

EVERYMAN'S GUIDE TO
RADIO

FIRST PRINCIPLES
THE ELECTRICITY OF RADIO
DIAGRAMS-THE SHORTHAND OF RADIO
THE MECHANICS OF RADIO
THE VACUUM TUBE

AUDIO-FREQUENCY AMPLIFICATION
RADIO-FREQUENCY AMPLIFICATION
FIXED AND VARIABLE CONDENSERS
COILS
IMPROVEMENT OF BROADCAST RECEPTION
HOW TO MAKE RADIO MEASUREMENTS
LEARNING THE LANGUAGE OF DOTS & DASHES
BATTERIES, BATTERY CHARGERS
AND B-ELIMINATORS
DIFFERENT TYPES OF RECEIVERS
RADIO ACCESSORIES, THE WONDERS OF
RADIO TRANSMISSION, WIRING GRAMS
FOR RECEIVERS AND TRANSMITTERS

EVERYMAN'S GUIDE TO RADIO

A PRACTICAL COURSE OF
COMMON-SENSE INSTRUCTION IN
THE WORLD'S MOST FASCINATING SCIENCE

VOLUME I

RAYMOND FRANCIS YATES
EDITOR-IN-CHIEF



CONTRIBUTORS TO THIS VOLUME:

SIR JOSEPH THOMSON, PH.D., F.R.S.
DR. ELIHU THOMSON, PH.D., SC.D.
DR. IRVING LANGMUIR, PH.D.
DR. E. E. FREE, PH.D.
LAURENCE M. COCKADAY, A.I.E.E.
EDGAR FELIX, A.I.E.E.

DR. CHARLES P. STEINMETZ, PH.D.
DR. REGINALD FESSENDEN, PH.D.
PROF. JAMES AMBROSE FLEMING, F.R.S.
PAUL GODLEY, E.E.
ALBERT G. CRAIG, E.E.
PROF. WILLIAM BALLARD, JR., E.E.

POPULAR RADIO, INCORPORATED
NEW YORK, 1927

COPYRIGHT, 1926, 1927
POPULAR RADIO, INC.

PRINTED BY THE STRATFORD PRESS
IN THE UNITED STATES OF AMERICA

Preface

WHILE radio literature has been added to in great volume during the last few years, the public has hitherto lacked a treatise to which it could turn with confidence and with the assurance that it would find the particular information desired.

Many excellent volumes have been prepared by eminent authorities, but these works either show evidences of hasty preparation or they are so steeped in the technicalities of the art as to be partially or wholly unintelligible to those seeking understandable reading matter. Then, too, it is utterly impossible completely to cover the subject within the confines of one modestly sized volume, so rapidly has radio grown.

Every Man's Guide to Radio in four volumes, is the first attempt to publish a complete and popular exposition of radio in all of its phases. It is designed to serve as a reference library for radio fans and novices at all stages of learning.

Everyman's Guide to Radio is especially dedicated to the young student who is looking forward to sharing in the rich rewards that radio is offering to its followers. There is no field that holds out greater opportunity for young blood. Proficiency in radio may lead to adventure on the seven seas, above the clouds, behind the closed doors of the great laboratories of the country or in the luxuriously appointed broadcasting studios. An honest and conscientious reading of *Every Man's Guide to Radio* will reward the young student in rich experiences and ample compensation.

Due to the simple, non-technical style that has been carefully followed in this work, the casual owner of a radio receiver will not only find much that will be of practical value to him, but he will also find an easily readable outline of one of the greatest scientific romances in the history of man, and he will emerge from the course with a keen understanding of the modern wonders of radio, such, for instance, as radio-dynamics, television, wired wireless and talking motion pictures. Upon completion he will also find himself familiar with certain fundamental facts and practices of the radio art that will make him a more intelligent user of radio apparatus. Instead of being an idle twister of knobs he will become aware of the delicate processes that take place behind receiver panels and he will

know what vacuum tube to use, what kind of a loudspeaker is best for this or that kind of a receiver and what "B" battery voltage to employ with a 201-a tube.

In assembling the material for *Everyman's Guide to Radio*, the Editors, in practically every case, have obtained the contributions of specialists each of whom has written concerning his own field of activity. This plan has made the work unique in that no single writer in it has tried to encompass the field as a whole, as in the less conspicuous radio books on the market. Consequently when the subject of vacuum tubes was approached, the editors naturally turned to men like Irving Langmuir, Ambrose Fleming (the inventor of the two-element tube) and William Ballard, Jr. When it came to a discussion of condensers, Sir Oliver Lodge, one of the world's greatest authorities in electrostatic phenomena, was asked to contribute to this department. In every case eminent authorities have been employed and in every case they have couched what they have to say in simple language intelligible to the lay mind.

Nevertheless, the raw recruit may find a slight difficulty in grasping the subject-matter of *Everyman's Guide to Radio* at first reading. But he should not be discouraged, either with himself or the course, for it is rare that a lay mind unaccustomed even to the simplest electrical laws can drink in radio facts as fast as they are presented, no matter how simple the language or how ingenious the explanations may be. Of course the average reader, the reader who still remembers his high school physics, and the reader who has thumbed the pages of some of the current radio magazines and books, will be able to absorb the material here presented practically as fast as he can read. The lay reader, however, may find it necessary to re-read certain portions. The editors hope he will make that slight effort, for they are confident that with very little study the whole meaning will suddenly dawn upon him and the pleasure and benefit he will derive will repay him an hundredfold.

There is, in *Everyman's Guide to Radio*, a vast storehouse of radio knowledge for those who would make use of it. By constant editing and constant rearrangement its material has been kept strictly up to date.

THE EDITORS

Table of Contents

SECTION 1

The First Principles of Radio. The electron, the proton and a general outline of the electron theory of matter. Ether waves from atoms and how they cause the sensation of light. The various and well-known theories of ether wave propagation. The Heaviside layer theory. How ether waves behave under various conditions. The Steinmetz theory of radio and electromagnetic waves. The chemical atoms and how they are held together by electrical forces. The similarity of radio, electrical and chemical phenomena.

SECTION 2

The Electricity of Radio. Explanation of voltage, amperage and electrical resistance. Ohm's law. How current is generated. Batteries, dynamos, motors and electrical measuring instruments. Condensers, transformers and the transformation of electric currents. How current is controlled, etc. Voltmeters, ammeters, hot-wire meters, thermo-couples, etc.

SECTION 3

Diagrams—The Shorthand of Radio. General explanation of radio circuits. Conventional diagram, photograph and outline of the function of each instrument used in radio receivers and transmitters.

SECTION 4

Mechanics of Radio. The instruments necessary for wave generation and propagation. How waves leave the antenna; how they travel, etc. Wavelength. Kilocycles. How waves are tuned, etc.

SECTION 5

Mechanics and Electrics of Tuning. Loose-couplers and how they work. Tuning coils and how they work. The operation of variometers and vario-couplers. Tuning circuits. Variable condensers. Fixed condensers. Damped waves. Undamped waves. The effect of resistance on tuning. The function of the antenna and the importance of its dimensions. Loops and aerial socket plugs. Antennaeless radio receivers. Interference; how to locate it and how to prevent it. Lightning arresters; how they work and how to install them. Single-control radio receivers. Dead spots—how they are found, etc.

SECTION 6

Detection and the Secret of the Vacuum Tube. The crystal detector and how it works. Why detectors are needed. The function of various crystals. The Edison effect; the story of the discovery that led up to the invention of the radio vacuum tubes. The two-element vacuum tube. How it works. The three element vacuum tube. How it was discovered and how it functions. Grid leaks, fixed and variable. The C-battery. How the C-battery affects the flow of electrons in vacuum tubes. The various types of manufactured vacuum tubes and their best usage. Vacuum tube data sheets. Characteristics of all well-known vacuum tubes. Photograph and specifications of all well-known vacuum tubes, fixed and variable grid leaks.

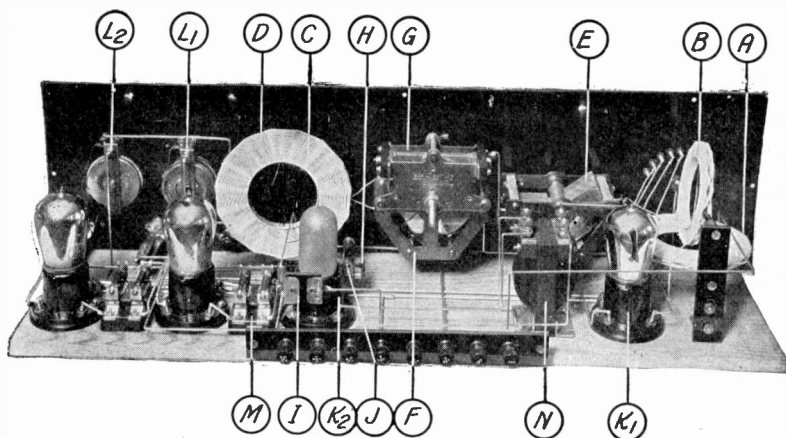

The Sections of the Everyman's Guide to Radio dealing with the various instruments keyed in this illustration may be quickly found by reference to the index below.

ILLUSTRATED INDEX

- A-B—Loose couplers and variometers, Section 10.
- C—Coils, basket wound, D-Coils, honeycomb coils, etc., Section 10.
- D—Radio frequency transformers, all types, Section 8.
- E—Condensers, variable types, Section 9 and 2.
- F—Condensers, variable vernier, Section 9.
- G—Condensers, variable and multiple, Section 9.
- H—Fixed condensers, Section 9 and 2.
- I—Fixed condensers, adjustable, Section 9.
- J—Grid leaks, Section 6.
- K1—Amplifier vacuum tubes and sockets, Section 6 and 16.
- K2—Detector vacuum tubes, Section 6.
- L1—Rheostats, Section 6 and Section 16.
- L2—Potentiometers, Section 16.
- M—Resistance coupled audio amplifiers, Section 7.
- N—Audio-frequency transformers, Section 7.

SECTION I

First Principles of Radio

SINCE radio phenomena are closely associated with the most fundamental precepts of modern physics, it is impossible to gain a penetrating or even intelligent understanding of them without first going to the very bottom of the whole matter. The necessity of this proceeding, however, should not chill the ardor of the practical enthusiast for we will find in such a study a particularly romantic series of facts.

When the subject of radio is approached on this basis it eventually blossoms out into a thing far more fascinating as a study than it possibly could be by a mere consideration of its more practical features. As a matter of fact, nothing but the most superficial understanding can be gained without considering the basic physics upon which the whole art of radio rests. These same physics, incidentally, account for every phenomenon in the world today from the beating of a human heart to the falling of a raindrop.

The Universe, as we know it, has been found to contain only two basic things; *electricity* and *waves*. The most exhausting investigations of science have failed to reveal any other substance. Matter is not the hard substance that our crude senses seem to prove; it is simply made up of tiny particles of a thing that we have arbitrarily called electricity. Our senses do not give us a true conception of the matter about us and it has only been through a long series of scientific investigations carried out by the aid of marvelous instruments

that we have learned to look at the world through different eyes.

The chemists of old, unarmed with the delicate devices of modern science, had it that matter was made up of "hard and eternal little particles" called *atoms* and it was not until 1897 that it was found that these hypothetical atoms were themselves made up of still smaller particles called *electrons* and that these electrons were nothing more or less than pure little particles of electricity so small that they were hopelessly beyond the magnifying power of the best microscopes. It was found that these electrons were merely charges of negative electricity and that they possessed the general properties of negatively charged bodies.

If the reader remembers his high school physics at all, he will recall that bodies carrying like charges of electricity repel each other and bodies carrying dislike charges of electricity (positive and negative) attract each other. How, then, can we maintain an atom of matter made up solely of negative particles when it is known that these particles have a natural tendency to part company? It is evident that we must have a positive influence working upon them to keep them within certain bounds.

Perhaps the best way to gain a reasonably intelligent picture of atomic structure is to consider briefly the general architecture of the most simple atom that we have in matter; the atom of hydrogen. Painstaking investiga-

tions extending over the last 25 years have shown that the hydrogen atom has but one electron and that this electron is moving at a prodigious speed and in a regular orbit around a positive core or nucleus called the *proton*. We cannot conceive of the negative electron maintaining a definite position in space without having something to hold it there. It is the counter-balancing positive charge of the proton that does this.

All the atoms of matter (there are some ninety different types) are made up from one (in the case of hydrogen) to ninety-six electrons revolving about positive protons in varied and complex systems.

The distance separating electrons from their mothering positive influence or proton is great as compared with the measurement of the particles themselves and what appears to us as very solid matter is in reality but a mere ghostlike structure. In the case of the element copper, the percentage of empty space is 99,999,999,999.8%.

Our solar system, which we ordinarily consider as being made up largely of empty space, has a density six hundred times greater than the paper upon which these words are printed. This is practically equivalent to saying that there is six hundred times more matter in the solar system than in the paper. We strike a tabletop with our hand and we find something there that is apparently solid and unyielding but it is solid and unyielding only because our hand is tremendously large and our senses appallingly crude.

If we could reduce our body to the dimension of an electron we could crawl into that table and wander around for months and months perhaps before we should come to anything that appeared solid or substantial.

If we did happen to see an electron it

would be moving with a speed of about 40,000 miles a second and if it should happen to strike us it would have a "wallop" thousands of times greater than anything that could be experienced in the world in which we humans live.

Let us imagine that we have in our hand a piece of copper wire 1/20 of an inch in diameter and 1 inch long. Let us assume also that this wire is magnified until it reaches from New York to San Francisco and that its diameter is proportionately increased. The wire will then be 2550 miles long and 125 miles thick. Under these conditions we would find that the electrons would still be (after having been magnified in the same proportion) 23/1,000,000 of an inch in diameter and that the nucleus would be 1/100,000 of an inch in diameter. The atoms would be separated by many miles of space.

This proton about which we have been talking, although very very small, is very dense, and, considering its size, of tremendous weight. If a large number of them could be crowded into a piece of matter about the size of an apple and packed real close together, that piece of matter would have a weight of many millions of tons and nothing on the earth, not even the earth itself, would be able to support it. It would straightway penetrate the rocks and the soil and travel with a great speed until it reached the center of gravity.

We see that, after all, we are living in sort of a dream world. The things in it are not as supposed for our senses reveal but a small portion of the real truth. The most peculiar part of it is that the theory that we have just been considering (*the electron theory of matter*) has been made to account for everything that happens in the world and radio is no exception. As a matter of fact radio is accounted for very easily by this theory.

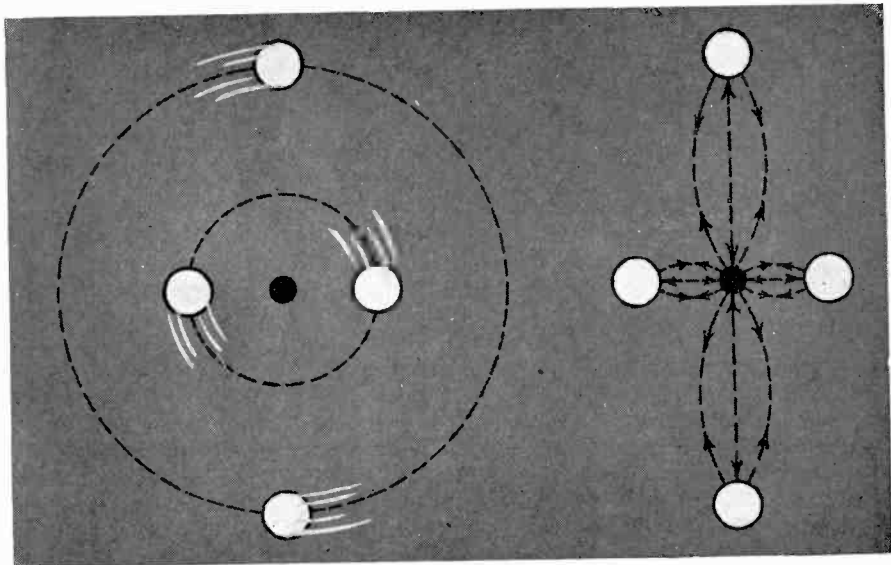

THE TWO PREVAILING THEORIES OF THE STRUCTURE OF ATOMS—
SHOWING HOW THE ELECTRONS ARE HELD BY ELECTROSTATIC FORCES.

Illustrated by one of the simplest atoms, that of the element Beryllium. The figure on the left shows the theory of Sir Joseph J. Thomson, as embodied in this Part. The four electrons, represented by white spheres, are held by a balance of attractive and repulsive forces at definite distances from the central nucleus of the atom, represented by the black dot. The other figure (at the right) shows the alternative planetary theory, according to which the electrons are supposed to be revolving around the nucleus much as the earth and the other planets revolve around the sun.

Before we go into the subject of the *ether* and *electromagnetic waves* which account for the phenomenon of radio, let us permit such an eminent authority as Sir Joseph Thompson, F.R.S., to tell us more about the atom and how it is put together.

“I believe that the introduction of the idea of the electron will break down, and indeed has already done so to some extent, the barrier of ignorance which has divided the study of the properties of matter into two distinct sciences, physics and chemistry.

“The properties of matter which are of primary importance to the chemist are those which relate to the power of

atoms to unite together to form new combinations, new compounds. Until recently the conception of the atom, formed by the physicist, afforded no clue to the variation in the chemical properties of the atom and gave therefore but little guidance to the chemist in what he rightly regarded as the most important part of his work.

“The chemist wants to know much more about the difference between an atom of hydrogen, and one of oxygen than that ‘the atom of hydrogen is a small particle of one kind of matter’ and that ‘the atom of oxygen is a heavier particle of another kind of matter.’

“The chemist wants to know the

reason why the behavior of an atom of hydrogen is so different from that of an atom of oxygen. This must depend upon the difference in the constitution of the two atoms themselves. Thus to explain the difference between the chemical properties of different atoms we have to go a step further than that considered by the atomic theory. Just as some of the physical properties of matter in bulk had required for their explanation the conception that matter is not continuous but has a structure of finite and measurable fineness, so no progress could be made towards the explanation of their chemical properties until we gave up the idea that the atom was indivisible, continuous and uniform, and assigned to atoms, as well as to solids and liquids, a structure of their own.

"The discovery of the electron in 1897 was the first direct evidence of such a structure. It was shown that these electrons came from all types of atoms, and that whatever the source there was only one kind of electron, which has a mass of only about 1/1700th that of an atom of hydrogen and carries a charge of negative electricity numerically equal to the positive charge associated with an atom of hydrogen in the electrolysis of solutions.

"Thus an invariable electron was proved to be a constituent of all atoms. Means were then devised to measure the number of electrons in the atoms of the different chemical elements. It was found that this number was finite and varied from element to element, and that the number of electrons in the atom of an element was equal to the atomic number of the element—the atomic number of an element being its place in the list when the elements are correctly arranged in the order of their atomic weights.

"Thus, in addition to the structure conferred by the electrons, the positively electrified parts of the atom have themselves a structure. It is the structure conferred by the electrons which is responsible for the chemical properties of the atom, and the structure of the positive core or nucleus is concerned with radioactive transformations.

"Up to the present time nothing has been discovered that cannot be resolved into electrons and positively electrified particles, and so it is natural to frame a theory of the structure of the atom on the supposition that it is built up of these two ingredients. It should be borne in mind, however, that our means for detecting the existence of electrically charged bodies far surpass those for detecting uncharged bodies, and if there were any uncharged constituents of the atoms, they would in any case probably have escaped detection. We know, however, even supposing that such constituents do exist, that their mass must be negligible compared with that of the positively charged parts, for these parts account for well within a fraction of a percent of the whole mass of the atom.

"Confining themselves, then, to the consideration of things the existence of which has been demonstrated, we regard the atom as made up of a massive positively electrified center surrounded by electrons; the number of electrons varying from one, in the atom of hydrogen, to a hundred or more in the heavier elements. The positive charge of the center and the negative charges on the electrons produce a field of electrical force which is determinable when the position of the electrons are specified.

"Thus the force exerted by the atom, and therefore its chemical properties, depend upon the configuration of the electrons and to determine this is one of

the most important problems in the electron theory of chemistry.

"This problem is that of determining the way the electrons arrange themselves under the action of their mutual repulsions and under the effect of forces exerted by the positive charge.

"I have adopted the plan of suppos-

"In this connection it may be observed that the introduction of some new physical law is necessary for any theory of the structure of atoms. We could not form a theory at all if all we knew about the action of electric charges was that they repelled or attracted inversely as the square of the distance, for

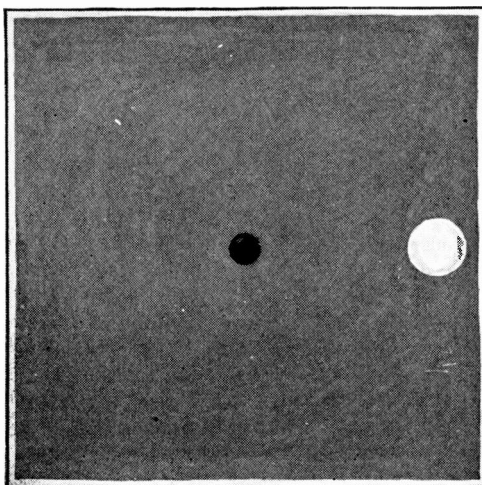

THE ATOM OF LITHIUM

3 Model of the atom of lithium according to the Thomson theory. The two electrons closest to the nucleus, as shown on page 9, are omitted in this and following models for the sake of clearness. This lithium atom contains only the one electron shown in the shell outside these two inner electrons.

ing that the law of force between the positive part and the electrons is, at the distances with which we have to deal in the atom, not strictly that of variation with the inverse square of the distance, but a more complex one which changes from attraction to repulsion as the distance between the positive charge and the electron diminishes. This hypothesis leads to a simple mental picture of the structure of the atom and its consequences.

this would put at our disposal only two quantities—the mass of an electron and its charge, and so we could not furnish the three units of *space*, *mass* and *time* required for any physical theory.

"The discovery of the induction of currents or (what is equivalent) the magnetic effect due to electric charges, introduced another fundamental unit, the *velocity of light*; the unit of length to which this system leads is the radius of the electron, about 10^{-13} cm., a quantity

of quite different order from 10^{-8} cm., which corresponds to atomic dimensions. The size of atoms being what it is furnishes proof that there is some law of physics that is not recognized in the older science.

"If the law of force is that just given, then a number of electrons can be in stable equilibrium around a posi-

librium at the corner of an equilateral triangle with the positive charge at the center. The most symmetrical arrangement of four electrons is when they are at the corners of a regular tetrahedron. Six electrons are in equilibrium when at the corners of a regular octahedron. Eight electrons arrange themselves at the corners of a twisted cube, a fig-

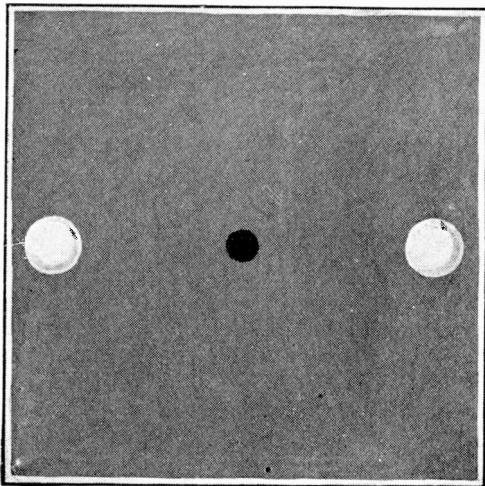

THE ATOM OF BERYLLIUM

4 Model of the atom of beryllium, the same atom shown on page 9. The two inner electrons that are there shown are omitted in this model just as they are omitted in the adjoining model of atom Number 3. The two external electrons are balanced one on each side of the nucleus.

tive charge without necessarily describing orbits around it.

"Thus, for example, if there is one electron in the second shell of the atom (ignoring the two inner electrons that are shown on page 9), this electron will be in stable equilibrium at a certain distance from the positive charge. If there are two electrons they will be in equilibrium with the positive charge midway between them. When there are three electrons, they will be in equi-

librium obtained by making two squares, placing them parallel to each other and at right angles to the line joining their centers, and twisting them relatively to each other so that the projection of their corners on a parallel plane forms a regular octagon.

"There must come, however, a stage when it will no longer be possible to have all the electrons at the corners of a regular polyhedron.

"To keep the electrons in stable

equilibrium in spite of their mutual repulsion requires a finite positive charge and the greater the number of electrons (and, therefore, the smaller the angular distance between an electron and its nearest neighbor) the greater the positive charge must be. When the number of electrons is not greater than eight, the

eight this is no longer possible. To keep, say, nine electrons in stable equilibrium would require a positive charge of more than $9e$, where e is the charge of an electron, but in a neutral molecule $9e$ is the maximum positive charge available when there are nine electrons in the atom. Thus the regular

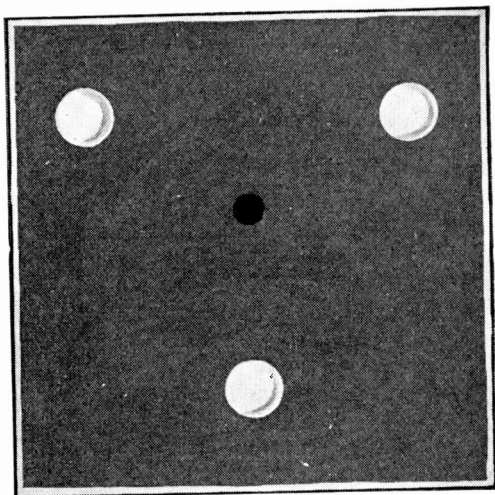

THE ATOM OF BORON

5 Like atoms number 3 and 4 the electrons of this atom (the atom of boron) are arranged in the same plane about the atomic nucleus at equal distances from it and from each other.

electrons can be kept in equilibrium by a positive charge equal to the sum of the negative charges on the electrons, which is the greatest positive charge that can occur in a neutral atom. So that when the number of electrons is not greater than eight, a neutral atom can have these electrons arranged symmetrically at the same distance from the center at the corners of a regular polyhedron.

“When, however, the number exceeds

progression in the arrangement breaks down when the electrons amount to eight and a new arrangement must come into force.

“Let us suppose that there are nine electrons; then these nine cannot all be arranged at the same distance from the center, for this arrangement would be unstable since a positive charge of nine is insufficient to keep nine electrons in stable equilibrium. The charge $9e$ could, however, keep eight electrons in

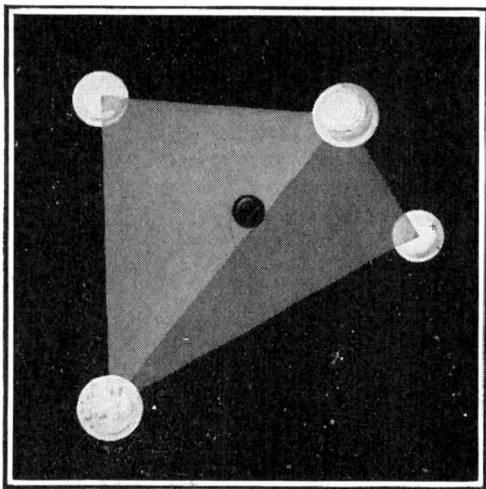

THE ATOM OF CARBON

6 This is the atom of the very common element carbon, the element of coal and of diamonds. Its four external electrons are arranged about the nucleus at the corners of an imaginary tetrahedron. As before, the two internal electrons are not shown.

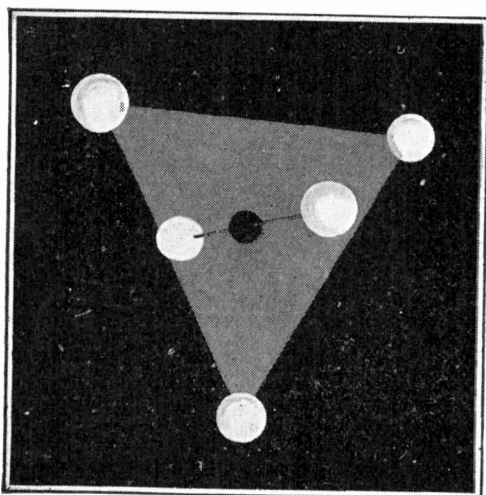

THE ATOM OF NITROGEN

7 The atom of nitrogen—the gas that composes four-fifths of the air. In this there are five external electrons, three of them arranged at the corners of an imaginary triangle, the other two at the ends of a perpendicular line through the center of this triangle.

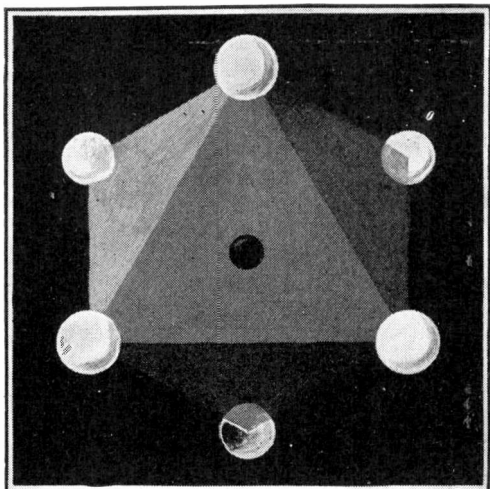

THE ATOM OF OXYGEN

8 One of the most important of all atoms, the atom of oxygen. This element is the commonest element in the earth's crust and is the element we breathe in air. Its six external electrons are arranged at the corners of an imaginary eight-sided solid or octahedron.

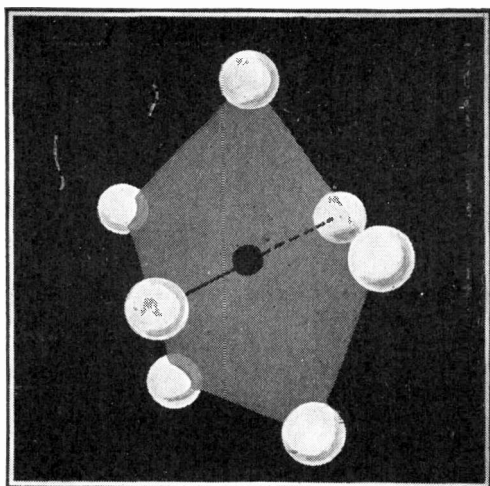

THE ATOM OF FLUORINE

9 The atom of fluorine, containing seven external electrons. Five of these electrons are arranged in one plane through the nucleus, as though at the corners of a regular pentagon; the other two electrons are at the ends of a perpendicular line, as in the case of atom number 7.

stable equilibrium at the same distance from the center, leaving one to go outside, relatively a long way out from the center of the atom.

"If there are ten electrons, these can be arranged so that eight form a layer round the center and two go outside. Eleven electrons can be arranged with an inner layer of eight and an outer one of three, and so on. Sixteen electrons

rium if the electrons proceed to form third shell; thus, if there are seventeen electrons, we could have an inner shell of eight, then another shell of eight and then an electron a long way outside. If we had eighteen electrons we should get two shells of eight and two electrons outside, and so on, until with twenty-four electrons we shall have filled up the third shell and have to begin again.

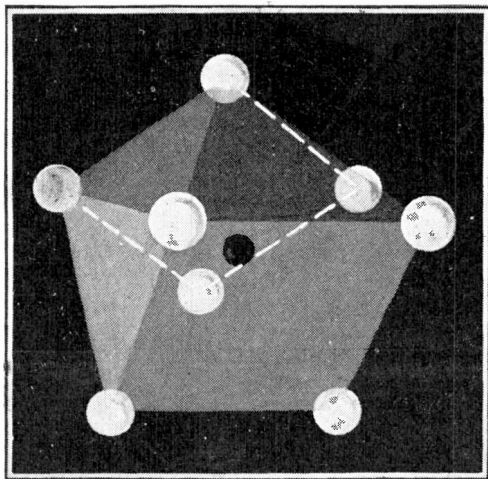

THE ATOM OF NEON

10 The atom of the rare gas neon. This contains eight external electrons, which is the greatest number of electrons, Sir Joseph Thomson believes, that can be held in a single shell all at the same distance from the nucleus.*

can be arranged with an inner layer of eight and an outer layer of eight.

"We have now got eight electrons on the outer layer and there is not accommodation for any more; as the atom is neutral, the excess of positive over negative electricity in the system consisting of the central charge and the inner layer is equal to the charge on the electrons in the outer layer. We can, however, get a system which will be in stable equilib-

"Thus, if we arrange the elements in the order of the number of electrons in the atom, which is the same as the order of the atomic weights, there will be a periodicity in the number of electrons in the outer layer. It will increase from one to eight, then drop again to one; in-

*With the preceding seven models this completes the list of the first ten elements. Element number one (hydrogen) and number two (helium) are not shown in this series as they contain only the two internal electrons shown on page 9; hydrogen having one electron only, helium having both of them.

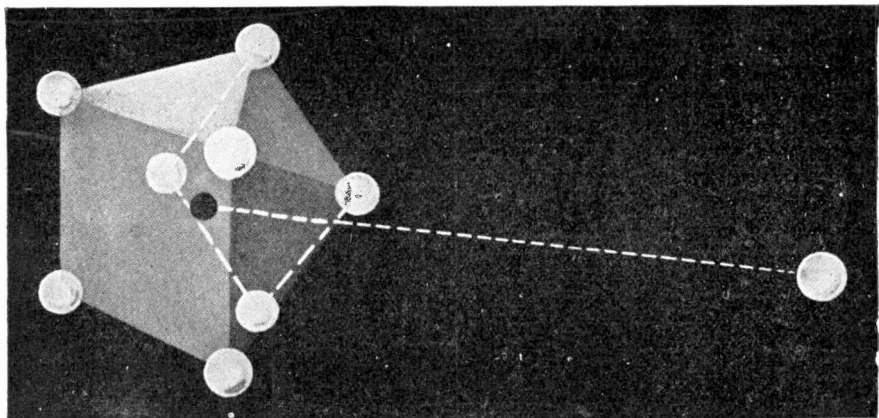

WHAT HAPPENS WHEN MORE THAN TEN ELECTRONS TRY TO CROWD INTO A SINGLE ATOM

11 The eleventh electron goes into a second shell at a distance from the nucleus 6.7 times as great as the distance of the first shell of eight electrons shown in the preceding models. This eleven-electron atom is that of sodium, one of the elements in common salt.

crease again to eight, drop to one, and so on. Thus, as far as properties depending upon the outer layer are concerned, the elements will show a periodicity in their properties similar to that expressed by Mendeleef's periodic law in chemistry.

"The valency of an element is a property depending on the number of electrons in the outer layer, the electro-positive valency being proportional to that number, so that this type of atom would explain the periodic law.

"There are some other interesting results which follow at once from the view we have taken of the constitution of the atom. One is the change in the chemical properties produced by electrifying the atom. Let us take the oxygen atom as an example, it has six electrons in the outer layer, and its valency is determined by the number of electrons in this layer.

"When the oxygen atom is positively electrified it has lost one or more electrons. If it is electrified so that it has lost one electron, the atom will only have

five electrons in the outer layer, the same number as there are in a neutral atom of nitrogen. Thus, if the valency depends on the number of electrons in the outer layer, the valency of oxygen carrying a unit charge of electricity ought to be the same as that of a neutral atom of nitrogen, i. e., it ought to form the compound OH_5 , a compound having the molecular weight 19.

"This is confirmed by observation with the rays of positive electricity; when hydrogen and oxygen are present in the tube, a line corresponding to this molecular weight is frequently observed.

"If we turn to negatively electrified atoms, a negative electrified chlorine atom would have eight electrons in the outer layer, it would resemble the neutral atom of an inert gas and so would not be able to enter into chemical combination. It might be expected to resemble argon not merely in its chemical properties, but also in the nature of its spectrum. Again, a positively electrified potassium atom has lost an electron

and so would contain the same number of electrons as a negatively electrified chlorine atom or a neutral argon one. Thus we should expect the spectrum of positively electrified potassium atoms to show similarities with that of negatively electrified chlorine atoms and with neutral argon atoms.

"Professor Zeeman and Mr. Dik have compared the red spectrum of argon, with the spectrum due to the positively electrified potassium atom and have found some exceedingly interesting points of resemblance.

"Similarly, positively electrified oxygen atoms might be expected to give spectra resembling those of neutral nitrogen atoms and positively electrified nitrogen atoms might show similarities with neutral carbon atoms."

It is interesting to note that the electrons we have been considering are able to accomplish a certain kind of broadcasting and they do this by setting up the same kind of wave disturbance in the ether that is created by a broadcasting transmitter. Instead of broadcasting the long waves of radio, the electrons broadcast the inconceivably short waves of light. It would be best at this point to note what Dr. E. E. Free, Ph.D., a prominent student of the electron theory, has to tell us about how the broadcasting of the electron is accomplished:

"The universe contains, so far as we know, only two things: electricity and ether waves.

"From the center of our earth outward to the most distant of the stars the probing finger of science has discovered nothing else. In every natural phenomenon, from the collision of two vast suns to the life history of an earthworm, everything is explainable as electricity or ether waves or the interactions of the two.

"Light is a form of ether waves. What we call heat is either an ether wave or a form of agitation in matter; and matter, as everybody knows nowadays, is really a form of electricity. Sound, too, is a vibration in matter and is therefore electrical. Magnetism and gravitation remain imperfectly understood, but these also, there is every reason to believe, are caused by some variety of ether waves that we have failed, as yet, to catch and analyze.

"And every material thing; the earth, the bodies of men and women, the eyes we see with and the ears we hear with, the copper wires that we build into our radio sets and the glass that houses our vacuum tubes, the sun and the moon and all the unnumbered millions of the stars; all these are composed of electricity, of the two fundamental kinds of electric particles that scientists call the *proton* and the *electron*. The proton and the electron simply represent two different electrical conditions, the proton, positive and the electron negative.

"The simplest kind of matter, we will remember, is the atom of hydrogen gas. This atom contains only two particles; one electron and one proton. The electron is a particle of negative electricity; the proton is a particle of positive electricity. The electron revolves around the proton as our earth revolves around the sun.

"The other kinds of atoms, making up the list of ninety chemical elements that have been discovered, are composed of these same protons and electrons; varying numbers of them up to nearly five hundred being put together in rapidly moving systems all constructed on essentially the solar system model, a central 'sun' around which revolve a number of tiny 'planets.'

"That is the modern picture of what atoms are like.

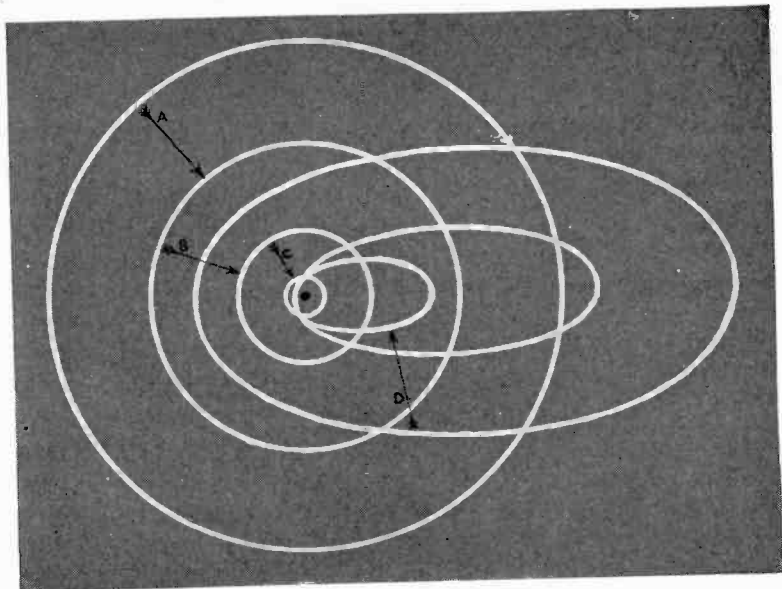

WHY THE HYDROGEN FLAME GIVES LIGHT

This diagram shows a few of the many possible electron orbits in an atom of hydrogen gas. There is only one electron in this atom and, accordingly, only one of these orbits is occupied at a time. Whenever the electron jumps from one orbit to another one (as indicated by the arrows A, B, C and D), a pulse of light is sent out. These light-pulses form the "broadcasts from atoms."

"These atomic systems are almost inconceivably tiny. More than 2,000,000,000,000,000 of even the largest atoms could crowd together comfortably enough on the surface of a pinhead.

"The printed letters on this page are composed essentially of atoms of the chemical element, carbon. Each carbon atom contains one central 'sun' and six electrons revolving around this as 'planets.' Yet so tiny is the entire assemblage that the little black dot that indicates a period at the end of this sentence contains more than 30,000 times as many carbon atoms as there are people in the world.

"Of course this is far too small for us to see. The smallest dust speck visible under the most powerful microscope ever devised contains many billions of atoms.

"How, then, can we be sure that the atom really does contain these particles of electricity spinning around a central 'sun' that is also electrical?

"We know by means of ether waves.

"The universe does not consist, remember, of atoms only. It contains, in addition, a great assemblage of ether waves; the waves of light pulsing back and forth between the stars, the waves of heat coming to us from the sun, the waves of electric energy that we are now using so amazingly in radio. The reader should not confuse these intangible waves of the ether with the very tangible waves of sound.

"These ether waves begin and end on atoms. If you light a match what happens is, that the billions of atoms in the flame send out ether waves of light. These ether waves enter your eyes and

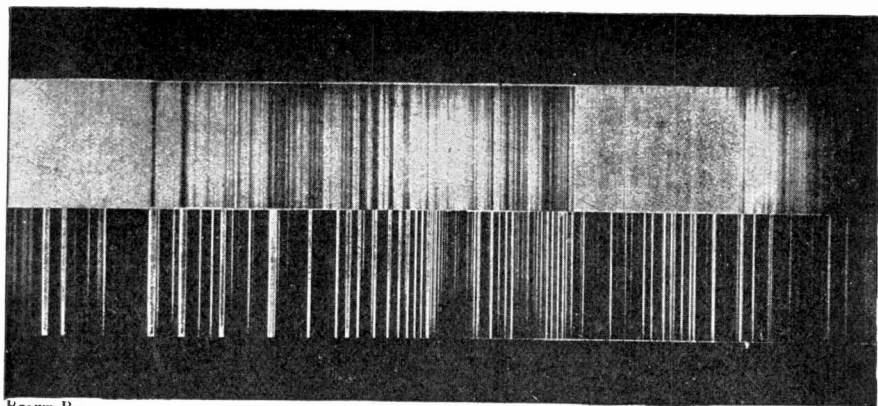

Brown Bros.

WHAT A LIGHT SPECTRUM LOOKS LIKE

This picture shows two photographs of spectra, which are the sets of bright lines and bands visible in a spectroscope whenever the light that comes from a group of excited atoms is analyzed by that instrument. Each one of these separate lines corresponds to an electron jump from one definite orbit to another one in each of the atoms that are emitting the light.

strike against the other atoms that compose the organ that you see with, your retina. The act of seeing is a kind of broadcasting. The atoms in the burning match broadcast an ether wave. This wave is picked up by the 'receiver' atoms in your eye.

"The same thing happens when you see a star. Atoms in that star, off many billions of miles in space, are hot or are excited by electricity. They broadcast ether waves in the form of light. These waves travel the vast distance through space and strike, finally, against the receiving instrument of your eye. Starlight is the broadcast news from other worlds.

"The most important thing about all this is the process by which these ether waves are sent out and received. This process represents the *relation* between the two fundamental things in the universe; the atoms (which are electricity) and the ether waves. How do atoms broadcast ether waves? How do other atoms receive them? These are possibly the deepest secrets of the universe and they are secrets which modern science

has made substantial progress in deciphering.

"This began with the science of spectroscopy.

"The spectroscope is an instrument that makes an artificial rainbow. Ordinary white light, such as the light of the sun, is passed through an arrangement of glass prisms and lenses. It comes out split up into its seven primary colors just like the colors of the rainbow.

"These colors differ, of course, in the wavelengths of the ether waves that compose them. The shortest light waves are on the blue end of the rainbow strip or spectrum; the longest waves are on the red end of the strip. The atomic broadcasting stations that send out the light waves use a number of separate wavelengths, just as radio broadcasters do.

"And curiously enough, it was found that each kind of atom, like each terrestrial broadcasting station, has its fixed wavelength or wavelengths. A white light, such as sunlight, contains practically all the wavelengths, but that is merely because it is coming from a

vast number of atoms and assemblages of atoms of many different kinds.

"If the United States contained a billion or two separate radio stations and if they all were sending at the same time, each on its own separate wavelength but if all these wavelengths were separated from each other by very tiny intervals, that would be a fair picture of what is happening when any body like the sun is sending out white light.

"But, if you take one kind of atom by itself and let it send out light, the result is very different. Suppose, for example, that you have a glass tube filled with hydrogen gas and that you send a power-

ful electric current through this tube so that the hydrogen atoms are disturbed and begin to broadcast. You will not get white light as you do from the glowing sun. On the contrary, the light waves sent out by the hydrogen atoms will comprise only a few distinct wavelengths. In a spectroscope they appear as lines of color at certain fixed positions along the rainbow strip of the spectrum. Other parts of the spectrum are dark.

"This is what scientists call the spectrum of hydrogen. It contains ten very bright lines and a number of fainter ones.

"In broadcasting language this means

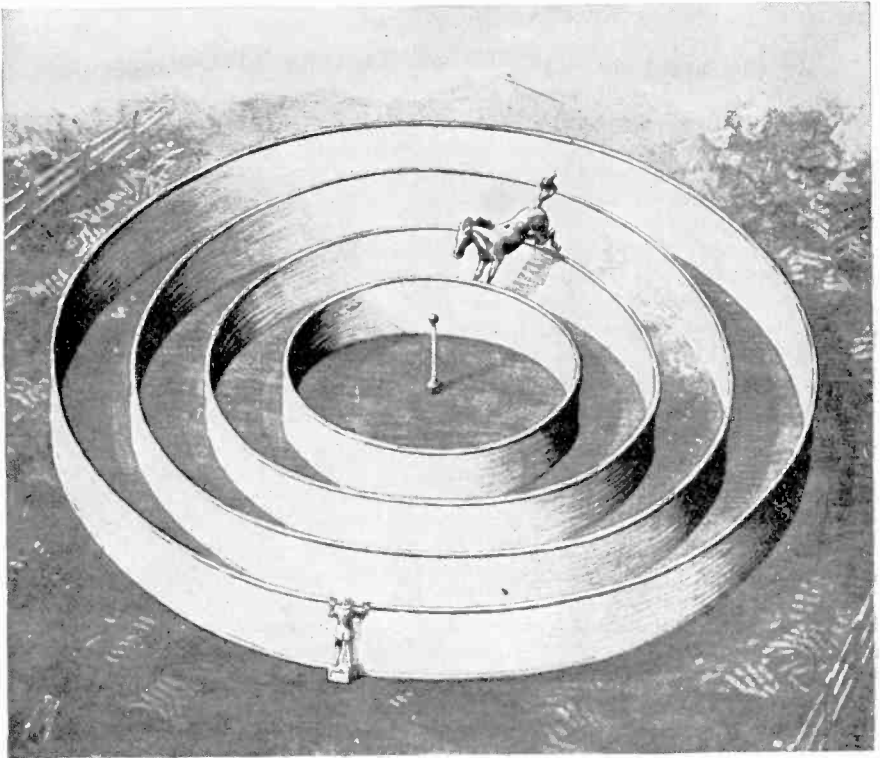

HOW WE "SEE" A BROADCASTING ATOM

The man at the outer fence can see the horse only when the horse is jumping over a fence. Just so, in a hydrogen atom, we can "see" the electron only when it jumps from one orbit to another.

that the transmitter of the hydrogen atom broadcasts light at ten or more perfectly definite wavelengths; just as WGY, for example, broadcasts its programs nowadays at two separate wavelengths and sometimes at three.

“And these ten (or more) wavelengths of the hydrogen atom are perfectly characteristic of that atom. Every hydrogen atom that sends out ether waves at all sends out one or more of these specific wavelengths. If you find the lines of these wavelengths in an unknown spectrum you know that this spectrum is

coming from hydrogen atoms just as surely as when you pick up a station on a radio wave of 492 meters you know that you are hearing from WEA F.

“More surely, in fact, for the different kinds of atoms maintain their wavelengths much more exactly than the man-made broadcasters do and, with a very few exceptions, no two kinds of atoms ever broadcast light on exactly the same wave.

“This gives you the clue to what is called spectrum analysis. The astronomer examines, for example, the light

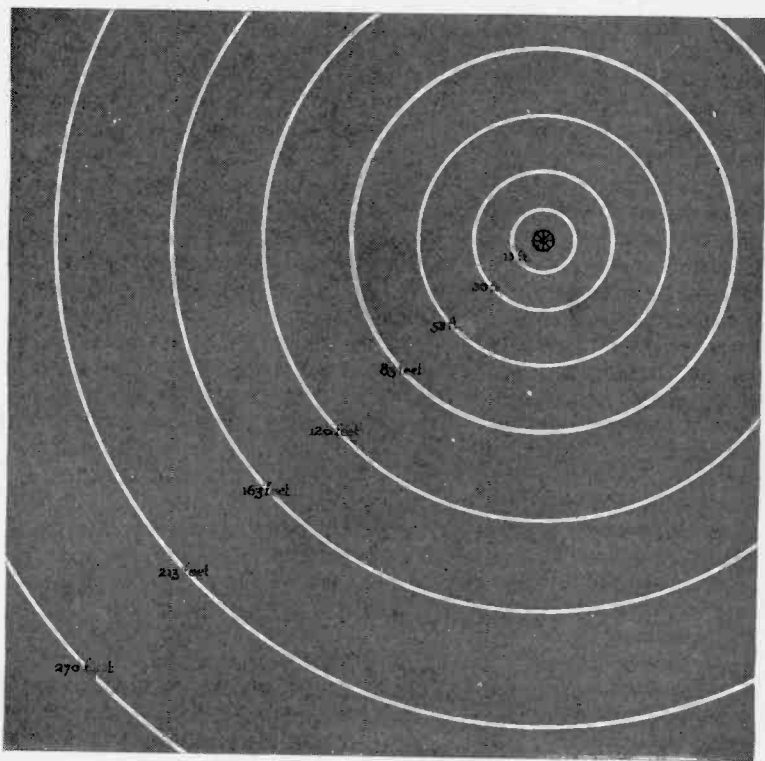

THE RELATIVE DIAMETERS OF THE ORBITS IN A HYDROGEN ATOM

If the innermost electron orbit of a hydrogen atom is regarded as being the size of the forty-inch wagon wheel at the center of this diagram, then the next eight orbits outside this have the diameters shown here in feet and drawn to scale.

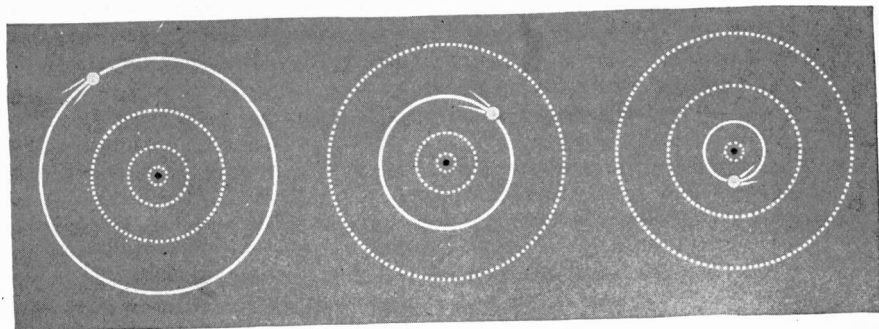

THREE SUCCESSIVE STAGES OF A RETURNING ELECTRON

In the diagram at the left the electron occupies the third orbit from the center. This position is unstable and the electron jumps to the second orbit, as illustrated in the center diagram. This position, too, is transient. The electron jumps finally to the inmost orbit, as illustrated at the right. For each jump a pulse of light is sent out.

rays coming from a distant star. He photographs the spectrum of this light. In it he finds certain definite lines. This means that certain definite wavelengths are present in the light. He compares these with the wavelengths known to be sent out by various kinds of atoms. Thus he determines what atoms exist off there in the star halfway across the universe. This is how we know that the atoms in the stars are the same as the atoms that we find here on earth.

"But this leaves untouched the problem of *why* the atoms broadcast their light messages in this definite way. What kind of oscillators and modulators or other apparatus do the atoms possess that make them able to send out ether waves with such exactness as to wavelength? This is the problem that Professor Niels Bohr has clarified so greatly in the past ten years as a part of his remarkable work on atoms.

"Professor Bohr starts from the idea of atomic structure already explained; the idea that all atoms consist of electron planets revolving around a central particle, also electrical, which acts as the atomic sun. It is convenient to consider the simplest known atom, that of

hydrogen. This consists, you remember, of one electron planet revolving around a single positive particle, a proton.

"In the actual hydrogen atom the orbit of the single electron is very small. It measures only about four-billionths of an inch in diameter. We can think better in larger sizes, so let us imagine that we can magnify a hydrogen atom by about ten billions times so that it is forty inches in diameter, about the size of an ordinary wagon wheel.

"On this scale the proton at the center will be still so small that it will be entirely invisible. Even the electron planet, which is nearly two thousand times larger than the proton, will be only about one four-thousandth of an inch in diameter, too small to be visible except with the help of a good microscope.

"These two particles make up the atom. All the rest of it is empty space.

"This represents, furthermore, the normal, inactive atom. It is not sending out any ether waves. So long as the electron stays in this normal orbit, the size of a wagon wheel, it does not broadcast any light. To see how it does broadcast light, according to the theories of

Professor Bohr, we must consider the other possible orbits that it may occupy.

"In the solar system of which our earth and our sun are parts there exist, as everybody knows, eight separate orbits each occupied by a planet. Our earth is the third from the center, both Mercury and Venus being closer to the sun than we are and moving in orbits smaller than the earth's.

"The atom of hydrogen possesses also a number of possible orbits for its electron planet. But there is only one electron in the atom. So what happens is that this same electron may occupy at different times different ones of the possible orbits.

"It is when the electron moves from one of these orbits to another one that there occurs, Professor Bohr believes, the transmission of the ether wave that

we call light. It is then that the atom becomes a broadcaster.

"In the wagon-wheel model that we have described the forty-inch orbit is the smallest and inmost one. It is here that the electron stays when the atoms are cold and not otherwise disturbed. But suppose that some outside force, as, for example, another fast-moving electron comes along and knocks the planetary electron out of this inmost orbit?

"If this happens there is another orbit that the electron can occupy at a certain distance outside the smallest orbit. This second orbit would be, on the wagon-wheel scale, 160 inches in diameter, or a little more than thirteen feet. Still outside of this is a third possible orbit thirty feet in diameter; beyond this is a fourth orbit about fifty-three feet in diameter, a fifth orbit about eighty-three feet in

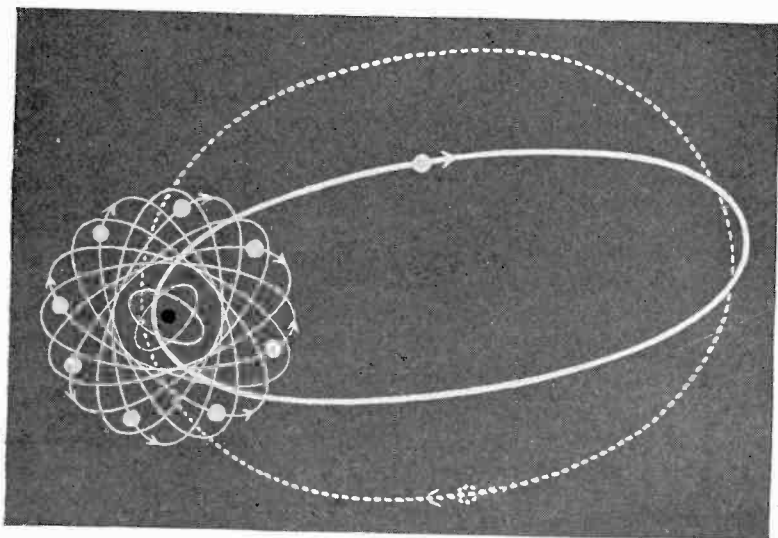

HOW A MORE COMPLICATED ATOM RADIATES LIGHT

This diagram represents an atom of sodium. The electrons that occupy the closely interlaced orbits near the center of the atom do not ordinarily jump about or send out light. But the outer electron, occupying the long orbit shown by the heavy white line, may occupy many other orbits—as, for example, the one shown by the dotted line. When this outer electron jumps about from one of these orbits to another the characteristic light spectrum of sodium is sent out.

diameter, and so on at least as far as an orbit that is 490 feet in diameter and possibly to still larger ones.

"When an electron is knocked out of an atom it must occupy one of these larger orbits or else it must go off altogether. For reasons that we need not discuss here, Professor Bohr believes that the electron cannot occupy any position in the atom except in one or the other of these specified orbits.

"So much for the electron as it goes out. Now let us consider its return.

"The attraction between the electron and the central proton of the atom makes the electron want to come back, just as our earth would be attracted back toward the sun if some force accidentally displaced it from its present orbit.

"And as the electron comes back, it does so by jumps. It occupies, in turn, the succession of orbits that I have described. Suppose that it has reached the fourth orbit, the one that is fifty-three feet in diameter on the wagon-wheel model. Its next move is to cross over by a sudden jump to the next orbit inside, that is, to the one that is thirty feet in diameter. As it does so something very amazing happens. The electron (or *something* in the atom) sends out a pulse of light.

"This is the essential idea of Professor Bohr's theory of atoms and ether waves; the theory that is now accepted by practically all the scientists working in this field. The idea, which is perhaps the greatest piece of thinking since Einstein's relativity theory, may be stated thus:

"Light is sent out by atoms only when one or more of the atomic electrons move from one possible orbit inside the atom to another orbit closer to the center of the atom."

"The wave length of the light that is sent out depends upon which orbit the electron has left and which one it goes to. In the hydrogen atom, for example, a jump from the fourth orbit to the third one sends out a single one of the possible wavelengths. This makes one of the lines in the spectrum of hydrogen. The other lines are made by other jumps; one, for example, by a jump from the third orbit to the second, another by a jump from the fourth to the second (for under certain conditions the electron may skip an orbit), and so on.

"In less simple spectra the conditions may be extremely complicated and difficult to understand. But in all of them that have been studied the general idea here described has been found to hold. All spectral lines—all the ether wave broadcasts that atoms send out—are believed to be due to sudden jumps of this kind made by electrons or groups of electrons inside the atomic structure.

"It is by taking the observed lines of spectra as measured in the laboratory and working backward from them to the atomic orbits and electron jumps that might have caused them that Professor Bohr and his associates have been able to establish most of the conclusions about atoms that we have already described.

"The atomic transmitter, then, is the electron. The thing that determines the wavelength transmitted is the particular jump that the electron makes. Only when the electron jumps is there any radiation of light. So long as it stays in a single orbit it radiates nothing.

"Let us quote an analogy that has been used elsewhere to make this clear.*

"Imagine a series of race tracks one inside the other like the concentric

*"Bohr's Model of the Atom," by E. E. Free. *Industrial and Engineering Chemistry*, vol. 16, pages 192-193 (February, 1924).

grooves of that once familiar game called 'Pigs in Clover.' Imagine these tracks separated by high board fences. Now put a race horse in the outermost track and instruct him to run around it until, when he happens to feel like it, he is to jump the inside fence into the next track, run around it for a while and then jump the next fence, and so on until he reaches the innermost track of all.

"If, then, you watch this procedure from the field outside the outermost fence, you will not see the horse at all so long as he is running in a single track. The fences hide him. But whenever he jumps a fence from one track into the next you will see him for an instant as he goes over.

"So with the hydrogen atom. You see the electron only as it jumps from one orbit to another one, for it is only then that the electron radiates light.

"The next step that atomic science must take is the discovery of what really happens when one of these electron jumps occurs. We know nothing about this at all. We do not even know that the electron 'jumps' in the ordinary sense of that word. What happens, so far as we can judge, is that an electron disappears from one orbit and simultaneously an electron appears in another orbit.

"Perhaps it is not the same electron at all. Perhaps an electron is destroyed in the first orbit and a second electron created out of ether or ether waves or something in the second orbit. We do not know what electrons are. It is entirely conceivable that they may be merely a form of ether waves or that both they and ether waves may be different forms of the same thing. These things are still mysterious.

"And they lie close, we may be sure, to that greatest of all scientific problems, the problem of what constitutes

that ultimate reality of Nature which appears to us now as matter, again as electricity, another time as waves in the ether and perhaps—who knows?—as what we are accustomed to describe as mind.

"Like the fable of the blind men who attempted to describe the elephant, although each had felt a different part of him, all these apparent facts of nature may be equally imperfect descriptions each of one aspect of the whole.

"Doubtless, science will attain, some day, a more complete description of these things. And nothing is likely to contribute more largely to this end than the investigation of those much longer ether waves that originate, we do not yet know how, from masses of moving electrons in wires, and that we call *the waves of radio.*"

The radio waves or the electromagnetic waves that are used in radio transmission have the same fundamental nature as the waves Dr. Free mentions in his treatment of the subject. They travel with the same speed, i. e. 186,000 miles a second and they have the same properties. They may be reflected, refracted and polarized. While our light waves may be measured in the millionths of an inch, our radio waves are measured in meters and they may be as small as 1/1000 of a meter (1/1000 of 39.37 inches) or as large as 25,000 meters. They move forward from the point of disturbance in exactly the same way as the waves in a pond move forward when a stone disturbs the water. We picture them going forward at the great speed of 186,000 miles a second in all directions at the same instant of time. They pass through solid matter, or at least this solid matter of our imagination, as easily as air passes through an open window.

For all practical purposes we can con-

sider these ether waves in the light of the above paragraphs but it is interesting to note at the same time how certain great scientists feel about the wave theory. The trend of these private theories should not confuse us. On the contrary they should help us to gain a more general view of the science.

There is one theory in particular that is important to our understanding of radio in that it tries to account for the way in which radio waves are held to the surface of the earth. We must not forget that ether is an all-pervading substance and that when superficially considered there is no reason why these waves should not go romping off into space instead of following the curvature of the earth as they must in travelling from one point to another.

To account for this following of the surface of the earth, radio scientists have evolved what is called the *Heaviside layer theory*. This tries to account for the phenomenon by assuming that there is in the upper reaches of our atmosphere an ionized or charged layer which tends to reflect the waves back to the earth causing them to flow in a channel between the earth proper and this theoretical layer. It will be remembered that we said previously that long ether waves could be reflected just as we reflect light waves from a mirror.

Dr. Elihu Thomson, Ph.D., Sc.D., has something vitally interesting to say about his theories of the Heaviside layer, which he airs in the following paragraphs:

"When Marconi brought out his system of wireless telegraphy about 1896, it was at first thought by most scientists or physicists of the time that it was a plain case of the sending out of waves of the Hertzian type, which Dr. Heinrich Hertz had so ably investigated ten years before. If such were the case,

the transmission was necessarily in straight lines from the oscillator; necessarily, also, such waves could not follow the curvature of the earth's surface, but they must leave the earth as if they were light beams—another case of electromagnetic waves moving in a straight course.

"There were some of us, however, who, taking into account the grounding at the base of the antenna, recognized the fact that the Marconi transmission was not made by real Hertzian waves, but on account of the grounding, by half-Hertzian waves only, and that the Marconi oscillator or antenna system was a half-oscillator only. From this it followed that the waves were in reality attached to and guided by the earth's surface, and particularly by the sea surface, more conductive than the land.

"It followed that there would be electric currents in the sea and earth-surface accompanying these half-Hertzian waves, and magnetic fields overlying the currents in the space above the earth's surface.

"When it was announced by Marconi a few years later that he had received signals across the Atlantic ocean by flying a kite, the cord of which constituted an antenna with the usual ground, many regarded him as something of a faker. At least, they believed that he was mistaken in his observations. Among these doubters were not a few of the leading scientific men and engineers of the day. It followed that if the waves were of true Hertzian type and were propagated in straight lines, they could not by any possibility curve around and over a mountain of water nearly two hundred miles high, as they would have had to do if they crossed the Atlantic close enough to the earth's surface to be detected.

"As it was soon demonstrated that

Marconi was right and that the signals did come around the curve of the earth's surface, those scientists who failed to recognize (and some of them even yet seem so to fail) that there was a fundamental difference between the waves in their propagation and in their generation as regards true Hertzian waves,

had been mistaken—and not Marconi.

“Then a singular thing happened.

“When confronted with the facts, this assumption pure and simple was made, which unfortunately lives and has character even today: that there was an electric mirror of ionized gas, or conducting gas, say fifty or sixty miles up in our

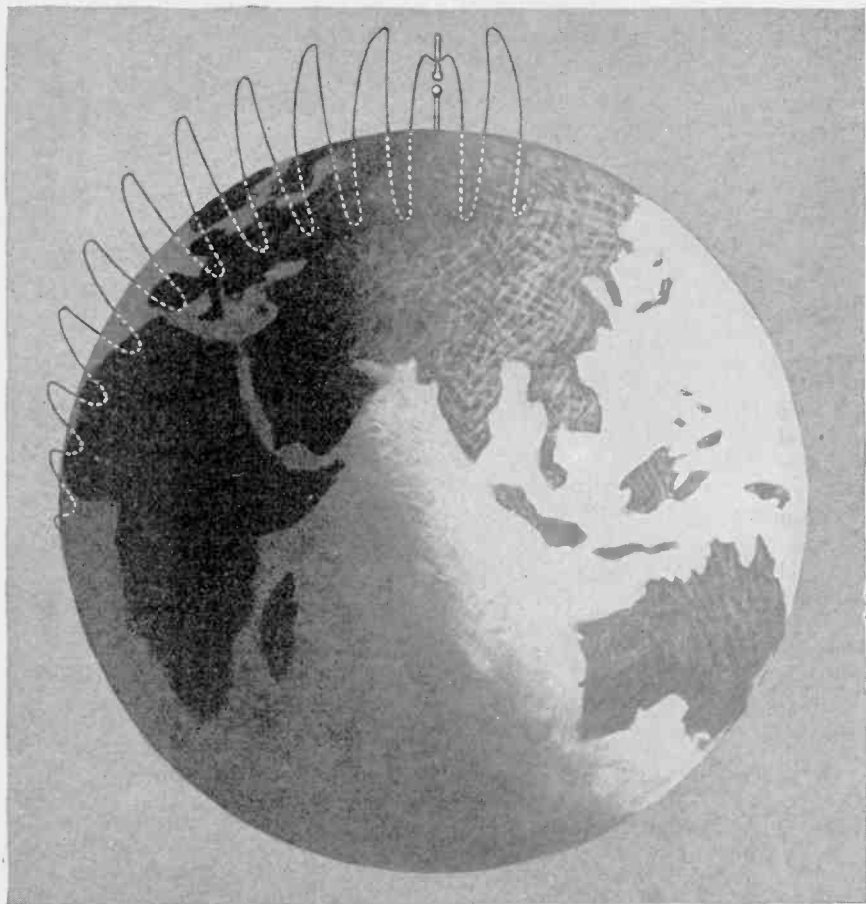

THE "GLIDING WAVE" THEORY—WHICH DR. THOMSON ACCEPTS

“The radio waves are in reality attached to and guided by the earth's surface, and particularly by the sea surface which is more conductive than the land,” states the American scientist. According to this theory, the half-Hertzian waves propagated from a grounded system would follow the curvature of the earth and would be accompanied by electric currents in the earth and sea surface, and by magnetic and electrostatic fields in the space above the earth's surface.

atmosphere, the under surface of which was so definite as to reflect the waves without diffusing or mixing them up, and so send them around the earth by successive reflections from above.

"I think that anyone who reflects for a moment on the requirements in such a case must predict that such an assumption is not only unnecessary, but that it strains the imagination too far, and plainly will not work. In order to work, it would have to be something like a metal surface, confined to a certain smooth regularity and of such a nature that the wave fronts could not penetrate it to any considerable depth without being turned back. It must be without swellings or wavy contour, and it must reflect the waves in such a way as not to interfere with those that are more directly transmitted, and so keep the waves in phase. It would have to be, as it were, Nature's gigantic whispering gallery for electric waves. The assumption itself (if it could be shown to be probably true, with the required limitations) might have justified the extended and complicated mathematical treatment it has received at the hands of some able men. But an assumption, if not needed or not true, is not helped by such treatment. The mathematics may be valid enough, but they do not make the assumption itself valid. Reasoning on false premises, whether mathematically or otherwise, does not make the conclusions valid.

"According to what has for many years been known as the 'gliding wave' theory, there never was and never could have been any doubt of the waves used by Marconi (the half-Hertzian) following the rotundity of the earth's surface.

"Experience shows that transmission over the sea is far better than over the land. Direction finding discloses that the direction of transmission favors the sea.

"Experience shows that when the land surface between two stations has been wetted by rains, great improvement in the transmission follows, to be again lost when the land surface is once more dried by evaporation. A good ground for the transmitting system or an ample condenser counterpoise is shown to favor greatly the launching of the waves. That the waves above the earth's surface tend to follow closely that surface, or may even be said to cling thereto, accords with the results obtained from aerial antennae, ground antennae, and loops or coils used as antennae.

"There never has been any occasion for the existence of the assumption of an upper conducting layer of such a nature as to reflect the waves without confusing them or diffusing them, and it is regrettable that such an assumption, having once received the sanction of great names, thereby continues to have a support and recognition which should never have been given and was never needed.

"The views presented by me in 1913 have been more and more confirmed by practice in the years since elapsed. They represented the views of the group, by whom the assumption of an upper reflecting layer was recognized from the start as a fallacy."

Reginald A. Fessenden, Ph.D., one of the most accomplished pioneers in the science of radio communication and a man who has laid down many of the basic facts of radio as we know it today, reflects scientifically on the manner in which electromagnetic waves move. He calls this new line of reasoning the "gliding wave theory" and he describes it as follows:

"The sliding wave theory appears to have been somewhat misunderstood both by its advocates and its opponents. The nature of this misunderstanding and how it arose will be better appreciated

if we consider the general state of the art at the time the sliding wave theory first appeared, in the Proceedings of the American Institute of Electrical Engineers, November 22, 1899.¹

"Joseph Henry, who was the founder of wireless telegraphy, had discovered electromagnetic induction and invented the induction coil². He had also made the fundamental discovery that the dis-

lations, he was the first to detect them at a distance, using what was later known as the magnetic detector. The high-frequency oscillations were generated in the upper floor of a building and transmitted to the cellar, where they were received by a receiving coil and utilized to shake out the magnetism from a magnetized needle³.

"Edison, Elihu Thomson and Hous-

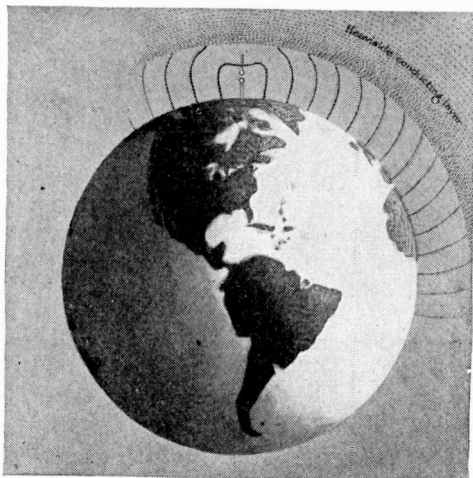

DIAGRAM OF THE HEAVISIDE LAYER THEORY

According to most scientists, radio waves are reflected from (and transmitted around the earth by) a layer of ionized gas that is suspended high in the atmosphere of the earth. Sir Oliver Lodge is the foremost exponent of this theory.

charge of a condenser was under certain conditions oscillatory, or, as he puts it, consists 'of a principal discharge in one direction and then several reflex actions backward and forward, each more feeble than the preceding until equilibrium is attained.' Henry was not only the first to produce high-frequency electric oscil-

ton made many experiments on these transmitted waves, and reports of their experiments will be found in Edison's papers in the technical journals of that period and in the paper by Houston and Thomson in *The Journal of the Franklin Institute* for April, 1876⁴. Between 1870

¹Reginald A. Fessenden, "The Possibilities of Wireless Telegraphy." (A discussion.) *Trans. Amer. Inst. Elec. Engrs.*, volume 16, mail edition pages 635-642, regular edition pages 607-614 (1899).

²Joseph Henry, "On the Production of Currents and Sparks of Electricity from Magnetism." *Amer. Jour. Science*, volume 22 (appendix), pages 403-406 (1832).

³"The Scientific Writings of Joseph Henry," 1832-1848. The Smithsonian Institution, Washington, D. C. Henry's important papers on electromagnetic induction are reprinted in "The Discovery of Induced Electric Currents," edited by J. S. Ames, volume 1, 107 pages, The American Book Company, New York, 1900.

⁴Edwin J. Houston and Elihu Thomson, "The Alleged Etheric Force. Text Experiments as to its

and 1888 von Bezold, Fitzgerald and Hertz had cleared up to a very considerable extent the nature of the phenomena observed, and Hertz's work had shown that the experimenters were dealing with true electrical waves.

"Dolbear⁵ and Edison had been using vertical grounded antennas for telegraphing wirelessly, though the effects they obtained appear to be mainly electrostatic and only partially true wave transmission.

"Crookes in the *Fortnightly Review*

Identity with Induced Electricity." *Jour. Franklin Inst.*, volume 101, pages 270-274 (April, 1876).

⁵U. S. Patent No. 350,299, issued October 5, 1886.

for February, 1892, proposed that resonant tuned circuits should be used to select out messages from different stations. Lodge⁶ and Popoff⁷ had used these waves for signalling, and Popoff, who had used a vertical grounded antenna, coherer and tapper back, pointed out that the apparatus might 'be adapted to the transmission of signals to a distance.'

"Tesla⁸, who had been doing a great

⁶Sir Oliver Lodge, "The Work of Hertz." *Proc. Royal Institution* (London), volume 14, page 321, June 1, 1894.

⁷Popoff, *Jour. Russian Phys Chem. Soc.*, April 25 1895.

⁸Nikola Tesla, "Experiments with Alternate Cur-

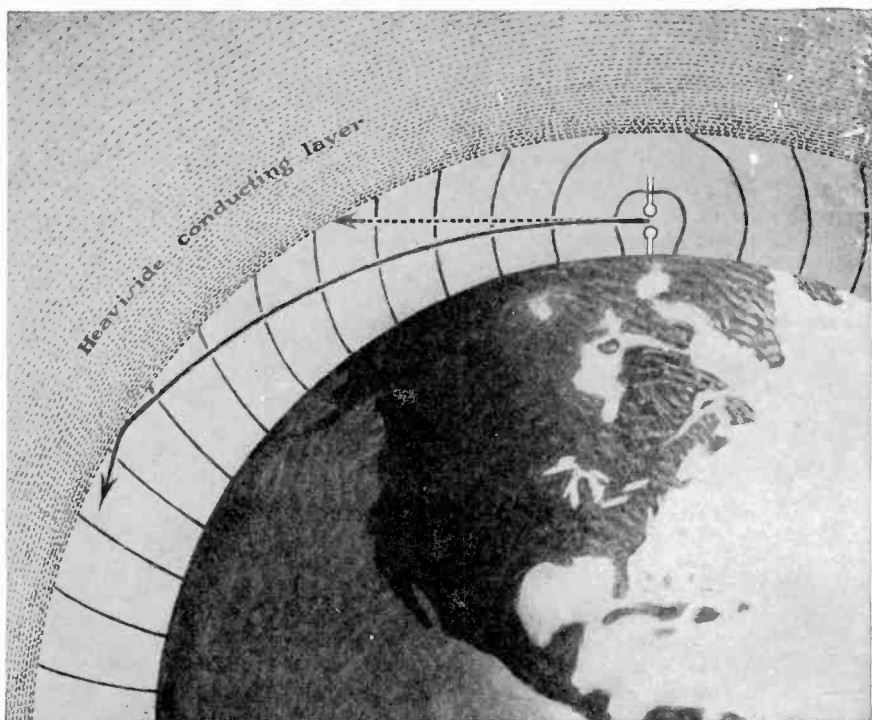

DIAGRAM OF DR. FESSENDEN'S THEORY

Instead of moving in straight lines outward from the source, as shown by the dotted line, the waves really move in a curve like that shown by the solid line. But this curve tends to bend away from the earth's surface and reflection from the Heavyside Layer is necessary to bring it back again.

deal of work in high-frequency oscillations, in 1892 proposed a system for transmitting signals wirelessly using the vertical antennas of Dolbear and tuned transformer circuits at the sending and receiving ends.

"Edison, in 1884, discovered and invented the hot-cathode vacuum tube², and used it for rectifying high-frequency currents. De Forest's great invention,

was a market for such a telegraphic system, even if working over only short distances, and in July, 1896, gave a demonstration to the English Post Office at Salisbury Plain and succeeded in increasing the range from its previous figure of a half mile obtained by other experimenters to a distance of two miles, using parabolic reflectors and the coherer. In the same year Captain



DIAGRAM OF THE GLIDING
WAVE THEORY

On the other hand, a number of eminent scientists (of which Dr. Elihu Thomson is one) maintain that radio waves are attached to and glide over the earth, following its contour in much the same way as do the radio waves in line radio.

which consisted of the introduction of a third electrode between the other two, was made about 1907.

"Marconi, who had worked under Righi's instructions, had, with the keen eye for commercial opportunity possessed by his race, realized that there

rents of High Potential and Frequency." *Jour. Institution Elec. Eng.* (London), volume 21, pages 51-163 (1892).

²U. S. Patent No. 307,031, issued October 21, 1884. See also Edwin J. Houston, "Notes on Phenomena in Incandescent Lamps," *Trans. Amer. Inst. Elec. Eng.*, volume 1, first paper, 8 pages, October, 1884.

Jackson (now Admiral) of the British Navy found that considerably greater distance could be obtained by using the Dolbear-Edison-Tesla arrangement of vertical antennas and tuned sending and receiving transformers at both transmitting and receiving ends.

"Such was the state of the art in 1899. Henry had discovered the method of producing high-frequency oscillations and of detecting them at a distance, utilizing his other inventions, the induc-

tion coil and the magnetic detector, for this purpose. Dolbear had invented the vertical antenna. Edison had invented the hot-cathode vacuum tube detector. Tesla had invented the tuned sending transformer and tuned receiving transformer, connecting to the vertical antennas. Marconi, Samuels and Isaacs had undertaken the commercial exploitation of the field. De Forest was about to begin the work which resulted in his invention of the audion.

"But even then the nature of the phenomena involved were not clearly understood. Possibly influenced to some extent by patent reasons there was a strong effort made to show that there was something radically new and strange in the systems which were being commercially exploited. It was stated by a number of authorities that the phenomena were *not* due to high-frequency alternating currents, but that some peculiar 'whip-crack' was necessary in the ether. A few quotations will illustrate this point¹⁰.

"Professor Cross stated that 'alternating currents in the vertical wire will not produce Hertzian waves in the ether, as such waves are produced only by the disruptive discharge. Probably a crude mechanical illustration would be the case of a whip-lash—motions of some kind would be produced, but they would be of a quite different character.' Fleming stated that 'although in the third claim the patent speaks of employing rapidly recurring or alternating electric impulses, unless some form of a condenser is discharged to cross the spark gap there cannot be any production of Hertzian waves—the disruptive discharge is the one essential condition

for the production of Hertzian waves.'

"Marconi stated that 'the difference between Hertzian oscillations and ordinary alternating currents is most certainly *not one of degree*. An analogy may be found in the case of a sound wave in air. The swinging of a bell in a church steeple to and fro will produce no wave, and further, no sound, but if the rim of the bell is struck soundly with a hammer, it effects the air with sufficient suddenness. Hence it appears absolutely clear to me that there is no Hertzian wave telegraphy without the essential feature for producing Hertzian waves, which is the Hertzian spark.'

"The writer had been lecturing and experimenting on the production and detection of Hertzian waves for a number of years¹¹, and was convinced that there was no essential distinction between the Henry high-frequency oscillations and Hertzian waves. With the object of demonstrating this a considerable number of experiments were made in 1899, with the assistance of one of the writer's former students, Dr. Kintner, and the results published in the American Institute paper above referred to, that is of November 22, 1899, in which the sliding wave theory referred to by Professor Elihu Thomson¹² was fully explained and illustrated.

"It will be seen that this paper on the sliding wave theory was written for a specific purpose, i. e., to show that there was no mysterious 'whip-crack of the ether' involved in wireless telegraphy, but merely the well-known high-frequency currents, and though it led to important developments, for instance, the wave chute, the use of the magnetic component of the wave, the loop an-

¹⁰Court reports in *Marconi vs. De Forest*, Southern District of New York. Proceedings Electrical Congress at St. Louis; Discussions *Inst. of Elect. Eng.* (England) and "Principles of Electric Wave Telegraphy."

¹¹Purdue University catalogue for 1892-93. Thesis,

Bennet and Bradshaw, Western University of Pennsylvania, 1895.

¹²POPULAR RADIO, volume 2, pages 231-235, (December, 1922). See also Elihu Thomson, "A Short Story in Wireless," *The Electrician* (London), volume 89, page 148 (August 11, 1922).

tenna, the pelorus or wireless compass, continuous wave generation, the wireless telephone and the heterodyne, it was never intended as a presentation of the complete theory.

"This has resulted in the theory being misunderstood to some extent. Professor Thomson has supposed, it would appear from his article, that the waves are *entirely* guided by the surface of the conductor and follow the earth around. Eckersley¹³, on the other hand, states that the transmission of the half waves is not influenced *at all* by the conductor but 'the energy is propagated in straight lines.'

"The correct theory lies between these two opinions. The original mathematical investigation made by the writer in 1900 shows that the sliding waves are guided by the earth's surface to a quite considerable extent near the origin, but that the effect rapidly falls off. The amount of the bending is expressed by a series formula, the first term of which is an angle equal to half the angle between a tangent to the source and a straight line joining the surface of the conductor at a distance of a quarter wavelength from the source, and the source. The effect of this series falls off very rapidly with the distance. For transatlantic distances it is negligible, but for the distances dealt with in my original paper it is quite appreciable.

"The reception of waves across the Atlantic cannot, therefore, be due to guiding of the sliding waves by the conductor and must be due to some conducting layer in the upper portion of the earth's atmosphere.

"Writers on the subject of the Heavi-

side Layer seem to assume that this layer is more or less hypothetical and are apparently not aware that it was investigated fully prior to 1907.

"The investigation was begun by the writer in 1900 at Cobb Point, Maryland¹⁴, where two masts were erected one mile apart and by means of hot wire barreters and ring receivers, the exact method of transmission of the waves was experimentally determined¹⁵. By means of ladders placed at varying distances from the antennas the course of the waves in the air was fully mapped out up to distances of several hundred yards from and to the antennas, and by burying the receivers at different depths in the ground and immersing them to different depths in the sea water, the rate of decay below the surface and the strength of the currents flowing in the surface were accurately determined. The results appeared in papers published by the writer some twenty years ago, where, for example, the figure is given that with a certain amount of salt in the sea water and with a certain wavelength the strength of the high-frequency currents falls off to the fraction $1/e$ of its former value at a depth of 18 inches. Figures are also given of change intensity in going up and down sloping ground. Later, in 1906, while operating across the Atlantic between Brant Park in Massachusetts and Machrihanish in Scotland extensive measurements were made on the efficiency of transmission of different wavelengths at different hours during the day and night. A curve showing the results was published in 1906¹⁶ and again in 1908¹⁴.

¹³T. H. Eckersley, "A Short Story in Wireless" (letter to the editor). *The Electrician* (London), volume 89, pages 242-243 (September 1, 1922).

¹⁴Where speech was first transmitted wirelessly, December, 1900. See Reginald A. Fessenden, "Wireless Telephony." *Trans. Amer. Inst. Elec. Engrs.*, volume 27, pages 553-629 (1909).

¹⁵A. Frederick Collins, "Fessenden's Work in Wireless Telegraphy." *Electrical World*, volume 42, pages 474-476 (September 19, 1903).

¹⁶Reginald A. Fessenden, "Wireless Telegraphy." *Electrical Review* (London), volume 58, pages 744-746 (May 11, 1906) and 788-789 (May 18, 1906).

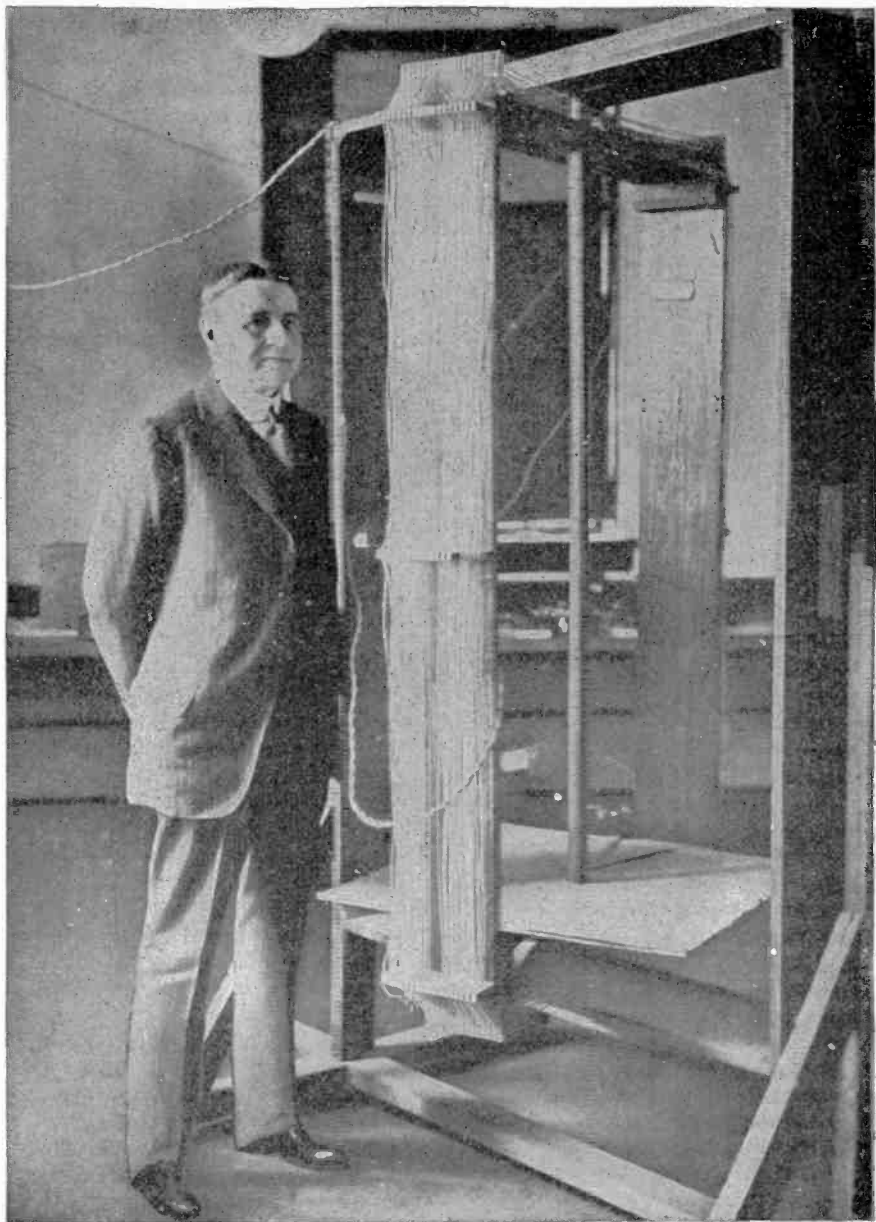

© Harris & Ewing

A FAMOUS AMERICAN RADIO INVESTIGATOR

Dr. L. W. Austin of the Bureau of Standards, with the apparatus used for investigating the effects of the ionized clouds described by Dr. Fessenden.

"The first point determined, as will be seen from these articles, was that the failure in transmission during daylight was not, as Dr. Fleming had stated and attempted to show mathematically¹⁷, due to absorption in the neighborhood of the sending station. This was determined by measuring accurately and simultaneously the difference in intensity between the daytime and nighttime reception of signals at six different stations at distances of 200 yards, 30 miles, 170 miles, 270 miles, 400 miles and 3,000 miles from the sending station. It was found that there was no difference in the daytime and nighttime transmission for nearby stations, and that the difference increased rapidly with the distance.

"A second point determined was the efficiency of different wavelengths for transmission during daytime and nighttime. From the curves given in the papers referred to it will be seen that the absorption increased slightly as the wavelength increased, up to a frequency of 70,000 and then fell off with extreme rapidity. It was for this reason that long wavelength was adopted by the writer for transatlantic working in January, 1906. Up to this time short waves had been used in the attempts to work across the Atlantic, under the impression that they gave a sharper 'whip-crack,' but as the result of these experiments and the publication of these curves it became generally known that long waves should be used for successful operation.

"The third result was the determination of the height of the conducting layer. This is given in section 10 of the article of May 18, 1906¹⁸, as follows:

"The height above the earth at which marked absorption begins to take place

¹⁷J. A. Fleming, "Principles of Electric Wave Telegraphy," pages 617 and 618.

may be roughly estimated as about 300 miles at nighttime and 100 miles during daytime.'

"It will be noticed that the height of this reflecting layer as determined in 1906 from the transatlantic wireless experiments agrees almost exactly with the height at which aurora are formed, as determined ten years later by trigonometrical photographic measurements.

"The fourth point determined was that the Heavyside Layer was not a smooth surface but was broken up into clouds of ionized air, 'ioneph's,' as the writer has termed them. To quote from the paper referred to, 'these masses of ionized air are not continuous but somewhat resemble clouds.'

"The fifth point determined was the size of these clouds, which is given in the article referred to as varying in diameter from 150 feet to two miles and more.

"The sixth result was the discovery of aeolotropic absorption or the variation in intensity in different directions on different nights.

"The seventh point referred to in the paper is the discovery of diffraction effects.

"The eighth result was the discovery of a relation between the efficiency of transatlantic transmission on different nights and the curves of variation in the earth's magnetism. The two sets of curves were found to be substantially identical in character.

"The ninth point was the discovery of what were called 'echo signals.' To quote from the article: 'On certain nights there appeared to be indications at the Boston station that a double set of impulses were being received, one about a fifth of a second later than the other. It is too early yet to make any definite statement in regard to the matter, but there is some reason for think-

ing that the second set of signals arrived at the station after going the longer way round. To take an actual numerical example, the strength of signals received at Boston from Machrihanish on the night of January 30 was 480 times that of audibility. If the second set of signals went around the other way, their intensities, according to the square law, would be as 1 is to 70. Hence signals that had gone the other way round would have an intensity of 480

divided by 70, or 7 times audibility. As a matter of fact, the second set of signals, which we may call the echo signals, were really nearly twice as strong. This, of course, might be taken as an argument against their having come that way, but I am not disposed to consider it as a conclusive one. If, however, they did come round the other way, it is evident that the rate of absorption must become uniform after a certain distance.

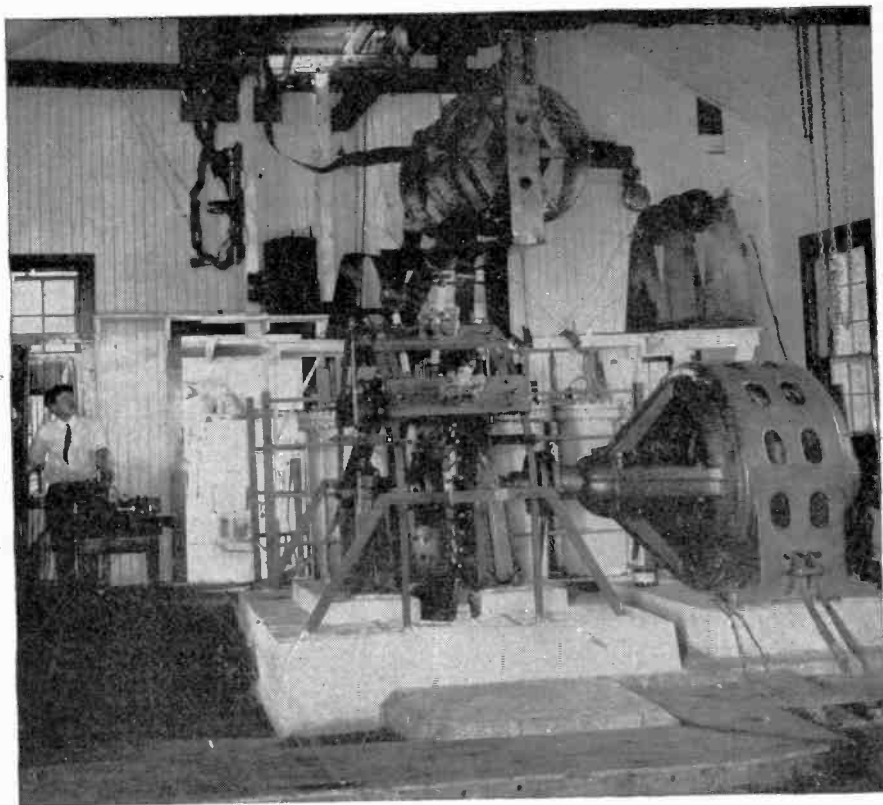

MEASURING THE HEIGHT OF THE HEAVISIDE LAYER

By means of this elaborate transmitter Dr. Fessenden carried on experiments in 1906. The operator, Guy Hill, has since become known to radio fans everywhere as Captain Hill, for several years associated with Major General George O. Squier.

"Though the statement was severely commented upon at the time (May 18, 1906), the existence of these echo signals has since been confirmed. In the January, 1922, issue of the 'Monthly Notices of the Royal Astronomical Society,' from the Greenwich, Poulka, Uccle and Edinburgh Observatories, Professor Sampson gives curves of 'the error in wireless time signals which demonstrate the curious fact that each observatory is liable to be in error by 0.2 second, and that the error frequently persists for some weeks in the same direction. The cause is obscure; lateral refraction due to dissymmetry in the distribution of atmospheric pressure is examined, but is insufficient to explain the whole anomaly.'

"It will be seen that a quite considerable amount of experimental work had been done on the Heavyside Layer as far back as May, 1906, and it is hoped that someone else may take up work along the lines indicated. Some additional information will be found in a paper on the pelorus published in 1919¹⁸.

"Dr. Elihu Thomson and Sir Oliver Lodge have referred to the 'skepticism' concerning Marconi's first attempt to transmit wireless signals across the ocean to Newfoundland. This is really a commercial and not a scientific matter.

"The reference is, of course, to the disclosures of fact which appeared in *The London Electrician* for November 22, 1907; to the fact that three dots were used as a signal letter; the fact that the receiver used (a carbon-mercury coherer) can be made to give a succession of three dots followed by a period of silence by adjusting the electrodes to the right distance; the fact that no one was allowed to listen in to the signals except

¹⁸Reginald A. Fessenden, "The Fessenden Pelorus (Wireless Compass); a Caution as to Its Use." *The Electrician* (London), volume 83, pages 719-721 (December 19, 1919).

Marconi and a single assistant who had no knowledge of electric circuits; the fact that the experiments were abruptly discontinued in spite of the very generous offer of the cable companies to waive their monopoly so far as experimental work was concerned and not only to permit but to assist Mr. Marconi in making any further tests; the fact that we now know that with the short wavelength used and with the single, kite-supported wire at the receiving end, the small amount of power and no amplification, no signals could possibly have been received over that distance with that apparatus; the fact that even with the much more highly powered stations subsequently built at Cape Cod it was found necessary to first send the Roosevelt message by cable from the Holland House, New York, and then, after it had been sent out from the Cape Cod station wirelessly, to send a second cable message by the Duxbury cable directing the release of the message cabled from the Holland House; the circumstances connected with the Glace Bay tests as discussed in *The London Electrician* of the date referred to, and the fact that a considerable amount of cable stock had been sold shortly prior to the announcement of the Newfoundland tests. These facts have undoubtedly influenced public opinion to skepticism. But this is a matter on which everyone must form his own opinion, and those who may be inclined to pass harsh judgment should remember that the standard of commercial ethics is not quite the same as that of abstract science.

"To conclude, I think that perhaps the most striking evidence of the reality of the Heavyside Layer is the close agreement of the results of the tests

¹⁹Reginald A. Fessenden, "A Regular Wireless Telegraph Service Between America and Europe." *The Electrician* (London), volume 60, pages 200-203 (November 22, 1907).

made to determine the height of this layer (as given in the paper in *The Electrical Review* for May 18, 1906, cited above) with the determinations of the height of the aurora borealis made in 1920. The fact that these two heights agree almost exactly is pretty conclusive evidence of the existence of such a layer. At first sight the aeolotropic transmission referred to in the paper of May 11, 1906, cited above, might be considered as equally conclusive evidence, but it will be seen from the paper of 1919 in *The Electrician* (also cited) that such a deviation would still exist even though there were no Heavyside Layer."

In the last paragraphs we talked a great deal about ether waves. When Hertz found that electromagnetic waves existed, scientists immediately thought that it was necessary that these waves should have some kind of a medium upon which to travel. The ether was invented partly as a matter of convenience. No one has ever heard, seen, felt or smelled the ether and there is not a single scientific instrument that can vouch for its existence. It is simply one of those inventions of the scientific mind created to temporarily account for certain observed phenomena. As far as we are concerned with the practical understanding of radio we do not care whether there is an ether or not. All we need to know is that waves are created and that these waves move with a certain speed and have a certain definite length. It is most interesting, however, to gather in the thoughts of our great scientists on this subject and the ideas expressed by the late Charles Steinmetz, "There Are No Ether Waves," may form a fascinating chapter in our present discussion. Steinmetz, basing his assumptions on the newer findings of the Einstein Theory of Relativity, goes on to say:

"The greatest contribution to science of the last ten or fifteen years, in my opinion, is the theory of relativity as worked out by Einstein and his collaborators. It is of vital importance because it revolutionizes our whole conception of nature and space. The theory of relativity concludes that there exists no absolute position or motion, but that these elements are relative.

"In other words, if we had only one single body in the universe we could never know whether that body is moving or standing still. If we had two bodies we could never find out whether body A moves and body B stands still, or whether body B moves and body A stands still. Nor could we determine whether they both move. There is no real absolute motion and we can speak of motion as relative only. If we had only one body in other words there would be no reason in speaking of that body as either moving or standing still. The conception of motion comes in only when there is more than one body.

"This conclusion is incompatible with the hypothesis of the ether as carrier of light.

"If ether fills all space, then there must be absolute position and absolute motion. A body is at rest or is moving relative to the ether, and this would be an absolute motion and would enable us to find out whether the body is standing still in regard to the ether or whether it is moving in regard to the ether, even if no other body existed.

"If the theory of relativity is right, therefore, then there can be no such thing as the ether and the ether hypothesis is untenable. It becomes necessary, then, to look into this ether hypothesis to determine how it was evolved and what it means.

"The first theory of light which demanded attention was promulgated by

Newton. He explained light as a bombardment of minute particles projected at extremely high velocities. If this corpuscular theory of Newton's is right, then two equal beams of light when superimposed, must always combine to a beam of twice the intensity. Experience shows, however, that two equal beams of light, when superimposed, may give a beam of double intensity or they may extinguish each other and give darkness, or they may give anything between these two extremes. This can be explained only by assuming light to be a wave, like an alternating current. Depending on their phase relation the combination of two waves, as two beams of light or two alternating currents, may be anything between the

sum and the difference of the two intensities. Thus two alternating currents which are in phase add; if they are out of phase they subtract.

"If light is wave motion, there must be something to move, and this hypothetical carrier of the light wave has been called the ether. At this point our troubles begin.

"The phenomenon of polarization shows that light is a transverse wave; that is, the ether atoms, or whatever it is that moves in the ether, move at right angles to the light beam, and not in the direction of the beam as is the case with sound waves. In such transverse motion, a vibrating ether atom neither approaches nor recedes from the next ether atom, and the only way in which the



International

DO WAVEMETERS REALLY MEASURE "ETHER WAVES"?

If, as Dr. Steinmetz maintains, there is no such thing as ether there are obviously no such things as ether waves. Accordingly this machine, instead of recording lengths of ether waves, must be recording some other forms of resonant phenomena which do not rest upon the ether hypothesis.

vibratory motion of each ether atom can be transmitted to the next one is by forces that act between the ether atoms so as to hold them together in their relative positions. That is, transverse waves can exist only in solid bodies. As the velocity of light is extremely high (180,000 miles a second) the forces between the ether atoms, which transmit the vibrations, must be very great.

"In other words, the hypothetical ether is a solid with a very high rigidity—infinity more rigid than the hardest steel.

"At the same time the ether must be of extremely great tenuity, since all the cosmic bodies move through it at high velocities without meeting any friction. In the revolution of the earth around the sun either the ether stands still and the earth moves through the ether at twenty miles a second, or the earth carries a mass of ether with it. In the first case, there should be friction between the mass of the earth and the ether; in the latter case, there would be friction between the ether that is carried along with the earth, and the stationary ether. But in either case, the frictional energy would come from the earth and show astronomically as an increase of the length of the year and increase of the solar distance. And no such evidence of ether friction is observed.

"The conception of the ether is one of those hypotheses, which have been made in the attempt to explain some difficulty, but the more it is studied, the more unreasonable and untenable it becomes. It is merely conservatism or lack of courage which has kept science from openly abandoning the ether hypothesis. Belief in an ether is in contradiction to the relativity theory, since this theory shows that there is no absolute position nor motion, but that all positions and motions are relative and equivalent.

"Thus the hypothesis of the ether has been finally disproven and abandoned.

"There is no such thing as the ether. And light and wireless waves are not wave motions of the ether."

"What, then, is the fallacy in the wave theory of light, which has led to the erroneous conception of the ether?

"The fact that beams of light can cancel out each other, and can interfere, proves that light is a wave, a periodic phenomenon, just like an alternating current. Thus the wave theory of light and other radiations stands today just as unshaken as ever. However, when this theory was established the only waves with which people were familiar were the waves in water and sound. Both are wave motions. Waves involving movement of matter. As the only known waves were wave motions, it was natural that the light wave was also considered as a wave motion. This led to the question; what moves in the light wave? And this question led to the hypothesis of the ether, with all its contradictory and illogical attributes. But there is no more reason to assume the light wave to be a wave motion of matter than there is to assume the alternating current wave to be a motion of matter. We know that nothing material is moving in the alternating current, and if the wave theory of light had been propounded after the world had become familiar with electric waves of alternating currents, that is the waves of periodic phenomena (which are not wave motions of matter), the error of considering the light wave as a wave motion would never have been made and the ether theory would never have been propounded.

"Hence, the logical error, which led to the ether theory, is the assumption that a wave must necessarily be a wave motion. Electrical engineering has dealt

with alternating currents and voltage waves; it has calculated their phenomena and applied them industrially, but it has never considered that anything material moves in the alternating current wave and has never felt the need of an ether as the hypothetical carrier of the electric wave. When Maxwell and Hertz proved the identity of the electromagnetic wave and the light wave, the natural conclusion was that the ether is unnecessary also in optics. But curiously enough, we then began to talk about electric waves in the ether and about ether telegraphy. In other words, we dragged the conception of the ether into electrical engineering, where it never had been found necessary before.

"But, if the conception of the ether is unnecessary what are we to think of as the mechanism of the light wave and the electromagnetic wave?"

"Suppose we have a magnet. We say that this magnet surrounds itself by a magnetic field. Faraday has given us a

picture representative of the lines of magnetic force. Suppose we bring a piece of iron near this magnet. The iron is attracted or moved. A force is exerted on it. We say that the space surrounding the magnet is a magnetic field. A field, or field of force, we define as 'a condition in space, exerting a force on a body susceptible to this field.' Thus a piece of iron being magnetizable—that is, susceptible to a magnetic field—will be acted upon. A field is completely defined and characterized at any point by its intensity and its direction.

"To produce a field of force requires energy, and this energy is stored in the space we call the field. Thus we can go further and define the field as 'a condition of energy storage in space, exerting a force on a body susceptible to this energy.'

"The space surrounding a magnet is a magnetic field. There are other kinds of fields of force. For instance, if we electrify a piece of sealing wax by rubbing

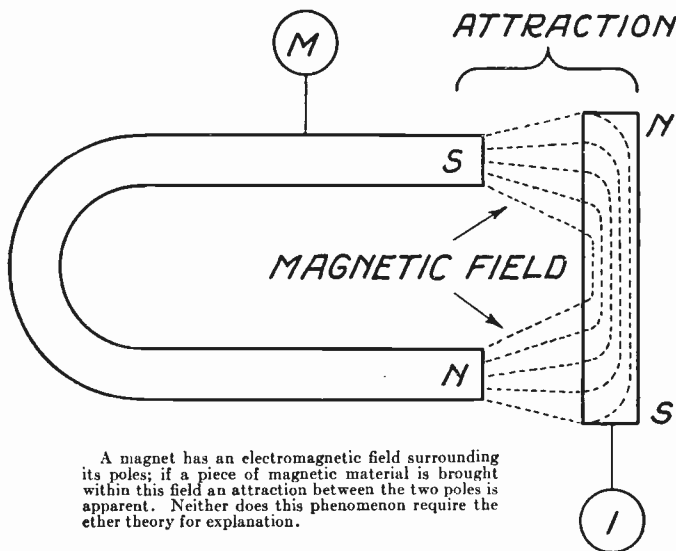

A magnet has an electromagnetic field surrounding its poles; if a piece of magnetic material is brought within this field an attraction between the two poles is apparent. Neither does this phenomenon require the ether theory for explanation.

it, it surrounds itself by a dielectric or electrostatic field, and bodies susceptible to electrostatic forces—as light pieces of paper—are attracted.

“So the earth is surrounded by a gravitational field. If a stone falls to the earth, it is due to the stone being in the gravitational field of the earth, and being acted upon by it.

“Now suppose that, instead of our permanent magnet with its magnetic field of force, we have a bundle of soft iron wires, surrounded by a coil of insulated copper wire, and that we send a constant direct current through this coil. We then have an electromagnet, and the space surrounding the magnet is a magnetic field. If now we increase the electric current, the magnetic field increases; if we decrease the current, the field decreases; if we reverse the current, the field reverses. If we send an

alternating current through the coil the magnetic field alternates, that is, the field becomes a periodic phenomenon or a wave: an alternating magnetic field wave.

“Similarly, by connecting an insulated conductor to a source of voltage we produce around it an electrostatic or dielectric field; a constant field, if the voltage is constant, an alternating dielectric field, (that is, a periodic or wave phenomenon), if we use an alternating voltage.

“Magnetic and electrostatic fields are usually combined, since where there is a current producing a magnetic field there is also a voltage producing an electrostatic field. Thus the space surrounding a wire that carries an electric current is an electromagnetic field, that is, a combination of a magnetic field and an electrostatic field. If the current and volt-

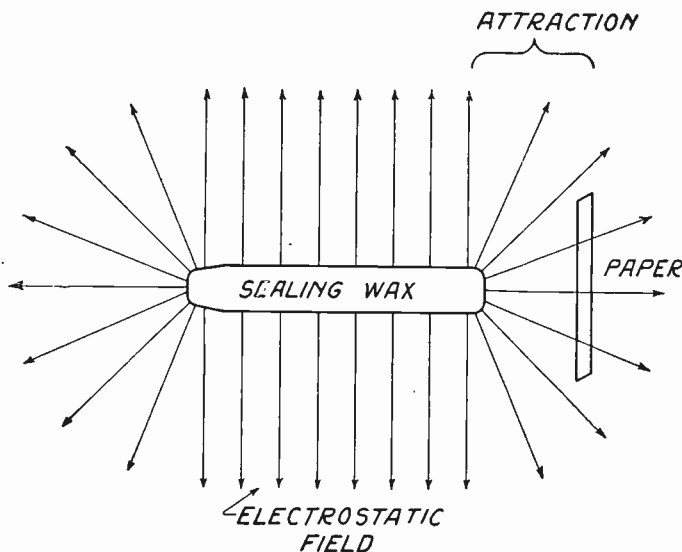

This diagram illustrates an electrostatic field that is set up around a piece of sealing wax by rubbing it with a bit of cloth, thus attracting such objects as pieces of paper, for example. This phenomenon does not rely upon the ether theory for explanation, states Dr. Steinmetz; it is explained on sounder scientific grounds.

age are constant, the electro magnetic field is constant. If the current and voltage alternate, the electromagnetic field alternates; that is, it is a periodic field or an electromagnetic wave.

"Maxwell deduced mathematically, and Hertz demonstrated experimentally that the alternating electromagnetic field (the electromagnetic wave), has the same speed of propagation as a light wave. It has been shown that the electromagnetic wave and the polarized light wave are identical in all their properties. Hence light is an electromagnetic wave.

"Electrophysics has been successfully developed to its present high state, has dealt with alternating currents, voltages and electromagnetic fields, without ever requiring a medium such as the ether.

"The conception of the field of force, or, as we should say more correctly, the field of energy, thus takes the place of the conception of the ether. The beam of light, the wireless wave, any electromagnetic wave is a periodic alternation of the electromagnetic energy field in space. Differences between light and other waves are merely those due to differences of frequency. Thus the electromagnetic field of the 60-cycle transmission line has a wavelength of

$$\frac{3 \times 10^{10}}{60} \text{ cm} = 5000$$

kilometers. The field is limited to the space between the conductors and their immediate surroundings. This is extremely small compared with the wavelength. Under these conditions, the part of the electromagnetic energy which is radiated into space is extremely small—so small that it can be neglected. In radio communication we use wavelengths of 15,000 to 200 meters and less;

that is, frequencies of 20,000 to $1\frac{1}{2}$ million cycles and more. The circuit is arranged to give the electromagnetic field the greatest possible extent, as it is the field which carries the message. Then a large part, even a major part, of the energy of the electromagnetic field is radiated. The frequency of the light wave is much greater still, 600 millions of millions of cycles. The wavelength, 50 microcentimetres, is a very tiny part of the extent of the field. Therefore practically all of the energy of the field is radiated; none is returned to the radiator.

"Our lack of familiarity with the conception of an energy field in space, and our familiarity with the conception of matter as the carrier of energy, may lead to the questions: What is the carrier of the energy of the field of space? Would not the ether be needed as a carrier of the field energy, just as on the older theory it was needed as a carrier of the hypothetical wave motion of matter?

"These questions are due to a mental error. Familiarity reverses the relation between primary and secondary conceptions.

"All that we know of the world is derived from our senses. They are the only real facts; everything else is concluded from them. All sense perceptions are due to energy; they are exclusively energy effects. In other words, energy is the only real existing entity. It is the primary conception, a conception which exists for us only because our senses respond to it. All other conceptions are secondary conclusions, derived from the energy perceptions of our senses. Thus space and time and motion and matter are secondary conceptions with which our mind clothes the events of nature."

END OF SECTION I

SECTION II

The Electricity of Radio

THESSE elusive little electrons that we have been considering are able to pass through organized matter with ease and an electric current is composed entirely of such particles bumping along from atom to atom or molecule to molecule. A very good idea of what happens will be gained from the illustration (page 46) where we see a crudely enlarged portion of a copper wire and the electron particles passing through it. In reality the copper atoms shown are much farther apart; so far indeed that if the proportionate distance were shown, the size of the paper upon which this course is printed would be hopelessly inadequate. However, for all practical purposes we can visualize the process as illustrated. Of course we must keep in mind, too, that these electronic current builders are anything but lethargic for they move through conductors with a speed so great that we cannot even imagine how fast they really travel. A racing automobile traveling 140 miles per hour is moving with an almost imperceptible speed—barely crawling in fact—when its rate of motion is compared with that of an electron rushing through a circuit at a rate of 35,000 miles per second.

These electrons are no different from the electrons that go to make up the atoms of matter. They are simply wandering electrons; electrons that have been torn loose from atoms to form a vast, roving population in the world of matter. Sometimes they become dissociated through perfectly natural

causes, but more often through the use of the devices which we have invented to pull them away from organized matter that heavy electrical currents may be set up and used. All of our generating devices are merely employed to set these electrons in motion through wires.

Let us for the moment return to our crude picture of the electrons crowding through the copper wire. They do not move with the same speed through all matter. For instance, in passing through a piece of iron wire they are not found so frisky because the atoms of the iron, for some reason not yet thoroughly understood, interfere with their passage. On the other hand a wire made up of silver would permit them to pass more freely than one made of copper. All of the metals could be arranged in a scale to show their relative resistance to the passage of electric currents. Some, like iron, lead and the trade wire, Nichrome, offer very great resistance while other materials like copper, silver and gold place very little resistance in the path of electronic current.

Substances that permit the free passage of electric currents which are nothing more or less than the passage of free electrons, are called conductors. A substance like water, although it is a relatively poor conductor when compared with copper, is, nevertheless, considered one of the conductors because it allows the passage of current in large quantities. There is no substance in the world that will not permit the passage of a certain amount of electric current



FIG. A: HOW ELECTRONS DRIFT THROUGH A CONDUCTING WIRE

Figure A: The small spheres represent the electrons; the large spheres represent the atoms of copper. The arrow shows the direction of drift of the electrons under the electromotive force applied by the battery. The electrons are really much smaller, in proportion to the atoms, than they are shown here. Collision of the electrons with the atoms is one cause of resistance.

but there are a few substances that pass so little that for practical purposes they are called non-conductors or insulators. Glass, for instance, puts up such an effective opposition to the passage of anything but a most insignificant number of electrons that scientists have learned to respect its resistance and they have placed it in the classification of the better non-conductors.

As a matter of fact, it is very fortunate for us that certain substances will not pass electricity freely for if this were not so we would find it impossible to carry electricity from one place to another over metallic channels. If we did not have insulators upon our telegraph poles the messages and power passing over them would, instead of going to a destination, leak off into the earth.

In many ways we may compare the flow of electricity through a metallic circuit with the flow of water through pipes. In the case of water, we find that it always has a certain pressure and that this pressure is usually measured in pounds per square inch. A water pipe may also deliver a certain amount or volume of water in a given time. If we stop to figure it out, we will find a direct relation between the size of the pipe (that is its internal diameter) the pressure of the water and the amount of water delivered per min-

ute. We should find that by increasing the pressure the amount being delivered per second will be increased. We should also find that if we doubled the size of the pipe but left the pressure the same, that the amount of water delivered would be greater.

Although we deal with different terms in the case of electricity flowing through a wire, we have practically an analogous condition. Even though electrons are more intangible than water it is evident that we must have some sort of a pressure to cause them to be moved through a wire, for any particle even though it be an electron, cannot be urged to move on without some physical incentive. A ball will roll down a hill unaided, but force must be applied if it is to be moved on a level surface. In the case of water, we always find it moving from a higher to a lower pressure. Electrons obey the same impulse but it is said that instead of flowing from a higher to a lower pressure they flow from a higher to a lower potential. The higher potential is called positive and the lower one is called negative.

Coming back to our water analogy, it will be remembered that the pressure of the water was figured in pounds. The measurement of the pressure of electrons is made in voltage. One volt

would be considered a very low pressure while 100,000 volts would be considered exceptionally high. The "volume" or flow of electrons, in place of being figured in gallons per minute as in the case of water, is calculated in units called amperes.

When water flows through a pipe there is a drop in pressure between the pump and the destination of the water at the end of the pipe line. This drop in pressure is due to the resistance offered by the pipe to the flow of the water; a certain amount of energy originally imparted to the water has to be used in overcoming the resistance in the line. This resistance will depend upon the diameter of the pipe and the conditions of the walls.

Our analogy between the passage of water through a pipe and electricity through a wire may be carried further by likening the falling of the pressure in a water pipe to the falling of pressure in an electric wire. In the latter case, this falling of pressure or voltage in a wire (as in the case of water) depends entirely upon the nature of the conductor; that is, whether it is brass, copper or iron and upon the size of the wire. If a very small wire is used, the current will meet a tremendous opposition and very little of it will flow. Such a wire would be said to have a high resistance. If the voltage should be pushed high enough, this little wire would finally burn up just as a water pipe with a pressure too high might burst. The substitution of a larger wire would permit the current to flow more freely and by reducing the pressure (voltage) the same amount of current could be made to pass.

Just as the pressure of electric current is measured in units called volts and the flow in units called amperes, so is the resistance measured in units called

ohms. This term is used in honor of Dr. Ohm, the German physicist who constructed the classic law of resistance which we are about to consider. In the case of measuring the resistance of very poor conductors the unit the megohm is used more conveniently, for the megohm is equivalent to 1,000,000 ohms. Very poor conductors may have a resistance as high as 500 megohms per cubic centimeter. When very minute resistances are employed (a large volume of pure silver for instance) the more convenient unit the microm is used. The microm is 1/1,000,000 of an ohm.

In reviewing these facts about the flow of electricity through a wire, the relationship between voltage, amperage and resistance must have been evident for we found that an increase in voltage caused an increased current to flow and that a decrease in resistance caused exactly the same thing to happen. We find that the flow of current can be controlled either by an (1) increase or decrease of resistance, and (2) by increasing or decreasing the voltage. Dr. Ohm found that these relationships took on a definite mathematical form and he expressed this form in Ohm's Law. Summed up it simply states that for a constant resistance, the current flowing in an electric circuit is directly proportional to the voltage and that for a constant voltage the current is inversely proportional to the resistance. Giving voltage the symbol "E" (meaning electro-motive force), resistance "R" and current "I," the following formulae make up Ohm's Law.

$$I = \frac{E}{R} \quad \text{or} \quad E = I \times R \quad \text{or} \quad R = \frac{E}{I}$$

As an example, let us assume that we have a circuit having a voltage of 12 as measured with an instrument known as a voltmeter. The amount of current

flowing as shown with an ammeter is found to be 2 amperes. According to Ohm's Law $R = E$ divided by I , and on this assumption 2 is divided into 12 which gives an answer of 6 ohms. Since Ohm's Law is of great importance in radio work, it will be wise to keep the forerunning facts in mind.

In Fig. B we notice how resistance may be added or divided depending upon the way in which it is connected in the circuit. In many cases engineers do this to properly control the flow of current. Instead of relying upon the natural resistance of copper wire forming the circuit, a wire having a very large resistance is wound onto a form and inserted. Such action, of course, always causes a drop in the amount of current flowing by reducing the pressure. At the top of the sketch we see the effect of two ohms of resistance in parallel or multiple. In this case the resistance will be the reciprocal or the equivalent resistance or I/R . Instead of the resistance being two ohms, as might

be supposed, it is $\frac{1}{2}$ ohm. By connecting the same resistance in series as shown in the lower portion of the sketch, the resistances are added and 2 ohms result.

Ohm's Law applies not only to portions of the circuit but to the circuit as a whole. If we had a generator and a circuit containing a number of electric lamps in series we should find it necessary to determine the resistance of each individual length of the wire and the internal resistance of the generator itself before we could add the factors together to determine the resistance of the complete circuit.

There will always be a drop of voltage when a current passes through wire offering resistance. The greater the resistance the greater the drop in voltage. If the terminals of a voltmeter are connected directly to the terminals of a resistance coil carrying a current the degree of drop in voltage may be determined by reading the meter. This is usually referred to as the drop in voltage or "potential drop."

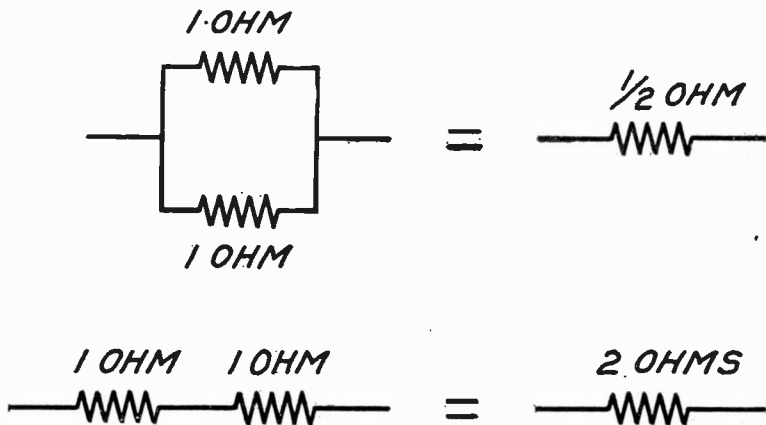

HOW RESISTANCES MAY BE ADDED OR DIVIDED

Figure B: The upper figure shows two resistances in parallel; the joint resistance is half that of either one. In the lower figure the same two resistances are connected in series; the joint resistance is then twice that of a single one.

It has been said that a flow of electric current is established only when a difference of potential or a pressure is created. There are a number of different ways of creating such a pressure. There is a chemical way of doing it which is carried on by the aid of devices called batteries. If a rod of zinc and carbon are inserted in a vessel containing a fairly strong solution of sal ammoniac there will exist between the copper and the zinc a difference of electrical potential. It will be found that the

furnace which, instead of consuming coal for its supply of energy, consumes zinc. This energy represented by the consumed zinc presents itself in the form of electronic flow in the circuit containing the cell and the motor.

If we had a number of such chemical cells on hand and connected them in series we should find that the voltages of the various units would be added together but their current capacity would be the capacity of one cell. If ten cells were arranged in series or tandem there

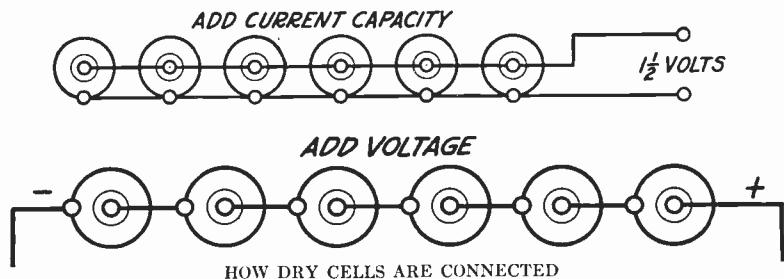

HOW DRY CELLS ARE CONNECTED

Figure C: At the top the cells are connected in parallel so that the voltage of the complete battery will be that of one dry cell. At the bottom the cells are connected in series so that the voltage of each cell is added. In the case shown there would be available 9 volts which is 6×1.5 .

carbon will have the higher pressure and it is consequently marked positive. The zinc having the lower pressure will be marked negative. If a voltmeter is connected between this negative and positive pole the degree of the electrical potential existing between these elements may be determined. It will be found to be in the neighborhood of 1.5 volts.

If a current consuming device like a small electric toy motor should be connected to this simple cell, a rather energetic chemical reaction would be set up between the sal ammoniac and the zinc plate as long as the circuit was closed. If this action should be continued long enough the zinc would gradually be consumed and would finally almost completely disappear. We find that we have here a sort of a chemical

would be available an electrical potential of 15 volts. This series connection is shown in the sketch. By arranging the batteries differently and placing them in what is known as parallel relationship the current capacity could be increased at the terminals. This parallel method of connecting the cells is also illustrated.

In the previous paragraphs we considered the flow of electricity as established by a chemical producer of potential differences. In applying the voltmeter to the chemical cell mentioned we would find that it would be necessary to connect the meter in a very definite way to have the needle or pointer register correctly. Reversing the meter would reverse the needle and no intelligent calculation of the voltage could be

formed. This proves that the current in this very simple producer of electricity is flowing in one direction only, just as water flows through a pipe. Such a current is called a direct current in electrical parlance and it is produced by batteries and sometimes by mechanical generators.

If we should wind a few turns of insulated wire around a nail and connect the terminals of this crude coil to an ordinary dry cell a most interesting thing would happen. We would find that the nail would have the property of attracting to it articles made of iron or steel. In short it would behave in exactly the same manner as a permanent steel magnet.

The magnetism of the nail could easily be accounted for by placing an ordinary compass close to a wire carrying current. It is known that a compass functions by reason of the magnetic poles of the earth and that it is extremely sensitive to magnetic disturbances. Any wire carrying a current will have about it a magnetic field and the compass will faithfully detect such a field if it is brought close enough to the wire so as to be within the range of its influence.

If we experiment with this compass and circuit a number of very interesting points may be brought out. By placing the compass at various distances from the wire and by varying the strength and voltage of the current we would soon find that the strength of the magnetic field, and, consequently its range of action, would depend upon the amount of current flowing. If the wire was large and a great quantity of current could be forced through it, the magnetic field in the vicinity of the wire would be strong and it would be found to influence the compass over a great distance.

When wire is formed into coils this magnetic field about it is concentrated and the amount of concentration depends upon the number of turns, the size of the wire, the amount of current flowing through it, the nature of the coil, etc. By using heavy enough current and enough wire, magnetic fields so powerful that they can attract several tons of iron may be produced.

If the little compass that we are describing should be brought into proximity with a heavy coil of wire carrying a current, it would be found that it could detect the magnetic field over a considerable distance. A real sensitive compass will sometimes indicate the passing of a street car several blocks away.

It has been found that magnetism will penetrate all solid substances. We could prove this by placing a piece of cardboard before the nail magnet. If this was done, the nail would still be able to attract to it small bits of iron and steel. However, careful calculation and experimentation has shown that all substances do not permit the passage of magnetism with the same degree of freedom. Air seems to offer considerable opposition while soft iron will greedily absorb magnetism. In fact, iron is the best conductor of magnetism that has been found and it is for this reason that it is used as a core in all magnets of the current consuming type. Such magnets, that is magnets that depend for their action upon the passage of current through a wire, are called electromagnets to distinguish them from permanent steel magnets that have no wire. It must be remembered, too, that electromagnets develop magnetic fields only so long as the current flowing through them exists. If the current is suddenly stopped the field collapses instantly and if the current is reduced in any way through the interposition of re-

sistance, the intensity of the field about the core will also be reduced.

A few iron filings, a piece of pasteboard and a permanent magnet of the horseshoe type are the only materials necessary to show that magnetism is not

of all permanent steel magnets.

In the electromagnets that we have been treating we have two different poles, a north pole and a south pole. Furthermore, there is a law in magnetism that states that like poles repel each

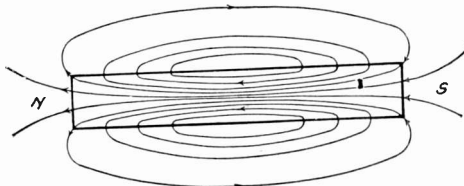

PERMANENT MAGNETIC FIELD

Figure D: The curved lines show how the magnetic field about a permanent magnet would appear if they were visible to the human eye. The shape taken by the field depends somewhat upon the shape of the magnet.

the topsy turvy action that we might have expected, but an orderly systematic disturbance that follows well established laws. If some of the iron filings are carefully scattered over the cardboard (Fig. G) it will be found that they try to assume different positions when the magnet is brought under them. It would seem that these tiny particles of iron struggle to align themselves in a definite pattern. When they do this, they follow what is known to

other and dislike poles attract each other. This statement can be very easily verified by bringing together the poles of two horseshoe magnets. If no action results it will be found that the like poles are in contact. If action does exist, it will be known that a north and a south, and a south and a north pole are connected.

It is surprising how a few simple materials will permit of an almost endless variety of experiments with electro-

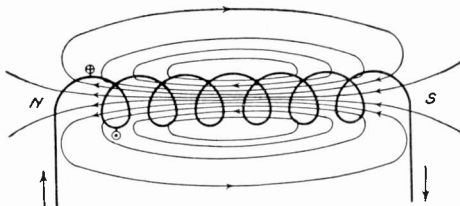

MAGNETIC FIELD ABOUT A COIL

Figure E: This diagram shows the similarity between a field produced by a permanent magnet and a coil of wire carrying an electric current.

electricians as magnetic lines of force. These magnetic lines of force are used merely as a matter of convenience in calculating the strength of magnets. These lines of force do not only exist around wires and coils but at the ends

magnetism. The winding of another coil of wire upon a nail and the addition of a sensitive current indicating device (called a galvanometer) to the experimenter's kit, makes possible demonstrations involving the elementary princi-

ples of electromagnetic induction. The galvanometer is connected to the terminals of the second coil and this coil is

brought into the neighborhood of the original coil connected to the cell. If the battery is alternately connected

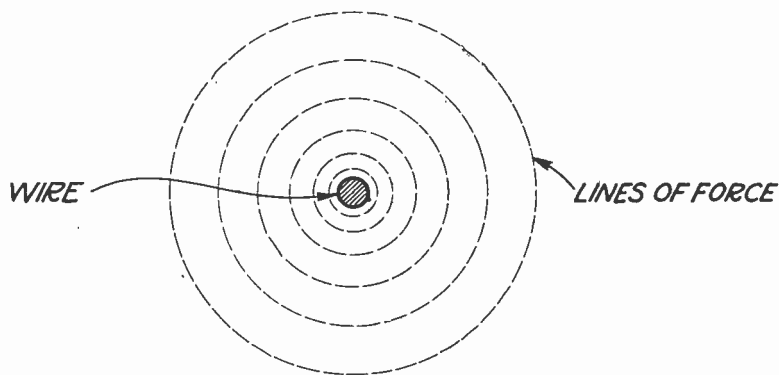

MAGNETIC LINES OF FORCE

Figure F: If the magnetic lines of force about a current carrying wire were visible and one of the wires in the coil at Fig. E should be cut the lines of force about it would appear as above. The strength of these lines depends not so much upon the voltage carried by the wire but the current strength. If a very heavy current was travelling through the circuit the lines of force would be proportionately great. Even with a very high voltage the lines of force would be small if the current was small. The student will also note that the lines of force become weaker in the outside circle which is indicated by the growing distance between the concentric lines. The field will be at maximum intensity close to the wire.

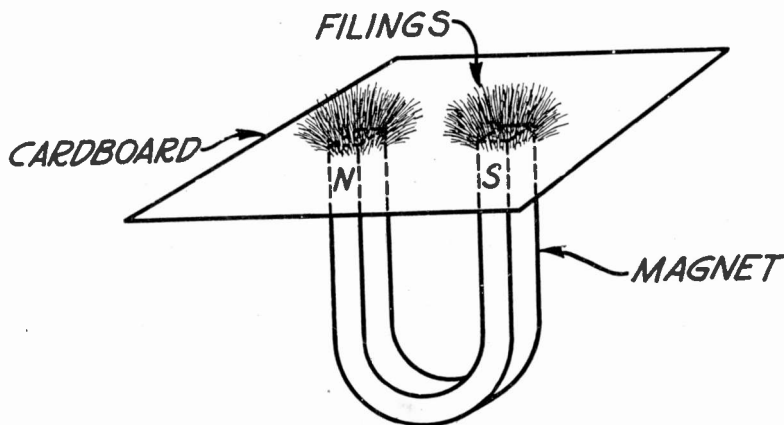

MAGNETISM OF HORSESHOE MAGNETS

Figure G: It was said in connection with Fig. D that the shape of the magnetic field produced by a permanent magnet which is a magnetized piece of steel depends upon the shape of the magnet. Here we really have a bar magnet bent into a horseshoe shape. This brings the magnetic fields which are strongest at the ends of the magnets into close relationship and hence a greater force is exerted. By placing a small piece of cardboard over the poles of a horseshoe magnet and sprinkling it with iron filings a very good idea of the course taken by the magnetic lines of force may be had. The tiny pieces of iron will tend to align themselves with the invisible magnetic force and will appear somewhat as shown in the sketch.

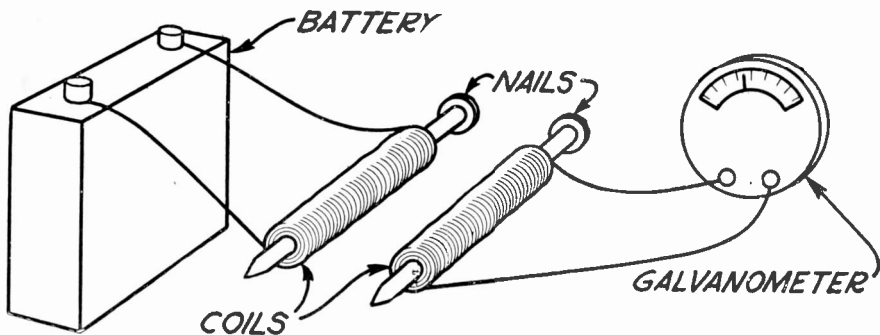

ELECTRIC ENERGY TRANSFER

Figure II: Here the student will see how it is possible for an electric current to jump across space from one circuit to another. The battery connected to the coil about the first nail generates a magnetic field which is picked up by the coil about the second nail, reconverted back into an electric current and registered on the sensitive galvanometer. The distance over which this energy transfer will take place depends upon the strength of the battery, the size of the coils, etc.

and disconnected, the indicating needle of the measuring instrument will jerk back and forth in response. This indicates that an electric current has been set up in the second coil although it is in no way connected to the first coil except through these invisible lines of force.

This simple experiment proves that a very definite relationship exists between electricity and magnetism for we have set up a magnetic field by the aid of an electric current and reconverted it back into its original state. Not only this, but we have succeeded in transmitting electric energy across space, which is, of course, wireless. While we do not care to go into the matter of radio at this moment, it may be said that very similar phenomena are involved.

Transmitting energy from one coil to another in this fashion is called electromagnetic induction and it finds great application in the workaday world, not only in radio but in telegraphy, telephony, power generation, etc. It is the most valuable property of electric current.

Let us come back again to the ex-

periment with the coils. It was noticed that the indicating needle of the measuring instrument was jerked into motion only upon the instant of connecting the battery. Even though the battery was left in connection, the needle dropped back to zero. This simply means that no current can be transmitted across space unless the magnetic lines of force are in motion, or unless the coil picking up the magnetic lines of force is *caused to constantly cut through the lines of force*.

This simple law of electromagnetic induction may be demonstrated in another fashion. A coil of wire is wound upon a cardboard mailing tube and the terminals of the coil are connected to a current indicating instrument. A permanent steel magnet is then inserted in the coil. As long as the magnet is moved within the coil the indicating needle of the instrument will show the presence of a current. However, if the magnet is permitted to remain stationary no current will flow. If the magnet remains stationary and the coil is moved, the current will flow again. In either case the wire turns of the coil

were made to cut through the invisible lines of force. In other words, work must be done before electromagnetic energy can be transformed into usable electric current. If the mere presence of a steel magnet inside a coil of wire would generate an electric current we would not need to burn coal or harness waterfalls to generate power. It would only be necessary to construct large

power it is necessary to connect the steam engine to an electric generator and if one horsepower of electric current is to be produced the power of the steam engine must be at least one-and-one-quarter horsepower for there is always a loss when power is transformed from one kind to another.

So far we have been dealing with direct current (D.C.). By this we mean

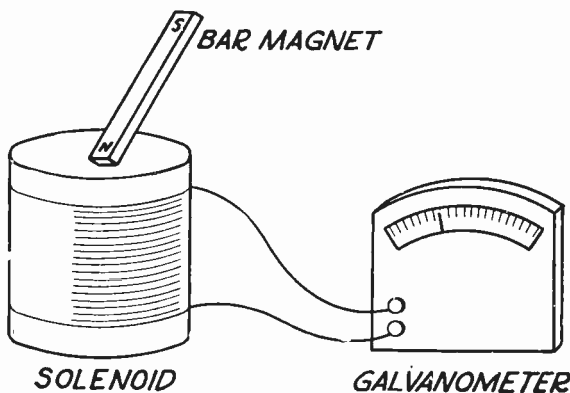

SIMPLE CURRENT GENERATOR

Figure 1: Here is another experiment that further illustrates the mysterious connection between electric current and magnetism. As long as the bar magnet is moved inside the solenoid shown there will be a deflection of the galvanometer needle which indicates the generation of a current. It is upon this simple principle that all electric generating machinery is based.

coils and place magnets within them. The law of the conservation of energy says that this cannot be done and the little experiments which we have just conducted prove that it cannot be done.

From the last experiment we receive the idea of the method used in the generation of electric power. An electric dynamo or generator is nothing more than a coil of wire revolving upon a shaft through a magnetic field. The magnetic field is set up by what is known as the "field windings" of the generator. If we wish to transform kinetic energy (energy of motion) produced by a steam engine into electric

a unidirectional current; a current flowing between positive and negative in one direction only. Such a current may be supplied by a battery or by what is known as a D.C. generator.

We are now ready to take up a widely applied form of current called alternating current (A.C.). Alternating current is quite different from direct current in that it does not hold to a uniform direction of travel. Rather it insists on going first in one direction and then in the opposite direction. An automobile or any moving object cannot move and stop and reverse itself unless the energy that is moving it in the original direction is

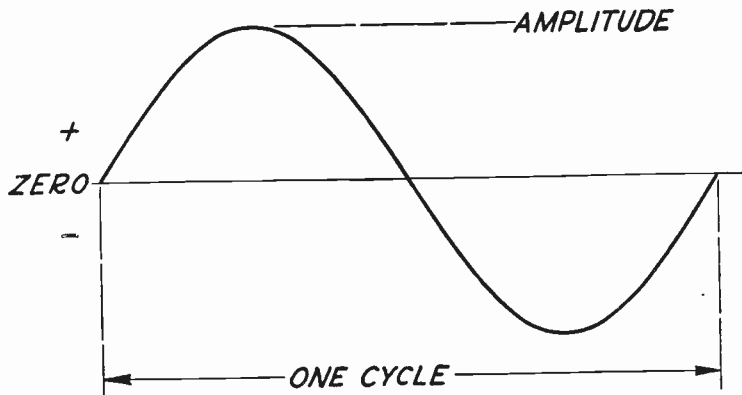

PICTURE OF AN ALTERNATING CURRENT

Figure J: This shows how an alternating current starts out at zero voltage, rises to maximum amplitude, drops back to zero and turns about doing the very same thing in the opposite direction. The number of times it does this in one second is referred to as its frequency which is always expressed in cycles. 60 cycles would mean that it was making 120 reversals per second.

brought down to absolute zero. You cannot set an automobile going twenty-five miles an hour and reverse its direction from forward to backward instantly without first bringing the energy expended down to zero. The same holds true of electric current. When it changes its direction of motion its voltage and amperage first drop to zero and for the barest instant of time there is absolutely no current flowing in the circuit.

This interesting action of alternating current can best be explained by the aid of a diagram. In the diagram we have a line which represents zero current and zero voltage. One side of the line represents one direction and the other line the opposite direction. The current starts out at zero and gradually increases until the voltage and amperage reach a maximum. The current then prepares itself for reversal and gradually drops back to zero. Then it starts out in the opposite direction and does exactly the same thing again. The number of these reversals that occur in a second of time

determines the frequency of the current. We often hear it said that such and such a circuit has a sixty-cycle current travelling in it. This simply means that the current is reversing itself one hundred twenty times a second and that each complete reversal from zero to zero and back to zero is a cycle. We have both high and low-frequency alternating current and although one hundred twenty reversals in the space of a single second may seem to be a very great speed to the dull human mind, it is mere loafing for an electric current with its extremely mobile electrons. Electric currents do not reach the high-frequency class until they are reversing at least 500,000 times a second in their circuits. This frequency may be carried to five million with very little difficulty.

Let us see what would happen if a coil carrying an alternating current was brought into the proximity of a second coil connected to a current indicating instrument capable of registering alternating currents. It would be found that a current, almost the exact replica of the

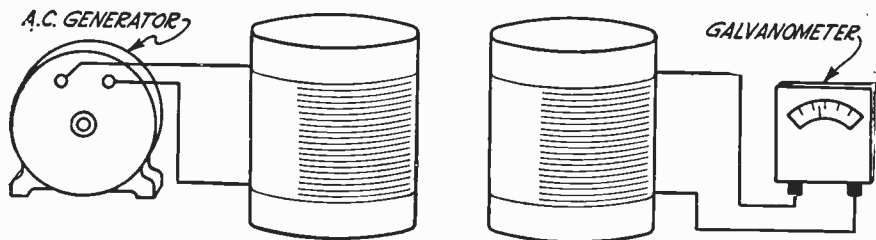

A. C. ENERGY TRANSFER

Figure K: This shows how an alternating current, due to its constantly fluctuating quality, may be transferred from one circuit to another by electromagnetic induction.

original current, would be developed or *induced* in the second coil. This is intriguing because we remember that in the case of direct current a current existed in the second coil only while the first coil was being moved through the magnetic lines of force. In the case under discussion, however, we must remember that we have a current that is constantly going up and down from zero to maximum and that this is equivalent to interrupting the current as we did in the dry cell. This constant interruption causes the magnetic field to build up and collapse and it is this movement of the field that causes it to constantly cut through the turns of wire in the second coil thereby building up an electrical potential that faithfully follows the action of the current in the first coil. Since we deal largely with this particular principle of electromagnetic induction in the science of radio, it will be well for the serious student to convince himself that he thoroughly understands the foregoing before passing on to a further consideration of the subject.

Since we discovered that iron is a much better conductor of magnetic lines of force than the surrounding air, it follows that a maximum transference of electrical energy between coils can be brought about only by providing an iron magnetic path between the coils. This proves to be true in practice. If

it is decided to transmit current from one coil to another the coils are wound upon hollow forms and these forms slipped over a soft iron frame.

It is natural for the student to ask, "What possible object could we have in merely transferring current in this fashion? Why not simply leave the coils out and complete the circuit without them?" If we desired to use the current in its original form this system of coils (which is usually called a transformer) would be quite unnecessary. In fact it would be highly impractical because it is at its best an inefficient instrument. It is only when electricians wish to *raise or lower the voltage* of a current that transformers are used. Whether the voltage of a current will be raised or lowered depends entirely upon the way the transformer is designed and principally upon the number of turns or the ratio between the number of turns in the first coil and the second coil. Incidentally it might be well to mention at this point that the first coil or the coil in which the current enters the instrument from its source is called the primary and the second or output coil is called the secondary.

Let us take into hand the simple problem of increasing the voltage of a sixty-cycle current. It will be assumed that a voltage of two hundred and twenty is desired instead of one hundred

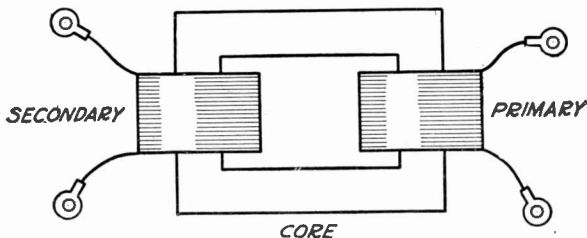

CLOSED CORE TRANSFORMER CONSTRUCTION

Figure M: The transformer illustrated above is called a closed core transformer because its core encompasses a certain area. The portion of the core upon which the secondary and primary are wound is referred to as the legs. For instance, there is the primary leg and the secondary leg. The coils of transformers are carefully insulated from the core to prevent short circuits and in the case of high voltage transformers the various layers of wire have to be insulated from each other so that the voltage will not be able to break down the insulation on the wire.

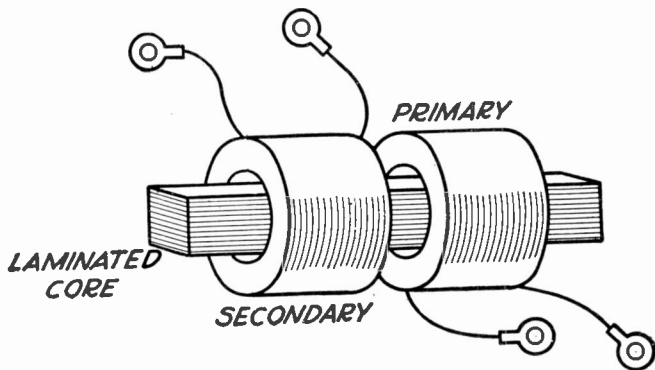

OPEN CORE TRANSFORMER

Figure N: When both primary and secondary coils of a transformer are wound on a rectangular core as illustrated the device is referred to as an open core transformer. They are less efficient than the closed core types because a continuous magnetic path for the field developed by the primary coil is not available. The cores in these transformers may be either round or square in cross section.

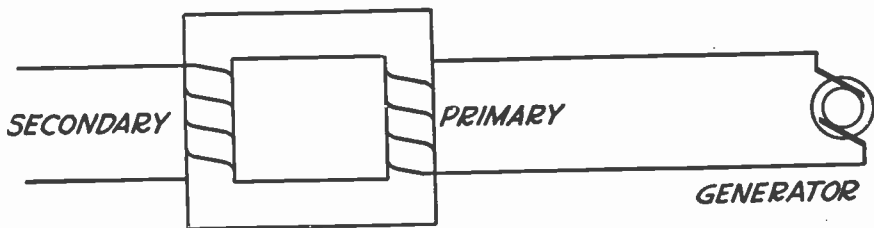

CLOSED CORE TRANSFORMER

Figure L: By providing an iron path between the coils shown in Fig. K the efficiency of the energy transferring system could be greatly improved because of the ease with which iron transmits magnetic lines of force. The side of the transformer connected to the generator is called the primary while the output coil of the transformer is called the secondary.

and ten. In other words, we wish to multiply our voltage by two. This simply means that there will have to be twice as many turns in the secondary as in the primary or a ratio of two to one. If we desired to triple the voltage, the ratio would have to be three to one, etc. We could keep on increasing this ratio between the windings until an electrical pressure of one million volts would be induced in the secondary coil.

It is evident that we cannot increase both the current and the voltage for here again we would be interfering with the law of the conservation of energy. We must not forget that as we increase the voltage and the current we increase the power for voltage times amperage equals watts (there are 746 watts in one horsepower). If we increase the voltage we must reduce the amperage and if we increase the amperage we must reduce the voltage. In other words we cannot get something for nothing.

Transformers are used for many purposes in both radio and electricity in general. Perhaps their most important function in the workaday world of electricity is that of boosting voltage for long-distance transmission lines. By using a high pressure, that is a pressure from thirty to one hundred and fifty thousand volts, the line losses are reduced and it is possible to use smaller conductors.

The electric lighting companies all use power transformers for home lighting is distributed to neighborhoods at a rather high pressure. It is then tapped off through the secondary of the transformers and delivered to the consumers.

We also find transformers that reduce the voltage to a very low point by increasing the current far beyond the values used for ordinary purposes. Such transformers are usually called *low pressure transformers* and they are used mostly for welding purposes. Perhaps

a secondary output would be in the neighborhood of ten volts but a current of several hundred amperes may be made to flow even with this small pressure if the wire used in the secondary leg of the transformer is very large and but a few turns are employed.

It is well to keep in mind the fact that all transformers are not of precisely the same type. Some of them have open cores and others closed cores. The difference between these two types is illustrated on page 57. In either case the core material must be of suitable iron laminations. A material called silicon steel is used extensively for this purpose.

When we come to the study of alternating current we really come to the parting of the ways for the study of alternating current brings with it numerous phenomena that are not associated with direct current. One of these phenomena is the ability of an alternating current to pass through a solid dielectric material used in electrostatic condensers. To assist our understanding of this peculiar property let us refer to Fig. O, where we see a D.C. generator connected to two metal plates separated by an insulating sheet. In the case of D.C. we may look upon this as an open circuit for there is an insulator interposed between the two terminals of the generator. These two metal plates separated by a sheet of insulation (which may be mica, hard rubber, glass or paraffine paper) constitute an electrostatic condenser and we find that the current of the generator is used for the small fraction of a second in storing electricity in this condenser. However, when D.C. is used the condenser, like a water reservoir, simply becomes filled up and the current from the generator stops flowing, or, in other words, the load is taken off the generator.

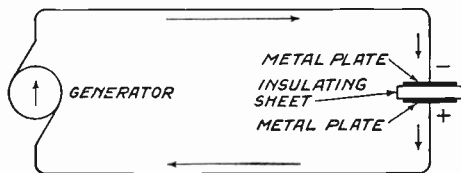

CONDENSER AND GENERATOR

Figure O: A direct current generator connected to a condenser will store up a charge on the condenser plates, one side positive and one side negative. The condenser may be discharged by connecting the plates together.

The time required for the generator to charge the condenser depends roughly upon two factors, the size of the condenser and the voltage of the generator.

The simple experiment above may be very beautifully and convincingly demonstrated by the use of a current indicating instrument. Such an instrument placed in the circuit would indicate the flow of a current while the condenser was under charge, but the needle would fall back to zero after its momentary deflection.

If this condenser were placed in an alternating current circuit it would be found that the current would pass through it rather freely, depending upon the design of the condenser and the voltage and frequency of the current. In general it would be found that the lower the frequency the larger the condenser must be for the condenser would be called upon to discharge automatically at the voltage peak of every current reversal. In the case of very, very low voltage and extremely high frequency such as found in radio circuits, the condenser would need be extremely small so that it could respond rapidly.

The capacity of condensers to hold electric currents depends largely upon the nature of the dielectric substance (the insulator) and upon the distance the plates are apart. At this point it is well to note, too, that all condensers are

not made up of two plates. As a matter of fact, very few condensers are made up of two plates. Most of them have many sets of metal and dielectric plates pressed together in a unit. A condenser having maximum capacity for any given current will be a condenser having a high dielectric material with very small separation between the metal plates. The closer these plates are the greater will be the capacity providing a highly efficient dielectric substance is used. If too thin a dielectric is used, the voltage that charges the condenser may puncture it and render the entire device inoperative.

Air is found to be an exceptionally efficient dielectric material and in figuring the dielectric constants of other materials air is taken as 1. Glass, depending upon its nature and manufacture, ranges from 4 to 10, mica from 4 to 8, hard rubber from 2 to 4, paraffine from 2 to 3 and porcelain from 3 to 4.

We may say in general that there is always an electrostatic capacity between bodies of different electrical potential. In radio we often hear it said that an antenna has a capacity. This is because the antenna is at one potential and the earth at another while the dielectric air is the medium in between. However, for direct current this capacity effect, as it has often been called, can usually be overlooked for it is so

rarely met that it does not interfere with operation of any sort.

If a condenser of suitable size were connected to an alternating current generator in the manner in which the condenser was connected to the D.C. generator an indicating instrument in the circuit would betray the presence of a current constantly flowing. The con-

tential while the other will be at a low potential. If the experimenter should put one hand in contact with the outer coating of tinfoil and the other hand in contact with the inner coating so that both the coatings would be connected through the body, a terrifying shock would be experienced. If a bent piece of wire attached to a hard rubber

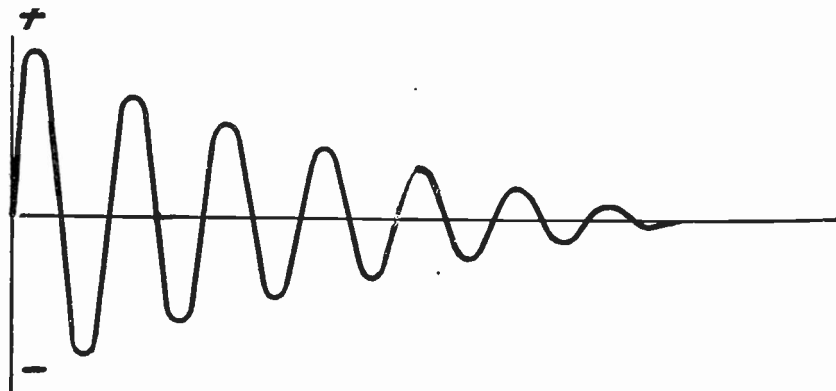

LEYDEN JAR DISCHARGE

Figure P: This is a picture of how the current produced by a discharging Leyden Jar or condenser would look if it could be charted. It starts out with great gusto but rapidly spends its force and tapers off to zero value.

denser would be charging and discharging in step with the current (providing it was large enough) and the generator would be practically short circuited.

By another very simple experiment it is possible to charge a condenser and to watch it discharge. This may be done with a spark coil or what is known as a Wimhurst machine; a device that is capable of generating high voltage currents by friction. If a Leyden jar (a Leyden jar is a glass bottle covered inside and outside with tinfoil), which is a crude sort of a condenser, is properly connected to either a Wimhurst machine or a spark coil in operation, it will accumulate a very heavy charge of electricity—one side of the glass in the bottle will be at an extremely high po-

handle is brought into contact with two such surfaces, a heavy crashing spark will result as the condenser discharges.

Although this discharging of the Leyden jar was accomplished in the small fraction of a second, many very interesting things happened. There was not simply one mad rush of the current from one surface to the other to level the electrical potential. The original rush of the current was so great as to bring the opposite side of the condenser to a higher voltage than the originally charged surface. This causes a reversal of the current and the process is repeated a number of times before the condenser is really discharged. The action of a discharging Leyden jar is depicted in Fig. P. We see that the current is

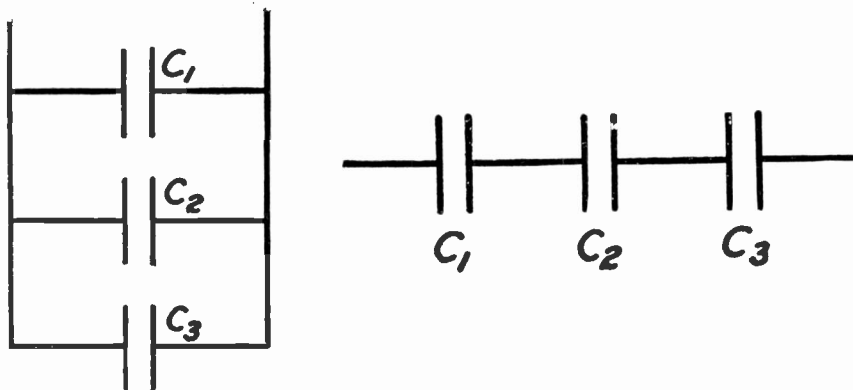

CONDENSER CONNECTIONS

Figure Q: Here we see the two principal methods of connecting condensers so that they may be made useful for various purposes. These connections hold true for all types of condensers, Leyden Jars included.

alternating or oscillatory in nature. First the current reaches a high value and then through a long series of reversals it gradually dies out just as one might strike the free end of a spring when the opposite end is held in a vise. The spring would vibrate with gradually decreasing amplitude until it finally came to rest.

This business of condensers may confuse the reader who remembers how emphatic we were in our statement regarding insulators. It was very definitely claimed that insulators would only permit comparatively small amounts of current to pass. We may still regard this as true for direct current but we must make reservations for alternating current, and especially alternating currents of high frequency. This does not mean that alternating current cannot be insulated. It can be but there is always a little loss through this "condenser effect" unless the conductors are widely separated.

As to the actual mechanics of this transfer of energy through insulating materials we can say little. The present theories of dielectric absorption

and the like could be included but the introduction of these subjects would probably confuse the lay student who, after all, is more anxious to know the practical side of radio than the purely theoretical side.

It is very important that the student should know the effect of connecting condensers in series and in parallel. It might be thought at first hand that should a number of condensers be connected in series their capacities would be added. This is not the case, however, for three condensers connected in series as illustrated at the right of the sketch on this page would give a total capacity smaller than the capacity of any single member of the group. If it is desired to connect condensers so that their capacity may be added they must be connected in parallel as shown in the Fig. Q. Here total capacity = $C_1 + C_2 + C_3$.

We have been talking about the capacity of condensers without considering the unit used in the measurement of these capacities. Since it was Michael Faraday who conducted most of the first practical research in connection with condensers the unit of ca-

capacity was chosen in his honor. It is called the farad. Now a condenser with one farad capacity would be so tremendous as to be quite beyond practical consideration. In other words condensers do not need to be made that large. For that reason a smaller unit is used. This unit is called the microfarad and a condenser of one microfarad capacity has a capacity of 1/1,000,000th that of a condenser with one farad capacity. In other words the micro-

tive resistance, or in other words a coil of wire. Alternating currents do not pass through coils of wire in the same way as direct currents. Here the current lags behind the voltage. In either case the lag may be as great as ninety degrees; that is the voltage may be caused to lag behind the current 90 degrees or the current behind the voltage 90 degrees.

Before leaving this subject of condensers, let us keep in mind the fact

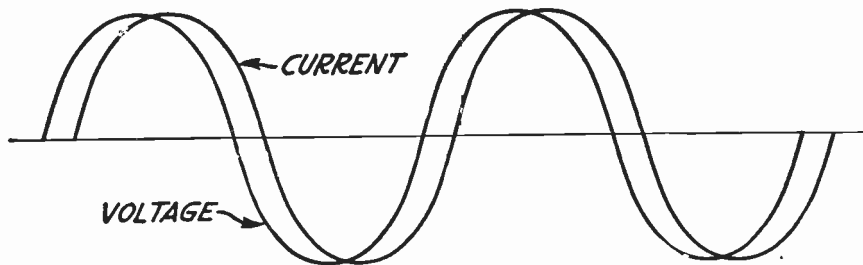

ALTERNATING CURRENT LAG

Figure R: When an alternating current is made to pass through a condenser the current is caused to jump ahead of the voltage and the degree of this jump will depend upon the capacity and nature of the condenser. The theoretical limit of this lead is 90 degrees. However, this point has never been reached.

farad is 1/1,000,000th of a farad. In extreme cases, where infinitesimal capacities are to be calculated, the still smaller unit, the micro-microfarad, is used.

An alternating current passing through a condenser does a very funny thing. Before reaching the condenser the voltage and amperage are travelling hand in hand so to speak. The introduction of a capacity in an alternating current circuit causes the current to lead the voltage. This is illustrated graphically in the sketch where we see the line representing the current leading the line representing the voltage. Exactly the opposite effect would be produced if the condenser were taken from the circuit and replaced with an induc-

that condensers have an actual ohmic resistance and that this ohmic resistance is not as high as might be expected simply because the current is called upon to pass through a dielectric material. If a condenser is properly designed with the correct materials used in its construction it may have an ohmic resistance of a fraction of an ohm.

While on the subject of resistance it is well to point out that Ohm's Law cannot be applied to alternating current calculations as it is applied to direct current. Changes in the formula are necessary to account for inductive, capacitive and reactance effects.

We are now ready to take up the subject of electrical measurement through the medium of instruments. While it

would be possible in many cases to determine the flow of potential through the application of Ohm's Law it is much more practical and convenient to apply a calibrated instrument so that the result may be had without calculation.

The two most used instruments in electrical measurement are the voltmeter and the ammeter. The voltmeter is a device which measures volts and the ammeter is a device which measures amperes and fractions of amperes. It will be seen at the outset that an instrument designed to give readings in connection with direct current circuits could not be so employed in alternating current circuits. We must not forget that in the case of alternating current we have a rapidly fluctuating current rising to amplitude and falling to zero many times during the course of a second. If a direct current instrument were placed in such a circuit the needle would simply vibrate and no indication of the potential or current value would be given. It is necessary to employ a special type of meter on alternating current circuits and therefore we have alternating current and direct current meters.

In radio, where we deal with especially small currents, it is necessary to use instruments of a very delicate nature and to measure in very small units. For instance, in radio circuits current is usually measured in millivolts and milliamperes. The prefix "milli" meaning 1/1000th of an ampere or 1/1000th of a volt. In some cases the microvolt or micro-ampere is used as a unit of measurement. This is equal to 1/1,000,000th part of either of the units mentioned.

Early in the nineteenth century it was found that when two dissimilar metals were brought together and heated that a current of electricity was generated.

The two metals forming the union make up a unit called a thermo-electric battery or thermo-electric generator. This very principle is used a great deal in measuring radio currents. In Fig. S we see the method used. An extremely small wire is connected between points A and A1. Two dissimilar metals, B and B1, are brought into junction with the fine wire and the metals are connected to the terminals of a very sensitive galvanometer. The wire between the points A and A1 is so fine that a very weak electrical current will cause it to heat and while this heat may not be perceptible it nevertheless raises the temperature of the thermo-electrical juncture and develops a current in the circuit containing the galvanometer. The current in this circuit will be in exact proportion to the amount of heat developed in the wire, which, on the other hand, depends entirely upon the amount of current.

The most superficial layman would understand that either a direct current or an alternating current may be used with an instrument operating on the thermoelectric principle. In either case heat will be developed through the passage of the current. The heat due to a given number of amperes of alternating current is the same as that of an equal number of amperes of direct current.

There still is another method of measuring currents of any frequency by the application of the heated wire. A very fine wire is stretched between two points and connected to a pointer of very delicate construction. The passage of the current through the wire causes more or less heating which is indicated in current strength upon the hand calibrated scale (See Fig. T).

While instruments like the above are used a great deal in measuring currents of radio frequency, magnetically con-

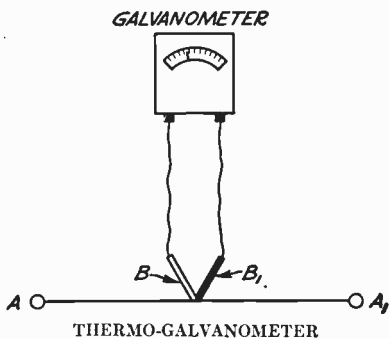

Figure S: Here we see a thermo-couple made up by the metals B and B1 connected to a galvanometer. The current passing from A to A1 heats the couple and causes a second current to be generated.

trolled instruments are still widely used and if we refer to Fig. U we will be able to readily determine the principle used in what is known as d'Arsonval meters. A tiny coil of wire is delicately pivoted between the poles of a powerful steel magnet. The needle (which is connected to the coil) and the coil are held in a normal zero or no current position by the action of a small hair spring similar to that found in watches. Very flexible lead wires are brought from the tiny coil and connected to the terminal poles of the instrument. When the instrument is brought into contact with a source of current through its terminals, part of this current will flow through the tiny coil and naturally will set up a magnetic field about it. This field will cause the coil to have a tendency to align itself with the field already existing between the north and south pole of the permanent magnet. The degree to which it succeeds in this depends upon the voltage of the circuit.

The circular piece of iron placed in the center of the moving coil and between the north and south pole of the permanent magnet is used to form a low resistance path for the magnetic lines of

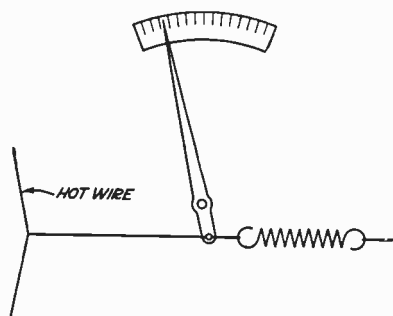
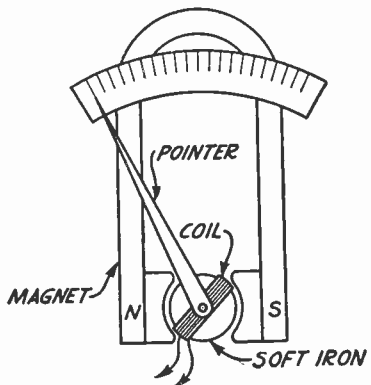

Figure T: When a current passes through the hot wire the wire expands causing the spring to move the needle over the scale of the instrument. The amount of expansion depends upon the strength of the current.

force. The interposition of this greatly increases the efficiency of instruments of this type.

It will be understood that the moving coil for d'Arsonval instruments may be made for practically any sensitivity providing the active parts are sufficiently delicate. Instrument makers have developed amazing ingenuity in the application of this absorbing principle and instruments capable of registering in microvolts and microamperes are not at all uncommon. The moving parts have been refined to such an extent that fifty microamperes are sufficient to cause the indicator to move over a rather large scale. Even a single ampere is a relatively small amount of current and when we divide it into a million parts we have left but an unimaginable whiff of energy.

We said that our last instrument had a moving coil made up of a fairly large number of turns of very small wire. Such an instrument is used to measure voltage and is very properly called a voltmeter. While the same type of instrument is used in constructing ammeters the resistance of the coil must be low. It is evident that to keep the re-



D'ARSONVAL INSTRUMENT

Figure U: Here is shown the principle of all D'Arsonval instruments, which consists of a current carrying coil balanced in a strong magnetic field. The coil is mounted upon delicate bearings and tends to rotate when a current passes through it. D'Arsonval instruments are widely employed.

sistance of this coil low will ultimately result in making the moving parts heavy and unwieldy. Low resistance means large wire and large wire means greater weight. Hence the smaller ammeters are made only for the measurement of small currents. When large currents are to be measured, ammeters are provided with what is known as a shunt which is illustrated. This shunt is usually made of a number of strips of special alloy large enough to safely carry the current. Upon reaching this point, the current divides most of it going through the shunt while a small portion of it flows through the meter. Since the resistance of the shunt is known, the amount of current flowing through the ammeter can be used as a basis for calculating the current flowing in the main circuit. Therefore, the scale of the ammeter can be used to register the actual number of amperes flowing through the circuit containing the shunt.

Many radio experimenters during

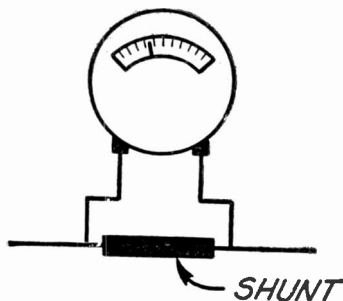

HEAVY CURRENT MEASUREMENT

Figure V: By providing a specially calibrated ammeter with a heavy shunt thousands of amperes can be measured with safety to the instrument. Only a small fraction of the current is allowed to pass through but this is in proportion to the amount of current passing through the shunt.

their most inquisitive days have had the sad experience of attempting to learn the condition of their storage battery with an ammeter of the pocket type. To their surprise the ammeter was probably burned out for when such an instrument is placed across the terminals of a storage battery the battery is practically short circuited. The resistance of an ammeter is very low and probably as many as 40 or 50 amperes might flow through it from the battery heating and destroying the device to a point beyond repair.

A voltmeter may be connected across the terminals of a storage battery with absolute safety for here we have an instrument with a high resistance capable of choking off a damaging supply of current.

In Fig. W we find that voltmeters and ammeters are connected to circuits in different ways. One is usually in series and the other in multiple. By connecting two instruments up in this fashion the current and voltage of a

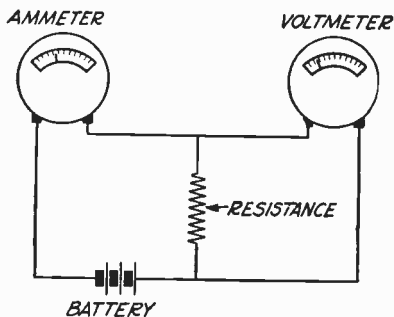

CURRENT AND VOLTAGE MEASUREMENT

Figure W: This shows how a voltmeter and ammeter would be connected to measure the current and voltage of a simple battery circuit. It will be noticed that the instruments are connected differently.

circuit may be registered simultaneously.

We must not think that the types of instrument described represent the whole range of current indicating devices. There are innumerable different types and designs, but those which we picked for description are used almost entirely for radio calculations.

By the proper use of a simple voltmeter and ammeter fairly accurate calculations in resistance can be made. In the sketch we see the connections necessary for what is known as the drop method of calculating resistance. Only a voltmeter is necessary for this test. This is connected to a two-way switch which permits the meter to first be thrown across a known resistance. This permits the voltage drop across the known resistance to be measured. The meter is then connected across the unknown resistance and the voltage drop is again measured. We then have:

$$\frac{\text{drop across known resistance}}{\text{drop across unknown resistance}} = \frac{\text{known resistance}}{\text{unknown resistance}} \quad \text{from which we}$$

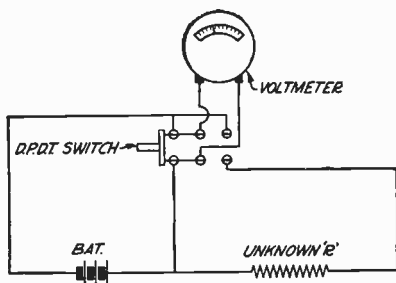

RESISTANCE MEASUREMENT

Figure X: Here is shown a method of measuring the resistance by the drop method. By determining the degree of voltage drop across R and knowing the other factors it is possible to calculate the resistance of R.

$$\text{obtain unknown resistance} = \frac{\text{known resistance} \times \text{drop across unknown}}{\text{drop across known resistance}}$$

There is a more accurate method of measuring resistance by the aid of a device called a Wheatstone bridge. If Fig. Y is studied it will expose the underlying principle involved. There are four arms to the bridge, A, B, C and D. Current flows through all four from a battery and the voltage of this battery is immaterial so long as it is capable of forcing a current through the arms. Arms C, A and B are made up of variable resistances carefully calculated so that the resistance of these parts of the bridge is known at all times. The unknown or X resistance is connected to the arm D. When this is done the resistance in arms A, C and B are adjusted until zero current flows through the galvanometer. The galvanometer will then come to a normal position of rest. If it is found that A and C have 20 ohms and 200 ohms respectively B will be 30 ohms and D will be $30 \times 200 \div 20 = 300$ ohms.

Before leaving this subject of pure

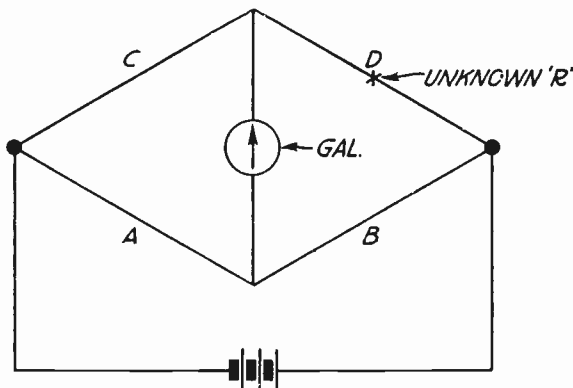

CONNECTIONS OF THE WHEATSTONE BRIDGE

Figure Y: Although many important electrical calculations can be made with a Wheatstone Bridge the connections of the device itself are comparatively simple. The "arms" A, B and C are made of variable resistances. They are shown as mere straight lines here as a matter of convenience.

electricity it will be well to gather in a few simple facts concerning the electrodynamic generation of current. Reference to Fig. Z will aid greatly in understanding the simple principles involved in the production of direct current. Here we have a permanent magnet which, as we already know, is capable of developing a magnetic field about its poles. From the simple experiments described previously it was also shown that the movement of a coil of wire through a magnetic field so that the coil cuts the lines of force resulted in the setting up of a current. If a coil of wire is wound upon a shaft and revolved between the poles of a magnet as shown, there will be generated in the coil a current of electricity. This current is led off for use by a device known as a commutator. This is really a rotating connector making contact with stationary parts called brushes. The brushes are the real terminals of the generator and they are connected to the outer circuit.

The revolving coil in a generator of this type is referred to as an armature.

The magnet in this case would be called the field magnet since it is depended upon to produce the magnetic field through which the armature rotates.

A little thought will make it evident that the voltage and amperage of this little generator that we have sketched depends upon (1) the strength or density of the magnetic field between the poles, (2) size and number of turns of wire of the armature, and (3) speed with which the armature revolves. If the armature is wound with extremely fine wire and revolved at high speed so that it cuts through a large number of lines of force in a second there will be available at the terminals of the generator a very high pressure or voltage. If, instead of a large number of turns of fine wire, there is placed upon the armature a small number of turns of very coarse wire we will have instead of a high voltage a high amperage and a low voltage. Thus it is seen that the output of the generators may be controlled to a nicety by the application of these well investigated rules of design.

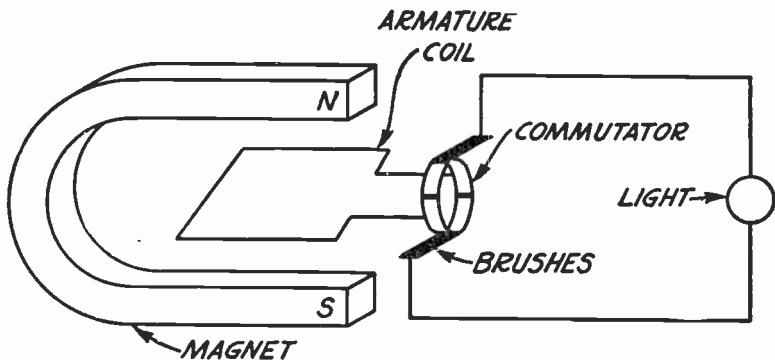

D. C. DYNAMO PRINCIPLE

Figure Z: It will be seen that a D. C. dynamo is nothing more or less than a coil of wire moving in a magnetic field with means provided for leading the current away from the moving coil with sliding contacts.

The generator that we have shown is of the simplest type imaginable. The application of the bare permanent magnet is made practically only in the case of magnetos used on ignition systems of automobiles. Larger and more efficient current generators are always provided with what is known as a field winding. Generators with field windings do not have permanent magnets. In place of

permanent magnets, soft iron is used and the field windings, soft iron is used and the field windings are placed over this iron mass. It is the function of the field winding to take a small portion of the current from the terminals of the generator to build up the magnetic field. While it is true that iron loses practically all of its magnetism when the exciting source is withdrawn there is always enough residual magnetism

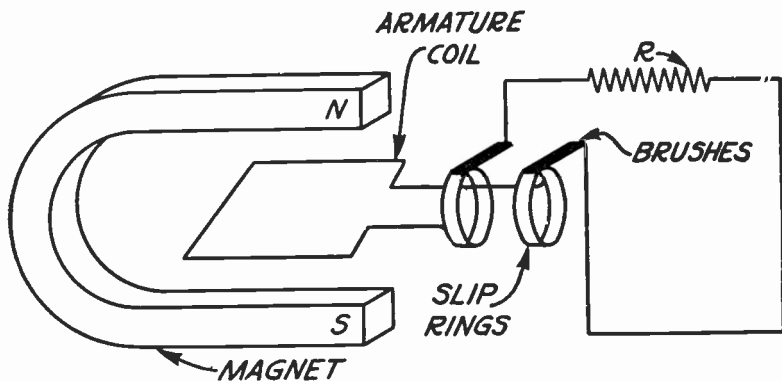

A. C. GENERATOR PRINCIPLE

Figure AA: The principle involved here is the same as that in the dynamo in Fig. Z save that the commutator arrangement is different. By employing two rings as shown the current produced by the moving coil is caused to zigzag back and forth in its circuit.



PICTURE OF A DIRECT CURRENT

Figure BB: This shows how a direct current would look with a single coil and a simple two piece armature.

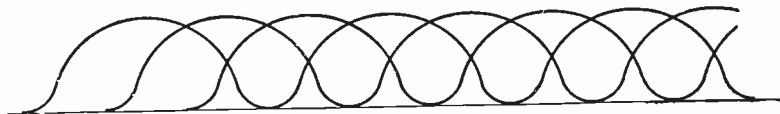

A DIFFERENT DIRECT CURRENT

Figure CC: This shows how the current would look when produced by a three-coil D. C. armature.

left in the iron field to permit the generator to build up when power is applied to its armature.

We must not make the mistake of taking the above as an accurate description of all of the direct current generators used. There are several different types and a profusion of different designs. For instance, commutators of all but the simplest types are made up of a number of copper segments in place of the two shown in our sketch and instead of one independent coil there is a number of coils connected to the segments.

We have just completed a discussion concerning direct current generators, that is, generators that are capable of producing direct current. However, they do not produce direct current in the sense of a dry battery. That is, the current produced, although it is in the same general direction, is not of uniform value. It will be seen that every time the brushes come to a break between the segments there will be an interruption. In the case of a simple two-pole generator the current produced at the poles if charted would appear as shown in Fig. BB. The current does not change its polarity but it falls back to zero in each revolution. By increasing the number of coils in the armature and

the number of segments and by providing the field with a pole to match each coil we produce a current or a series of currents that take the form shown in Fig. CC. The tendency of each generator is to build a fairly uniform current. The little variations are known as ripples and for all ordinary purposes the current may be looked upon as uniform.

If we wished to change our first simple direct current generator into an alternating current generator it would only be necessary to alter one part. That would be the commutator. In place of a two segment commutator we would use two independent metal rings each one attached to one terminal of the armature coil. The brushes would make contact with these rings. Under such conditions there would be two complete reversals of the current at every revolution of the armature. We see, then, that the frequency of such a generator would depend not alone upon the speed of the armature but upon the number of coils in the armature and upon the number of poles in the field of the generator. By providing the generator with two field coils and four poles the frequency would be doubled at the same speed.

Aside from the facts just mentioned,

alternating current generators operate on the same principle as direct current generators; currents are produced with armature coils that cut through magnetic fields.

The amount of current generated by either a direct current or alternating current producer depends to a certain extent upon the load in the external circuit. If the external circuit is opened

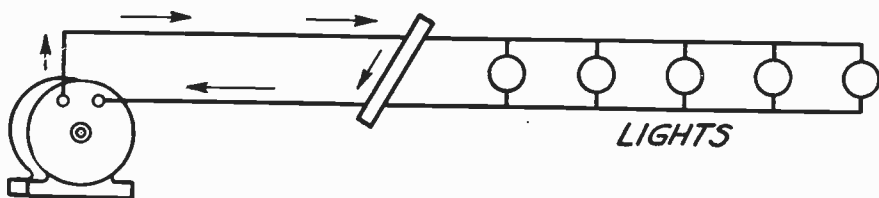

WHAT A SHORT CIRCUIT MEANS

Figure DD: When the path of an electric current is shortened as it would be in the sketch, the current always increases because of the shortened path and what is known as a short circuit is developed.

and there is no current flowing in it there will be no load on the generator and, save for mechanical friction, no resistance will need to be overcome in turning the armature. With such conditions prevailing the generator would be said to be running idle. When the external circuit is closed current is immediately induced in the armature and there is set up in it a magnetic field opposing the original magnetic field developed by the field coils. The amount of opposition will be determined by the amount of current flowing in the armature coils and this in turn depends upon the size of the wire and the amount of current that is required by the devices in the external circuit. Let us imagine that a heavy conductor is thrown across the external circuit of the generator as illustrated. Since nature has decreed that electricity will always follow the path of least resistance, it is evident that the current flowing will avoid the part of the circuit beyond the point where the conductor

was thrown across it. This will permit an exceptionally heavy current to be built up in the generator and a tremendous load will be thrown on the whole system. If no provision has been made for such an emergency either the wire comprising the external circuit will melt through at the excessive passage of current or the windings in the armature of the generator will be burned out.

To prevent such dangerous accidents, which, in the case of large power houses, might run into as much as \$100,000, circuit breakers or fuses are used as a protection to the circuits and generators and also as a protection against fires, for a heavy current on the rampage is a prolific producer of fire. In the case of circuits carrying only a few hundred volts fuses are employed. A fuse is nothing more or less than a strip of metal made up of a low melting alloy. Lead is the basis of it. This little strip of metal is designed to have a definite current carrying capacity. When this capacity is overstepped through a short circuit or through the action of a device requiring too much current for the safety of the circuit, the excessive current heats up the alloy instantly and causes it to melt or "blow." The melting of the alloy, of course, interrupts the circuit and it is left "open" until a fresh fuse is inserted.

The circuit breaker, which is used for heavy currents where fuses would be

impractical, operates upon an electromagnetic principle. A movable contact element is placed before the poles of two heavy electromagnets. These magnets carry the current that is passing through the circuit. The moving part of the breaker is provided with contacts that are normally closed. However, when the current becomes too strong the magnets exert a greater force upon the movable element and it is eventually drawn down opening the circuit as it moves.

We have, in this portion of the course, gained a fairly comprehensive idea of the romantic side of electricity. The laws

and effects that we have studied and assiduously absorbed are extremely pertinent to the subject of radio for after all radio is a mere subdivision of electricity. All of the laws of electricity hold true in radio and for this reason it is always necessary for the student to gain at least a superficial knowledge of practical electricity before he ventures further into the still more fascinating realm of radio.

The ambitious student must be warned against passing on to what follows without first having assured himself that he is familiar with the electrical principles outlined.

END OF SECTION II

SECTION III

Diagrams—The Shorthand of Radio

As in chemistry, the radio man has a shorthand method of expression which he uses in sketching out circuit connections. In place of depicting the constructional details of transformers, sockets, coils and the like, symbolic characters that have been agreed upon by the profession are used. The reader will not only find that an understanding of the symbols used will be of great convenience to him in practical work, but that few articles pertaining to radio can be intelligently assimilated without a mastery of radio shorthand. Since the editors of the present instruction believed that the student should be led into the practical phases of the study as soon as possible, it was decided

to insert this matter here. This will permit the use of standard diagrams throughout the remainder of the course.

After a little practice the student will find the symbol method of diagram printing a most convenient help in his work of radio experimentation or in keeping abreast with radio progress by constant perusal of the current publications. As time goes on he will find himself capable of absorbing the electrical details of any circuit presented in this fashion by a mere glance at the instruments shown and their position. It will also be found very easy to use these symbols in preparing notes on the subject of radio. Radio diagram symbols are practically standard.

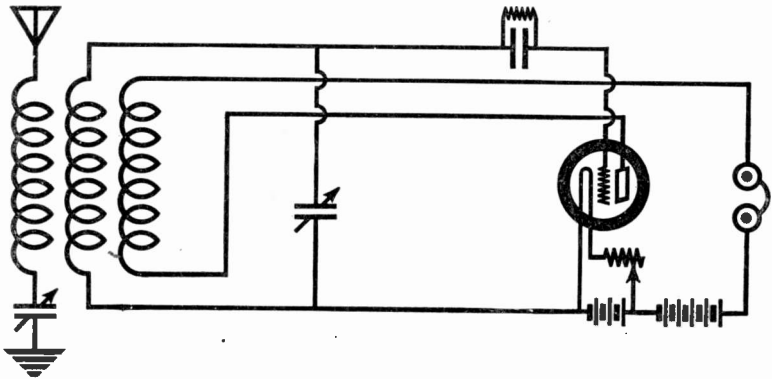

DO YOU KNOW WHAT THE ABOVE SYMBOLS MEAN?

Unless you do, you cannot understand the practical and useful hook-up drawings that constitute such a valuable part of this course.

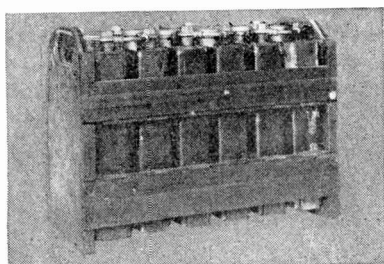

"A" BATTERY—Until recently the "A" or filament-lighting battery was almost universally of the storage type. It may be well to note here that the UV-201-a tube is primarily a storage-battery tube, and that it is not economical to operate more than one of these tubes on dry cells. However, the use of tubes, such as the UV-199 and WD-11, which operate on an "A" battery made up of dry cells, has increased materially in the last year or two. Although made up of several cells, the "A" battery has two main terminals

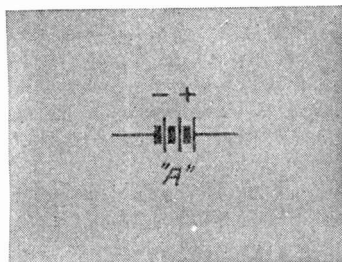

which connect to the filament of the tube; one of these is positive and the other negative: Make sure that the voltage at these terminals is correct for the tubes you are using, and also that the "A" battery is capable of furnishing current for the number of tubes which you intend to use. Three WD-11 tubes should have three dry cells connected in parallel, for instance. One dry cell would have the same voltage but it could not furnish current for three tubes economically. By using three cells in parallel the current is divided between the three.



"B" BATTERY—The "B" battery is made up of a number of "flashlight" cells connected in series and sealed together in a convenient container, there being fifteen of the cells in the $22\frac{1}{2}$ -volt size and a correspondingly larger number in the higher-voltage batteries. The large-type "B" battery will prove more economical for a permanent set, while the smaller sizes have their points of advantage for portable sets. The detector battery is usually a $22\frac{1}{2}$ -volt, tapped

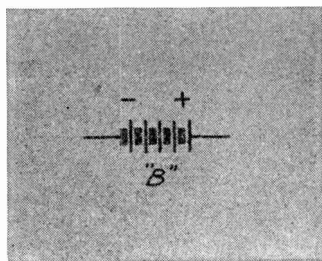

type which gives any voltage in steps of $1\frac{1}{2}$ volts from $16\frac{1}{2}$ to $22\frac{1}{2}$ volts for soft detector tubes which are critical to plate voltage. The amplifier "B" battery can be conveniently made up of $22\frac{1}{2}$ or 45-volt blocks connected up in series to give the required voltage. The battery made up in this manner will have two outside or unconnected terminals, one positive and one negative, and these will form the connections to the set.

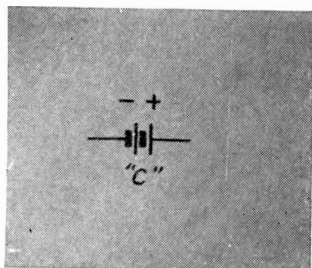
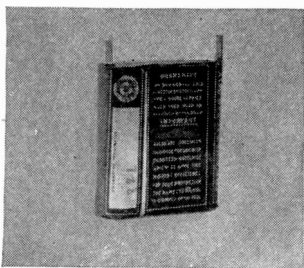

"C" BATTERY—With more than $67\frac{1}{2}$ volts on the plate of the average tube it is advisable to connect a "C" battery in the grid circuit to bring the potential of the grid to the correct negative point with respect to the filament. Small flashlight cells of 3 to $4\frac{1}{2}$ volts make good "C" batteries and are easy to obtain. To connect a "C" battery in an amplifying circuit, break the grid lead

between the amplifying transformer and the filament, and connect the ends to the two terminals of the "C" battery, the negative side of the latter should be toward the transformer and grid. Another advantage of the "C" battery is that it cuts down the average plate current greatly and makes the "B" battery last much longer. There is very little current drain on the battery.

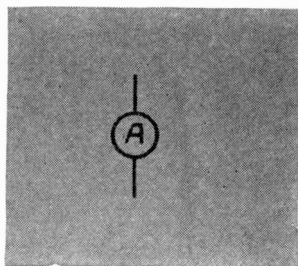
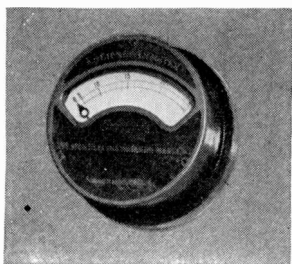

AMMETER—The ammeter is a device for measuring the current flowing in some particular circuit; for instance, it could be placed in the filament circuit of a vacuum tube to see how many amperes were being drawn from the storage battery. An instrument for smaller current values (the milliammeter) could be connected in the plate circuit of the vacuum tube to see how many thousandths of an ampere were being drawn from the "B" battery. An ammeter never measures how many amperes there are in the battery, but it does measure the number of amperes that

some other instrument is drawing from the battery or whatever source of power we may have. The ammeter has two terminals and is always connected in series in the circuit; that is, one of the wires of the circuit is broken and the two resultant ends are connected to the two terminals of the ammeter.

It is not unusual to see ammeters sketched in diagrams with shunts across their terminals. Shunts are used when exceptionally heavy currents are to be measured and they are usually depicted by an oblong which represents a solid piece of copper.

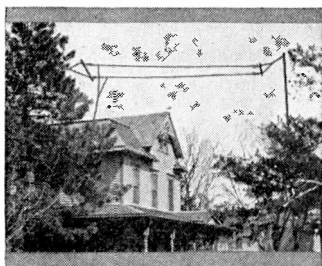

ANTENNA—The most common type of antenna (and one that gives universal satisfaction for receiving) is the single-wire "L" type, approximately 100 feet long. It is insulated at each end, preferably with a glazed porcelain antenna insulator, and the lead-in to the receiving set is taken off at one end. Number 14 seven-strand bare copper wire is most suitable for antenna wire because of its

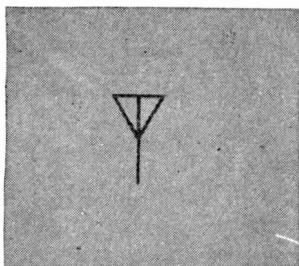

larger surface and greater strength than the solid wire of the same gauge. For transmitting, four parallel wires are often used to give greater radiating area; a wire joined to each of these is in turn connected to the single lead-in. As the multiple lead-ins always are joined to one common wire we may regard the antenna as having a single connection and thus it is shown in the diagrams.

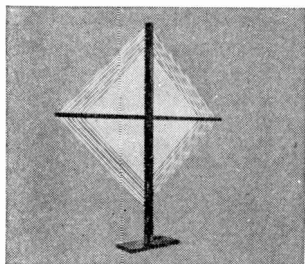

LOOP ANTENNA—The regulation outdoor antenna always gives reception over greater distances and also louder signals than the loop on the same receiving set. However, circumstances may make the use of a loop necessary; in this case the amplification will have to be increased considerably over what would be necessary with the outdoor antenna. Two or three stages of radio-frequency amplification will be required in addition to the customary detector and two stages of audio-frequency amplification. Do not attempt to use a loop on the ordinary three-bulb regenerative set. For broadcast reception the

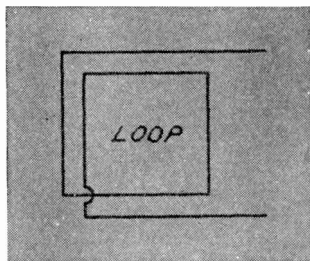

loop antenna may consist of twelve turns of No. 18 wire wound in a square, two feet on a side, the turns being separated one-half inch. The loop antenna has two connections, although one of these may be arranged so that it can be cut in on different turns.

Although numerous methods showing loops are employed by technicians, the form taken will usually approximate the one shown. The number of turns may vary, some engineers using but a single turn of wire, but there will always be a representative feature that will enable the reader to recognize the instrument.

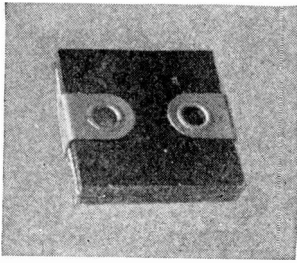

FIXED CONDENSER—The most satisfactory type of fixed condenser for receiving sets, and one that is comparatively inexpensive, is the small mica condenser of reliable make. As the amount of energy handled is extremely small, it is not advisable to use home-made condensers of doubtful quality. One of these small condensers of .00025 or .0005 mfd. capacity can often be connected in series with the antenna to cut down the wavelength if necessary. In

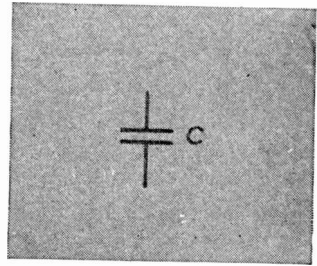

places where some loss does not matter and where the cost of a mica condenser of such large size would be prohibitive, such as the filter condensers for transmitting sets, paper condensers are often used. The fixed condenser has fundamentally two metal surfaces which are separated by an insulating sheet, although the metal surfaces may be made up of a large number of sheets. There are two connections, one to each of the metal surfaces.

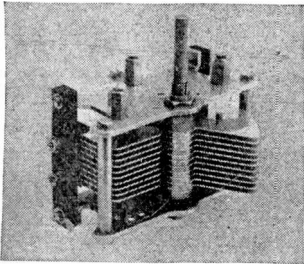

VARIABLE CONDENSER—The variable air condenser has become fairly well standardized in form; it consists of a number of stationary plates, closely spaced and connected together, and approximately the same number of rotary plates which are also connected together and which mesh between but do not touch the stationary plates. The condenser has two connections, one to the stationary plates and one to the rotary plates. Always connect the rotary plates to the part of the circuit which is nearest the ground potential to

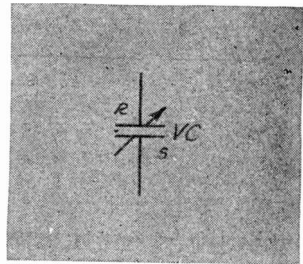

avoid "body-capacity" effects. The condenser should be well made *mechanically* and *electrically*; the bearings should fit well and preferably be of metal; and the stator and rotor should be separated by a good insulating material to avoid excessive dielectric loss.

This method of showing a variable condenser is practically standard. Sometimes one of the lines that is shown parallel here is curved slightly to represent the movable plates. This, however, should not confuse the reader who knows the general symbol.

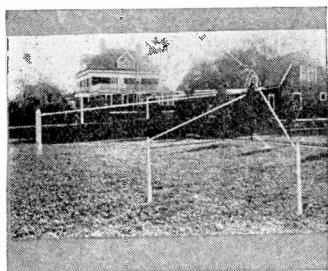

COUNTERPOISE—When a ground connection is impossible or when a natural ground gives too high a wavelength on our transmitting set, we fall back on the counterpoise; this is placed below the antenna and far enough above ground to clear obstructions. The counterpoise may take the form of the antenna or it may be spread out fan shape. At any rate it should be well insulated just the same as an antenna; otherwise, if it should be grounded (even poorly) at some

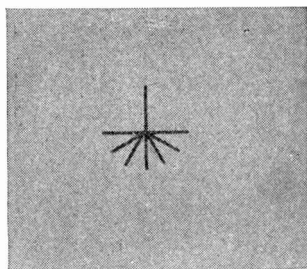

point, we defeat the purpose of the counterpoise which is to give a uniform electric stress over its entire area much the same as the stress between condenser plates. The wires of the counterpoise should be all connected and soldered together to form a single lead-in to the transmitting or receiving set. The form and size taken by any counterpoise will depend somewhat upon the space available for it. In any case, it is always indicated as illustrated,

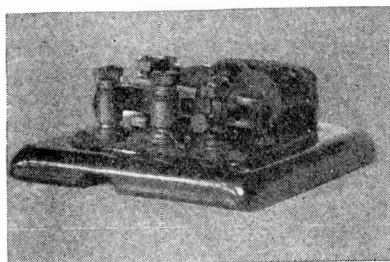

BUZZER—The chief uses of the buzzer in radio are for code practice and for testing out crystal detectors to find a sensitive spot. The buzzer for either of these purposes should (preferably) be one of the special high-frequency type. The note of an ordinary call buzzer is much too low. For code practice a buzzer, battery (dry cell) and a key are simply connected in series. For testing crystal-detector adjustment, a buzzer, battery, and a key or push button are connected as above, and in addition a

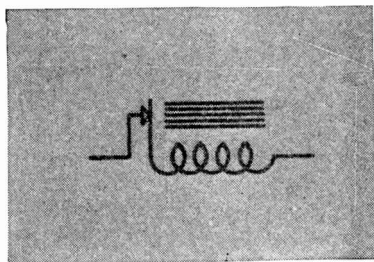

wire is connected, from the binding post nearest the buzzer interrupter, to the ground lead of the receiving set.

Sometimes buzzers are shown with one electromagnet and sometimes with two. However, this is not technically important for a buzzer with one electromagnet functions in exactly the same way as a buzzer with two magnets. It will be noticed that the wiring diagram of the buzzer itself is shown. This may be done because of the simplicity of the circuit used in such instruments.

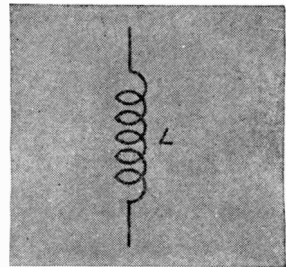
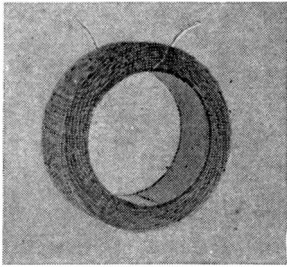

RADIO-FREQUENCY CHOKE COIL—
The uses of the radio-frequency choke coil are very similar to the audio-frequency choke coil except that it is constructed to operate at much higher frequencies and is therefore generally made with an air core. The coil shown in the illustration is an ordinary honey-comb coil, which type is usually satisfactory for radio-frequency choke-coil

purposes. The radio-frequency choke consists of a single winding and has one connection at each end. Such a coil may be used in a low-power vacuum-tube transmitting set as a radio-frequency choke in the grid-leak circuit or in the plate circuit to keep the high-frequency energy from getting back into the power supply. These coils find many uses;

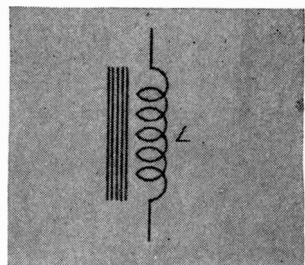
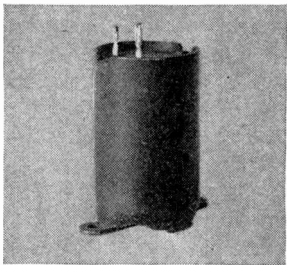

AUDIO-FREQUENCY CHOKE COIL—
The audio-frequency choke coil consists of an iron core with a continuous winding, and has two connections, one to each end of the winding. The choke coil has a tendency to smooth out variations in current as its magnetic field opposes all changes in the current. An example of this use is to steady the plate current of a transmitting tube by connecting one or more choke coils in series with the rectified supply. There is always a drop in voltage across a choke coil and this is used in choke-coil-

coupled amplifiers. The choke coil is connected in the plate circuit of one tube and the drop across it used to operate the succeeding tube in the next stage of amplification.

Sometimes audio-frequency choke coils are constructed so as to be variable by taps. When they are arranged in this manner diagrams usually give some indication of the variable feature. When the coil is shown without taps it is usually taken to mean that the inductance is of fixed value. Such coils are also used as A. C. chokes.

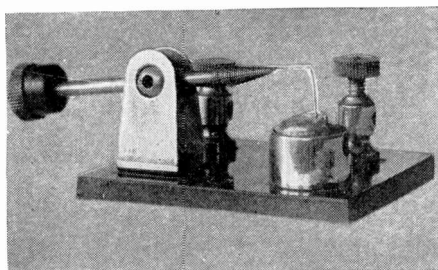

CRYSTAL DETECTOR—The crystal detector generally takes the form of a fine wire or "cat-whisker" pressing lightly on some kind of mineral crystal; the common minerals are galena, silicon, pyrites, carborundum or one of the synthetic crystals. Within 15 to 25 miles of the large broadcasting stations the crystal set will give good, clear reception on

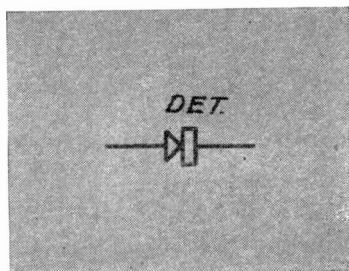

the telephones; a loudspeaker cannot be used with a crystal set. In selecting a crystal detector see that it is so constructed mechanically that the entire surface of the crystal can be easily explored with the "catwhisker." There are two connections to the crystal detector, one to the "catwhisker" and one to the cup which holds the mineral.

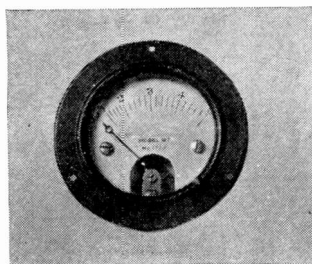

GALVANOMETER—The galvanometer is a delicate instrument for indicating a small electric current, but is not used for measuring current. That is, it may be used to show when the current is minimum or maximum, but not the exact value of it. The galvanometer is useful in bridge-measurement work where it is necessary to compare unknown values of resistance, inductance or capacity with standards of the same. It can also be used for wavemeter work in radio. The galvanometer has two connecting

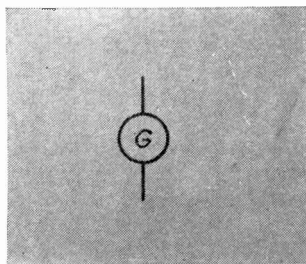

terminals and there will always be shown two wires running to it in any circuit diagram.

In the case of the galvanometer we will also find that other writers prefer to show it diagrammatically in different styles and while it will be standardized throughout this course we cannot always expect to find it illustrated in this fashion outside this work. However, galvanometers are frequently identified by the letter "G" which is usually placed inside the circle.

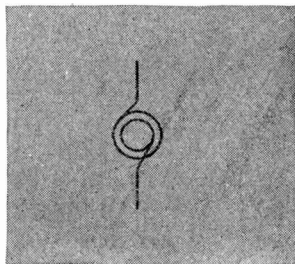
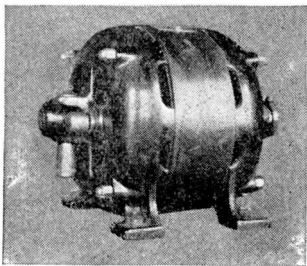

A.C. GENERATOR OR MOTOR—The A.C. generator finds little use in radio work except in spark transmitters but the motor is often used as a source of power for motor-generator sets when the local electric supply is alternating current. The A.C. generator or motor frequently has three terminals in the larger sizes as three-phase distribution of power is more satisfactory than single phase. The single phase motor is not

inherently a self-starting device, and must have some sort of starting mechanism incorporated within it; on the other hand the three-phase motor *is* self-starting and is much more rugged. The single-phase motor has two terminals brought out to binding posts. Alternating and direct current motors are never employed in receiving sets. It is only in the diagrams of transmitters that we find the symbols used.

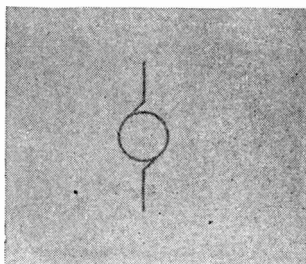
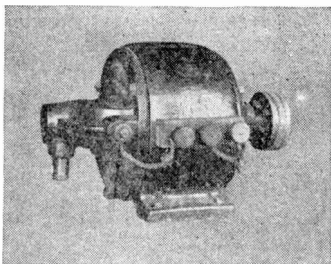

D.C. GENERATOR OR MOTOR—The D.C. generator is used in radio work to produce the high-voltage plate supply for the better class of transmitters. It also finds a use in stepping the voltage down for battery charging. The D.C. motor is used for power in the motor-generator set, for driving spark gaps, etc., when the local electric supply is direct current. There will usually be two connections for the generator and also two connections for the motor unless the latter is so powerful that it requires some sort of starting mechanism. The

local electric company will have its own regulations about the sizes of motors requiring starters. The motor itself will have two external connections or terminals.

Since every direct current motor functions as a generator if it is turned mechanically by a gas engine or another electric motor there is no distinguishing mark between direct current motors and direct current generators in diagrams. Sometimes when a generator is shown it is so marked but when the motor is pictured no indication is made.

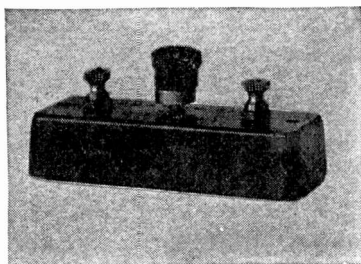

GRID CONDENSER—For the purpose of detection we must operate the tube at the knee of the “characteristic curve” by the use of a “C” battery or resort to the grid condenser, which isolates the grid and allows the negative charge on it to build up through several cycles instead of changing to positive at each half cycle as it would normally do.

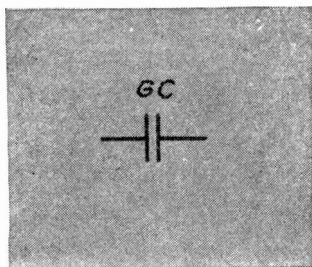

The grid-condenser method of detection is used in most receiving sets and the common value of the grid condenser is .00025 mfd. One of the small mica fixed condensers is just as good as something more expensive. However, do not try to economize by using a paper condenser at this point. The grid condenser has two leads.

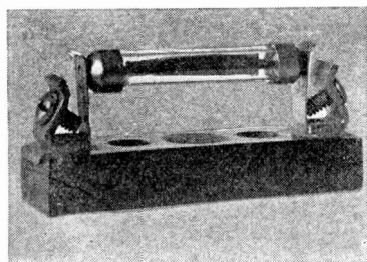

GRID LEAK—With the grid-condenser method of detection some means must be provided to allow the negative charge on the grid of the tube to *leak off gradually*; otherwise the charge would build up until the tube was paralyzed. For this purpose a high-resistance path called the grid leak is connected between the grid and the filament; the value of the grid leak runs into the millions of ohms, 2 megohms (2,000,000 ohms) being a common value. While there may be some advantage in a variable grid leak, it is so difficult to find a good one, that the tubular type is per-

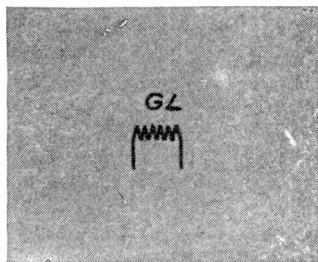

haps the safest one to use. There are two connections to the grid leak, one to each end of the resistance unit.

While there are many different types of variable grid leaks on the market, as yet technicians have not decided to indicate this variable feature in a diagrammatic way. This is probably because the grid leak once adjusted for any particular tube does not need to be touched again for some time. Adjustments are so few and far between that it is practical to show all grid leaks as being fixed in both electrical and mechanical form.

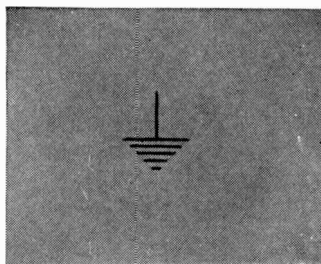
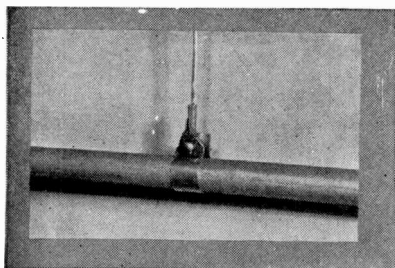

GROUND—Fortunately a good ground is available to most of us; the solution of this important problem is the ordinary water-piping system of the house. The ground wire may be soldered to a brass fitting, or one of the faucets, or it may be connected directly to the pipe itself by means of a ground clamp. The pipe should be brightened up with a file before connecting the ground clamp. If a

ready-made ground is not at hand, a galvanized pipe driven in moist earth or a buried copper sheet is the best substitute. There is a single lead to the ground connection and the size of this should not be smaller than No. 14 copper wire. A low-resistance wire must be used. Ground wires should also be heavily insulated when used outside the house.

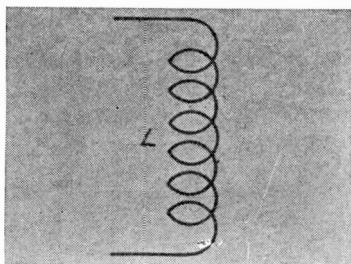
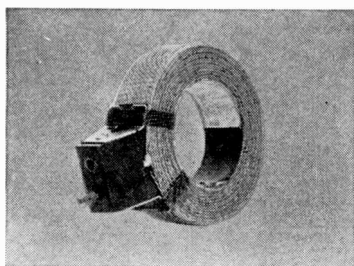

FIXED INDUCTANCE—The fixed inductance or coil is a continuous winding with two connections, one at the beginning and one at the end. It may take the form of the single-layer coil, bank-wound coil, spiderweb coil, honeycomb coil, etc. The purpose of the various forms of winding is to decrease the distributed capacity of the coil; such inherent capacity acts much the same as a fixed condenser across the coil and this gives the system a natural wavelength, which is an undesirable condition since we usually wish to control the wavelength by means of a variable con-

denser connected across the coil. The honeycomb coil is especially useful for receiving the long wavelengths, while the other forms of winding are more widely employed on the short and medium wavelengths.

Some radio technicians prefer to show inductances as they are wound upon tubes, that is, showing the tube with characteristic lines over it to represent the wire. This is a laborious process in diagram making and it does not tell the layman any more than the simple loops shown in this particular diagram. The above is standard practice.

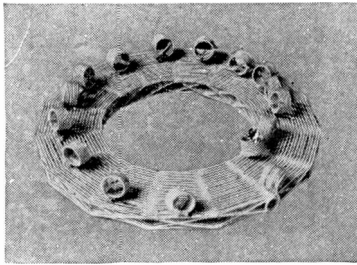

VARIABLE INDUCTANCE—The variable inductance is merely a coil with provisions for using a part of the whole of it. There are two fundamental connections; one usually goes to the end of the coil and the other to a slider, clip, or inductance switch. If an inductance switch is used, taps are taken off the coil five to ten turns apart and connected to switch points. A switch arm makes contact with any one of these points,

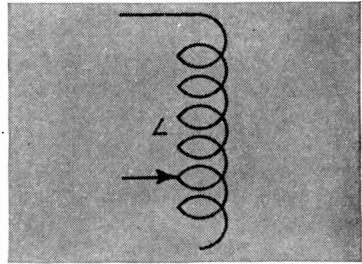

thus cutting in more or less of the coil. Sometimes two switches are provided at opposite ends of the coil, one for *tens of turns* and one for *single turns*. Then the two fundamental connections are to the two switch arms. The old two-slide tuning coil was a little different, in that it had one fixed connection at the end, and *also* two sliders, one for the primary circuit and one for varying the inductance included in the secondary circuit.

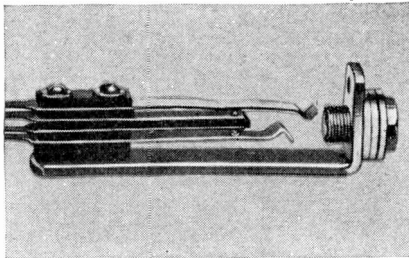

TELEPHONE JACK—The telephone jack gives us a means of using either the detector, or one or more stages of amplification at will. The ordinary jack for all but the last stage of amplification has four terminals; the two outside terminals are connected in series in the plate circuit of the preceding tube, that is, one to the "B" battery positive and one to the plate of the tube; the two inside terminals are connected to the primary of the following amplifying transformer. When the plug is not inserted in the jack, the plate wire should

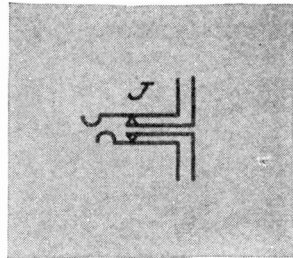

make contact with the terminal marked P on the transformer and the "B" battery wire should make contact with the terminal B on the transformer, through the fingers of the jack. The last jack has two terminals and these are connected in series in the plate circuit of the preceding tube. The jack furnishes a convenient method for "plugging in" the headphones.

The reader will in his radio work find many other types of telephone jacks depicted in diagrams but the various springs and contacts will always be illustrated in the manner given.

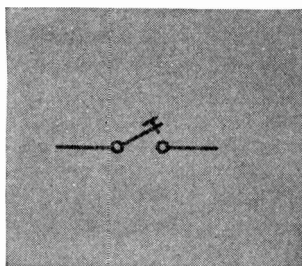
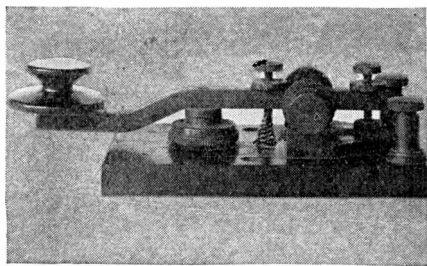

KEY—The key is used for breaking up the high-frequency current into dots and dashes for radio telegraphy. In the old-time spark transmitters the keys were very ponderous and unwieldy due to the fact that they had to handle (directly) very large currents, being inserted in series with the primary cir-

cuit of the power transformer. However, with continuous-wave apparatus there are places where even a small key may be inserted so that it will control the energy from several large vacuum tubes. There are always two connections to the key, these being shown by the two wires running to it in the diagram.

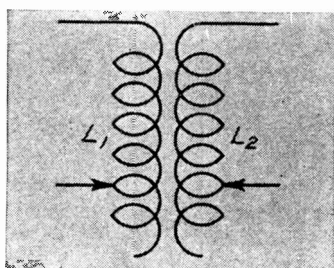
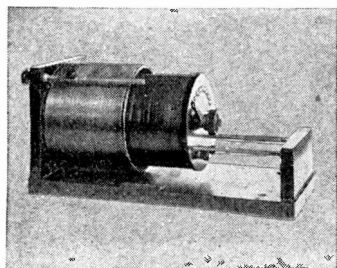

LOOSE COUPLER—The loose coupler is an older and less convenient device than the vario-coupler, for coupling the primary and secondary circuits. The primary coil is stationary and is usually provided with a slider for varying the inductance by single turns. The secondary coil slides in and out of the primary to vary the coupling, and is provided with approximately half a dozen switch points to change its inductance value. There are two primary connections, one to the slider and one to one end of the coil. Also there are two secondary connections, one to the switch arm and one to one end of the

coil. The construction of the loose coupler makes it inconvenient for panel mounting and it has gradually fallen into disuse.

Loose couplers take many other physical forms but electrically they all function the same and all types are indicated in diagrams in the conventional manner illustrated. It must be remembered that all of the various instruments shown in this series of pictures oftentimes take different mechanical forms. Regardless of this form the diagram used to represent the instrument is usually standardized in all radio publications.



MICROPHONE—The ordinary carbon-grain microphone consists of two metal plates with a number of carbon grains between them. These two plates form the two connections to the microphone, and they are insulated from each other, of course, except through the path furnished by the carbon grains. To one of the plates the diaphragm of the microphone is attached and the varying pres-

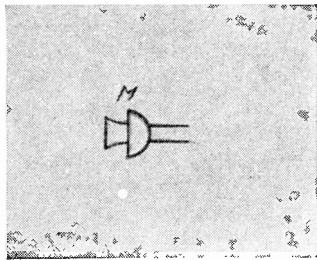

sure of the diaphragm (caused by the sound waves) is transferred to the carbon grains. This changes the resistance of the microphone and consequently the amount of current which is flowing through it, so that the amount of current at any instant is representative of the sound wave striking the diaphragm at that time. The symbol shown is practically standard.

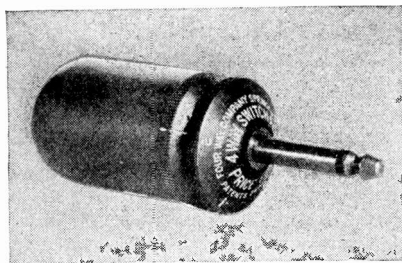

TELEPHONE PLUG—In connection with a jack, the telephone plug may be used to insert any given pair of telephones or any loudspeaker in the set instantly. There are two connections to the plug, one to the tip and one to the sleeve, and the two terminals of the telephones or the loudspeaker are merely joined to these. When a two-circuit jack is in the normal position, without the plug inserted, each outside spring makes contact with the corresponding inside spring and the circuit is completed through the following transform-

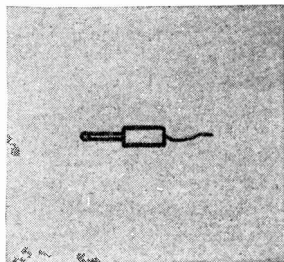

er. When the plug is inserted, contact between the outside and inside springs is broken, and the tip and sleeve of the plug make contact with the outside springs of the jack, completing the circuit through the telephones. This places the telephones in the plate circuit of the preceding tube and disconnects the succeeding stages from the telephones and other stages of amplification.

Sometimes telephone plugs are made to accommodate a large number of 'phone tips. There is no special way of representing such a plug in a diagram.

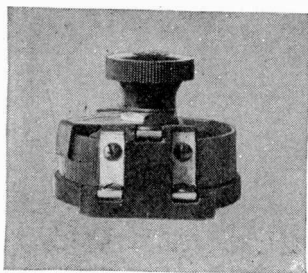

POTENTIOMETER—The theory of the potentiometer is based on the fact that the potential or voltage of a wire varies uniformly along its length from negative to positive, and that by tapping off at various points along the wire or resistance we can get any desired potential within the range of the battery. The two outside terminals of the potentiometer (ends of the winding) are connected across the "A" battery and the desired potential is obtained by moving

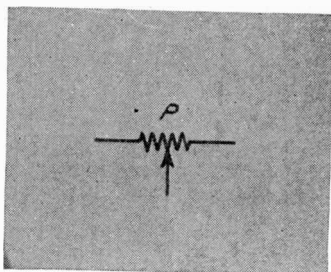

the third connection (the pointer) to different points from negative to positive. There are two principal uses for the potentiometer, the first being to vary the plate potential of a soft detector tube by connecting the negative "B" battery lead to the pointer of the potentiometer, and the second to vary the grid potential of radio-frequency amplifying tubes by connecting the grid return to the pointer. This allows a six-volt variation in either position.

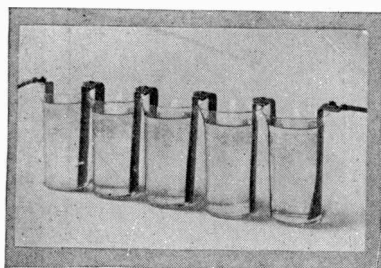

CHEMICAL RECTIFIER—The chemical rectifier cell usually consists of one lead and one aluminum electrode immersed in a saturated borax solution. For battery charging, two to four cells having large electrodes may be connected in parallel in order to carry the heavy current. On the other hand for rectifying the plate current for vacuum tubes, a number of cells that have smaller electrodes are connected in series, as the voltage is high and the current is low. The chemical rectifier is not very eco-

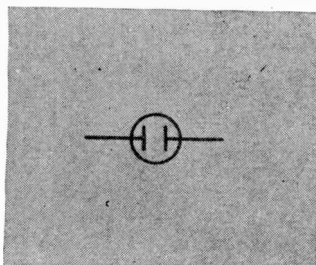

nomical for battery charging as most often used, due to the fact that the current is most always cut down by a rheostat and a large part of the energy is lost *in* the rheostat in the form of heat. There are two connections to the rectifier, one to the positive aluminum electrode and one to the negative lead electrode.

Chemical rectifiers of this type are often used to charge small B batteries but the reader will find that they require much attention.

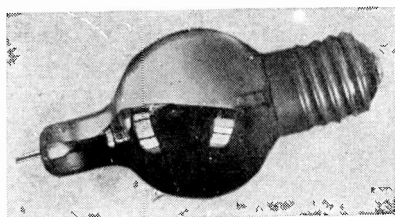

RECTIFIER TUBE—The rectifier tube is a two-element tube and will always have three terminals. Two of these are for lighting the filament and the third is the plate terminal of the tube. The filament-lighting circuit is merely an auxiliary circuit; the connections of the rectifying circuit proper are to one of the filament terminals and the plate terminal of the rectifier tube. The source of current to be rectified is connected in series with the rectifier tube;

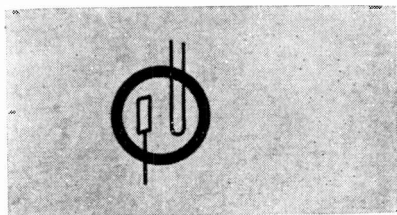

since the current can only pass from the plate to the hot filament, the filament is always the positive pole and the plate the negative pole of the rectifier. Rectifiers range from the Tungar type (a low-voltage, high-current tube for battery charging) to the high-voltage rectifiers handling several thousand volts for the plate supply of large vacuum tubes that are used in transoceanic high-power telegraph transmitters. They will rectify high voltages.

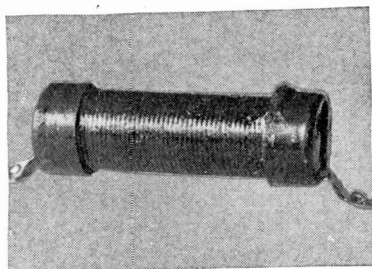

FIXED RESISTANCE—The fixed resistance can be used to couple amplifier circuits together, being placed in the plate circuit of one tube and the voltage drop across it used to operate the succeeding tube. Resistance coupling is not economical because a large quantity of the plate-circuit energy is lost in the resistance in the form of heat. On the other hand it has the advantage of amplifying nearly all frequencies used in radio *uniformly*, and thus does not cause distorted signals. The fixed resistance has two terminals, one at each end of

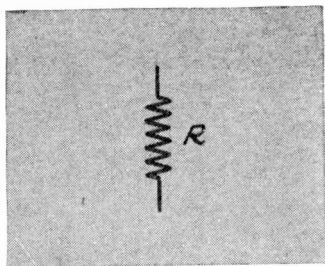

the resistance element. The element may take the form of a continuous winding of wire or may be made up of some high-resistance material such as carbon or graphite. It should generally be non-inductive; in some circuits this is imperative but in others it doesn't matter.

By non-inductive resistance we mean resistance in which the wire is wound back on itself so that the magnetism produced will be working in opposition. This is really the principle used in the variometer. Non-inductive resistances are used in alternating current.

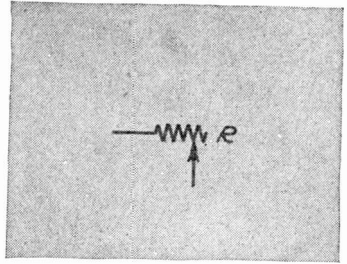
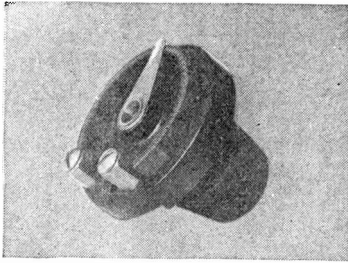

RHEOSTAT—As the voltage of a battery gradually decreases with use, all tubes are designed to operate at a voltage somewhat less than that of the battery they are to be used with. The rheostat should, therefore, have sufficient resistance to cut the battery voltage down to the proper tube rating. Also the current-carrying capacity of the rheostat should be large enough to prevent undue heating; for instance, an

ordinary commercial 50-ohm rheostat would burn out immediately if used with a tube drawing one ampere or more. However, do not worry if the rheostat heats up to a certain extent, as that is the way the energy lost in it is dissipated. The rheostat has two connections, one to the pointer and one to one end of the winding. Use a rheostat with your tubes of the resistance specified by the manufacturer.

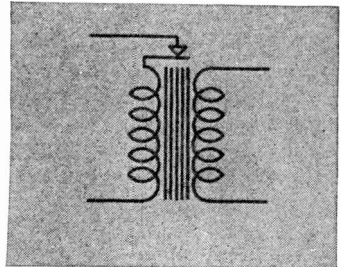
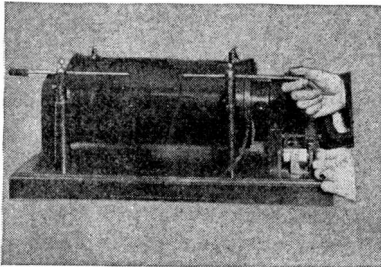

SPARK COIL—The spark coil is an instrument used to obtain a voltage high enough to jump a specified air gap, the discharge across the gap being used to send out waves at a radio frequency. The primary consists of a small number of turns and the secondary of many turns of fine wire, both being wound about a laminated iron core. A method of interrupting the primary circuit at regular intervals is provided, and this interruption gives us an alternating secondary current of very high voltage. This current is used to charge a con-

denser until the voltage is sufficient to break down the air of the spark gap and discharge across the gap. Generally there are four connections to the spark coil, two to the primary and two to the secondary. The interrupter is usually made integral with the coil and placed in the primary circuit. However, the interrupter may be separate if connected properly in the circuit.

The spark coil is practically obsolete since it has always been a very inefficient producer of electric oscillations.

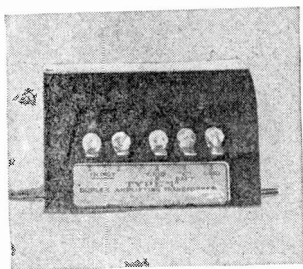

PUSH-PULL TRANSFORMER—For each stage of push-pull amplification we must have a special audio-frequency, input transformer with a tap at the center point of the secondary winding, and also a special audio-frequency output transformer with a tap at the center point of the primary winding. Therefore the push-pull transformers are usually sold in pairs. Push-pull amplification varies the plate current of both tubes up and

down from the normal, thus giving an increase in signal strength. In a stationary condition, that is without any signal being impressed on the tube, the direct current in one half of the output transformer opposes that in the other half and there is no flux in the core. With this condition we can use much higher voltages and get louder signals without distortion. This system is giving way to resistance amplification.

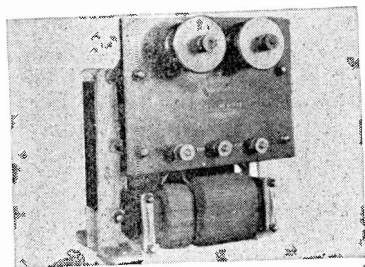
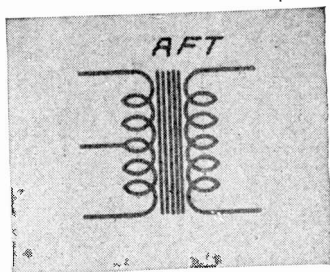

TRANSFORMERS—The transformer has two separate coils, both wound about the same closed iron core. The primary is the side connected to the source of power and has two terminals. The secondary is the side from which power is to be drawn at some voltage either higher or lower than that impressed on the primary. It has two terminals or may be tapped at several points to obtain a selection of voltages. Therefore, it can be seen that the transformer is fundamentally a device for changing the voltage of the supply. When the voltage is cut down by utilizing the drop

across a resistance much energy is lost in heat; on the contrary the efficiency of the transformer runs as high as 98 per cent in the larger sizes. The transformer cannot be used on direct current.

Transformers are used for many different purposes. Some step up the voltage and some step it down. Some increase the current while others diminish it. In any event transformers are always depicted substantially as shown. The primary can usually be recognized by heavy lines when the current is stepped up and the reverse when current is stepped down.

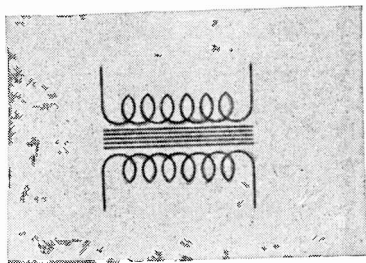

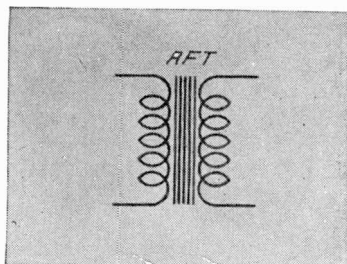
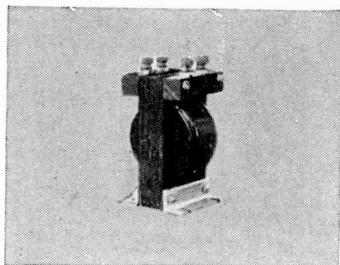

AUDIO-FREQUENCY TRANSFORMER—The audio-frequency transformer is merely a step-up transformer designed for voice-frequency currents. The primary is inserted in the plate circuit of one tube and the secondary in the grid circuit of the succeeding tube. Due to the step-up ratio, any change in the primary current and voltage produces a much larger swing in the grid voltage of the succeeding tube, and this causes a correspondingly greater change in the plate current of the same tube. The

simple audio-frequency transformer has four terminals, two for the primary and two for the secondary. The general practice is to make the primary terminals P and B for the plate and "B" battery connections and the secondary terminals G and F for the grid and filament connections. A transformer should have such characteristics that it will amplify tones of all frequencies, within the audible range of the ear, with equal intensity. Transformers that do otherwise produce distortion.

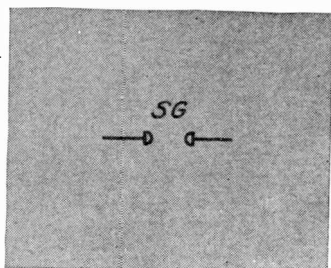
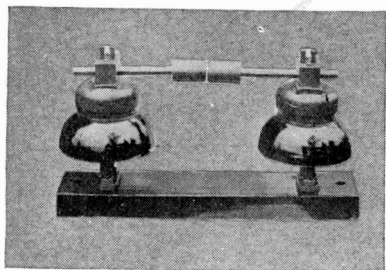

SPARK GAP—For any form of spark transmitter, some kind of spark gap must be provided. This is the point where the energy we put in the transmitter is changed from an audio frequency to radio frequency. The gap may be a plain two-electrode gap, a quenched gap, or a rotary gap. The various forms of spark gaps are used to give a better tone or note to the transmitter. For example, the rotary gap may be supplied with sufficient elec-

trodes to produce 500 sparks a second, thus giving a note which is more pleasing and easier to read than the lower frequencies of the plain gap. The spark gap will always have two fundamental connections even if there are a large number of electrodes.

The reader will not find many spark gaps in radio diagrams at present because of the gradual passing of the spark method of producing electrical oscillations.

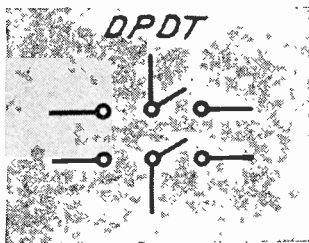
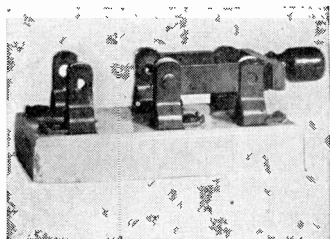

SWITCHES—The most common switches used in radio are the following: a single-pole, single-throw (SPST) with two connections, single-pole, double-throw (SPDT) with three connections, double-pole, single-throw (DPST) with four connections and double-pole, double-throw (DPDT) with six connections. These switches are made up in standard form and also in a special anti-capacity type with the area of the switch parts re-

duced to a minimum. Of course there are also three and four-pole switches but their use is less common. Whatever the number of connections, it is merely necessary to count them on the diagram and make sure that the switch itself has the same number of connections and the same number of switch arms. Such switches may be used for antenna switches, battery chargers, and many other functions.

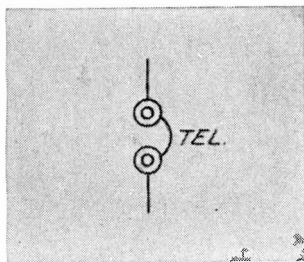
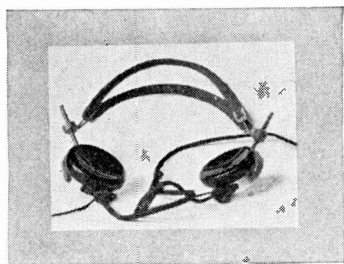

TELEPHONES—A good pair of telephones is essential for reception; probably the best way of selecting them is to buy from a reliable manufacturer. There are two common types; in one the magnets act directly on the iron diaphragm and in the other they act on an iron armature which is mechanically connected to a mica or composition diaphragm. Either of these types is satisfactory if well made. The two telephone receivers are always connected in series, that is, one terminal of one 'phone is connected to one terminal of the other

phone and the remaining two terminals are brought out for connections to the receiving set. For any good receiver, the telephone headpieces act as the mouthpiece and if they are of good design and quality the results will be good. If the telephones are inferior, however, reliable results cannot be expected. A good receiver deserves a good headset.

Fortunately the telephone is universally illustrated as we have it shown in the diagram. The telephone is the one instrument that has a practically uniform appearance.

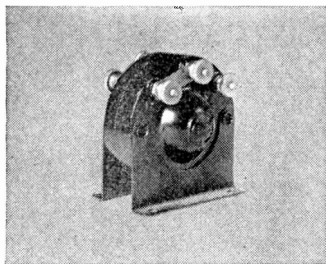

RADIO-FREQUENCY TRANSFORMER—The radio-frequency transformer operates on the same principle as the audio-frequency transformer, except that it is designed for high-frequency currents. It is often made with an air core, or at least with an open iron core. The radio-frequency transformer has four terminals, two for the primary and two for the secondary. The common practice is to mark the primary terminals P and B

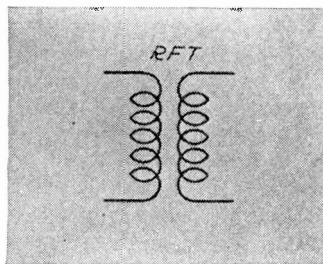

for the plate and "B"-battery connections, and the secondary terminals G and F for the grid and filament connections. Some transformers have a metal link for short-circuiting part of the winding, thus giving a wider wavelength range. Two or three steps of radio-frequency amplification are practically a necessity for loop operation. This type of transformer is not as efficient as the tuned type.

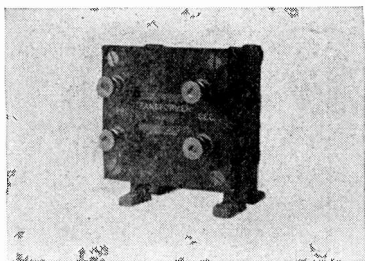

MODULATION TRANSFORMER—In order to couple together the microphone circuit and the grid circuit of a vacuum tube, a transformer must be used. Examples of this use are the grid-modulation, and Heising-modulation circuits. The modulation transformer is similar in appearance to the amplifying transformer, but usually has a higher step-up ratio. It has four terminals, two for the primary and two for the secondary. The primary winding of the modulation transformer is simply connected in series with the microphone and a suitable battery. The secondary winding is

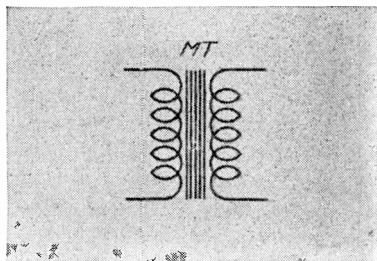

connected to the grid circuit of the oscillator tube in the case of grid modulation or to the grid circuit of the modulator tube in the case of Heising modulation. The transformers should be built to withstand rather high voltages.

Here we have practical proof of the simple way in which all transformers are shown diagrammatically. The primary will always be connected with a source of current because it is this side of the transformer that receives the electrical impulses that are to be transformed to a higher or lower voltage.

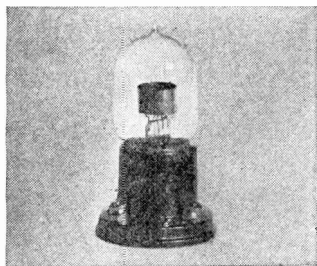

VACUUM TUBE—The three-element vacuum tube has four terminals; two of these are the ends of the filament, the third is the grid, and the fourth is the plate. Since there are no designations for these terminals on the tube itself, it is imperative to purchase a suitable vacuum-tube socket and follow out the circuit from the letters on the same. The two filament terminals will be marked F, the grid G, and the plate P. These same letters have been placed on the diagrammatic vacuum-tube symbol

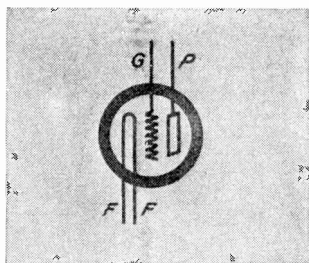

shown, but will ordinarily be left off, as it is a simple matter to learn which element is which. The action of the vacuum tube cannot be treated here except to state that under normal operating conditions the telephone current flows from the plate to the filament, and that small changes in grid voltage will make comparatively large changes in the plate or telephone current. This process amplifies the currents passing through the telephones and produces louder signals.

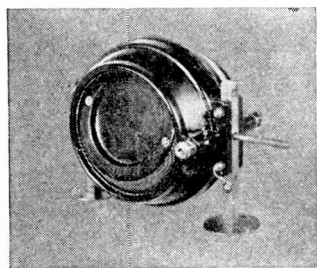

VARIOMETER—The variometer provides a continuously variable inductance (within the range of the instrument); it consists of two coils connected in series and mounted so that one rotates within the other. When the current traverses the two coils in the same direction and when the axes of the two coils are parallel, the inductance of the variometer is maximum; when the current traverses the two coils in opposite directions and when the axes of the two coils are again parallel, the inductance of

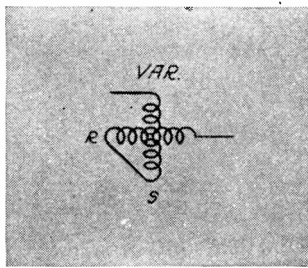

the variometer is minimum and should theoretically approach zero. There are two connections to the variometer, one to the end of each coil; the opposite ends of the two coils are connected together.

Here is another instrument that has not been standardized in diagrams unfortunate as it is. However, the variometer can be recognized by tracing the connection between the two coils used. It will be recalled that the variocoupler has two distinct windings not directly connected.

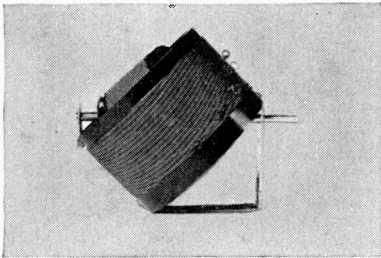

VARIOCOUPLER—The variocoupler is one of the most widely used instruments for coupling and tuning the primary and secondary circuits; it consists of a stationary primary coil, and a secondary coil rotating within the primary coil, so that the coupling between them may be varied. The primary of the variocoupler is provided with taps for changing the wavelength; there are two primary terminals, one to the wavelength

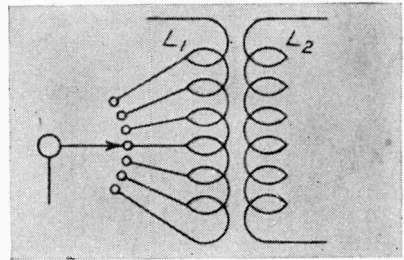

switch and one to the end of the coil. The secondary of the variocoupler has a fixed number of turns and is always tuned by means of a variable condenser connected across the coil or by a variometer in series with it; there are two secondary terminals, one to each end of the coil. These secondary terminals are brought out through the bearings or through "pigtail" connections made to the coils of the instrument.

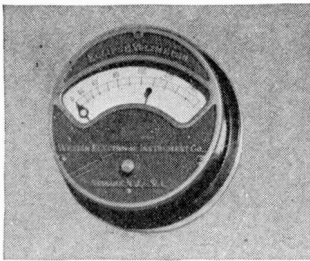

VOLTMETER—The voltmeter is an instrument for measuring the potential difference (voltage) between two points in a circuit, that is, how much higher the voltage is at one point than at the other. For instance, it might be connected across the "A" battery to measure the difference in voltage between the positive and negative terminals. A voltage measurement is the only satisfactory method of testing "B" batteries or of locating a bad unit among them. After the voltage of the 22½-volt unit has fallen below 16 it

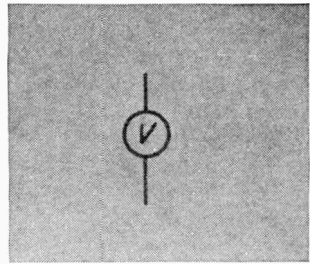

should be discarded. The same proportional drop can be applied to the larger units. The simple voltmeter will have two terminals for connecting to the two points where the voltage difference is to be measured. For "B" battery measurements the voltmeter should be of high resistance.

The voltmeter is really shown like the ammeter save for the fact that there is a "V" written across its face or beneath it in the diagram. Practically all types of meters are shown in this fashion.

From a reading of the foregoing the reader will notice that such instruments as the variable condenser, the variometer, the fixed condenser, the grid leak, the rheostat, tuning coil, choke coil, battery and others have only *two* terminals.

The potentiometer has *three* terminals.

Most types of transformers have four terminals—two for the primary winding and two for the secondary winding. Push and pull transformers, it will be noticed, have five connections.

Tube sockets have four connections, one marked G for the grid, one marked P for the plate, and the other two marked F for the filament connections.

Variocouplers have a number of taps (inductance terminals) for the primary and two connections for the secondary.

Some of the other more complicated accessories have a large number of terminals; among these are motor generators, tapped coils and power transformers.

Consider the specific case of a variable condenser; if you see the symbol for

this instrument in a circuit diagram you will always find two lines (wires) running to it, one from each side. If you were to connect this instrument in that particular circuit you would only have to connect these two wires to the two terminals that you would find on the condenser. This same line of reasoning holds true for instruments with three terminals, four, or more terminals.

In a variocoupler the primary coil is always the larger outside coil and the secondary is the smaller inside coil.

In a transformer (radio-frequency or audio-frequency) the primary terminals are marked P for the plate, and B for the wire going to the "B" batteries. The secondary terminals are marked G, for the grid wire and F for the wire leading to the filament.

The symbol for the vacuum tube, it will be noticed, contains four lead wires. The upper left-hand wire is the grid lead and when connecting up a vacuum-tube circuit this wire should always be connected to the terminal marked G on the

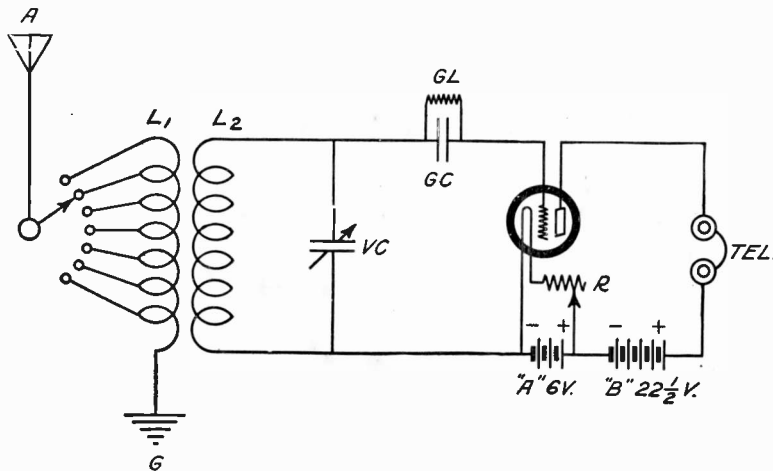

A DRAWING FOR A STRAIGHT AUDION CIRCUIT

Unless you know what these symbols mean, this diagram is unintelligible. This part tells you how to read it.

tube socket. The upper right-hand wire is the plate lead and this should always be connected to the terminal marked P of the tube socket. The other two wire leads (in the diagram) are the filament connections and should be connected respectively to the terminals marked F on the tube socket.

Now let us study the diagram at the bottom of page 95.

This is a standard diagram for a straight audion circuit. We will first pick out the instruments that are used in this circuit. By referring to the upper left-hand portion of the diagram we will find the triangular-shaped symbol for the antenna. Directly below it we find the symbol for the variocoupler. And below this we find the symbol for the ground. Then connected to the secondary of the variocoupler we find the symbol for a variable condenser. And in the center of the diagram we find the symbol for a vacuum tube. Directly below this we find the symbol for a rheostat and an "A" battery. Connected between the grid of the tube and the variable condenser we find the symbols for a fixed condenser and a grid leak. To the right of the diagram at the top we find the symbol for the telephones and below this the symbol for a "B" battery. From this diagram, therefore, we learn that we need the following list of parts in order to make the set:

- 1—variocoupler;
- 1—variable condenser;
- 1—grid condenser;
- 1—grid leak;
- 1—vacuum tube;
- 1—vacuum-tube socket;
- 1—rheostat;
- 1—"A" battery (for lighting the filament);
- 1—pair of telephones;
- 1—"B" battery (for supplying the plate current).

The next thing to do would be to obtain these parts of suitable sizes to

incorporate in the set. The sizes for the various instruments are almost always given in the text of the article of which the diagram is a part. These sizes include the proper capacities for the variable condensers and fixed condensers, the proper resistances for the grid leaks and rheostats, the proper type of tube to use for detector or amplifier and the proper voltages to use for the "A" batteries and "B" batteries.

To start wiring up a set like the one shown in the diagram the beginner should obtain the proper connecting wire, a soldering iron, some solder, soldering flux and a heavy red pencil.

A good layout for this particular set would be to mount the variocoupler at the left-hand end of the panel; place the variable condenser beside it, with the socket mounted alongside the variable condenser, at the right-hand end of the panel. The rheostat should be mounted on the panel directly in front of the vacuum-tube socket. The vacuum-tube socket should be mounted on the base with the plate and grid terminals turned toward the back of the set.

Now we should include on the left-hand end of the panel, two binding posts, one for the antenna and one for the ground. At the right-hand end of the panel should be mounted six binding posts, the top two being for the telephone, the second pair for the "B" battery, and the bottom two for the "A" battery.

After the instruments have been mounted on a panel in a manner which will keep the connecting wires as short as possible, we should commence the actual wiring.

From the diagram we see that there is a wire running from the antenna to the switch arm of the variocoupler. Cut a piece of wire long enough for this pur-

pose and solder one end of it to the back of the antenna binding post of the set. Then run the wire as direct and neatly as possible to the shaft of the switch arm on the panel.

When this is completed *take the red pencil* and cover the line you have just completed (on the diagram) with a red line.

In looking at the diagram hereafter you will know that you have already completed this connection; it will be evident at a glance.

Now you will notice from the diagram that there is a wire running from the ground to the bottom end of the variocoupler. Connect this to the back of the ground binding post and also to the variocoupler end. Then trace over this line on the diagram *with the red pencil*.

There are five taps to be connected to the switch points on the panel, from the primary winding of the variocoupler. Make these connections one by one and each time you complete one trace it over on the diagram *with the red pencil*. The primary circuit is then complete.

The top end of the secondary is then run direct to one terminal of the variable condenser. Make this connection and *use the red pencil*. It will be noticed that there is a joint from this wire leading over from the wire you have just connected which runs to one side of the grid leak and one side of the grid condenser. Make this connection and trace over *with the red pencil*. Now connect a wire from the terminal marked G on the tube socket and run it to the opposite sides of the grid condenser and grid leak to the connection you have just completed. Cover this *with a red pencil line*.

To get back to the variocoupler, we

notice that there is a wire running from its bottom end over to the negative "A" battery. Make this connection on your set and again cover on the diagram *with the red pencil*.

There are two branches from this wire, one to the remaining terminal of the variable condenser, and one to one of the terminals marked F on the tube socket. Make these connections separately, after which *use the red pencil*.

Now there is a connection running from the positive "A" battery over to the negative "B" battery and this requires a wire connecting your A binding post and your B negative on your set. This wire also has a branch running to the pointer on the rheostat. Connect these and *mark off* on the diagram.

The other terminal of the rheostat is connected to the remaining terminal marked F on the tube socket. Do this and *mark off* on the diagram *with the pencil*. There are now two connections left to complete the wiring. One is a wire from the "B" battery positive to the telephones and this requires the connection of the binding post marked B and the nearest telephone binding post. The other wire should be connected between the remaining telephone binding post and the terminal marked P on the tube socket. *Mark off* the two last connections *with the red pencil*.

Now look at the diagram again. Are there any connections left *uncovered by the red pencil*? If not, the set is correctly connected and you have succeeded in reading an electric diagram!

Try this out and you will find that even the most complicated circuits are subservient to your wishes and you will never have any trouble nor make any mistakes. There is nothing to it!

END OF SECTION III

SECTION IV

The Mechanics of Radio

MANY of us who have walked past the radio cabin on a steamer have heard the crashing, sparking sounds that issue from the radio transmitter. Some of us have seen the sets in operation and most of us have perhaps turned away with the thought: "Well, radio certainly is a wonderful thing, and it must have taken some brain to work out the idea, but it's beyond me."

This, however, is not so. Anybody can understand the mechanics of radio if given the right instruction.

We must first become slightly familiar with two electrical instruments—the inductance or coil, and the condenser. We must learn that these two pieces of apparatus are storehouses of energy. The coil we find has the ability to store up electromagnetic energy.

This means that the coil produces an electromagnetic field about itself that is similar to the field set up around a steel permanent magnet. The condenser on the other hand, by having all the electrons drawn off one plate and crowded on the other plate, becomes "charged." This causes one plate to be positive, and the other to be negative. The plate which contains all the electrons is the plate that is charged negatively. These two charges cause the "dielectric" or insulation between the two metal plates to be placed in a stressed or strained condition; in other words, an electrostatic field is set up in the insulation.

We will now connect up these two instruments with a spark gap and show how they, in combination, will cause

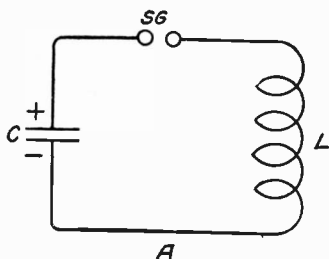

HOW CONDENSERS ARE CONNECTED

Figure A: This shows part of a radio transmitter circuit of the spark type. It contains a coil, a spark gap and a condenser.

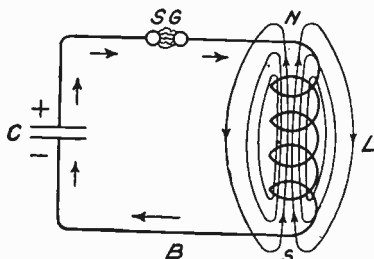

A DISCHARGING CONDENSER

Figure B: The coil becomes energized, the condenser charges and discharges across the spark gap, producing a loud crackling noise.

wave trains of high-frequency currents to be generated and how they also can be varied in size so that the frequency of the oscillations can be controlled at will, thus controlling the wavelength emitted from the transmitting set of which they form a part.

If we connect a wire to one plate of a condenser, which is made for high voltages, and which is diagrammatically shown at C in Figure A, and also connect the other end of this wire to one electrode of a spark gap SG, and connect the other plate of the condenser C to another wire which is attached to one end of a coil L, and further connect the other end of the coil to another wire which is in turn connected to the remaining electrode of the spark gap SG, we have connected up a regular oscillating circuit such as used by spark radio telegraph stations for generating the oscillations necessary for the production of the Hertzian or radio waves.

Now we will continue and make the circuit oscillate for our inspection in a very slow manner so that we may comprehend the workings clearly. Of course this will be unnatural, but it will serve to show us the functioning of the circuit in much the same way as motion pictures

are slowed down so that the observer may see each individual action.

We will first place a charge on the condenser C; a positive charge on the upper plate and a negative charge on the lower plate, Figure A. As we may have already learned, a condenser when charged, contains a store of energy which is in the form of electrostatic electricity, or stationary electricity.

When a condenser is charged in this manner it tries to discharge and thus neutralize the charges on the plates. This discharge cannot take place unless the condenser has some external, electrically conducting path through which the electric current may run. This conducting path may be a wire attached from the positive plate to the negative plate. Inspection of Figure A shows that we have these conditions fulfilled except for one point—the air gap between the electrodes of the spark gap. Therefore, if we wish the electric charges on the condenser to discharge through the circuit we must place a high enough voltage on the plates so that the resistance of the air between the electrodes will be overcome and a spark allowed to jump across the gap. Then we have a complete conducting circuit from the

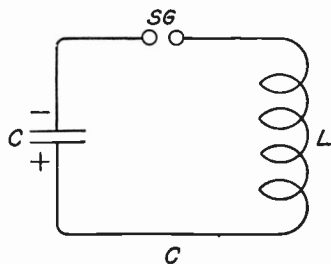

THE CHARGE REVERSED

Figure C: This diagram is the same as Fig. A save that the charge on the condenser plates are reversed.

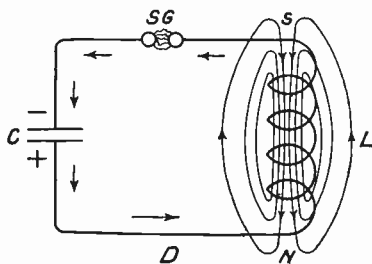

ANOTHER DISCHARGING CONDENSER

Figure D: This diagram is also the same as Fig. B save that the condenser has the charges upon its plates reversed.

upper plate to the lower plate of the condenser and a current of electricity is caused to flow around through the circuit as indicated by the arrows and the spark shown jumping the gap in Figure B. This current is instantaneous and is shown as a positive impulse making up one half a cycle in Figure E.

We have learned that when a current is allowed to flow through a coil, a magnetic field is set up around the coil, which causes it to become an electromagnet with one end of a north polarity and the other end south, as shown at L in Figure B.

When the current has flowed through the circuit, the charges that were on the condenser C have become neutralized and therefore the current ceases. When this happens the magnetic field that has been set up around the coil L collapses; that is, the magnetic rings fall back on the surfaces of the wires and a peculiar effect is noticed; a voltage is induced in the coil which is positive in the direction that the current was running.

This means that the condenser C receives a reverse charge immediately

after the current from the initial charge has ceased to flow.

This second charge places a positive potential on the bottom plate of the condenser and a negative charge on the top plate (see Figure C). This charge is not as strong as the first charge, however, because there is some energy lost due to the fact that the current must overcome the resistance of the wire and that of the air through which the spark must be forced.

When this second charge on the condenser reaches a high enough value to again break down the spark gap, a spark occurs across the gap and a second current flows through the circuit, in the opposite direction to the first current (see Figure D). This current forms a negative impulse which is shown in the diagram, Figure E, as the second impulse of the first cycle. Again the coil sets up a magnetic field around itself, only this time the top of the coil is of a south polarity and the bottom of the coil is north.

When this field collapses at the cessation of the second current the coil in-

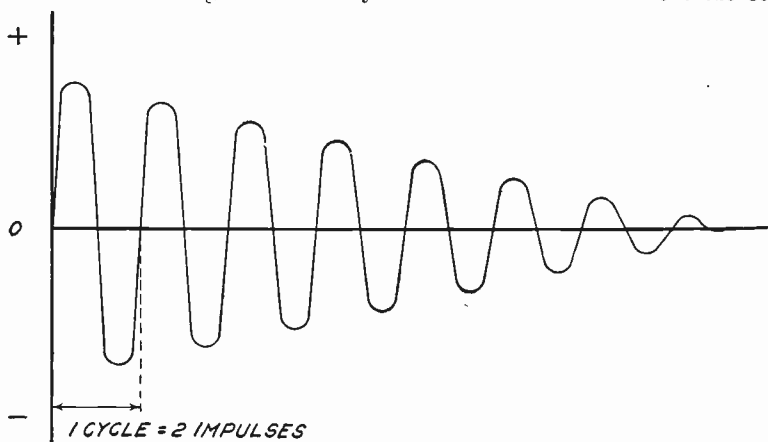

DRAWING OF AN OSCILLATING DAMPED CURRENT

Figure E: How the current produced by the discharge of a condenser gradually falls to zero value. The time required for this action to take place is a very small fraction of a second.

duces the third charge on the condenser which is in the same direction as the original charge.

The same cycle of events then takes place and the current oscillates back and forth through the circuit one way and then the other, but the successive oscillations become weaker and weaker until they die out (see Figure E).

Remember, however, that in our study of these oscillations we have considered them as slow oscillations; in reality they take place in the twinkling of an eye—much faster in fact. One of these series of current wave trains, as they are called, would look to the human eye, like one single crackling spark across the gap. The modern radio transmitter uses frequencies up to 2,500,000 cycles a second, which means 5,000,000 reversing impulses a second, jumping the gap. Little wonder that they look like one single spark!

We now have a general idea of how this simple little circuit, composed of these simple instruments, can perform this miracle of electrical speed and motion without any mechanical moving parts. Now we shall see how we can control the frequency of these generated impulses, by varying either the size of the coil or the size of the condenser.

We may liken the condenser to a pitcher of water. We know that if we have a small pitcher, a certain sized stream of water will require a certain length of time to fill the pitcher. If we use a larger size of pitcher, and hold it under the same stream of water, it will take a greater length of time to fill it. It will also take a longer time to empty the larger pitcher than it will take to empty the small one.

We can also liken the coil to a coiled tube that we can pour the pitcher of water into. A certain length of time will be needed for the water to wind around

through the convolutions of the coiled tube and finally find its way out of the bottom. If we make the tube twice as long, it will take twice as long for the water to run through.

Now apply this idea to the electrical circuit. If we use a larger condenser C, it will take longer for it to charge and discharge, making the currents that oscillate through the circuit to last longer. If they last longer, there cannot be as many each second. Therefore if we increase the capacity of the condenser we get fewer impulses a second, thus decreasing the frequency of the oscillations and increasing the wavelength that is emitted from the antenna to which this circuit is coupled.

Or we may get the same result by increasing the number of turns of wire in the coil, and the current will take longer to run through it, so to speak; again we have less impulses a second or a higher wavelength. Increasing either the capacity of the condenser or the inductance of the coil, increases the wavelength. This latter method is generally used for transmitting stations, as it does not vary the power of the set to such a great extent while changing the wavelength, as varying the size of the condenser varies the power greatly that the circuit uses. A given size of condenser will hold a given charge, and if it is varied in size the charge varies in size also.

The coils are generally made with a large number of turns of heavy wire on them and a sliding contact slides over the surface of the wire and picks out the desired number of turns to be left in the circuit to obtain a frequency that corresponds to the desired wavelength.

In this way radio transmitting stations are tuned to the wavelength that they are required to send out on by governmental regulation.

So we find that the whole scheme is, after all, simple. The only feature that made it seem mysterious was the fact that we had no way of telling just what took place when the sparks "jumped the gap," until we analyzed the whole process.

In a future part we will show how these impulses are transferred to the transmitting antenna; then we will see that the coil plays a double role in the radio circuit.

A radio wave is a vibration of the ether, that supposed substance that fills space.

There are many different kinds of vibrations that travel through the ether; that is to say, certain vibrations produce entirely different results than other vibrations.

Suppose we consider (Fig. F), for example, a flexible reed, fastened to a stationary base, as shown in the illustration. If we cause the reed to vibrate, it will first take the position "A," and then swing back and past its original position to a third position "B," and then back to its original position again. Then the same series of movements will be gone through again. This complete set of movements is called a cycle. A cycle then, is composed of two impulses, one in one direction and another in a reverse direction.

Now if we cause the reed to vibrate at a speed of 16 cycles a second, the reed will cause a sound wave to be propagated in the immediate space surrounding it. This wave will make itself manifest to our senses in the form of a low humming sound. Close by the reed the sound will be fairly loud, but at a distance of fifty feet it may be inaudible.

If we increase the frequency (or speed of vibration), to 500 cycles a second, the

low hum will increase in pitch until it will be a shrill whistle, like the high notes of an organ.

If we continuously increase the frequency of the oscillations, when we have the reed oscillating at a frequency of 25,000 cycles a second, the sound will have gotten so high that the human ear cannot hear it. In other words, the waves that are generated around the reed have gone out of the range of frequency that we call sound waves.

As the frequency is increased it will be soon noticed that the reed begins to get warm, until, finally, by placing the hand near it we "feel" the heat wave. This heat wave is of exactly the same nature as the sound wave except that it has a different frequency and produces different results. In one case we hear the sound, with a sound recording organ called the ear, and in the other case we feel the presence of heat by our sense of touch.

As the frequency of the little reed is increased beyond this point, the heat developed finally increases until the reed begins to glow a dull red color. Instantly the wave has become a light wave and it is visible to our eyes, but the heat is still felt. This shows that the ranges of heat and light overlap in the frequency scale.

Any further increase of frequency would mean destruction to the reed through overheating, but if we could imagine its frequency as increasing without burning up, the waves sent out would pass through the ranges of color and the X-ray.

To sum up the foregoing, different ranges of frequency, say 16 to 25,000 cycles, produce waves that we call sound, and another range produces heat, light and color. Another range produces X-rays, and a similar range produces waves which we call Hertzian

waves, named after Hertz, the man who discovered their existence.

And these Hertzian waves are our radio waves. The frequency of the electricity that is used to generate them lies

ment would be much less violent because the waves would be weaker after traveling this distance.

Or take another illustration: We know that a fire built in the woods is hot on all

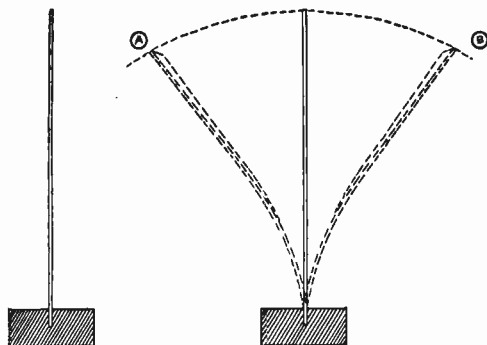

REED ANALOGY

Figure F: A vibrating reed produces the most simple form of sound wave.

within the ranges of 10,000 to 3,000,000 cycles a second.

We now know what a sound wave is. Did we ever notice that the seats in a theatre are invariably arranged in circles? This is done to take advantage of the fact that all waves, such as sound waves, light, heat, and radio waves travel from a point outward in ever increasing circles.

You will get some idea of how sound waves travel by observing what happens when a stone is thrown into a pool of still water. A circular wave is at once formed around the spot where the stone hits the water. This circular ripple begins to travel outwards with its diameter ever getting larger until it dies out.

If we place a cork on the surface of the water near the spot where the stone had struck, it will bob up and down violently as the wave passes by. If the cork were to be placed on the water at a distance from the same spot, the vertical move-

ment would be much less violent because the waves would be weaker after traveling this distance. If we move closer to the fire the heat increases because the heat waves are stronger there; if we move away, the heat decreases. This also is because the waves weaken as they travel.

The same general conditions hold true for radio waves. The transmitting station may be likened to the stone thrown into the water, and the receiving station may be likened to the corks on the surface of the water.

How radio waves are sent out is illustrated in Fig. G, which shows how they leave the antenna.

The antenna is shown, for simplicity, as a single wire vertical antenna with a spark gap as a generator of oscillations in series with the ground. For every given frequency of current jumping the gap, a wave of a certain definite length is radiated from the antenna. The

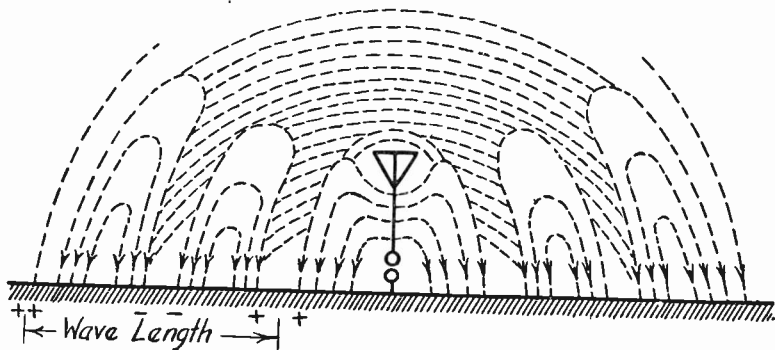

HOW WAVES LEAVE AERIALS

Figure G: Radio waves spread out from a transmitting antenna in much the same way as sound waves spread out from a vibrating reed. The dotted lines indicate the circular radio waves.

length of the wave is the distance between the start and finish of one complete wave, measured along the ground. All radio waves travel with the terrific speed of light, 300,000,000 metres a second. When we know this, the wavelength of a wave radiated from an antenna can easily be calculated if we also know the frequency of the oscillations in the antenna circuit.

A table of wavelengths used for radio communication is given below as a matter of interest, showing the frequency of the currents which cause them to be emitted from an antenna:

Wave length in meters	Frequency in cycles a second	Type of station which uses each wavelength
200	1,500,000	Amateur stations
300	1,000,000	Ship stations
360	834,000	Radio telephone broadcasting stations
450	667,000	Ship stations
600	500,000	Commercial ship and shore stations
1,000	300,000	U. S. Navy
1,400	214,300	Commercial traffic
2,600	115,400	Time signals
5,000	60,000	High powered commercial stations
10,000	30,000	High powered commercial stations
15,000	20,000	High powered commercial stations

20,000	15,000	High powered commercial stations
30,000	10,000	High powered commercial stations

Now let us consider how radio waves are received.

It will be noticed from the above table that as the frequency of the current in the antenna decreases, the length of the emitted wave increases.

We receive a radio wave when we erect an antenna with its insulated wires high in the air, and these wires get in the way of the advancing circular waves. When a series of waves strike the antenna they do not cause it to bob up and down like a cork, but they do produce a tangible result nevertheless. This result takes the shape of a feeble current induced in the receiving antenna which is an exact replica of the current in the transmitting antenna, but reproduced on a much smaller scale. It has the same frequency and is like it in every respect except in strength.

Thus we can readily see that it is not the electric current itself that travels through the ether, but that the electric current does start a disturbance in the ether in the form of a Hertzian wave which travels outwards in all directions

in circles. And when these waves strike another antenna which is tuned to that particular wavelength, they will induce in that antenna a current similar to the transmitting current, only of decreased intensity.

What is a kilocycle? Why are radio waves now being measured in this new unit instead of the familiar wavelengths? What is frequency?

Of these questions let us take first what frequency is and what is its relation to wavelength.

Any wave whatsoever, a radio wave in the ether, a sound wave in the air, a water ripple on the surface of a pond, consists of a succession of pulses moving along one after another. Most waves have a succession of *regular* crests and troughs like ocean waves or like the electric wave, a picture of which is shown in Fig. H.

The part of the wave between one crest and the next following crest is called one complete wave. Its length

—that is the distance between successive wave crests—is one wavelength. This is the familiar radio unit.

The *frequency* is merely the number of such complete waves that pass in one second, or what is the same thing, the number of wavelengths in the distance the wave moves in one second.

Consider the arrival of a moving wave at some fixed point; for example, the arrival of a sound wave at your ear.

The wave appears to your ear as a succession of regularly timed pulses, of the speed of radio waves. The speed of sound in water is about 1,500 meters a second. The fastest known speed for sound is in steel; it is about 5,300 meters a second.

Not only radio waves but all kinds of ether waves are designated most conveniently by their frequencies. The table on page 106 gives in form convenient for reference all the ether waves now known with their frequencies and the corresponding wavelengths in vacu-

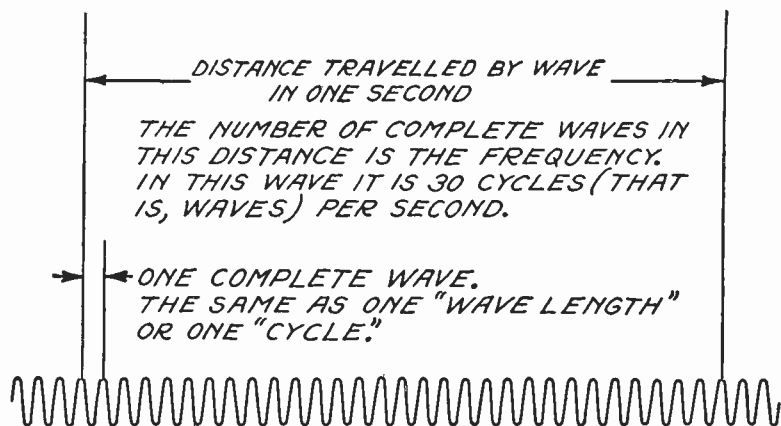

WAVE LENGTH VS. FREQUENCY

Figure H: This diagram shows clearly the relation between wave length and frequency for the specific wave pictured at the bottom—in this instance the wave produced by the note of a flute.

TABLE OF ALL THE ETHER WAVES NOW KNOWN

		<u>FREQUENCY</u>	<u>WAVE LENGTH</u>
AUDIO FREQUENCY VIBRATIONS	10.6 OCTAVES	.02 KILOCYCLE <i>(20 VIBRATIONS PER SECOND)</i>	15,000,000 METERS
		<i>THE AUDIO FREQUENCY AND THE RADIO FREQUENCY OVERLAP AS SHOWN IN ANOTHER DIAGRAM HEREWITH.</i>	
USUAL RADIO WAVES	6.7 OCTAVES	30 KILOCYCLES	10,000 METERS
		<i>HERE BELONG ALL ORDINARY RADIO WAVES.</i>	
SHORT ELECTRIC WAVES	16.7 OCTAVES	3,000 KILOCYCLES	100 METERS
		<i>THESE WAVES HAVE BEEN USED ONLY EXPERIMENTALLY. HERE BELONG, ALSO, THE RADIO HEAT WAVES RECENTLY DISCOVERED BY DR. E. H. NICHOLS. ALL THESE WAVES WILL PROBABLY BE QUITE IMPORTANT IN THE FUTURE.</i>	
HEAT WAVES	10.3 OCTAVES	300,000,000 KILOCYCLES	.001 METER <i>(10,000,000 ANGSTROM UNITS)</i>
		<i>ALSO CALLED THE INFRA-RED RAYS.</i>	
LIGHT WAVES	1 OCTAVE	387,000,000,000 K.C.	7750 ANGSTROM UNITS
		759,000,000,000 K.C.	3900 ANGSTROM UNITS
ULTRA- VIOLET LIGHT	3.7 OCTAVES	10,000,000,000,000 K.C.	300 ANGSTROM UNITS
		<i>RAY'S THAT PENETRATE MOST KINDS OF MATTER.</i>	
X-RAYS	11.6 OCTAVES	30,000,000,000,000,000 K.C.	.1 ANGSTROM UNIT
		<i>FROM RADIUM</i>	
GAMMA RAYS	3.3 OCTAVES	300,000,000,000,000,000 K.C.	.01 ANGSTROM UNIT
		<i>UNEXPLORED REGION, WAVES STILL SHORTER THAN GAMMA RAYS</i>	

um. The term "octave" is borrowed from music. One octave means all the waves between any particular frequency and a frequency twice as great. For example, the first octave of the table includes all the waves between a frequency of 20 cycles a second and a frequency of 40 cycles a second; the second octave is from 40 to 80 cycles a second and so on.

The entire series of ether waves, from the longest radio waves to the shortest gamma rays, is now known without gaps. There was formerly a gap between the ultra-violet waves and the X rays, but this has been filled by the discovery of some very long X rays lying well within the ultra-violet range. The other former gap, between the heat waves and radio waves, was filled recently by the work of Nichols and Tear.

The divisions of the waves into radio waves, heat waves and light waves, are made merely for convenience. All the waves belong, really, to one unbroken series. Many of the divisions are overlapped, just as the heat waves overlap the short radio waves and the X rays overlap into the ultra-violet. A similar overlap of the audio frequencies and the radio frequencies is shown in the illustration on this page (Fig. I).

The ether waves that have been most studied by scientists are those of light. These differ from the longer and shorter waves only in that they happen to be perceived by the human eye. Physically all the waves are the same. The color of light depends upon its frequency, or, what is the same thing, upon its wavelength. The band of color in a rainbow, which scientists call the spectrum, is as follows (see next page):

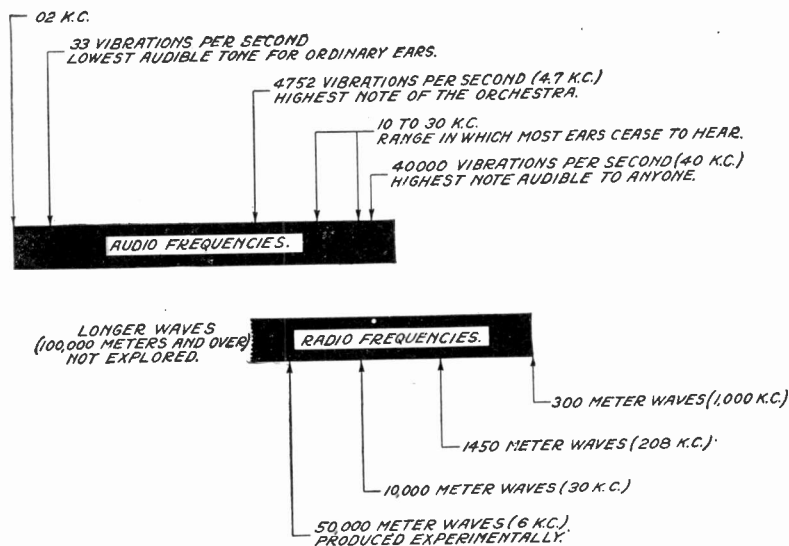

RADIO FREQUENCIES THAT WE CAN HEAR

Figure I: The longer waves of radio overlap into the range of audio frequencies, as is shown in this diagram.

	Angstrom Units
Heat waves (invisible).....	longer than 7,750
Red light.....	7,750 to 6,460
Orange light.....	6,460 to 5,900
Yellow light.....	5,900 to 5,600
Green light.....	5,600 to 4,900
Blue light.....	4,900 to 4,500
Violet light.....	4,500 to 3,900
Ultra-violet rays (invisible)	shorter than 3,900

The Angstrom unit used in this table and which is the common unit for the length of light waves, equals one ten-billionth of a meter. It is named after the celebrated Swedish scientist Dr. K. A. Angstrom, who was the first to study

and chart the spectrum of sunlight.

Other units of length sometimes used in designating the wavelengths of ether waves, are the following:

1 meter.....	equals 1,000 millimeters
1 millimeter.....	equals 1,000 microns
1 micron.....	equals 1,000 double microns
1 double micron	equals 10 Angstrom Units

The abbreviation for micron is the Greek letter mu (μ), that for the double micron is ($\mu\mu$); that for the Angstrom Unit is A. U. or sometimes merely A. A double micron is sometimes called a "micro-micron" or a "mille-micron."

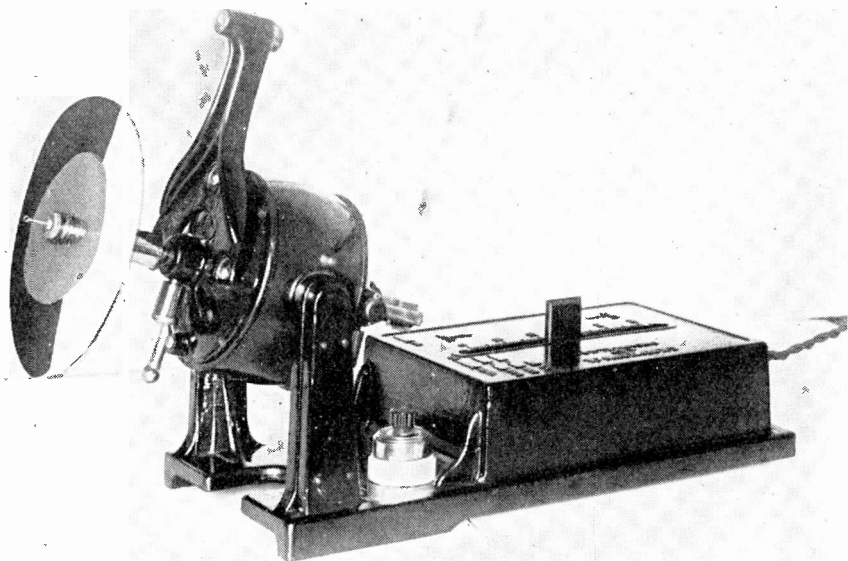

HOW COLORED LIGHT WAVES ARE MIXED AND JUDGED

Figure J: One half of the colored rim on the edge of the disk is red, the other half is white. When the disk is rapidly revolved by the attached electric motor the light waves in the two portions of the disk blend in the eye, producing a shade of pink. In the other way the color-blends necessary to produce any desired shade of any color are worked out in the laboratory. Psychologists also use this same instrument to determine the way in which the human eye sees various mixtures of light of different colors.

SECTION V

Mechanics and Electrics of Tuning

RADIO currents of high frequency are usually generated in some form of closed circuit, which is tuned by varying either the inductance or the capacity in the circuit or both. These currents must, however, be supplied to the antenna circuit, in some way or other, before they can be used for the propagation of Hertzian or radio waves through space, thus making possible radio telegraphy and telephony.

The device used for this purpose is called a "transformer." When it is used for transmitting it is usually called an "oscillation transformer," and when used in a receiving set, it is known as a "loose coupler" or "variocoupler."

Before we take up the devices used for high-frequency currents, let us study the ordinary low frequency transformer such as is used for lighting our homes.

Such a transformer consists of three main parts; a primary winding, a secondary winding, and an iron core. The core is usually made of iron sheets built up in the form of a square "ring," or hollow square. The primary winding is then wound over one side of this square, using the iron for a core, and the secondary is wound over the opposite side of the square, also using the iron for the core. Such a transformer is shown in Fig. B.

Now if we cause an alternating current or a pulsating direct current to flow through the primary winding, by con-

necting the two ends of the primary wire to an alternating current generator or to a direct current generator, with a device for breaking up the direct current into impulses, we will cause the iron core of the transformer to become magnetized. The magnetic flux will flow around through the "legs," and the direction of its flow will be governed by the direction of the current flowing through the primary coil.

We have already learned that if insulated wire is wound on a soft iron core and a current of electricity is caused to flow through the winding, the core will become magnetized. If a similar winding and core were suddenly to be placed near enough to a permanent magnet for the iron core to become magnetized externally for an instant, the reverse action would take place, and a current would thus be induced in the winding.

To return to our transformer; when the core is magnetized by the current flowing through the primary winding, the magnetic flux flows around through the core and passes through the center of the secondary winding. At this instant a current is induced in the secondary winding that corresponds exactly with the current that flows through the primary winding. This effect is called electromagnetic induction. The primary winding changes the electric current into magnetic energy; the core carries the magnetic energy around to the

secondary coil, and the secondary changes the magnetic energy back into an electric current.

In this way electric currents can be transferred from one circuit to another without any actual connection between the wires of the two circuits. When two circuits are thus connected together by means of a transformer, they are said to be "magnetically coupled" together.

Radio circuits are also coupled together in much the same manner, but the transformers used for coupling radio circuits do not have iron cores. They use air cores. Iron cores are used with low-frequency currents, while for high-

frequency currents air cores are used.

In transformers used for coupling radio circuits, the windings are wound on insulating tubes. Such a coil is shown in Fig. C.

If we take two such coils, one for the primary and one for the secondary and place them end to end as shown in Fig. A and cause a radio current to flow through the primary coil, the magnetic field surrounding the primary coil will envelop the secondary coil, passing through it and causing a current to flow through the secondary coil.

If, however, we should place the secondary coil at right angles to the primary

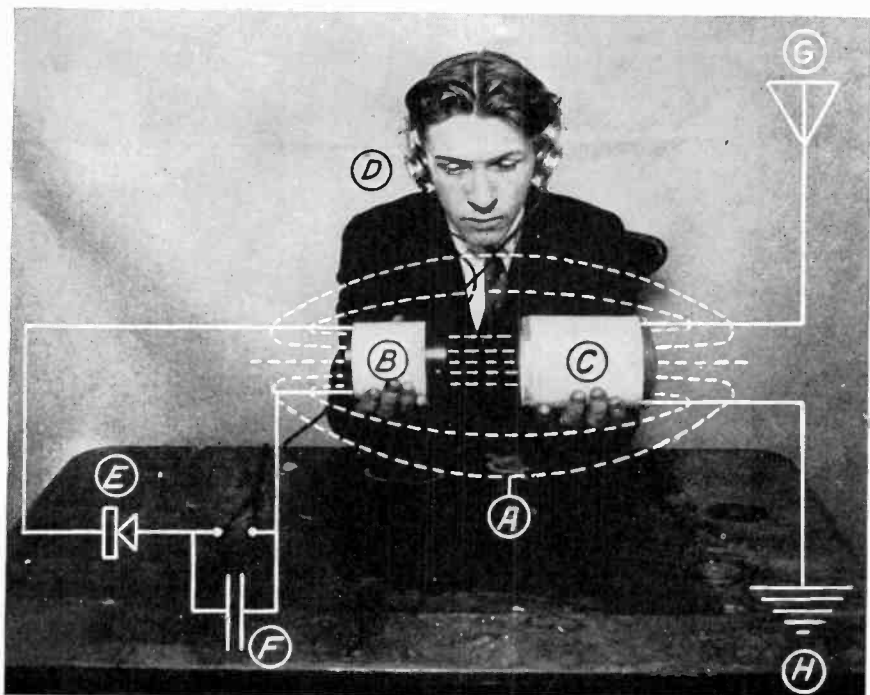

WHAT THE MAGNETIC ENERGY CIRCULATING AROUND RECEIVING COILS LOOKS LIKE

Figure A: If the human eye could perceive lines of electromagnetic force, it would see the phenomenon shown in this diagram. A are the lines of force generated by the primary coil C, which induce currents in the secondary coil B. D are the head telephones; E the crystal detector; F the fixed telephone condenser; G the antenna and H the ground connection.

coil as in the annexed Fig. E (B) page 114, there will be little or no current induced in the secondary coil as the magnetic flux does not flow in the proper direction through it. In most radio sets, the secondary winding rotates, and by rotating the knob on the set which is attached to this coil, the coupling is varied.

In some sets the secondary coil slides in and out of the primary coil, and the coupling is varied in this way. When the secondary coil is in a position that allows all of the magnetic flux to flow through it, the two circuits thus coupled are said to be "closely coupled," and when the secondary coil is placed in a position that allows little or no magnetic flux to flow through it, they are "loosely coupled." When a transmitting or a receiving set is coupled loosely to the antenna circuit, it sends out a sharper

wave or receives with much sharper tuning, than a set that is closely coupled.

An oscillating circuit comprises a condenser, a spark gap, and an inductance or coil. The coil serves a double purpose. It tunes the circuit to the desired wavelength, and also serves as the primary coil of an oscillation transformer. The secondary coil receives the oscillations from the primary coil by electromagnetic induction, and at the same time tunes the antenna circuit. The secondary coil is connected in series with the antenna and ground. In this way the antenna circuit is energized and the Hertzian waves are emitted from the antenna.

A variometer, which consists of two coils connected in series, is often used for tuning a circuit. One coil is stationary and is called the "stator"; the other coil rotates inside it and is called the

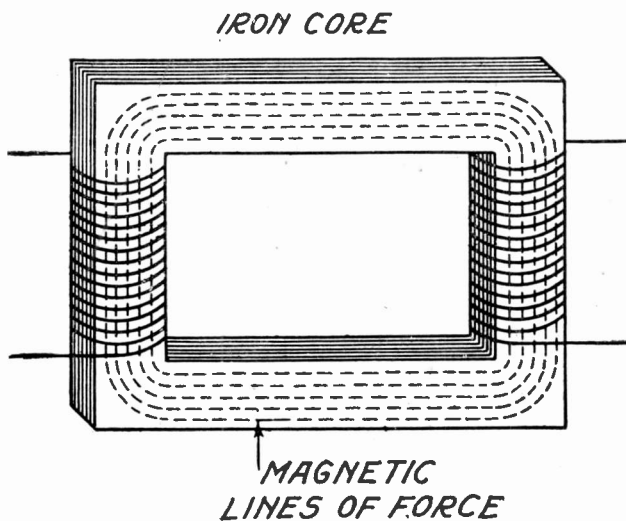

PICTURE-DIAGRAM OF A TRANSFORMER

Figure B: How an ordinary transformer transfers electric current from one circuit to another by means of two coils and an iron core.

“rotor.” In using this device to tune a circuit, when the coils are rotated so that the electromagnetic fields of the two coils are opposing (as Fig. D), the two fields acting against each other do not allow any electromagnetic energy to be stored up, or in other words their mutual induction is theoretically zero.

A coil of this type set in this position would respond to very low wavelengths.

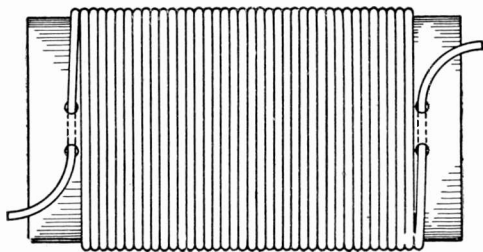

A SMALL INDUCTANCE

Figure C: A coil of the type used for transferring currents from one radio circuit to another.

If the rotor be turned so that its field be additive with the stator, as shown in Fig. D, the two fields will act with each other to store up electromagnetic energy, and the mutual induction will be at a maximum. In this position the variometer will respond to a high wavelength.

By slowly rotating the rotor from the first position to the last mentioned position, the variometer can be used for tuning and will pass through the various wavelengths that it is designed to listen in on. The variometer is used for tuning in receiving sets, and Fig. F shows two variometers used to tune the primary and secondary circuits of a receiving set. The other two coils shown in the circuit are the primary and secondary coils of the loose coupler, or variocoupler.

Thus we see how the coil is used in radio circuits, and that it serves the double purpose of tuning the circuits while at the same time it couples them together, or transfers the electricity from one circuit to the other.

While the subject of wave production and reception has been briefly treated previously, the importance of the matter is so great as to make further study

justified. Perhaps there is no better way of grasping the real fundamentals of tuning and wave production than to go back over the original work of Professor Heinrich Hertz, the young German student who first discovered the secrets of radio transmission and reception.

There is a romantic side to Hertz' work and, although it has nothing in particular to do with the purely practical phases of the subject we are considering, it does form one of the most fascinating side lights in the whole history of communication without wires. This is so because it involves a great figure in American life; Thomas A. Edison. Thomas A. Edison not only discovered the principle of the modern vacuum tube, as we shall see later, but he was responsible for setting off the spark of genius in young Hertz, whose work was

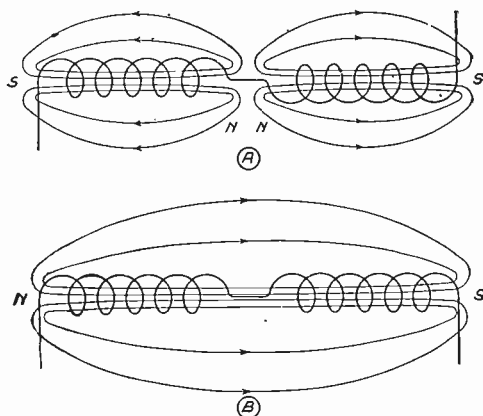

POSITION OF COILS

Figure D: A shows two coils connected in series with the windings opposing; with this connection the coils respond to low wavelengths. B shows the coils with the windings additive. This device is called a variometer.

the foundation of the great art of radio telegraphy and telephony.

In the early 80's, Edison was exhibiting his electric lights and scientific curiosities at the Paris Exposition. In his booth he had the apparatus necessary for the execution of an experiment that had caused him a great deal of amusement and wonder back in his American laboratory. On one side of the booth there stood on a pedestal a small black box containing nothing more than a loop of wire connected to a small spark gap. The box was so arranged that the spark that passed across the gap could be viewed only from the outside through a small peephole. On the opposite side of the stage, Edison had placed a spark coil, which is merely a high-voltage transformer working on an interrupted direct current circuit. Of course, the spark coil was provided with its own spark gap and when the primary circuit of the coil was closed, a high pressure discharge would take place across the gap. When this was done,

however, the little gap in the black box on the opposite side of the booth also responded and a tiny discharge crackled between the metal electrodes.

To the scientists of Europe, and there were some very great ones at the time, this Edisonian experiment was the most intriguing feature of the whole exposition. The little black box was the center of a great deal of attraction as the scientific generalissimos of the Continent crowded about it seeking to explain in their own minds the *modus operandi*. An actual transfer of energy was taking place under their very eyes and noses—there was a connection over space between two widely separated points—but no one in the group ventured a statement as to the mechanism of this marvelous feat.

One day, before the exposition had closed, a thin, retiring young man about twenty-seven years old was wandering through the aisles keenly absorbed in the details of the more scientific appurtenances. This young man naturally

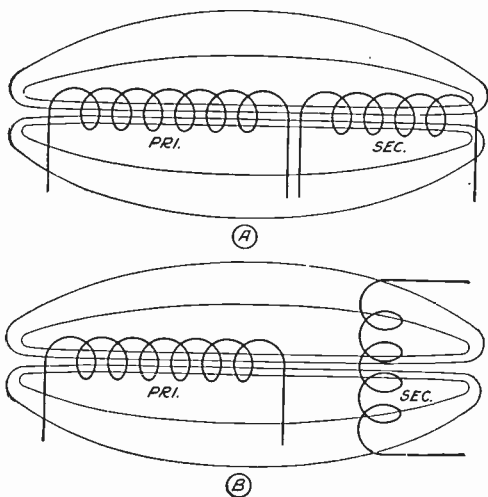

INDUCTIVE RELATIONSHIP

Figure E: Shows two coils placed in inductive relations to each other; large currents are induced in the secondary from the primary. B shows the coils in non-conductive relation. This device is called a loose coupler.

gravitated toward Edison's booth and there found the experiments that had baffled the older scientific heads. This young man was none other than Heinrich Hertz, and when young Hertz viewed this spark in the little black box his mind flashed back to the year 1860, the year in which Prof. James Clerk Maxwell, the Scotch physicist, promulgated his startling mathematical treatment on the electromagnetic wave theory. Although Maxwell had never heard of radio waves, he gave reasons for their existence in cold mathematics and when Hertz looked through the peephole in the little box he was pretty sure he was looking at a phenomenon that could be accounted for by Maxwell's penetrating figures.

Hertz, inspired and twitching to satisfy a consuming scientific curiosity, immediately returned to the University of Bonn (where he had graduated) to

begin what later proved to be the classical experiments from which the whole radio art blossomed.

If we follow closely an outline of Hertz' activity we shall gain from it a fairly accurate mental picture of how waves are transmitted and received. Not only this, but we shall gain a presentable idea of the underlying theory.

The simple devices used by Hertz are illustrated in Fig. G. The transmitter consisted merely of a conventional type of spark coil provided with an adjustable spark gap. This was the Hertzian transmitter. It was the device that set up electrical "splashes" in this vast all-pervading pool of highly attenuated stuff that we call the ether. The receiver was a modification of Edison's first contraption and it took the form of a loop of wire provided with two little brass knobs at each end. An insulated handle provided a means for carrying it

about the laboratory to get the effect of different positions and localities. This was the receiving element, and, since it greatly resembled the characteristic antenna of the butterfly, Hertz decided to name it after this and the name survives to this very day.

When Hertz set his spark coil in action and walked about the laboratory adjusting this antenna by moving the brass knobs closer and farther apart, a position would finally be reached where a small spark would pass across the gap indicating that the receiving outfit was in exact *resonance* or *in tune* with the very crude transmitter.

Hertz was a highly imaginative inves-

tigator and he was not satisfied to merely duplicate what must have been to Edison only a novel experiment. Hertz aimed to reveal the properties of these waves that he had discovered. At least he was positive that he was dealing with a wave phenomenon because of the peculiar actions of the transmitter and receiver and their need of being in resonance with each other. As a matter of fact, he wanted to show that these long waves had identically the same nature as the short ether waves of light. If his theory held true it was evident that these longer ether waves should possess the same properties as the shorter ones and that they, like the

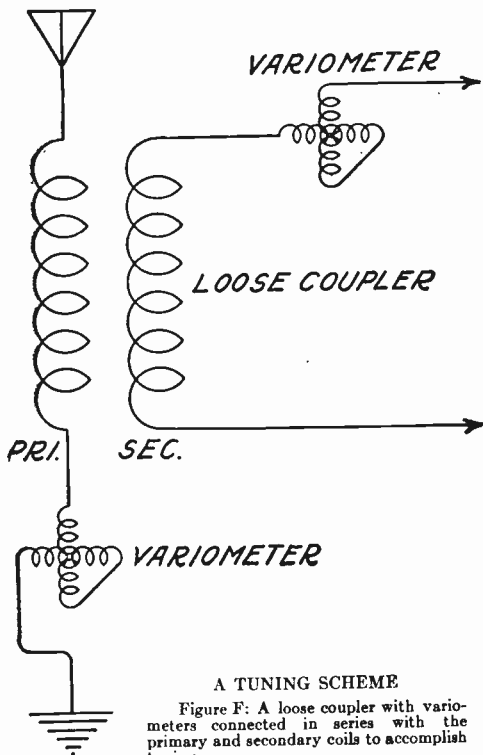

A TUNING SCHEME

Figure F: A loose coupler with variometers connected in series with the primary and secondary coils to accomplish tuning.

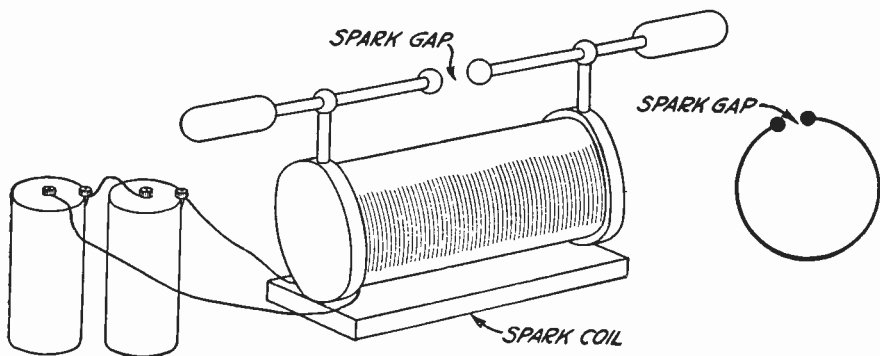

HISTORY-MAKING RADIO APPARATUS

Figure G: This cut shows the simple but highly ingenious apparatus employed by Hertz in his original experiments at the University of Bonn, Germany. Electromagnetic waves were set up with the spark coil and detected with the simple loop of wire illustrated at the right of the drawing. When the loop was in tune, a spark appeared across the gap. Hertz called the receiving loop an antenna because it resembled the antenna of a butterfly. This term has been held since that time.

shorter ones, should be capable of reflection, refraction and polarization. By setting up a reflector of proper size, Hertz found that he was able to direct these waves about the laboratory with impunity. He could send them shooting in this direction or that in searchlight-like fashion. Not only this, but by using a huge prism of pitch he was able to bend them in the same manner that light waves are bent when they pass through a glass prism. Hertz ended these classical experiments firm in the belief that he had discovered the big brothers of the little light waves that effect the optic nerve of the animal eye.

The tuning fundamentals of Hertz' transmitter and receiver are extremely simple. By measuring the distance from the end of one of the electrodes on the transmitter to the end of the other he was able to determine the approximate physical dimensions of a receiver that would be in resonance or in tune with the transmitter. Hertz knew that the length of the wave emitted by this simple contrivance would depend largely

upon the physical dimensions of the spark gap and electrodes. Let us assume, for argument's sake, that the distance between the ends of the electrodes was two feet. If the total length of the wire comprising the receiving loop was made two feet, it would be in resonance or in tune with the transmitter.

By increasing the length of the electrodes or spark gap, Hertz was able to vary the length of the wave emitted. He knew he was varying the length because he threw his receiver out of tune each time he increased the physical dimensions of the transmitter.

After reading the above, we come to the simple conclusion that radio tuning is, after all, very much like the experiments that we conducted with tuning forks and taut wires back in the high school physics class. It will be recalled that if two piano wires of exactly the same length are placed side by side, one will pick up the vibrations of the other even though it is not touched.

Our previous experience with elec-

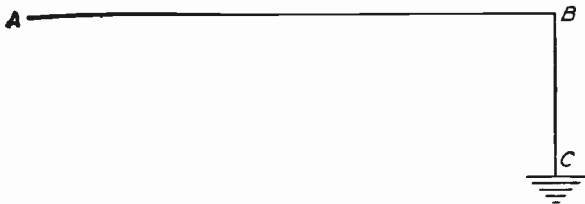

FACTS ABOUT A SIMPLE AERIAL SYSTEM

Figure H: The wavelength of an aerial system depends upon several factors, height being an important consideration as well as length. A high aerial not only means lower capacity (the electrical capacity existing between the aerial and the ground) but it also means a longer lead-in wire which is part of the aerial system and must be added in when calculations in wavelength are made. The aerial is measured not from points A and B as might be expected, but from A to C, which also includes the ground. The natural wavelength of the aerial system should never be greater than the wave to be received; that is the length in meters of the wire between points A and C should never be greater than the wavelength of the broadcasting stations to be received from.

trical condensers taught us that they might be charged and discharged and that this action depended not only upon their size but upon the voltage and frequency of the charging current. By using a condenser in connection with his very simple transmitter, Hertz found that he was able to control the wavelength. When a large condenser was used, the length of the wave emitted was made longer and when a small condenser was used it was made shorter. This can be easily understood, for, when the condenser is inserted, the electrical dimensions of the system are changed and this is equivalent to changing the physical dimensions. An interval of time is necessary to charge and discharge a condenser. This interval of time, as before stated, will depend upon the size of the condenser charging and the voltage and frequency of the current. When Hertz inserted the condenser he was no longer depending entirely upon the physical dimensions of his circuit. He also considered as a factor the rate at which the condenser charged and discharged.

Hertz also knew that he could make

waves longer by putting more wire in the circuit because it would take a current longer to get around the circuit, and since the wave it produced depended upon the frequency, it would be longer. This would be just like increasing the length of a piano wire. It will be seen that when condensers and coils are inserted in transmitter circuits to increase the wave length, proportionate changes have to be made in the receiving circuit before it can be placed in resonance or in tune with the transmitter. What we really do when we place condensers and coils in radio circuits is to change the frequency of the current flowing and this always changes the wavelength because the wavelength depends entirely upon frequency.

Let us take into consideration the case of an aerial wire connected to the ground (Fig. H). The wavelength of this receiving antenna will depend almost entirely upon the distance between points A and C. The aerial proper runs only between points A and B. However, in such cases, the length of the ground wire must also be included with any calculations pertaining to the wavelength of

VARIABLE CONDENSER

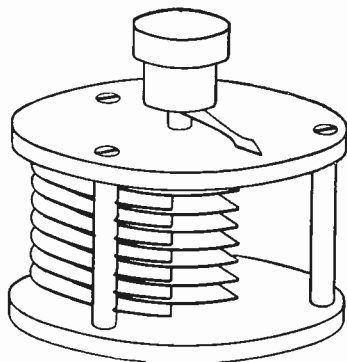

CONSTRUCTION OF THE VARIABLE CONDENSER

Figure I: A variable tuning condenser with which it is possible to make changes in capacity between certain limits, depending upon the number of plates in the condenser, the distance separating them and the general constructional features.

the system. For convenience sake, this antenna system will be said to have a "natural period" of 260 meters. By "natural period" we mean the wavelength to which the antenna system would be naturally tuned without any tuning devices. If such a simple antenna should be connected to a detecting device of some nature, the reception from 260 meter broadcast stations would be possible. This system, however, would be insensitive to the vibrations set up by the 316 meter broadcast stations or by any broadcast station with either a higher or lower wavelength. Of course it would be possible to climb up to the roof and change the amount of wire in the aerial but this would not only be an impractical but a totally unnecessary action. All that we need to do in such a case is to place a coil of wire in connection with the aerial, not on the roof, but in the receiving set used in connection with the aerial. This coil of wire is made variable by arrang-

ing its turns so that a small metal slider connected with the aerial may make contact with each individual turn. By moving this slider up and down the coil we may, without going on the roof and with very small exertion, add or subtract wire from the antenna system at the same time increasing or decreasing its length and consequently its response to waves of various lengths.

Condensers affect the wave length of receivers as well as transmitters and here we have another element of tuned circuits. It is evident from the outset that a condenser with a fixed capacity, that is a condenser able to hold a definite amount of electricity, would not be suitable for tuning because it would make only one definite change. A condenser with a variable capacity must be used for this purpose and we find in Fig. I a condenser of this type. Here we have a set of stationary and movable plates so arranged that the movable plates are sandwiched in be-

tween the stationary ones by turning the knob. The movable plates are kept out of direct contact with the stationary set by air separation and through the use of a suitable dielectric or insulating material. By turning the knob of the condenser, a continuously variable capacity is obtainable, and capacity can either be added or taken from a circuit by this simple action.

There is still another factor that will change the wavelength of a system and this is electrical resistance. Although resistance, due to its destructively inefficient effects, is not used for purposes of tuning, it is necessary that the student should have a knowledge of the manner in which it changes the frequency of alternating electric currents.

In our water analogy (Part II) we saw that the only force opposing the

flow of water—hence something to be made as low as possible—is the friction in the pipe. In electric circuits, resistance plays the same role—it uses up the energy in the production of heat which in most radio instruments is to be avoided.

Forcing current through the heater coil of an electric iron produces heat energy from electric energy. The filament of an ordinary incandescent lamp becomes hot and glows for the same reason.

The phenomena considered up to this point have been true of “direct current” resistance, that is, the resistance offered to a steady flow of electricity. In radio, however, we are not dealing with steady currents, but with currents that reverse their direction of flow many, many times a second. Other forces

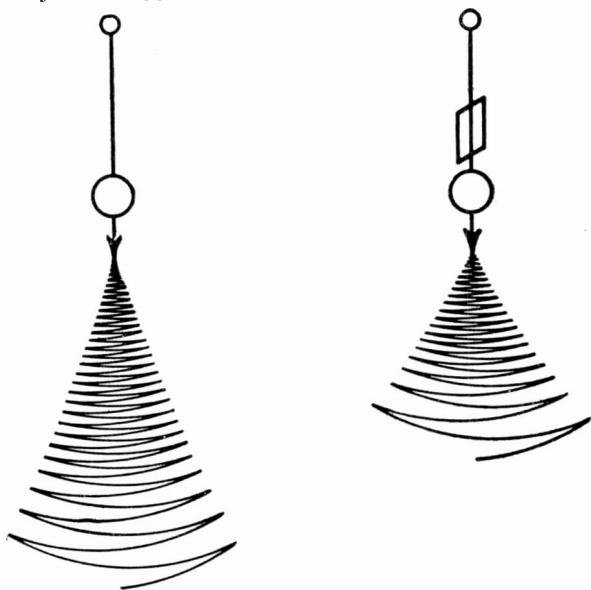

HOW THE OSCILLATIONS OF A PENDULUM ARE DAMPED

Figure J: The wind-vane attached to the pendulum at the left increases the air resistance and damps the oscillations of the pendulum. In an analogous way, electric resistance in a circuit damps out the electric oscillations of an alternating current.

come into play as soon as we leave the realm of steady currents, and jump into radio-frequency circuits.

At 300 meters, the current reverses its direction twice each cycle or two million times a second. Instead of sticking to the "straight and narrow" the current seems to try to get away from the wire. Like water on a rapidly rotating grindstone, it moves toward the outside of the wire. At very high frequencies, that is, at low wavelengths, the current is actually carried in a thin layer on the outside of the wire or other conductor.

This phenomenon is known as the "skin effect." The crowding of the current to the outside cuts down the effective cross section of the wire which increases the effective resistance.

Litzendraht wire, commonly known as "litz," was originated to overcome this increase of resistance with frequency. This wire is composed of many strands of fine wire, each insulated from the other. Litz is not effective unless great care is taken to see that each strand is cleaned and soldered when making connections. Broken wires within the cable destroy its effectiveness at once. With currents corresponding to a 1,000-meter wave, this stranded wire is particularly useful, while at extreme low wavelengths the current reverses so frequently that the advantages of stranding the wire are not so apparent.

At 200 meters, 99 per cent of the current is carried in a thin shell on the outside of the conductor. The thickness of this surface layer is about .009 inch. For this reason copper tubing is often used for heavy high-frequency currents; the hollow conductor has approximately the same high-frequency resistance as a solid wire.

Just as mechanical friction is the bane of all engineers, electrical resistance, ex-

cept where heat is required, is a thing to be avoided by electrical engineers. It is not sufficient in designing a coil to go to a wire table, pick out a size of wire that has a low direct-current resistance, and wind up a coil. The problem is one of winding a coil that will have a low resistance to *high-frequency currents*—and that is a task which has bothered even the best of engineers.

The effect of resistance in high-frequency circuits is to damp out the oscillations that exist in the circuit, and such damping out is not advisable. An analogous effect may be seen by counting the number of oscillations a pendulum makes before and after hanging a vane on the bob, so that the air resistance is increased. (Fig. J, Page 119).

The immediate result of adding resistance to a radio circuit is to broaden its tuning. For instance, the two curves shown (Fig K) here are "resonance curves" of a small receiving set. It will be seen that for a given wavelength (350 meters) the amount of current is large. On either side of this peak the current falls off rapidly, so that wavelengths lower and higher than 350 will cause little interference.

The other curve shows at once what happens when resistance is added to a high-frequency circuit. Signals of lower and higher wavelengths are much more noticeable than in the first case.

How are we to avoid resistance in a circuit, say in a receiving set?

A complete answer involves the mutual effects of circuits on each other, which is a matter that we will discuss under inductance. There are, however, a few practical rules to bear in mind, though, like many rules, they frequently fail:

1. Make only single-layer coils—or if more than one layer is necessary, use a bank winding.

2. Space solid wires about the distance of the diameter of the wire. Do not space Litz wire—wind turns closely together.

3. Avoid taps.

4. Avoid larger coils than necessary. Do not expect a coil large enough to tune to waves of 3,000 meters to do good work on 300 meters.

5. Use small tubes and many turns rather than large tubes and few turns.

6. Make leads short and of the same size of wire as the coil.

7. Choose the size of wire carefully.

It is a safe rule to use wire between the sizes of No. 18 to No. 30, although it must be admitted that tuners made of smaller or larger wire than these limits sometimes work and work well.

We are now ready to take up the subject of tuning devices and the first one that comes to our attention, because of its simplicity, is the single-slide tuning coil. Although the single-slide tuning

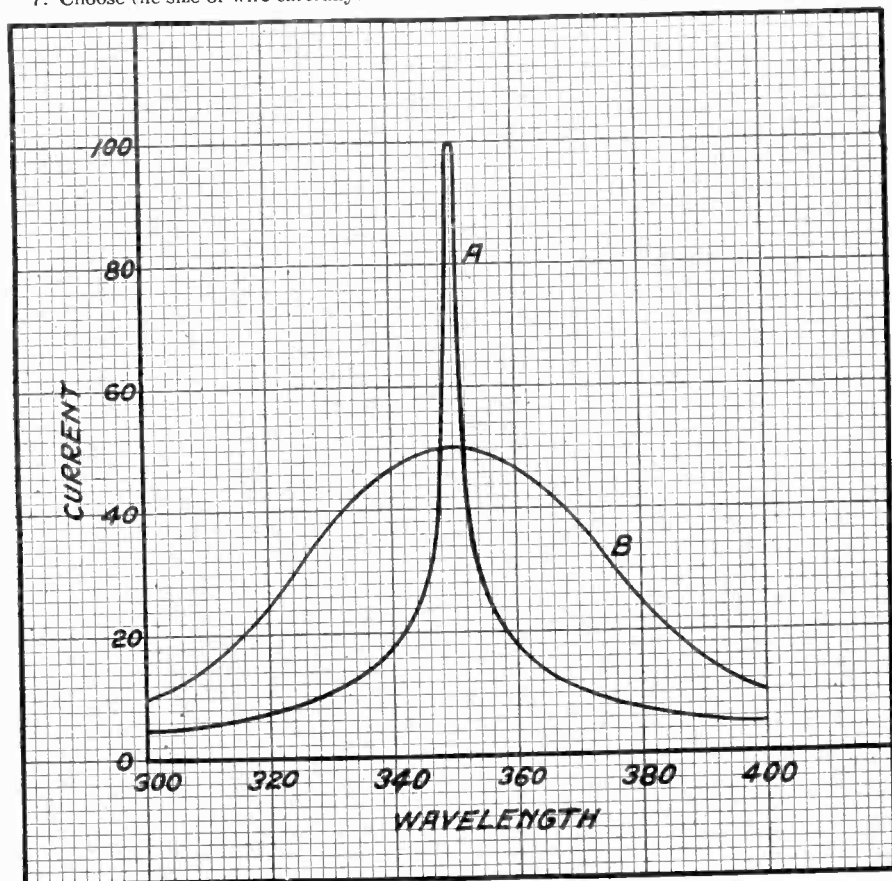

HOW RESISTANCE IN A CIRCUIT AFFECTS TUNING

Figure K: Resonance curve A corresponds to a circuit that has little resistance. The tuning is sharp on a wavelength of 350 meters. Curve B represents a circuit containing more resistance. The resonance is less sharp and the tuning is broadened.

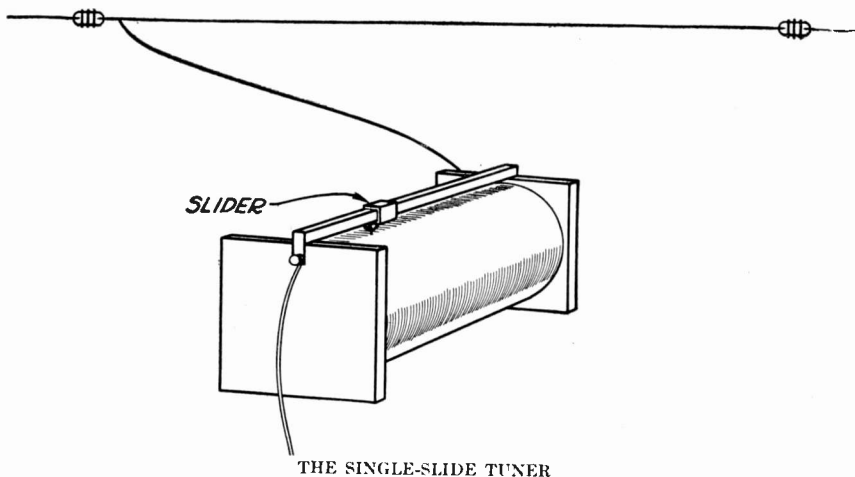

Figure L: How the simple single-slide tuning coil is connected to an aerial to form a variable portion of it.

coil was a much used device in the early days of radio it is now practically obsolete having given place to more efficient devices for the bringing about of resonance. As might be expected by the reader who has carefully followed the foregoing matter, the old fashioned single-slide tuning coils were directly connected to one end of the antenna and were, in effect, merely a concentrated part of the antenna system in general. For that matter, every tuning device is a concentrated part of the aerial system but it seems more logical to look upon the single-slide tuner in this way because of its extremely simple construction. One of our accompanying sketches (Fig. L) shows the method of connecting the single-slide tuner in the aerial system. Here it will be seen that the slide or the movable contact, which makes connection with the turns of wire upon the cylinder, is connected with the ground and that by moving this slide, wire may be added or taken from the aerial.

A tuning coil, or for that matter, a

tuning device of any kind, connected in the manner shown is said to be in the antenna or aerial circuit. It is well to remember this for radio literature of all kinds makes reference to the antenna circuit.

While there are a number of different ways of connecting even this simple single slide tuner, it is useless to consider them because of the technical standing of this form of tuning device. However, by viewing Fig. M, page 123, the student will be able to grasp a fundamental which will show the logic of referring to a tuning coil and an aerial as a circuit. In the past, our conception of a circuit has generally involved a complete metallic path from the positive side of a source of current like a battery or a generator back to the negative side.

If we will recall the explanation of a condenser, we shall see that the aerial and the ground with the dielectric, air, in between really forms a condenser of small capacity. Thus a circuit is established taking the route shown in Fig. M.

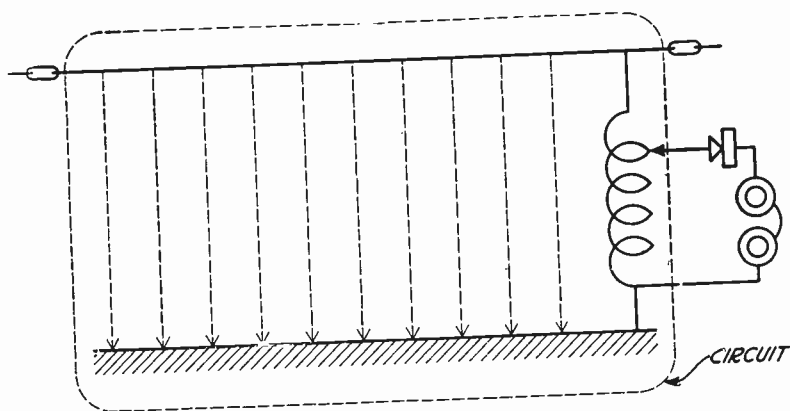

THE CAPACITY BETWEEN AERIAL AND GROUND

Figure M: The dotted lines represent the capacity existing between the aerial and ground of any aerial system.

There is also a second circuit involving the tuning coil, the crystal detector and the receiving telephones. At the same time it will be seen that an antenna circuit is not merely a circuit containing inductance or wire. It must, for the reasons given, contain some capacity. The amount of this capacity will depend upon the height of the aerial and its size. If the aerial is very small and very high it will have an insignificant capacity and vice versa.

Aerials of large capacities are, of course, more susceptible to longer waves than are shorter aerials. They are susceptible to longer waves not only because of a large capacity but because of a great amount of inductance. It often happens that the amateur experimenter or radio fan is unable to put his equipment in resonance with a distant transmitter of low wavelength because the "natural period" of his antenna system is safely above the wave which he desires to receive. His antenna may have a natural wavelength of 300 meters and the wave he wishes to receive may be as low as 215 meters.

The treatment of this problem allows us to put into actual practice some of the facts we absorbed earlier in the course concerning the connections of condensers and how these connections affect the combined capacities. For instance, it was said that connecting condensers in series reduced the capacity of the group. Two one microfarad condensers connected in series (illustrated again in Figure N) result in an actual combined capacity of $\frac{1}{2}$ microfarad. If the condensers were connected in multiple or parallel, the capacity would be added and there would be available a total capacity of two microfarads.

By taking advantage of this peculiarity of electrostatic condensers we may very conveniently reduce the capacity and thereby the natural period or natural wavelength of an antenna circuit by merely placing in series with the aerial and the tuning device a small condenser of either a fixed or variable type. Of course, with the variable type finer adjustments may be made in tuning and greater selectivity or separation of wavelengths is attainable. What we really

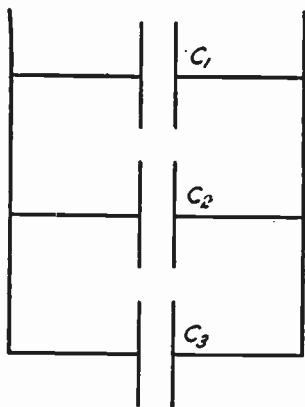

CONDENSERS IN MULTIPLE

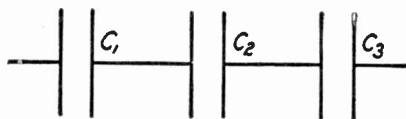

CONDENSERS IN SERIES

HOW TO CONNECT CONDENSERS

Figure N: The above directions must always be followed if condensers are to be connected in groups to give different capacities.

do here is to place a capacity in series with the existing capacity between the aerial and the ground. This always results in reducing the wavelength because the *total capacity is made smaller*.

If it is found that an antenna system, or technically an antenna circuit, will not respond to a long wavelength there is another way that may be resorted to in boosting the wavelength to a point where the longer wave will be successfully entrapped. It would be necessary only to wind a few turns (actual number of turns will depend upon the increase desired) of wire upon a cardboard tube which would be inserted any place between the aerial and the ground. Such a coil is technically known as a *loading coil*. It really is a wavelength booster.

Before passing on to the more involved systems of tuning radio receivers, it would be wise to treat more thoroughly the practical features of antenna erection and construction. Here at last is a point where the prac-

tical mixes freely with the theoretical. Since the antenna is essentially one plate of an electrostatic condenser, it is evident that it must be properly insulated from the other plate, the ground. If there is any considerable leak between the aerial and the ground, the condenser will be more or less ineffective and the receiving set will fail to take in the largest amount of energy possible. This will result in low efficiency and poor selectivity. Aside from the aerial forming a part of the condenser, it must also be remembered that there is induced in it an actual measurable electric current, for when these rapidly moving radio waves strike something that is attuned to them they are immediately reconverted back into electric currents of a very small value.

Insulators used to hold antenna out of electrical contact with their surroundings should be of the best possible quality to prevent leakage. They must also be chosen with some idea as to their resistivity to weather conditions. Glass

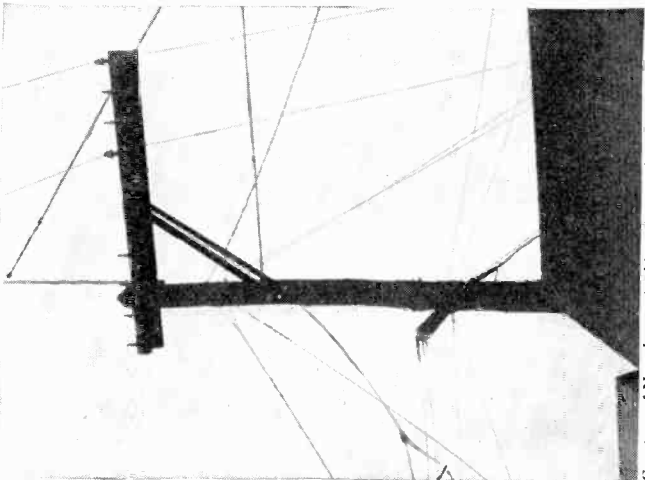

Courtesy of New Jersey Accident Prevention Committee

DON'T STRING UP YOUR ANTENNA WHERE IT MAY TOUCH OTHER WIRES

Figure O: You involve risk when you place an antenna in a maze of wires like the one shown above.

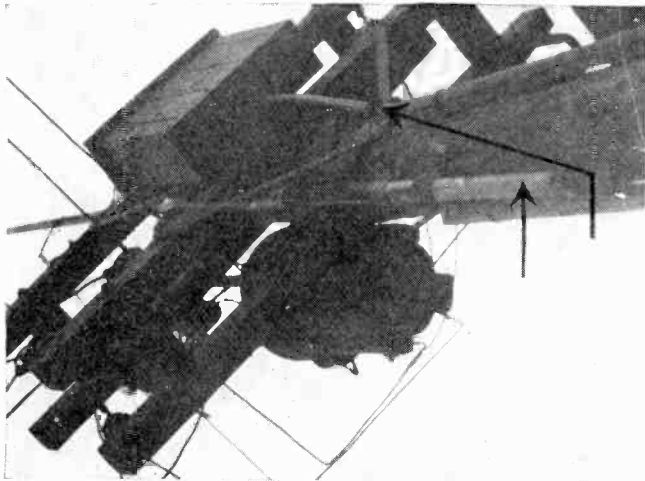

Courtesy of New Jersey Accident Prevention Committee

DON'T RIG ANTENNA ON ELECTRIC LIGHT POLES

Figure P: The short arrow points out an antenna supporting-pipe that passes close to power lines. The long arrow indicates an antenna pulley attached to a cable.

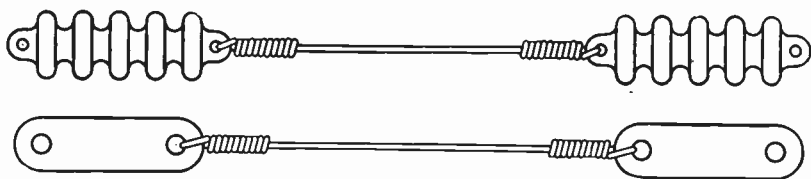

HOW TO USE INSULATORS

Figure Q: The use of insulators in tandem. The insulators above are made especially for aerial use while the lower cut shows how ordinary insulators used in house wiring may be pressed into service. Many other types of insulators are used but the corrugated porcelain type shown at the top is in great favor.

and porcelain are not only excellent insulators but they are able to withstand the worst attacks of the elements for many years without showing signs of appreciable electrical depreciation. Insulators, when used in connection with a single wire, which is usually the type employed for broadcast reception, are ordinarily placed in tandem. These will be found illustrated in Fig. Q. The reader will also notice (Fig. R) the general method employed in making multi-wire antennae. The wave length of a multi-wire antenna depends largely upon the method of connecting the wires. If four wires are used and connected at their ends in the form shown, the wavelength will be a little greater than that of one wire for there will be a greater capacity due to the increased area.

Single wire antennae used for broadcast reception should have a total length, excluding the tuning devices but including the ground wire, of about 150 feet. This does not mean, of course, that signals cannot be received on a 50-foot antenna or a 25-foot antenna. It simply means that greatest efficiency would result with the longer antenna because it will, so to speak, obtain a larger "grip" on the ether. The more wire (within definite limits), generally speaking, that is exposed to the waves, the greater the induced current will be.

Indoor antennae cannot be as effi-

cient as antennae placed directly in the path of approaching waves. While it is true that electromagnetic waves can penetrate solid matter with ease, they always do so at a sacrifice in energy. Unless an ultra-sensitive receiving set is used, it is not advisable to employ an inside antenna of the type mentioned.

In designing and erecting an antenna it is important that the constructor consider the effect of placing the antenna in various directions. There is well substantiated experimental proof which shows that aerials receive best in the direction in which they are pointed. This "directive effect" is most pronounced when the far end of the antenna wire is higher than the other end. It sometimes happens that a transmitting station that eludes the antenna in one position can be received from by effecting a change in the direction of the aerial.

Some advice on the type of wire to use in aerials may not come amiss. Iron, steel or any other wire with a high resistance must be avoided if the efficiency of the receiving set is to be brought up to the highest possible level. The wire used should be of copper with a fair sized diameter. If bare copper wire is used, a single piece about No. 14 gauge is preferable. Smaller gauges used in large spans are apt to succumb to belligerent winds. Stranded copper wire, which is made up of a half dozen or more of independent wires twisted together, is

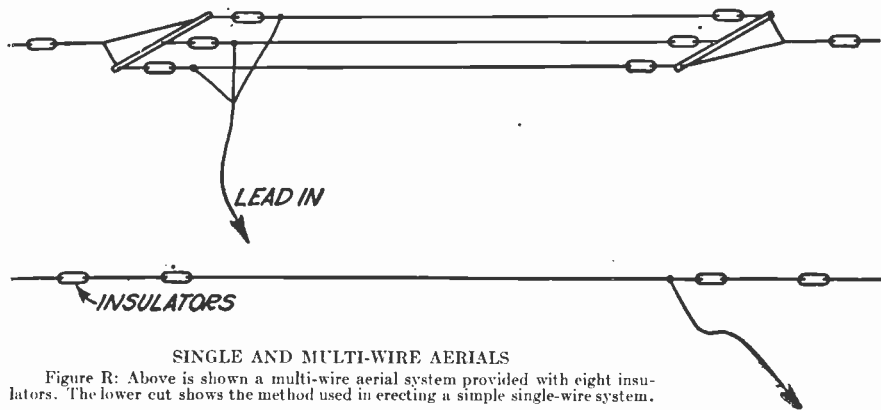

best both from the electrical and mechanical standpoint.

There is a system of using the electric light wires of a building as an antenna and, while this principle does not work out in all cases, due to peculiar local conditions, it is worth trying. It would be disastrous and highly dangerous to connect a radio set directly to an electric light socket, but it has been found that a small condenser, while it will effectively choke off the low-frequency currents in the lighting circuit, will per-

mit the high frequency currents of radio to pass with little resistance. The inquisitive reader, remembering that condensers transmit current, will probably wonder why the current from the lighting circuit is not able to pass through with the radio-frequency currents. Perhaps a small amount of it does, but it is not appreciable and certainly not enough to be considered. If a great quantity of current was to be taken from an alternating lighting circuit through a condenser, the condenser

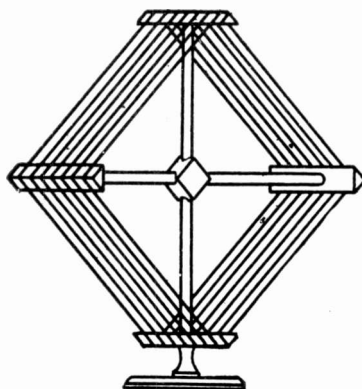
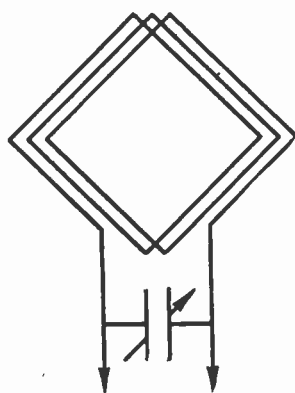

HOW TO TUNE A LOOP

Figure S: At the left is shown the method of connecting a variable condenser to a loop aerial for tuning purposes. The cut on the right shows the conventional construction for loop aerials.

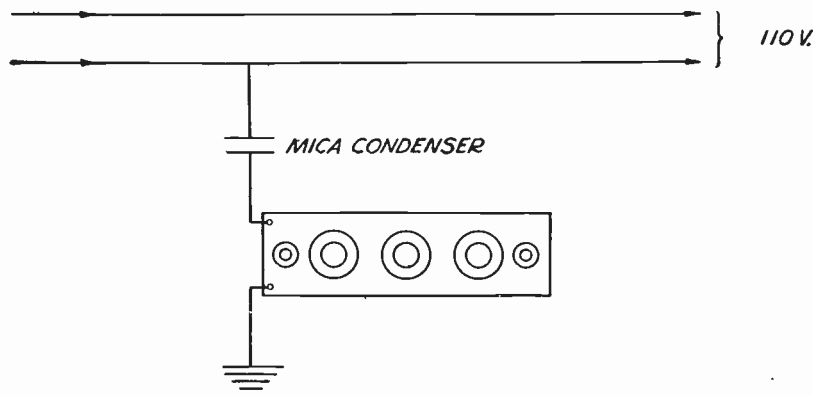

THE LIGHTING WIRES AS AN AERIAL

Figure T: How it is possible, using a small fixed condenser, to connect an ordinary receiving set to the lighting circuit. Long distance reception is attained with such an arrangement.

would have to be of tremendous capacity due to the low frequency.

The success of connecting a receiving set to a lighting circuit through the medium of a fixed mica condenser depends upon the fact that every lighting circuit in any building absorbs a certain amount of the energy from passing radio waves. By suitably connecting a receiving set to this lighting circuit, this energy may be made available in the form of music and speech.

There is still another type of indoor aerial, the loop. The loop is sort of a concentrated antenna wound upon (and insulated from) a frame in the form of a coil. As in the case of an outside antenna, the wavelength of an indoor loop depends largely upon the number of turns it carries. The fewer the turns, the lower the wavelength and vice versa. (Refer to Fig. S, page 127).

The loop is really a magnetic type of antenna. It functions as a coil of wire functions when it is brought into a field of magnetism produced by an alternating current source. While it has a measur-

able capacity it is not as high as that of an outdoor antenna. Loops are usually tuned by varying the number of turns they contain through the medium of a switch or by shunting a variable condenser across their terminals as in Fig. S. There is another factor, too, that determines the efficiency of loop reception and this is the position of the loop in regard to the direction of the approaching waves. It has been found that loops have marked directive effects and that they receive best when placed in certain definite positions. This fact brings us to a simple electrical rule, an understanding of which will not only permit us to use a loop with intelligence, but which can be applied practically in reducing interference from extraneous sources.

It has been shown that coils of wire pick up and convert electromagnetic waves best when they are placed in a certain definite position with regard to the waves. When a coil of wire is placed in the position illustrated at B, Fig. U, minimum energy will be received. If the loop is turned so that it points di-

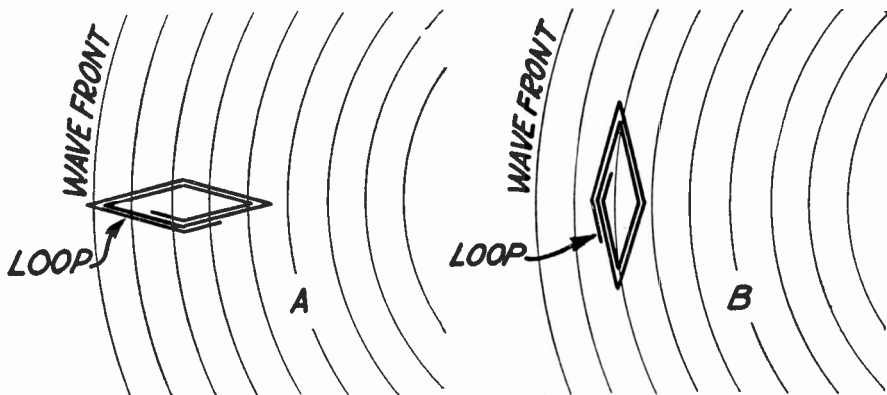

LOOPS AND HOW THEY INTERCEPT WAVES

Figure U: At A, the loop is positioned so as to intercept the maximum amount of radio energy. When in this position, it will be pointing directly at the radio station doing the transmitting. B illustrates the position of minimum sensitivity.

rectly to the transmitting station, maximum energy will be induced in it.

By employing a system of loops, the Navy Department of the United States has been able to devise a workable scheme for the location of ships at sea. This rule of the loop is more or less invariable and if the direction of a transmitting station is known, the operator will have little or no trouble in receiving from it if he places his loop so that it will point in the general direction of the station. The tuning effect of the loops, will at once be evident when a loop is turned during reception. The strength of the reproduced sound will vary all the way from great audibility to practical inaudibility by turning the loop 90 degrees.

By employing some tricks of the trade it is possible to receive over comparatively great distances by using highly sensitive receivers minus the conventional aerial. As a matter of fact, the systems that we are about to describe* do not use aerials at all. While reception by means of these methods will be

* They are outlined by the famous radio experimenter, Paul Godley.

found very satisfactory considering the conditions, the novice using them should not expect to duplicate the performance of outdoor antenna systems.

"Many circuits of one sort or another have been devised which enable broadcast reception without the use of an antenna. Mainly these have been comprised of multi-stage amplifiers of the radio-frequency type; and no general attempts have been made to take advantage of the inherent sensitivity of regenerative circuits in conjunction with 'antenna-less' outfits.

"In passing, two interesting facts might be observed. (1) The cheapest and most effective form of radio amplification which has been devised for use in conjunction with an antenna-less radio receiver may be constructed at a cost of a few dollars. It is comprised of an average-sized antenna and a good earth connection.

"(2) As compared to hazards involved by telephone and electric light connection due to lightning or other cause, the lightning hazard of an antenna is, at least, small.

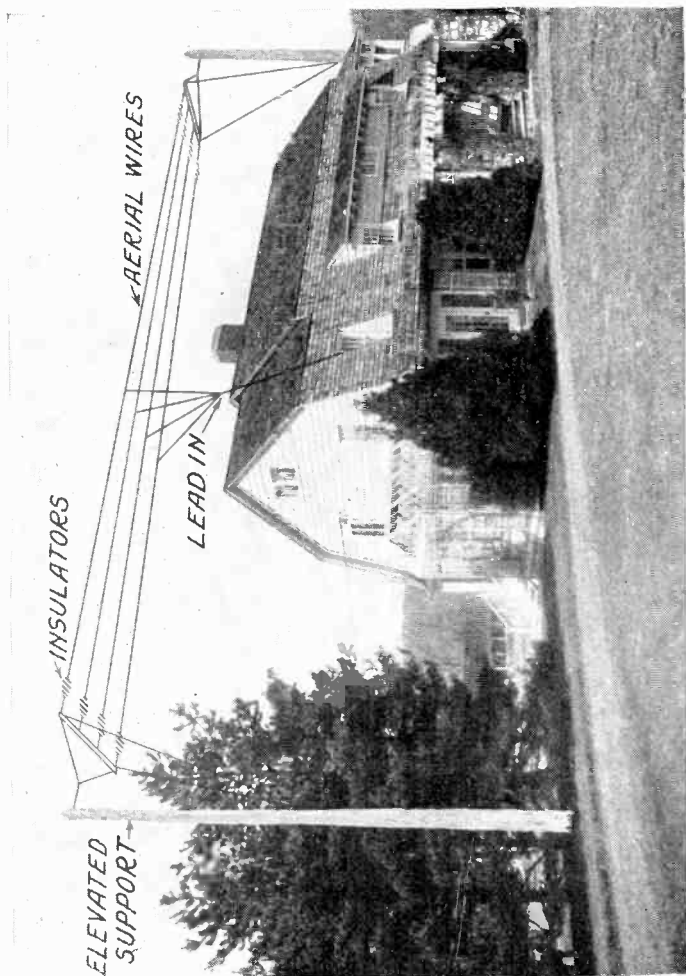

PUTTING UP A BIG TRANSMITTING AERIAL.

Figure V. A good method of erecting a large transmitting aerial system. The student will notice special guy wires arranged at each end of the aerial to prevent it from swaying in the wind. This not only increases its resistance to the elements but adds to its electrical efficiency.

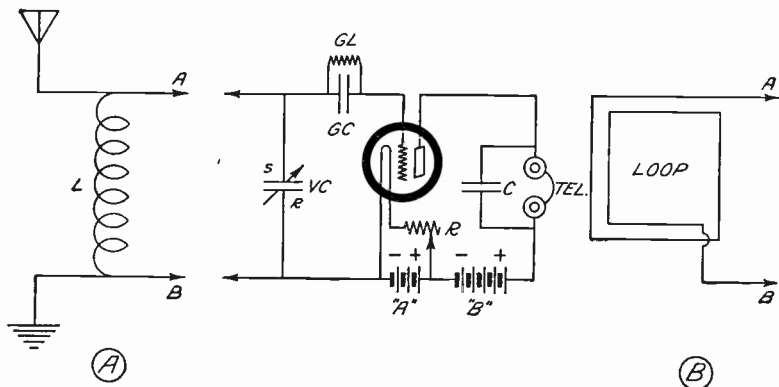

TWO PICK-UP SYSTEMS

Figure W: The potential developed across the terminals A and B of coil L (shown at "A" in connection with an outdoor antenna) are of enormously greater amplitudes than those developed across A and B of the loop antenna (shown at "B"). If either of these two pick-up systems were used with the vacuum-tube detector circuit (shown in the middle of the diagram), scheme "A" would therefore be immeasurably better.

"Multi-stage radio-frequency units depend as a rule for excitation upon the current collected by a loop antenna consisting of a few turns of wire on a square frame, two feet or so on a side, and almost invariably the circuits call for a ground connection. Upon trying circuits of this sort, it is immediately learned by the experimenter that if the ground connection is left off the strength of the received signal is materially weakened. From this it must be assumed that all of the energy which excites the outfit does not come to it through the loop antenna; that the ground connection in itself is in some manner acting as an antenna; that currents are being generated in the earth and fed up to the receiver through the ground connection.

"It takes but a moment for even the uninitiated experimenter to prove to his own satisfaction that the currents generated in the loop antenna, such as that described briefly above, are small indeed as compared to those generated in an overhead antenna of average dimen-

sions. In other words, the difference of potential which exists between the points A, and B, in the antenna circuit (left hand side Figure W) are quite large as compared to those differences in potential existing between points A, and B, in the right hand side of Figure W. The ratio of those potentials will run somewhere in the neighborhood of one hundred to one. If the ground connection is run directly to the grid of the vacuum tube (as shown in Figure X) and if proper compensation is made in the tuning element of Figure X so as to allow for the change in wavelength which results, surprisingly large values of signal will be fed into the outfit as compared to those fed into it by the loop alone. The ratio of the signal potentials picked up on the average ground connection, as compared to those picked up by the average antenna, is about twenty to one in favor of the antenna. This ratio will vary a great deal, however, depending upon the type of ground connection. Where the ground connection is a long one, the energy picked up

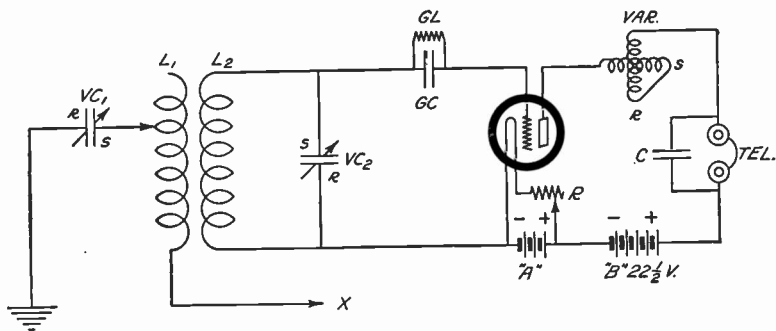

OVERCOMING "BODY CAPACITY"

Figure Z: This circuit overcomes the inherent body-capacity troubles encountered in the circuits of Figure B and C.

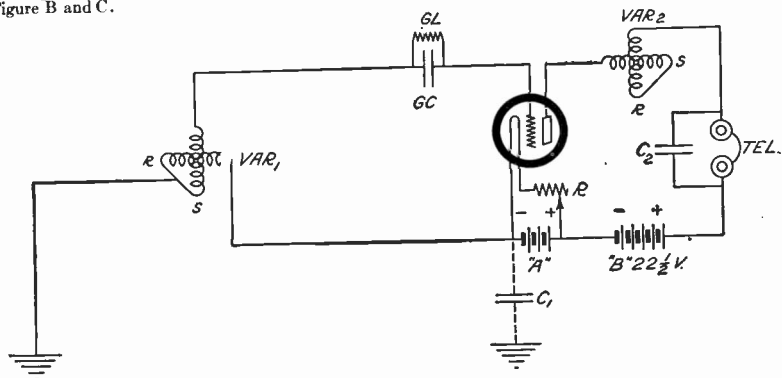

SPLIT VARIOMETER METHOD

Figure AA: The split-variometer method, which is about the same thing as shown in Figure C.

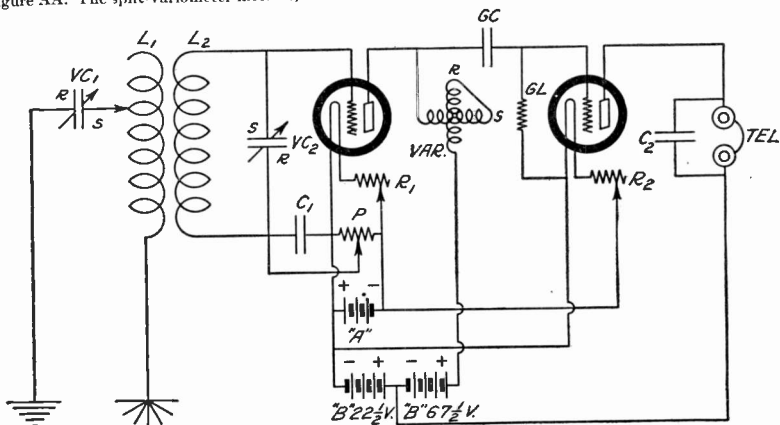

USING R. F. AMPLIFICATION

Figure BB: One stage of tuned, regenerative, radio-frequency amplification

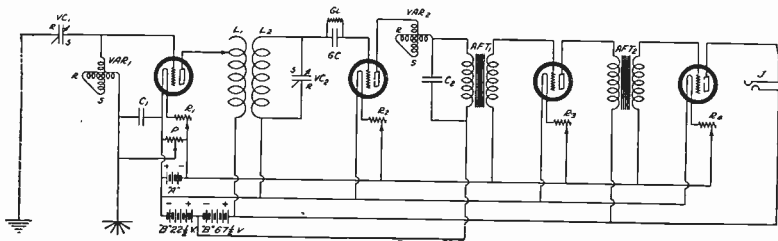

THE MOST EFFICIENT CIRCUIT

Figure CC: The best circuit arrangement of all to use. This is a standard three-circuit regenerative receiver, with the tuned ground circuit, one stage of radio-frequency amplification and two stages of audio-frequency amplification. This is an exceptionally sensitive set-up and works splendidly with this antennaless system.

will be *greater*; if the ground connection is a short one, it will be *less*. In the average home, however, this ratio of approximately twenty to one will hold true.

Connecting the ground to the grid of the vacuum tube is *not* desirable, however, for the reason that the size of the capacity C-1, is large. (This capacity C-1, is formed by the receiver and its battery which go to make up one plate of a condenser, and the ground which forms the other plate. The insulating material, air, or whatever it may be, between the receiver and the earth, forms the dielectric. Its value will, of course, vary, depending upon the location of the receiver with respect to the earth.)

"A better method of connection is that shown in Figure CC, where a tap is taken out of the center of the grid inductance and grounded. This, however, has not completely eliminated the difficulty of the shunt capacity; furthermore, both the methods of Figure X and Figure Y place the filament circuit of the receiver at a potential considerably above earth potential, which results in serious difficulties as soon as one attempts to tune the outfit, as the operator's body in approaching the receiver

will alter the value of the capacity C-1, in either case, with the usual baffling result.

"The circuit shown in Figure Z overcomes these difficulties and results in the same signal strength. Figure Z is easily arranged in conjunction with any standard three-circuit receiver and may be set up without any great amount of difficulty when using a single-circuit receiver (merely by supplying and coupling an extra inductance L-1).

"Figure AA indicates a method of utilizing the earth pick-up where the receiver is comprised of two variometers, one in the grid circuit and one in the plate circuit. In this case, the earth is connected to the mid-point of the grid variometer."

While there are many extraneous sources of interference with radio reception, aside from the lack of sensitivity in many poorly designed receivers, most of these obnoxious interruptions and irritating cacophonies may be eliminated by taking advantage of certain definite electrical laws.

Interference from power lines is more or less chronic in small towns where heavy sources of current surge through wires on telegraph poles. This interference is due not only to leakage from

the power lines but to direct inductive effects. In the case of leakage, a noise is produced in the receiver very much like that produced by static. It may not appear with any regularity and at times only when the weather is damp or rainy. There is little that the radio student can do to overcome such annoying noises. Certainly he should by no means risk his life investigating the insulators on the poles near the house. Power lines that cause chronic interference of this nature usually carry a death-dealing current that burns human flesh immediately it comes in contact with it.

The power companies throughout the country have in general bent every effort to keep interference of this nature down to a minimum. It seems that they are not only desirous of keeping informed regarding leaks in their lines but that they also have a genuine desire to establish peace and tranquility in the ethereal world. If chronic cases are re-

ported to them, an effort will be made to seek out the character of the trouble. It often happens, however, that the exact source of interference of this nature is most difficult to locate. If the power company cannot find it, it behooves the troubled person to set about to locate it himself. If the following directions are carefully carried out, a simple and effective means of searching out this form of annoyance will be available.

A trouble finder must be portable and it must employ a loop antenna or receptor. The most essential factor is the directional property of this loop antenna. If the loop antenna is directional in its effect, the source of interference may be located by direct tracing or by triangulation; that is, by taking a bearing with the loop receiver from two or more different points in the zone of interference and drawing lines on a map of the city, one from each point

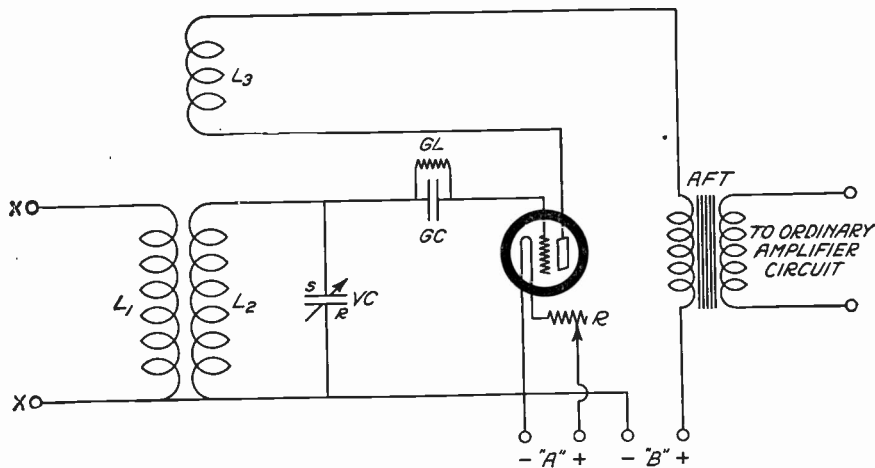

THE WIRING DIAGRAM OF THE INTERFERENCE LOCATOR

Figure CC2: The terminals marked X connect to the loop. The circuit is the ordinary three-coil tickler hook-up. Any other good circuit can be used provided it is arranged to tune the wavelengths below the broadcasting, so that the interference can be received without the music or lectures.

where a bearing is taken, in the direction in which the loop antenna points, and the source of the interference will be found at the point of intersection of these lines.

A common type of power-line interference is that produced by an arc in a circuit due to leakage from one circuit to another, from a circuit to the ground, or to a poor connection. This arc tends to set up currents which feed back through other power lines, with the result that the interference is noticeable over a wide area, although the maximum interference will be noted in the immediate vicinity of that part of the circuit which is arcing. With an ordinary receiver that employs a loop antenna, it is often difficult to locate the source of interference by triangulation, due to the fact that the interference is prevalent over such a wide area and affects the receiving circuit direct or through the battery and telephone leads, thus tending to destroy the directional property of the loop antenna. It is, therefore, essential that a receiver be employed which will not be affected by disturbances except through the medium of the loop antenna. A receiver of this type has recently been used in an investigation of power-line interference in a Georgia city.

The wiring diagram of the trouble locator is shown. The primary and tickler coils are wound in the same manner as the coils in a "low-loss" tuner, of No. 18 cotton-covered wire, $3\frac{1}{4}$ inches in diameter, the primary having 5 turns and the tickler 12 turns. The secondary is wound on a 4-inch cardboard tube in the ordinary way, of No. 18 cotton-covered wire, having 23 turns. A .0005 mfd. variable condenser is shunted across the secondary.

The general construction of the loop antenna is also shown in Fig. DD.

The thorough shielding of the receiver should be noted from the illustration. The inside of the receiver cabinet is lined on all sides with tin and all battery and telephone leads are covered with copper braid connected to the shielding inside of the cabinet. The shielding around the telephone leads is connected to a binding post between the telephone jacks, the binding post being connected to the shielding inside of the receiver cabinet.

The first test was made with an ordinary loop receiver, with which the interference was traced to a street lighting circuit, which, when cut off, eliminated the interference. This circuit, however, is twenty miles long and the power company had no means available for locating the exact point in the circuit from which the interference came and the loop receiver being used was not sufficiently directional to locate it. A power-line expert was then sent to this city but was unable to locate the exact source of the trouble, although exhaustive tests were made of lights, insulators, generators and other equipment under suspicion. These tests, however, developed some interesting facts and after comparing notes on these two tests it was decided to construct the receiver referred to above.

Another test was then made using this thoroughly shielded receiver. The interference was found to be greater in one section of the city and the point of maximum intensity was found by listening on various broadcast receivers in the vicinity. Maximum interference was noted at the residence of a broadcast listener two blocks from the point where the defect in the lines was ultimately found. At this point, using a receiver employing three stages of radio-frequency amplification, detector and two

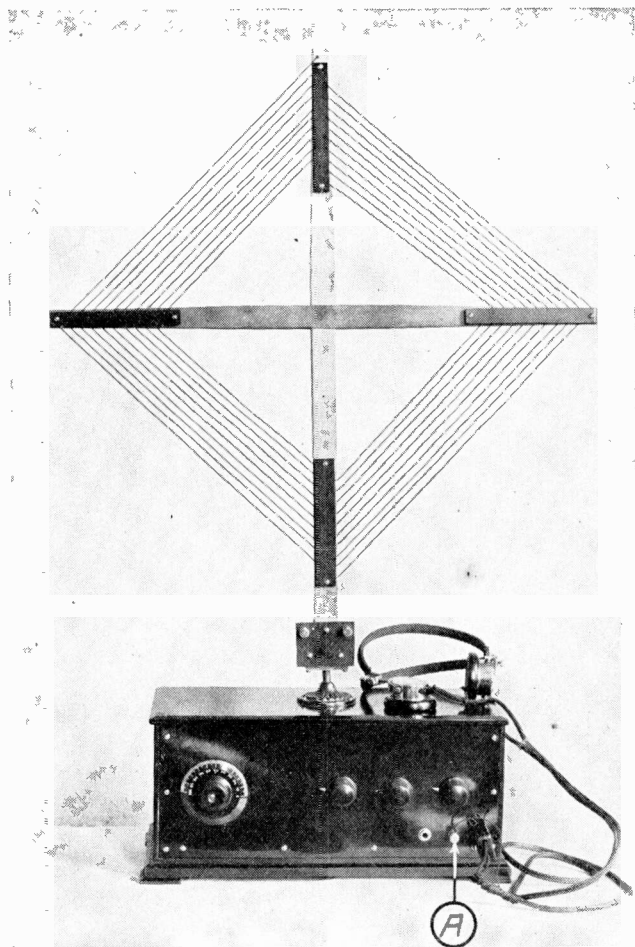

A SET THAT LOCATES POWER-LINE INTERFERENCE

Figure DD: The binding post A, between the two jacks, is grounded on the shielding inside the cabinet so that an extra wire connected to the copper braid that is wound around the phone cords may be grounded to the inside shield.

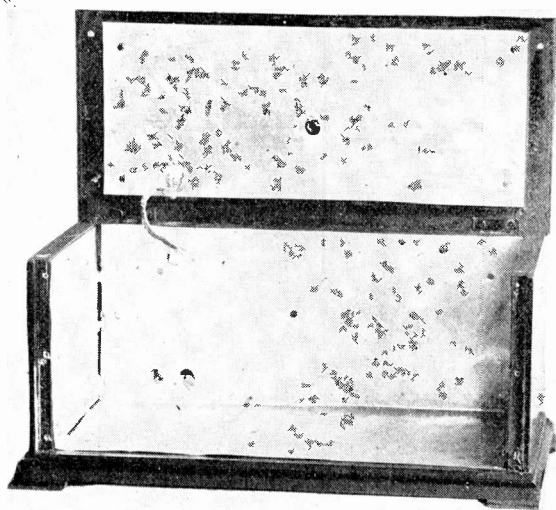

COMPLETE SHIELDING MAKES THE LOOP SHARPLY DIRECTIONAL

Figure EE: Shielding may be of doubtful value in many types of receiving sets, but it is essential in locating interference. The cabinet shown above is completely lined with sheet metal. The top section is electrically connected to the rest of the shield by the piece of copper braid, as shown.

stages of audio-frequency amplification, connected to a loudspeaker, the disturbance could be heard for nearly two city blocks, completely drowning out all broadcasting stations.

The shielded receiver was mounted in an automobile and the maximum signal strength was noted when the loop receptor was pointed directly down the street. As a 13,000-volt transformer was located in the center of the street about five blocks away, the automobile was moved in that direction, but upon arriving at the transformer it was noted that the signal strength had decreased and the loop receptor pointed back up the street. Several trips were made up and down the street between two of these transformers until the car was finally stopped about two blocks below the residence of the broadcast listener,

directly in front of a suspended street light, where it was found that the signal strength was at its maximum.

A pole was secured and when this light was tapped the interference varied from nearly minimum to maximum as the light swung from its support; this variation was noted on both the portable loop receiver and also on the receiver located in the residence of the broadcast listener two blocks away. The car was moved about one block, first to the right and then to the left of the light, and new bearings taken; and in each instance the loop pointed directly toward this light.

A lineman was secured who shorted the light, which was a high-voltage series lighting circuit. But this did not remove the interference. The outlet to this light was then shorted on the pole

and the circuit leading to the light entirely cut out, but this also failed to eliminate the trouble, although tapping the light caused the strength of the interference to vary as first found. The lineman shook the various wires attached to the pole below the 13,000 volt line; it was found that the interference stopped when the steel guy wire, supporting the street light, was raised. This guy was found to be lying across a 2,300-volt primary circuit, causing an arc. The light, swinging in the wind at times, apparently accounted for the intermittent nature of the interference.

The tests were started at 8.00 P.M. and the trouble was located about midnight; a lineman was secured and the trouble remedied about 3.30 A.M. About eight hours were required for the test. It will be found in such cases that patience is as much a necessity as the proper type of equipment.

The circuit employed in a receiver used for this purpose was not found to be important, so long as sufficient amplification is employed, two stages being preferred, and the wavelength range is low enough to avoid interference from local transmitting stations.

The shielding, however, is extremely important. Isolating the receiver in this manner, but not connecting any part of it to the shielding, tends to increase the directional properties of the loop receptor, which is a vital factor in locating any type of interference.

Interference from power lines is sometimes characterized by a constant and loud hum of undiminishing amplitude. If the power line is close by, this hum is of sufficient magnitude to be heard over reception. Unfortunately, few remedies can be applied to eliminate such trouble. In some instances this "AC hum" as it is often called, is produced

because the antenna runs parallel with the power lines. The inductive relationship in such cases is ideal for a maximum amount of current will be transferred from one circuit to another inductively when the wires run parallel. About the best thing that the novice can do is to run his antenna *at right angles to the power lines*. This should diminish, if not eliminate, the noise. If it does not diminish it sufficiently, the next best thing to do is to shorten the antenna for larger antennae usually pick up a greater volume of current.

While speaking about power lines, the student is warned against running his aerial system over any wires carrying electric current. This includes lighting service wires, for, while 110 volts is not looked upon as fatal, surges in power lines and defects in transformers often cause the voltage in such service wires to rise to a very high value. Furthermore, if the aerial wire should drop in a wind-storm and accidentally short circuit the service line, heavy electrical damage would probably result. Not only this, but a person operating the receiver might receive a dangerous shock and all of the vacuum tubes and perhaps the transformers in the receiver would be burned out.

It must be remembered that electric light systems are grounded as well as radio circuits and that should the aerial come in contact with only one side of a power circuit, a short circuit would be produced. There is also a possibility that such a short circuit would produce a fire if the aerial dropped during the absence of the family.

It is odd how the mention of outside aerials usually brings to the mind of the novice the subject of lightning. It seems that there is an inborn fear of lightning in the human race. It is un-

fortunate, too, that misinformation often spreads more rapidly than true knowledge and this has been the case in connection with lightning and radio.

Lightning, like other dangers we face, appears worse than it is. Of course, the probability of danger has been well advertised from the standpoint of public safety by the Board of Underwriters and

power to attract or change the course of a lightning discharge of billions of volts.

Here are a few of the facts of science:

Most visible lightning discharges take place between clouds of different potentials. If every flash seen during a storm were grounded to earth in the form of a direct discharge, a thunderstorm would invariably be accompanied by tremen-

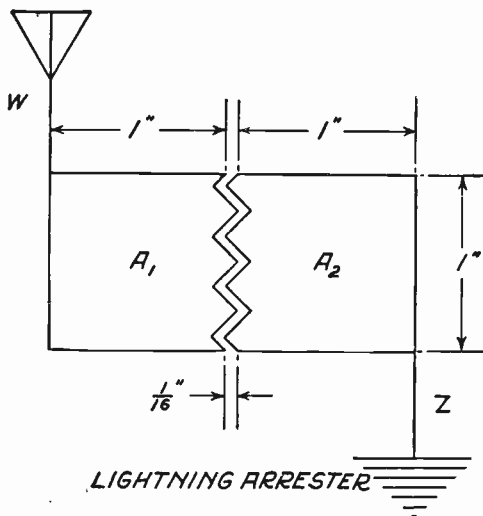

SIMPLE ARRESTER

Figure FF: An air gap lightning protector can be made of two pieces of brass plate as shown above. These should be mounted on a suitable insulated base and the receiving set should be connected across W and Z.

from the business standpoint by manufacturers of lightning arresters.

Fears disappear with knowledge of the facts. The facts that relate to the possibility of lightning striking an antenna are of two groups: facts of experience and facts of science.

As to facts of experience:

After twenty years of radio, there are but few cases on record of antennae being struck by lightning. It is nonsense to attribute to a radio antenna the

dous damage, but instead of this, most of the charges gathered on clouds are dissipated through a continuous stream of leakage between the earth and the clouds. Nature with her usual foresight, always accompanies high humidity and heavy rain with a highly charged cloud atmosphere. In this way she punctures the insulation of air between the clouds and the earth by a continuous stream of minute conducting bodies, each highly charged. Some of these continually dis-

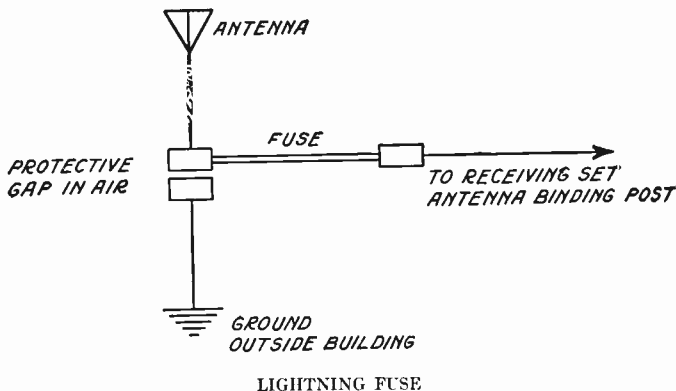

Figure GG: This lightning protector has a fuse leading into the instruments. If lightning should strike, the long fuse would blow out and the electrical discharge would take place through the gap.

charge through the antenna system, as is evidenced by that unpleasant noise which we call static. Thus, there is a continuous conducting path between a cloud and the earth, resulting in a lightning flash only when extremely high charges are present. When such a discharge takes place, a current of millions of amperes and billions of volts drain the cloud of its charge.

A thunderstorm, then, clears away the charges on the clouds in two ways; first by a continuous stream of charged raindrops and conducting ions; and second, by direct discharges, such as take place between the electrodes of a spark gap. The latter is usually preceded by a collection of charges from nearby clouds until sufficient potential has been collected by some one cloud to break its way directly to the earth through a space of from one and a half to two or more miles.

An electric charge sufficiently strong to break through a space of that distance is of such intensity that its course is influenced very slightly by the relatively small attraction of a piece of antenna

wire. Moreover, a grounded antenna is at the same potential as the earth itself.

Since the potential of the antenna is practically the same, the only other assumption that might make it seem that an antenna might be an attraction for a lightning discharge is the fact that the antenna is nearer the cloud than the surface of the earth. The cloud is from 7,000 to 11,000 feet away. The ordinary receiving antenna for broadcasting is seldom more than a hundred feet in the air. A hundred feet more or less travel for a charge of billions of volts is not sufficient to make such a charge change its course as much as twenty feet in order to find such a little path of less resistance. In the few cases known of lightning striking an antenna, it is certain that it would have struck at that very spot if no antenna had been there.

The actual ionized path established by a direct cloud discharge is at the most but a few inches in diameter. Surrounding this ionized path of direct discharge, there is a large accompanying discharge, perhaps several miles in area. This entire area is influenced by the terrific

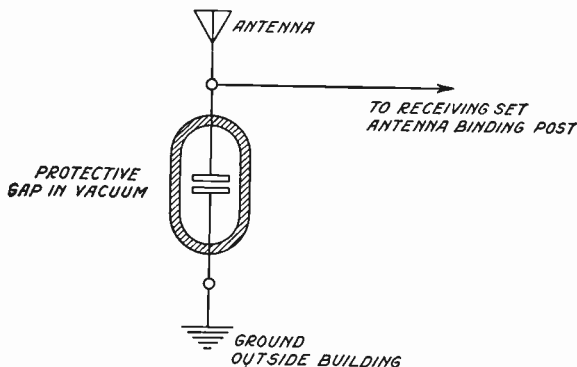

A VACUUM TYPE OF LIGHTNING ARRESTER

Figure HH: The instruments are connected to the antenna and ground as usual, with the gap shunting the windings. Any electrical surges that gather on the antenna immediately cause a discharge across the gap in the vacuum.

current grounded by the lightning discharge. Sensitive receiving sets are greatly affected by this for several miles around—perhaps anywhere within a radius of scores of miles. It is against this sympathetic discharge that we take our main precautions.

The lightning arrester dissipates such charges with certainty and safety even though the antenna is not grounded, and so forms actual protection, similar to that of the time-honored lightning rod.

The lightning arrester is a safety gap designed with such electrodes that a charge on the antenna of over 500 volts is grounded with the greatest possible facility. Whenever a charge of sufficient voltage is collected on the antenna, a spark discharge takes place across the electrodes of the arrester gap.

Against an actual discharge—that is, lightning striking at a particular place—there is no real protection possible.

Since the actual ionized path of such a direct cloud discharge is but a few inches in diameter the owner of a broadcast receiving set should not expect his

particular little antenna with no especial attracting features to be picked out. He would be as much an egotist as an old maid in her little back yard holding out an up-turned thimble, confidently expecting that when but one rain-drop falls from a cloud two miles away, it will so distinguish her as to direct its way to her thimble when it might as easily fall anywhere else within the State.

In planning lightning protection, make certain that your antenna is protected by a grounding device as required by the Board of Underwriters. This protects you against damage occasioned by any discharge taking place through the antenna either because of natural leakage or because of indirect cloud discharges and lightning discharges nearby. By having the grounding device properly installed the insurance on the property is protected. A radio set that is properly set up with antenna and with ground connections made in the correct way, affords better protection against lightning than if it were not installed. There is absolutely no justification for

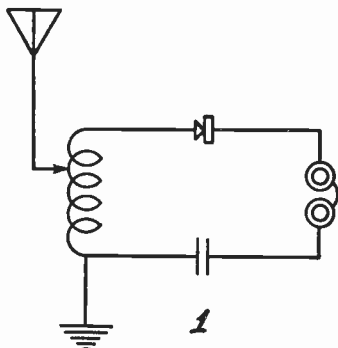

DIRECT COUPLING

Figure II: The system of tuning employed here is known as "direct coupling," a term coming from the fact that the tuning coil, which may have a number of sliders to take the place of the single one illustrated, is connected by direct metallic path with the aerial proper. While there is a coupling effect between the aerial and the closed circuit (the circuit involving the condenser, detector and 'phones) it is not as pronounced as that occurring between the two coils in diagram 3 on this page.

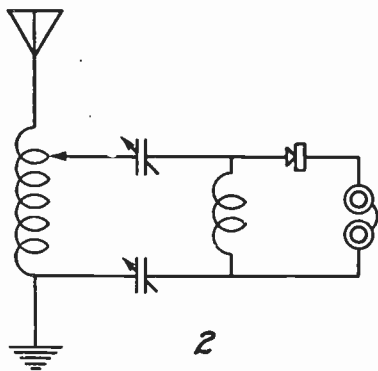

ELECTROSTATIC COUPLINGS

Fig. II: Here a single or multi-slide tuning coil is employed together with two coupling condensers of a variable type. The electrical energy of the aerial system is transferred to the circuit containing the 'phones and detector by the charging and discharging of the condensers.

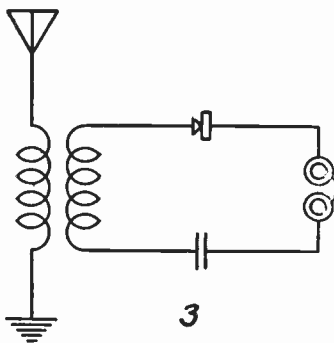

INDUCTIVE COUPLING

Fig. II: Here two independent coils are used, one in the aerial circuit and one in the closed circuit with the 'phones, condenser and detector. The energy in this case is transferred from the aerial circuit to the closed circuit by electro-magnetic induction. Tuning may be affected by changing the degree of coupling between the coils.

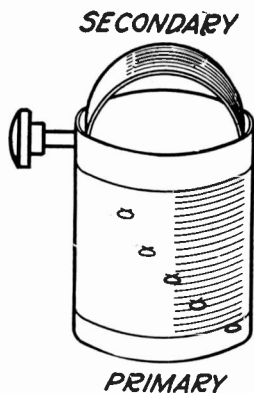

A LOOSE-COUPLER

Fig. JJ. A conventional type of loose coupler. The upper coil is moveable while the large coil (the primary) is usually tapped for purposes of tuning.

the hysterical fear that a radio installation will "draw" lightning—no more justification than in the case of the child's fear that some grinning hobgoblin will jump out from the dark.

After having digressed, beneficially we hope, into the realm of the aerial proper we shall now return to the subject of tuning. In the accompanying diagrams (Fig. II) we see the three principal methods used in bringing circuits into resonance. The first case was considered previously. It is that of using a single slide tuner directly in connection with the aerial. This is called the *direct coupling* method because the current flows by direct metallic path without being inductively or capacitatively transferred from one circuit to another. In the left-hand diagram, we see the *capacitative coupling* method where the tuning coil is still used but two condensers of the variable type are used to transfer the energy from the aerial circuit to the secondary circuit containing the 'phones and the detecting device.

In the third case there is shown the *inductive coupling* method of transferring energy from the primary or aerial circuit to the secondary circuit.

Inductive coupling as illustrated in the third circuit is usually effected by what is known as a loose coupler. The name of the device is more or less indicative of its principle of operation. Two coils loosely coupled, that is placed in "loose" inductive relationship to each other, are mounted so that one coil is movable. The loose coupler usually takes the form depicted (Fig. JJ). A primary winding, which is the winding connected to the aerial and the ground, is placed upon a cardboard or bakelite tube measuring about $3\frac{1}{2}$ inches in diameter. The size of the wire and the size of the tube will, in some measure, depend upon the length of the wave to which it is desired to tune. A second coil, the secondary, which is usually directly connected to the detector, is arranged at the end of the large coil so that it may be turned. From our understanding of

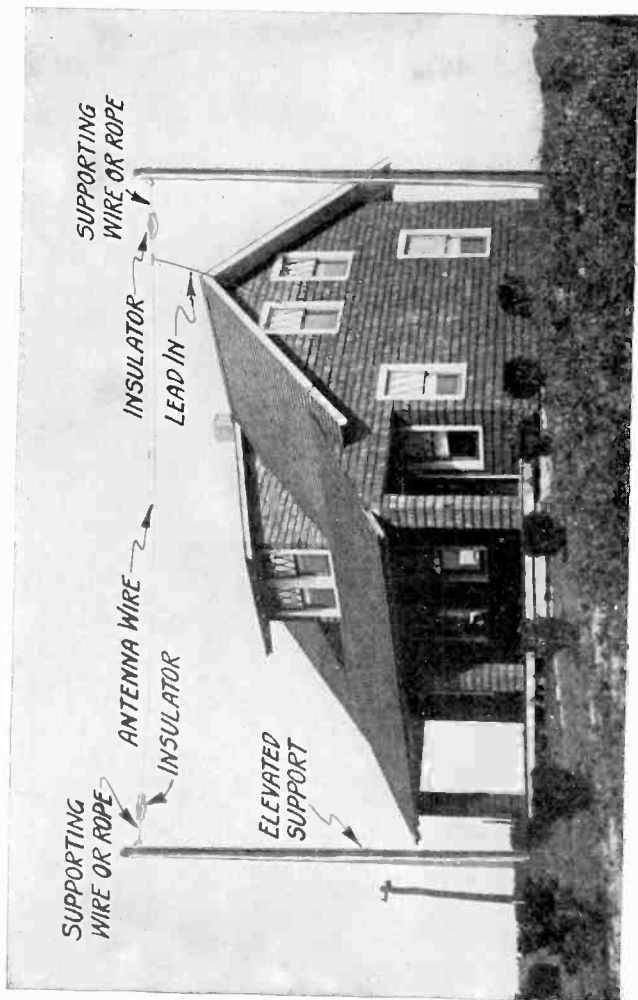

AMATEURS HAVE SENT AND RECEIVED TRANSATLANTIC MESSAGES WITH THIS TYPE OF ANTENNA

Figure KK: As the amateur is limited to transmission on low wavelengths a highly efficient antenna is a prime necessity. This is the best for his purpose.

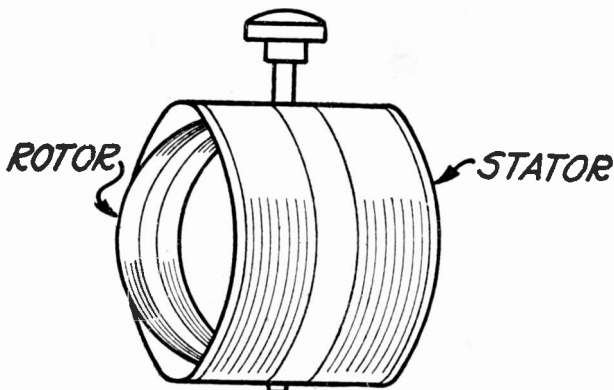

A VARIOMETER

Fig. LL: Two coils are involved in a variometer but, unlike the loose-coupler, they are connected together directly. By turning the coils they are caused to "buck" or aid each other.

inductive effects, it will be seen that by turning the secondary coil the inductive relationship, and therefore the resonance, between the primary and the secondary circuit is altered. When the winding on the secondary of the loose coupler is placed exactly parallel to the winding of the primary, there will be a maximum transfer of energy between the two circuits. When the secondary coil is placed at right angles to the primary there will be a minimum transfer. Here we see the reason why it is not advisable to place aerial wires parallel with power lines.

There is still another method of inductively regulating the transfer of energy from the aerial to the detecting circuit. This is done by an instrument known as a variometer. The variometer is made up of one continuous coil of wire arranged in two sections. The one section is usually mounted on the inside of a wood or composition frame and the second coil is usually mounted upon the outside of a spherical frame revolving within the first coil.

Only two terminals are provided with the instrument and here we will see, by means of the illustration and a few words of explanation, how such a device can regulate the flow of energy between two circuits. The stationary and movable portion of the continuous coil in the variometer can be put in inductive harmony or opposition by revolving the movable element. The effect is the same as though two coils were wound in a solenoid form and brought in different positions in regard to each other. When the coils were parallel the effect of the inductance would be practically absent because they would be working to aid each other. However, if the coils were so arranged that the current travelling through them was in opposite directions, the one coil would "buck" the other and there would be a noticeable tendency to choke off the current. Any position between the two extremes would produce a relative amount of, we might say, inductive bucking. The effect is the same as though we caused a stream of water in a pipe to develop a

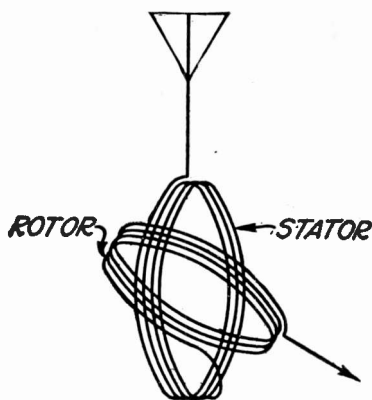

CONNECTIONS OF VARIOMETER

Figure MM: The method of connecting the two coils of a variometer is here shown. It will be noticed that there is a direct metallic connection between the aerial and the remainder of the receiving set. The variometer, however, is not always used in this particular position.

counter pressure. Since the counter pressure could not reach the original pressure (except by the interposition of a valve) some current would always flow. The same is the case with the variometer. Although the coils may be in inductive opposition, some current will always flow.

Variable condensers are widely used in tuning circuits because infinitely small changes in wavelength can be effected owing to the continuously uniform variations in capacity that may be made. It would be most difficult, both from the engineering and practical standpoint, to arrange a coil of wire so that the same effect could be produced inductively instead of capacitatively. For this reason condensers are practically always used in connection with coils. Coils are more or less necessary because they help to produce higher voltages, and, as we shall see later, this is very desirable.

If the student desired to set up a simple tuner involving a mere coil of wire wound around a cardboard tube and a small variable condenser, the apparatus might be connected according to the method in Fig. NN. Here the coil of wire has such a wavelength of its own that when it is used in connection with the aerial and the condenser changes in capacity will give a fairly large wavelength range. This wavelength range, as might be expected, will depend more or less upon the capacity of the condenser for the other elements have fixed values. If the capacity of the condenser is large the maximum wavelength will be large.

While involved in the general subject of tuning, it is desirable to introduce at this point the subject of wave traps. A wave trap is merely a circuit which permits of higher selectivity, that is greater separation between waves of slightly different length. The wave trap cir-

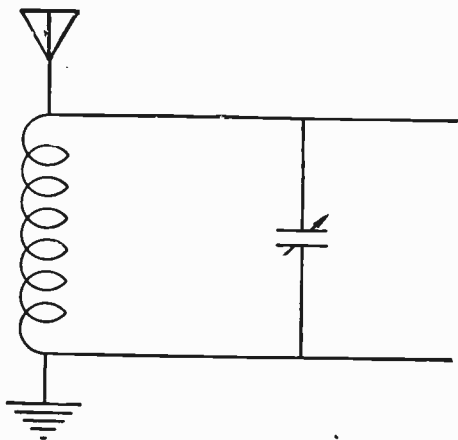

VARIABLE CONDENSER CONNECTIONS

Figure NN: A method of connecting a variable condenser to a single- or double-slide tuner to aid sharper tuning.

cuit, which consists merely of a small coil of wire (the coil may be of the ordinary honeycomb type) and a small variable condenser is interposed between the aerial proper and the receiver. By turning the condenser, the circuit will respond to the desired wave. Great

selectivity is obtained and waves of different length will be effectively prevented from passing. A switch is arranged so that the selector device may be dispensed with by forming a direct connection to the receiver.

A second system for trapping waves

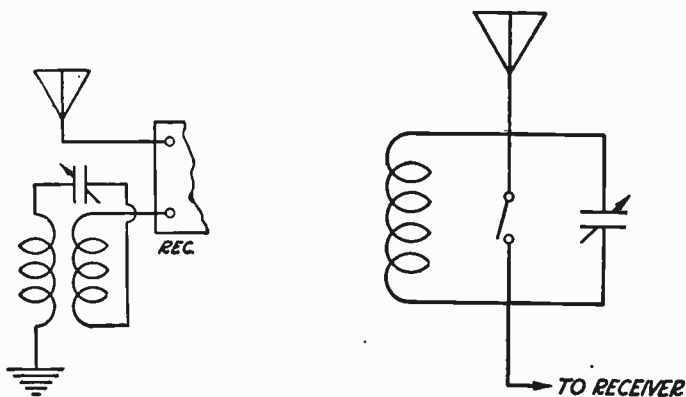

TWO WAVE TRAPS

Figure OO: At the left is shown a two-coil wave trap using a variable condenser. The trap at the right employs only one coil and a variable condenser.

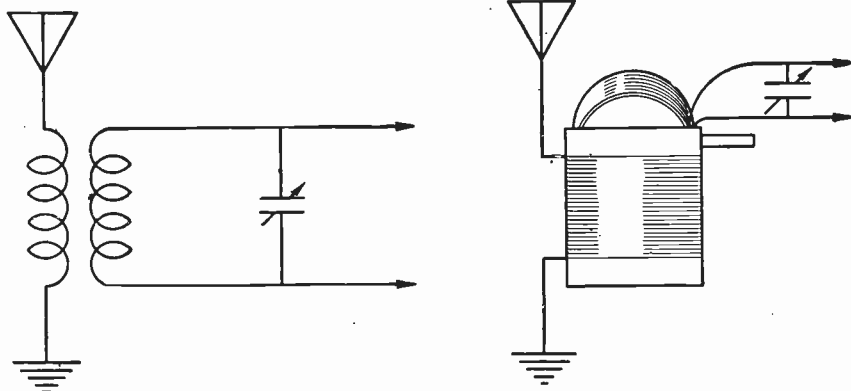

THE CONDENSER AND LOOSE-COUPLER

Figure PP: How the variable condenser is used as a tuning adjunct to the loose-coupler. The connections in both sketches are the same save that one sketch is diagrammatic and the other is in the form of a picture.

is also shown and here a variable condenser is employed with two coils of wire placed in such positions that their fields oppose each other. One system will be found to work practically as well as the other and perhaps the first one described is the most conveniently assembled.

When variometers or loose couplers are employed in tuning, condensers are usually used in conjunction with them. Otherwise, great selectivity is practically impossible because fine adjustments are not attainable. When a variable condenser is employed with a loose coupler, it is always placed directly across the secondary—shunted across the secondary. Changes in wavelength are brought about by turning the secondary of the loose coupler and by turning the movable plates of the variable condenser. When a variable condenser is used in conjunction with a variometer it is usually shunted across it as in the case of the loose coupler. Circuits like those just described are not highly efficient nor are they extremely selective.

Variable condensers are sometimes used in series with the aerial or ground. In this position they alter the wavelength of the aerial system by placing in series with the aerial capacity another capacity which may be small or large. The reader will recall the principle involved here if he gave proper attention to the explanatory matter in the fore-running portion of this Part.

There are many different ways of tuning aerial circuits but they all involve the simple principles that we have outlined. In some instances more complicated hook-ups are employed, but if the student will study them very carefully he will find that the combination merely involves: (1) loose coupled circuits, (2) directly coupled circuits and (3) circuits involving variable condensers.

Some receiving devices involve a number of independent circuits; circuits that are tuned. Even the simplest sort of a receiver usually involves two independent circuits as illustrated, Fig. QQ. Here we have what is known as the antenna circuit (sometimes called the *open circuit*)

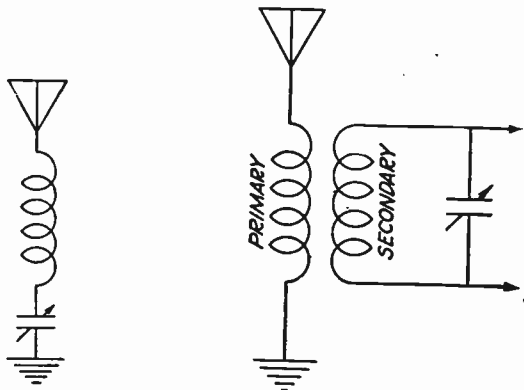

THE ANTENNA CIRCUIT

Figure QQ: The antenna or aerial circuit involves the aerial, the tuning instruments connected to the aerial and the ground.

which is technically incorrect) and the closed or secondary circuit. When a signal is tuned to, it is necessary to put the secondary or closed circuit in resonance with the antenna circuit before we can obtain a maximum transfer of energy between the two. That is very easy to understand. We could not hope to get maximum current transference between the two unless they were in electrical harmony; that is, unless one was capable of matching the electrical characteristics of the other. Coming back to our two stretched piano wires, we could not hope to cause one to vibrate at maximum efficiency when the other was plucked unless both the wires were of exactly the same length.

The famous Cockaday four-circuit tuner is a good example of multi-tuned circuits. Here four independent and distinct circuits are employed in a system of tuning which is extremely selective and which produces a very efficient method of broadcast reception.

The Hazeltine Neutrodyne is another receiver which involves more than one

independent circuit. In this particular receiver, it is necessary to bring three independent circuits to resonance with variable condensers before the receiver as a whole is in resonance with the incoming waves.

Unfortunately for the radio tinker, the really efficient radio receiver involves from three to six circuits and the tendency in technical development seems to be along complicated rather than simple lines. We say complicated, but, as a matter of fact, no circuit is complicated if it is studied out and analyzed in the light of the explanations given in this course.

The use of three or four independent and adjustable circuits in modern receivers has brought with it a demand for unification in control. It should be quite unnecessary for the radio listener to fuss around tuning several circuits independently when it is possible to mount the condensers controlling these circuits upon one shaft so that they can be turned on their shafts by a single knob.

Laurence M. Cockaday has prepared a thorough and at the same time simple discourse on the subject of single control:

"Up to three or four years ago the men and boys who were interested in radio receiving and transmitting apparatus were relatively few in number. Their interest was of quite an experimental and scientific nature.

"But with the advent of popular broadcasting and its development from that time to this, there have been literally millions of people who have been drawn into the radio game by either its recreational appeal or by its educational features.

"The vast majority of those who have been attracted to the field are broadcast listeners with little or no technical train-

ing and without much interest in scientific matters. However, these people have a lively interest in receiving apparatus, although they know little about its intricacies. It is, therefore, not extraordinary that the modern trend of receiver design is one of simplification in control.

"The early receivers that employed some of the more complicated and sensitive circuits contained, in some instances, as many as ten to fifteen tuning controls for selecting between signals transmitted on various wavelengths. During the last two years, however, the tuning of the more popular receivers has been reduced to not more than three to five controls. This means that most of the modern sets have no more than that many dials or knobs on the panel.

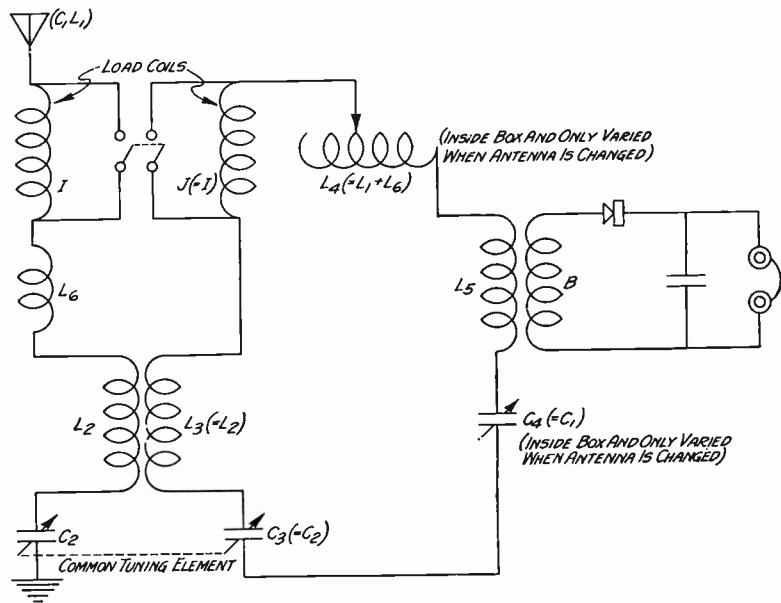

ONE OF THE FIRST SINGLE-CONTROL SYSTEMS

Figure RR. This wiring diagram demonstrates one of the earlier schemes for tuning two resonant circuits by means of a common capacity tuning element that is adjusted by a single knob.

"An interesting system that indicates great foresight and ingenuity on the part of the inventor, and a significant one, for reducing the number of controls in receivers, was devised some fourteen years ago by John V. L. Hogan, the well-known radio engineer. In his patent Mr. Hogan describes a method for tuning various circuits to resonance by means of a number of associated tuning elements mounted on a single shaft or controlled by a single dial although connected electrically in different circuits.

"The object of this scheme is, briefly, to tune a number of resonant circuits by rotating a single control knob.

"The significance of this method has only recently been apparent.

"In Figure RR we find a wiring diagram of the early Hogan single-control receiver that employs two tuned circuits that are controlled by a common tuning element. (See page 151.)

"The common tuning element consists of two variable condensers, C2 and C3, which, of course, must be of equal capacity and must contain the same capacity ratio of maximum to minimum.

These two condensers are arranged on the same shaft on which they revolve at exactly the same rate, and as the rate varies, the capacity of each one is always approximately equal to the other. The two inductances L2 and L3 are also of equal fixed values of inductance. The condenser C4, which was contained inside the receiver, was set only once to balance the capacity of the antenna. The coil L4, also a variable instrument that is inside the cabinet, is varied to equal the inductance of the antenna plus the inductance of the coil L6.

"In this early type of single-control receiver, when the two circuits were balanced up as indicated, the two condensers that formed the common tuning element could be rotated by a single knob and still the two circuits would be kept in resonance through the whole wavelength scale. When this condition was established, a practical single-control receiver was evolved.

"This specific instance demonstrates the idea of using condensers as a common tuning element.

"The inventor also described and used

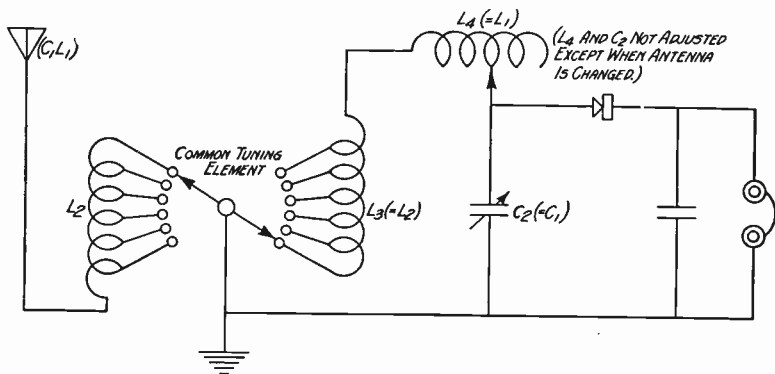

AN EARLY SINGLE-CONTROL METHOD FOR AN INDUCTIVELY-TUNED CIRCUIT

Figure 55. One of the early methods of tuning two resonant circuits by means of a common inductance tuning element that is rotated by a single dial or knob.

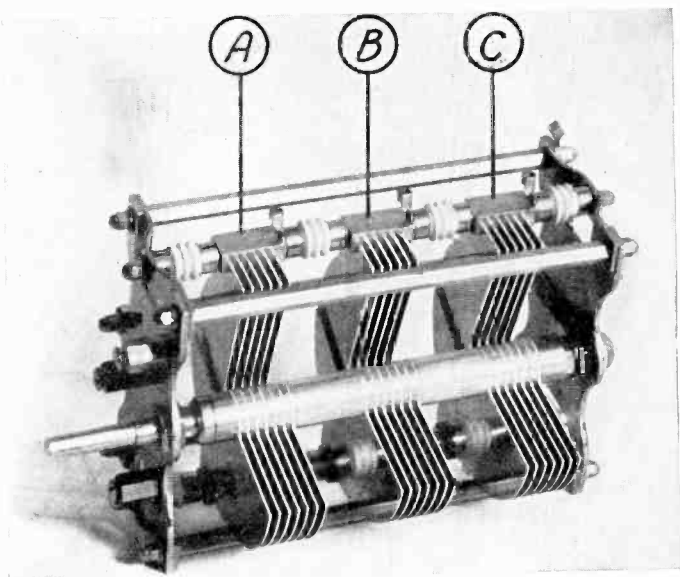

A TRIPLE-UNIT CONDENSER

Figure TT. This picture shows a triple-unit condenser. The three units A, B and C may be used for tuning three resonant circuits. This condenser would be suitable for a two-stage tuned radio-frequency receiver.

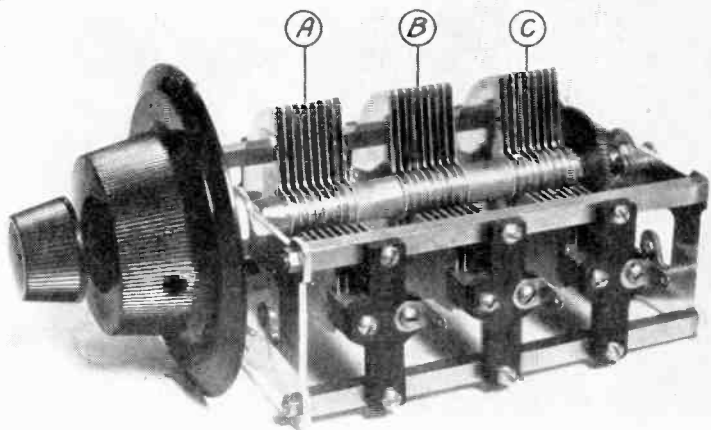

A TRIPLE-UNIT WITH VERNIER SINGLE-CONTROL

Figure UU. Another make of common tuning element, a triple vernier condenser, is shown here. In this unit, the three sections A, B and C are all controlled by the single knob. The insulation of the unit is composed of six pieces of hard rubber.

a circuit shown in Figure 55 in which he incorporated variable inductances as a means for accomplishing the same results. This receiver is shown diagrammatically in which the inductances in the two tuned circuits are varied in steps of equal amounts in both circuits by a single control knob. These two inductances are shown in the diagram as L2 and L3.

“Additional inductances and capacities L4 and C2 are used inside the cabinet and these are adjusted only when the set is first connected to a new antenna. These two elements are used to compensate for the capacity and inductance of the antenna indicated as C1

and L1. When this initial adjustment has been made, the various wavelengths may be tuned in by adjusting the inductance tuning-element knob.

“Either of these two simple plans for obtaining a single-control receiver may be used with the more complicated and effective receivers, such as used today.

“During the last five years most of the engineering work on receiving sets has been directed toward circuit development, and, during that time, we have had four major types of circuits which have come into general use. These may be enumerated as follows:

1. Regenerative circuit;

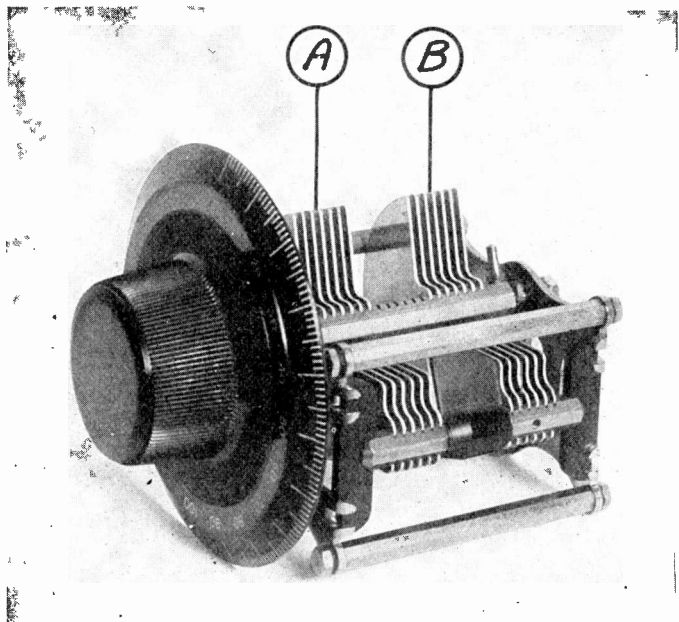

A DOUBLE-UNIT FOR SINGLE-CONTROL

Figure 56. This picture shows a double-unit condenser which consists of two units A and B. This unit can be adapted to a single-control, four-circuit tuner or a single-control superheterodyne. It could also be used for tuning a single-stage, radio-frequency receiver.

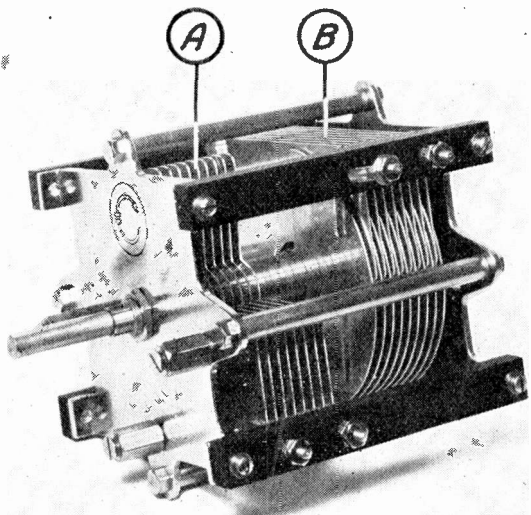

A LARGE CAPACITY DOUBLE-UNIT

Figure WW. This double-unit is also composed of two condensers A and B mounted on the same shaft.

2. Transformer-coupled, radio-frequency circuits;
3. Tuned radio-frequency circuits;
4. Superheterodyne circuits.

“The development of receivers along these four lines has been merely a refinement of circuit design and circuit stabilization. This work has resulted in some really excellent receivers and in some cases, the ease of control has been greatly improved over the earlier circuits of the same classes. The second class, No. 2, we can neglect, as only one circuit is tuned. However, by the application of the Hogan scheme to the other three of these types or classes of receivers, a receiver will be produced that the least informed novice can tune with ease. Such a receiver will contain only a single knob for adjustment, and it will give better results than the more

complicated sets in the hands of the ordinary broadcast listener.

“An application, then, of this scheme will be the most important single factor in the future development of sets; and it will make radio really accessible to the average American.

“The first step in modifying these types of receivers to combine and unify the tuning control, is to select the type of mechanical arrangement to be used. There are three general methods that can be employed:

1. The use of a combined shaft;
2. The use of a gear arrangement;
3. The use of a belt arrangement.

“All three of these methods present specific advantages and problems. In Figures TT, UU, VV, WW, ZZ are shown a number of makes of multiple condensers that embrace the combined shaft

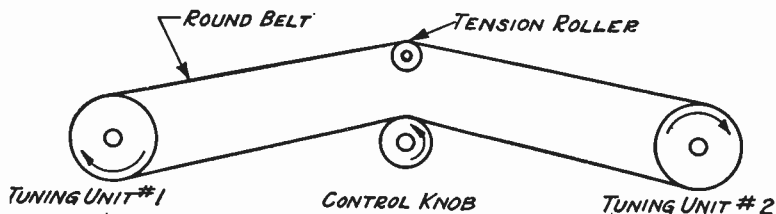

A BELT-OPERATED CONTROL SCHEME

Figure XX. Another method that has been used for the single control of two units. The control knob rotates the units in synchronism by means of a belt and rollers.

principle. All four of these are of the finest workmanship and construction, and are being used in the newest types of sets that are built by some of the more forward-looking manufacturers.

"The utilization of the second method allows for the use of separate condensers or inductive tuning units of the ordinary type with the familiar 'rack and pinion' coupling between shafts. This scheme is shown diagrammatically in Figure YY. With this arrangement it is extremely important that the train of gears fit snugly and that there be not too much friction.

"The third arrangement, which also has its supporters, employs separate condensers or inductive-tuning units which are caused to turn in unison by means of rollers and a belt.

"An idler pulley is usually used to take

up slack so that the belt will not slip and thereby keep the units in proper relative position to each other. This method is shown diagrammatically in Figure XX.

"Any of these methods may be employed, but for personal preference and simplicity of explanation we will consider only the first one.

"There are not many regenerative circuits that permit the application of the principle of single-control. The one regenerative receiver that probably stands out as the most suitable for such use is the Four-circuit Tuner.

"In this type of receiver the two circuits that control tuning and regeneration are rotated in unison. Both dials are rotated throughout the wavelength range at the same rate and both should always read the same in dial settings.

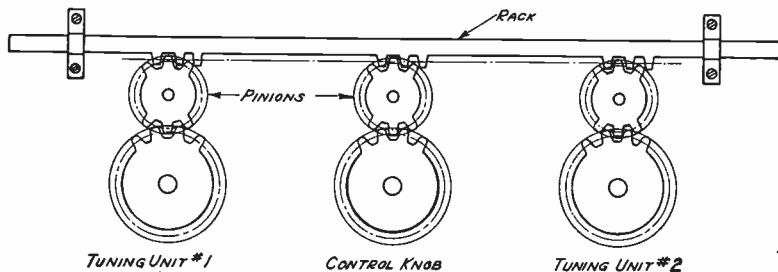

A RACK AND PINION CONTROL SYSTEM

Figure YY. A method for controlling two tuning units by means of a rack and pinions. The control knob is indicated as attached to the center gear.

“By using a double-unit condenser combination in place of the usual two condensers, the two circuits (the stabilizer and the secondary) may be adjusted by a single dial. This is shown diagrammatically in Figure B3. C1 would be one section of the condenser and C2 would be the second section. These would both be mounted on a single shaft and rotated in unison.

“The application of the single-control idea to the tuned radio-frequency circuit is almost as simple as its application to the Four-circuit Tuner.

“In Figure A3 are shown the primary and secondary coils which are used to couple two stages of amplification. Connected across their secondaries are variable condensers C1, C2 and C3, in the usual manner, except that these three condensers have a common shaft and a single dial as indicated by the dotted

lines and the arrows. This arrangement is for condenser-tuned receivers.

“For inductively-tuned receivers of the tuned radio-frequency type, the general layout or scheme might be as shown in Figure C3. Here the common tuning element is composed of a variable inductive winding. These are shown in the diagram as variometers at L1, L2.

“Stating the method generally, the two tuning elements C1, which controls the loop tuning, and C2, which controls the oscillator tuning (see Figure D3) can be arranged, by choosing the right values of inductance in the circuit, so that they will vary with the wavelength substantially at the same settings. This means that they can be also connected by the same shaft and controlled by a single dial. Any slight variation at the ends of the scale can be adjusted easily by a vernier variometer or other vernier

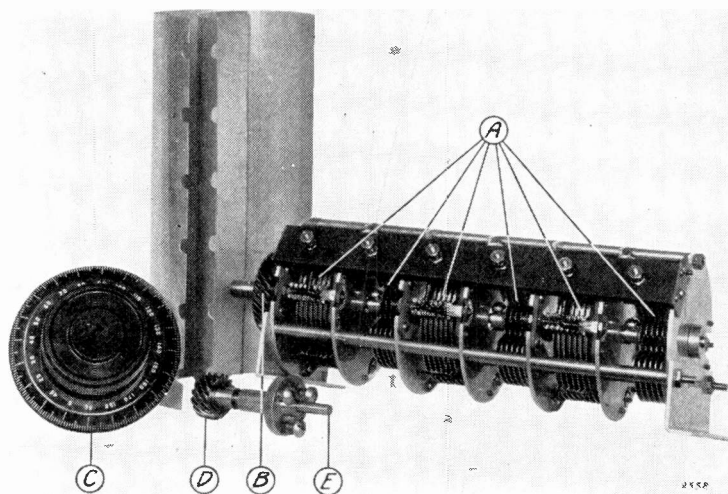

A SIX-UNIT, SINGLE-CONTROL CONDENSER

Figure ZZ. A complete unit consisting of six condensers A which are all fitted to the same shaft and controlled by a single dial C. The dial is attached to an auxiliary shaft E which operates the condensers through the bevelled gears D and B. Six resonant circuits may be tuned with this single unit.

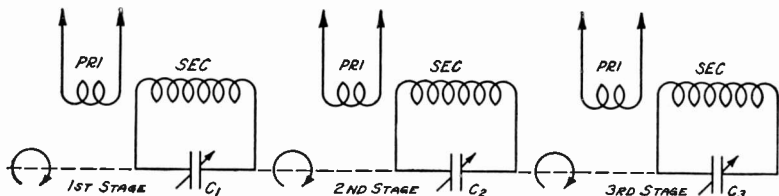

HOW THE SINGLE-CONTROL CAN BE APPLIED TO A TUNED RADIO-FREQUENCY CIRCUIT

Figure A3. This diagram shows how the tuning of a two-stage, tuned radio-frequency receiver may be reduced to a single-control. The three condensers, C1, C2 and C3 are mounted on the same shaft and are controlled by a single knob or dial.

device as indicated in the diagram at LV. One engineer has already experienced very fine results from such a combination.

"In summing up, we find that the single-control idea for controlling the more complicated, and therefore the more sensitive and selective circuits, has a number of great advantages and strong points not among the least of which we have found to be:

1. The simplest method of tuning;
2. The calibrated or "logged" dial;
3. The speediest method of tuning;
4. The most accurate method of tuning;
5. Elimination of body capacity;
6. Better looking sets;
7. Sets that the novice will not hold in awe;
8. Much better sales value.

"The simple tuning, including the calibrated feature that tells the user at just what point to set the one dial to bring in the station wanted, is sure to be popular. Besides, a set that a novice can tune as readily as the experienced radio fan is a great development.

"Finally, sets that do not have so many 'little dials and knobs and gadgets' to turn, to make squeals with, and to collect dust, are sure to be more popular with the women and the children and the man without technical interest.

"In other words, in single-control receivers we will have the first sets that will enjoy an overwhelming popularity with the larger public consisting of men, women and children who want to listen

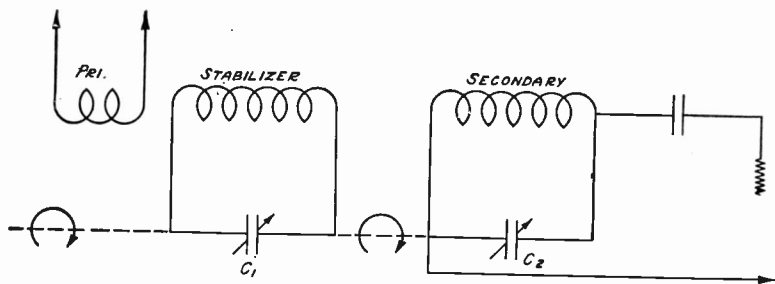

SINGLE-CONTROL ADAPTATION FOR A FOUR-CIRCUIT TUNER

Figure B3. The control method shown in this diagram indicates how two condensers C1 and C2, when mounted on the same shaft and controlled by a single knob, can be employed in a four-circuit tuner.

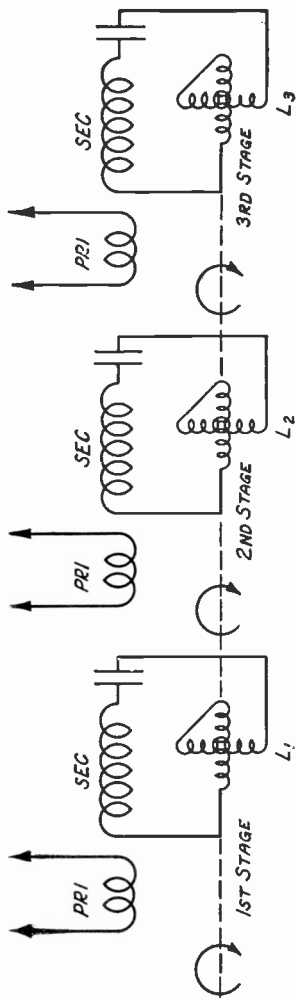

SINGLE-CONTROL APPLIED TO AN INDUCTIVELY-TUNED RECEIVER

Figure C3: A method whereby a tuned radio-frequency receiver may be tuned by means of three variable inductances, L_1 , L_2 and L_3 mounted on the same shaft, and controlled by a single dial.

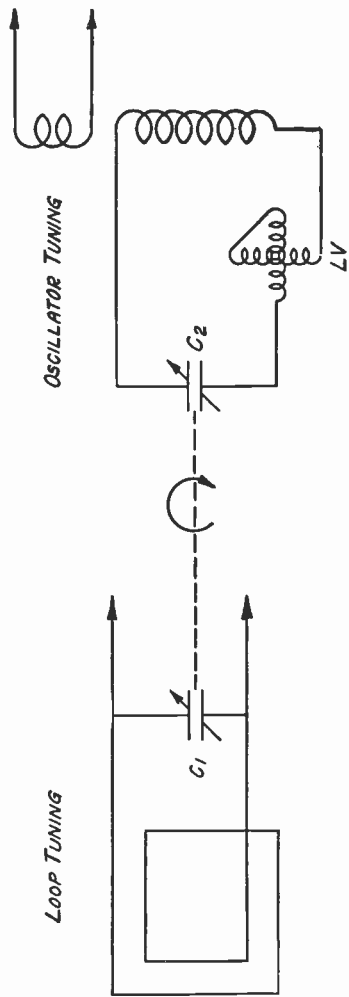

HOW SINGLE-CONTROL MAY BE USED IN THE "SUPER"

Figure D8: This diagram shows how the loop tuning and the oscillator tuning in a superheterodyne receiver may be simplified. The two capacitors C_1 and C_2 of the proper capacities may be mounted on the same shaft and controlled by a single-dial. In this case, however, a small variable inductance unit LV should be used for exact settings on distant signals.

without any fuss and without having to study technical information before they learn the particular tricks of the particular make of receiver they happen to own.

"These are the reasons why the angle-control receiver is fast coming into vogue and why it will stay."

It is of importance that the student should understand the proper use of knobs and dials on radio receivers especially in connection with tuning appli-

ances. The average set owner believes that tuning is a mere matter of turning knobs until some station is accidentally picked up. It is impossible to intelligently tune any kind of a receiver unless the person manipulating the knobs and dials has some understanding of the instruments back of the panel and their position in regard to the dials with which they are connected.

There are two general types of dials in use today; one is calibrated from 0 to

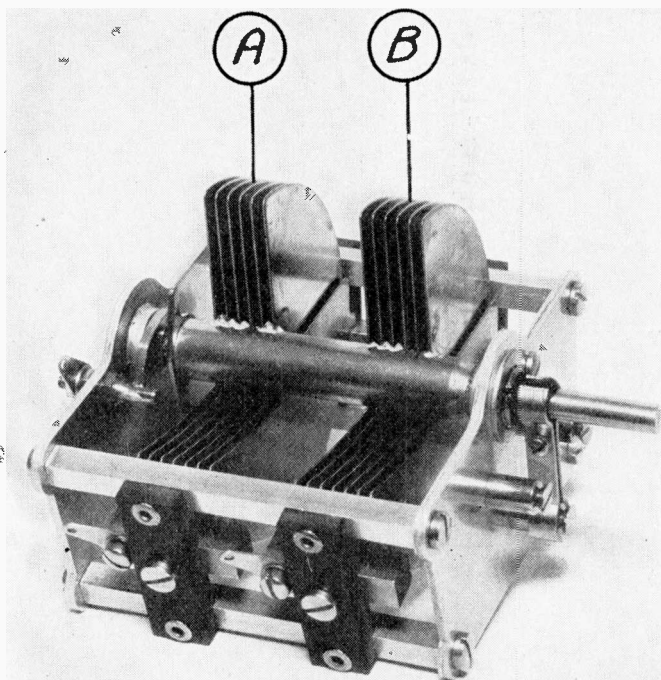

A DOUBLE-UNIT WITH STATORS MOUNTED ON HARD RUBBER STRIPS

Figure E3. The double unit condenser pictured above has two units, A and B. The stator plates are mounted on two strips of hard rubber insulation; both of the rotor sections are mounted on the same shaft. This unit may be used in the same manner as the two units shown in Figures E and F.

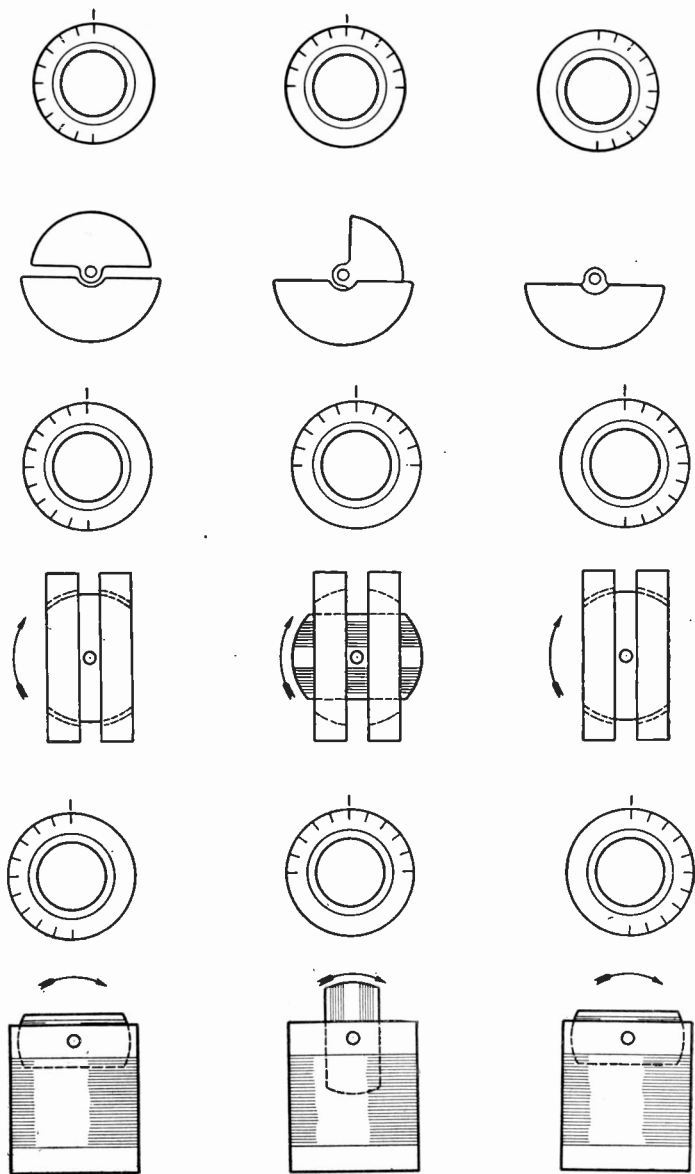

THE MEANING OF THE DIAL POSITION

Figure F3: This diagram shows how dials should be employed with the various tuning instruments as a check upon the operation of a receiver. Either 100 degree or 180 degree dials may be used.

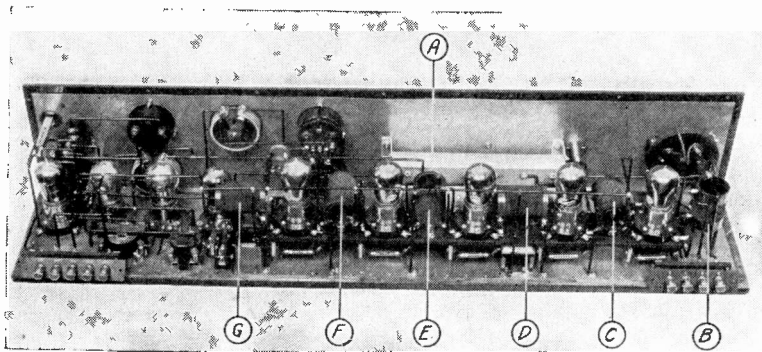

A RECEIVER WITH ONE DIAL THAT TUNES SIX CIRCUITS

Figure G3. This picture shows a rear view of a super-pliodyne receiver in which the multiple tuning unit shown in Figure ZZ is used. This unit appears at A, and is enclosed in a metal shield. It tunes simultaneously the six transformers B, C, D, E, F and G, which are connected to as many stages of radio-frequency amplification.

100 and the other, more scientifically perhaps, from 0 to 180 degrees. Then, of course, we also have dials with micrometer or vernier attachments. It is the function of these attachments to turn the shaft of the instrument only a very small distance compared with the distance that the vernier is moved. Most of these combination dials with the vernier have two distinct knobs, one that turns the shaft direct and one that works through a small train of gears to turn it very slowly. Verniers are more or less essential in the case of long distance work and when used with very selective receivers. Oftentimes a movement of 1/100th of an inch is necessary to bring the wave to a point of full resonance. It will be found in general that verniers are practical only when used in connection with variable condensers.

By reference to Fig. F3 we see the position taken by the movable plates of the condenser when the dial is turned half way around. When the movable plates are fully inter-leaved with the stationary plates, the reading on the

dial should be 100 in the case of a zero to 100 dial, and 180 in the case of a zero to 180 dial. At the half-way mark (50 or 90) the plates of the condenser should be exactly half way. When a dial is used in this manner it acts as a true index to the angle taken by the plates and figuring from this the operator of a circuit will have a rough idea of the amount of capacitance at every setting.

The proper dial setting for loose coupler secondaries is also illustrated. At zero degrees, the rotor or secondary of the loose coupler should be perfectly horizontal so that there will be a maximum inductive effect between it and the primary. At 50 or 90 degrees the secondary or rotor winding should be at right angles to the primary winding and the inductive effect at this point will be minimized. As the dial is revolved the rotor is brought back to its horizontal position.

Reference should also be made to the little sketches showing the proper use of the dial with the variometer. In a case of this nature, there is a uniform change in inductive relationship between the

rotor and stator windings as the knob is turned toward its full number of degrees.

Radio folks—professionals and amateurs alike—have long talked about “dead spots.” Experience has shown that there *are* certain stretches of coastal territory and mountainous areas where it is extremely difficult to effect reliable communication in the conventional manner. But always the term “dead spot” is a relative one only; a “dead spot” being due to the partial absorption of the electromagnetic waves.

A well-known example of this phenomena lies in the inability of ship stations in Long Island Sound to establish satisfactory communication with shore stations on the Atlantic side of the Island, even though the Island is, at its widest part, but forty miles across. Coastwise vessels find great difficulty in communicating with New York City in a satisfactory fashion over distances of but fifty or sixty miles when they are close to the Jersey shore.

An example of this phenomena which deals with transmission on amateur wavelengths may be cited as follows:

A first class amateur transmitter in New York City finds it possible to communicate directly with a like amateur station in Philadelphia, ninety miles distant, during daylight hours. When darkness falls, the signals of the Philadelphia station become unreadable until late in the evening, and are even then unreliable.

Radiophone listeners, too, report “dead spots” in various localities. In Atlantic City during the summer months it is possible to secure fairly good broadcast programs both from New York and Philadelphia during daylight. At night, however, programs from both points are unreliable. Many points on Long

Island, forty to seventy miles distant from the New York City stations, frequently find it impossible to record satisfactory broadcast programs.

During the summer of 1920, an effort was made to take advantage of this phenomena in the choice of sites for stations which were to handle the commercial traffic along the Atlantic coast. During the war the Navy department handled all ship-to-shore traffic, inasmuch as all land radio stations had passed into their hands when war was declared. Subsequent to the Armistice this traffic was handed back to commercial companies. Considerable competition then existed between the older and some newly formed companies as to who should handle the bulk of it. There proved to be a sufficient amount of traffic to make its handling profitable. At least four companies who owned and operated stations within the vicinity of New York were each making frantic efforts to get the better of the other. The most serious difficulty encountered was that of interference between the sending stations.

To be specific, one station at Cape May, New Jersey, two in New York City, one at Babylon, L. I., one at Southampton, L. I., one at New London, Conn., and one on Nantucket Island, frequently tried to establish communication with the same ship at the same time, particularly when that ship would report 200 or more messages ready for transmission. Perhaps one of these stations would receive an acknowledgment from the ship operator whose efforts to get the traffic off were frequently rendered futile because of the interference from the competing stations. Loop aeri-als and receivers of various types were tried with but little relief.

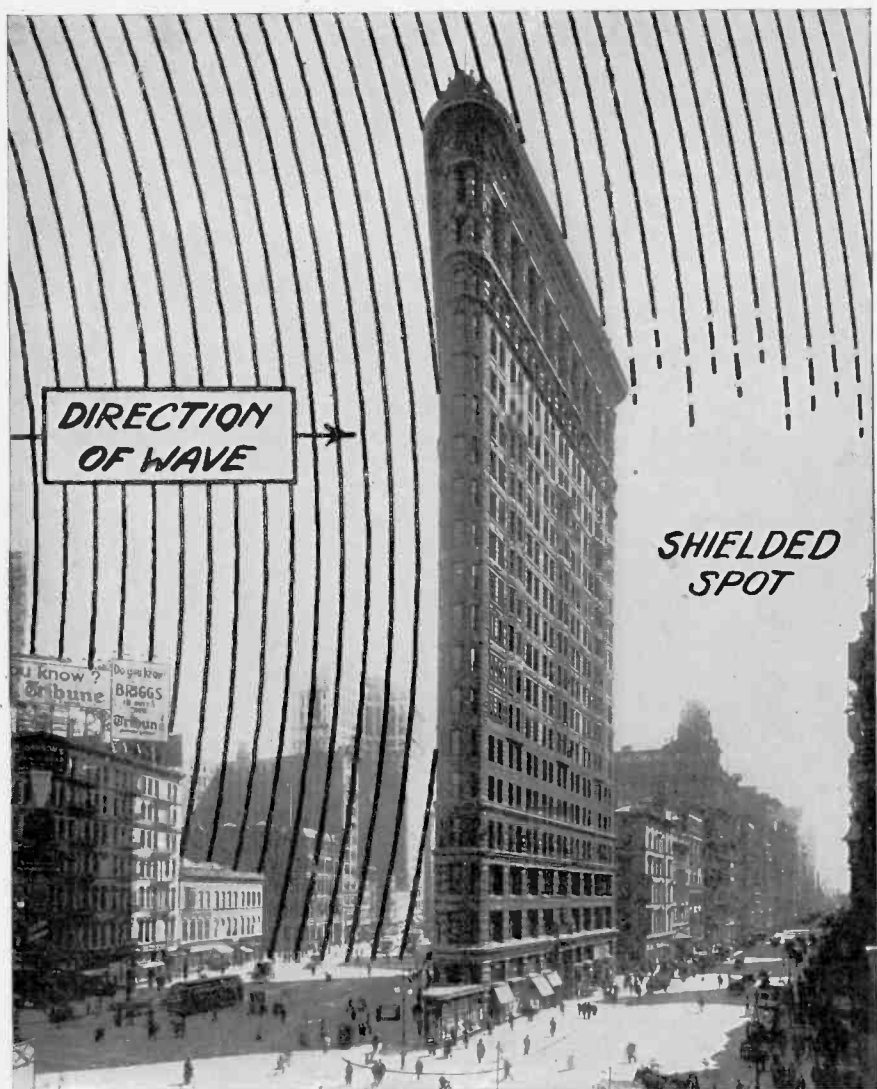

Brown Bros.

HOW "DEAD SPOTS" ARE CREATED

Figure H3: Usually the cause of the trouble is a wall—especially a wall in the form of a building that is largely of metal construction—between your radio receiver and the broadcasting station. Such a structure serves as a shield that deflects the radio waves in much the same way as a ten-foot fence serves as a shield when it intervenes between two men who are conversing. An ordinary crystal or single-tube receiver is usually insufficient to detect the weakened radio waves that do penetrate the shielded areas.

The idea was then hit upon of locating certain points on the North Atlantic coast which would provide comparative freedom from most interfering land stations. The method of locating these "dead spots" proved to be rather ingenious and interesting; to the gratification of those in charge of operations, locations were found where interference

from many stations was almost entirely eliminated.

In one of the illustrations which accompany this article (see this page) is shown a super-heterodyne type of receiver mounted in a Ford sedan. The receiver consisted of a three-element vacuum tube detector, a frequency changer, and a four stage - radio - fre-

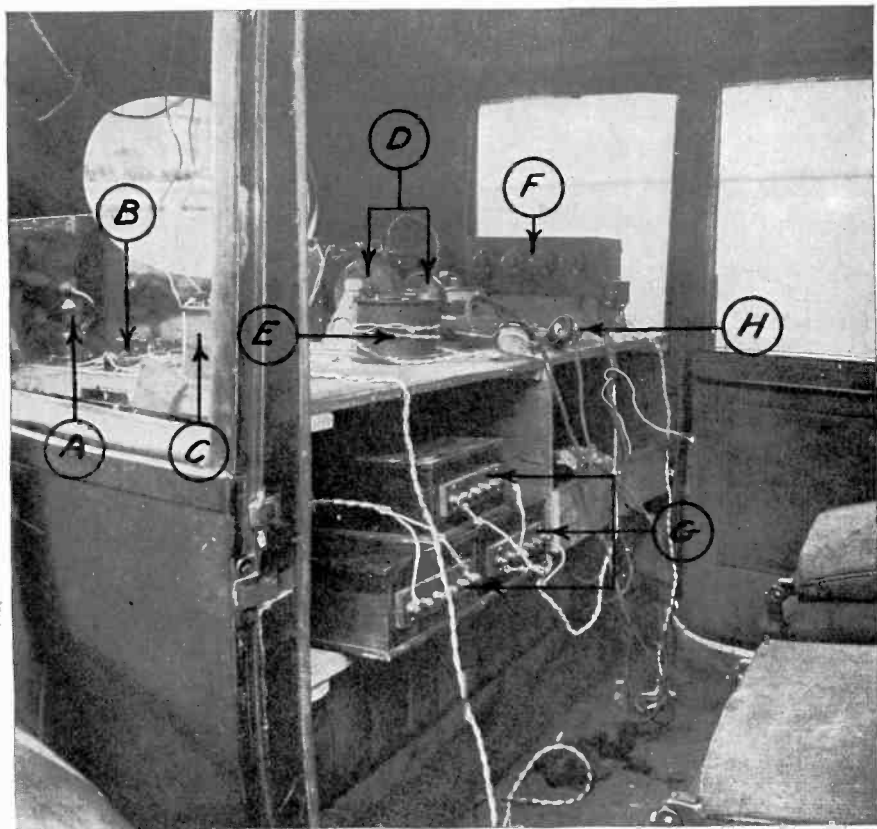

THE INTERIOR OF THE RADIO SLEUTH

Figure 13: This extremely sensitive receiving apparatus, which was installed in a small sedan, included: A, the vacuum tube used for detection; B, the rheostat for this tube; C, the tuning condenser; D, the honeycomb inductances; E, the heterodyne control; F, the radio-frequency amplifier; G, the "B" batteries for the detector, oscillator and amplifier. And, of course, the telephone receivers H.

quency amplifier. The car lighting battery was used for all vacuum tubes. However, separate plate potential batteries were used respectively for the detector, the frequency changer (oscillator) and the radio-frequency amplifier. The circuits of the amplifier were so arranged that the signals could be weakened; that is to say, a certain type of audibility meter was provided. The antenna used consisted of twenty turns of wire on a wooden frame, four feet on a side. The antenna (loop) was so mounted on a rear fender that it could be revolved until pointing toward the transmitting station. Signal strengths obtained with this outfit were equivalent to those which could be obtained on a "T" type antenna, 160 feet high, in conjunction with a single vacuum tube detector and regenerative receiver.

Upon careful study of a topographical map, a point was generally chosen so as to be shielded from the transmitting station by low hills, a rather dense forest, or by a stretch of coast line. Past experience had shown that these usually acted as a shield. At a point near East Moriches, L. I., signals from New York City stations and from New London, Conn., were found to be almost totally inaudible, while signals from the station at Babylon, L. I., were reduced to the point where they would be of no serious trouble. At Smith's Point, some one mile farther toward the Sound, signals from the New York stations, the Babylon station as well as the New London station, were about up to standard. In both positions, signals from out at sea were equally strong. At the Smith's Point location, however, signals from great distances were recorded, as it was possible to read the signals of ships well out at sea and entirely beyond the range

of communication of any of the land stations mentioned previously.

As the result of observations in this locality, a receiving station was planned and finally erected. On Cape Cod a point was found near North Truro, Massachusetts, where signals from Boston and Chatham stations were materially reduced. It became necessary at this point, however, to fall back upon large sand dunes for the shielding effect, and an extremely interesting phenomenon was discovered; a movement of the receiver of only a few hundred feet in either direction caused a marked difference in the strength of signals that came from land stations, while practically no change in signal strength was to be observed in the signals that originated at sea.

Observations taken near the station at New London, Conn., pointed to considerable shielding of this same sort. While signals from New York City stations came in with considerable strength, signals from Long Island and from stations on Cape Cod and near Boston were weak, whereas signals from all vessels in the Atlantic lines came in with what seemed to be doubled strength. It is certain that the exceptionally good work which the station at New London (WLC) has always done is thus accounted for.

It was desirable to locate a third station on the coast of Maine; for this purpose an extended series of observations were taken between Bar Harbor and Eastport. In addition to natural shields or barriers against radio signals from coastal stations, it became necessary in Maine to look, first of all, for a source of power supply. This existed at but few points along the coast. Observations taken at or near Rockland indicated exceptionally good shielding

from all transmitters with the exception of the Naval station at Bar Harbor. Ocean-going vessels in the Atlantic lines could be received at this point with great clearness. The Bar Harbor station, however, was a serious drawback and after many experiments along this part of the coast, a point was found near Harrington, Maine, where shielding from both Bar Harbor and Rockland was ideal. Some weakening of signals from ocean-going vessels was to be noticed, however, due, no doubt, to the absorption taking place while the signals were in transit across Nova Scotia.

It has long been presumed that hills absorbed or deflected radio signals. Frequently mountains cast decided shadows; so do forests in lesser degree. In the case of the forest, absorption plays the greatest part in the weakening of

the signal. Where a chain of mountains exist, the shadowing effects may become quite complex. This is also usually true in the larger cities, due to large steel structures, and is particularly noticeable where communication is being attempted upon the shorter wavelengths. The shorter the wavelength the more pronounced the shadowing effect, for the size of objects such as mountains and groups of trees and tall buildings are of the same order as the dimensions of the radio waves. Where the length of the wave is several thousand meters, few mountain ranges are to be found whose dimensions are sufficient to render them other than relatively small objects in the path of the wave.

Large bodies also act as reflectors.

An instance of this is on record. An attempt was being made to receive a sig-

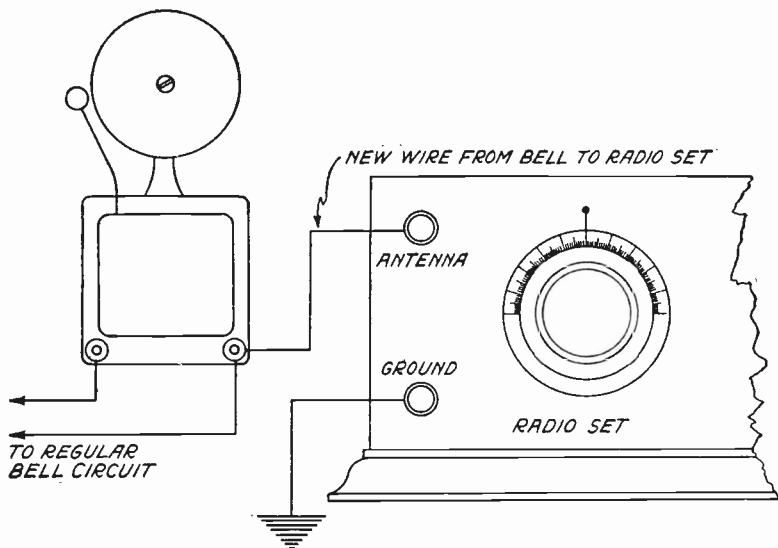

THE WIRING DIAGRAM FOR THE BELL CIRCUIT ANTENNA

Figure 13: When you connect the antenna binding post on your set to the nearest bell, be careful to try both binding posts on the bell and leave the wire permanently connected to the side that brings in the signals with the greatest intensity.

nal from a point directly away from a mountain. The signal from the distant station was considerably weakened by bringing the receiver within approximately one and a half wavelengths of the mountain. It is to be assumed in this case that energy reflected by the mountain back into the receiver, arrived there completely out of time with the oncoming wave. The reflected wave counteracted the incoming wave with the result that signals strength was weakened.

Complete information concerning the effects of various objects upon the transmission of radio energy is not now available. When it is, it should be possible to definitely plot the rise and fall of signal strengths over any particular territory. There is little doubt that the "fading" effects observed by so many broadcast listeners are caused by the reflection of the electric wave from layers of gas many miles above the earth. The assumption is that the energy travels up and through the earth's atmosphere to a layer of ionized gas—that the gas reflects the wave, sending it again earthward—that in its travel the wave has encountered nothing which tends to absorb its energies. Suddenly a vapor cloud or a flaw in the reflecting mirror results in the absorption or loss of the signal. These irregularities occur rapidly at short wavelengths in mountainous or hilly countries—less rapidly over level country and at sea, but, under given conditions, the frequency of the fading intervals is a function of the wavelength.

It sometimes happens that, on account of circumstances over which the radio fan has no control, it is not pos-

sible to put up an outdoor antenna which will be suitable for the reception of broadcasting.

Here is one way to overcome this difficulty; it will enable one to receive broadcasting by making use of the ordinary "bell" circuit in the house. In every apartment house there is usually a front door bell and also a buzzer in the kitchen, which is connected for use in the dumb-waiter. This latter circuit makes a good antenna because it is not used as much as the front door bell. As a slight buzz will be heard in the receivers every time the button is pushed, and as the door bell is apt to be rung at almost any time, the dumb-waiter buzzer is the more serviceable of the two.

Using one side of this circuit will not harm either the bell circuit or your receiver. Even when the buzzer or bell is rung, it will have no effect on the set, except that a noise will be heard.

To connect the radio receiver to such an antenna is simple. Loosen up one of the binding posts on the buzzer or bell and connect a wire to it. The other end of this wire should be run down to the antenna binding post on the radio set. In connecting this wire to the buzzer, one must be sure that the wire which was already on the binding post of the buzzer is put back in place, otherwise the buzzer will not ring.

Of course, it is not possible to receive much DX on an antenna of this sort but if circumstances are right, some surprising results may be had. On local broadcasting stations, the signals should be almost as loud as with the outdoor antenna.

END OF SECTION V

SECTION VI

Detection and the Secret of the Vacuum Tube

IF Nature had made our ears sensitive to the higher vibrations, radio development would have taken a different course and many of the elaborate devices that we now use would be wholly unnecessary. It has often been demonstrated that the average human being is incapable of hearing vibrations with a frequency of over 20,000 per second. This means that we could be in the midst of the most terrifying source of sound waves but that, if these waves were beyond 20,000 cycles a second, we would have no sense of their being present.

This shortcoming of the human ear makes it necessary to employ what is known as a detector in the reception of radio music and code signals. From our previous investigations into the realm of radio, we know that the currents used in radio transmission are of very high frequency. So high indeed that if we permitted them to pass directly through a telephone receiver, we would receive no indication of their presence. The diaphragm of the telephone receiver, having appreciable mass would, in the first place, be unable to respond to the madly fluctuating currents and should the diaphragm respond, the human ear would be insensitive to the air vibrations produced.

Let us see what kind of a current is produced in a receiving set when it is in

tune with a radio transmitter of the spark type. Of course, we know that sparks are used only in the transmission of code and not for the carrying of voice or sound. Sparks produce damped waves. That is, wave trains that start out at high amplitude and rapidly diminish to zero. If we were to picture these waves graphically they would look something like the outlines given in Fig. A (right). The wave starts out freshly, reaches a high maximum amplitude and gradually tapers to zero. Although the amplitude *decreases* the student will see that *the wavelength remains the same*; that is the distance between the peaks.

These damped wave trains come very rapidly; so rapidly indeed that a telephone receiver placed in their path would be useless in detecting them. What we need in cases of this nature is some sort of a device that will have the effect of changing the frequency of these extremely agile waves. In other words we wish to bring them from the *inaudible* or supersonic range of vibrations down to the *audible* field where they can be heard and distinguished by the human ear.

It was known for a long time before radio was put into commercial use that certain natural minerals like galena and zincite possessed the properties of *unilateral conductivity*. This term is not so formidable when we are told that uni-



HOW A CRYSTAL TREATS AN OSCILLATING CURRENT

Fig. A. A crystal is a sort of "valve" that permits electric current to flow freely in one direction but cuts off the flow in the opposite direction. This diagram clearly illustrates the action. The current pictured at the left builds up what is known as a "damped wave." Thousands of such "wave trains" go to make up a single dot of the telegraphic code. So rapid do these pulsations come that some means must be employed to make them audible. The crystal detector does this as illustrated on the right. Instead of the pulsations in each wave train affecting the diagram of the 'phones independently, they produce a combined effort which causes all the pulsation in a single wave train to make but one of the several hundred vibrations in a single dot of the telegraphic code. Thousands of these tiny "noises" would be in a long dash.

lateral conductivity simply means *electric conductivity in one direction*. When current is sent through an ordinary copper wire, the direction makes no difference in the resistance; it is the same either way. However, in the case of a crystal like galena we find a different condition. Galena does not obey Ohm's law in both directions. In one direction the current will obey the laws of Ohm and flow through meeting little resistance. When the current is reversed in its direction, there is immediately placed in its path a huge block of resistance that practically chokes it off entirely. No one can explain this action although many physicists have attempted to reveal the mysteries that surround it.

Now let us see what would happen if we should interpose a small piece of galena in the path of a rapidly vibrating and highly damped current such as that we considered in Section IV. The impulses travelling in one direction would pass through the galena freely, but the impulses travelling in the opposite direction would be effectively choked off. As a result of this action we would have

a series of direct current impulses as shown in Fig. A (left). Since the frequency of vibration would be only cut in half the telephone receiver would still be insensitive to them. However, each group of pulsations act as a unit and they have an accumulative effect upon the diaphragm. The three pulsations shown combine to cause the diaphragm to move once, that is they pull the diaphragm of the telephone receiver down and release it. So rapid are these pulsations that several thousand of these little *wave trains* must exhaust themselves against the diaphragm to cause one tiny dot of the telegraphic code to be made.

A crystal detector is a very simple arrangement. It involves only a small holder which will allow high frequency currents to pass through the active mineral. A number of different minerals are used for crystal detectors but silicon, carborundum, galena and borite are among the most common forms. Galena is one of the most popular because it is the most sensitive. It is usually placed in a small metal container and a tiny wire known as a catwhisker is brought

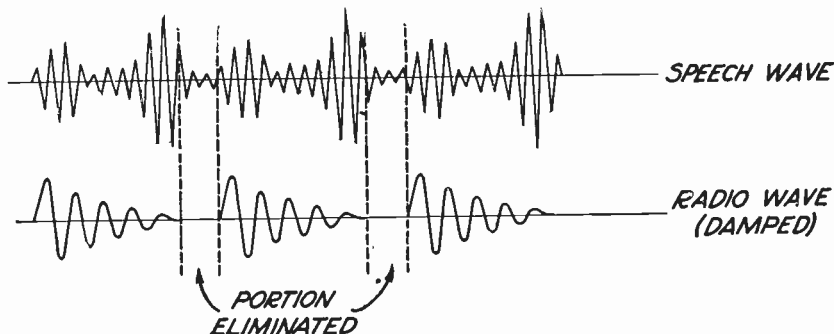

FIGURE B

This diagram shows why it is impossible to impress a continuous sound wave upon a series of damped waves. The intervals between the damped waves would be silent and unintelligible sounds would be produced in the distant receiver.

into contact with its surface. This wire leads the high frequency current into the crystal and is also used to find the most sensitive spots. With this type of detector it is necessary to constantly readjust the catwhisker to insure maximum sensitivity. The passage of large amounts of static electricity from the aerial tends to burn the detector point out of adjustment and sudden shocks or jars will be found to disturb its sensitivity.

Strange as it may seem to the student of the art, the simple little crystal, with all of its troubles, is the one perfect reproducer of the sounds transmitted by radio waves. It is a most efficient rectifier. (A rectifier is a device that will produce a pulsating direct current from an alternating current.) Although a most efficient rectifier the crystal is in no sense an amplifier. As a matter of fact, it is a very wasteful rectifier and unless a very sensitive pair of 'phones is used in connection with it, reception is impractical. If the telephones are sensitive, a crystal detector may be used for the reception of broadcast music over a distance of 25 miles. A use has been found for crystal detectors in reflex re-

ceivers and a few permanent types have been developed for this purpose. Here the crystal is employed as a detector and the input and output circuits are amplified. The current is amplified before it passes into the crystal and it is amplified after it passes out of the crystal. A very practical form of carborundum detector of the permanent type has been developed for reflex work.

When we bring back to mind the jagged damped waves that we considered at the beginning of this Section, we will understand that such waves could not be employed in the transmission of voice and music. A reference to Figure B will show why this is so. Sound waves produced by the human voice and by musical instruments have a continuity of flow and if such sounds were superimposed upon damped waves part of the sound waves would be entirely eliminated at the receiving end. We would have as a result nothing but a garbled confusion of incoherent sounds.

Spark transmitters of any type cannot be used to carry broadcast music. We must use what is known as a continuous wave. That is a wave that flows continuously without the crude interrup-

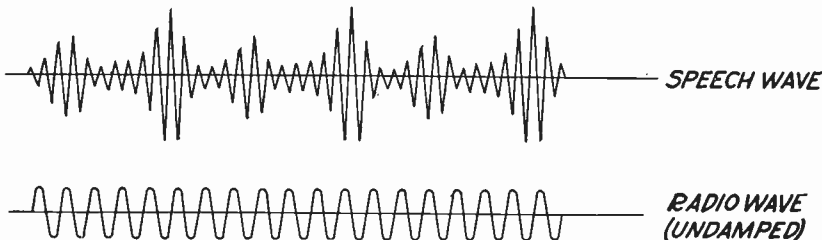

THE UNDAMPED WAVE AND THE SOUND WAVE

Fig. C. The undamped radio wave illustrated at the bottom of the drawing is necessary for the transmission of sounds. It will be seen that such waves contains no interruptions unless the current that actuates or excites the transmitter is cut off. When sounds are impressed upon undamped or continuous waves similar to that illustrated, the resulting current in the output circuit of the distant receiver fluctuates according to the intensity of the sound impressed upon the diaphragm of the microphone in the broadcasting station. The wave emitted by the broadcasting station is then said to be "modulated."

tions produced by the spark system. Reference to Figure C will show how nicely the sound waves can be superimposed upon the undamped waves produced by the huge transmitting vacuum tubes at the broadcasting stations.

The sound modulated waves used in broadcasting are just as elusive as the signals produced by sparks. The vibrations are hopelessly beyond the audible range, but, by the introduction of a crystal detector, this high frequency can be made to produce audible sounds.

We are now ready to take up the subject of the vacuum tube. The development of this instrument by Fleming and DeForest changed the whole aspect of radio. Before DeForest's work, radio was a stumbling, clumsy infant of the technical world. It had very definite limitations and there appeared to be very little room for technical growth and expansion. The vacuum tube, through supplying a more sensitive means of detection changed all of this; made radio the great and glorious thing that it is today.

Our own Thomas A. Edison supplied the spark of genius which finally flowed into the vacuum tube in the hands

of Prof. James Fleming, English investigator. In the early 80's, while Edison was investigating the properties of his electric lights, he wandered upon a most unusual condition, a condition that had, until that time, never before presented itself to any scientific mind. The particular experiment involved the simple arrangement in Figure D. A small metal plate was sealed into one of the ordinary carbon filament lamps of that time. Connected between this plate and the filament proper was a sensitive galvanometer in series with the battery. Much to Edison's amazement, he could make current flow across this heated space between the filament and the plate but when the poles of the battery were reversed, no current would flow. Edison thought little of the experiment and was probably too much absorbed in his light experiments to give it more than a passing thought. He had, however, discovered a principle that caused currents to act as they acted when they passed through certain minerals. It was a case of unilateral conductivity or one way conductivity across a heated space.

Prof. James Ambrose Fleming, F.R.

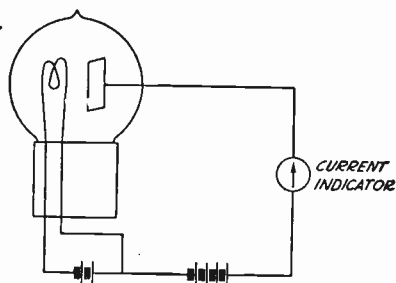

WHAT EDISON DID 45 YEARS AGO

Fig. D. Edison found it possible to make a current flow from the filament to a sealed-in plate of an electric light by connecting the battery and meter as illustrated. It was this remarkable experiment that inspired the modern vacuum tube. This principle is not only used in radio tubes but also in battery chargers of the tube type. The tube in such cases is much larger and constructed so as to conduct heavy currents.

S., took this principle of Edison's and applied it practically in the radio art by developing from it the first two-element vacuum tube. Perhaps it would interest the reader to permit Prof. Fleming himself to outline the development of this history making device:

"Forty years ago, early in 1882, after the Edison Electric Light Company of London was formed, I was appointed electrical adviser to the company. I was therefore brought into close touch with the many problems of incandescent lamps and I began to study the physical phenomena with all the scientific means at my disposal. Like everyone else, I noticed that the filaments broke easily at the slightest shock, and when the lamps burned out the glass bulbs became discolored.

"This discoloration of the glass was generally accepted as a matter of course. It seemed too trifling to notice. But in science it is the trifles that count. The little things of today may develop into

the great things of tomorrow.

"I wondered why the glass bulb grew dark and I started to investigate the matter. I discovered that in many burned out lamps there was a line of glass that was not discolored in any way. It was as though someone took a smoked glass, drew a finger quickly down it, and left a perfectly clean line behind.

"I found that the lamps with these strange, sharply-defined clean spaces were covered elsewhere with a deposit of carbon or metal, and that the clean line was immediately in the plane of the carbon horseshoe filament and on the side of the loop opposite to the burned-out point of the filament.

"It was obvious to me that the unbroken part of the filament acted as a screen to that particular line of clear glass, and that the discharge from the overheated point on the filament bombarded the remainder of the bulb with molecules of carbon or vaporized metal shot out in straight lines.

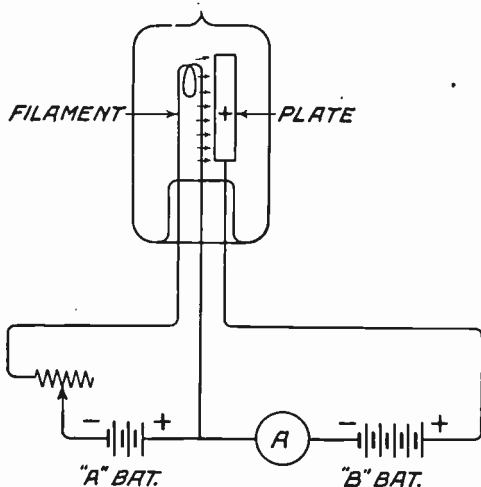

HOW THE FLEMING VALVE WORKS

Fig. E. This diagram illustrates the passage of the electrons from the filament to the plate, thus causing a current to flow through the meter deflecting its needle.

"My experiments at the end of 1882 and early in 1883 proved that I was right.

"Edison was at work in his laboratory in 1883 when he noticed that if he fitted a tiny metal plate inside the bulb of an electric lamp and connected it outside the bulb with the positive end of the filament, he obtained a slight current. The phenomenon was called "the Edison effect"; but Edison could not explain it, nor did he use it in any way.

"In October, 1884, Sir William Preece obtained from Edison some of these electric lamps with metal plates sealed inside them, and he turned his attention to the investigation of the phenomena of the Edison effect. He decided the Edison effect was connected with the projection of carbon molecules from the filament in straight lines, thus confirming my original discovery. There Sir William Preece let the matter rest, just as Edison had done. He did not satisfactorily explain the phenomenon nor

did he seek to apply it in any way. The Edison effect remained just a peculiar property, a mystery of the incandescent lamp.

"Other work claimed my attention for a long time, but I was certain in my own mind that there was still a great deal to discover about this peculiarity of the incandescent lamp, and directly the opportunity occurred I started to investigate the subject once more. In 1888 I had some special lamps made at the Edison and Swan lamp works. Some were strangely shaped, with long glass tubes springing from the sides; others had tubes shaped like the capital "L." The filaments were of carbon, bent round like a horseshoe, and within the bulbs or in the side tubes metal plates were fixed.

"With these lamps, I conducted many tests of a highly technical nature, which I fully described in various scientific papers to the Royal Society and Physical Society. I was keenly inter-

ested, although the average man would have found little in my laboratory to appeal to him. I fully confirmed Sir William Preece's observations that the molecules discharged from the incandescent filament could not pass round a right-angle bend, and double confirmed my original discovery that the molecules traveled in straight lines.

"Then I enclosed the negative leg of the carbon filament in a glass tube, and found that the bombardment of electrified particles was completely stopped. By altering the position of the metal plates, I learned that I could vary the intensity of the bombardment. At last I tried placing a metal cylinder completely around the negative leg of the filament without touching it, and the mirror galvanometer that I was using to detect the currents indicated the strongest current of all. It was plain that the metal cylinder enclosing the negative

filament caught all the electrified particles that were shot out from the filament.

"What I discovered led me to experiment with electric arcs in the open air, and I found that the same phenomenon existed. I published the result of these experiments in a paper in 1889, 'On Electrical Discharge Between Electrodes at Different Temperatures in Air and High Vacua.'

"Thereafter, whenever the opportunity occurred, I continued my experiments with a view to further discoveries. I need not enter into technical details here, but all my researches indicated that the molecules of my original discovery were composed of particles charged with negative electricity. Since the brilliant discoveries of Sir J. J. Thomson in 1897 we have called them 'electrons.' By surrounding the negative filament with a metal cylinder and

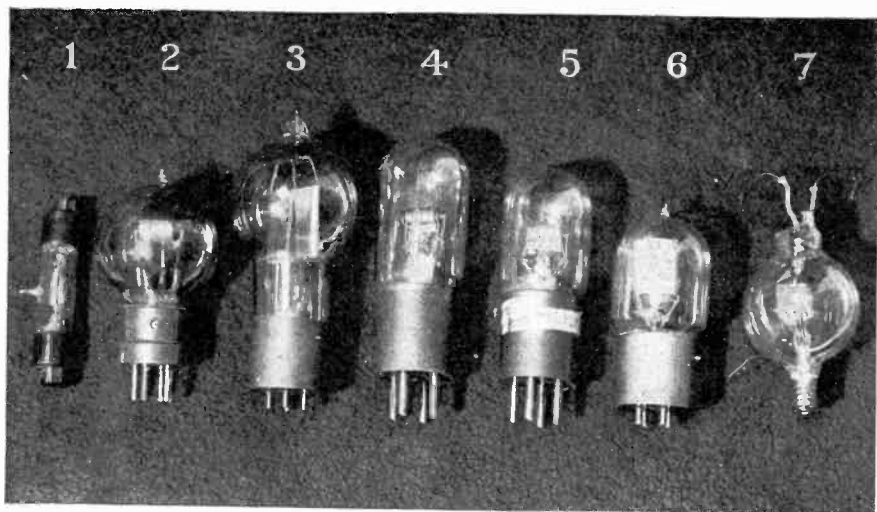

FIGURE F AN UNUSUAL COLLECTION OF AMERICAN AND FOREIGN TUBES—

The various forms of vacuum tubes shown above may be identified as follows: 1, the Myers audion (American); 2, amplifier tube used by the French; 3, the De Forest rectifier tube (American); 4 and 5, German tubes made during the war (on account of the scarcity of brass in that country at the time, the bases of these tubes were made of iron); 6, the well-known Moorhead Electron-relay (American); 7, the original De Forest "Audion" (American).

bringing the filament to a high state of incandescence, a current of negative electricity was induced to flow from the filament to the plate, but it could not be induced to flow in the opposite direction from the plate to the filament.

"I have often been asked to explain why the current could flow one way and not the other, and I think a rough analogy is to liken the glowing filament to a battery of guns always firing shells at a certain target. The shells must travel away from the guns. The impulse is behind them, so they must go forward. It is physically impossible for them to travel toward the guns from which they have been fired. In hitting the target the shells burst and expend their energy, just as the electrons give up their energy, or negative electricity, when they hit the cylinder surrounding the filament.

"It is thus easy to understand why the

current can flow only one way, that is, from the filament to the cylinder. The electrons are like porters, all hurrying in one direction with a tiny load of negative electricity. As there are no porters traveling in the opposite direction, it is impossible to get any current carried back again.

"In 1899 I was asked to act as electrical adviser to Marconi's Wireless Telegraph Company and to assist in solving the technical problem of equipping the first transatlantic wireless station at Poldhu with electrical apparatus that would send a wireless impulse across the Atlantic. At that time a wireless signal had not been sent much over 100 miles, so it was a big jump to send a signal 2,000 miles.

"We realized that high power would be necessary, and that the old methods of supplying power would be useless. Accordingly, we ordered certain ma-

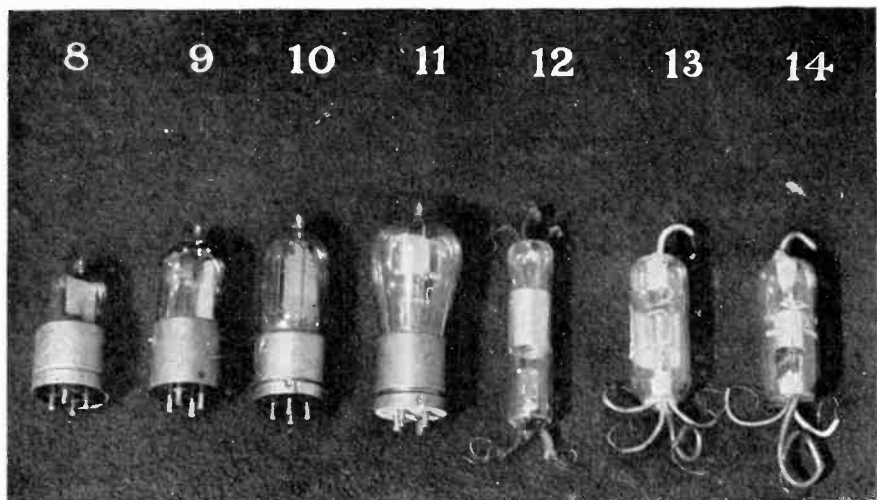

Figure F. INCLUDING SOME OF THE EARLY MODELS USED BY AMATEURS

8 is the De Forest VT-21, a wartime tube (American); 9, the Moorhead amplifier tube (American); 10, the Western Electric VT-1, used by the U. S. Navy and the U. S. Signal Corps during the war (American); 11, the Radiotron, now in common use for detection and amplification (American); 12, the tubular "Audiotron," at one time the amateur's favorite detector (American); 13, an amplifier tube with a second spiral grid that serves as a plate (Japanese); 14, a detector tube, evidently copied after the "Audiotron" (Japanese).

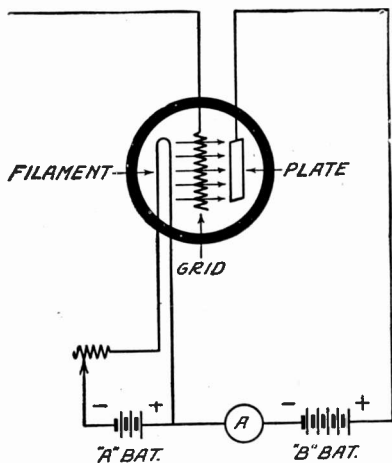

FIGURE G

Diagram of the insulated grid in the vacuum tube. The arrows pointing from the filament to the grid and plate of the tube show the path of the electrons after they are "boiled" out of the filament by heating it electrically.

chinery, which was installed in due course, and in November, 1901, Senatore Marconi, with two assistants, went to St. John's, Newfoundland, to see if it was possible to obtain messages from Poldhu.

"The weather was bad. High winds enveloped them as they stood on Signal Hill trying to induce their kites and balloons to rise in the air. They had barely coaxed one kite to rise when it broke from its moorings and fell into the sea. They tried again until at last the long-looked-for signal was detected. On December 12 they heard three distinct taps signaling the letter "S" and wireless telegraphy across the Atlantic was an accomplished fact, needing only more perfect instruments to make it commercially possible.

"In those early days the coherer was used to detect signals. All wireless students know how it works. The metal

filings in the coherer leap together at the touch of an electrical impulse and form a bridge for the current to pass over, and they have to be tapped apart before they can detect another electrical impulse. Senatore Marconi improved on the coherer as a receiver by inventing the magnetic detector. Yet there was room for still further improvement."

The Fleming vacuum tube was infinitely more sensitive in the reception of radio signals than any device that had been used up to that time. After the work of Fleming, DeForest, through a long series of brilliant experiments, added a third element, the grid, to Fleming's valve and brought it from the plane of a sort of scientific makeshift to a marvelous instrument capable of detecting the most insignificant whiffs of electrical energy. The vacuum tube of today is without doubt the most sensitive device in the world.

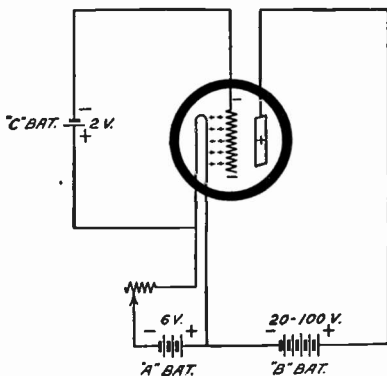

FIGURE H

This diagram illustrates the action of the negative charge on the grid. Since electrons are negatively charged particles, it will be understood that a negative charge on the grid will influence their passages.

If a crystal be connected in an alternating current circuit, only half the impulses will flow through it and the other half of the impulses trying to flow in the other direction will be resisted, or held back. A crystal, then, conducts currents much better in one direction than in the other, and the current that actuates the telephones in a crystal set is that current (which happens to be flowing in the right direction) which the crystal lets through. It will readily be seen that this actuating current is but a part of the received energy, and if all the incoming current could be put to work in some way or other, much louder signals would be produced in the telephones.

We shall now see how the vacuum tube uses all of these received impulses, both positive and negative, and uses them so as to act as a trigger acts in a gun. It takes but a small effort to pull the trigger, although the resultant explosion is many times more powerful than the trigger effort. So the vacuum

tube uses the feeble received currents to "trigger off" larger currents supplied by the "B" battery and in this way at the same time amplifying or strengthening the signals. In this case the "B" battery may be likened to the powder in the gun, and the feeble incoming impulses may be likened to the pressure upon the trigger. An incoming impulse pulls the trigger of the vacuum tube, so to speak, and the "B" battery connected in the plate circuit of the tube immediately "shoots" the energy to reproduce the trigger impulse in a much amplified fashion. This is made possible by the rectifying and amplifying qualities of the vacuum tube itself, giving receiving results far superior to those of the crystal detector which possesses only the quality of rectifying.

Edison, while studying the effects of heated filaments of carbon in the old-fashioned electric incandescent lamp, found out that the filament got thinner and thinner as the lamp burned, and that the glass bulb began to get darker

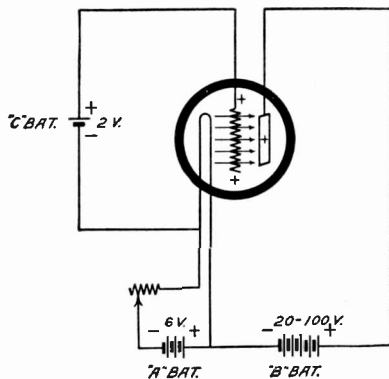

FIGURE I

The action of the positive charge on the grid. Compare this with Fig. H. A positive grid causes an increased electron flow since unlike charges of electricity exert attraction between bodies carrying them.

and darker at the same time. The filament seemed to be disintegrating, and giving off particles which shot across the evacuated space and stuck to the glass. He conceived the idea of placing another electrode or wire in the lamp that would collect these little particles which constantly were being driven away from the filament. Later he found that the extra wire became charged slightly negative every time the lamp was turned on, and finally a battery was connected across between the wire and the filament, with the positive terminal of the battery connected to the wire. Immediately a current was detected flowing in this circuit, and when the lamp was turned off, the current promptly stopped. This action was called the "Edison effect," and we know now that all filaments, when heated in a vacuum give off electrons which fly off and away from the filament.

Before we go any further, there are three points to remember which are important if we are to understand the action taking place in the vacuum tube:

First: a vacuum tube will pass current only from the plate to the filament.

Second: the strength of this current is dependent upon the density of the stream of electrons passing from the filament to the plate.

Third: the density of the stream of electrons is dependent upon the temperature of the filament, the kind of material the filament is made of, the distance between the filament and the plate, and the amount of "B" battery potential applied to the plate.

While experimenting with electron streams in flames and hot gases, De Forest found that he could control the strength or density of the stream of electrons by placing a charged wire mesh in the path of the stream. That this is a fact will at once be evident to anyone who knows that "like charges repel, and unlike charges attract." The electrons are negative, and when the mesh is charged negatively the electrons in the stream which are trying to pass through the holes in the mesh are repelled and the stream is reduced and stops, and

when the mesh is charged positively, the electrons are strongly attracted and the stream is increased and strengthened.

DeForest then applied this principle to the vacuum valve and interposed his famous "grid" in between the filament and the plate. (See Figure G.) In this diagram the grid is shown disconnected and has no externally applied charge on it. In this state the tube would act about the same as the Fleming valve; that is, there would be a flow of electrons across from the filament to the plate if the filament is heated. This is the same as stating that a current would flow from the plate to the filament (refer to the three points to be remembered, mentioned above). The electrons would pass through the spaces in the grid.

Now suppose we should connect a small battery "C" across from the filament to the grid with the negative terminal connected to the grid and the posi-

tive terminal connected to the filament, as shown in Figure H. This would make the grid negative with respect to the filament, or in other words a negative charge of 2 volts will be placed on the grid. Let us study the effect of this charge on the grid in the diagram. The electrons trying to leave the filament, represented by the arrows, are negative. The grid is charged negatively, by the "C" battery. Remembering the fact that "like charges repel and unlike charges attract," we readily see that the electrons are repelled and forced back to the filament; a small number, or none, ever get across to the plate. Hence, in this condition the tube lets little or no current across from the plate to the filament.

What would happen if we suddenly were to reverse the terminals of the "C" battery which is charging the grid? Let us investigate in Figure I. In this case

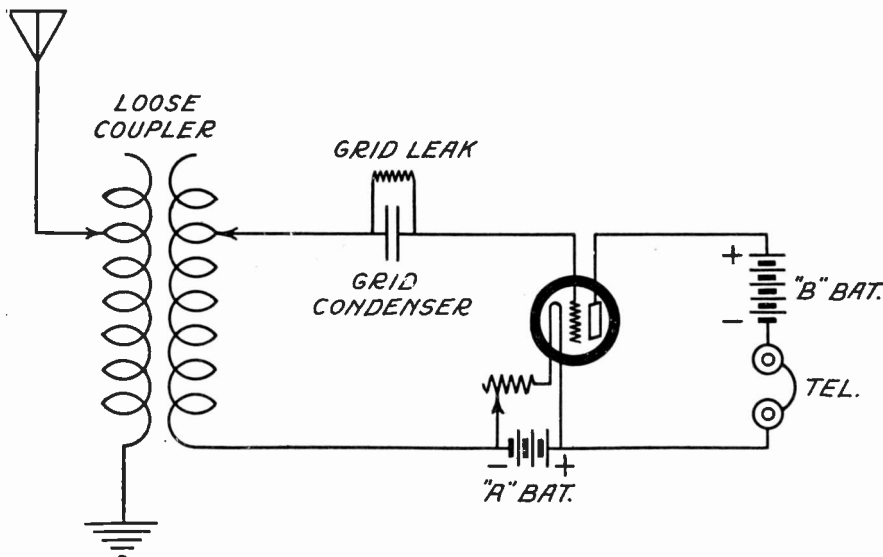

FIGURE J

The diagram above shows the method of connecting a three-electrode vacuum tube to a loose coupler, as a detector.

the grid would have a positive charge of 2 volts, and the negative electrons would be strongly attracted across from the filament to the grid. When they get this far on their journey they begin to feel the greater attraction of the higher positive voltage charge on the plate and they pass through the spaces in the grid in a flying effort to get to the plate, which receives them "with open arms," so to speak. The attraction of the positive charge on the grid draws many times more electrons from the filament than would ordinarily leave it, and thus the density of the stream is increased many times. Another reference to our famous three points will prove that there is at this time a much stronger current flowing from the plate to the filament. The current flowing across from the plate to the filament of course is a direct current, and is known as the "plate current" of the tube. To sum up the action of the tube in a few words, we might say that "the plate current (explosion) of the vacuum tube can be controlled by the voltages (trigger) applied to the grid."

Now we can see the likeness between the action of the vacuum tube and the action taking place in firing a gun.

It takes a very small change in grid voltage to effect large changes in the values of plate current, and it is this plate current that is used to actuate the telephones in a vacuum tube receiving circuit. The feeble received impulses are used to "trigger off" much larger currents supplied by the "B" battery, in this way at the same time amplifying and strengthening the incoming signals. This is the reason why the vacuum tube gives so much stronger signals than the crystal detector, which only rectifies the weak incoming impulses.

In Figure J is shown a conventional

circuit with a vacuum tube used as a detector. The loose coupler is used to tune in to the desired wavelength so that the radiated energy may be received and applied to the grid in the form of high frequency impulses. These impulses vary the amount of the direct plate current of the tube so that the same voice waves as spoken into a distant telephone transmitter are reproduced and amplified in the telephones which are connected in series with the plate and "B" batteries. A grid condenser is used to supply the incoming charges to the grid of the tube. The grid leak resistance is used to prevent the negative charges accumulating on the grid in such large quantities that the tube becomes inoperable.

It is interesting to note that this action of the vacuum tube that we have been considering is based entirely upon the tiny electrons that we romanced over in the introduction to the course. When a heavy current passes through a conductor and causes the metal to be heated high above the temperature of its surroundings, millions and millions of tiny electrons are "boiled" out of the wire and jump off into space. If the wire is surrounded by atmosphere at ordinary pressure, these little electrons will not go far before they bump into an atom of one of the gases present in the atmosphere. If this heated wire is placed within the confines of an evacuated space the electrons will "boil" out more freely and they will move with greater speed. Not only this, but the direction they take can be controlled by placing a positively charged plate in the vicinity of the heated filament.

This unilateral conductivity across the heated space between the plate and the filament of the vacuum tube is brought about solely by the movement of large numbers of electrons passing in

one direction. They function merely as current carriers. Sometimes it happens that they are boiled out of the filament so rapidly that the positive voltage on the plate is not high enough to cause them to travel at maximum speed. When a condition such as this occurs, the electrons start piling up between the plate and the filament. This results in what is known as a *space charge*. That is, the space between the filament and plate becomes negatively charged through the presence of too many electrons all moving but not moving fast enough. When this space charge is present the vacuum tube will be found to be practically paralyzed for the electrons that leave the filament will be repelled because the space charge is negative and the electrons are negative. It is simply a matter of electrons repelling electrons. There are two remedies for a condition of this nature. One is to cut down the current flowing through the filament so that the filament will not be heated to such a high temperature. This diminishes the supply of electrons. The other remedy is that of applying a higher voltage to the plate so that this electrical "sucking" effect will be increased.

It is evident, even to the layman, that it is desirable to coax out a maximum number of electrons with minimum filament temperature. Bringing down the temperature of a filament means that we can reduce the amount of current used and that we will have as a result a more efficient device.

The great laboratories of the General Electric Company have found ways of increasing electronic emission from filaments and perhaps it would be more beneficial to the student to have Dr. Irving Langmuir, Ph.D., D.S.C., one of the greatest living authorities on the

vacuum tube, tell about the amazing method of increasing the supply of electric carriers.

"When metals are heated in high vacuum, electrons, or minute particles of negative electricity, evaporate from their surfaces. If there is another electrode in the evacuated space which is given a positive charge the electrons drift over to this electrode plate or anode so that a current flows between the two electrodes. Dushman has recently derived an equation which should supersede the well-known Richardson equation, giving the relation between the electron current and the temperature of the filament (cathode). The advantage of this new equation is that there is only one constant which we need to know for each different filament material, instead of two constants which were necessary for the Richardson equation.

"The electron emission from a large number of different materials has recently been measured. The thoriated tungsten filament gives a current at a temperature of 1,500° Centigrade absolute, which is about 130,000 times greater than that from ordinary tungsten. Measurements have also been made of filament materials that have even greater emissions.

"In order to make use of the total electron emission that a filament is capable of giving, it is necessary to apply to the plate of the tube a high enough voltage to overcome what is known as the 'space charge' effect. When small amounts of gases are present in the partial vacuum, positive ions are formed in the space between the filament and plate, and these tend to neutralize the negative space charge and allow the current from the filament to pass across the space at much lower plate voltages. In other words, the

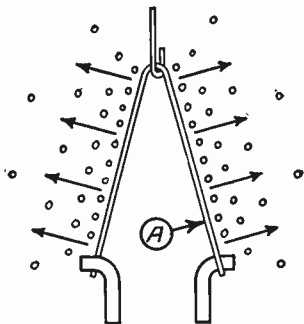

Figure L.—THE ELECTRON DISCHARGE FROM THE ORDINARY FILAMENT

The arrows on this much-simplified drawing show the direction taken by the electrons that are emitted from the heated tungsten filament, A. It is the positively charged plate of the vacuum tube that causes the electrons to be attracted and "pulled" across the vacuous space. The degree to which they respond depends largely upon the voltage of the B battery.

effect of gases is to increase the current-carrying capacity of the tube.

"Such an effect is used in the tungar rectifier. Care must be taken as to just what gas is used for the purpose, for many gases have the effect of poisoning the filament, and cutting down its emission of electrons to a small value.

"If very high voltages are used on the plate, so as to produce intense electric fields, it is possible to *pull* electrons out of the filament. In fact, it is possible to pull electrons even out of cold filaments, that is, filaments at ordinary temperatures. The currents obtained this way from the filament come from very minute areas, but in these areas the current density amounts to more than one hundred million amperes to the square inch.

"The thoriated tungsten filament is a tungsten filament containing one or two percent of thorium, usually in the form of oxide. When such a filament is

heated to about 2,500° Centigrade, a little of the thorium oxide is changed into metallic thorium. In the meantime, however, any thorium on the surface of the filament evaporates off, leaving only pure tungsten. If the filament temperature is then lowered to about 1,800° Centigrade, the thorium gradually wanders or diffuses through the filament, and when it reaches the surface (provided that the vacuum is almost perfect) remains there and gradually forms a layer of thorium atoms which never exceeds a single atom in thickness. The thickness of this film is therefore about .00000001 inch, yet this film increases the electron emission of the filament more than one hundred thousand fold. Two of the latest radio tubes which have recently made their appearance and are known as radiotrons UV-201A and UV-199 embody the new principle of the thoriated filament.

"Of course this useful film is very

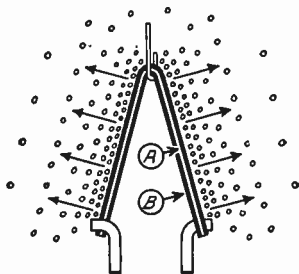

Figure K.—THE ELECTRON DISCHARGE FROM THE THORIATED FILAMENT

Note the greatly increased emission of electrons from the tungsten filament, A, which has been coated with a minute layer of thorium, B. Such treatment of filaments permits the filament current to be cut down without loss of efficiency. That means that less A battery current flowing through the filament will produce the right effect.

sensitive and needs some protection to keep it in good condition. Very slight traces of water vapor or other gases would oxidize this film and destroy it.

"This may be avoided by putting in the bulb some substance that combines with the water before it has a chance to attack the thorium film. One such a substance is metallic magnesium.

"Furthermore, it is necessary to avoid heating the filament to too high a temperature, or the film might evaporate off. It is therefore best to operate such a filament within a rather narrow range of temperature close to 1,700° Centigrade, where the ratio of evaporation is small, and where the temperature is high enough for the thorium gradually to diffuse to the surface and continually repair any damage done by the effect of slight traces of residual gases.

"The thoriated tungsten filament opens up many new fields of scientific investigation. By measuring the electron currents, it is possible to determine

accurately exactly how much thorium is present on the surface. An amount of thorium corresponding to only one one-thousandth of the surface covered with a layer one atom deep is easily measurable in this way. It is possible to knock off a thorium film by bombarding it with positive ions, moving at high velocities, and in this way the true nature of the bombardment can also be determined.

"Most of the applications of high vacuum tubes have depended upon the control of electron currents—as, for example, by the grid in the three electrode tube.

"The action of the grid is due to the charge on the grid that modifies the space charge effect. This is the action that is employed in practically all tubes used today for radio transmission and receiving.

"There are many other methods, however, of controlling electron currents. An important method is that used in the magnetron, where there are only two

electrodes in the evacuated space and the control is obtained by means of a magnetic field generated by an external coil of wire. A still simpler form of magnetron suitable particularly to very large power tubes, consists of a very large straight filament in the axis of a cylindrical plate. The magnetic field produced by the current flowing through the filament is enough to prevent electrons flowing between cathode and anode. By heating the filament with alternating current which periodically falls to a low value, a large electron current can be made to flow from the filament to the plate also periodically. This gives a pulsating or oscillating current, which can be used for radio transmission. A 1,000-kilowatt tube of this kind is in process of development; preliminary tests have been in every way satisfactory.

"Another form of tube by which elec-

tron currents can be controlled is the dynatron. This depends upon subjecting one of the three electrodes in the tube to electron bombardment in such a way as to cause electrons to be splashed out of it, just as water can be splashed out of a cup by attempting to fill it too rapidly from a faucet. A tube of this kind acts like a real negative resistance, and may be used for producing electrical oscillations with considerable efficiency.

"One of the most important of every day applications of electron discharges from hot cathodes is in the Coolidge X-ray tube, which is now almost universally used as a source of X-rays. These tubes were first made about 1913 and are gradually being improved in many respects. The latest type of tube, suitable for use by dentists, is a small tube weighing only a few ounces, and only about three inches long. Because

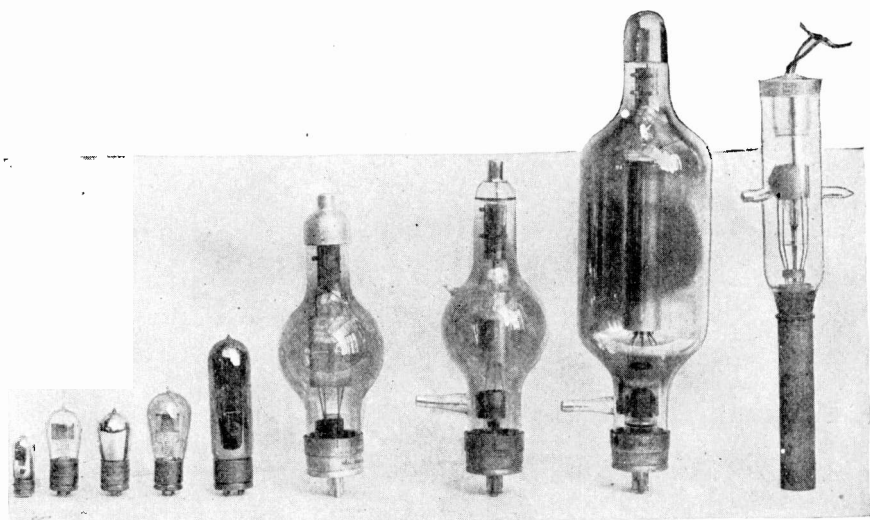

General Electric

RECEIVING AND TRANSMITTING TUBES

Figure M. The three tubes at the left are receiving; two of them have the new thoriated filament. The other six are for transmitting; they range from 5 to 20,000 watts output.

of the special features of this tube, the entire X-ray outfit, including the transformer, lead screen and regulating apparatus, weighs only a few pounds and takes up a space of only a small fraction of a cubic foot.

"One great advantage of this new form of tube, besides its convenience, is its absolute safety, even in the hands of inexperienced operators, for there are no high voltages in any part of the apparatus which is accessible."

The beginner in radio is greatly confused in the matter of vacuum tubes because of the large number of types available. Since the expiration of certain key patents, many manufacturers have entered the field of tube production and the market is loaded with all sorts of detectors and amplifiers. While we have no desire to indict the independent manufacturer of tubes, the reader is cautioned to investigate claims very carefully before he invests his money in nondescript articles. Some of the independent tubes will be found to meet all the claims of their manufacturers while others, due to lack of proper equipment, will be practically useless when placed in a circuit. A vacuum tube is more or less like an egg. An egg may look perfectly fresh and the storekeeper may claim that it is fresh, but it will be found very stale when subjected to the olfactory test.

Due to the rapidly changing conditions and to the going and coming of independent tube manufacturers the editors have decided to hold the descriptive matter concerning tubes down to the products of the more staple organizations.

WD-11 and WD-12. The WD-11 and WD-12 tubes are of the dry cell type, that is they are tubes that operate without the use of storage batteries. Their

filament current consumption is so small that they may be provided with sufficient current from ordinary dry cells for a long period of time. They are thus economical and beautifully adapted to small receivers where portability or conservation of space must be considered. WD-11 and WD-12 tubes have practically the same electrical characteristics and either type may be used as detectors or as amplifiers. The bases are different, however, for the WD-11 requires either a special socket or an adapter so that it may be inserted in the standard socket.

Used with care, WD-11 tubes should have a life of from 800 to 1000 hours of constant operation. The manufacturer of this tube recommends a B battery of 22½ volts. In some cases, however, it may be advisable to drop this voltage to 18, especially if the reproducing equipment of the receiver emits unnatural noises. It might be said here that too much voltage on a detector tube will cause undue distortion.

The grid condenser used with either WD-11 or WD-12 tubes should have a capacity somewhere in the neighborhood of .00025 mfd. and the grid leak (which is the high resistance used in the grid circuit and which we will consider more fully later on) should be of 2 megohms. When WD-11 or WD-12 tubes are used as amplifiers, a greater plate voltage must be applied. This voltage may be as high as 80, and, although the plates of these tiny tubes will stand as much as 200 volts, it is not practical to go over 90 because of the inability of the average audio frequency transformer to withstand this application of pressure.

When more than one WD-11 or WD-12 tube is used in an amplifying system, an additional 1½ volt cell should be added for each tube. The cells are con-

nected in parallel. A dry battery should give from 70 to 90 hours of operation with tubes of this design. Since the filament requires $1\frac{1}{2}$ volts, in case one tube is used, it is connected directly to the rheostat and the filament. The rheostat in this case has a total resistance of 6 ohms and it will be understood that this resistance is variable by moving the contact over the surface of the wire.

Vacuum tubes are always controlled by rheostats for it is only by regulating the flow of current through the filament that we can increase or diminish the supply of electrons and thereby the amplifying and detecting characteristics of the tube. Rheostats with different resistances are required for the different tubes. More will be said about this later.

UV-200 and C-300. The UV-200 and the C-300 tubes are of the same manufacture and consequently they have practically the same electrical properties. Each of these tubes requires a six-volt storage battery or current from some other six-volt source controlled by a standard six-ohm rheostat. While such a tube may be operated on dry cells connected so as to supply a current of about six volts, such operation will be found very expensive for the filament consumption of these tubes is about one ampere. These tubes are used more as detectors and they have been designed especially for this kind of service. Experience has shown that a B battery having from 15 to 24 volts should be applied to the plate and that a grid condenser somewhere between the capacity of .00025 and .0005 mfd. is best.

UV-201—C301. As in the case of the UV-200 and C-300 tubes, the UV-201 and C-301 are identical in construction and operating characteristics, since they

are both made by the same manufacturer but sold through two different channels of distribution. A six-volt storage battery is required for the current supply and this may be regulated by a six-ohm rheostat. These tubes, or rather this tube, should be supplied with a B battery voltage of approximately $22\frac{1}{2}$ volts when used as a detector and with from 45 to 100 when used as an audio-frequency amplifier. Incidentally it will be found that the characteristics of this tube make it more adaptable to audio-frequency amplification than to detection. This tube will also be used with poor success in radio-frequency amplification for it seems that it has been primarily designed to function with highest efficiency in audio-frequency work.

UV-201A—C-301A. As in the cases mentioned previously, the UV-201A and C-301A are one and the same tube sold in different type numbers and under different trademarks. These tubes require six volts of potential, but since they are constructed to consume but $\frac{1}{4}$ amp. at maximum intensity, it is necessary to use a rheostat that will provide from 16 to 30 ohms of resistance. When such specifications are given, the reader is warned not to ignore them and use a lower value. If a six-ohm rheostat should be used for any length of time with such a tube, its life would be greatly reduced and before it finally succumbed, it would act very badly either as a detector or an amplifier.

The tube under discussion requires from 18 to 45 volts as a detector and anywhere from 40 to 125 volts as an audio-frequency amplifier. We have in the UV-201A a most amenable tube, for it may be used very successfully either as a detector and audio-frequency amplifier or a radio-frequency amplifier.

UV-199. The UV-199 is made to operate on two dry cells connected in series. However, practice dictates the sanity of using three cells because of the rapid polarization or dropping of current in the case of a battery of two. It has been found that three cells connected in series will provide sufficient current to operate a UV-199 two hours a day for six months.

Since the filament consumption of these tubes is small (being only .06 of an ampere) it is logical to look to a heavy voltage on the plate to obtain a sufficient supply of electrons for efficient operation. The plate voltage is 80 but the user of the tube may feel safe in advancing well beyond this figure without fear of damaging the tube.

The rheostat used with UV-199 tubes should in the case of one tube be 30 ohms and, in the case of two tubes operating together, one rheostat of 20 ohms will be found sufficient. Three UV-199's in parallel operation can be nicely controlled with a ten ohm rheostat.

At this point the reader should be warned not to operate a vacuum tube (regardless of its type of manufacture) at a higher plate voltage or filament brilliancy than that required for the good reproduction of music. Excessive current in the filament will damage the tube greatly in a short time. This is especially true of the UV-199. Sometimes it can be restored to good operation by lighting the filament for a half hour and leaving the plate voltage off.

The UV-199 may be used either as a detector or amplifier in radio- or audio-frequency systems. While its plate voltage is not critical, about 35 or 40 volts will be found to be the point at which it works best. It is also important to know that when this tube is used as an amplifier the rheostat should be con-

nected in the negative filament lead and that the return lead from the post on the socket marked "grid" should be brought to the negative terminal of the A battery. When the UV-199 is used as an amplifier, from 40 to 80 volts may be used on the plate.

DV-1. The DV-1 tube is of DeForest manufacture and three volts, which may be supplied by two dry cells, is supplied to the filament. As in the case of some of the other dry cell tubes, a 30-ohm rheostat is needed for current regulation. The DV-1 is an excellent detector and a fair audio-frequency amplifier. When used in the former capacity, from 22½ volts to 45 volts will be needed on the plate. As an amplifier, this voltage may be increased from 50 to 85 volts. Experience has shown that the DV-1 is a most excellent radio-frequency amplifier.

DV-2. In the DV-2 we have a tube designed for heavy amplification in audio-frequency circuits. A six-volt source of current (preferably a storage battery) is required by this tube and a six-ohm rheostat is usually employed to regulate the filament current. When employed as an amplifier, a voltage somewhere between 45 and 150 will be found suitable. The reader will be disappointed if this tube is applied to detection.

DV-6A. Here is a six-volt storage battery tube that requires from 22 to 45 volts as a detector and from 45 to 100 volts as an amplifier. It may be used with equal success either as a detector or amplifier.

209-A. This is a tube consuming very little filament current and operating from a six-volt source. It should have a 30-ohm rheostat and a B battery from 90 to 120 volts.

VT-1. The VT-1 is sometimes

called the "J" tube and it is manufactured by the Western Electric Company as a detector and an amplifier. Due to the abundant source of electrons from its filament, a plate voltage of between 12 and $22\frac{1}{2}$ will be found sufficient. This may be increased to 45 when the tube is employed for amplification. It operates from a six-volt storage battery and a rheostat having from 6 to 15 ohms may be used in connection with it. The grid condenser should have a value of .005 mfd. capacity.

VT-2. The VT-2, which is also of Western Electric manufacture, is sometimes called the "E" tube. It is a most excellent audio-frequency amplifier and requires an A battery of 7 volts. However, in practice it is found to work well with a six-volt storage battery and a six-ohm rheostat. B battery potentials may run as high as 350 volts with such a tube.

216-A. In the 216-A we have the master audio-frequency amplifier. It operates from a six-volt storage battery and may be controlled by a 6 to 15 ohm rheostat. The B battery should be of 120 volts although a slightly greater or less voltage may be best. This tube is especially suitable for use in connection with power amplifiers.

There is given on pages 190-191 a table which shows the general characteristics of the various vacuum tubes in general use. Even a perfunctory study of this table will assist the student in choosing vacuum tubes for various purposes.

By using the data given in this chart with our knowledge of Ohm's Law, we may, by a few very simple calculations, determine the exact amount of resistance that should be employed with each tube. Take the figures given in the second and third columns. The second column, it will be noticed, gives the

filament terminal voltage and the third column the filament battery voltage. We know that the difference between these two figures represents the voltage drop in the resistance of the rheostat. By following Ohm's Law it will be seen that this is equal to the product of the current flowing through the rheostat or the resistance is equal to the voltage drop in the rheostat divided by the current. Let us take as an example the UV-199 tube. Reference to the table shows that the terminal voltage is three volts and the filament battery 4.5 volts. The difference between these two figures is 1.5 volts which represents the drop in the rheostat. The current flowing through the rheostat as found in column 4 is .06 amperes hence the resistance in the rheostat must be $\frac{1.5}{.06}$ equals 25

ohms. Since every engineer works with a factor of safety it is always wise to employ resistance a little higher than that actually found with figures. A resistance of 30 ohms is best with the UV-199.

When two such tubes are used together the total current flowing through the rheostat is then .12 amperes. We then have $\frac{1.5}{.12}$ which equals 12.5 ohms.

Although small, the grid leak is a most important device. It is part and parcel of the detector vacuum tube itself and it often happens that radio receivers are insensitive and cranky for the want of a more accurately adjusted resistance in the grid circuit. It might perhaps be well to more thoroughly investigate the function of a grid leak.

To become familiar with the function of the grid leak, let us consider Figure N.

Here we see an ordinary receiving circuit that has connected to the vacuum

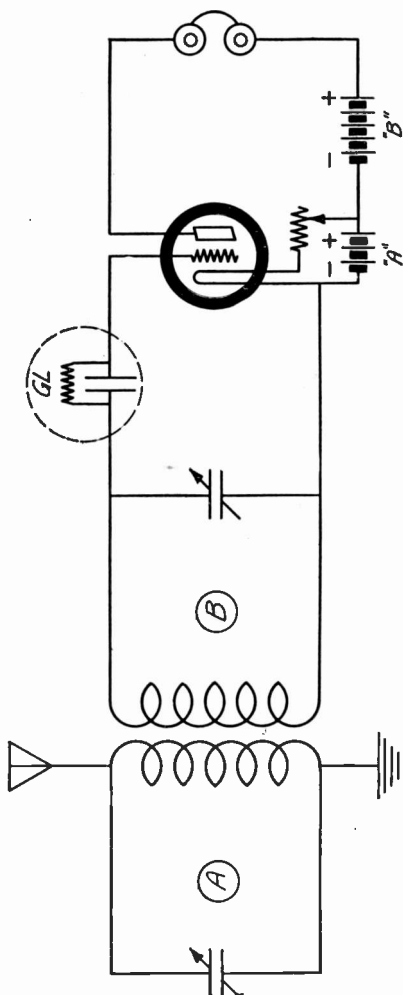

HOW GRID-LEAKS ARE USED IN A RADIO RECEIVING CIRCUIT

Figure N. This conventional receiver hook-up shows one of the connections for the grid-leak which acts as a throttle upon the flow of electrons from the grid of the vacuum tube.

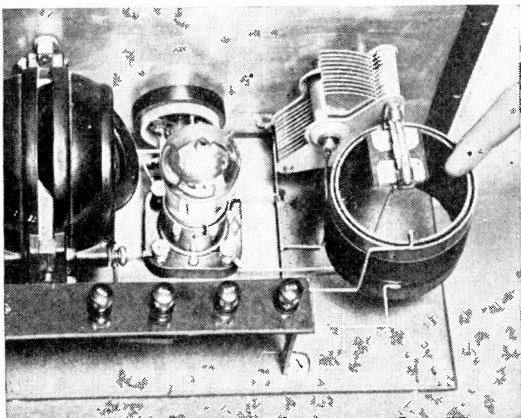

HOW A GRID-LEAK IS MOUNTED IN A RADIO RECEIVER

Figure O: A grid-leak and a grid-condenser are shown at the right in the picture near the finger.

tube grid a grid leak and a grid condenser. Let us assume that the circuit B is tuned to the same wavelength as the antenna circuit A. Oscillations will then be set up in B and this will be connected to the grid with the vacuum tube by way of the condenser. Therefore, the grid will become alternately positive and negative; and each time the grid becomes positive, the electron current will be decreased. Consequently during each wave train the grid will gain a negative charge.

Now, this negative charge is both good and bad. It is good if we control it and bad if we allow it to reach a point that is too high.

We must remember that the little electrons, which are shot off the glowing filament of the tube are negative in nature and when the grid becomes negative the electrons are forced back to the filament. When negative meets negative repulsion always takes place. Two negatively charged bodies always repel each other. Therefore, we must not allow the grid to become too negative if

we wish to operate our radio receiver at its most efficient point.

At the end of each wave train this negative charge should leak off through the condenser or through the glass walls of the tube itself. This should happen before the next wave train comes along, and it is to insure such a result that a high resistance is inserted across the grid condenser. This high resistance is called the grid leak.

The importance of grid leaks grows daily. The day of calling a pencil mark on a piece of cardboard a grid leak is past. Our more sensitive circuits demand a very carefully regulated resistance of constant value and a grid leak of constant value is a mean thing to make.

Grid leaks are made by depositing a colloidal carbon ink upon a small strip of paper. So difficult has been the task of making these grid leaks with an accurate resistance that only one or two manufacturers have the courage to guarantee that their grid leaks are accurate within 10 per cent. The resistance of

grid leaks changes with age, following it appears, as far as physicists know, the same law that holds true for cheese, of which the taste improves with age.

A grid leak made today will have a resistance three months from now somewhere between $\frac{3}{4}$ and $\frac{1}{2}$ of its original value.

The resistance of grid leaks is measured in megohms. A megohm is a million ohms. $\frac{1}{10}$ th of a megohm is then 100,000 ohms and $\frac{1}{2}$ of a megohm is 500,000 ohms. The one megohm type is most used, but this is not mentioned as a recommendation.

Too many fans choose their grid leaks on the hit and miss principle. They figure that as long as they have a grid

leak in the circuit or an apology for one, their obligation to this particular part of the outfit is fulfilled, yet, the operating efficiency of many an outfit has been ruined through an unhealthy grid leak.

No set rule can be given for the use of grid leaks. Resistances that range all the way from $\frac{1}{10}$ th to five megohms are used. If we have a pet circuit and want to make sure that we are employing a grid-leak of the proper resistance, there is only one thing to do and that is to cut and try. But one cannot cut and try, if one only has a single grid leak. If we buy three grid leaks, one with a resistance of $\frac{1}{2}$ megohm, one of one megohm and one of $1\frac{1}{2}$ megohms, there

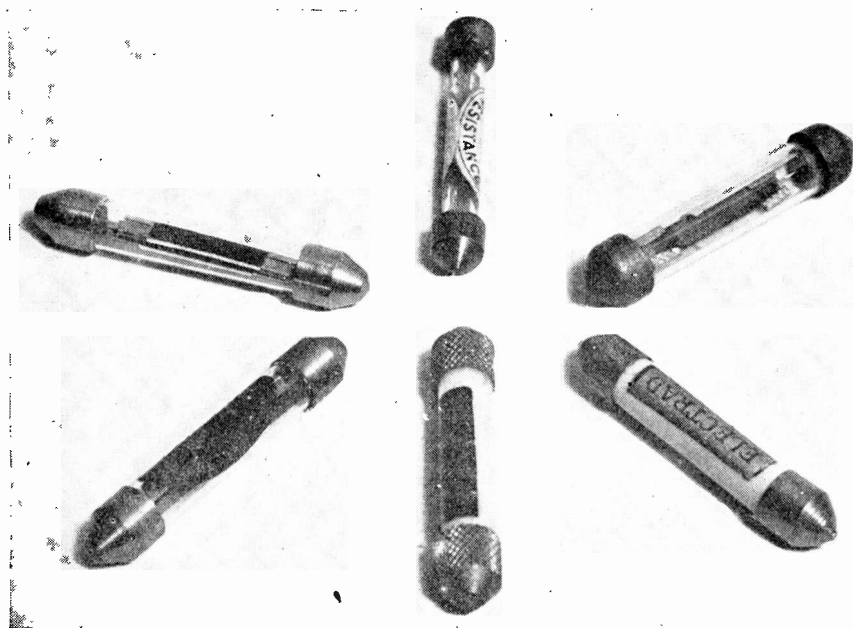

HOW GRID-LEAKS ARE CONSTRUCTED

Figure P: Grid-leaks are usually made of a strip of insulating material that has been impregnated with some substance containing a carbon or graphite base and hermetically sealed in a glass tube. This construction insures a constant value of resistance that, under other conditions, would be subject to change by atmospheric effects.

is a possibility that we may arrange these in a combination of just the necessary resistance. When these resistances are connected in series as illustrated in Figure R, we add them to determine the total resistance. Thus the following formula would hold true:

$$R = R_1 + R_2 + R_3$$

When we connect in series, we always add the resistance. Now, if we were to obtain a lower resistance, we connect the grid leaks in parallel for which arrangement the following formula holds true:

$$1/R = 1/R_1 + 1/R_2 + 1/R_3$$

We see it is possible to juggle the three little grid leaks around so that we can obtain rather a wide range of resistances.

What is the most perfect form of grid leak?

There is such a thing, yet some of us would probably guess all night before we should hit upon it.

Who would imagine that a perfect grid leak is a two-element vacuum tube?

When the filament of a two-element tube is cold and no current is passing through it, the resistance of the space between the filament and the plate is infinite. If current is allowed to pass through the filament, the resistance of this space can be changed all the way from infinity to a few thousand ohms. Therefore, a two-element vacuum tube with a battery and rheostat is the most dependable form of variable grid leak, and the best way of using this variable grid leak is shown in Figure S. Of course the average bug will not care to go to this trouble, but for the real radio

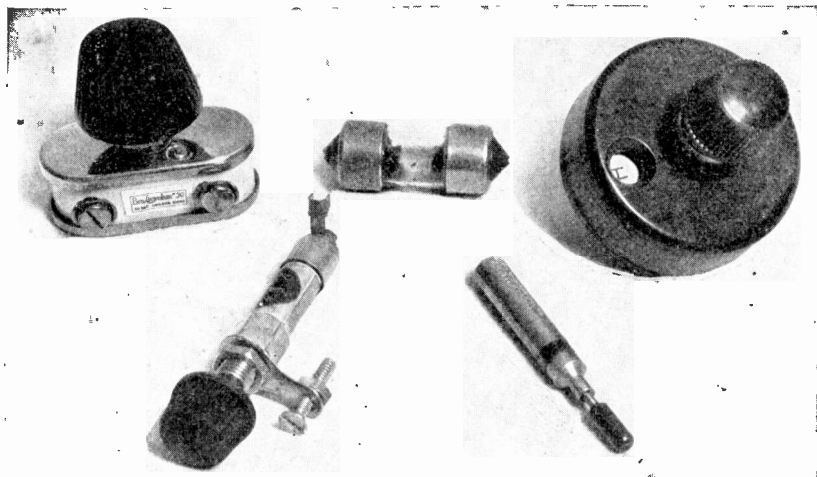

VARIABLE GRID-LEAKS OF STANDARD TYPES

Figure Q: Some types of variable grid-leaks are built so that pressure upon a substance varies its conductivity or so that a plunger passes through a loosely-packed, highly resistant substance. In another type a contact slides over a surface that is completely impregnated with a substance like graphite. There is besides a unique grid-leak that contains a highly resistant liquid which makes contact on a large or small area of metal terminals as the grid leak is turned in its contact springs.

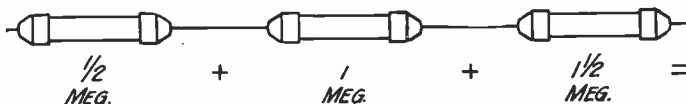

HOW TO FIGURE COMBINED RESISTANCES IN SERIES

Figure R: Grid-leaks connected in series as shown in the diagram have a resistance that is equal to the sum of their individual resistances.

“crank,” nothing can be thought of that will surpass this arrangement for bringing results.

Who would think that a grid leak would cause circuit noises? But a poor grid leak will do exactly that. Grid leaks, aside from being non-inductive and non-capacitative should also be non-microphonic. When tiny carbon particles are brought together they are bound to be microphonic unless they are properly treated. The least movement of these particles due to mechanical disturbance or to temperature effects will alter the resistance of the grid leak and we will get a registration in the ‘phones. For this reason grid leaks must be made of the very best materials and thoroughly protected from moisture and

other disturbing effects. If we build our own pencil-line grid leaks, it will be wise to soak them in paraffine after the connections are made.

Right here it is well to give a word of warning about the connections. Small clamps of copper are best to use, since much of the trouble in grid leaks results from poor contact with the ink surface.

This is an appreciation of the lowly grid leak. Let us remember that it is quite an important thing after all and that it demands the respect of the set owner just as much as its more aristocratic brothers and sisters, the condensers, coils, vacuum tubes and headphones.

There is a practical side to the use of vacuum tubes which the student will

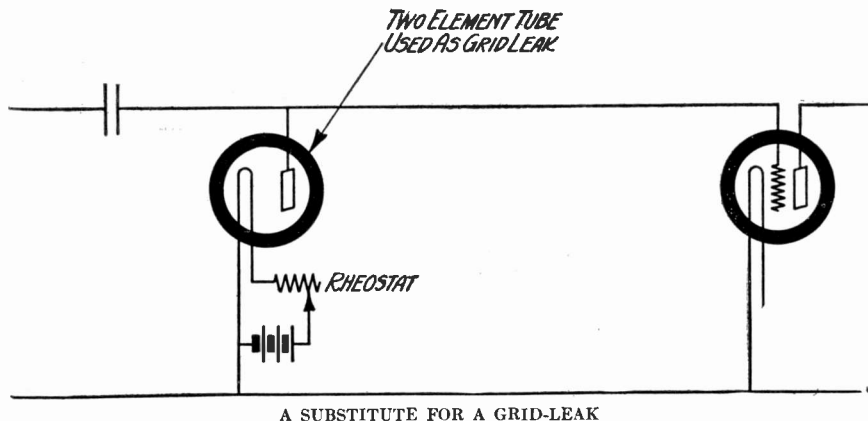

A SUBSTITUTE FOR A GRID-LEAK

Figure S: How a two-element tube, preferably one of the old Fleming valves, may be connected in a receiving circuit to perform the function of a variable grid-leak.

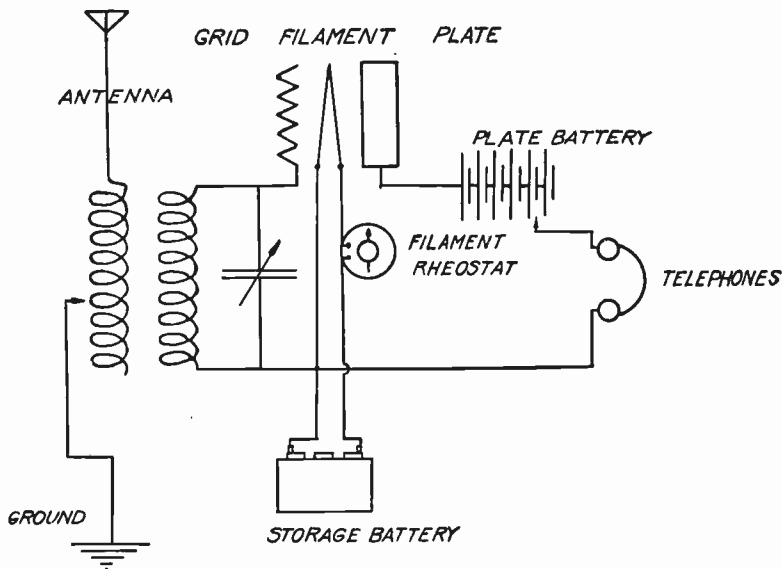

FIGURE T

A vacuum tube used as a detector is shown in this diagram. To simplify the explanation of the functioning of the circuits, the grid condenser, which is used in most cases, has been omitted.

have to master before he can employ this device intelligently. For instance, we have what is known as "hard" and "soft" tubes in radio and each has certain definite properties that may be taken advantage of in radio reception. William C. Ballard, Jr., an associate of Prof. Vladimir Karapetoff of Cornell University, has prepared an authoritative treatise on hard and soft tubes from which the alert reader may glean many points of value.

"The term 'soft' as applied to a vacuum tube is something of a puzzler to most people, as there is nothing about any kind of a vacuum tube that would suggest such a name. The name, however, has been handed down from 'X-ray' terminology and indicates a tube through which a discharge can be easily

produced and whose rays have but feeble penetrative power. When these tubes are investigated it is found that they do not have a very high vacuum and contain appreciable traces of some gas or gases. If the traces of gas are removed from the X-ray tube either by absorption or pumping, the tube becomes 'hard' and requires a much higher voltage for its operation as a consequence. The rays sent off by a hard tube have much greater penetrative power and are frequently spoken of as 'hard' rays."

In order to understand just why a trace of gas makes a tube a good detector we will have to consider briefly what goes on in the detector circuit.

Figure T shows a common connection used for detector tubes. The radio sig-

nal sets up an alternating current in the antenna circuit almost exactly similar to the kind of alternating current we use for electric lights and power, but one which changes its direction about ten thousand times as rapidly as the kind we use for such purposes. An alternating current is one that flows for a while in one direction, stops, and flows for the same time in the opposite direction; then it reverses and flows in the original direction again, and so on indefinitely. The alternating currents with which we have to deal in radio reverse their direction of flow very rapidly. For instance, if we are receiving a 300-meter wave the current never flows in any given direction for over one-half of one millionth of a second. The usual way by which the rapidity in which a current builds up and dies down is measured in cycles per second. When the current has built up in one direction, reduced to zero, built up in the other direction, reduced to zero and comes back to its original starting point, we say that it has gone through one cycle. Applying this form of measurement to the 300-meter wave mentioned above, it requires one millionth of a second to complete a cycle. Hence the frequency is recorded as one million cycles per second.

If we were able to put a current of this character through the windings of a telephone receiver there would be little or no effect produced. While the current is flowing in one direction it tries to pull the diaphragm or vibrating metal plate toward the magnet, and when the current has reversed the opposite force will be exerted on the diaphragm. But for the 300-meter wave these opposing pulls will only last for one-half of one millionth of a second apiece, and before the first pull has any chance to move the diaphragm, the second pull acts on the

diaphragm and neutralizes the effect of the first pull. Since the push and pull are equally strong there will be no appreciable motion of the diaphragm.

But we can make these currents actuate a telephone receiver if we can make the pulls stronger than the pushes or vice versa. Under these conditions the effect of one pull cannot be exactly balanced out by the next push, and after several strong pulls and weak pushes the diaphragm will begin to move. As the diaphragm moves it pushes a little air along in front of it and thus produces a sound wave.

From the way in which the process has been described the reader may think that the diaphragm is moving slowly, but actually it moves so rapidly that your eye cannot begin to follow it. But, as rapidly as it is moving, its motion is slow compared to the lightning-like changes of the radio current, and we may have several hundred pushes and pulls before there is any appreciable motion of the diaphragm.

One way to make the pulls stronger than the pushes would be to entirely eliminate the pushes, or more strictly speaking, the electric currents that produce the pushes. This is just what happens when we use a crystal detector. The crystal has the property of letting currents pass through easily in one direction and of shutting them out almost entirely in the opposite direction.

The vacuum tube accomplishes this result not by shutting off all current in one direction but by making the pushes and pulls of unequal force. Referring to Figure T again, the radio waves set up currents in the antenna circuit and their effect is in turn transmitted over onto the grid of the detector tube. The alternating currents in the antenna circuit produce alternating voltages on the

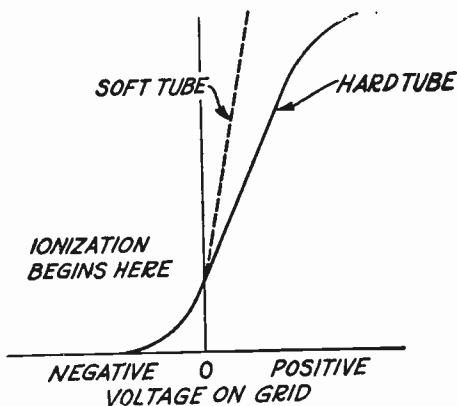

THE DIFFERENCE BETWEEN A HARD AND SOFT TUBE

Fig. U: This shows how both soft and hard tubes act with various voltages on the grids.

grid, which may be considered in the light of electric pushes and pulls following each other rapidly. The telephone receivers shown in Fig. T are not connected directly in the grid circuit but are placed in a second circuit known as the "plate circuit" on account of the fact that in order to complete the circuit, current has to flow between the filament and the plate.

The peculiar action of the vacuum tube lies in the control which the grid has upon the current flowing in the plate circuit. The grid acts as a sort of screen through which the plate current has to pass in its passage from the filament to the plate and the amount of current that gets through the screening grid depends upon the voltage applied to the grid at that particular instant. If the grid is positively charged, by connecting the positive side of a battery to it and the negative side to the filament, the plate current will increase to a value higher than the value which would flow when the grid is connected directly to the filament by a piece of wire. When

the connections to the battery are reversed so that the negative pole is connected to the grid and the positive pole is connected to the filament, the plate current will drop to a still lower value.

The simplest way in which to express a complex relation such as exists between plate current and grid voltage is in the form of a "curve." To show the relation between the plate current and the grid voltage we rule a number of equi-distant parallel lines, both vertical and horizontal, and assume that distances measured in a horizontal direction to the right represent positive grid voltages, horizontal distances measured to the left represent negative grid voltages, vertical distances measured upward represent positive plate currents and vertical distances measured downward represent negative plate currents. The heavy horizontal and vertical lines represent the lines from which we start the measurements. In order to find out just what current will flow when the grid is one volt negative we look for the first vertical line to the left of the heavy

vertical line and follow this line up until it crosses the curve. The distance that we had to travel along the first left-hand line to reach the curve will give us the value of the plate current under the specified condition of one volt negative on the grid, and this length can be most easily found by projecting it over by eye on the heavy vertical line where the scale of units of the plate current is shown. In the case shown the plate current is 2. (See Fig. V, page 201).

If we investigate the value of plate current when the grid voltage is one volt positive we will have to follow the first right-hand line up until it intersects with the curve and the corresponding value of plate current in this case is 8. Similarly, when the grid voltage is zero the plate current has a value of 4.5.

For the sake of simplicity, let us suppose that the value of the grid voltage induced from the radio signal varies between one volt positive and one volt negative, the plate current will increase up to 8 when the grid is positive, drop back to 4.5 when the grid voltage is zero and drop still further to 2 when the grid is one volt negative. The plate current passes through the telephones and when the plate current is increased beyond its normal value the pull on the diaphragm will be increased, producing a "pull" on the diaphragm. When the grid is negative the plate current will drop below its normal value, and by cutting down the pull below normal give the diaphragm a push in effect. On account of the shape of the curve, the pull will be stronger than the corresponding push so that the diaphragm will finally move after several cycles have acted upon it, and thus send out a sound wave. If the curve has been a straight oblique line, the value of the push and the pull would have been more nearly identical

and a lesser effect would have been produced upon the telephone diaphragm. On the other hand, if the curve has been very much more curved or had a sharp break in it, the difference between push and pull would have been much more marked and the pull on the diaphragm would have been even more pronounced with a consequently stronger signal.

The curve shown in Figure V was drawn for a hard tube. The high vacuum and the absence of all gas gives a smooth curve and one which usually does not have any very sharp bends in it. Where slight traces of gas are left in the tube the curve is more likely to resemble that shown in Figure U. From an inspection of this curve it can readily be seen that there will be a large difference between the corresponding pushes and pulls and a correspondingly strong signal in the telephones. The reason for this sudden break in the curve is due to the effects of "ionization by collision."

As the electrons sent off by the filament in a soft tube are drawn over to the plate they collide with some of the gas particles or molecules still left inside the tube. Up to a certain electron speed nothing happens, but when the electron is moving rapidly enough it will break up any gas molecule with which it comes into contact. The gas molecule is composed of a small particle of gas to which are attached small particles of electricity. When the gas molecule is broken up, some of the electricity is set free and moves over with the other electrons to the plate, thus increasing the plate current. This value of speed necessary to break up the gas molecule is quite well defined and the plate current takes a sudden jump just as soon as it is reached. When this ionization action is very intense it causes a blue glow inside the tube. The

best adjustment for detector action is very much below the blue glow point and can be best determined by listening in the telephone while gradually increasing the plate voltage and filament current. When a certain point has been reached a hissing and frying sound will be heard in the telephones; this indicates that the first stage of ionization has been reached. Now turn the plate voltage or filament current down until the hissing has just disappeared and the tube should operate at its best point.

There is one difficulty in the operation of soft tubes; they are liable to change their degree of "softness." The metal parts inside the tube have the property of absorbing and giving up gas, depending on what happens to be going on inside the tube. In general,

heating either the electrodes inside the tube or the glass walls of the tube will set gas free in the tube. On the other hand, operating a tube at or near the glow point has a tendency to absorb some of the free gas and make the tube harder. Tubes usually grow harder in use rather than softer, so that it is sometimes possible to bring them back to their original sensitive condition by carefully heating the glass bulb. The heating of the bulb has the tendency of loosening up some of the gas particles that have become stuck on the sides of the bulb, thus reducing the vacuum to the proper sensitive point.

There is a comparatively simple test which almost any experimenter can make to determine the degree of vacuum inside a soft tube. This test requires a

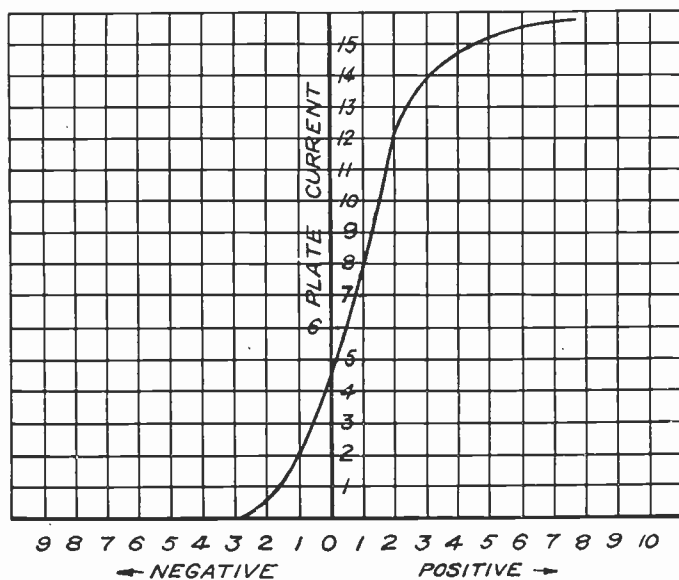

FIGURE V

The relation of grid voltage to plate current in a hard tube is shown by what is known as the "characteristic curve."

small spark coil which can give about a one-quarter inch spark. Connect one of the high tension terminals to the battery (if not already so connected) and set the coil into operation. Next, grasp the tube in the hand, taking hold of the glass bulb, and take care that no part of the hand comes nearer than an inch to the metallic base. Touch any of the terminals to the high tension lead of the spark coil and carefully examine the tube for any signs of glow inside it. No glow at all indicates that the tube is either very hard or else that it is full of air. A pale greenish glow which seems to stick on the inside surface of the glass bulb indicates about the right amount of gas for good detector action. It may operate all right when the bulb fills with a pale greenish-blue glow, but if the glow is purple or confined to a small area directly around the plate and filament the probabilities are that there is too much gas inside the tube to give satisfactory detector action because of excessive ionization.

Soft tubes, while undoubtedly more sensitive as detectors, are not particularly reliable and for this reason many experimenters are using hard tubes as detectors and making up the difference in signal by using more amplification. This is particularly true with a regenerative receiver, where the detector circuit losses are eliminated by the feedback action of this circuit."

As vacuum tubes grow older they become "fagged out" and, although they may appear the same from the outside and though the filaments may light as cheerfully as ever, the reproduction given by them will be "thin" and scratchy. The bringing about of this condition may be accelerated by abusing the tubes when they are in use. A tube may be abused by burning its filament

at too great a temperature or by placing a too high voltage upon the plate. The current passing through the filament and the voltage upon the plate should be only the amount necessary for good reproduction at a fair and not excessive volume. When a radio set is blasting away so that it annoys everybody within the block, it can be taken that its operator knows little about radio or that he cares nothing about the economical operation of his radio set.

While it is true that excessive filament current and plate voltage will hasten the end of a tube's good performance, this must not be taken to mean that a tube will not reach this stage eventually even though it is carefully used. If a set is used nightly, tubes will probably begin to show signs of depreciation in from six to eight months. The volume of the set will drop and the reproduction will have a scratchy, nasal tone. When a condition of this nature is reached, it simply means that the filament of the tube has given up practically all of its free electrons near the surface and that the few electrons left are not sufficient to cause enough current to flow between the filament and the grid. Therefore the reproduction will be "thin" and unsatisfactory.

There is a way of reactivating tubes so that the older ones may be brought back to a state approximating their original condition. The process simply explained is that of sending an extra high current through the filament for a short period of time. This treatment heats the filament to an excessive temperature and many of the electrons that were safely below the surface are "boiled" or forced out into the outer layers.

The current used for this reactivation is usually alternating current be

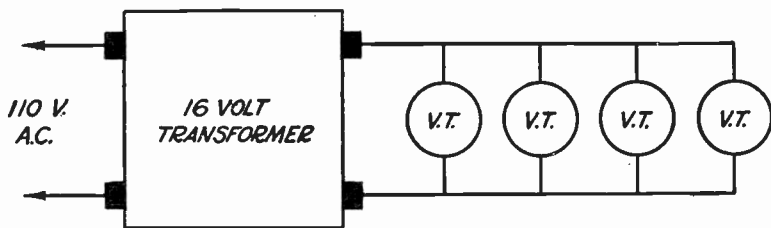

FIGURE W: CONNECTIONS FOR TUBE REACTIVATOR

The simple connections for a vacuum tube reactivator. The transformer used is a voltage reducing type which overloads the filaments of the vacuum tubes in the secondary circuit for a brief period.

cause it is found to have more effect than direct current. Perhaps this is because of its throbbing or pulsating nature, each pulsation coming as a distinct shock. For 201A or 301A tubes 16 volts of alternating current is necessary to bring about recuperation. This should be applied for only 30 seconds. If it is applied longer than this, the filament will be unable to withstand the terrific punishment and will perhaps succumb. After this treatment, the filament may be connected to an 8-volt source of current (which may be direct current) and it may be left here for ten minutes. This latter treatment seasons the tube and it will then be found to have regained a large part of its original perfection.

In event the more serious readers wish to try their hand at reactivating a group of tubes they may follow the diagram given. As many as ten tubes may be treated at one time.

The 16-volt treatment for reactivating indisposed vacuum tubes is by no means standard. Some of the manufacturers of reactivating devices have designed their equipment to develop a voltage higher than 16. Nor is the time limit mentioned in connection with the treatment standard. Some engineers believe that short treatment at high

voltage is the solution while others feel, and perhaps rightly so, that a lower voltage should be used with a longer time limit.

The objection to the higher voltage (say 20 volts) is that it requires a fairly robust filament to withstand this high pressure for the full time limit. A real old tube may often be killed by the cure. In any event, however, the purchaser of a tube reactivator should follow out the directions of the builder.

All tube reactivators do not have transformers. Some manufacturers have taken advantage of the drop across resistances and have provided the proper voltage by this means.

In the following pages the student will find listed photographs and the general characteristics of practically all the standard vacuum tubes. These have been alphabetically arranged so that they will be conveniently available for ready reference. If the reader is looking for a tube with special characteristics for use for a specified purpose he will, no doubt, find it by glancing through the data. For instance, if he is looking for a tube for use with a resistance coupled amplifier he will require one with a high plate resistance. The list shows that the Daven and the Hi-Constron are ideal for this purpose.



From a photograph made for POPULAR RADIO

Dr. Lee de Forest

*The inventor of the audion with three electrodes—
the vacuum tube that made the present day radio
transmission and reception possible.*

"I am sure that no one connected with the radio art or industry can fail to recognize the debt we all owe to POPULAR RADIO. No agency has done more to popularize and dignify the new art, to arouse widespread interest in its merits, and abiding faith in its future, than has this magazine."

—DR. LEE DE FOREST

VOLUME II—CONTRIBUTORS

SIR OLIVER LODGE, F.R.S.
PROF. J. H. MORECROFT, Ph.D.
LAURENCE M. COCKADAY, A.I.E.E.

GEORGE LEWIS, E.E.
SYLVAN HARRIS, E.E.
DORMAN D. ISERAL, E.E.
MORRIS S. STROCK, E.E.

DR. E. FREE, Ph.D.
JOHN V. L. HOGAN, E.E.
JESSE MARSDEN

CONTENTS

SECTION 7

Audio-Frequency Amplification. The underlying principles of plain audio-frequency amplification. The action of simple systems. The various types of amplifiers; transformer coupled, resistance coupled, impedance coupled types. Push-pull amplifiers. The characteristics of audio-frequency transformers. The cause and cure of distortion. Dry-cell tubes as audio amplifiers. Amplification curves and specifications of all popular makes of audio-frequency transformers.

SECTION 8

Radio-Frequency Amplification. The underlying principles of radio-frequency amplification. The action of simple systems. The various methods used in coupling radio-frequency amplifiers. Radio-frequency transformers; how they should be designed and how they should function. The various types of radio-frequency transformers. Tuned radio-frequency amplification. The specifications of the various popular makes of transformers on the present market.

SECTION 9

Fixed and Variable Condensers. The principle of electrostatic capacity. The mechanical features of variable and fixed condensers. The different types of condensers. The importance of insulation and the properties of insulators. The factors that determine capacity. How good condensers should be designed. The finer points of variable condenser construction. The losses in variable condensers and how they can be overcome. The wavelength, capacity and frequency curves and specifications of all the popular types of variable condensers on the present market.

SECTION 10

Coils. The electrical features of simple coils. The causes of electrical losses in coils of various types. The different types of coils; D-coils, honeycomb coils, spider-web coils, solenoids, bank-wound coils, etc. Distributed capacity; how to overcome it. Wire and wire tables. How to design coils for different wavelengths. Specifications and photographs of different types of coils.

SECTION 11

The Improvement of Broadcast Reception. The various causes of radio interference. Broadcast waves and how they produce unnecessary noises. Causes of distortion in various types of radio receivers. Radiating receivers and how to adjust them. Crystal receivers—how to improve them. How to overcome all kinds of interference.

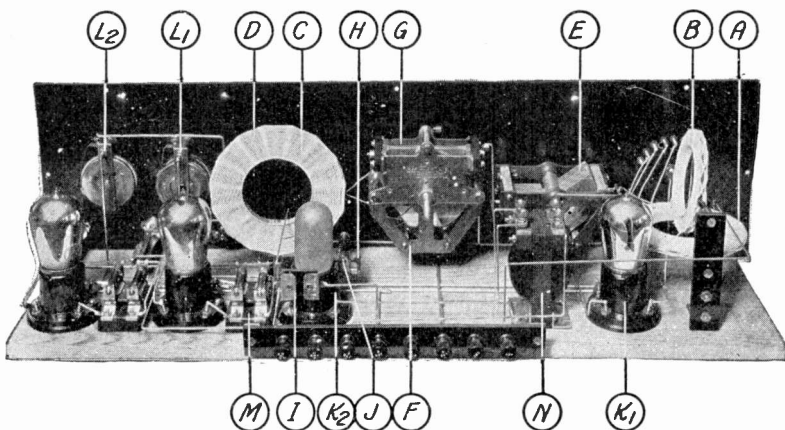

The Sections of the Everyman's Guide to Radio dealing with the various instruments keyed in this illustration may be quickly found by reference to the index below.

ILLUSTRATED INDEX

- A-B—Loose couplers and variometers, Section 10.
- C—Coils, basket wound, D—Coils, honeycomb coils, etc., Section 10.
- D—Radio frequency transformers, all types, Section 8.
- E—Condensers, variable types, Section 9 and 2.
- F—Condensers, variable vernier, Section 9.
- G—Condensers, variable and multiple, Section 9.
- H—Fixed condensers, Section 9 and 2.
- I—Fixed condensers, adjustable, Section 9.
- J—Grid leaks, Section 6.
- K1—Amplifier vacuum tubes and sockets, Section 6 and 16.
- K2—Detector vacuum tubes, Section 6.
- L1—Rheostats, Section 6 and Section 16.
- L2—Potentiometers, Section 16.
- M—Resistance coupled audio amplifiers, Section 7.
- N—Audio-frequency transformers, Section 7.

SECTION VII

Audio-Frequency Amplification

AMPLIFICATION is a term that is usually misunderstood by the novice. It is often thought that amplification involves "blowing up" a small amount of energy into a large amount of energy just as one might inflate a balloon. This is not a true idea of the process. In the case of increasing the strength of weak radio signals with vacuum tubes, we do not in a really true sense amplify, we merely *add to*. Each vacuum tube enables us to take energy from a local source and add it to the incoming signal or music. The vacuum tube allows us to take energy from a B battery and to add small quantities of this energy to the tuned signal. This process of adding energy to incoming impulses involves many delicate conditions and functions as we shall see.

There are two fundamentally different types of amplification. We have radio-frequency amplification and audio-frequency amplification. Radio-frequency amplification (which will be described in Part 8) is amplification that takes place before the incoming signal has had the opportunity of reaching the detector tube. In other words it is amplification before detection and the tubes and other appurtenances used for this purpose are always placed between the detector and the aerial. Audio-frequency amplification is amplification that takes place after the signals have been reduced to

the audio frequency range. It is well to think of radio "before" and audio as "after."

L. M. Cockaday has supplied this portion of our study with a comprehensive treatment on the subject of audio-frequency amplification and the reader will gain from it much that is of value.

"The problem of vacuum tube amplification is somewhat different from that of vacuum tube detection, although the same essential theory of operating the tube is observed.

"The vacuum tube is a voltage operated (voltage controlled) device. This same principle is used for amplification.

"Dr. Lee De Forest saw the feasibility of using the amplifying qualities of the vacuum tube when he took out his patents on the 'cascade amplifier,' as he called it. This system uses a number of vacuum tubes connected in cascade, coupled together by means of transformers so that the output circuit of the detector tube is connected to the input circuit of the first amplifier tube, and so on with the second and third amplifier tubes. It is not good practice to use more than two stages of this type of amplification, on account of 'tube noises' which are amplified along with the signals and which tend to blur reception.

"Audio - frequency amplification is

cascade amplification of the rectified impulses which are flowing in the plate circuit of the detector tube. These impulses are of an audio or audible frequency and the successive stages of amplification are coupled together with a transformer called an 'audio-frequency amplifying transformer,' which will step up the voltage of an audio-frequency impulse and supply it to the grid of input circuit of the next tube.

"For the present we will look into the inner workings of the audio-frequency amplifier.

"First of all, let us investigate how

the series of tubes used in this method are connected.

"In Fig. A we have a standard hookup for an inductively coupled tuner with a vacuum tube detector; added to this is a two-stage audio-frequency amplifier. The first stage consists of a transformer, T^1 , and a vacuum tube, V^2 ; the second stage likewise contains similar instruments, T^2 and V^3 .

"The secondary circuit of the receiving coupler receives the energy collected by the antenna circuit; this energy supplies the grid of the detector tube with a radio-frequency oscillating voltage wave

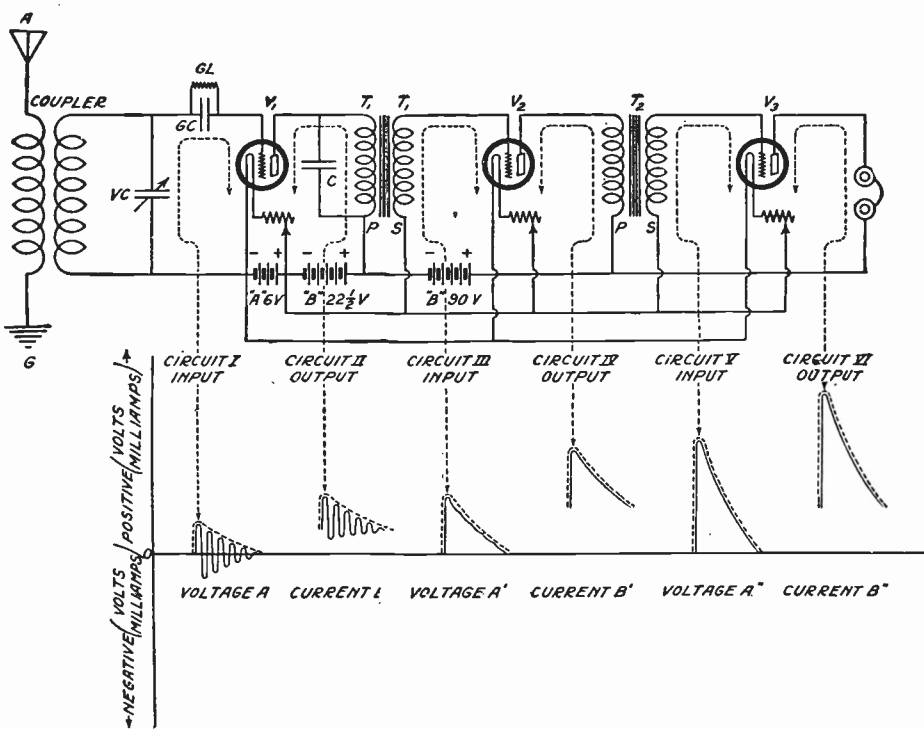

HOW THE AUDIO-FREQUENCY AMPLIFIER WORKS

Figure A: This diagram shows the electrical action that takes place in a radio receiver from the time the current enters the antenna until it reaches a reproducing device after having passed through two stages of audio-frequency amplification.

shown at A. This is the voltage across the circuit designated as Circuit 1.

"The tube V^1 then acts as a relay and produces an amplified impulse in its plate circuit (Circuit 2), which has the same audio-frequency wave form as the original impulses in Circuit 1. These wave forms can be compared by referring to the dotted lines in curves A and B. The radio-frequency component of the current B is passed around the transformer winding P by means of the bypass condenser C, and only the audio-frequency component of the current B (which is shown by the dotted lines) passes through the winding P. This current, flowing through P, induces a similar impulse in the secondary winding S, except that the voltage of the impulses induced across the Circuit 3 is higher than the voltage in Circuit 2 on account of the step-up ratio used in the transformer windings.

"The voltage in Circuit 3 is shown at A^1 . By comparing the voltages A and A^1 we readily see that in A^1 we have a much greater voltage impressed on tube V^2 than the A impressed on V^1 . Therefore in the plate circuit of V^2 (Circuit 4) we have a greater current response than in V^1 , Circuit 2. Compare the currents B and B^1 .

"It will be seen that the second tube amplifies the current flowing in the plate circuit of the first tube and supplies this amplified current to a second transformer, T^2 , which also steps up the voltage of the impulse as shown in Circuit 5, supplying the grid of tube V^3 with a larger voltage than that applied to tube V^2 . Compare A^1 and A^{11} . This in turn produces a still greater response in the plate circuit of tube V^3 , Circuit 6, shown at B^{11} .

"Now, the problem before us is to get the plate current variations as large as

possible; that is just what we have done, as is shown when we compare the currents B, B^1 , B^{11} in the plate circuits of the three tubes. They have been getting larger in each additional stage of amplification.

"A further analysis of this action should enable us to see clearly that the phenomena in a vacuum tube is purely a case of cause and effect. The cause is the voltage applied to the grid and the effects the corresponding current which flows in the plate circuit. In our diagram the causes are shown at A, A^1 and A^{11} and the effects at B, B^1 and B^{11} . If we increase the cause as at A^1 , we get a greater effect, B^1 , and if we further increase the cause as at A^{11} , we get a still greater effect, B^{11} . The increase in the cause is accomplished by the transformers which step up the voltage of the succeeding impulses, and the effect is increased by the relay action of the vacuum tubes themselves.

"This amplification is done at an audio frequency, because the amplifying transformers pass the audio-frequency impulses with facility, but hold back the radio-frequency component of the current, not allowing it to flow through their windings."

We have really four distinct types of audio-frequency amplification. We have just completed our discussion of what is known as straight audio-frequency amplification. Then we have what has become known as push-pull amplification or power amplification (due to the great volume produced), resistance-coupled amplification and impedance-coupled amplification. Straight amplification and push-pull amplification are transformer-coupled systems. That is, one tube is coupled to the next magnetically by a very simple transformer involving a primary and secondary wind-

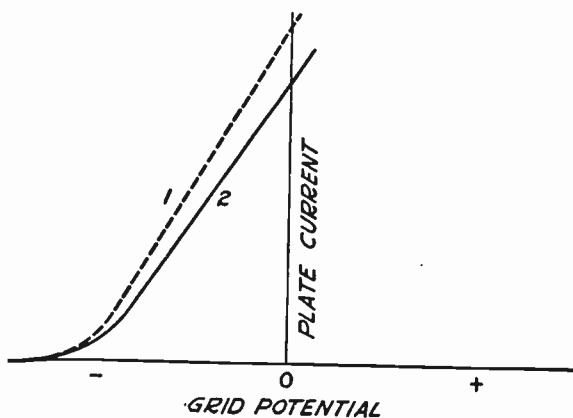

A SIMPLE CURVE

Figure B: This simple curve shows the relationship between the grid voltage and the plate current of a standard three element vacuum tube.

ing. We shall leave impedance-coupled amplification out of our discussion because it is as yet in its experimental form.

Push-pull amplification, which requires special transformers, is recommended in many cases where great volume is required because this volume may be produced with small distortion. If more than two stages of plain or straight transformer-coupled amplification are used, the duty imposed upon the third tube will be far beyond its electrical capacity and its output current will be badly twisted and distorted as a result. We may, however, attach to any two-stage audio-frequency system a push-pull unit and get as a result very sweet reproduction with high power volume.

It is the electrical characteristics of the vacuum tube that defeat attempts to employ more than two stages of audio-frequency amplification. To put it technically it is because the grid voltage when plotted graphically against the plate current is not in a straight line. While this phrase may sound terribly

technical, it expresses nothing more than the electrical relationship between two values. It is the relationship between the grid voltage and the plate current of the tube and if we refer to Fig. B we shall see just what it means. The grid voltage is shown in the horizontal line and the plate current is shown along the vertical line. The reader will notice that the vertical line is marked zero and this means that it is the dividing line between positive and negative potentials. That is, everything above zero will be positive and everything below zero will be negative. When we start at the extreme left hand side it will be seen that as the grid voltage increases toward the vertical line the plate current also increases until we get to zero potential. The student will also note that the curve increases as the grid potential decreases.

When a B battery is connected to the plate of a tube through a transformer, the receiver offers a resistance to the passage of current from the battery so that the retarding increases as the cur-

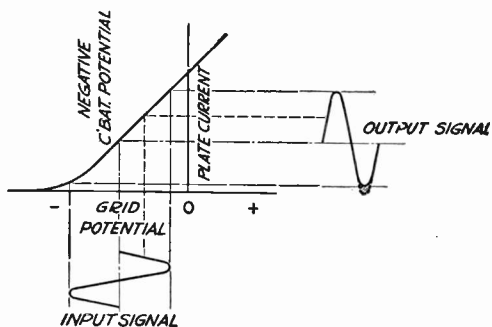

HOW DISTORTION IS PRODUCED

Figure C: If the reader will study this curve together with the text he will be made to understand the advantages of the push-pull system of audio-frequency amplification.

rent increases. This causes the current to drop back or to lag behind the values shown at B. It will be noticed if the sketch C is studied that the curve is straight for the grid voltages within certain limits. If the radio receiver could be operated so that only the straight portion of the line would be employed perfect reproduction would result. However, most receivers are operated so that the curved portion is involved.

When a negative potential is placed on the grid of a tube by inserting a C battery in the circuit, there is established a voltage as shown by the vertical line. This will be found marked. About these lines fluctuates the wave of the incoming signals and it is these that we desire to pass on to the loud speaker in the exact form in which they come in save for the fact that their energy content should be increased. Due to this small curve, the student will see that the lower side of the wave of the outgoing current is not of the same height as that of the upper side of the wave. This is indicated by the shaded area.

This shaded area also indicates the amount of distortion that will be present in the loud speaker. We have a visual idea of the amount of unnecessary sound produced.

In Fig. D we will find a diagram of the standard two-stage push-pull amplifier. Each stage consists of no more than the standard vacuum tube and the special type of push-pull transformer. It will be noticed also that the secondary of the first transformer and the primary of the second or output transformer are tapped in the center. We can also see that the voltage impressed upon the primary of the transformer is the same as that which would be impressed upon an ordinary audio-frequency transformer. However, since the secondary of the transformer in the push-pull system is tapped in the center, the voltage impressed upon the grid of each of the two tubes used is only half of that which would be impressed upon a tube in an ordinary straight audio-frequency circuit. Consequently we may impress upon the primary just

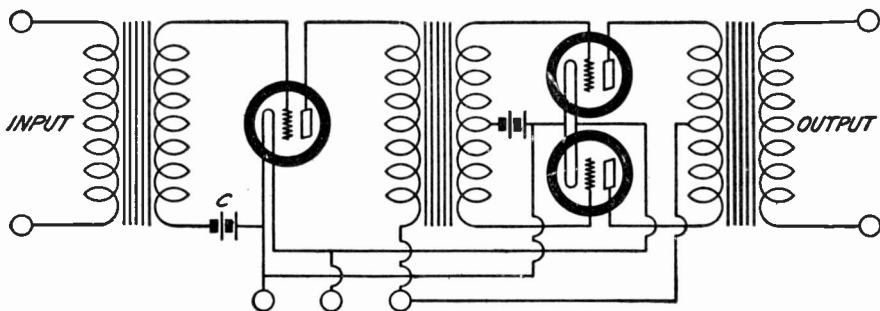

A PUSH-PULL AMPLIFIER DIAGRAM

Figure D: This diagram shows all of the connections involved in a conventional two-stage amplifier of the push-pull type. The reader will notice the position of the C-battery between the first tube and the secondary of the first transformer. This is the correct position for all C-batteries for ordinary type of audio-amplification. The advantage of the push-pull amplifier lies in its high power amplification and small degree of distortion. So small is the distortion that such amplifiers may be employed after two stages of straight audio-amplification without danger of bad reproduction.

twice the voltage that we could impress upon another system. When this divided voltage is united in the primary of the output transformer we will have doubled the output energy.

Let us see if we cannot put this more simply. When two tubes are connected in a one-stage system (push-pull is really a divided or balanced one-stage system) there is a balancing effect between the tubes which will permit us to work each tube at a higher point than we could work the same tubes in a straight audio-frequency system. In a certain sense any distortion caused by one of the tubes up to a critical point will be balanced out by the other tube. By using this system we are able to get three times the volume that would be possible with a two-tube audio-frequency amplifier of the ordinary type.

Audio-frequency resistance-coupled amplification has, because of the splendid reproduction available from such sources, superseded most of the old types during the past few months. Resistance-coupled systems are both simple

and inexpensive and unlike transformers, the resistance units employed for this purpose do not have critical characteristics. This means that with reasonable care the rankest novice may assemble an amplifier of this type and obtain from it very mellow and sweet reproduction.

To thoroughly understand resistance-coupled amplification we shall have to again go over the functioning of a vacuum tube, for it is upon the peculiar characteristics of vacuum tubes that resistance-coupled amplification is based.

In the accompanying curve (Fig. E) we see the graphic result obtained by plotting the plate current against the grid voltage. At another place (Fig. F) we see an oscillating circuit, one side of which is connected to the grid and the other side to the filament of a three element valve. We will assume that the normal current flowing in the plate circuit is represented by Y. It will also be noted that this Y line connects with the vertical line at a midway point. The characteristic line, that is the line which

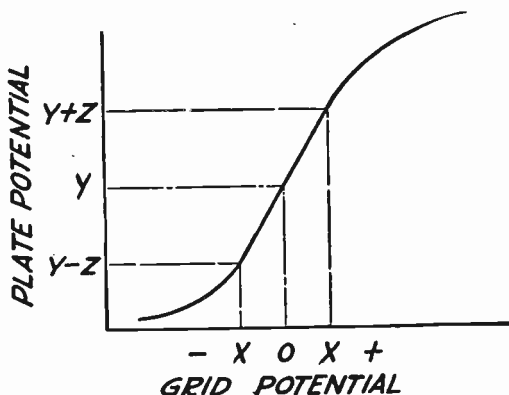

VACUUM TUBE OPERATION

Figure E: The operation of a vacuum tube is explained by charting the relationship of the plate potential or voltage to the grid potential or voltage.

represents the characteristics of the tube, is the line which is partly curved and partly straight. Further examination will show that this Y line also connects to the midpoint of the straight part of the characteristic line.

We will assume that the normal current flowing in the plate circuit is represented by this Y line. It is desirable in practice that this should be the value of the plate current when the grid voltage is zero. In actual practice this condition can be arrived at by adjusting the voltage on the plate and to do this it is necessary to have a variable B battery and to also adjust the filament current.

Now let us assume that we have an oscillating current impressed upon the grid of the valve in Fig. F and that this current will place an alternating positive and negative charge on the grid. If we further assume that the potentials developed are created by an undamped oscillation of symmetrical wave form we shall see that the positive potential communicated to the grid will be numerically equal to the negative potential.

At this point it will be necessary to again refer to the sketch E showing the characteristic curve where we may examine the effect of this alternating potential on the current in the plate circuit of the tube.

We have previously assumed that the normal potential of the grid is zero and that the corresponding plate current is represented by Y . We will now assume that the potentials applied to the grid are positive X and negative X . Under such conditions we see that a potential of X positive on the grid causes the plate current to increase by a value Z . Further back we assumed that the positive potential was numerically equal to the negative potential and further that the portion of the curve upon which the tube operated is a straight line. It will now be seen that the negative X causes a decrease in the anode current of exactly Z . From this it will be seen that the theoretical variations of the plate current are exactly proportional to the oscillations in the circuit connected to the filament and grid of the tube. It is

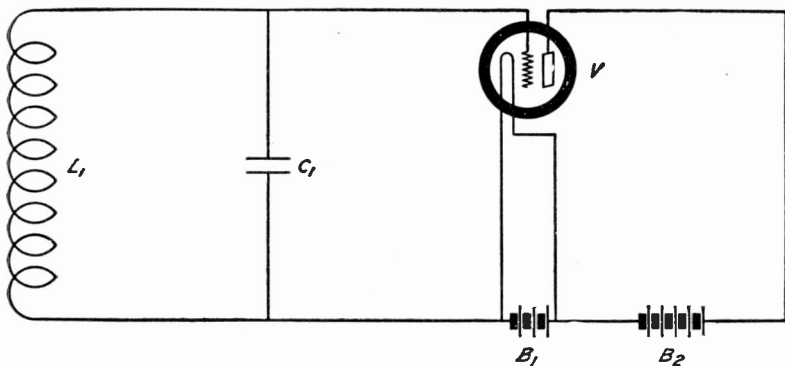

THE VACUUM TUBE IN A STANDARD CIRCUIT

Figure F: The operation of a resistance-coupled audio-frequency amplifier will be better understood by first reviewing the action of a simple circuit like the above. A difference in potential is impressed across the grid and filament of the tube by the coil L_1 . This is then rectified by the tube V aided by the A battery B_1 and the B battery B_2 . As the text will explain, an oscillatory high-frequency current is impressed upon the coil L_1 , carried to the vacuum tube and rectified in the usual manner. An understanding of this process will assist the student greatly in mastering the details of resistance-coupled amplification.

obvious that these variations may be made to control the grid potential of a second valve.

In resistance amplifiers a resistance is inserted in the plate circuit of the first tube and the variations of the plate current produce varying potentials increasing the resistance and these are applied to the grid and filament of the second vacuum tube.

If the plate potential to a tube is increased with respect to the filament, we find that the plate current gradually increases and similarly if we increase the grid potential the plate current increases. To put it differently, if the current through the same conductor varies it is equivalent to considering the conductor as a variable resistance. For our particular purpose we may consider the plate circuit of a tube in a resistance coupled amplifier to be composed of a fixed and variable resistance, the plate filament path constituting the variable

element. The plate resistance constitutes the fixed component and it is the variable potentials produced across these which are applied to the filament and grid of the next tube. This will probably be better understood by referring to Fig. G. Here we have a battery connected across a variable resistance AB in series with a fixed resistance BC . For our purpose we will suppose that the resistance AB is equivalent to the resistance BC . If the potential of the battery should fall along the path AC the voltage would be distributed uniformly along both AB and BC and hence the voltage across BC would be exactly half of that across AB since both resistances are of the same value.

Let us suppose now that the resistance AB is lowered. The distribution of the potential along the path AC will then be altered for, since the value of AB has been increased, there will be less voltage drop along it. On the other hand the

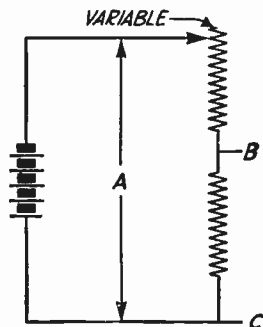

HOW A RESISTANCE ACTS ACROSS A BATTERY

Figure G: This simple circuit contains all of the elements involved in a single-stage resistance-coupled amplifier. The text will explain how the two systems are related.

total voltage drop along the path AC will increase. Similarly, if the resistance AB is increased the potential across BC will be decreased. It is this very principle that is taken advantage of in audio-frequency amplification of the resistance-coupled type.

If we will refer to the next diagram (Fig. H), which involves a vacuum tube and B battery and a resistance in series with the plate and filament of the vacuum tube, we shall find a condition existing analogous to that which we have just considered. The vacuum tube takes the place of the variable resistance AB in the previous diagram. Since the resistance of the space between the plate and the filament of the tube is varied according to the changes upon the grid, there will be a fluctuation in the voltage drop across BC providing, of course, that the filament and the grid of the tube are connected to a radio circuit.

In the next figure (Fig. I) we see a resistance-coupled amplifier. Radio-frequency currents are applied to the

grid and the filament of the first tube through the medium of the resonant circuit containing the coil and the variable condenser. This causes the first tube to act as a variable resistance in series with the fixed resistance BC. The variations in the resistance of the tube cause a fluctuating voltage drop across the terminals of the resistance BC and these variations are carried on to the second tube. In normal practice, there would be a potential across BC, the fixed resistance, of something like 30 volts. This would be supplied by the B battery of the first tube. If a little fixed condenser in the grid circuit of the second tube is not used, the potential of the grid of the second tube would be in the neighborhood of 30 volts and the tube would be rendered inoperative. It is this little condenser that prevents the passage of anything but the small variations in the potential produced across the terminals BC. (It will be recalled that pure d.c. will not pass through a condenser.) In place of the fixed con-

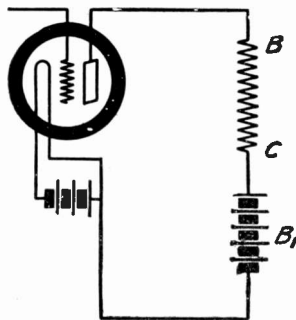

THE OPERATION OF A RESISTANCE- COUPLED AMPLIFIER

Figure H: Here the vacuum tube takes the place of the variable resistance AB in Figure G. It will be seen that the space between the filament is made variable in resistance by the charges placed on the grid of the tube.

denser, a battery (which is shown) might be inserted which would oppose the current flow of the B battery of the first tube. This, however, is expensive practice and there are not enough advantages in the system to make it advisable to use it.

For best results, audio-frequency amplifiers of the resistance-coupled type usually require about 130 volts of B battery. The resistances used range from $\frac{1}{4}$ to $\frac{1}{2}$ megohm. The usual form of grid leak is admirably suited to resistance-coupled amplification and standard fixed condensers of .01 mfd. capacity may be used to stop the flow of the B battery current. Although it is not advisable to use more than two stages of ordinary audio-frequency amplification employing the usual type of transformer, this rule does not have to be followed in the case of resistance coupling. Here three stages of amplification may be used with absolute safety. In practice, however, it has been found best to use one stage of audio-frequency amplification with the transformer and the two following stages with resistance coupling.

Resistance coupling affords faithful reproduction of music and is without question the best form of amplification that has thus far been developed.

In radio reception we do not only have the A and B battery, but we also have the C battery, which is perhaps less understood than either of the other two. A C battery, providing it is used correctly in audio-frequency circuits, will effectively overcome a great deal of needless distortion of the output current.

While C batteries are employed to prevent distortion, they can also create distortion. It is only by an understanding of their operation that such distortion may be prevented.

A C battery is usually made up of several cells of flashlight battery connected in series so that the total voltage of the battery will be the sum of voltages of the cells. Thus, a three-cell battery gives 4.5 volts. Such batteries are placed in a circuit so that their negative poles are connected with the grid and consequently their function is to place a negative charge of electricity upon the

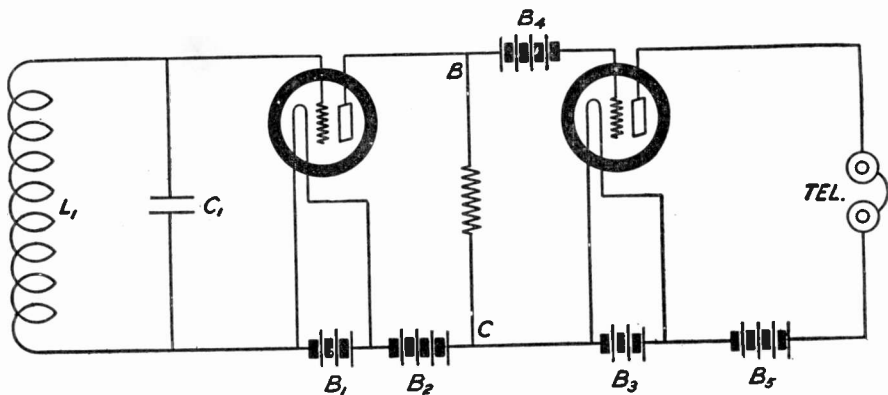

A RESISTANCE-COUPLED AMPLIFIER

Figure I: Diagram of connections used in a simple two-stage resistance-coupled audio-frequency amplifier. The voltage drop occurs across the fixed resistance marked BC. This is the general principle employed in all resistance coupled audio-frequency amplifiers.

grid. The positive pole of the C battery finds its way to the filament and the negative pole of the B battery. This method of connection may be easily remembered by keeping in mind the fact that it is connected just the reverse of the B battery. The positive pole of the B battery is always connected to the plate while the negative pole of the C battery is always connected to the grid. It is to be remembered that this arrangement is not to be employed with detector tubes, but only with amplifiers.

The object is to place enough negative potential upon the grid so that its maximum positive point will still remain below zero. Since a negative grid cannot draw a current, no distortion will be produced.

A C battery of the wrong voltage, either too high or too low, will be worse than no C battery at all. The voltage must be controlled within rather narrow limits. If it is carried beyond a critical point and the grid is made highly negative, the plate current will be distorted. We will have as a result badly distorted

music, because we cannot distort a current with sound superimposed upon it without at the same time distorting the sound. Indeed if we insist upon carrying the negative potential of the grid to a point where it is abnormally high, we would cut off the plate current entirely. We should choose a C battery of such voltage that when the grid is at its most positive point, it will still have an appreciable negative potential. This will prevent the plate current from being distorted and also keep the music sweet and melodious. A potentiometer shunted across the C battery so that its potential could be (Fig. J) varied from practically zero to full value is one means of getting the correct voltage. It will be found that the voltage should be somewhere between 3 and 9.

The amount of C battery on the first stage is not nearly as critical as that on the second stage. This is easy to understand if we know that the voltage of the incoming radio wave is weaker and therefore can be more readily accommodated to the straight part of the charac-

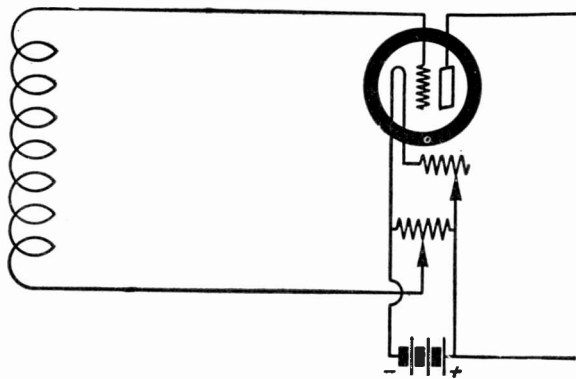

HOW TO USE A POTENTIOMETER

Figure J: The manner of employing a potentiometer to place a negative bias on the grid of the vacuum tube is illustrated.

teristic curve. Since the voltage is boosted in each stage of amplification, in the second stage it has been built up to a higher point and the radio user will therefore find it more difficult to reach just the proper C battery potential.

Although the C battery is usually employed as shown in Fig. K, experience has proven that it is more practical to place it as shown in Fig. L where it may be used without adding a length to the grid lead, which, owing to its susceptibility to stray currents, it is best to keep as short as possible. A long grid lead is an invitation to stray currents and when they are induced in it, a feed-back condition is brought about which usually results in audio-frequency regeneration and consequent distortion. It is wise therefore to place the C battery between the filament and the secondary of the amplifying transformer. When in this position the impedance of the secondary winding acts in such a manner as to ward off any stray potentials that may reach the grid and bring about trouble.

It is always well to keep the C battery fresh, for when extreme chemical action

sets in, which is usually denoted by swelling and the formation of blisters, the battery is apt to become noisy through a certain amount of current fluctuation to which the grid is somewhat sensitive, especially at the first stage. However, but a trifle of current is drawn from a C battery and it can be used for a long time before it will be necessary to replace it.

A technical understanding of audio-frequency amplification is impossible unless the reader becomes familiar with the true nature of the audio-frequency transformer. An acquaintance with this essential will not only arm him with knowledge that will permit him to operate radio sets most effectively but it will also permit him to buy transformers intelligently and to specify their characteristics.

The research work going on today is bound to upset a number of notions about audio-frequency transformers which have long been prevalent among radio fans. For example, people still buy transformers by specifying the turns ratio, although the turns ratio is no cri-

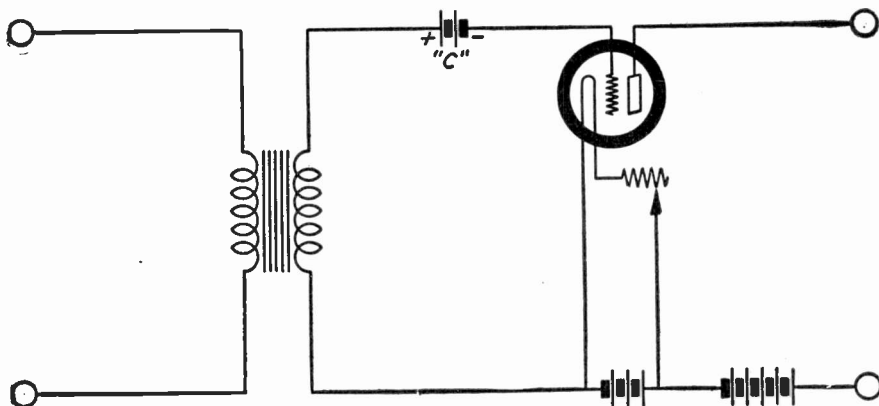

HOW NOT TO USE A C BATTERY

Figure K: Although the C battery will function when used as shown, it is not the correct position for it.

terion of the quality of a transformer. Others believe that it is necessary to use transformers having different turns ratios in the different stages of an amplifier, and manufacturers turn out different ratio transformers when such a procedure is only an attempt to rectify defects.

After all, the transformer must meet just one requirement to be classed as a

high quality transformer: It must reproduce faithfully the sound currents which are supplied to the primary circuit.

Audible sound vibrations range in frequency from as low as 16 vibrations a second to as high as 30,000 a second. But for all practical purposes, such as the transmission of high quality speech and music, we are concerned, essentially, with the range between 30 and 10,000

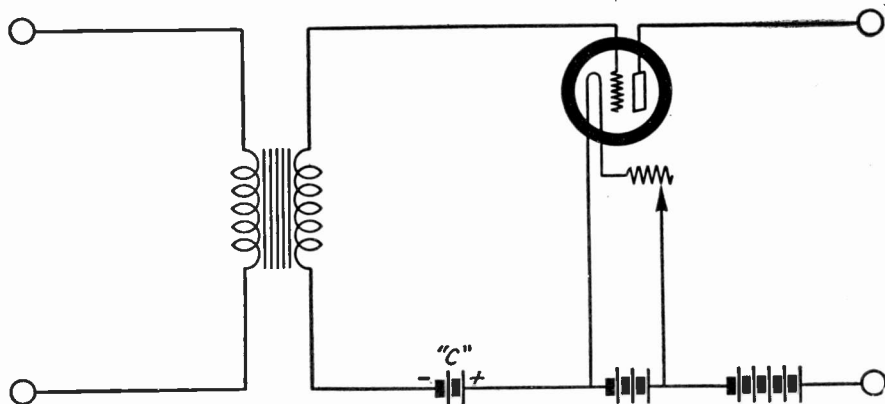

HOW TO USE THE C BATTERY CORRECTLY

Figure L: The text will give the reason for connecting the C battery of a radio set in the position illustrated

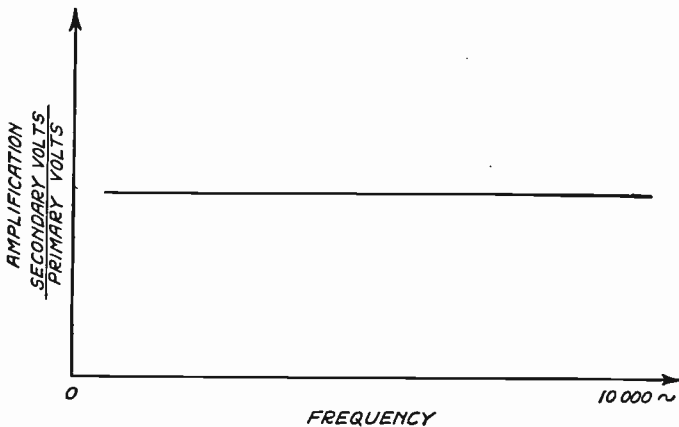

HOW AN IDEAL AUDIO-FREQUENCY TRANSFORMER SHOULD AMPLIFY

Figure M: The straight horizontal line shows what the amplification response should be for an ideal transformer with changes in frequency from 60 to 10,000 cycles; it would amplify all the audible frequencies with equal intensity.

cycles a second. The lowest notes on the piano keyboard and the beat of the kettledrum are in the neighborhood of 25 or 30 cycles while the piccolo and organ reed may go as high as 10,000 cycles. Between these two extremes we have every other possible intermediate frequency, and all possible combinations of frequencies such as might occur in the rendition of a selection by a symphony orchestra, a band or a chorus. Even when we are apparently concerned with only one frequency (as, for example, middle C, 256 vibrations a second, as played by a violin), other frequencies are involved; for harmonics (or overtones) are generated which are of several times the fundamental frequency, and the intensity of each of these overtones bears a certain quantitative relationship to the intensity of the fundamental. It is evident, then, that for any reproduction to sound natural, the transformer must be able to reproduce all frequencies from 30 to 10,000 cycles equally well over the entire range.

The difference between an audio-frequency transformer intended for use in radio-telegraph reception and one intended for radio-telephone or broadcast reception will at once be readily appreciated. In the case of telegraph reception we are concerned with one audio frequency which may be 500 cycles or 1,000 cycles or some other frequency of that order. The transformer may be designed to give its maximum amplification at the signal frequency, and no particular thought need be given to what happens at the other frequencies. Also the transformer can be given a high step-up ratio so that the transformer itself amplifies the signal voltage as much as possible. Ratios as high as 10 to 1 have been used without detracting from the efficiency of the transformer at the particular signal frequency used. Radio-telephone reception obviously presents a much more difficult problem and introduces considerations which are vital to good results.

As a measure of the quality of an

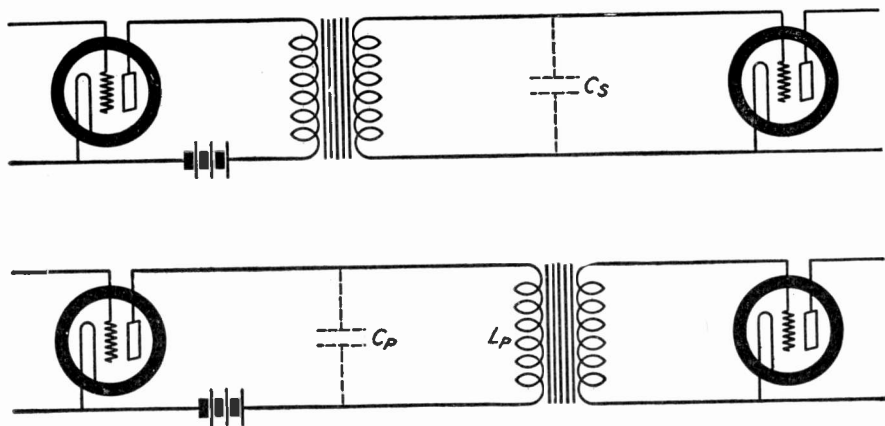

HOW DISTRIBUTED CAPACITY AFFECTS THE HIGH TONES

Figure O: In the top figure the capacity of the secondary windings has the same effect as though a condenser C_s were connected across the terminals. The high turns-ratio multiplies this capacity effect so that we have the effect of a condenser C_p as shown in the bottom figure. The result is that the higher audible frequencies are by-passed around the primary winding and do not reach the grid of the following tube.

amplifying transformer we may take its "frequency characteristic" which shows the relative performance of the transformer at different frequencies. Suppose we apply a given constant voltage at different frequencies to the primary of the transformer and then measure the voltage across the secondary of the transformer at these different frequencies. An ideal transformer would have frequency characteristics as shown at M. This curve shows that the transformer reproduces in the secondary all the frequencies between 30 and 10,000 cycles equally well. This is the ideal which audio-frequency transformer design should approach. The greater the departure of actual transformers from this ideal the less desirable the instruments would be for broadcast reception.

The ratio of the number of secondary turns to the number of primary turns is called the "turns ratio." When a transformer is designed for a particular frequency, the voltage across the secondary

is equal to the voltage impressed on the primary times the turns ratio, provided the coupling coefficient is unity, which is very nearly the case in most closed-core transformers. But at other frequencies this is not necessarily so. One of the factors which is instrumental in producing this effect is the distributed capacity of the transformer secondary winding.

If, with a given number of turns on the primary winding, the turns ratio is increased, the secondary turns increase correspondingly. The greater the number of turns on the secondary the greater is the distributed capacity of the secondary winding. This distributed capacity behaves, in effect, as a shunt across the secondary of the transformer. Furthermore, transformer theory and practice show that this secondary distributed capacity is equivalent in its effect to a certain capacity in the primary circuit, and this equivalent primary capacity is equal to the actual secondary capacity multiplied by the

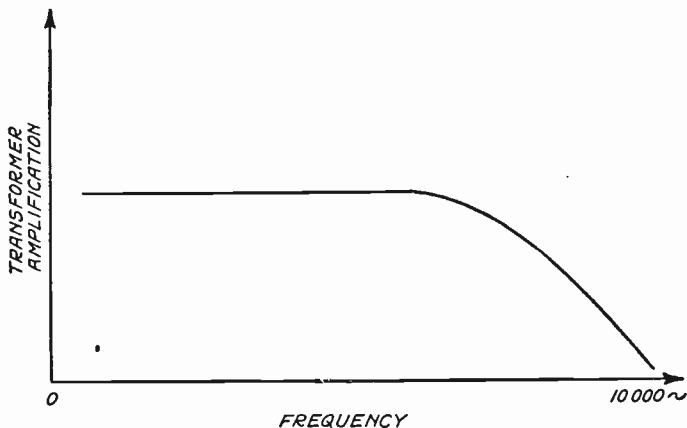

WHY SPEECH IS MUFFLED

Figure N: This curve shows a falling off in amplification as the frequency is increased. The high tones are lost and the result is a muffled, drummy quality to both speech and music. This undesirable but frequent action is the most common cause of poor reproduction in home-made audio-frequency amplifiers using poorly designed audio transformers.

square of the ratio. Thus, if a given transformer that has a turns ratio of 7 has a distributed secondary capacity of C microfarads, then it behaves as though we had a capacity of $(7)^2C$, or $49C$ microfarads capacity in the primary. In other words, the capacity effect of the secondary is multiplied about 50 times in the primary circuit, and it behaves, in effect, as though it were shunted across the primary. This increased primary capacity produces a great departure from the ideal flat frequency characteristic, and introduces considerable distortion.

A transformer for interstage coupling is generally used in connection with vacuum tubes as in Fig. N (top) where C_s represents the distributed capacity of the secondary.

Fig. N (bottom) represents the same circuit, except that the secondary distributed capacity is replaced by its equivalent primary capacity. We thus have two reactances in parallel, the

primary inductance of the transformer and the effective primary capacity. If there were no capacity, all the audio-frequency current in the plate circuit would flow through the primary inductance and would thus be effective in producing secondary voltage. The presence of the capacity, however, has the effect of shunting some of this audio current, and, as the reactance of a capacity decreases with increase of frequency, it will shunt more of the high-frequency currents than the low. Also, since this shunt current flows through the capacity rather than through the primary of the transformer, it can have no effect in producing induced voltage across the transformer secondary. As a result we have progressive falling off of secondary voltage as the frequency is increased, and the ideal frequency characteristic of Fig. N begins to look somewhat like that of Fig. P.

The first effect of a high turns ratio, which means high distributed capacity in interstage coupling transformers, is to

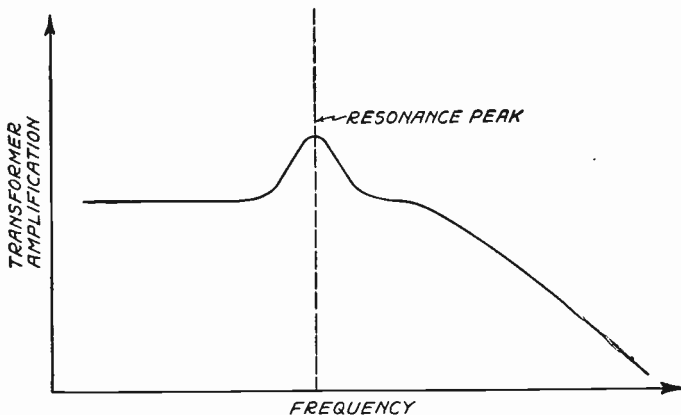

HIGH CAPACITY ALSO PRODUCES RESONANCE EFFECTS

Figure P: The capacity and the inductance of the transformer form a tuned circuit and when the distributed capacity is high, the resonance point falls within the audible frequencies and excessive amplification of a particular tone is the result. This is also a common fault of many amplifiers of the audio-frequency type.

produce decreased amplification at the high frequencies. The distortion characterized by the absence of the high frequencies is a muffled, drummy quality in both speech and music, and the absence of sibilants and consonants in speech.

The high distributed capacity that results from a high turns ratio produces still another undesirable effect in audio-amplifying transformers—a resonance phenomenon at the particular frequency to which the circuit $L_p C_p$ in Fig. O (bottom) tunes. This is a tuned parallel circuit whose impedance at resonance is a maximum. The voltage developed across it is, therefore, a maximum at resonance. Hence there will be a peak in the amplification at this frequency, and there will be another departure from the ideal transformer characteristics of Fig. M which now begins to look like Fig. N. The distortion introduced by such a transformer is obviously an exaggeration of the particular frequency

to which the transformer constants tune, and this is often the explanation of why certain musical tones stand out prominently and conspicuously over all others in a particular receiver. If such a transformer is used in both first and second stages of an audio amplifier it will be evident that this resonance effect will be multiplied in the second stage, and the amplification characteristics will look like Fig. Q.

To avoid over-exaggeration of this resonance effect, therefore, many manufacturers recommend the use of a transformer having a different turns ratio in each stage. This mitigates the evil of an over-exaggerated single frequency, but introduces instead *two* resonant periods. For, when each transformer has a different turns ratio the constants will be different, and $L_p C_p$ (Fig. O), will tune to a different frequency. The combined frequency characteristics of both transformers will, therefore, be of the nature of Fig. R where two moder-

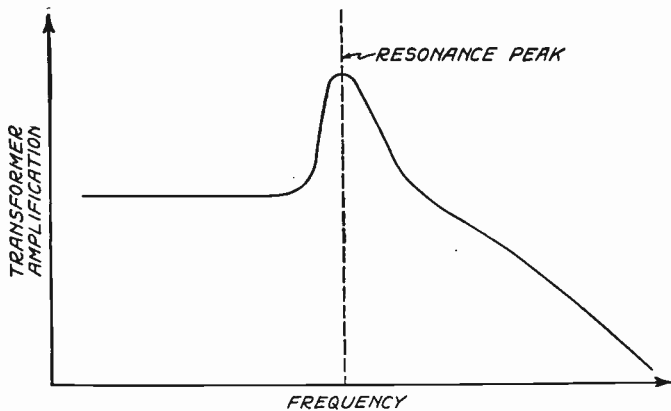

WHAT HAPPENS WHEN THE SAME TURNS RATIO IS USED FOR TWO STAGES

Figure Q: If a transformer which has a bad resonance point is used in each of the two stages, the distortion will be multiplied and an exaggerated resonance peak is the result. It is very difficult to design a transformer to overcome this defect.

ately sized resonance peaks are produced as against one over-emphasized peak in Fig. Q. This procedure is obviously no solution to the problem of securing uniform amplification at all frequencies. The solution is, rather, to make transformers which amplify all frequencies uniformly, and the first step is to avoid high turns ratio which produces two irregularities in the ideal flat frequency characteristic. There is poor amplification at the higher frequencies and resonance peaks.

The high-ratio transformer will in general give greater volume than the low-ratio transformer, though this may not always be the case, as it is possible that the loss in amplification at the high frequencies will neutralize the gain obtained at the low frequencies. In electro-acoustic converters it is almost invariably true that high quality of signal is inconsistent with quantity of signal. In the case of microphones, high

quality of reproduction is accompanied by *diminished* output. Similarly, in the case of transformers, high quality can only be secured *at the expense of quantity of signal*, which means that high ratios *must be* dispensed with so long as the usual grade of transformer steel is used.

The next important consideration which emphasizes the necessity of low ratios is the primary impedance (A.C. resistance) of the transformer. Transformers are connected as shown in Fig. O with primary in the plate circuit and secondary across filament and grid. But, as the grid is at a negative potential, the secondary may be considered as though on open circuit. Therefore, the total amplified voltage produced is directly proportional to the voltage available across the primary inductance L_p , and for purposes of discussion we may regard the circuit as a reactance-coupled amplifier.

In a reactance-coupled (plain coil

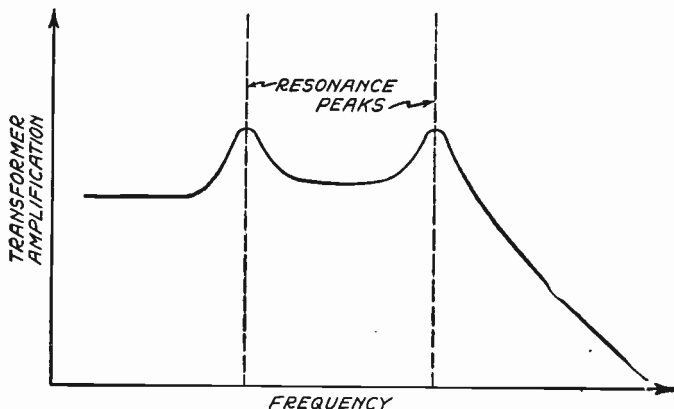

WHAT TWO DISSIMILAR TRANSFORMERS MAY DO

Figure R: The curve shown is the combined effect of using a transformer which has one resonance point in the first stage, and a transformer with a different resonance point in the second stage.

coupled) amplifier the voltage developed across the reactance depends upon the ratio of the plate reactance to the internal resistance of the tube. The greater the reactance the greater the voltage across it. But, when the reactance reaches a value of about three times that of the valve resistance, almost maximum voltage is developed across it. Theoretically, maximum voltage is developed across the reactance when it is infinite, but for all practical purposes we may consider that maximum voltage is developed across a plate reactance when its value is three times that of the tube resistance. For any values of the reactance below this, the voltage developed across it will be less than the maximum.

Inasmuch as the reactance of a coil is directly proportional to the frequency, maximum voltage amplification will not be secured unless the above condition is met at all frequencies. To illustrate with an actual problem, consider the case of a transformer whose primary

has an inductance of 10 henrys (the henry is the unit of inductance) connected in the plate circuit of a tube with plate impedance of 20,000 ohms. The reactance of the primary is given by $6fL$, where f is the frequency and L the inductance. At 1,000 cycles the reactance is equal to 60,000 ohms, which is three times the plate impedance of the tube. Above 1,000 cycles the reactance becomes greater but the voltage developed across it is practically constant. Thus, full maximum amplification is secured above 1,000 cycles with this transformer. Below 1,000 cycles, however, the reactance is less than that required for maximum voltage, and the amplification is correspondingly decreased.

The characteristics of such a transformer are shown in Fig. S and it is seen that the low frequencies are not reproduced properly. In order that the low frequencies be taken in by the transformer, its primary inductance must be considerably greater than 10 henrys.

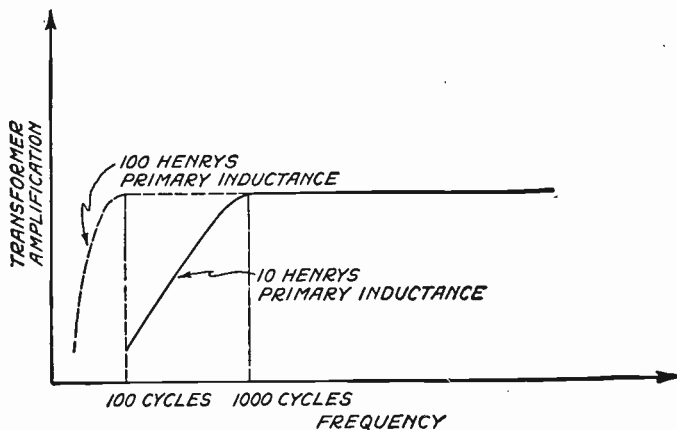

WHAT HAPPENS WHEN THE PRIMARY INDUCTANCE IS LOW

Figure S: If the inductance of the primary winding of the transformer is too low, the low notes are lost because they are not properly amplified. Speech or music will then have a shrill, tinny sound.

If the primary inductance were 100 henrys, maximum amplification would be secured at 100 cycles and over, but frequencies below 100 would be dropped out. The condition, therefore, for securing the very low frequencies is that the primary inductance must be very great, in fact high enough so that its reactance at the lowest required frequency is three times the tube impedance.

But high inductances cannot be secured unless a great number of turns are used on the iron core, and for a given transformer ratio the secondary turns go up proportionally with the primary turns, which produces an increase in the distributed capacity, and a loss of high frequencies. Thus, the conditions for securing the low frequencies conflict with that for securing the high frequencies. As a result, unless radical changes are made in the weight and dimensions of an audio transformer, a compromise must be struck between the conditions for se-

curing both low and high frequencies. Constants must be chosen which will not make the low frequency cut-off point too high.

The above limitations to securing a flat top characteristic for an audio-frequency transformer are, in the final analysis, the result of restricting the weight and dimensions of the transformer. It is desirable to economize both in space and weight, and as a result, transformers are generally made small with not much iron. This introduces the various distortions which are present.

The relationship between the various factors involved in the magnetic circuit of an iron core is shown in Fig. T. This curve shows the flux density (flux density is the number of magnetic lines of force in a sq. cm.), or number of lines of magnetic force for a unit cross-section of the core, produced by any magnetizing force, which is proportional to the product of the current and the number of

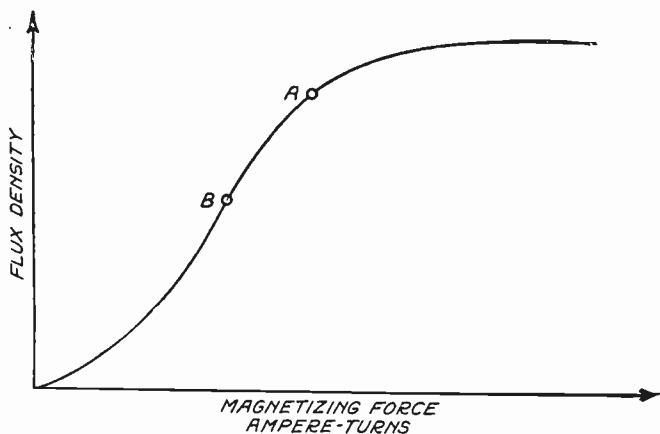

THE SIZE OF THE TRANSFORMER CORE IS IMPORTANT

Figure T: Small audio-frequency transformers often distort because the iron core is so small that it is magnetized to the point A on the curve where variations of the plate current above and below this point do not produce equal voltage variations on the grid of the next tube. The flux density should be such that the magnetization of the core will lie at point B on the curve. Thus it is seen that the volume of iron in a core is important.

turns of wire through which it flows.

The inductance of any winding on a closed iron core, as, for example, the primary of an audio frequency transformer, depends on the number of turns and the total flux threading the core (not allowing for leakage which is small for a closed core). For a given flux density, the total flux threading the core is proportional to the cross-section of the core. When the cross-section of core is small, as is the case in the average amplifying transformer, the flux density must be high in order that a given flux be produced. From Fig. T it is seen that a high flux density can only be secured by a correspondingly high magnetizing force. As the d.c. plate current is fixed for any given tube and operating conditions, the number of turns must be high to secure the necessary magnetizing force. The smaller the cross-section the greater must be the number of turns.

For any given transformer ratio this results in a correspondingly higher number of secondary turns, with resultant increase in distributed capacity. The consequence is that high-frequency distortion is produced, as explained under the discussion of distributed capacity.

If the size of the transformer core were increased, a given flux could be produced by a smaller flux density. For a given tube and plate current this would be secured with a smaller number of turns which, in the case of a transformer of given ratio, would result in lower distributed capacity and less high-frequency distortion. The larger the transformer the less the high-frequency distortion.

It can likewise be shown that the low-frequency distortion decreases as the size of the transformer increases. For a given flux density and number of turns the total flux threading the larger

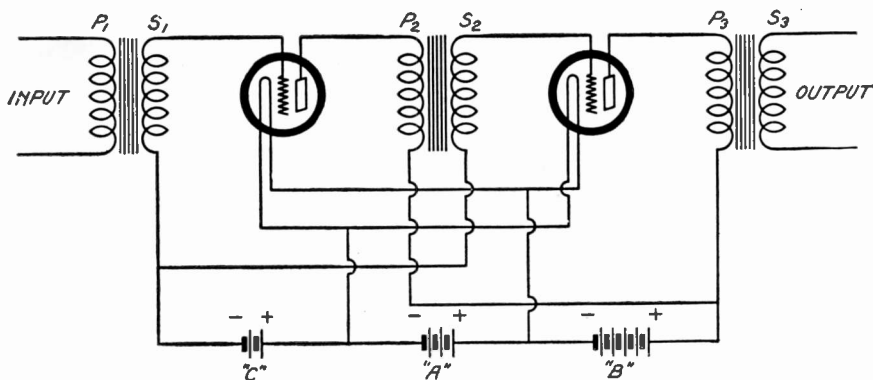

THE TRANSFORMER-COUPLED AUDIO-FREQUENCY AMPLIFIER

Figure U: This is a standard amplifying circuit with the exception that there is included, in the grid circuits, a grid-biasing battery called a "C" battery. This will often help to reduce distortion in a circuit of this kind. C batteries also greatly aid in cutting down distortion in plain audio-frequency amplifiers of conventional design. However, they are practically necessary with push-pull systems.

cored transformer is greater. Therefore, the inductance will be greater, and it will take in more of the low-frequency range than a smaller transformer for reasons explained in the discussion on primary impedance. The distortions thus produced are a dropping out of the lower and upper range of frequencies.

There is another type of distortion introduced different from those mentioned above—the introduction of new frequencies. This is due to saturation of the iron core and is most likely to occur in small transformers. The current flowing through the primary of the transformer may be resolved into two components; first, the direct current of the tube, and second, the audio-frequency alternating current. The direct current is the larger of the two, and produces a certain magnetizing force and flux density which are constant. Suppose that these values are such that the transformer operates about point A of Fig. T. Then the audio-frequency current produces variations in the flux

density which produce corresponding variations in voltage.

However, equal variations of the magnetizing force above and below point A of Fig. T do not produce equal variations of flux density, due to the shape of the curve. In other words, the wave form of the secondary voltage is different from that in the primary of the transformer, which means that distortions have occurred in the original sound. An alteration of the wave form of voltage is equivalent to the introduction of frequencies other than those originally present. If the transformer were large enough to permit the direct current of the tube to magnetize the core to the extent indicated by point B of Fig. T, this distortion would not occur, for equal variations in the audio-frequency current above and below point B would produce equal variations in flux density above and below B, because the transformer is now being worked on the straight-line portion of its magnetizing curve. This effect is similar to the

working of a vacuum-tube amplifier on the straight-line portion of its characteristic rather than at the saturation point where distortions enter.

The conclusion to be drawn is that the quality of an audio-frequency transformer improves with increase in its size and the amount of active iron in it. Very small transformers are bound to give poor quality. In the past, manufacturers have been guided more by considerations of space and weight economy than by considerations of quality. This policy must now be reversed if high quality standards are to be maintained. By proper design of the transformer, by proper choice of turns ratio and transformer constants, and by a careful selection of materials, distortionless transformers *may* be made.

The ideal audio-frequency amplifier should operate without distortion, have a uniform amplification factor for all frequencies and intensities within the predetermined range, and at the same time deliver the maximum power obtainable from the tube used at the predetermined maximum intensity of input.

The amplification curve of the amplifier, plotted against frequency with constant input e.m.f., must be flat, within the range of frequencies predetermined. If this is not the case, certain notes will be heard louder than the rest, or certain harmonics will be disproportionately loud, and the effect will be distorted reproduction.

In order that these requirements may be fulfilled, it is often necessary to sacrifice efficiency in intensity and amplification to obtain quality. Usually it is possible to amplify *perfectly*, with two stages, to the same intensity as could be done *imperfectly*, in one stage.

The most commonly used audio-frequency amplifier is the transformer-coupled type. It will be seen from the

diagram in Fig. U that the first tube is coupled to the input circuit through a transformer, the primary of which, P1, is suited to the impedance of that circuit. In receiving equipment, the detector tube characteristics determine this impedance and in broadcasting equipment, it is the microphone. Any variation in primary current will produce a corresponding alternating electro motive-force (e.m.f.) across the secondary coil, S1, which e.m.f. is impressed on the grid circuit of the first tube. A corresponding change in plate current of this tube occurs, along the characteristic of the tube, which current flowing through winding, P2, of the second transformer produces an alternating e.m.f. or voltage across winding, S2. The plate current flowing through winding, P3, produces an alternating e.m.f. at secondary winding, S3, in the same manner as outlined above for the previous stage. The winding, P3, is determined by the second tube's plate impedance and S3 depends on the output-circuit impedance. The output circuit, in the case of a receiving outfit, is a loud-speaker or headset. Quite often, the third transformer is omitted and the headset or loudspeaker is placed directly in the plate circuit of the last tube. For a transmitter, the output circuit may be a larger amplifier tube or a modulation system.

The transformer-coupled amplifier is the *most efficient* type of audio-frequency amplifier but, in most cases, the *poorest* from the point of view of quality of reproduction. It takes advantage of the amplification constant of the tube and, in addition, by means of a step-up ratio of the transformers, the secondary voltages are raised so that with the present receiving tubes having a voltage-amplification constant of about 6, it is possible to obtain amplification as high

as 20 or higher. However, distortion is introduced mainly because iron-core transformers must be used. There is a steady value of plate current flowing through the primaries, and when variation takes place, the operation is not within the straight line portion of the B-H curve of the laminations. In addition, a minute hysteresis loop is traced, introducing distorting harmonics. The frequency range of the transformers is also usually limited, the best of transformers showing good behavior only over a range of up to 2,000 or 3,000 cycles.

As was already mentioned, the chief difficulty with the transformer-coupled amplifier lies in the fact that the cores of the transformers are *saturated* by the plate current of the tube, flowing

through the primary winding. By use of a larger core this may be partially overcome but, at the same time, the core losses will be increased, causing a lessening in the efficiency of the transformer so far as intensity is concerned.

It is possible to avoid this difficulty and yet to get the same or a greater amount of amplification by making use of a back-to-back or push-pull connection thus eliminating the constant value of flux in the cores.

The connection for two stages is shown in Fig. V. The operation of the input transformer is the same as in the first-mentioned type except that there is a mid-tap on the secondary connected through a negative-grid-bias battery to the filaments. At a given instant, the outer terminals of S1 will be positive and

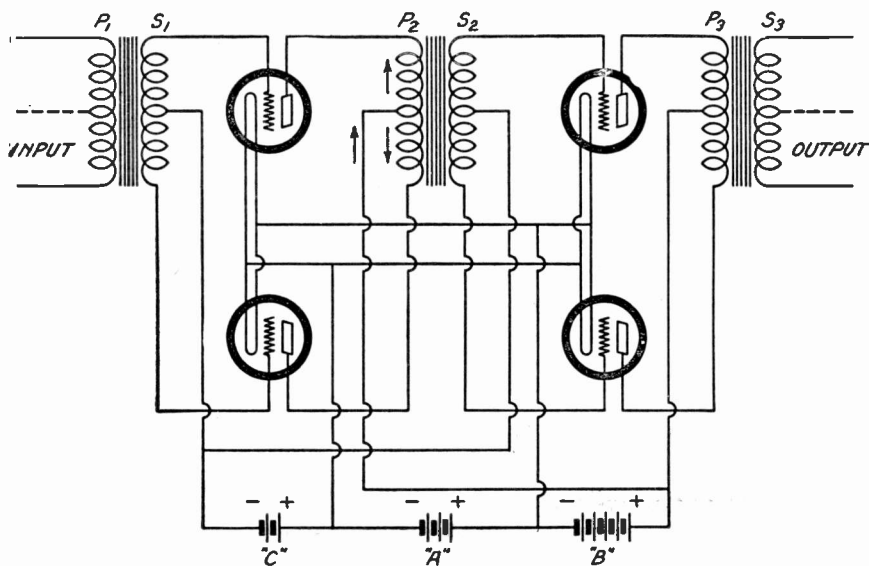

THE PUSH-AND-PULL AUDIO-FREQUENCY AMPLIFICATION CIRCUIT

Figure V: By means of split-winding transformers and the use of two tubes per stage, the distortion due to the permanent magnetization of the iron cores is eliminated. This type of amplification gives exceptionally good reproduction

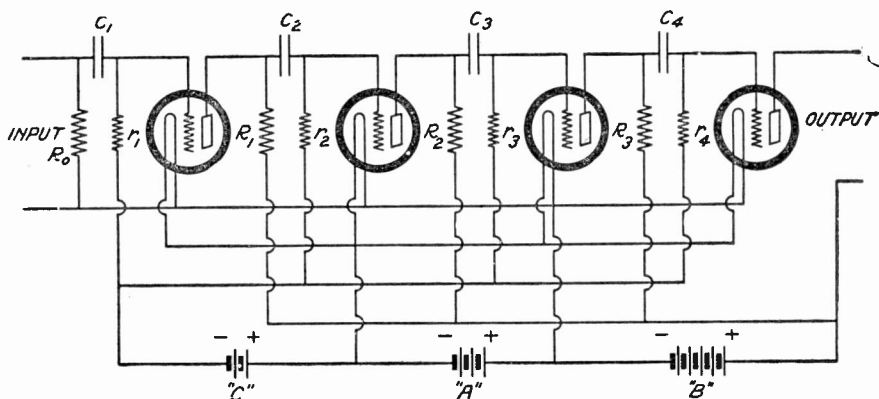

THE RESISTANCE AND CONDENSER-COUPLED AMPLIFIER

Figure W: If properly designed this type of amplifier will give better reproduction than either of the other two types of transformer-coupled amplifiers. This scheme is almost universally used in broadcasting for amplifying voice-currents before impressing them upon the transmitter. Slightly modified, this system also lends itself to amplification in reception.

negative respectively so that the grids of the tubes in the first step are 180 degrees out of phase. The corresponding plate currents will be increasing and decreasing, respectively. Before any disturbance is made, the plate battery currents will be as indicated by the arrows and since the tubes are identical and have the same grid potential, the plate currents will be equal and flow in opposite directions in the transformer winding, P2. At equilibrium, therefore, there will be no flux in the core of the transformer, but when an alternating e.m.f. is impressed on the grids of the tubes, as described above, there will be a resultant flux in the core which will induce an alternating e.m.f. in winding, S2. The action is the same in the second step through the output transformer as described in the first case. The dotted mid-tap shown on the input transformer is necessary if a double button microphone had been used or if the previous steps had been from a similar amplifier. If the back-to-back principle is followed

through further amplification, the output transformer must also be tapped as indicated by the dotted line,

It would appear that the amplifier just described would be only fifty percent as efficient as the standard transformer-coupled type, but when it is remembered that for the same total output, tubes of only one-half the output rating may be used in the push-pull amplifier, it is understood that the two are equally efficient. In addition, the push-pull amplification transformers have no steady flux in their cores so that the quality of reproduction as well as the range of frequencies is bettered. There remains, however, the distortion due to operation over the hysteresis loop which is always present in an iron-core device.

Transformer-coupled amplifiers of either type are decidedly limited as to frequency and are not, unless carefully designed, faithful in their reproduction due to the introduction of harmonics from iron cores. The resistance and condenser-coupled amplifier shown in Fig.

W is decidedly better from these points of view. It is, at once, obvious, however, that it is impossible to get an amount of amplification from each tube greater than that determined by its own amplification factor. Even this condition is never reached, as will be explained later. The input may be through a transformer as before or it may be through a coupling resistance and condenser from a smaller tube as shown. The condensers C1, C2 and C3 are identical for the same type and size of tubes as well as the grid resistances, r_1 , r_2 and r_3 and the plate resistances R_1 , R_2 and R_3 .

In addition to the grid leaks, it is often advisable to use a grid battery to establish the proper operating grid potential. The battery is shown at C. When an alternating e.m.f. is impressed across the input terminals, that same e.m.f. will operate on the grid of the first tube, with the exception of the small drop in the condenser C1. By making the condenser large, the maximum possible impressed voltage is assured. If this impressed voltage is increasing in a positive direction, the plate current of the first tube will increase, causing the drop across R_1 to increase. As the battery voltage sup-

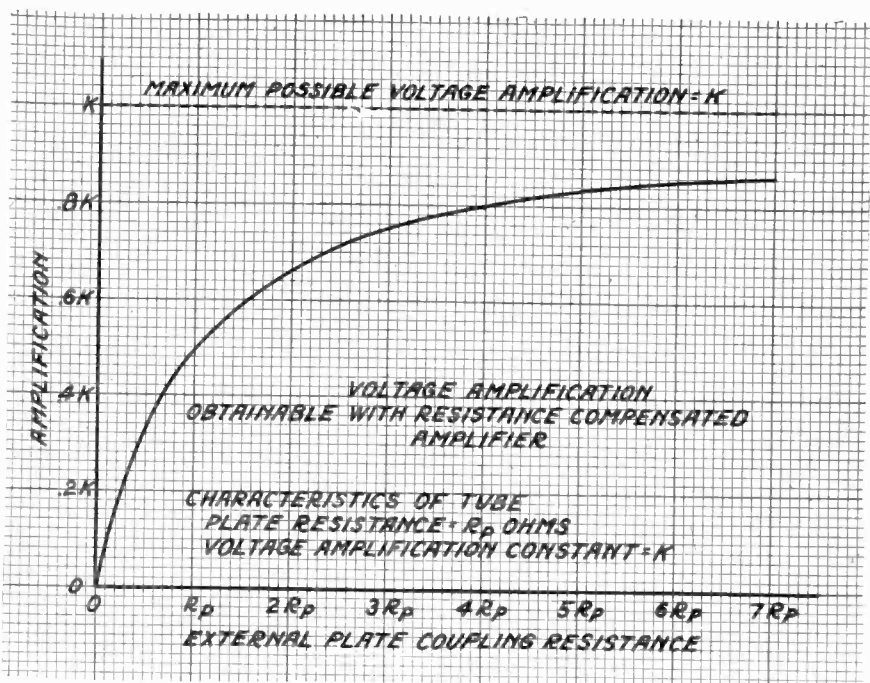

THE MAXIMUM AMPLIFICATION THAT CAN BE OBTAINED WITH THE RESISTANCE-COUPLED AMPLIFIER

Figure X: It will be noticed that, as the value of the plate resistance is increased, the amplification obtainable is also increased up to a certain point, where it remains constant.

plying the plates is constant and the battery resistance is small in comparison to that of the remainder of the plate circuit, the plate voltage of the first tube will be decreased correspondingly. This decreasing voltage is impressed across the grid and filament of the second tube where the same process is repeated and so on throughout the other stages of the amplifier,

Assuming the drop in the coupling condensers to be negligible (this will be treated in detail later), it is possible to express the amplification per tube as follows.

Let,

I_p = effective value of the a.c. component of the plate current of tube No. 1.

k = voltage amplification constant of the tube.

E_{g1} = effective value of a.c. voltage impressed upon the grid of tube No. 1.

R_p = a.c. plate-to-filament resistance of the tube.

R_1 = external plate coupling-resistance, as shown.

$$\text{then } I_p = \frac{k E_{g1}}{R_p R_1}$$

E_{g2} the effective value of a.c. voltage impressed upon the grid of the second tube, will be

$$I_p R_1 = \frac{R_1 k E_{g1}}{R_p R_1} = E_{g1}$$

and the ratio
$$\frac{E_{g2}}{E_{g1}} = \frac{k R_1}{R_p R_1}$$

which is the voltage amplification obtained per stage of tube.

It is thus seen that as R_1 is made large, the maximum amplification obtainable is of the value, K . The accompanying curve shows this action graphically. It must be remembered, however, that as R_1 is increased, it is necessary to increase the voltage of the plate battery accordingly, or the normal voltage on the plate of the tube is so decreased that its amplification constant is decreased.

The drop across the grid-coupling condensers, as has been mentioned before, must be small in comparison to the total value, $I R_1$. In other words, the reactance of the grid condenser must be small in comparison to the resistance of the parallel circuit, composed of the grid-leak resistance and the internal grid-to-filament resistance of the tube. Here again, the wide range of frequencies, to be accounted for, establishes a weakness. Since 25 cycles was taken as the minimum frequency, the condensers must have a comparatively large capacity. But when the condensers are made large, another consideration enters. If the grids of the tubes were operated free, that is, with no grid leaks, which corresponds to an infinite leak resistance, the action would be erratic.

In the above condition, a sudden stray negative voltage on the grid of a tube might cause the plate current of that tube to drop to zero. Due to the insulation of the grid through the condenser, the plate voltage would not appear until the charge was removed from the grid. This action is commonly termed "blocking" of the tube, and it is for this reason that the leaks are used. Now if a condenser, C , and a leak, R , are used on a tube, the time for the grid to resume its operating potential is defined by the time constant, RC seconds. If, therefore, the capacity of the condensers is increased, the amplifier will tend to distort so that to bring the time constant back to the proper value defined by the frequency of the highest note, the resistance of the grid leaks must be decreased. In so doing, the drop $I_g R_g$ which is the actual voltage affecting the grid will be reduced. It is therefore seen that the proportioning of leak resistance and condenser capacity is a compromise. A further

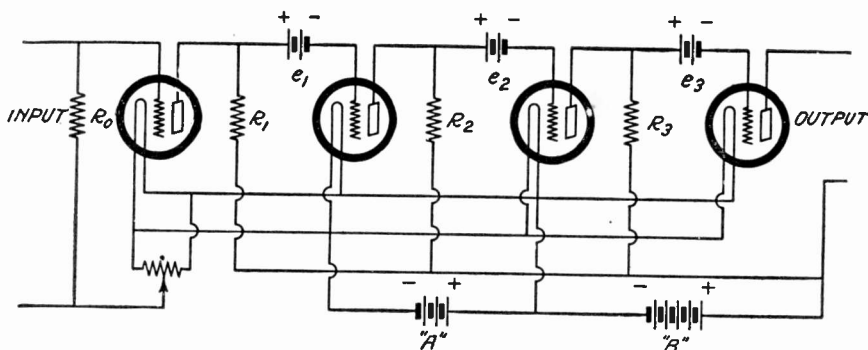

THE APERIODIC RESISTANCE-COUPLED AUDIO-FREQUENCY AMPLIFIER

Figure Y. This is at the same time the purest reproducer and simplest of the resistance type of amplifiers. Although its over-all amplification is by no means as great as in the case of the transformer-coupled type, nevertheless it has its peculiar advantage, because all possibility of distortion is eliminated.

effect in this amplifier enters when the leak voltage drop is made to compare with the condenser drop. In this case, the amplifier will operate with greater intensity on notes of higher frequencies because the ratio of leak voltage to the voltage drop across the condenser changes appreciably.

From the above discussion, it is obvious that the plate coupling-resistances may be displaced by high-inductance chokes of comparatively low resistance. In this way, greater amplification may be obtained from a plate battery of the same voltage. However, the element of iron losses and distortion due to the iron core enters to counterbalance the increased amplification.

Due to the more faithful reproduction obtained, the resistance and condenser-coupled amplifier described above has been adopted to considerable extent for the speech input amplifiers on broadcast transmitters. The practice has been to use more tubes and get good quality rather than to use transformer-coupling with its high amplification and possible introduction of distortion. The resistance and condenser-coupled am-

plifier, however, is limited to the upper frequencies, but since most musical and speech reproduction is above 200 cycles, satisfactory operation is obtained.

There is an amplifier that is simpler than the ones described above which responds uniformly to all frequencies from zero, or d.c., to about 100,000 cycles, at which frequency the internal capacity-coupling in the tube limits the operation. In other words, it is an *aperiodic* amplifier. Its circuit for four stages is shown in Fig. Y. The plate coupling-resistances, R_1 , R_2 , R_3 , are designed in the same manner as in the case of the resistance and condenser-coupled amplifier. The grids are coupled *conductively* to the plate of the preceding tube through a small battery. It is the purpose of these batteries to neutralize the plate voltage and thereby to establish the proper potential on the grid. Since there are no condensers or inductances in the circuit, all possibility of distortion is minimized. Further, it will be seen that there is a through conductive path, making d.c. amplification possible. It is a simple matter to positively adjust this amplifier.

The apparatus required for a four-stage unit is as follows:

- 4 Western Electric 216-A vacuum tubes or equivalent;
- 4 sockets for above tubes;
- 6 Western Electric 38-A, 48,000-ohm resistance units (or equivalent) 96,000 ohms per plate;
- 1 "A" battery potentiometer, 200 to 400 ohms;
- 1 D. C. milliammeter, 0-25 milliamperes;
- 1 input discharge resistance, 50,000 to 100,000 ohms;
- 1 storage "A" battery, 6 volts;
- 1 "B" battery, 120 volts, capable of delivering 50 milliamperes;
- 3 "C" batteries, 45 volts each, adjustable, current practically nil.

Be sure that all connections are as illustrated in Fig. Y in the section explaining the theory of the amplifier. Obtain the static characteristic curves for the tubes used, so that the value of plate current for proper operation may be determined. For the 216-A tubes, this is about 9 to 15 milliamperes, and is obtained for the last tube when the grid is connected directly to the negative filament lead. When these tubes are used, disconnect the grid of the last tube from the negative of e_3 , and connect it temporarily to the negative filament terminal. Note the plate current as read for the last tube on the milliammeter, say 11 milliamperes. Now disconnect the grid of the third tube (from the left on diagram) from the battery, and connect it to the negative filament, at the same time connect the grid of the fourth tube to its battery. Adjust the connection of e_3 until the original normal plate current is restored to the last tube, 11 milliamperes in this example. Connect the grid of the second tube to negative filament, and adjust e_3 to give normal plate current in the last tube. Finally connect the grid of the

first tube to negative filament and adjust i_2 for normal plate current in the fourth tube. The complete amplifier, excepting the first stage, is now correctly adjusted to give maximum amplification with minimum distortion. The critical adjustment on the first tube is made when the input transformer has been connected. Under this condition, the potentiometer is regulated until the plate current of the last tube is once again restored to normal value.

The amplifier is simple and easy to operate, once the initial adjustments have been made. One point must be continually observed; *the plate current of the last tube should not be allowed to change or "dance."*

Any movement of the needle on the meter indicates the presence of distortion. It is best to provide a means for controlling the input to the amplifier, and, by means of this control, the current must be kept steady and fixed.

The introduction of the dry-cell vacuum tubes with their very special characteristics, has confused many radio experimenters who have attempted to employ these devices in amplifying systems. For the benefit of these workers there is appended a comprehensive accumulation of data along these special lines. The material, as presented, was prepared by Frank A. Hinners, R.E., after a long series of exhaustive experiments:

"Many laymen who are thinking about joining the ranks of broadcast listeners, and even large numbers of broadcast listeners of experience, find it difficult to decide when to use, and when not to use the dry-cell tubes.

"When portability is required above all else, the dry-cell tubes obviously recommend themselves. Even when portability is not a factor but the consideration of small first cost and low

upkeep is important, the dry-cell tubes have much to recommend them. The cost of a storage battery and the charging appliance represents a considerable sum, which is, of course, unnecessary with dry-cell tubes.

"The dry-cell tube used for some purposes performs quite as well as the larger storage-battery tubes, yet for other purposes it cannot equal the large tube.

"To mention some examples, the dry-cell tube fitted with the proper grid leak when used as the detector in regenerative receivers, produces results closely approaching the larger tube, if not in signal volume, certainly from the DX standpoint. Used with the proper grid leak in non-regenerative receivers in which radio-frequency amplification is *not* incorporated, results equalling but not excelling the crystal detector are the rule. Reference is made to the WD-12 tube operated from a single dry cell. Operated in this type of receiver, *without* proper grid leak, results are inferior to a crystal detector. Since we are considering the amplifying properties of the dry-cell tube here, its detector action cannot be described at length; sufficient to say that the dry-cell tubes, which are of the hard, highly exhausted type, are not especially sensitive detectors.

"In choosing between the two general types of tubes now in use, storage and dry-cell operated, the public finds itself confused by much conflicting information. Many, attracted by the lower first cost of the dry-cell tubes, buy them with expectations of a performance equal to the larger tubes. Frequently, disappointment is a result, because the listener expects too much from this type of tube—due to no fault of the tube. Were the information regarding the dry-cell tube available in quantitative

form, instead of the prevalent terms such as 'good,' 'fair' and 'poor,' the truly remarkable merit of this form of tube would become known and needless disappointments, therefore, avoided.

"In order to supply this quantitative information, a series of observations were conducted in the laboratory under conditions practically duplicating actual service.

"An audio-frequency amplifying transformer of exceptionally good electrical design, with a four-to-one turn ratio, was used. The results obtained apply strictly to this particular make of audio-frequency transformer and therefore would not be found correct for all makes of such transformer. In general, however, the differences between the amplification obtained from the various tubes hold approximately true for other transformers of similar design and of the same general characteristics.

"In Fig. Z a family of curves is shown. The vertical axis shows the audibility or current amplification. The horizontal axis shows the audio frequencies of the alternating-current voltages applied to the vacuum tubes and the audio-frequency amplifying transformer. In the test, the amplification and the frequency of the a.c. voltage applied to the grids of the amplifier were noted. The amplification, together with the particular frequency of the input current were plotted as the observation was made. A curve drawn through the points plotted indicates how the amount of amplification obtained is influenced by the varying frequencies applied to the grids of the various vacuum tubes indicated in combination with the audio-frequency amplifying transformer. The frequencies used in the experiments correspond to the basic range of frequencies produced in music and human speech.

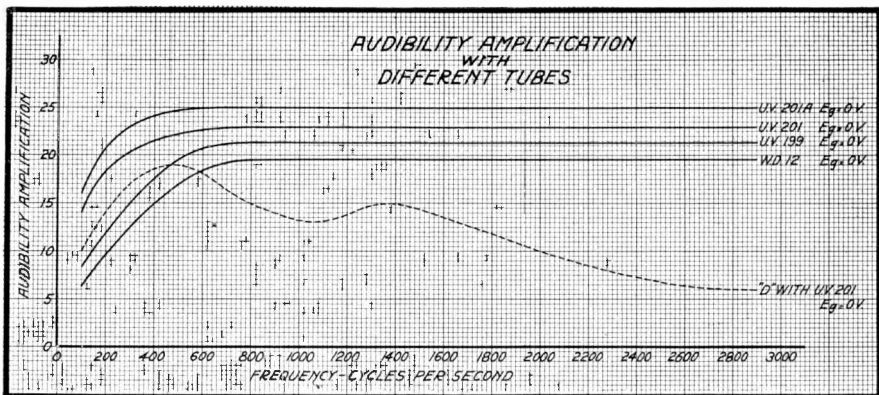

A GROUP OF FREQUENCY-AUDIBILITY CURVES FOR AMPLIFYING TRANSFORMERS

Figure Z: The four top curves in heavy black lines show the audibility record of one transformer used in connection with four different types of vacuum tubes. Notice that the amplification is constant over a wide range of audio frequencies. This is a good transformer; it does not distort but it amplifies with equality all the frequencies within the range shown. The lower dotted curve shows the audibility of a poor transformer. Notice how the amplification falls off at the higher frequencies. This transformer would produce distortion. It is unusual to find vacuum tubes of different manufacture that will give the same curve with the same transformer. Oftentimes tubes of the same manufacturer will not do this.

"At points where curvature appears the change in amplification noted is the direct result of the particular frequencies applied to the grids of the vacuum tubes. At these frequencies, tones emitted from loudspeakers and headphones operated by the transformer and vacuum tubes cannot correspond, in point of volume, to the original tone acting upon the microphone in a broadcasting station. This effect is known as 'distortion,' and appears wherever the output does not reproduce the input with fidelity.

"To illustrate to what an extent an audio-frequency transformer of poor design may be held accountable for distortion, the characteristic curve of another transformer has been added, which appears as curve 'D.' Obviously a transformer that produces such an erratic characteristic would be unsuited to broadcast reception. Yet, a considerable number of such transform-

ers are being offered to the public and enjoy a wide sale.

"The ideal transformer would produce a straight line parallel to the frequency scale. Although the transformer used in these tests has a sloping characteristic below 600 cycles a second, at higher frequencies it produces practically uniform amplification. For this reason it is well suited to these measurements, as we are in quest of information on vacuum-tube performance.

"In these measurements the amplification is expressed as 'times audibility' and represents the number of times the telephone current has been multiplied in passing through the particular vacuum-tube and transformer-combination used.

"In all curves shown in Fig. Z, the voltage applied to the plates of the various vacuum tubes used was 67.5, a voltage most frequently specified by transformer manufacturers. The grids of all tubes tested were connected to the

DRY CELL TUBE DATA

1 Tube	2 Current Ampli.	3 ONE STAGE		5 % Diff.	6 Current Ampli.	7 TWO STAGES		9 % Diff.
		4 % Output	Energy Ampli.			8 % Output	Energy Ampli.	
201-a	25	625	100	0	625	390,000	100	0
201	23.5	550	88	12	550	300,000	77	23
199	21.5	460	73	27	460	210,000	54	46
WD-12	19.5	380	61	39	380	144,000	37	63

negative-filament terminal. This connection is standard with most amplifier and receiving-set manufacturers.

"In the table on this page the results obtained from the curves in Fig. Z have been entered, together with some further information obtained by calculation. The theoretical energy amplification obtained with UV-201-a tubes has been made the standard of comparison, its value being expressed as 100 percent.

"The sound volume delivered by headphones and loudspeakers is governed by the electric energy supplied to them. The current increase due to amplification, in itself is not a direct indication of the comparative sound output that either the headphone or the loudspeaker may be expected to produce. To determine the comparative sound volumes that may be produced by headphones or loudspeakers operated by various tube combinations, it is necessary to express the measured current or audibility increase as energy amplification, inasmuch as such devices are energy-operated.

"The energy amplification may be assumed to vary as the square of the current amplification because the impedance of the load circuit was main-

tained constant as well as larger than the internal plate impedance of the vacuum tube. This assumption is quite correct, as the relative amplification values noted in the above table are taken along the flat portion of the characteristic and thus free from the influence of frequency changes.

"The energy amplification computed in this manner is noted in column 3.

"Column 4 shows the percentage output produced by the various tubes specified in terms of 201-a output. Column 5 shows the percent difference in output of such tubes in terms of the 201-a output.

"From the observations noted in columns 3, 4 and 5, it will be seen that the WD-12 tube used as a single-stage audio-frequency amplifier delivers an energy output, equivalent, in round numbers, to 60 percent of the 201-a tube output, representing a 40 percent sacrifice in result. In the case of the 199, these figures become 73 and 27 respectively, representing a smaller sacrifice in result, namely, 27 percent.

"Instead of using the percentages of column 4, let us refer to the energy amplifications listed in column 3.

"Suppose we consider the electric energy fed to the amplifier by the de-

tector as the energy unit. One stage of audio-frequency amplification would produce a sound volume 625 times larger than this unit with the 201a tube; 550 times with the tube 201,* 460 times with tube 199 and 380 times with tube WD-12. These values differ considerably numerically on paper, yet the differences seem less impressive to the ears of the listener.

"Two stages of audio-frequency amplification are more widely used by the listener and for this reason an appraisal of the dry-cell tube's performance in this field will perhaps prove of even greater interest. To carry these observations this further step forward, calculations are again necessary.

"Amplifiers arranged in cascade amplify in geometric progression if the voltage applied to each of the grids falls within the straight portion of their grid-plate characteristic; that is, voltages whose values are below the bend in this characteristic. When so operated, the result produced by two stages of amplification 'A' becomes the product 'A x A.' This relation applies to the amplification whether expressed as current or energy amplification. In either case the amplification for two stages is the product of the amplification of the individual stages, however expressed, and if each stage produces the same amplification 'A' the result of two stages is 'A².' In the case of three stages of audio-frequency amplification, were there are no very serious practical limitations, the over-all amplification produced would correspond to the third power of the amplification of the individual stage, equal amplification, of course, being obtained from each of the stages.

*The improvements in storage-battery-operated tubes are also clearly indicated. It is to be observed that tube 201-a produced a trifle less than 14 percent more energy amplification than the older 201 tube. This by

"This geometric relation which governs the operation of the cascade amplifier is of the greatest significance, and yet it is little known to the radio listener.

"Vacuum tubes are rated in terms of their individual performance, but their operation in the cascade arrangement leads to results of a different order. Differences noted in their individual performance, which may be quite small, assume astonishing proportions in the cascade arrangement.

"It may be of some interest to note how the action of the cascade arrangement would differ if it obeyed arithmetical instead of geometrical law. The case, it should be remembered, is purely hypothetical and except for purposes of illustration, it has no value whatever. Were the amplification arithmetical, two such stages of amplification would equal the sum of the individual amplification of the two stages. The values of columns 6 and 7 would be only twice as large as the values of columns 2 and 3. A far greater number of tubes would be required to produce the amplification values noted in columns 6 and 7. The percentages noted in columns 8 and 9 would not, however, differ from those of columns 4 and 5.

"Take the 199 tube as an example: This tube was 73 percent as effective as the 201-a tube. It produced 165 less energy units than the 201-a tube. Two such stages of amplification obeying arithmetical law would lack another 165 energy units, reaching a total of 330 units. This would, however, still be equal to 73 percent of the amplification produced by two 201-a tubes.

"Actually, however, because the over-all amplification is the product and not

itself is a considerable improvement but, when accomplished with one-fourth of the filament current formerly needed, represents a decided advance in the art of vacuum-tube manufacture.

the sum of the individual amplification of each tube, the resultant amplification becomes $.73 \times .73$, or 54 percent.

"Referring to the table we find two stages of 199 and WD-12 are, respectively, 54 percent and 37 percent as effective as two stages of 201-a amplification. The comparative loss or sacrifice in volume for two stages of 199 and WD-12 becomes 46 percent and 63 percent, respectively. Differences in performance of this order, which are enormous indeed, account in large measure for whatever disappointments listeners experience in their use of the dry-cell tubes.

"These differences may be more strikingly illustrated by referring to column 7 of Table 2. Here the over-all, calculated energy amplification has been entered. Also in this case consider the energy fed to the first amplifier tube as the unit. We find that if two 201 tubes replace 201-a tubes of like number, the energy is increased 300,000 fold. For two 199 tubes, 210,000 fold, and WD-12 tubes, 144,000 fold.

"Now with two 201-a tubes an amplification of 390,000 fold was noted. If we consider the loss of energy units, it is to be noted 90,000 units less are obtained with 201 tubes;* 180,000 less with 199 tubes, and 246,000 less with WD-12 tubes.

"From the data obtained it must be apparent that when cost is weighed against results, the use of the dry-cell tube as a single-stage, audio-frequency amplifier is wise economy.

"However, weighing cost against results, the dry-cell tubes used in the amplifier of two stages do not, in the opinion of many, represent real economy. Considering the investment represented by the receiving set, two-stage amplifier, vacuum tubes, loudspeaker and sundry accessories, the added storage-battery and charger cost is not prohibitive, particularly as each of these units is so much less effective when dry-cell tubes are used.

"It should be noted, however, that the two-stage amplifier that uses dry-cell tubes produces an amplification many times greater than the amplification of the single-stage amplifier using the larger tubes. When it is considered that the two-stage amplifier fitted with dry-cell tubes costs less than a single-stage amplifier that uses the larger tube provided with its complement of storage battery and charger, the former has much in its favor. Do not, however, look for performance approaching the two-stage amplifier fitted with storage battery tubes."

*Here it is to be observed that the two-stage audio-frequency amplifier using 201-a tubes produces 80 percent more energy amplification than the older 201 tubes.

SECTION VIII

Radio-Frequency Amplification

THE engineering sages have it that radio-frequency amplification with unit controlled tuning mechanism, represents the Philosopher's Stone of wireless communication. It seems, too, that manufacturers are aiming more and more toward receivers of this type because of their great sensitivity and the possibility of using them without a system of clumsy wires outside the house.

Mr. L. M. Cockaday contributes in the following pages, a very agreeable treatise on the subject of radio-frequency amplification:

"Radio-frequency amplification is amplification of the current impulses received from the antenna circuit of a receiver *before* they have been rectified by the detector tube. The successive stages are coupled together with *radio-frequency* transformers.

"Before we take up the subject of how the radio-frequency amplifier works, however, let us learn of one of the disadvantages of audio-frequency amplification. That will help us to better understand the aim and purpose of amplification before detection.

"The detector tube receives radio-frequency oscillations and turns them into impulses of direct current. *But the impulses must be of a certain strength before the detector will respond to them.*

"Let us consider the case of a receiving set that employs a vacuum tube detector

and two stages of audio-frequency amplification. The set is installed in a city. Signals from stations located in the city may be detected and received with such volume as to be unbearable. This happens because the detector delivers a fairly large impulse to the amplifiers and they further strengthen them to an enormous value. Signals from stations, say 500 miles away, are only just audible with the detector alone, but when the amplifiers are used they are comfortably audible; the amplifiers take the feeble current from the detector and nourish it. Signals from across the other side of the country, however, may be too weak to be detected by the detector tube and so the amplifiers are supplied with no current and no signal is heard.

"This difficulty of the audio amplifier may be summed up in the following statement. The audio-frequency amplifier will not function on a signal unless the signal is of sufficient strength to operate the detector tube and thus supply an audio impulse to the amplifier. This is true no matter how many stages of amplification are used. Audio-frequency amplification has its use, however, as it is the most efficient method used in getting a loud signal when the initial signal is strong enough to operate the detector tube.

"Radio frequency, on the other hand, has just the opposite characteristics; by its use, weak distant signals are ampli-

fied, but they cannot be increased by this method to a value high enough to operate a loud speaker satisfactorily. Radio-frequency amplification strengthens the feeble oscillations received from the antenna circuit until they are strong enough to be detected by the vacuum-tube detector. In other words radio-frequency amplification takes place before the signals are rectified by the detector and audio-frequency amplification takes place after they are so rectified.

“So much for the general explanation. Let us now see how the radio amplifier

works. In the diagram we show a conventional circuit with two stages of radio-frequency amplification, and a vacuum-tube detector, that employs a loop antenna. The tuning elements consist of the loop inductance and the variable condenser VC. The first stage of amplification consists of the tube V1; this is coupled to the second stage tube V2 by means of the radio-frequency amplifying transformer T1. The second stage is coupled to the detector tube V3 by means of a second transformer T2, which is started by a condenser VC2, and which supplies the amplified radio-

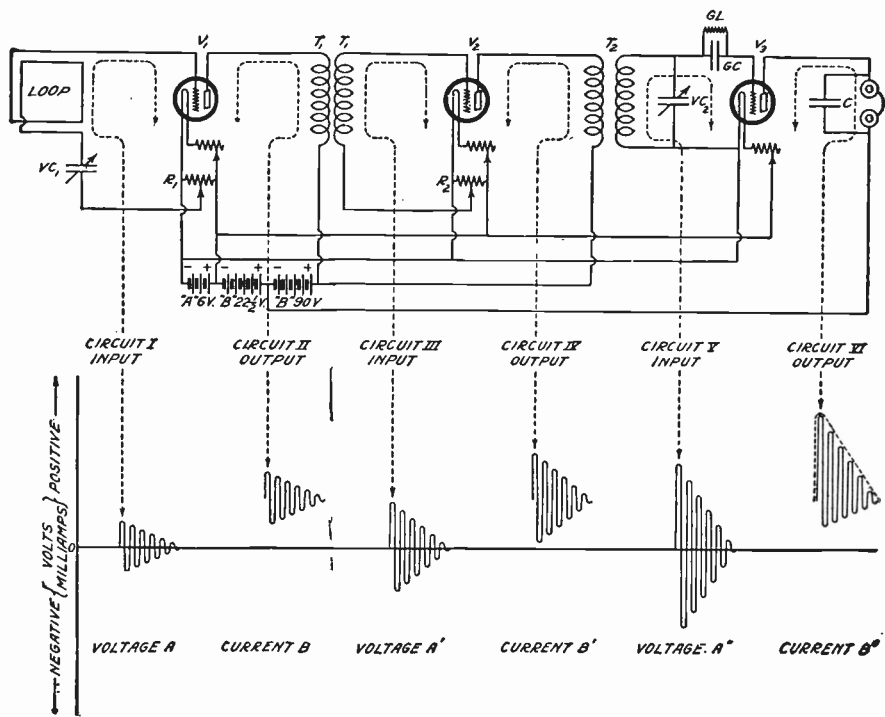

RADIO FREQUENCY ANALYZED

Figure A: The lower chart shows exactly what current changes take place in a radio-frequency amplifying circuit.

frequency impulses to the detector tube for rectification.

“A weak impulse (much too feeble to operate a detector tube, let us say) is received by the loop and tuned by the condenser VC1. This high-frequency impulse flows through the input circuit I and impresses a tiny voltage wave (A) on the grid of the amplifier tube V1. The relay action of the tube reproduces this wave form in its plate circuit II and causes a current (B) to flow through the primary winding of the transformer T1. The voltage of the impulses is stepped up by the transformer T1, and supplied by its secondary winding to the grid of the V2 in circuit No. III. This voltage is shown at A; by comparison with A it will be seen that it has been increased considerably. The tube V2 then responds to this voltage A¹ and the current wave B¹ flows in its plate circuit IV, through the primary winding of the transformer T2. Comparison of B and B¹ will show a great increase in the current value. The transformer T2 then steps up the voltage of the impulses and impresses a voltage A¹¹ on the grid condenser (GC), which passes it to the grid of the detector tube V3 in circuit No. V. Compare voltages A and A¹¹. A¹¹ is very much stronger than A.

“If A had been supplied to the detector tube direct, it would have been too weak to be detected by the tube V3 and there would have been no response in the plate circuit VI. However, the weak impulses shown at A have been amplified by the radio-frequency amplifier until they are strengthened as shown at A¹¹, when the tube V3 is able to detect them, or in other words, rectify them as shown at B¹¹ in circuit VI. This current B¹¹ flows through the bypass (see Part 9, Condensers) condenser C and the voltages on the condenser cause a low-frequency current, as indicated by the

dotted lines in B¹¹, to flow through the telephones T thus producing audible sounds.

“It must be borne in mind that the impulses on the grid of each tube oscillate about its free grid potential, and to secure maximum results the potentiometers R1 and R2 are provided as means for adjusting this free grid potential with respect to the filament.

“This same sensitivity of the radio-frequency amplifier makes it suitable for use with the loop antenna, which collects only an extremely small amount of energy, where the audio-frequency amplifier alone would fail.

“The use of radio-frequency amplification with a loop antenna for building up the strength of the feeble impulses so that the detector tubes can detect them, combined with the use of the audio-frequency amplifier to increase these audible impulses to sufficient strength to operate a loudspeaker, makes an ideal set for listening to broadcasting. And not the least of its virtues is the fact that it may be assembled complete in a case similar to that of a phonograph, with batteries, tubes, loop and all; no outside connections are necessary.

“The use of audio-frequency amplification is limited to signals which are strong enough to be detected and this method will increase the volume tremendously. The use of radio-frequency amplification is for increasing the strength of feeble impulses that are not strong enough for a detector to pick up alone.

Our discussion of radio-frequency amplification must have impressed us with the fact that the transformers used between the tubes are most important parts of the amplifying equipment. After all is said and done, successful radio-frequency amplification is a mere matter of transformer design; the transformer,

as simple as it is, has been the engineering stumbling block. We are fortunate in having this side of the question discussed for us by Mr. George Lewis, an engineer of splendid standing in the art. Mr. Lewis' work follows:

"Radio-frequency amplification has been used for a number of years in the design of radio receivers for commercial communication purposes wherein the wavelengths range from 600 to 25,000 meters. At the longer wavelengths, corresponding to those used in trans-Atlantic communication, little difficulty is experienced in obtaining good results.

"The advent of radio broadcasting at wavelengths between 360 and 500 meters, however, introduced so many new problems in transformer design, that the manufacturers of radio-broadcasting receivers seemed to favor the use of a detector and several stages of audio-frequency amplification. The operation of the vacuum tube as a radio-frequency amplifier offers far greater application than any other service at the present time. And while it is true that the vacuum tube may be utilized effectively as an audio-frequency amplifier and as a detector in receiving circuits, yet signals

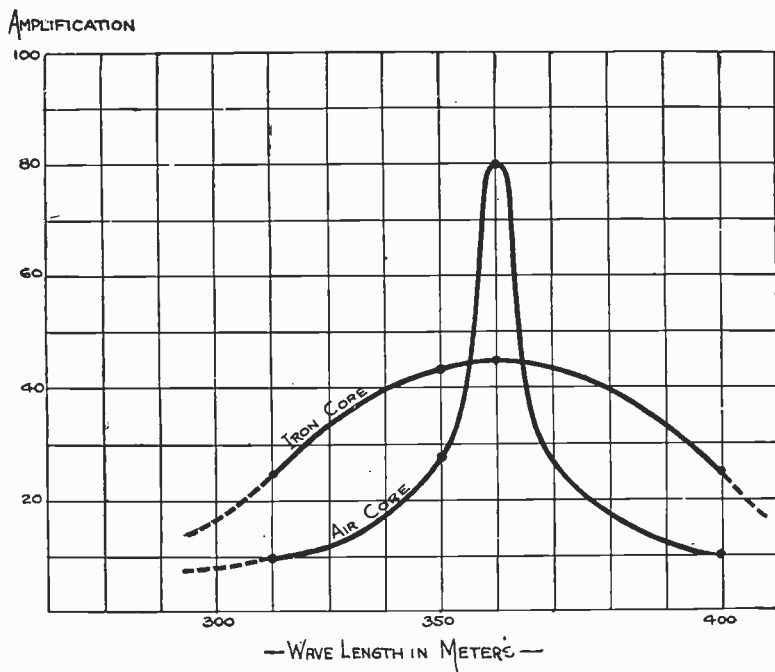

A COMPARISON OF SELECTIVITY FROM IRON-CORE AND AIR-CORE TRANSFORMERS

Figure B: These two resonance curves show the relative selectivity obtained with an air-core transformer and an iron-core transformer for radio-frequency amplification. Notice how much greater amplification is obtained on 360 meters with the air-core transformer. On wavelengths other than this, however, the iron-core transformer gives the greater amplification.

cannot possibly be received unless their strength is sufficient to operate the detector.

“In the early days of radio, communication over a certain distance was looked upon as a problem of transmitter power, as it was considered that a certain energy would be required to operate a detector and unless the transmitting station was capable of delivering this energy at the receiving point, communication could not be established. Today the problem has been altered from *transmitter power* to *receiver sensitivity*—a much less expensive proposition, brought into effect by radio-frequency amplification.

“In other words, the more modern receiving equipment brings about the

same effect as moving the transmitter up toward the receiver.

“It is an accepted fact that the output of a detector does not vary in direct proportion to the input voltage applied to the grid, but as the grid potential is lowered a certain (cut-off grid voltage) is reached below which no response is registered in the plate circuit and the electron tube ceases to function as a detector.

“This means, that signals from radio stations located at a distance so far from the receiver as to prevent potentials greater than the cut-off grid voltage to be applied to the detector tube of the receiver, cannot be recorded, even though a number of stages of audio-frequency amplification are employed.

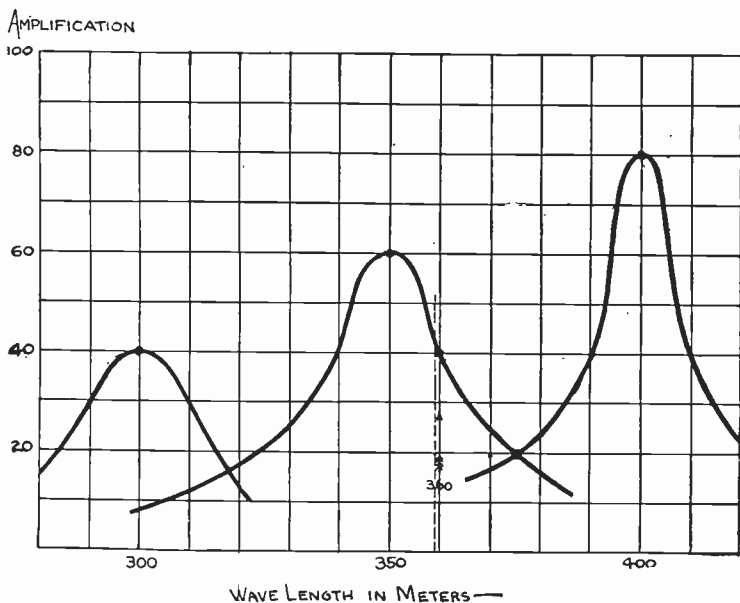

A RESONANCE CURVE FOR A RADIO-FREQUENCY TRANSFORMER

Figure C: In this case the transformer has a winding tapped in three places. The highest amplification is obtained on 400 meters. The next highest peak would be at approximately 350 meters and the lowest tap would give a peak at 300 meters. At wavelengths between these taps, however, the amplification would drop off quite severely.

“At applied potentials greater than this (cut-off grid voltage) value the output or response in the plate circuit of the detector increases more rapidly than the square of the input potential. Therefore, any arrangement that tends to increase the potential delivered to the detector will not only greatly increase the volume of detected signals, but make it possible to receive stations which would be inaudible otherwise, due to the

inherent (cut-off) factor of the detector tube. This condition immediately recommends the use of radio-frequency amplification.

“Radio - frequency amplification, in general, may be grouped in the following classes:

- 1: *inductive coupled*
 - Air-core transformers (aperiodic)
 - Air-core transformers (tuned)
 - Iron-core transformers (aperiodic)
 - Iron-core transformers (tuned)

AMPLIFICATION

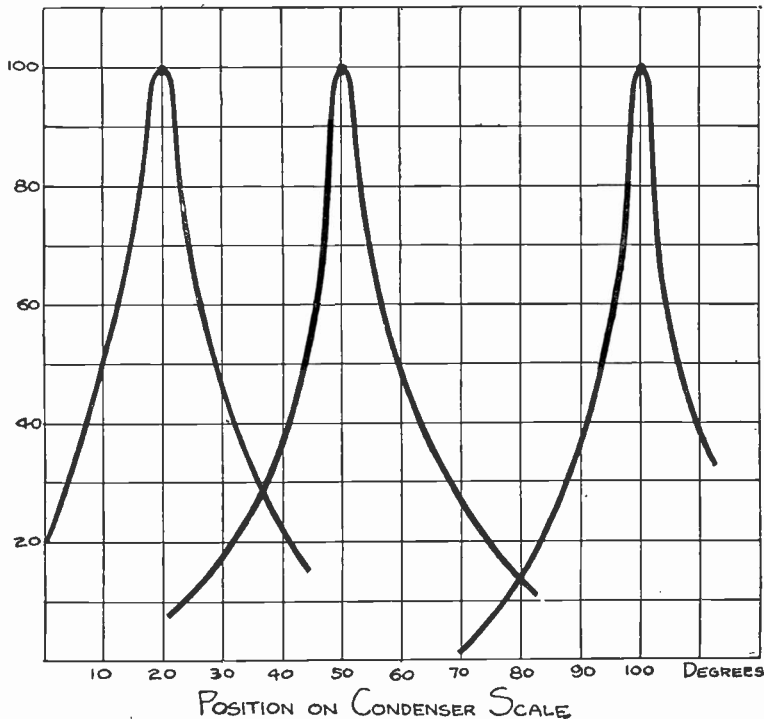

A RESONANCE CURVE FOR A TUNED TRANSFORMER

Figure D: This device would be used with a variable condenser. The condenser settings are shown along the bottom edge of the chart. These settings correspond to the wavelength ranges shown in the charts in Figures C and D. Using this method of amplification, the resonance peak could be shifted along over the entire range with higher constant amplification at the various wavelengths. For instance, at a setting of 20 on the condenser, corresponding to a wavelength of about 300 meters, the amplification could be considered as 100. By simply varying the condenser throughout the entire scale, the peak can be shifted to cover all wavelengths (within a certain range) with equal efficiency. This is shown on the graph, by the two additional curves for a condenser setting of 50 and 100 respectively.

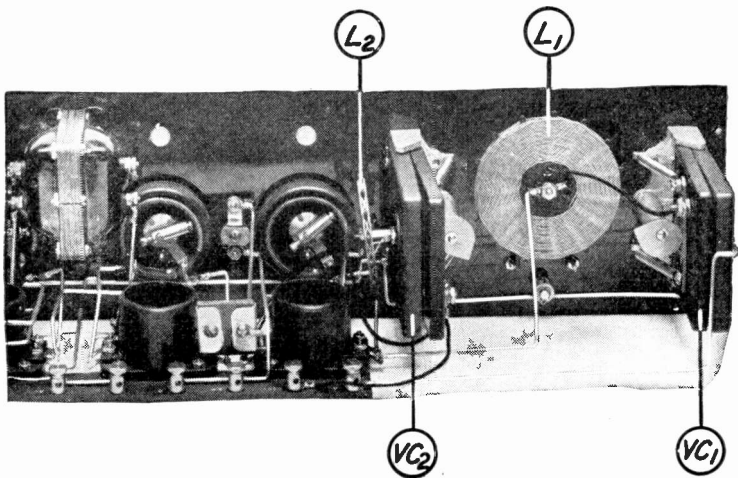

A RECEIVER EMPLOYING TUNED RADIO-FREQUENCY AMPLIFICATION

Figure E: The antenna circuit is tuned with a coil, L1 used in connection with a variable condenser, VC1, or "book" type. The plate circuit of the radio-frequency tube is tuned by a similar coil and condenser, L2 and VC2 respectively

2: direct coupled

- Tuned impedance
- Choke-coil arrangement
- Resistance coupled
- Electrostatically coupled

"Practically all of the systems of radio-frequency amplification have been used from time to time with some degree of success, either in this country or in Europe. However, the particular construction of the American vacuum tube, together with the shortness of the waves utilized for broadcasting, has tended until recently to confine the practice in this country to inductive-coupled transformer arrangements.

"During the past few years, however, a number of manufacturers have developed and marketed receivers in which the radio-frequency amplification was accomplished by a fixed ratio. Transformers of the direct-coupled type are composed of two inductive windings which, when operated in connection with the grid-to-plate capacity of the vacuum tube, bring about resonance of

the desired frequency. This arrangement for transformation is limited by the extremely narrow wavelength band over which the transformer will efficiently operate. A fixed-ratio transformer with an air core is remarkably efficient in its operation. However, the sharp resonance curve confines all practical operations to wavelengths quite close to its resonance period.

"This limitation is shown by the sharp-peaked resonance curve at A.

"Here it is evident that the receiver operated with this transformer will receive radio concerts at a wavelength of 360 meters with a signal intensity or volume of 80. Other stations broadcasting on a wavelength of 400 meters will be received with a volume of 10.

"The air-core transformer has been utilized with a fair degree of success when the windings are provided with a switching arrangement wherein the turn ratio and the resonance period can be set for several separate wave zones.

"For instance, a transformer may be constructed with three taps so connected to the windings that a resonance is obtained at 300, 350 and 400 meters. An amplification curve for a transformer of this class is shown at C.

"It will be noted that the highest amplification point is at 400 meters, and that all of the other resonance points are lower. This is due to the resistance introduced when the coils are tapped. The 400-meter position utilizes the whole coil. The other positions do not, but have (dead ends) or inactive sections, which absorb a part of the energy.

"While the amplification obtained at 360 meters is only 40, as compared to the 80 listed for the transformer in Fig. B, this tapped transformer can be used more efficiently at *all* wavelengths between 275 and 425. It is readily appreciated that the strength of received signals is not uniform between the wavelengths here listed, but stations transmitting at wavelengths of 300, 350 and 400 meters are received with a maximum signal strength, and those at 275, 320 and 370 meters are received with reduced volume.

"A great majority of the radio-frequency transformers in use at the present time, instead of using tapped windings so as to obtain tuning peaks or high-amplification points as described, introduce a magnetic core which tends to broaden the useful wavelength band. The construction of this transformer is exactly the same as the air-core transformer except for the introduction of the magnetic core. The influence of the magnetic circuit in broadening the resonance curve is shown by the low, broad curve of Fig. B, wherein the sharp resonance period of 360 meters is not obtained, as is the case when the core is removed. While the volume of the received signal is reduced to 45 in

comparison with the 80 obtained when the core is removed, the signal volume at 300 and 400 meters *is increased*.

"Receivers that embody transformers of the types described above have been operated with a certain degree of success during past years where all of the radio broadcasting stations of this country were licensed to operate on wavelengths of 360 or 400 meters. Stations transmitting at wavelengths greater or lower than these values are what may be termed beyond the useful amplification wavelength zone of these transformers.

"The sharp resonance curve shown in Fig. B represents the amplification at various wavelengths on each side of the resonance point with a transformer composed of two coupled windings having a definite value of self inductance. As the windings are composed of a great number of closely associated turns, they bring about a high value of distributed capacity between the various turns of the windings. The effect of this combination can be represented by a condenser having the same value as the distributed capacity and connected between the terminals of the coil.

"In the particular instance of the transformer of Fig. B the inductance and capacity of the windings are purposely proportioned in the design of the transformer to be resonant at 360 meters, thereby enabling the radio concerts to be received with the greatest intensity at this broadcasting wave.

"Windings designed to have an appreciable value of distributed capacity cannot be included in the class of efficient inductances as the condensers formed between the windings are notoriously inefficient, due to the poor dielectric properties of the insulation covering the wire. A more efficient design may be arranged by altering the

construction of the inductance so as to reduce the internal or distributed capacity as far as possible and then bring about the resonant condition at 360 meters by tuning the circuit by means of an efficient variable condenser. An arrangement of this class is termed tuned-radio-frequency amplification, and represents the most efficient form of radio-frequency amplification available at the present time. Not only is the amplitude of the received signal increased from 80 to 100 by the introduction of an efficient inductance and condenser, but the wavelength range of the system can be greatly increased.

"As an example, assume that the condenser and coils were selected so that resonance was obtained at 600 meters when the condenser was set at 100 degrees, corresponding to its full scale, or maximum capacity, position.

"The resonance curve obtained at this setting is shown by the right-hand curve of Fig. D. This arrangement would bring about resonance at 400 meters when the condenser was set at 50 degrees, as shown by the middle curve of Fig. D. The 300-meter resonance curve is shown at 20 degrees. If resonant at 360 meters, the condenser would be adjusted to a position between 30 and 40 degrees where the 360-meter signals would be received with the same intensity as the three waves already shown. Here we have a radio-frequency amplifier of practically uniform amplitude, that is, amplification with equal intensity at any wavelength over the range of the instrument. The simplicity of construction and the ease with which the tuned-radio-frequency amplifier is operated cannot be overestimated.

"Fig. E illustrates a receiver of this class wherein the inductance consists of a special form of basket-woven coil of an extremely efficient type used in combination with a tuning condenser.

"In this type of amplifier the condenser plays an important part. Experimenters and investigators have appreciated the technical advantages embodied in this principle of amplification. However, the popularity of this system has been retarded by the discouraging reports circulated by those constructing such an amplifier with condensers having high dielectric losses or strong external or stray electric fields. The condenser having the high loss reduces the over-all efficiency of the device to that of the ordinary transformer and the stray field prevents the proper wavelength adjustment.

"It is claimed at times that there is little difference between radio-frequency amplification and audio or voice-frequency amplification except a slight increase in the range of the receiver.

"It may be stated that radio-frequency amplification will not materially increase the power or volume of strong signals, and that *all* magnification of power *must be accomplished* by radio-frequency amplification. However, the following inherent advantages found in radio-frequency amplification are most important in the design of an efficient radio receiver:

- 1—An increase in the receiving range of a receiver;
- 2—Amplification without distortion of signals;
- 3—Possibilities of employing loop or frame-type antennas;
- 4—Reduction of the possibilities of interference caused by re-radiation when used with regenerative receivers."

SECTION IX

Fixed and Variable Condensers

In the last part on coils it was said that a radio set consists principally of three vital devices, coils, condensers and vacuum tubes. These, with perhaps the 'phones thrown in, are indispensable elements. The condensers and coils are used for tuning to the waves and the vacuum tube is used to detect and amplify the signals. It is in recognition of the importance of this third element, the condenser, that this treatment has been included concerning fixed and variable condensers.

It would perhaps be wise to briefly review what has previously been said about electrostatic current storing devices. When a condenser is mentioned there should immediately crop up in the mind of the reader a mental picture of two or more metallic plates separated by a non-conducting substance such as air, glass, mica, or quartz. We may recall that only alternating current may pass through condensers because they continuously cause the plates to be charged and discharged and direct currents have the power to charge the plates only once.

We were also told that a condenser is something like a milk bottle or other liquid receptacle. It will discharge (overflow) only after it has become filled (charged). The time required for its becoming charged depends entirely upon its electrical capacity and this in turn depends upon the quality of the materials used in the condenser and their

arrangement. A condenser as big as a piano box may be made that will not have the capacity of a condenser small enough to be placed in the palm of the hand so that we see the size of a condenser is deceiving when taken as an index of its capacity.

Before passing on to the more intricate electrical features of variable condensers let us devote a few moments to a brief outline of the mechanical side of condenser construction. After all, the mechanics of every electrical device must be understood before one can pass on and intelligently consider the electrical side of the subject.

In our sketch (Fig. A) we see the general scheme used in the manufacture of fixed condensers, that is, condensers with fixed capacities. Looking at it carefully we see that it is nothing more or less than a series of electrical sandwiches, the "bread" being little slabs of insulation while the filling is a conductor. It will be noted that there are two groups of fillings and that they are separated from each other by the blocks of insulation. The pieces of conducting material are usually referred to as plates. The plates in each group are connected together (soldered) and a wire lead brought out to the terminal.

Since it is desired to obtain a large electrical capacity in a small space, tinfoil is used for the plate material and mica in very thin sheets for the insulating material in most cases. Mica is

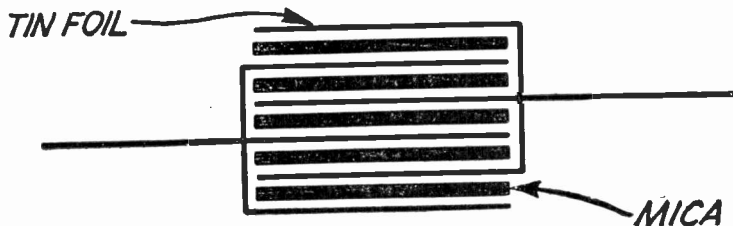

HOW A CONDENSER IS ASSEMBLED

Figure A: This illustrates the scheme used to make fixed condensers. The insulating material, which is usually mica, is sandwiched in between the metal plates. These plates, in the case of fixed condensers, are of copper foil or tin foil. In the construction of condensers of this type, it is essential that the plates (both insulation and conductor) are pressed together tightly. Otherwise heavy losses will be introduced and the quality of reception will be brought down to a low level. Some special mechanical means is usually employed to keep the plate together.

exceptionally efficient for this purpose because it has a high insulating value and very thin sheets of it may be used to produce high capacities. Exceptionally thin sheets may be used in radio receiving because we are not dealing in any case with exceptionally high voltages and there is no danger of the insulation being punctured. If a small receiving condenser should be placed across a 3000-volt line, the insulation would, no doubt, break down under the terrific pressure and the condenser would become short circuited. Under these conditions it is usually said that the condenser has become punctured.

If we examine the second sketch (Fig. B) we will see the common forms taken by fixed condensers. The first form is of the mica type with the elements squeezed between two bakelite end plates, eyelets being used not only to hold the end plates in position, but to also form the terminals of the condensers. The largest condenser is of the paper type. That is, paper is used as the insulator and condensers of this type have a capacity in the neighborhood of $\frac{1}{4}$ to 2 mfd. However, such devices are more often employed in continuous wave radio transmitting sets.

While on the subject of small fixed condensers it will perhaps be well to warn the reader against the use of paper condensers in reception. Paper condensers are not usually produced with end plates and the elements are very loosely assembled. When such a condenser is placed in an alternating current circuit, the rapidly changing charges on the surface of the plates exerts an actual mechanical force and the condenser will give out a humming noise corresponding to the frequency of the current in the circuit. It is natural to assume that a condenser acting in this manner is not performing its service efficiently and that it is not the best thing to use. Paper condensers should never be employed in radio receivers and especially in audio-frequency circuits. In the audio-frequency circuit the current is vibrating at a comparatively low rate and the inertia of the plates of such condensers is small enough so that they respond readily to these currents. If an exceptionally poor paper condenser is used in the audio-frequency side of a receiver one may readily hear the music or voices coming over it by simply placing the ear close to the condenser. Some physicists, taking advantage of this prin-

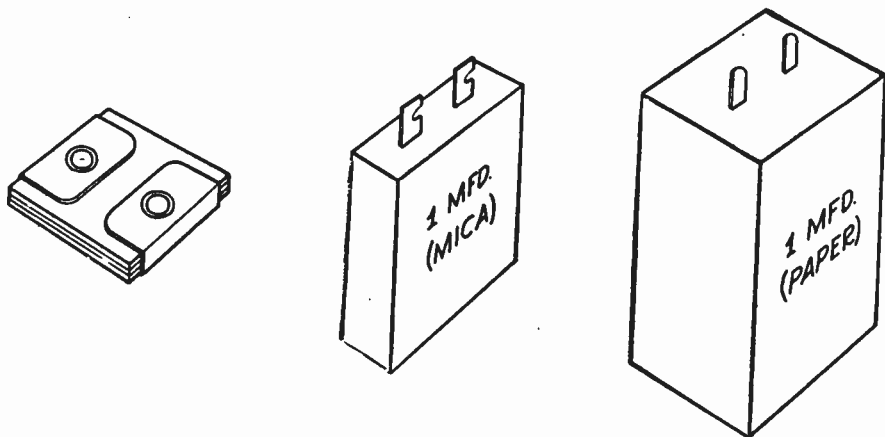

DIFFERENT TYPES OF FIXED CONDENSERS

Figure B: The small condenser at the left is mica insulated and it is available in the smaller capacities. The condenser in the middle may have a capacity anywhere from .25 mfd. to 1 mfd. At the right is illustrated the form taken by paper or telephone condensers. The larger type of paper condensers are employed in systems to "iron" out the ripples in a pulsating direct current. This principle is employed in the construction of "B" battery eliminators so that the current or voltage put on the plate of the vacuum tube will be of a uniform nature.

ciple, have reproduced the human voice with an electrostatic loud speaking device.

Coming back to our little fixed condenser with the eyelets, we will see that it is very convenient to increase capacity by using more than one condenser and slipping each condenser over two machine screws as illustrated in Fig. C. Such an arrangement really amounts to an adjustable fixed condenser and since these small mica condensers may be purchased in capacities running all the way from .0025 to .01 mfd. practically any capacity may be arrived at.

These little fixed condensers have a multitude of uses in radio reception. In the most simple type of a crystal receiving set they are used to bridge across the 'phones as in Fig. D. In such a position they help to increase the signal strength and clarify reception. Such condensers are also used a great deal in performing what is known as a bypass function. We know that alter-

nating current will pass through condensers and that direct current will not. Therefore, by properly using a condenser we can choke off direct current and permit alternating current to pass. The two circuits may be simply separated by a condenser. Thus, in reflex work radio-frequency current is made to pass over audio-frequency circuits although the current flowing in the audio-frequency circuit cannot reach the current flowing in the radio-frequency circuit due to its direct pulsating nature. Sometimes small fixed mica condensers are bridged across audio transformers so that the radio-frequency current in the circuit will be able to avoid the windings of the transformer because the resistance of the condenser is lower than the windings. The term resistance, by the way, when used in connection with alternating current is more often referred to as impedance. The reader should remember this to

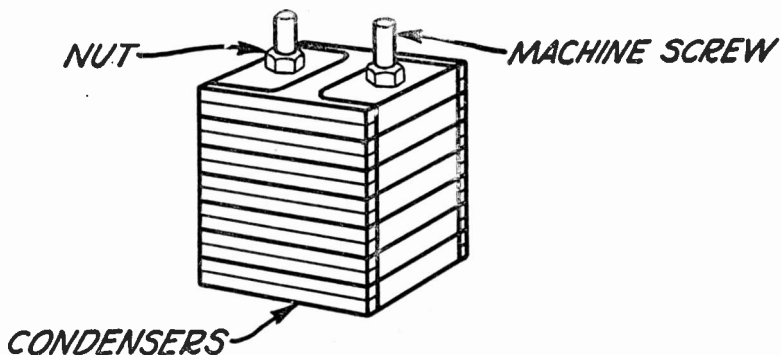

BUILDING UP CONDENSER CAPACITY

Figure C: By slipping a number of small mica condensers over two machine screws, the capacities will be added. This is so because the condensers are connected in multiple. The capacity of condensers connected in this fashion are always added. Two .025 mfd. condensers, for instance, would give a combined capacity of .050 mfd. This is a convenient system for use in building up correct capacities with the condensers on hand.

avoid confusion in digesting radio literature.

The subject of the variable condenser will be best introduced by carefully analyzing the general mechanical features of this type of instrument. Electrically it is the same as the fixed condenser; we have a number of electrical sandwiches consisting of insulation with metallic filling. The insulation in this case, however, is invisible because ordinary air performs the function. The group of stationary plates which are all connected together are sandwiched in between the movable plates which are also connected together. The separate groups of plates must not touch each other for the condenser immediately becomes short circuited and a direct conducting path is formed through it. Incidentally the plates in the stationary group are called the stator plates and the plates in the movable group are called the rotor plates.

We will obtain a very good idea of the practice followed in condenser construction by considering the attached sketch

Fig. E. The condenser plates are made semi-circular and either aluminum or brass is the metal used. The plates may be soldered together but more often they are held in a slotted metallic member. The end plates, that is the plates at each end, should not function electrically but should be used merely as mechanical supports for the stationary and movable plates. Sometimes these end plates are made of an insulating material, but modern practice seems to be in favor of metallic plates. When metallic plates are used some effective means must be employed to prevent a flow of current between the movable and stationary plates. The stator plates must be insulated from the rotor plates. It is very important too that this insulation is of the very best kind and that it should be placed in a certain definite position for we must remember our definition of a condenser; it is made by separating two conductors by an insulator. Unless the solid insulation used to separate the rotor and stator plates is placed correctly there

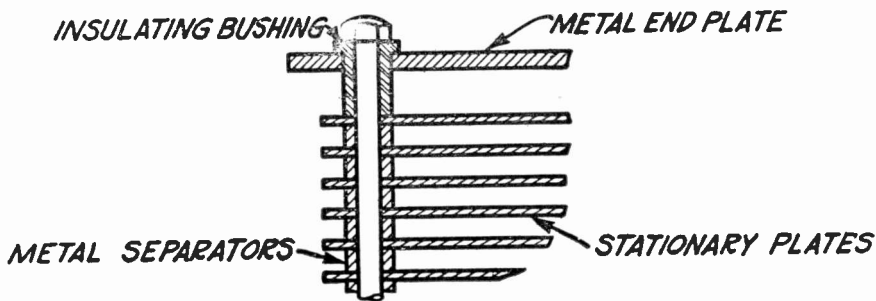

BAD PRACTICE IN VARIABLE CONDENSERS

Figure E: Condensers assembled with fibre bushings in the manner shown are very inefficient devices and will greatly impair the efficiency of any radio receiver with which they are used. Fibre should never be employed as an insulator for condensers because of its property of absorbing moisture.

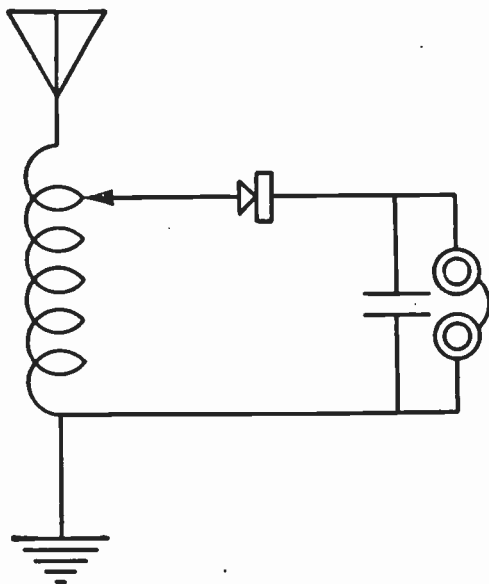

WHERE SMALL CONDENSERS ARE USED

Figure D: This diagram shows one of the methods used in employing small fixed condensers in crystal receivers. This condenser could be given several other positions in such a circuit but the one illustrated is most effective. Such condensers find a multitude of uses in vacuum tube circuits.

will be a damaging *capacity effect* which will interfere with the capacity obtained between the sandwiched plates. We shall consider this matter more in detail later on in this Section.

We will understand that the bearings of a variable condenser are important when we think of the changes in capacity that would result if the rotor plates were wobbly. This would cause a difference in the distance existing between the rotor and stator plates when the rotor was moved and our condenser would not give a uniform change in capacity; there would be little jumps in it that would greatly affect tuning. Small brass bushings are always employed in good condensers and they should be machined very accurately so that the shaft of the rotor will revolve without changing its vertical position.

In tuning a radio set it is often desirable to turn the rotor shaft of a condenser an almost microscopic distance. This is difficult to do with the unaided fingers and for this reason condensers are nearly always provided with vernier attachments. That is, attachments that may be used in causing the rotor to turn only a small fraction of an inch. These verniers take various forms. Gears are sometimes used and in every case the knob employed on the shaft of the condenser is in two parts. One part of the knob makes a direct connection to the rotor shaft and the other part works through a train of gears or by friction on a large disc connected to the shaft. If gear operated verniers are purchased the reader should carefully check the instrument for lost motion. This is ordinarily referred to as "play" and it is the result of mechanical imperfections between the gear teeth or the gear train. It is most difficult to tune accurately with a condenser having this lost motion.

Insulation takes an important part in condenser design and it might be well for us to go into this angle of the subject a little more thoroughly before we tackle the phases of the subject that are more difficult to understand than those just treated.

Although Professor Einstein did not specifically say so, insulation is a relative term. A substance that will effectively insulate at one voltage will pass current under another as freely as water passes through a sieve. Indeed, there is *nothing* that will not pass a certain quantity of electricity. Therefore, we insulate to *minimize* the leakage of currents.

Electric leakage is an insidious thing from the viewpoint of the radio fan. When a water pipe, boat or air tank leaks it is a simple matter to find the outlet and to apply the needed remedy, but in a radio set we can have a leak as big as all outdoors and still we cannot see the invisible fluid that manages to escape. If there is anything that will quickly reduce the efficiency of a radio set, it is poor insulation. This is doubly true about transmitters, and even in receivers it is an important factor.

The degree of insulation necessary depends upon the voltage used. A water pipe that carries ten gallons of water per minute at a pressure of 60 pounds to the square inch would probably burst if the pressure in pounds to the square inch were suddenly multiplied by five. The same might hold true of a wire carrying electric current; if the voltage were suddenly multiplied by five or even by two, the insulation would become ineffective and we would experience heavy leakage. Although insulation cannot burst, it can break down electrically and burn up when the voltage reaches the rupture point where it can

puncture things in its path that offer resistance.

There are two things that are most important in considering the subject of insulation: One is *voltage*, as we have already seen. The higher the voltage the greater the resistance of the insulation must be, to effectively keep it in its path of virtue, so to speak. The other factor would probably be little suspected by the average experimenter. It is *frequency*.

The way in which frequency affects an insulating substance may be a bit obscure, but nevertheless this fact is as true as the law of gravity. Some notion of the importance of frequency and its effect upon dielectric strength (insulating strength) may be gained from the

fact that an insulator that will stand up under an application of 100,000 volts at a frequency of 60 cycles per second may break down and become totally ineffective under a voltage of 20,000 at 150,000 cycles per second. From this we learn that radio-frequency currents are much more difficult to handle and insulate. They are the wilder and more unruly members of the electric-current family.

It is usual to measure resistance of insulating materials in ohms just as the degree of resistivity offered by a copper wire is measured in ohms (or fractions of an ohm). In measuring resistance of real insulators we have such "gobs and gobs" of ohms that we use a more convenient term, the megohm (1,000,-

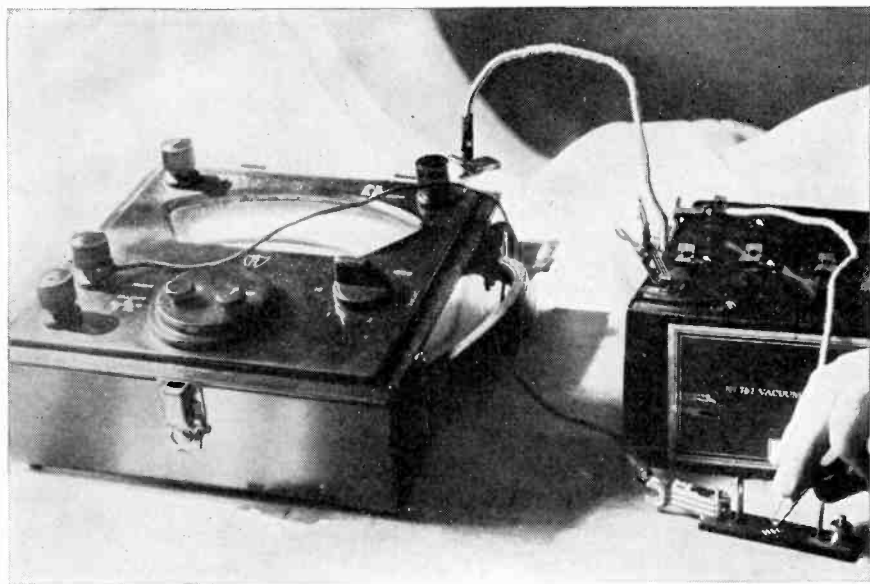

AN ELEMENTARY TEST OF INSULATION

Figure F: With a regular "B" battery and an extremely sensitive microammeter connected in series with a piece of insulating material, it is sometimes possible to get a current of 15 microamperes to flow through the insulation. This test is a crude test, however, and would only serve to show up a very poor piece of insulating material.

000 ohms). That this term is more convenient will be appreciated when it is understood that a unit cube of a good insulating material might have a resistance of 100,000,000,000,000,000 ohms.

The dielectric strength of any substance (and by this we mean its ability to resist a voltage that would tend to break it down) can be likened to the mechanical strength of the metal in a high-pressure tank. Any dielectric or insulating substance has a critical voltage point at which it will rupture or break down and allow current to pass through it freely. If it is a good insulator the amount of voltage that must be applied to do this is necessarily high,

ranging from 1,000 to 500,000 volts for the different thicknesses of insulation.

Dielectric strength is measured in terms of the number of volts required to puncture any definite thickness of the material. It is a sort of indefinite quantity, since it is difficult to measure with any degree of accuracy. In the accompanying illustration we see a small high-potential transformer of 7,000 volts potential, set up to puncture a small thickness of insulation of the much-used "mud" variety, which is usually a combination of lampblack and shellac. The voltage at which puncturing takes place, depends upon the *frequency* of the current, the *time* during

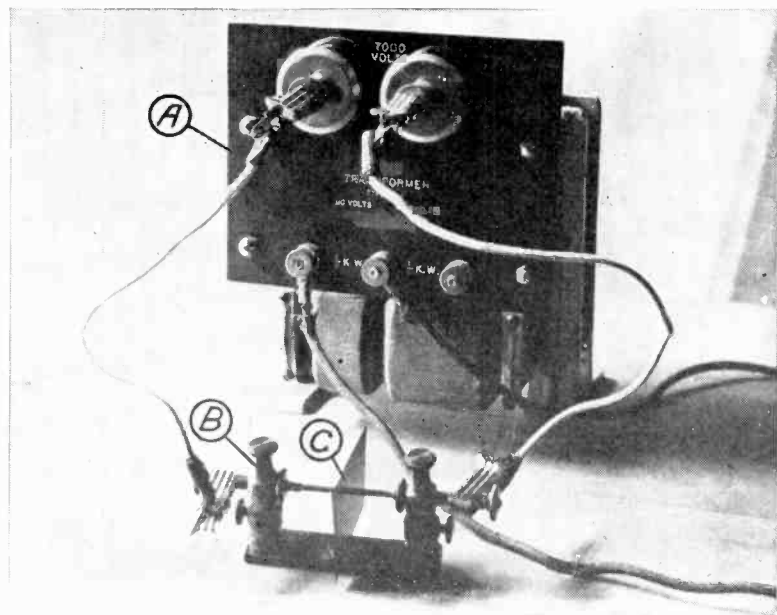

A TEST OF THE DIELECTRIC STRENGTH OF AN INSULATING SHEET

Figure G: A high-potential transformer A is connected across the terminals of a spark gap B. The sheet of insulation of known thickness is then fastened between the electrodes of the spark gap and then the voltage of the transformer is raised until the dielectric strength of the sheet is overcome and a spark passes through the insulation. The voltage at which this electric breakdown occurs is the dielectric strength of the material, and it is measured in volts per mil.

which the voltage is applied and the size and shape of the electrodes and their distance apart.

For instance, the use of needle points will often cause a breakdown at voltages where flat surfaces will not. This, of course, can be understood since what we might call the voltage gradient in the insulator is larger in the case of the needle points and a smaller area of the insulator is called upon to withstand the entire strain. If the same load were distributed over a larger area the insulator might successfully withhold it.

The insulating materials that we use in our radio sets should be of the best variety. The "mud" referred to should be used only where it is not called upon to resist the passage of radio-frequency currents, no matter what their voltage value may be. The contributor has made a number of tests on the insulating strength of some of the lower grades of this substance and he finds that at radio frequencies they pass a considerable amount of current even when the voltage is seemingly insignificant. Some of this material makes beautiful-looking grid leaks and it is only necessary to mount the binding posts *in* it at a definite distance apart to obtain any number of megohms or fractions of a megohm as a grid leak! Even with a direct voltage, this material shows the passage of dangerous amounts of current. A simple experiment with a microammeter, similar to that shown in the photograph gives indisputable proof of this statement. If a small piece of the stuff is connected up in series with a 100-volt "B" battery, appreciable quantities of current will be allowed to pass, even when the electrode separation is comparatively large! With a separation of $\frac{1}{2}$ inch the contributor has had an ammeter reading as high as 15 micro-

amperes. According to Ohm's Law

$$R = \frac{E}{I}$$

.00000025 amperes and a voltage of 100, it is evident that the insulation is only 4 megohms which is disgustingly low for anything that is dignified by the name of insulation. This material is probably all right to use for knobs, dials and the like, but its performance as a restrainer of electric pressure is not sufficiently noteworthy to warrant its use in radio equipment.

Any of the synthetic-resinous products are well suited to radio use whether in transmitters or receivers. They offer a fairly substantial resistance to moisture, their dielectric strength is high and their mechanical strength is enormous. The contributor can say little in favor of vulcanized fibre as far as its use for radio insulation is concerned. Its use for panels is to be discouraged since it has a terrific appetite for water and sucks in atmospheric moisture with sponge-like efficiency. Fibre has a dielectric strength of 330 volts per mil, or 13,000 volts per millimeter with a thickness of $\frac{1}{32}$ of an inch. This, of course, is in the perfectly dry state (which is unusual and which can be maintained only in the laboratory under experimental conditions). Compared with this, the resinous materials show a dielectric strength of 1,000 volts per mil or 39,400 volts per millimeter in a thickness of $\frac{1}{32}$ of an inch. A good piece of this material has a volume resistivity of about 1,000,000 megohms (10^{12} ohms) per centimeter cube. The surface resistivity may be anywhere from 100 megohms to 10,000,000 megohms. These figures show us that any of these products can be used with perfect safety as panels and for other insulating purposes in a radio set.

There are numerous grades of this type of material. One is formed by allowing sheets of paper, white duck, or cloth to soak in raw resinous liquid varnish. The sheets are then placed one on top of the other in a powerful steam-heated hydraulic press. The press comes down, giving the sheets a tremendous squeeze and heating them at the same time. When the sheets come forth from the press they are in a much changed condition. What was once 50 or 75 sheets is now a single flat block of exceptionally hard material that will resound healthily when it is struck a sharp blow with a hammer. The sheets are welded together, forming a homogeneous material.

Other forms of insulating materials are molded. For instance, molded, synthetic-resinous or rubber materials are placed in the mold and subjected to heat and pressure at the same instant. The material fluxes and becomes almost semi-fluid, filling every interstice of the die. There is both a chemical and physical change. The chemical change is irreversible and permanent.

Most of the "spaghetti" that we buy is composed of cloth tubing impregnated with either oxidized linseed oil or raw bakelite varnish. This material should be freely used where bus or other wire comes in contact with the wooden parts of the cabinet. In no case should the connecting wires be allowed to make contact with the wood without being heavily insulated. Wood is an exceptionally poor insulator and is usually filled with atmospheric moisture.

The contributor hopes that those who have read this course will give more thought to the insulation of their radio outfits henceforth. Insulation is a mighty important thing, and since we cannot see the leakage that is taking place there is only one thing left to do. That is to

insulate our variable condensers and outfits, in the best manner that we know how, using materials that have proven their worth in the workaday world.

The variable condenser is the most important radio device for tuning since it provides means for *infinite* variations of wave lengths over a given range. While it is possible to vary the period of a circuit by adjustment of inductive values, this system is not only more wasteful of energy but is highly impractical from the standpoint of pure mechanics. If infinite variation is to be had in a coil, the mechanical appurtenances necessary to bring this result about are so involved and complex as to make the whole arrangement bulky and unsatisfactory. Furthermore, such a system of wavelength variation could never be as efficient as the system of capacity change.

The variable condenser is the one ideal, and, providing that the resistance of the condenser is a negligible factor and that its general losses are beyond measurement, no more efficient tuning device can be desired. The variable condenser method gives a sharpness at resonance that is unattainable by other systems. However, this cannot be taken to mean that every condenser regardless of its electrical properties produces the same results. Actually, there is a wide variation in condenser efficiency depending solely upon (1) the electrical design and (2) the quality of the material used. Unless strict adherence is given to the scientific niceties of condenser construction as laid down by the best authorities today, unsatisfactory results will be had.

Condenser losses, due to the complexity of the electrical phenomena involved, are of a most insidious nature and much of the total energy received by condenser tuned outfits can be dissipated

in useless forms without a hint of such a process to the user. Frightful losses may occur and efficiency may drop as much as 50% in condenser devices alone unless the prescribed rules of construction are adhered to by the manufacturer.

Although a condenser is of comparatively simple construction from a mechanical standpoint it is not, as many believe, a simple matter to defeat the natural tendencies toward loss and inefficiency. Like all of the devices used in radio, the net efficiency depends upon how successfully the manufacturer has met the demands determined by the Bureau of Standards and other authorities. Although a condenser may present a very grand appearance to the eye, it may create an appalling loss of energy when checked by precision instruments. At the same time a condenser may have the very best of materials in its construction and yet if they are not properly arranged, the device may function as poorly or even worse than the one involving good design with poor materials.

Although it is not easily conceivable to the lay mind, a condenser, when introduced into an electrical circuit, represents a large element of resistance. Since unwarranted resistance is fatal to radio efficiency it stands to reason that the elimination of this resistance is one of the ideals to which conscientious manufacturers must hold themselves.

With the introduction of the low loss idea, many extravagant claims have been made about the resistance of variable tuning condensers and many manufacturers, to meet the need of the new public demand, have made no more drastic changes than to add a sticker to their cartons claiming "low loss." Since the layman has no means at his disposal to check up these extravagant claims, it follows that thousands of highly inefficient devices have been

sold due to the unscrupulous activity of those who have not had the necessary capital to change their tools and method of manufacture.

In stating the resistance of a condenser it is customary to claim that it has a value equivalent to a series resistance of such-and-such an amount. This means that it has a resistance that would allow the same current to pass if it were connected in series with a perfect condenser of the same capacity. Due to the great difficulty of making correct calculations in the higher radio frequencies, these resistance measurements are usually made with a 1,000 cycle source. Overlooking the fact that many of the figures given are altered to make them sound more reasonable, the figure itself means little or nothing for it has been determined again and again that it is not scientific or even correct to assume that there is a fixed relation between 1,000 cycle measurements and measurements at radio frequencies. It means practically nothing to compare the resistance of two differently constructed condensers at high frequencies when the standard 1,000 cycle frequency current has been used as a basis of measurement.

Resistance and insulation in condenser construction are intimately related and it is through this that many mistakes are made. Every dielectric or non-conductor used for electrical separation between the movable and stationary plates has what is known as an absorption factor; that is, the materials are capable of absorbing a certain percentage of the total energy that passes through the device. The larger the quantities of this material introduced, and the greater the mass, the greater the losses will be. The placing of this material is also an important factor for if it is placed where the electrostatic

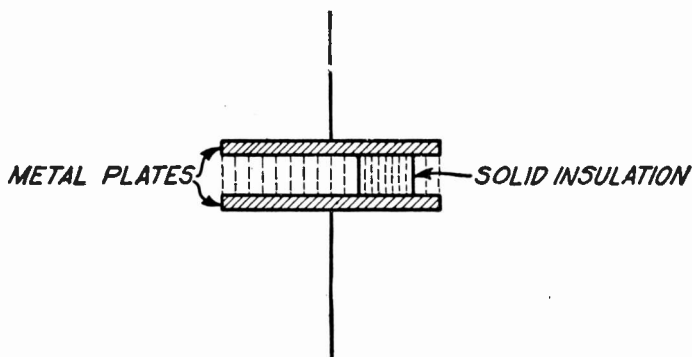

A PHENOMENON ILLUSTRATED

Figure H: How a piece of solid insulating material will affect the capacity of an air insulated condenser. It will be seen that the solid insulator allows more of the electrostatic lines of force to travel through it than does the air. This can be compared with the effect caused by a piece of iron introduced in a magnetic field. Since iron is a better conductor of magnetic lines of force, the field concentrates through the iron. The electrostatic lines of force are illustrated doing the same thing.

field is most intense, and where the electrostatic lines of force passing through it are great, greater losses will result. This may be compared in a way with magnetic phenomena for it is well known that the magnetic lines of force influenced by a piece of soft iron will depend entirely upon the position of the iron in relation to the coil producing the lines of force. Successful construction then is possible only when material with extremely *low dielectric loss is used and placed in a position where the electrostatic field is at minimum value.*

Reference to Fig. H will demonstrate the meaning of this statement. In this case we have two metal plates separated from each other by air and placed at different potentials. Under such conditions there will be an electrostatic field between the plates and the shape taken by this field is shown by the dotted lines. If an extremely poor dielectric substance is placed between the plates, the electrostatic lines of force will at once redistribute themselves, and many of them, instead of passing through the

more efficient dielectric, the air, will pass through the poor dielectric with consequent loss in electrical efficiency through the increase of resistance. If the dielectric material is able to pass six times more lines of force than an equivalent space of air, it is said to have a dielectric constant of six. What is needed for high efficiency is a substance that will pass very little more or less lines of force than the air. It is a matter of scientific record that few such materials exist in the world.

It will be seen from the above that condensers merely insulated with bushings (see Fig. E) cannot in any way be reconciled with the demands of low loss construction. Condensers with solid insulated end plates, unless the insulation is of one of the best materials, are also wasters of valuable energy and very inefficient.

It is interesting to note at this point that these dielectric losses through absorption increase with frequency due to the fact that the electrostatic lines of force are building up and collapsing

with every change of potential from zero to maximum.

There is still another source of loss due to electrical connections between plates themselves. This means that good clean, tight connections must exist between the plates and between the stationary terminal and the connection formed between it and the rotating plates. This latter connection has been the source of some trouble and in many cases pigtailed, or flexible connections, have been introduced. The Bureau of Standards, after much research, has been emphatic in its stand against the use of pigtailed due to the losses that they induce. The best practice is that of producing the best possible electrical connection between the end of the rotor shaft and the fixed terminal by means of a contact. The Bureau of Standards holds, and rightly so, that the inductance of the leads of a condenser should

be at absolute minimum for the apparent capacity of a condenser at high frequencies will increase with frequency due to inductance in the leads in a similar manner to the variation of the apparent inductance of a coil with distributed capacity. Connections between the binding posts and plates should be short and thick, for this has been found to minimize both inductance and resistance.

In these days of low loss construction a great deal is heard about minimum capacity. Of course the minimum capacity of a condenser should be as close to zero as is consistent with reasonable cost of manufacture. A condenser with a positive zero might be constructed but it would be so costly as to be beyond the means of the average purchaser. Some hold that a low minimum is impossible when metal end plates are used. This is true only under

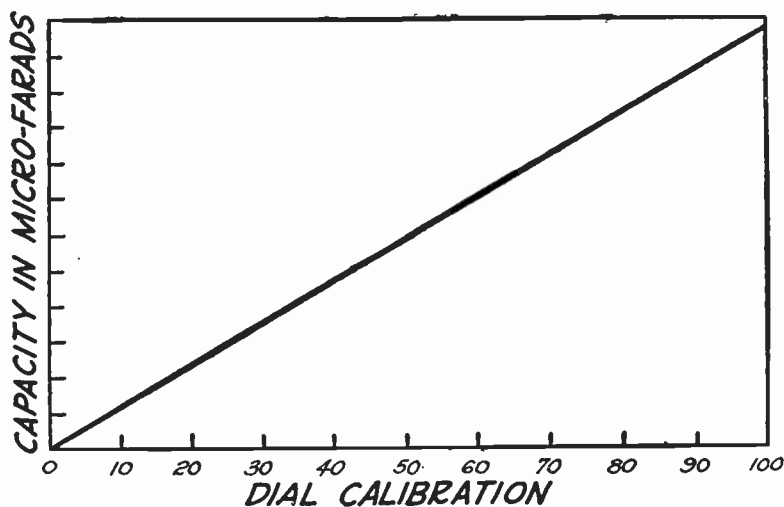

WHAT A STRAIGHT LINE CONDENSER INVOLVES

Figure I: A straight-line condenser, whether of the frequency, wavelength or capacity types, must show an increase and decrease in capacity that will give a straight line when plotted as illustrated.

a certain condition, i.e., when the distance separating the stationary plates and the end plates is small. There is a law that states that the intensity of the electrostatic field existing between two members at different electrical potentials is *inversely proportional to the square of the distance*. This means that if the distance is doubled, the field is quartered, etc. If a distance equivalent to the distance separating the plates were used between the end plate and the stationary plates, a natural high minimum would result. However, when this distance is made $\frac{3}{4}$ of an inch or more the resulting minimum capacity is so small as to be almost beyond accurate measurement. Of course, at maximum capacity, that is, when the movable plates are interleaved between the stationary plates, the end plates have absolutely no effect for they are at the same potential as the movable plates. There can be no electrostatic field where there is no difference in electrical potential.

The Bureau of Standards draws attention to the inadvisability of using end plates of dielectric materials with high temperature coefficients. Such materials have changes in mass and shape when subjected to varying temperatures and quite naturally these changes are reflected in capacity. It also usually happens that end plates made of ordinary dielectric materials absorb huge quantities of moisture (sometimes as much as 8%) and through their temperature changes and moisture absorption they warp appreciably. That is the reason why some very cheap condensers, after they have been used for some time, will develop a short circuit. The insulation warps and consequently throws the entire device out of mechanical adjustment. Since small changes in this way effect large changes in the position

of the plates due to leverage, it requires but a small change in external conditions to bring about fatal results.

Much has been said about straight-line condensers and there exists in the public mind some amusing fallacies as to the why and wherefore of such instruments. When a condenser is said to be straight-line little or nothing is meant unless some information is imparted on the nature of the straight line, that is, whether it has to do with capacity, wavelength or frequency. Most condensers are manufactured for straight-line capacity. This means in effect that the capacity is calibrated against the dial setting and that the result of this process is a perfectly straight line on the graph, instead of a curve (see Fig. I). The same is true of wavelength and frequency. As far as the ordinary purchaser is concerned straight-line can be totally ignored for it has little to do with efficient operation. What the discriminating fan desires to know is the amount of loss that a condenser has when it is operated in connection with circuits at radio frequencies. If such a purchaser will look for the features mentioned in this treatment he will be able to purchase condensers that will minimize the destructive losses that occur in the average radio receiver.

Several misconceptions are current about condensers for use in radio receiving sets. We have heard suggestions as to how to use condensers properly in tuning, as to what the proper capacity should be, and as to the smallness of the resistance allowable in the condenser.

"Low-loss" condensers have been placed on the market. Competition among the manufacturers of these low-loss condensers is very keen. As a consequence, many statements have been

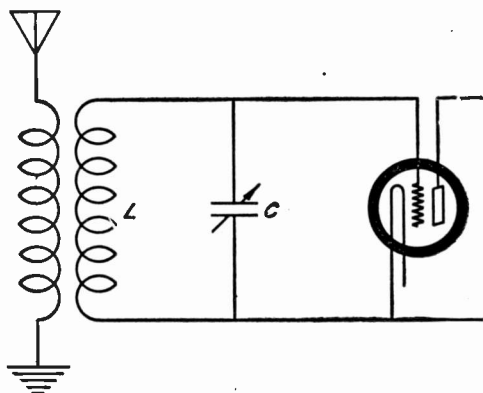

DIAGRAM OF AN ORDINARY
TUNING CIRCUIT

Figure J: Shows the usual manner of representing a simple vacuum tube tuning circuit where the voltage arises in the windings of the inductor, L.

made concerning the resistance which are not based on absolute fact.

There are a few physical facts which we must understand to be able to comprehend the problem.

The three-electrode vacuum tube, for example, is used in connection with circuits that include an inductor and a condenser. The vacuum tube is essentially a voltage-operated device, so that the problem hinges around the voltages set up in the circuit.

Figure J represents a simple tuning circuit connected to a three-electrode vacuum tube in the usual manner. L is the inductor and C is the condenser. It can easily be shown that the tuning circuit can be represented in the form shown in Figure K. The point is that the results are the same whether we consider the electromotive force as arising in the windings of the inductor, or as being applied in series with it. Actually it arises in the windings, but as the simple series circuit of Figure K is exactly equivalent, we will use this figure in these considerations.

Voltages, or differences of potential, are set up between two points in a circuit due to the *impedance* between these points. The impedance may be a pure resistance, a pure capacity, or a pure inductance, or a combination of these. Actually there are no such *pure* quantities, every electrical device containing all three of these quantities to some degree. For simplicity, however, we will consider the inductor as a pure inductance and the condenser as a pure capacity.

The part of the impedance which is due to either the capacity or the inductance, or both, is known as the *reactance*. The reactance due to the inductance alone is $X_L = 0.00628 FL$ and that due to the capacity alone is

$$X_c = \frac{159.3}{fC}$$

When a proper balance between the capacity and inductance in a circuit is obtained which results in resonance, these two reactances are equal and op-

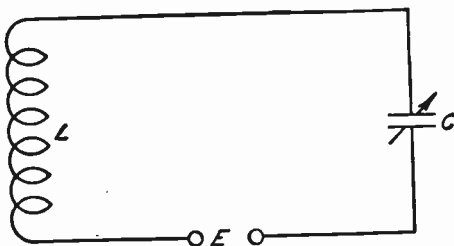

SIMPLIFIED DIAGRAM OF A RECEIVING CIRCUIT

Figure K: This shows the equivalent tuning circuit of that in Figure 1. In this circuit the voltage is applied in series with the other elements.

posite in effect, and the total reactance of the circuit is zero.

In these formulas X_C and X_L are the inductive and capacitive reactances respectively, in ohms, f is the frequency in kilocycles, C is the capacity in microfarads and L is the inductance in microhenries. These reactances exist in the circuit even when resonance is obtained, even though their net effect on the total circuit is zero.

The voltage drop between any two points in such a circuit is the product of the current in the circuit and the resistance or reactance between the two points. Thus the voltage drop across a pure resistance is $V = RI$ and the drop across a pure inductance or capacity

$$V_C = X_C I = - \frac{159.3 I}{f C}, V_L = X_L I = 0.00628 f L I$$

To obtain a large voltage across the inductance or capacity in Fig. J, it is evident that the reactance for a given current and frequency must be high. In other words, a large inductance and small capacity should be used. This is the conclusion that has been arrived at by someone a long time ago, and everyone has been following it as sheep follow their leader. The contributor does not

mean that this conclusion is incorrect; he means that it is not one half the story.

The story becomes somewhat different when we consider the resistances in the circuit. The presence of resistance represents a loss of power as given by the formula

$$P = RI^2$$

in which P is the power loss in watts, R the resistance in ohms, and I the current in amperes. It is to be noticed that the loss of power increases in proportion to the *square* of the current; that is, for a given resistance the power loss is quadrupled if the current is doubled. This loss of power results in broadness of tuning as well as inefficient operation of the receiving set and lowering of its receiving range. It is this loss that we are trying to overcome in our low-loss condensers and coils. We will now consider what effects are present in condensers and coils and other parts of the tuning circuits that give rise to these losses.

Until lately there have been no satisfactory methods known by which to measure the resistances of small air condensers. Various bridge methods of measurement have been used from time to time, but these are satisfactory only

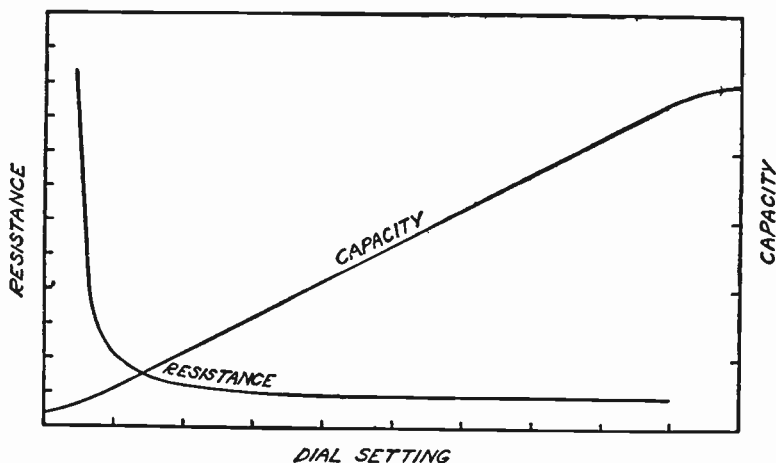

THE RESISTANCE CHANGES IN CONDENSERS AT DIFFERENT DIAL SETTINGS

Figure L: Notice that resistance rises sharply at the lower dial settings. These observations indicate that it is well to design your inductors so that you can tune with your condensers at higher dial settings (those above 80).

at lower frequencies than are used in radio reception; generally in the audible frequency range. When high frequencies are used there are losses of power in the bridge which vitiate the results of the measurement.

Substitution methods of measurement have been used, which require the assumption of zero resistance in a condenser specially constructed and used as a standard of comparison. Common sense tells us that zero resistance in any piece of electrical apparatus is impossible, so that this method of measurement must be regarded as very inaccurate.

Experimenters have attempted to compute the resistance of condensers by making the measurements at 1,000 cycles on a bridge and then calculating the probable resistance at radio frequencies. The method used is outlined as follows, together with the objections to the method. Condenser resistances have been measured at low frequencies

by the bridge methods and plotted as shown in Fig. L.

This is the curve for a glass condenser of capacity 0.002 microfarad. It will be noticed that this curve is straight throughout its whole length except for a very slight curvature at the lower end. Moreover, it will be noticed that it covers the range from 1,000 meters to 4,000 meters, or from 300 kilocycles to 75 kilocycles. These are frequencies which are not used in ordinary radio work (except in the case of long-wave transatlantic stations).

In this method of measurement, as the curve is practically a straight line, it was assumed to be straight all the way as the broken line shows. Experimenters therefore have assumed that the resistance of a condenser decreases in the same proportion as the wavelength is decreased. A bridge measurement which gives 125 ohms as the resistance of the condenser at 1,000 cycles (300,000 meters) would then have a resistance

of 0.125 ohm at 1,000 cycles (300 meters), according to their method of reasoning. That is,

$$\frac{1,000}{1,000,000} \times 125 = 0.125 \text{ or } \frac{300}{300,000} \times 125 = 0.125$$

The calculation is given for both wave length and frequency.

That this method cannot be correct, or give even nearly correct values of the resistance is indicated by the slight curvature at the foot of the curve in Fig. L. A curvature so slight as amounting to only 0.01 ohm for a range of 1,000 cycles would not be noticeable on the curve, but its effect would be multiplied 1,000 times if the same curvature were maintained over a range of 1,000,000 cycles. The result would then be in error by 1 ohm and the actual resistance would be 11 times the computed value. This is an exaggerated example, used to illustrate the case, but it can be shown that even if the curvature is very much less than this the error in the result will be several hundred percent from the true value.

The trouble lies in the assumption that the curve is a straight line. This is equivalent to saying that the power-factor (known also as the phase-difference) of the condenser is constant. The power-factor is given in degrees by

$$\psi = 0.36 f R C$$

in which f is in kilocycles, R in ohms, and C in microfarads. We can see from the formula that the power-factor cannot be constant. As f varies, the value of R also varies, due to skin effect, so that the power-factor must vary. If it did not vary the resistance would be inversely proportional to the frequency, and we would write

$$R \text{ proportional to } 1/f$$

But on account of the skin effect the correct relation is:

$$R \text{ proportional to } 1/f^m$$

This is the effect that has been neglected in the method described above. As a result of all this a new method has been devised which eliminates the inaccuracies of the above methods, and permits the measurements to be made under the same conditions which prevail in radio circuits. The measurements were on a great many condensers, including all types and all makes. The method was carefully checked by measurements made on known resistances. The resistances ranged from about 0.5 to 2.5 ohms, the low-loss types showing slightly lower resistances than the old types. We will not at the present time go into the resistances of the particular makes. What the contributor wishes to do is to give his reader an unexaggerated idea of the importance of the condenser resistance.

Now, consider the subject of coils, for these are always used with condensers in tuning circuits.

It is well known that coil resistances run very high, especially at radio frequencies, which we are considering. One manufacturer of a concentrated inductance of 100 turns advertises the resistance of his coil to be 80 ohms at 500 meters. Another manufacturer advertises the resistance of his loop antenna to be about 30 ohms at 200 meters. In fact, as far as the writer knows, no inductances have as yet been designed having resistances which even approach the low values of condenser resistances.

Let us consider, for example, a condenser which has a resistance of 1 ohm used with the loop mentioned above which has a resistance of 30 ohms.

Suppose we replace this condenser with one which has a resistance of 0.5 ohm. The total resistance of the circuit will be reduced only 0.5 ohm out of 30.5 ohms, or less than 2 percent.

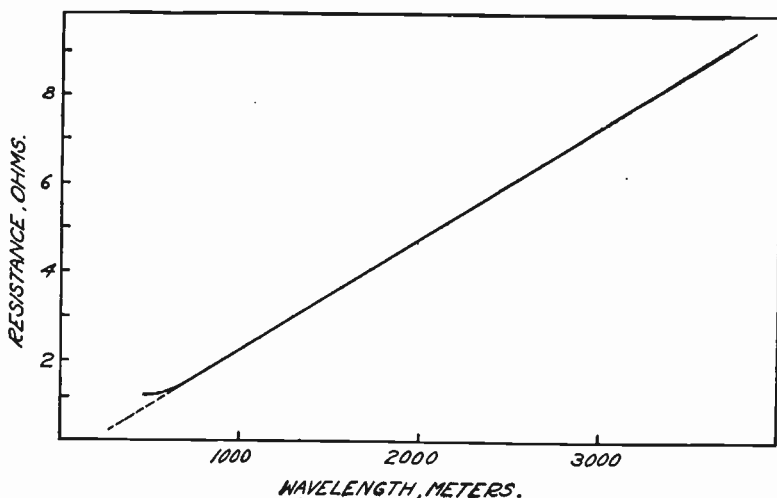

RESISTANCE CURVE OF A CONDENSER OPERATING ON THE HIGHER WAVELENGTHS

Figure M: It has been assumed that resistance in condensers varies directly with the wavelength. Calculations of resistance made on this assumption are erroneous at low wavelengths where the resistance decreases at a slower rate as indicated by the slight curvature of the graph.

The great worry about condenser resistance is therefore needless, and a great deal of undeserved pressure has been brought to bear upon the manufacturers of condensers by those who would better have devoted their time and energy to designing low-loss inductors.

There is another very important point that should be brought out here. By the new method it was possible to plot the variation of resistance of a condenser with the dial setting. The general shape of this curve is shown in Fig. M. Its shape might be suspected from the inverse relationship between the resistance and cross-section of a conductor.

In Fig. M, the important point to consider is where the curve begins to bend. Experiments have proved that the resistance remains practically constant from 100 on the dial to about 30,

at which point it turns up sharply. At 10 on the dial or less the resistance may go up as high as 15 or 18 ohms. This particular condenser had a capacity of .0005 mfd.

Interpreting this in connection with receiving circuits, it is not well to use the condenser at the low dial settings. The inductance used with the condenser should be so designed that the wave range can be covered without having to go lower than about 30, or best 25 on the dial. This should relieve the situation somewhat with regard to the minimum capacities of condensers. If we should not use the lower end of the dial, who cares, then, what the minimum capacity is? The best practice, in consideration of these facts, is to select a condenser that has a large capacity ratio between 100 and 30 on the dial, and to design the inductance to give the

wave range desired. This will mean using a larger condenser and small inductance which is often advantageous, since a small coil can be constructed to have lower resistance than a large one.

It is well to point out here, also, that the effect of soldered joints in various parts of the circuit, including those between the plates and elsewhere in condensers, is likewise negligible. More importance should be attached to the design of low-resistance coils. There are many forms on the market, but they are all more or less alike. There are some things in connection with coils that have not generally been considered, and it is probable that a broader way of looking at the problem may result in considerable improvement in design. The writer has built an inductance coil of a special form which permitted reception on a loudspeaker at a distance of 15 miles from the local broadcasting station using a simple one-tube circuit and an old-style condenser.

We are now ready to understand better what the relation of condenser to inductance in a tuning circuit should be. To obtain high grid voltages the capacity should be small and the inductance great. But large inductance goes with greater coil resistance. This means that our grid voltage will not be as high as we expected it to be. A compromise must be effected so that fairly high grid voltages can be obtained by having the reactances high, without sacrificing too much by the increased resistance. The usual 0.00025 or 0.0005 may be used satisfactorily for ordinary work, but in view of all the preceding arguments the author has lately been more inclined toward the 0.001 size, using a small 3 or 4-plate condenser shunted around it for accurate tuning.

Sir Oliver Lodge has contributed some interesting and helpful reflections on

variable radio condensers for those who desire to go more deeply into the mathematical side of the subject. To quote:

"When a conductor is charged with electricity, its potential rises. And, if the quantity of electricity supplied to it is doubled, the potential is doubled too. The ratio of the charge to the potential is called the "capacity" of the body.

"There is the same sort of thing in heat. The more heat is supplied to a body, the higher grows the temperature. And the ratio of the amount of heat supplied, to the consequent rise of temperature, is called its 'thermal capacity.'

"The thermal capacity of a body naturally depends on its size or rather its weight; but it also depends on its material. That part of the capacity is called "specific," which means the capacity of each pound or each gram. The specific capacity of lead is one thing, of iron another, and of water is greater than either.

"In this respect, thermal capacity differs from electric capacity. Electric capacity does not depend on the material of the conductor, but, as Faraday showed, on the nature of the material surrounding the conductor. A conductor in air has one capacity; but if plunged into a vessel of oil, or melted resin, or pitch, or some other insulator, it has another and greater capacity. Hence there is a specific inductive capacity for each insulating material, which can be ascertained by experiment.

"In addition to that, however, the capacity of a body changes, not only by reason of the insulator surrounding it, but also by reason of conductors in its neighborhood. If it is brought near the earth, for instance, or near a wall, its capacity increases. And this increase of capacity is calculable from the geo-

metrical conditions, that is, when the shape and distance of bodies is known.

"In some respects, therefore, electrical capacity is less simple than thermal capacity, since the latter has wholly to do with properties of materials, whereas the former is dependent on geometrical conditions besides.

"Take the simplest case—an isolated sphere: the moon, for instance, or a brass ball far away from anything else. A charge on it is measured by the repulsive force it can exert on a similar equal force at a given distance, in

accordance with what is called Coulomb's Law. The electrical force varies inversely with the square of the distance, just as gravitation does. But force is always equal to gradient or slope of potential. From this it follows, though not quite obviously, that the electric potential at any point near a charged body is equal to the charge divided by the distance *i.e.*, the simple distance of that point from the charge.

"Assuming this, and applying it to the case of an isolated sphere, let us ask: What is the potential of its center?"

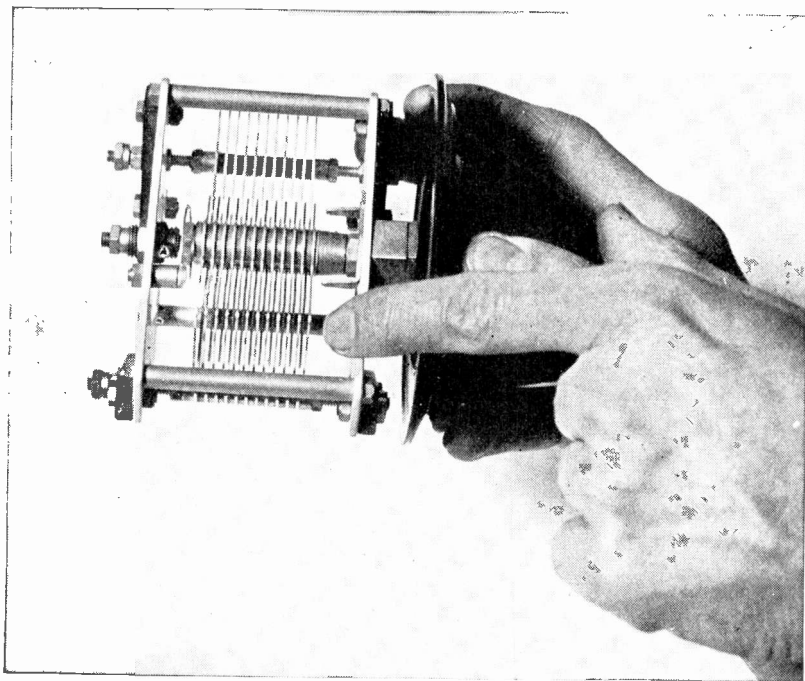

A TYPICAL RECEIVING CONDENSER

Figure N: The ordinary receiving condenser has air insulation and the plates are spaced as close as mechanical considerations permit. This is a satisfactory procedure since the potential between the plates is low, and the close spacing gives relatively high capacity. If the air was replaced by another insulating material, the capacity of the condenser would be increased. Any difference, however slight, in the distance between the rotor and stationary plates will affect the capacity of the condenser. Even changes in atmospheric conditions will bring about slight changes in the electro-static capacity.

"The charge resides wholly on the surface; hence the center is at a distance from that charge equal to the radius of the sphere. Consequently the potential is Q .

"And since the body is a conductor and the electricity is at rest upon it, its potential is uniform, or the same throughout. This $\frac{Q}{r}$ therefore gives the potential of the conductor. And, if you want to know its capacity, you simply divide the quantity by the potential and you get r .

"That is, the capacity of an isolated sphere is equal to its radius, and can be

expressed in centimeters, meters, miles or any other units of length.

It may be asked: How can a capacity be a length?

"The capacity depends, not on the body itself, except as regards its size and shape. It depends essentially on the properties of the material surrounding it. The material surrounding the moon is the ether of space. The material surrounding a brass ball is the ordinary atmosphere. The two surroundings do not differ appreciably in this respect. They both have practically the same specific inductive capacity. But un-

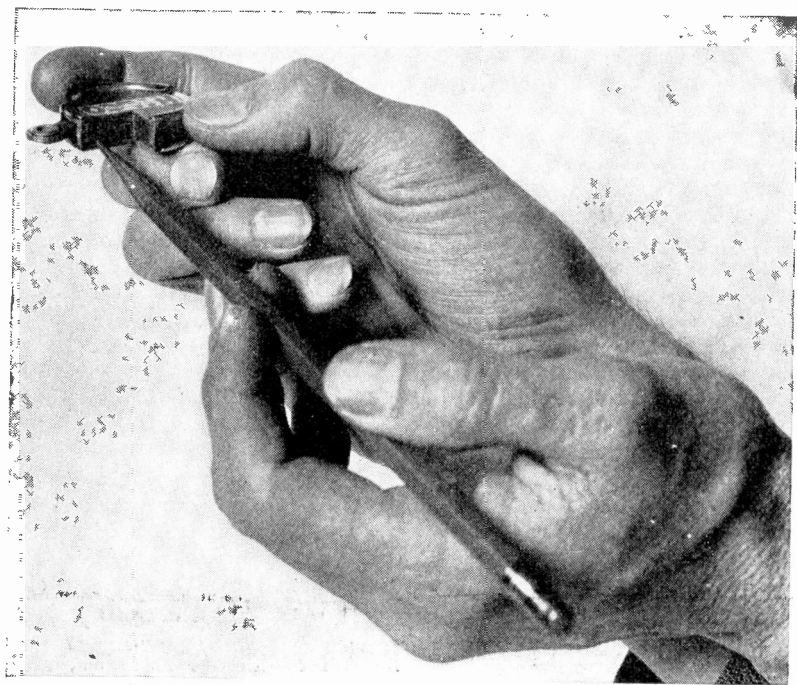

A COMPACT TYPE OF CONDENSER

Figure O: This tiny condenser has about ten times the capacity of the one shown in Figure N because it is constructed with mica insulation and the plates are spaced only a few thousandths of an inch apart. Part of the condenser is cut away to show the interior construction. The physical size of a condenser means little as an index to the measurement of capacity. This tiny condenser illustrated could have an electro-static capacity many times greater than a condenser many times larger.

fortunately its value is unknown. It is accordingly called K . And when we speak accurately, we ought to say that the capacity of an isolated sphere is Kr .

"But for practical purposes, we cannot deal with an unknown quantity. The simplest plan is to assume it to be 1, and proceed with the memory of that perfectly gratuitous and arbitrary assumption at the back of our minds. This is the basis of the electrostatic system of measurement. When a thing is expressed in electrostatic units, the meaning is that the unknown quantity K has been arbitrarily called 1. The worst of it is that we get so used to doing this that we are likely to forget the assumption altogether. The convenience of the assumption is that it enables us to specify our measurements in a very much more simplified manner.

"Now put an outer hollow globe round the brass square. It can be done, and actually used to be done, by applying to it two brass hemispheres bigger than itself, and suspending it symmetrically in the hollow. It can be charged through the suspending wire. If the outer shell is earthed, the inner globe will now be found to have a much greater capacity than before. The charge on it has, so to speak, pulled up from the earth an equal quantity of opposite electricity; and the two charges face each other across the insulating space.

"If we now reckon the potential of the center of the sphere, it will be $\frac{Q}{r}$ due to the one charge, and $\frac{Q}{r'}$ due to the other. The potential will then be:

$$Q \left(\frac{1}{r} - \frac{1}{r'} \right) = Q \frac{r' - r}{r r'}$$

and hence the capacity (Quantity \div

Potential) of the globe, now that it is surrounded by an outer shell of radius r' , is

$$C = \frac{r r'}{r' - r}$$

"Now, we see that $r' - r$ is the thickness of the insulating space or dielectric separating the two conductors, which we may call Z ; and if this space is very thin, that is if the spheres nearly fit, $r r'$ may be called r^2 . So the capacity of such an arrangement as this, which is familiar to electricians as a condenser, is $\frac{r^2}{Z}$. Now the area of a sphere is $4 \times r^2$.

Hence we may specify the capacity of the spherical condenser as,

$$\frac{A}{4 \pi Z}$$

"This result is general; for it does not really matter whether the condenser is spherical or not, provided the dielectric thickness is uniform. It will do equally well for a pair of flat plates, one earthed, the other insulated, each plate of area A . So the capacity of a condenser in general is,

$$\frac{A}{4 \pi Z}$$

provided only air or ether is between the plates. If, however, some other substance is used as the insulator or dielectric, such as glass or mica or paraffin or oil, we must multiply this value by the specific inductive capacity of the material relative to air, as determined by Faraday; and may thus get four or five times the air-value. This numerical ratio has to be determined by experiment for different materials, and is usually recorded among the data characteristic of different substances.

SECTION X

Coils

To look upon a single layer coil of wire wound upon a homely cardboard cylinder, one might think, and logically enough, that such coils function on very simple principles and that they could not be involved in the delicate formulæ of the engineer. If such a coil should be prepared for use in a direct current circuit, this speculation would be justified, but when they are used in a radio-frequency circuit, many very interesting things take place. As a matter of fact, it would be possible to write a book about the things that happen, although this may amaze the layman who visualizes nothing but a magnetic field about the coil when it passes current.

In the following paragraphs we will consider only those phenomena that effect radio reception. The reader will also notice as he goes on that the phenomena discussed become more and more involved and while the serious student may wish to continue through to the last, the reader who does not care to enter into mathematical discussion may stop midway feeling that he has a good practical understanding of coils and their function.

In Section IV we learned that coils of wire were used for two general purposes. Their most important use was in the process of tuning. By connecting a coil of wire to an aerial and varying the length of the coil through a movable contact it was found that the wave-

length of an aerial system could be adjusted to different values depending upon the amount of wire in the coil. Coils are also used as the medium for the transfer of electrical energy from one circuit to another through electromagnetic induction.

In our early discussion of the simple laws of electricity, we saw how two different circuits involving two coils in proximity could be used for a transfer of energy. The first circuit involving a current source and a coil would transfer energy to a second circuit containing nothing but a coil with a current detecting instrument. We see this principle used again and again in radio circuits where one coil is coupled to another so that energy may be transferred from the first to the second circuit and so on. In some radio receivers the electrical energy is transferred as many as ten times. That is it jumps (electromagnetically) across ten gaps between the aerial and the reproducing device.

During the past two years radio engineers have set out on a campaign to reduce the electrical losses in radio receiving equipment. A great deal of their effort has involved coils and many improvements have been made that have helped to stop the appalling waste that takes place in the ordinary types. Let us for the moment focus our attention on the very common form of coil in Fig. A. Here we have an insulated tube which may be bakelite, hard rub-

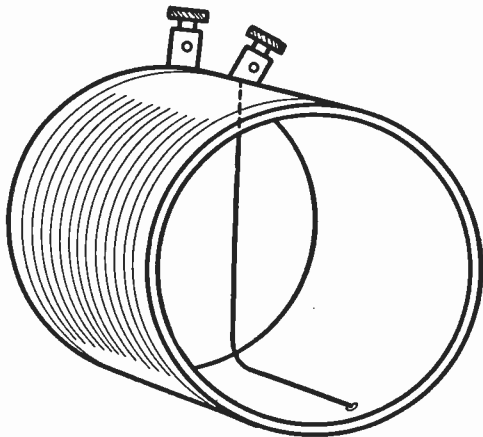

A SIMPLE INDUCTANCE COIL

Figure A: A simple inductance coil of the type usually found in radio receivers. Coils take various forms, but this type is conventional.

ber, fibre, cardboard, glass or wood. Upon the outer surface of this tube is wound a number of turns of insulated wire and the ends of this wire are connected to two binding posts or terminals mounted at one end of the tube. To lay any claim to perfection such a coil would have to have (1) very low resistance, (2) no distributed capacity and (3) a maximum inductance for the amount of wire used.

The first of these important features does not depend entirely upon the ohmic resistance of the wire. The best we can do in selecting the wire for a coil is to see that it has a sufficiently large cross section, that the insulation is of the best possible kind (silk, for instance) and that the wire is of pure copper. As we shall see later, the wire alone does not determine the resistance; it is only one factor. In the case of direct current, the wire alone would be the only thing considered in determining the number of ohms of resistance in the circuit. The use of high-frequency cur-

rents changes all of this and our very simple little coil becomes a veritable bundle of the most intricate phenomena.

In a previous paragraph we mentioned distributed capacity. Unless the reader has studied literature of this type before, the term will be a new one to him. We know that capacity is a term used in connection with condensers and we know further that condensers are made up merely of two conducting surfaces or elements such as metal plates separated by a non-conducting medium such as air or glass. A simple combination of these elements is capable of storing electricity providing there is a *difference in electrical potential*. Such capacities are also capable of transferring energy from one circuit to another through what is known as *electrostatic coupling*.

Where there is a difference of electrical potential there is always a capacity effect; by this we mean that the elements involved tend to act as an electrical condenser. We know that

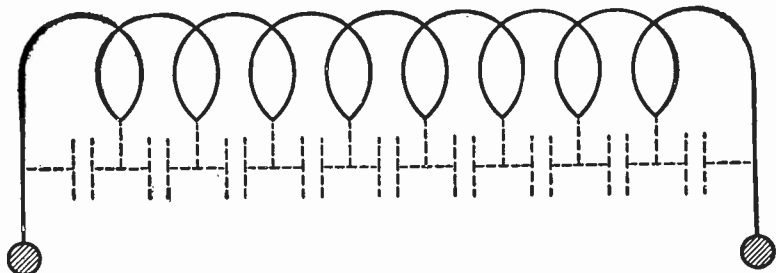

ILLUSTRATING THE CAPACITY BETWEEN TURNS.

Figure B: The dotted lines in the diagram represent the small condensers that are formed between the turns of an inductance coil used in a radio receiver.

when current is allowed to pass through a coil such as we have been dealing with there will be a higher potential at the entrance to the coil than at the exit. No matter how well the wire in the coil conducts electricity, it will offer some resistance and this will create a *potential difference* between the terminals. Not only this but there will be a potential difference between every turn of the coil, because of the electrical resistance offered. If there is a potential difference between each turn of the coil and the turns are insulated from each other, we may look upon the coil as having a number of tiny condensers connected between its turns. Reference is made to the sketch (Fig. B) where this effect is diagrammed. We do not need to merely imagine the presence of these little condensers for they are there just as surely as the coil itself and it is this effect that is called *distributed capacity* and it is a phenomenon that associates itself only with alternating currents in the higher frequencies.

It will be evident that coils with a minimum distributed capacity are desirable for we shall see that the charging of all of these little condensers involves a loss of energy and that we must strive in designing coils to minimize this capacity effect between turns.

The nature of the insulation on the wire and the distance separating the turns of the wire will effect this so-called distributed capacity. If we should wind a coil with silk covered wire, measure its capacity and then apply to the wire a coat of shellac we should find that the distributed capacity would be greatly increased and that the electrical efficiency of the coil would drop to a lower level. It might be well to warn the reader here against this practice. Oftentimes the shellacing of a coil will render a radio receiver totally inoperative. If the coils in a Cockaday four-circuit tuner are shellaced, the receiver becomes practically useless, due to the drastic increase in capacity.

Let us go back to the simple coil that we have been analyzing and see if we cannot find other capacity effects. It will be noticed from the drawing that the terminals are mounted at one end of the coil and that the wire from one end of the coil runs down the inside wall of the tube to make connection to one of the terminals. This wire runs directly under the turns of wire on the outside of the coil and it is separated from them not only by the insulation of the wire but by the material of which the tube is constructed. Here we have a wire running under wires of a higher

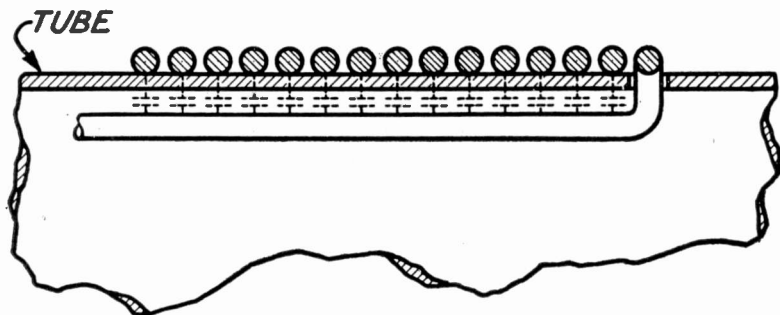

ANOTHER SOURCE OF USELESS COIL CAPACITY

Figure C: How capacity is formed between the turns and lead wire of a coil. This difficulty may be easily overcome, however, by running the lead wire through the tube concentrically.

potential and consequently we must have a capacitative effect. This effect will be as illustrated in the accompanying sketch, Fig. C.

We know that the terminals of the coil must be at different potentials and, if they are mounted as shown in the original sketch (Fig. A), we know that there must be a capacitative effect between them. This is also shown in Fig. D. If these terminals are placed close together, the capacity of the condenser of which they form the plates can be very high for we must remember that the maximum potential difference is at the ends of the wire. Since the capacity of condensers decreases as the distance between the plates is increased (this follows an inverse law), it will be seen that efficient coils should have their terminals as far removed from each other as possible.

Condensers used in combination with coils form a practical tuning combination and such combinations are widely employed in radio receivers. Let us see now what effect this distributed capacity would have in a coil used in combination as depicted in Fig. E. Here it will be seen that the condenser is connected in parallel or shunted across the

terminals. Back in our discussion on condensers, we learned that when condensers are connected in parallel the capacity is added. From this it will be seen that the capacity of the condenser connected across the coil will be added to the distributed capacity of the coil itself. Thus, if the coil has a distributed capacity of 50 mmfd. (mmfd. = micro-micro farad) and the variable condenser a minimum capacity of 20 mmfd., the minimum of the system in general will be 70 mmfd. If the condenser has a maximum of 250 mmfd. the maximum of the system will be 300 mmfd. Such a combination will give a range of capacity of approximately 1 to 4 or wavelength of 1 to 2, since the wavelength varies as the square root of the capacity.

If the capacity of the coil should be reduced to 25 mmfd., the minimum capacity with the same condenser would be 45 mmfd. and the maximum 275 mmfd. With this combination we would have a capacity range from 1 to 6 and a wavelength range of from 1 to 2.4 instead of from 1 to 2 as in the case of the coil with the distributed capacity of 50 mmfd. From this, it is evident that the wavelength variation will be greatest

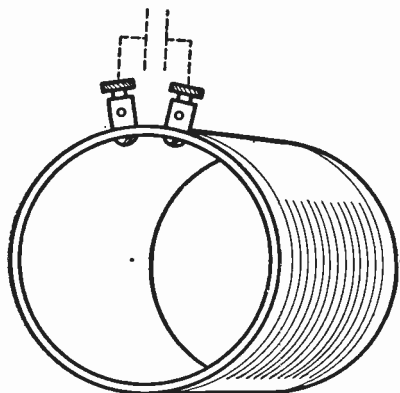

THE CAPACITY BETWEEN COIL TERMINALS

Figure D: If the binding posts of a coil are mounted close together as illustrated, a capacity will be formed between them. This capacity, like all other unwanted capacity in a coil, helps to reduce the efficiency.

in systems of this nature when the distributed capacity of the coils used is minimum. Not only this, but there is a great saving in energy and the electrical losses will be less when the distributed capacity is low.

Coils should be designed to get as great a tuning range as possible with a given variable condenser. This condition is met when the capacity of the variable condenser is small and the number of turns in the coil large. Signal strength will be high when large amounts of wire are used. However, this object is defeated when the distributed capacity is allowed to reach a great value. The Fig. F herewith shows a conventional type of coil investigated some time ago by Prof. Morecroft of Columbia University. It will be noted that the two leads from the coil make connections to the terminals inside of the tube. When first tested, this coil had a natural period or a natural wavelength of 117 meters. When the two leads were taken

away from the terminals in the wooden end, the wavelength was reduced to 93 meters. When the long lead was run through the coil as concentrically as possible, the wavelength was reduced to 86 meters and a further reduction to 71 meters was the result when the binding posts were placed one at each end of the coil near the ends of the wire. This also reduced the distributed capacity from 13.7 mmfd. to 5.05 mmfd.

In general it must be said that coils should have a minimum of bulk, or better that the forms upon which the coils are wound should have a minimum bulk. This is so because we do not want to introduce a large amount of dielectric material into the magnetic and electrostatic field produced by the coil. The material must be moisture proof and it must have sufficient strength to be mounted so that the turns will remain intact and vibration will be eliminated.

We must come back to the subject of

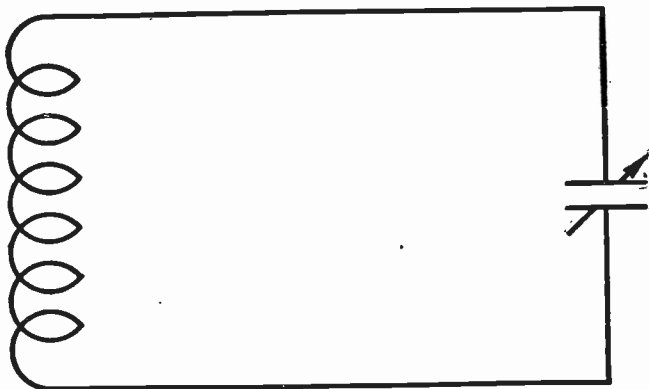

A COIL AND A CONDENSER

Figure E: The text will explain how the combination of a coil and a condenser in a radio receiver will be affected by the presence of a large amount of distributed capacity in the coil.

distributed capacity to consider means of reducing this effect by winding the wire so as to minimize the electrostatic field produced by potential differences. Since we know that the capacity of two bodies to store electric current decreases inversely as the square of the distance separating them, it should be our object to place the turns of every coil as far apart as possible. To follow this practice blindly would be very impractical for our coils would be so cumbersome as to require many times the space that they now occupy. Some coils are being based on this principle using a separation of about 1/16th of an inch between the turns and winding the coil upon very slender frames having little bulk. Such coils are said to have low losses and it is true that they are more efficient electrically than ordinary types.

Lorenz, an electrical experimenter, developed a method of winding coils that greatly reduces this destructive distributed capacity. By winding the wire upon a series of pegs arranged in a circle he was able to zigzag it in the fashion

illustrated (Fig. G). If this method is examined closely it will be seen that no two wires parallel each other for any distance at close proximity. The turns are close to each other only at points where the wires cross and, of course, there will be a capacity effect at these points but it will be so small as to be well beyond values ordinarily obtained.

There is still another method of winding Lorenz coils by mounting the pegs radially and zigzagging the wire to form a pancake type of coil. (See Fig. H.) Spider web is the name usually applied to coils of this type and owing to this zigzagging method, the distributed capacity of these coils is also reduced to a fair minimum.

The most practiced method of varying the inductance of plain coils is that of providing the coil with tapped joints as illustrated (Fig. I). The introduction of these points, due to their electrical effect, immediately contributes to the losses already taking place. They not only add resistance to the coil, but distributed capacity as well, for there will

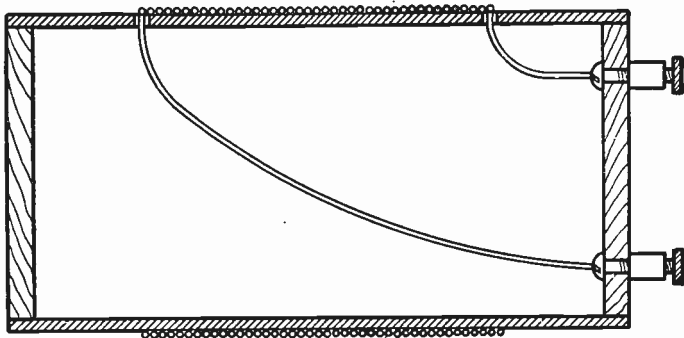

A COIL MADE FOR RESEARCH PURPOSES

Figure F: Prof. Morecroft of Columbia University investigated a coil built in the manner illustrated above and found out many interesting things. The results are given in the text.

be a difference of electrical potential between each point and between each lead. Of course, this cannot help but establish a capacitative effect between these members and to this there will be added resistance. The effect would be the same as that illustrated; we would have a coil used with a number of very small resistances and small capacities.

In viewing our tapped coil diagram, we will notice that when the switch point is not on the last tap that there is an unused portion of the coil. This is usually referred to as a *dead end*. As a matter of demonstrative fact, there is really no such a thing as a dead end and if we could apply the proper measuring instruments we would find that this dead end was a greedy consumer of energy and that it would do a great deal to reduce the general efficiency of the coil.

Perhaps the average reader of this manuscript has heard honeycomb coils alluded to in conversation between amateur radio telegraphers. The honeycomb coil which we have illustrated in Fig. J is really a coil of the Lorenz type, since the various turns are caused to

cross each other at different angles. This quite naturally reduces distributed capacity and produces a more efficient radio inductance. Such coils are ordinarily employed with small plugs and there is a measurable capacity across the terminals of such plugs. This capacity will act as a condenser shunted across the coil. However, this need not worry the novice for even with this drawback, honeycomb coils are decently efficient and they are very convenient for use as loading coils, wave trap inductances, and tuners. When used as a variable tuning device, the honeycomb coil must be provided with a standard. The holders for the coils proper are made movable so that the inductive relationship between the coils (and thereby the wavelength) can be altered. When the coils are close to each other, there is close coupling and maximum wavelength and when they are away from each other, there is minimum coupling and minimum wavelength.

Since these coils are interchangeable in their mountings, and since they may be purchased in a wide variety of sizes,

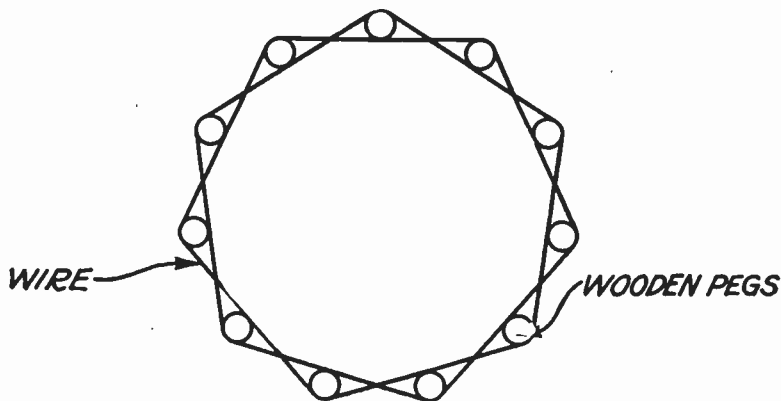

A FORM OF THE LORENZ COIL

Figure G: By winding wire zig-zag on pegs in the manner illustrated, the distributed capacity may be reduced greatly.

they are very convenient in making large changes in the wavelength of any receiver. The amateur experimenter equipped with a group of these coils may change the wavelength of his receiver from the broadcasting range to the high transatlantic telegraph range by simply

inserting a new set of larger coils which is a mere matter of a few seconds.

To facilitate the use of such coils we have included two tables which will be found quite accurate for the duo-lateral or honeycomb coils that are now obtainable in every radio store. In one table

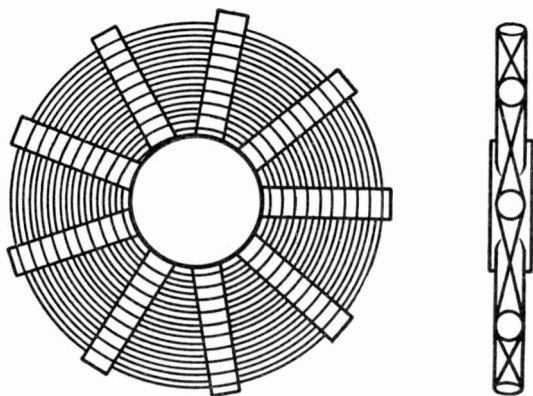

ANOTHER FORM OF LORENZ COIL

Figure H: This is also a Lorenz coil wound in a different fashion. The wire is zig-zagged around pegs placed radially.

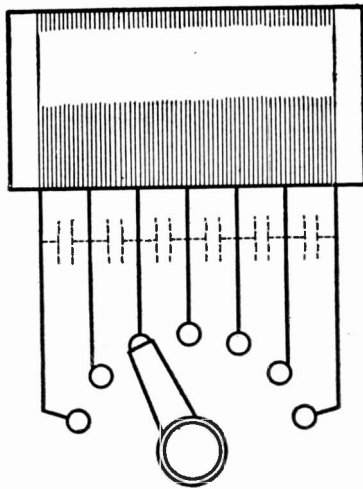

CAPACITY BETWEEN COIL TAPS

Figure I: This is what happens when the taps of a coil are placed too close together.

we show the natural wavelength range of the coils with different turns. In the second table the average wavelength obtained with honeycomb coils and 5, 11, 21, and 43 plate condensers is given. In such cases, it is assumed that the variable condenser used is connected directly across the terminals of a coil.

There are many, many different types of coils and we could carry this discussion on for hundreds of pages without having exhausted the fund of data that is available. What we wish to do is to familiarize ourselves with the most pertinent features of coils in general. This grounding will permit us to use good judgment in the choice of coils for receiving sets, and, after all, modern receiving sets are largely a matter of vacuum tubes, coils and condensers. The rest of the material used must be of an accessory nature.

In the accompanying sketch (Fig. K) we see still another type of coil which is called the "D" coil, so named because its

two halves form the letter D. It might just as well be called a figure-8 coil, for it also forms this figure. It will be seen that this coil is wound by slotting a tube in the manner illustrated. The wire used may range anywhere from 14 gauge to 28 gauge depending upon the range of wavelengths desired.

Due to its peculiar construction and the fact that the magnetic fields produced by each half of the coil oppose each other, the coil produces a very small total magnetic field. This makes the device of value in reducing to a minimum stray magnetic coupling with other coils in the receiver. To put it more clearly, this coil may be used closer to other coils without danger of magnetic coupling.

In still another sketch (Fig. L) we see what is known as a bank wound coil and here again the effort is toward increasing the electrical efficiency by decreasing losses through distributed capacity and resistance. By bank wound

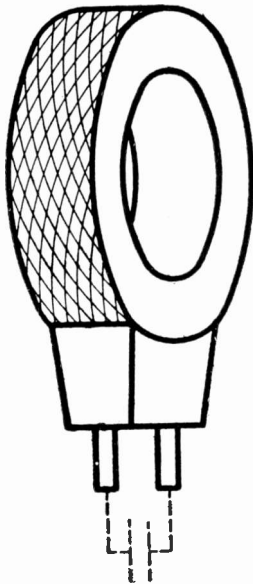

A HONEY-COMB COIL

Figure J: This picture not only shows the conventional form taken by honey-comb coils but also the distributed capacity that may exist between the terminals.

HONEY-COMB COIL CHARACTERISTICS

No. of Turns	Inductance in Millihenrys at 800 Cycles	Natural Wavelength in Meters	Distributed, Capacity Micro-micro Farads
25	.039	65	30
35	.0717	92	33
50	.149	128	31
75	.325	172	26
100	.555	218	24
150	1.30	282	17
200	2.31	358	16
249	3.67	442	15
300	5.35	535	17
400	9.62	656	13
500	15.5	836	13
600	21.6	1045	14
750	34.2	1300	14
1000	61.0	1700	13
1250	102.5	2010	11
1500	155.0	2710	13

coils we mean coils that are wound with staggered turns of wire. We will obtain a very good idea of the procedure followed in winding such coils upon tubes. First, two turns are wound upon the tube, one following the other. When the second turn is finished, the wire is given a little kink and the next turn is placed so that it will come between and on top of turns 1 and 2. Then the wire is kinked again and turn 4 is made. Then turn 5 is placed on top of 2 and 4, etc. By following the bank wound

method we obtain a very compact coil with a most respectable low degree of distributed capacity.

It is more than likely that the average readers of this discourse will understand very little about wire sizes or the general nomenclature in use by wire manufacturers. Yet a little more than a smattering of facts is necessary if the student is to gain more than a superficial mastery over the subject of radio. Perhaps there is no better place to insert material of this nature since we have

MINIMUM AND MAXIMUM WAVELENGTHS OBTAINABLE WITH DUO-LATERAL COILS WHEN USED WITH VARIABLE CONDENSERS*

Type No. of Pacent Var. Con.		3 Plate		5 Plate		11 Plate		21 Plate		43 Plate	
Capacity Range of Con- denser in Micro-micro Farads	Max.	49		91		208		418		877	
	Min.	7		8		10		13		21	
Coil Numbers	Wave Length in Meters		Wave Length in Meters		Wave Length in Meters		Wave Length in Meters		Wave Length in Meters		
	Min.	Max.	Min.	Max.	Min.	Max.	Min.	Max.	Min.	Max.	
US 25.....	75	105	75	130	75	180	120	245	120	355	
US 35.....	105	145	105	175	105	245	160	335	160	480	
US 50.....	145	205	145	250	150	355	220	485	220	690	
US 75.....	195	290	200	365	210	520	340	715	340	1020	
US 100.....	250	380	255	475	260	675	430	930	430	1330	
US 150.....	335	550	340	705	355	1020	680	1410	680	2060	
US 200.....	435	730	445	935	465	1350	900	1880	900	2700	
US 249.....	535	910	560	1170	575	1700	1100	2370	1100	3410	
US 300.....	680	1120	690	1430	720	2140	1400	2870	1400	4120	
US 400.....	830	1450	870	1880	890	2750	1800	3830	1800	5500	
US 500.....	1050	1840	1080	2390	1120	3430	2300	4870	2300	7000	
US 600.....	1270	2200	1300	2840	1360	4130	2800	5700	2800	8200	
US 750.....	1600	2760	1680	3570	1710	5100	3500	7200	3500	10400	
US 1000.....	2090	3660	2140	4750	2240	6900	4700	9600	4700	13800	
US 1250.....	2570	4670	2640	6000	2770	8900	6000	12500	6000	18000	
US 1500.....	3320	5800	3400	7500	3570	11000	7500	15400	7500	22100	

Note—In making calculations of the 21 and 43 Plate condensers a minimum capacity of 100 micro-microfarads has been assumed which includes the capacity of accessories in the circuit.

*Courtesy of Pacent Electric Company.

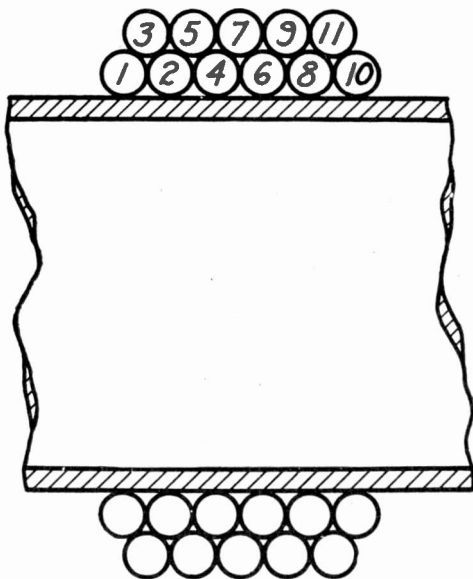

HOW BANK WOUND COILS ARE MADE

Figure L: The method used in winding a bank wound coil. The numbers on the wires indicate the order in which they are laid down.

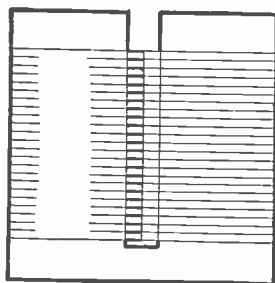
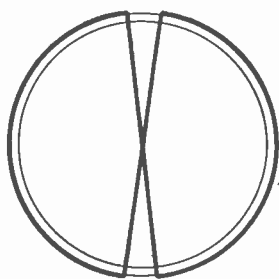

THE CONSTRUCTION OF THE D COIL

Figure K: A simple but effective coil with a fair degree of electrical efficiency to its credit.

just completed a popular explanation of coil phenomena and are about to embark upon technical features of design.

When a wire is referred to by a certain number, as, for example, "No. 16 or No. 28," this number means the "gauge" of the wire. It is a way of specifying the thickness. It would be much more convenient and scientific simply to set down the diameter of the wire in thousandths of an inch or in millimeters, but years ago engineers got into the habit of specifying the sizes of wires and rods and plates by the particular slot or hole in a "gauge plate" into which the wire or other thing would fit. The habit has persisted. These slots or holes were numbered, hence the present numbers used to designate the sizes of wire.

Many such systems of gauges have been in use in different countries and at different times. In the United States, for use with copper wire, only one of these systems has survived. This is the American Standard or "Brown and Sharpe" gauge, often referred to as the "B. and S." gauge. The numbers in it are purely arbitrary, like the width letters for shoes. The gauge numbers do have, however, a mathematical relation to each other such that an increase of three numbers means a decrease of the cross-section of the wire by just one-half; which means, in turn, a doubling of the electrical resistance of each foot of the wire.

It is useless, however, to bother about remembering this mathematical relation. The table printed with this article gives the numbers in the Brown and Sharpe gauge, with the diameters of the wires in "mils," one mil being one thousandth of an inch. In this table, for example, number 18 wire is seen to have a diameter of 40 mils, which means that

its thickness is 40 thousandths, or one twenty-fifth of an inch.

In many of the books you will see tables of "circular mils." This is the *square* of the diameter of the wire in mils. For example, number 18 wire equals, in circular mils, the square of 40, or 1,600. Note that this is *not* the area of the cross-section of the wire, for the wire is circular instead of square and the area of its cross-section is not the square of its diameter but must be calculated from the geometrical formula for the area of a circle.

Fortunately the possible confusion about the circular mils has little importance in radio calculations as circular mils are not much used by radio writers. The best thing to do is to use always the *diameter* of the wire in mils. If figures are given in circular mils take the square-roots of the numbers and you will have, in all cases, the diameters of the wires in mils.

The electrical resistance of a copper wire depends on its cross-section. In the table are given the resistances of wires of the different gauge numbers for direct current at ordinary room temperatures. In practice these resistances must be considered merely as approximate values, since the resistance of wire varies slightly with the hardness or softness of the wire, with the temperature and sometimes with other things. The figures in the table are close enough for all ordinary purposes.

Bear in mind that these resistances are for *direct* current. For ordinary alternating currents, such as are used in power work or in house lighting, the resistances are about the same, but for radio-frequency currents the resistances are quite different because of the skin effect. It is impossible to give a general table for resistances at radio frequencies since the frequency, the nature

THE SIZES AND PROPERTIES OF DIFFERENT KINDS OF COPPER WIRE

B & S Gauge	Diam. Mils.	Feet Per Pound	Ohms Per Foot	TURNS PER INCH			Enameled
				Bare	S. C. C.	D. S. C.	
8	128	20	.00064	7.8	7.3	7.7
9	114	25	.0008	8.7	8.2	8.6
10	102	32	.0010	9.8	9.2	9.6
11	91	40	.0013	11.0	10.3	10.8
12	81	50	.0016	12.3	11.5	12.1
13	72	63	.0020	13.8	12.8	13.5
14	64	80	.0026	15.6	14.3	15.1
15	57	100	.0033	17.5	15.9	16.9
16	51	127	.0041	19.6	17.9	18.3	18.9
17	45	160	.0052	22.2	20.0	20.4	21.3
18	40	200	.0065	25.0	22.2	22.7	23.8
19	36	260	.0082	27.7	24.4	25.2	26.5
20	32	320	.0104	31.2	27.0	28.0	29.7
21	28.5	408	.0131	35.1	29.9	31.0	33.1
22	25.3	515	.0165	39.5	33.9	34.4	37.2
23	22.6	650	.0208	44.2	37.6	37.9	41.5
24	20.1	820	.0262	49.7	41.5	41.8	46.5
25	17.9	1,030	.0330	55.8	45.7	46.1	52.1
26	15.9	1,300	.0416	62.8	50.2	50.8	58.5
27	14.2	1,640	.0525	70	55	55	65
28	12.6	2,060	.0662	79	60	61	73
29	11.3	2,600	.0834	88	65	66	82
30	10.0	3,280	.105	100	71	72	91
31	8.9	4,140	.133	112	77	78	103
32	8.0	5,230	.167	125	83	84	115
33	7.1	6,570	.211	140	90	91	130
34	6.3	8,330	.266	158	97	99	145
35	5.6	10,480	.335	178	104	106	161
36	5.0	13,200	.423	200	111	114	180
37	4.5	16,600	.533	222	118	121	204
38	4.0	21,000	.673	250	125	128	227
39	3.5	26,500	.848	285	135	137	256
40	3.1	33,400	1.070	322	141	145	286

of the winding, the character of insulation on the wire, the tube that it is wound on and even other factors, may affect the measured resistance of a coil.

For use in winding coils and in calculating the amount of wire needed for them the tables of turns per inch will be found useful. This means linear inch, along the coil, one layer deep. The figures are approximate only, as the wire made by different manufacturers differs slightly. "SCC" means "single-cotton-covered"; that is, a wire wrapped with one layer of cotton insulation. Similarly, "DSC" means "double-silk-covered" wire, having two layers of silk insulation. There are also "double-cotton-covered" and "single-silk-covered" wires but they are little used in radio work. Enameled wire, having a thinner and transparent insulation, is much used in radio.

Wires of unusual shape, as for example, square bus-wire, are usually specified by the number of the round wire to which they are equivalent in electrical resistance. This means that such wires have the number of the round wire having the same cross-section. A number 16 bus-wire, which is a common size for wiring radio sets, has as much copper in it per foot as has a number 16 round wire. There will be, therefore, about 1,275 feet of such wire in a pound.

In England an entirely different set of gauge numbers is sometimes used for

wires. It is called the "British Imperial Standard Wire Gauge," frequently abbreviated to "S. W. G." A few British publications use the Brown and Sharpe gauge just as we do, but if the gauge system is not specified it is safe to assume, in British work, that the S. W. G. system has been used. This system is also used more or less in other countries, though in France it is customary to specify, also, the diameter of the wire in millimeters. A millimeter is one thousandth of a meter or about .04 inch. One millimeter equals 39.37 mils, and one mil equals .0254 millimeter. These figures permit easy conversion of either one into the other.

The B. and S. gauge, the S. W. G. system, the measurement in mils and the similar measurement in millimeters are the only four ways commonly used to specify the size of copper wires. But for iron and steel wires three other gauges are sometimes used; the Roebbling gauge (also called the Washburn and Moen gauge), the Birmingham gauge and the Stubs steel-wire gauge. The Stubs *iron-wire* gauge (as contrasted with that for steel wire) is the same as the Birmingham gauge. All this is rather complicated but it has, fortunately, little application to radio as these gauges are not used for copper wires.

The approximate relations between the two gauges that are used for copper wires are given in the following table:

No. 10 S.W.G. (British)	equals	No. 8 B. and S. (American)
No. 14 S.W.G. (British)	equals	No. 12 B. and S. (American)
No. 18 S.W.G. (British)	equals	No. 16 B. and S. (American)
No. 22 S.W.G. (British)	equals	No. 21 B. and S. (American)
No. 26 S.W.G. (British)	equals	No. 25 B. and S. (American)
No. 30 S.W.G. (British)	equals	No. 28 B. and S. (American)
No. 34 S.W.G. (British)	equals	No. 31 B. and S. (American)
No. 42 S.W.G. (British)	equals	No. 38 B. and S. (American)

These relations are not exact, but give an idea of the relation between the two gauge systems. For the exact diameters of wires in the two systems, as well as for details concerning exact resistances and the like, it is necessary to consult the more comprehensive tables in the handbooks of electrical engineering.

By special permission of the Director of the United States Bureau of Standards, Washington, D. C., we are able to include in this data on coils a very practical and at the same time very accurate manuscript by Morris S. Strock of the Bureau radio staff:

"In the tuned circuit of every radio receiving set there are one or more coils of wire which carry the feeble alternating currents induced in the antenna by the incoming radio waves.

"Such currents go to make up a minute amount of electrical power. If the coils in which these currents flow are improperly made, they will waste a larger portion of this power than is necessary. This condition limits the flow of useful current with the result that the current value may not be quite high enough to produce an audible signal in the telephone receivers. In this case the substitution of more efficient coils would give understandable reception from a distant station when otherwise it could not be heard.

"A receiving set that employs regeneration or radio-frequency amplification will detect exceedingly minute currents, yet, there is always a threshold current value (in the vacuum tube) below which even these sensitive circuits will fail.

"There are two other reasons for using efficient coils, and these reasons involve the signals obtained from *any* transmitting station. The first of these additional reasons tells us that efficient coils increase the selectivity of the circuit.

"Selectivity is something every receiving circuit needs, and means of improving it are *well worth while*.

"Coils of low power loss will permit of good amplification without excessive filament currents or high plate voltages.

"This means that the signals will be less noisy and less distorted—and, to all those who are interested in broadcast programs, what single consideration is more important than that of securing reproduction which is natural and lifelike?

"Let us take an inventory of the factors that cause these power losses, in order to learn how to avoid them.

"*First*, it should be stated that power losses in a coil increase as the resistance of the coil is increased.

"Resistance—more properly called high-frequency resistance—may be measured. Radio-frequency resistance changes somewhat with the frequency, but at all radio frequencies the same features of coil construction always cause an *increase* in apparent resistance. Therefore, change of apparent resistance with frequency need not be considered in detail.

"Alternating currents of radio frequency are unevenly distributed through the conductor, their effect being most pronounced on the surface, and the higher the frequency the greater this *skin effect* will be. Therefore, if the surface area of the conductor is increased, its resistance will usually be decreased. For braided or stranded conductor this statement may not be literally true. For instance, at frequencies below 1,000 kc (wavelengths over 300 meters) a solid conductor sometimes has a lower radio-frequency resistance than stranded Lit-zendraht cable of greater surface area.

"*Second*, the insulating material between the turns of the coil increases its apparent resistance.

"This is due to a phenomenon called dielectric absorption. The insulation acts much the same as the insulation (dielectric) of a condenser, and if the insulating material is a poor dielectric the losses are relatively high.

"*Third*, the insulating material of the form upon which the coil is wound and other insulating material in the field of the coil, will also increase its resistance and for the same reasons just given.

"*Fourth*, any metal in the field of the coil will increase its radio-frequency resistance because the metal object has eddy currents induced in it and these currents absorb useful power from the circuit. At the back of the panel in many radio receiving sets is placed a metal shield which serves a certain useful purpose; it will, however, considerably *increase* the resistance of coils mounted too close to it.

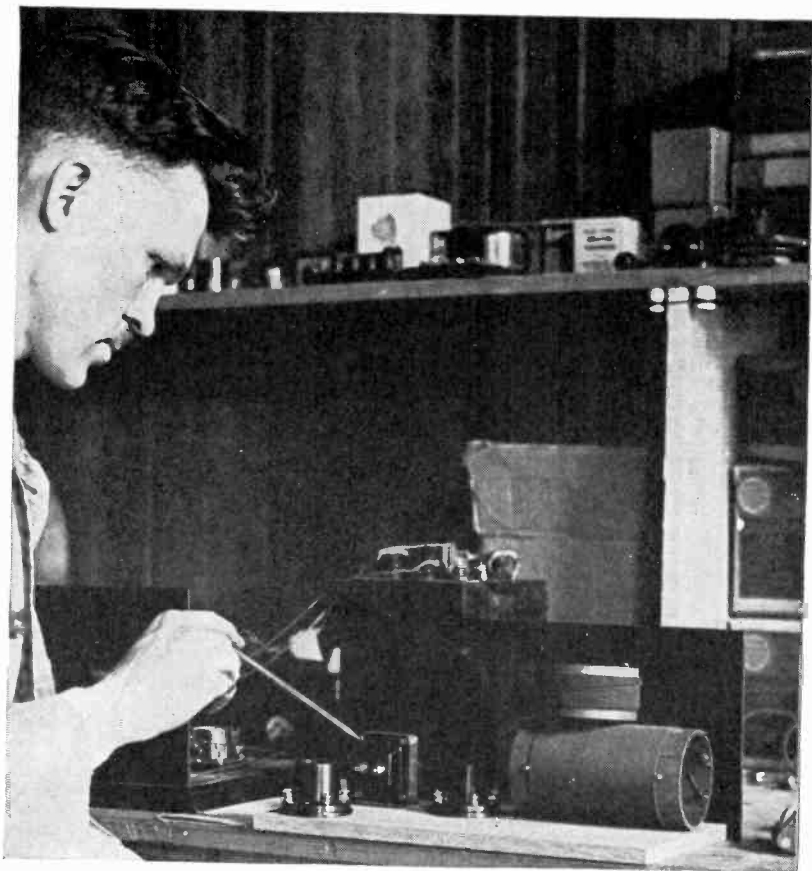

KEEP THE AUDIO TRANSFORMER AWAY FROM THE TUNING COIL

Figure M: In arranging the instruments, remember that audio transformers necessarily contain a lot of iron which has a particularly strong choking effect at radio frequencies.

"Fifth, leakage of current between the turns of the coil will increase its radio-frequency resistance. This most usually occurs when the conductor insulation collects moisture.

"Sixth, unused turns (dead ends) often increase the resistance of a coil. The dielectric effect previously mentioned, increases the distributed capacity of the windings and in the case of dead ends, a resonance effect may be obtained which causes the radio-frequency resistance to rise to a high value.

"Seventh, taps taken from the coil and connected to switch points, increase its resistance. The switch points being imbedded in insulating material, the phenomenon of dielectric absorption comes into play.

"Results of actual tests showing how the radio-frequency resistance of coils is increased will emphasize the remarks just given and point the way to practical hints forming the subject-matter of this contribution.

"A first example involves a typical coil (shown at the left in Fig. O) such as might be used in the antenna circuit of a receiving set. (For the present, the hand of the observer holding the metal rectangle is to be ignored; this will be considered shortly.)

"This coil was made by winding sixty turns of No. 20 DCC wire around a four-inch cylinder of phenolic insulating material (bakelite, so called, but actually it may be something else). At 750 kc (400 meters) the radio-frequency resistance of this coil was 3.2 ohms—and now comes the significant part of the experiment. An identical coil was wound on a dry cardboard cylinder and its resistance at the same frequency was only 1.1 ohms. Thus the humble cardboard, used in a dry place, was superior electrically (although not mechanically) to the more aristocratic insulating ma-

terial. This is not true, however, when the cardboard absorbs moisture.

"Now, consider the one-sixteenth inch brass rectangle shown at the left of this coil. Metal parts of greater weight or size than this are frequently used in mounting coils. For mechanical reasons this may be necessary, yet the amount of metal should be reduced as much as possible. The metal piece shown in the photograph was placed inside the coil and the apparent resistance was thereby increased 0.5 ohm.

"A final test of this coil shows the effect of leakage. A few drops of clean water were allowed to soak through the insulation over the area shown by the dotted lines, and the resistance of the coil was increased 0.6 ohm. This hints at the importance of protecting the coil winding from moisture, especially in the case of cotton insulation which readily absorbs moisture from damp air. These measurements were made in a dry atmosphere so that the cotton insulation was extremely effective.

"At the right of Fig. O is shown a so-called spider-web coil which was wound from No. 24 DCC wire on dry cardboard. This type of winding supposedly gives lower radio-frequency resistance than a winding in cylindrical form because of a slight spacing of the turns. This factor is, in itself, an advantage, yet due to the peculiar form of winding the losses may be unnecessarily high. At 713 kc (420 meters) the resistance of this coil was 3.9 ohms. Another coil was made by winding the same kind of wire on a cylinder of dry cardboard so that the same inductance was secured—that is, either coil could be substituted in the measuring circuit without changing its frequency. The radio-frequency resistance of the second coil was only 2.9 ohms.

"We now come to an excellent exam-

ple of how a coil should *not* be made. This is shown in Fig. P—the primary portion of a two-circuit tuner (loose coupler) made in the days when little was known of coil losses. If the designer had *tried* to secure a high radio-frequency resistance he could scarcely have done better! Note the large brass rod for the sliding secondary, the insulating material completely covering the

winding (70 turns of No. 22 SSC wire), the large switch points embedded in the insulating material, and finally, the large metal support for the coil form. This construction incorporates excellent *mechanical* features and one good electrical feature—firm contact on the switch points. In securing these results, however, the radio-frequency power losses were greatly magnified. A



THE WRONG WAY TO ARRANGE THE INSTRUMENTS

Figure N: If you place the audio transformer up against the tuning coil as shown, it may cut down the efficiency of the set as much as fifty percent. It will make the signals weaker and will cause the tuning to be very broad.

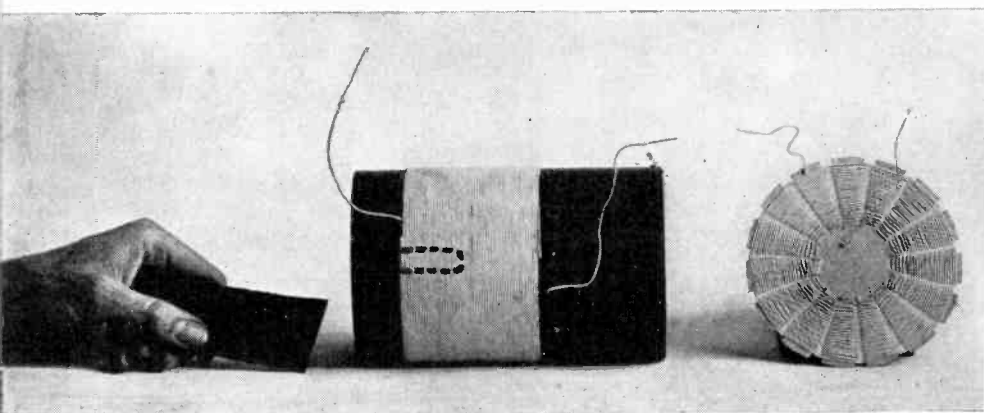

EXPERIMENTAL COILS THAT GAVE SURPRISING RESULTS

Figure 0: The dotted lines on the center coil indicate the area that was wet with a few drops of clean water. Wetting just this small portion of the coil greatly increased the resistance. The spiderweb coil was not as efficient as a straight cylindrical coil of the same inductance value.

measurement of resistance including all the turns of this coil, gave a value of 25 ohms at 483 kc (620 meters)—*at least five times the necessary value.*

“Thus far we have taken an inventory of the causes of power losses in coils and have given practical examples of these losses. Working from this foundation, we will now give practical hints for reducing or eliminating power losses. It must be borne in mind that merely substituting an efficient coil for one of poor design in a receiving circuit will not give any startling improvement in results, if the rest of the circuit and the antenna and ground system have an unnecessarily high radio-frequency resistance. Reasonable precautions in wiring and careful selection of parts should, however, take care of these difficulties. In the case of coils, the experimenter has quite a field, for he frequently makes them himself, or, if the purchased article is used, it can usually be rewound if necessary.

“An ideal coil, as far as power losses are concerned, would be one made by

winding a conductor of zero resistance into a coil having no material support and using the whole thing in an isolated position. This fantastic illustration emphasizes the importance of taking precautions which will approach this condition. These precautions will apply to all coils used in: wavetraps; single-circuit tuners; two-circuit tuners; regenerative tuners; tuned-radio-frequency transformers in reflex or neutrodyne circuits. Single-layer coils only, are assumed—multi-layer coils, except those having spaced turns, should *never* be used for broadcast or amateur frequencies.

“First considerations involve the conductor.

“Unless space is rather restricted it is a good rule to use nothing smaller than No. 20 copper wire. An instance was once noted, where, in the wiring of a receiving set, an inexperienced person had used steel wires! This introduced an unnecessary resistance of several ohms and the set would not operate satisfactorily. When some of the longer

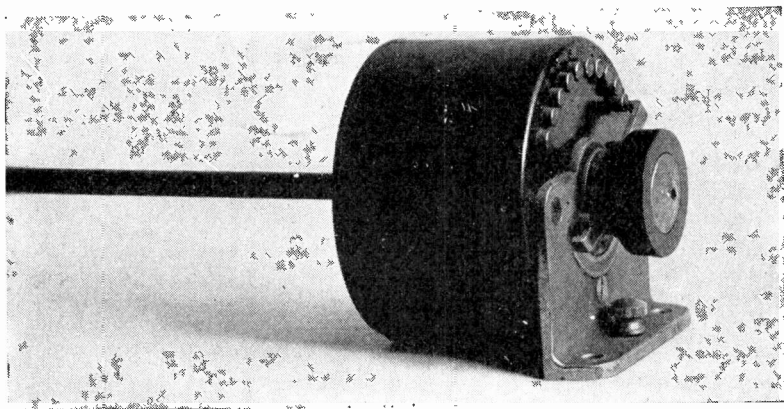

AN EXAMPLE OF ELECTRICAL INEFFICIENCY

Figure P: This primary portion of a two-circuit tuner (loose coupler) was made in the old days when little was known of coil design. It has almost every fault mentioned in this Section, including large masses of metal in the field and too much insulation material surrounding the coil. It has five times the resistance at radio frequencies that such a size coil should have!

steel wires were replaced with copper wires, the circuit gave good results.

“Stranded (Litzendraht) cable, consisting of enameled strands of fine wire braided in a special manner, often gives a lowered resistance at frequencies above 1,000 kc (wavelengths below 300 meters) provided the following precautions are observed:

“(1) Testing each strand for continuity;

“(2) Testing each strand, for possible shorting through insulation, with every other strand;

“(3) Observing great care in winding so that no strands will be broken;

“(4) Equal care in soldering terminals so that no strands will be missed.

“A violation of any of these conditions may cause an excessively high radio-frequency resistance. Precautions (1), (3) and (4) are necessary because the fine strands break easily and are difficult to solder; precaution (2) is necessary because ‘pin holes’ are common in the enamel insulation. The best way to remove enamel from these fine strands

is by heating cautiously to a dull red and plunging into alcohol.

“The insulation and spacing of the conductor is also important. Enamel insulation, alone, is not desirable because it gives a noticeably higher radio-frequency resistance than silk or cotton-covered wire of the same size. The enamel is a poor dielectric and because of its thinness, gives the coil a high distributed capacity—hence the resistance is increased. Double-cotton-covered wire is good, because the cotton insulation gives good spacing between turns, and the cotton itself, when dry, is an efficient dielectric. Enameled wire which has a double-cotton-covering has a peculiar advantage in that the enamel excludes moisture and prevents leakage losses while the cotton takes care of the spacing. Here the dielectric effect of the enamel is not serious because of greater spacing of the turns. Wire that has single cotton or single silk insulation is not desirable; double silk insulation is very good and does not absorb moisture as readily as cotton.

"Having decided upon the conductor and its insulation, it is logical to consider the winding form.

"Phenolic insulating materials, commonly used for this purpose, are usually not as good from the dielectric viewpoint as dry cardboard or wood, although their non-hygroscopic properties are excellent, as well as their ability to withstand high voltage. In the receiving circuit, however, no such voltages exist, so this latter advantage is *nil*. These materials are mechanically stronger than any other kind and this advantage is worth considering if the equipment is for rough portable use.

"Other winding forms are hard rubber, cardboard and wood. Hard rubber has excellent non-hygroscopic properties and most hard rubber has lower dielectric losses than cardboard or wood; it is also better from the mechanical viewpoint.

"Wood forms are not common except for use in rotors but for this purpose they may be made almost as efficient as cardboard. The wood should be treated the same as the cardboard but the drying process should be longer. One difficulty in the use of wood is that it may have been rather green when turned out at the factory. If a close examination reveals no sign of cracking and if the wood itself appears dry it is most probably well seasoned.

"Wood or cardboard forms as purchased should not have been varnished or treated with any compound, particularly black varnish, which may increase the power losses.

"In mounting the completed coil, precautions must still be observed but mechanical requirements of metal mean the sacrifice of some electrical efficiency. However, as little metal as possible should be used, especially inside of the coil. Also, the coil should be mounted

at least two or three inches from any shields at the back of the panel. Taps should be connected by short wires to switch points which should be small in order to reduce the dielectric effect of the insulating material in which they are imbedded.

"Two general factors can be taken advantage of to reduce coil losses. *First*, use no more turns or taps than are necessary; if a variable condenser is used, it will take care of the fine tuning adjustment. *Second*, do not use a long coil of small diameter, nor a very short coil of large diameter; to do so means that more wire will be needed to secure a given amount of inductance,—with the result that the radio-frequency resistance will be somewhat greater. It can be shown experimentally that the maximum inductance with a *given length* of wire is attained when it is wound in a coil with a diameter equal to about 2.3 times its length. This is a good standard to go by, but the limits are rather wide and coils somewhat longer or shorter, relative to their diameters, may be used, the approximate extremes in either direction being shown in Fig. Q.

"Coils of various fancy forms of winding may be purchased or the experimenter may be capable of winding them himself. Some of these coils actually have low losses while others may not be as efficient as simple single-layer coils wound with precaution. When coils are purchased, select those having lowest losses by avoiding:

"(1) Small conductors; (2) conductors having fine individual strands,—broken strands cause high resistance; (3) closely spaced enameled wire; (4) bulky coil forms; (5) coil terminals mounted in large blocks of insulating material; (6) large pieces of metal used in mounting; (7) heavily varnished windings; (8) more taps or turns than are necessary.

“One brief concluding sentence suggests the marrow of this contribution:

“As proved by laboratory tests, radio-frequency coils in a receiving set waste power, and definite precautions in coil construction reduce these power losses, enabling the set to give clearer signals.”

Those who wish to ascend to greater technical heights in the matter of coil design and construction will find in the following pages a beautiful contribution to the subject by no less an authority than Sir Oliver Lodge. While the facts presented may be beyond the point that the average experimenter cares to go, the mathematics are by no means beyond high school education.

“In the first place, to keep the distributed capacity to a low value the

actual wire used in coils for a receiving set should be thin, so as to expose but little surface. The wire should be of the highest conductivity, but the smaller its diameter the better, so far as this desideratum is concerned. Also the shorter the length the better, since the capacity varies directly with the length. The only disadvantage of a very fine wire is that its resistance is high. But, after all, resistance does not much matter. For a receiving station the current is feeble, and the thinnest wire will serve. It may be coated with silk, cotton or enameled. And if a stranded core is employed, the enameling of each separate strand is sufficient to keep them isolated from each other.

“But it is well to wind the turns of

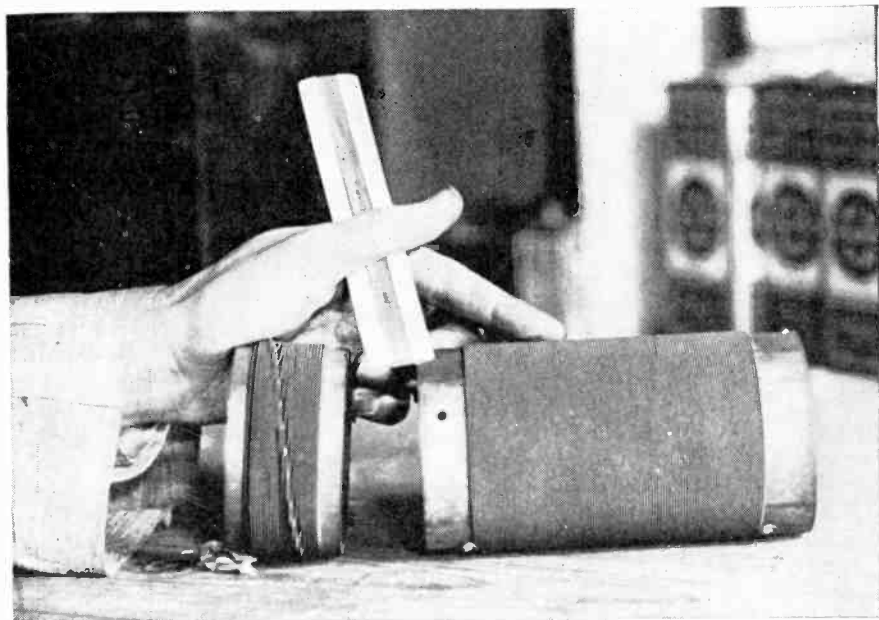

THE RELATION OF COIL DIAMETER TO LENGTH IS IMPORTANT

Figure Q: These coils represent about the limits of diameter and length for the highest efficiency. Avoid long, small coils and very large, short coils; both extremes are bad because they require more wire to get the same inductance—and this increases the loss.

wire not too close together. Hence a fairly thick cotton covering might be applied outside the real insulation, so as to diminish the capacity effect of each turn upon the others. The thickness of the ultimately covered wire may therefore, be three or four, or even ten times the thickness of the copper core; but we may doubt if it is ever necessary or advisable to use a covering as thick as that. And were it not for the practical experience which has developed "basket" or open winding, the author should have been disposed to advocate a close compact coil wound so as to give maximum inductance for a given length. In any case, maximum inductance must be aimed at, whether the covering of the wire be thick or thin. We shall assume then that the wire to be used has an external diameter or thickness T , and that the copper core has the thickness t , and shall proceed to consider what is to be done with it.

"Given the antenna capacity and the wavelength or range of wavelengths desired, we can at once determine the inductance or range of inductances necessary. Here is the formula, which gives the coil inductance as the square of the wavelength divided by forty times the antenna capacity; *everything being expressed in the same units of length*∗:

$$\text{Inductance} = \frac{\text{Square of wavelength}}{40 \text{ times the capacity}}$$

λ²

that is $L = \frac{\quad}{40C}$

"For instance, to receive on a wavelength of 200 meters with an antenna whose capacity is 1 meter, which would be a likely value for a single wire elevated by a pole 20 meters high, the coil must have an inductance,

$$L = \frac{40,000}{40} = 1,000 \text{ meters.}$$

that is, 1 kilometer, or 10⁵ centimeters, or a tenth of a millihenry. To get a wavelength of 1,000 meters with an antenna of 2 meters capacity would need an inductance

$$L = \frac{10^6}{80} = 12,500 \text{ meters,}$$

that is, 12½ kilometers or 1¼ millihenry. Twice this value would be needed if the capacity of the antenna were halved. But if the wavelength were to be doubled the inductance must be quadrupled.†

"Now, to get the necessary inductance in a coil, using the smallest length of wire, it must be wound on a frame of the following shape and dimensions, *viz.*, a disc coil of external diameter 14 units, of internal diameter 8 units, and with the channel for the wire a square, 3 units to a side. There remains only to determine the size of the unit which will give the required inductance L , for wire of given external thickness T . The formula for determining the actual size of the coil's external diameter D , is:

$$D^5 = 66.6LT^4$$

meter is ten percent bigger than a micromicrofarad.

For inductances the conversion is still easier:

1 henry = 10,000 kilometers = a thousand million centimeters

1 millihenry = 10 kilometers = a million centimeters

1 microhenry = 10 meters = a thousand centimeters

1 millimillihenry = 1 centimeter

Hence, to express inductances in centimeters is always quite easy.

∗See appendix at end of this Section.
†See Appendix for explanation. The following table will effect conversion from conventional capacity units to length units: the latter being in many respects more convenient except for large capacities:

1 microfarad = 9 kilometers
1 millimicrofarad = 9 meters
1 micromicrofarad = .9 centimeter

For practical purposes a capacity expressed in micromicrofarads may be interpreted at once as nearly equal to the same number of centimeters. A ten percent allowance can be made if desired, for a centi-

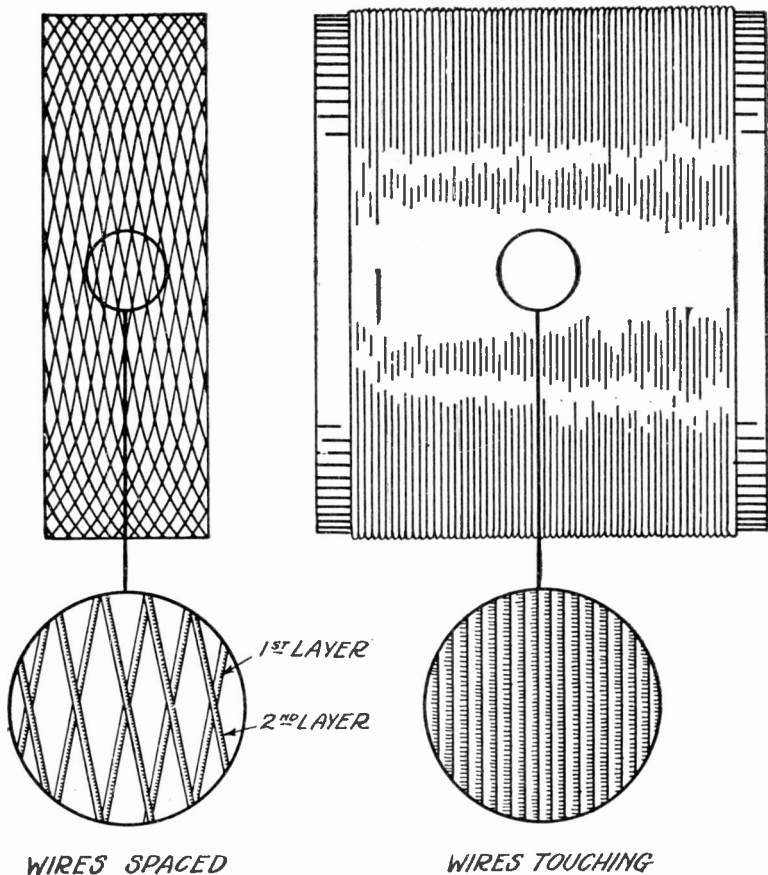

TWO STANDARD METHODS FOR WINDING COILS

Figure R: The coil on the left is known by numerous names, such as basket weave, honeycomb and duolateral; the turns of wire cross each other at an angle and therefore, the capacity between turns (called the "distributed capacity" of a coil) or between layers is low. Compare this method of winding with the coil on the right, which is an ordinary solenoid winding. Here the turns of wire lie right along side of each other and close together; the distributed capacity of such a coil is high, especially if a number of layers are wound over each other.

And once having determined D , the size of the coil is known in every detail, also the number of turns of the given kind of wire, and the length of wire necessary.

“The use of this formula will be best illustrated by an example.

“Suppose the inductance required is one millihenry, that is to say, 10 kilometers or 10^6 centimeters; and let the thickness of the covered wire be 2 millimeters or $1/5$ centimeter; then D^5 , comes out from the above formula as

$$D^5 = \frac{66.6}{625} \times 10^6,$$

or a trifle more than 10^5 ; and therefore the extreme diameter $D = 10$ centimeters practically. The internal diameter d will then be

$$d = \frac{8}{14} D = 5.7 \text{ centimeters};$$

the breadth of the coil b , or the side of the square channel in which the wire is wound will be,

$$b = \frac{3}{14} D = 2.142 \text{ centimeters};$$

the number of turns n , of covered wire of thickness five turns to the centimeter will be

$$n = \left(\frac{b}{T} \right)^2 = 115;$$

the mean radius of a turn r , is,

$$r = \frac{1}{4} (D + d) = 4 \text{ centimeters};$$

and hence the total length of wire is,

$$l = 2 \pi nr = 27.6 \text{ meters}.$$

“Or it may be more convenient to work with inches, so far as the workshop dimensions are concerned. If we

are dealing with the same inductance we must divide 10^6 centimeters by 2.54 to bring it to inches. Or we may take as example a round number: Let the required inductance be $L = 400,000$ inches, while T , the thickness of the wire, = $1/10$ inch. Then we can reckon the external diameter of the coil, in inches, as:

$$D = \sqrt[5]{\frac{66 \times 400,000}{10,000}} = 4.84 \text{ inches}.$$

So that the internal diameter will be $d = 2.72$ inches. And the side of the square channel $b = 1.03$ inch. The number of turns will be,

$$n = \left(\frac{b}{T} \right)^2 = 106,$$

and the length of the wire used,

$$l = \frac{1}{2} \pi (D + d) = 1,260 \text{ inches} \\ \text{or } 35 \text{ yards}.$$

“The result we see is not a large coil, even for so thick a covered wire. By diminishing the thickness of the wire the coil can be much decreased in size. For if the size of the channel is given, then the use of a wire of half the thickness will give a 16-fold inductance, because it depends inversely on the fourth power of the thickness. This is indeed obvious. For if the wire is half as thick, double as many turns can be put in each layer, and there will be twice as many layers, so the number of turns altogether is quadrupled. And as the inductance depends on the square of the number of turns, that will be magnified 16 times.

“As regards size of bobbins for a given thickness of wire, we can make this statement: doubling the linear dimensions of the bobbin for a given wire will magnify the inductance of the result-

ing coil 32 times. This is not quite so obvious, but it clearly appears from the formula, since L varies with the fifth power of D , and $2^5 = 32$.

"The first idea of self-induction originated with Faraday, long ago, but he was quite vague about it, and called it "the electrotonic state of a conductor." It puzzled him a good deal, and he treated it almost as if it were some chemical property of the metal, acquired under electrical influence. He named it "electrotonic state" in November, 1831, during his great discoveries in electromagnetic induction generally.

"The idea became rather more definite in the hands of Sir William Thomson (Lord Kelvin), who in 1853 gave the mathematical theory of electrical oscillation. He perceived a sort of analogy between Faraday's electrotonic state and electrostatic capacity—only he perceived it was kinetic instead of static—and he therefore called it "the electrodynamic capacity of a discharger." In other words, he found that it was a *constant* belonging to all the wire circuit through which a Leyden jar discharged. Thus in an oscillating circuit there were the two things, both essential to oscillation:

"*First*, the electrostatic capacity of the charged areas:

"*Second*, the electrodynamic capacity of the connecting wire or discharging rod. Resistance came in subordinately, as a damper of oscillation, in a comparatively simple way which he thoroughly understood.

"Then, later on, it was realized that just as two wires lying alongside of each other had a mutual coefficient of induction, so that the one induced currents in the other (as discovered by Faraday)—each being susceptible to the rate of variation of the current in the other—so it might be said that every longitudinal

part of a single wire reacted on the other parts of the same wire, or, in other words, that the wire was itself susceptible to the rate of variation of the current in itself. Hence it was possible to speak of not only the mutual induction of two parallel conductors, but of the self-induction of one. And so Maxwell introduced the term "self-induction," and made it quite definite and calculable. Later, Heaviside styled it inductance, to correspond with resistance.

"There are two ways of calculating this quantity, now commonly denoted by the letter L . One is to reckon the number of magnetic lines of force which effectively surround a wire carrying a current—the momentum, so to speak, of its magnetic field—and to call that momentum L_1 , where 1 is the strength of current. The other is to treat the wire as if stranded, and to reckon the mutual induction of the strands on each other. This can be done by taking it as equal to the mutual induction of two parallel wires at what is called the "geometric mean distance apart": that is to say, at a distance determined by the shape and size of the cross section of the single wire—a distance which can be reckoned as the average distance of the points in such a section from each other. It is all worked out in Maxwell's great treatise, published in 1873; and he gives an expression for this geometric mean distance for different shapes of section. It is important, because it applies, not only to a single wire, but to the cross section of the wound channel in a coil. That cross section may be square, or oblong, or round—as when the coil is shaped like a curtain ring.

"In practice the section is usually oblong or square. It may be oblong *broadways*, as when one or a few layers are wound cylindrically on a tube; or

oblong *depthways*, as when short layers are wound so as to be piled on top of each other, making a sort of disc.

“For a coil with one narrow dimension (that is to say, for a winding whose section is a thin oblong, whether the coil is wound horizontally or vertically) the geometric mean distance asunder of its parts is .223, or say a quarter, of its larger sectional breadth.

“For a square section, the value is .45 times the length of one of the sides, that is, about half the side of the square.

“For a circular section it is .78 or say three quarters of the radius.

“For an oblong section in general, the accurate expression is decidedly complicated, involving logarithms and tangents, but it may be taken as approximately a quarter of the width and depth of the section added together;

more accurately, $\frac{b+d}{\sqrt{20}}$, which is very

nearly right. The complete formulas will be found in Maxwell, or quoted

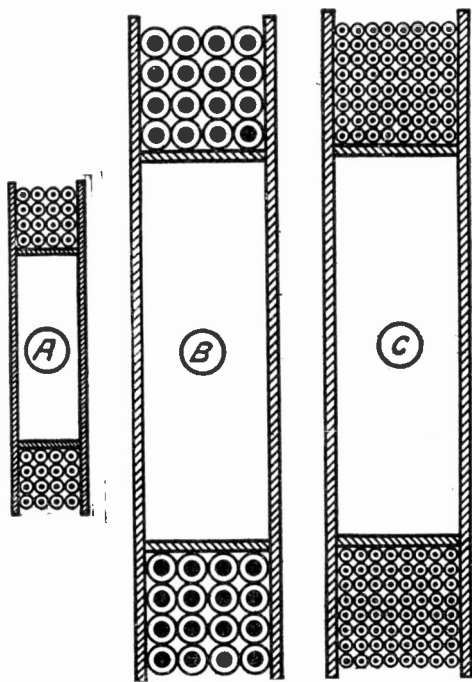

FIGURE 5

It is interesting to note that if we build a coil of certain dimensions A, it will have a certain inductance. If we double all its dimensions, including the diameter of the wire (as in coil B), the inductance will increase very slowly in proportion to the added size. If, however, we keep the wire the same size as in the first coil and at the same time double all the other dimensions of the coil, as in C, we will find that the coil has inductance 32 times greater than coil A.

in Professor Fleming's comprehensive treatise and we need not attend further to it now, because we want to concentrate on the most compact section—either a circle or a square. For it is this compactness which gives the maximum self-induction.

“That, however, is not all that is necessary to be known, by any means. That only determines the shape of the channel in which the wire is wound. We must know the average size of the channel in relation to the circle of wire so formed, that is to say, we must know the external and internal diameters of the coil in terms of its sectional dimensions. Maxwell calculates that too, though he says it was first worked out by the mighty mathematician Gauss, in 1867; though under what circumstances and for what reason Gauss can have calculated it, we do not know. It will be instructive to some readers if we indicate the manner of calculation, though those who like may skip the algebra, which we may defer for the immediate present. Anyhow, the *result* is clear and definite and simple enough. The width and depth of the channel's cross section must be approximately three-fourteenths of the external diameter of the coil, or three-eighths of the internal diameter, the external diameter being fourteen-eighths or $1\frac{3}{4}$ times the internal. (See Fig. S.) That determines completely the shape of the best coil, whatever its size may be. Every coil that we now proceed to speak of is to be of this shape, they will differ only in size, one will be like another magnified. But the wire which is wound on the coils will not be magnified. If it were, the number of turns would remain the same, and the inductance would increase very slowly in proportion to the additional size. It would, in fact, in that case simply increase with the linear dimensions, or,

what amounts to the same thing, it would be proportional to the length of wire used.

“But if the wire is maintained at a constant thickness, no matter what the size of bobbin on which it is wound, the inductance increases vastly as the dimensions increase. It increases not only because of the greater length of each turn of wire, but also in proportion to the square of the number of turns. If the linear dimensions are doubled, the number of turns are quadrupled, and therefore the length of wire is quadrupled. The inductance depends on the square of the number of turns, and therefore is quadrupled twice over, making it 16-fold, and the linear dimensions being doubled makes it altogether 32-fold. That is to say, increasing the size of the coil, for a given thickness of wire, increases the inductance as the fifth power of the size. In other words, doubling all the linear dimensions multiplies the inductance by 32.

“The formula connecting the three things—outside diameter of coil (D), thickness of covered wire (T), and maximum inductance (L_m)—is as follows:

$$\frac{D^5}{T^4} = 66.6L_m$$

“Here the D , T , and L must all be expressed in the same units, no matter what those units are; and for convenience L should therefore, in such cases, always be expressed as a length, not in such units as henries or fractions thereof, though these are useful for other purposes.

“So also it is best, for radio apparatus, to express capacity as a length, and not in farads or microfarads or micromicrofarads. It is much better to express it in meters, because one usually wants to employ it to calculate the wavelength. The wavelength is 2π times the geo-

metric mean of the inductance-length and the capacity-length, that is, about 6 times the square root of their product. Thus, suppose L is 10 kilometers, and C is 1 meter, the wave length would be 600 meters. If L is 1 kilometer, and C is 10 meters, the wavelength is the same. If L is 16 millihenries, or 16×10^6 centimeters, and C is 100 centimeters, the wavelength will be 240,000 centimeters, or about $2\frac{1}{2}$ kilometers.

"By thus working in length units, the calculation is quite simple, and can be done in one's head; and slips of extensive magnitude can be avoided, because there is a common-sense feeling about the size of the quantities dealt with, all the time, which prevents their being accidentally taken hundreds or thousands of times too big or too small, as may easily happen when hastily dealing with meaningless units of quite unsuitable size. To measure things in farads and henries when we want the dimensions of a coil in inches, or a wavelength in meters, is not practically convenient.

"Any open oscillating circuit transmits its energy to the ether, and so radiates it into space. If a circuit consisted of two capacity areas separated by a long wire or rod, it would be an exceedingly powerful radiator, and would radiate practically all its energy in two or three swings or alternations.

"However, a circuit of this type would be unsuitable for tuning or for any precisely resonant effects. To prolong the oscillations we must introduce electrical inertia in the form of inductance. The electrical oscillations will then alternate back and forth for a much longer time. It will conserve its energy to some extent; in other words, the damping coefficient will be diminished, so that if left to itself it would continue swinging twenty or thirty, or even more, times;

or if connected to a continuous-wave generator it will be kept in vibration with but little applied power when tuned to the right frequency.

"When a current runs through a wire, it inevitably wastes some energy in the form of heat, especially if the wire is of small diameter. Any straight conductors should therefore be fairly large so as not to damp the vibrations out too much. But inductance which must be added to prolong the oscillations, and control the frequency of oscillation, has to be added in the form of a coil. For best operation, the resistance of this coil should be a minimum, and its inductance a maximum. It is obvious that if too great a length of wire is used, the resistance will be unnecessarily high, and the resistance and damping effect more than is needed. The question is whether thin wire will do for the coil, or whether it must be as large in cross-section as the lead-in wires.

"Let us now consider the resistance and inductance of a coil wound in a given channel, or on a specified size of tubing or other frame. The damping depends on the ratio of R to L (i.e., Resistance \div Inductance); and so long as this ratio is constant, the damping will be the same. It does not depend on R alone, nor on L alone, but on the ratio of the two. Suppose we fill the channel with a thick wire, its resistance will be small, but its inductance will be small also. Whereas, if we wind it with wire of small diameter, we shall have a large number of turns; so that the resistance will be high, but the inductance will also be high, and we must, therefore, consider whether the ratio remains the same. We shall find that it does, and that whether the coil is wound with a single thick wire, or whether it is wound with thousands of turns of fine wire, the ratio is not altered. For the resistance

will depend on the square of the number of turns, since the length of wire will increase with n , and the cross section of the wire will diminish with n . Therefore, the resistance will depend on n^2 . But the inductance also depends on n^2 . Hence the ratio of R to L remains constant whatever wire is used.

“With extremely thin wires the space is largely occupied with insulation, and there is a tendency for the ratio of R to L to increase somewhat on this account as the thickness of the wire is diminished. But the increase is little, and for practical purposes is unimportant. Consequently, although the lead-in wires should be fairly substantial, or at least not too constricted in diameter, the wire on the coil may be reasonably thin. And any further details about the winding should be dealt with from the point of view of capacity as the resistance may be left to take care of itself.

“The way to keep the capacity in the coil small is to wind it in a single layer, such as a number of turns wound on a cylinder. In that case we have only the capacity of each turn upon those on each side of it, unless the tube on which it is wound is of some conducting material, in which case the wire will form one coat of a cylindrical condenser, and the capacity will be far from insignificant. It is important, therefore, to use good insulating material for the cylinder on which wire is wound.

“Another plan, though more troublesome, is to wind the wire as a thin disc, in a large number of superposed layers of small breadth. By adopting this method of winding, and without using end pieces or metal frames of any kind, we reduce the capacity to a minimum. And we can, if we like, separate the turns, making a sort of basket winding,

or else a spiral with interspaces, such as is often used for a loop antenna. Such methods of winding, however, are far from giving the maximum inductance possible with a given length of wire; so that the resistance may begin to be excessive, since that depends on the total length of wire used.

“If the wire is wound more compactly, say as compactly as possible, by filling a square section channel with layers of wire, one on top of the other, the inductance can be made a maximum by choosing a channel of the right dimensions, in proportion to the diameter of the coil; and the length of wire used will be a minimum, which is advantageous if the capacity effect is not troublesome.

“To calculate the capacity effect of a coil of many cylindrical layers, we can treat each layer as if it were one coat of a cylindrical condenser; and we shall find that we do not have to add these capacities together. The effective capacity of the whole coil will not be more than the capacity of a single layer, because the whole difference of potential between the terminals will not be applied to any one layer, but only a fraction of it. The whole difference of potential exists between the terminals of the coil, that is, between the inner and the outer layers. If there are six layers, only $1/6$ of the difference of potential is applied to each, and to reckon the effective capacity we shall have, therefore, both to multiply and to divide by 6. Hence it is that the number of layers does not matter. All we want to know is the capacity of any one layer.

“Take the axial dimensions of the coil, or what may be called its breath; call that b . And take the radius of the coil, which we may call r . The layer forms a cylinder whose area is the

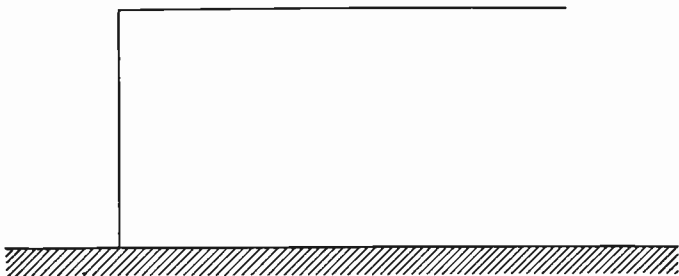

THIS CIRCUIT WOULD RADIATE ITS ENERGY QUICKLY

Figure U: If a circuit consists of two capacity areas such as the antenna and ground arranged as shown, it would radiate practically all its energy in two or three swings or alternations. Such a circuit could not be tuned properly.

circumference multiplied by the breadth; that is,

$$2 \pi r b.$$

“It only remains to reckon the distance which separates one layer from the next, and this will be equal to the thickness of the covered wire minus the thickness of the uncovered wire. For an approximate estimate we can neglect the thickness of the uncovered wire, assuming that it is thin, and take the distance as the diameter of the wire, that is, twice the thickness of the covering.

Treating it in this way, we know that the capacity of a plate condenser is

$$\frac{A}{4 \pi Z}$$

where A is the area of either coating, and z the distance between the coatings. So in the above case this quantity will be

$$\frac{2 \pi r b}{4 \pi T}$$

if T is the thickness of the insulation. We will consider the order of magnitude of this capacity for a given example.

“Let the breadth of the coil be 2 inches, and the mean radius of all the windings

on it be 3 inches, and let the diameter of the covered wire with which it is wound be rather more than $\frac{1}{2}$ millimeter, or say $\frac{1}{40}$ of an inch. The capacity of each layer, with regard to the layers above and below, will then be

$$\frac{r b}{T} = 240 \text{ inches}$$

that is, 20 feet, which is comparable to the capacity of a single-wire antenna 400 feet high!

“The coils we advocate are wound with much thinner wire than that. And if the diameter of the covered wire is .006 of a centimeter, even though the breadth of the channel is only 1 centimeter, yet with the mean radius 3 centimeters, the effective capacity will be

$$\frac{3}{.006}$$

that is, 500 centimeters, or 5 meters, which is still very large—bigger than most amateur antennæ.

“To have that capacity, a single-wire antenna would have to be about 100 meters long! and even a quadruple horizontal antenna with its four wires spaced a yard apart would have to be 40 meters in length.

“But we do not want the capacity of the coil to have any relation to the capacity of the antenna. The coil should be kept in its due insignificance so far as regards capacity. What we want in the coil is inductance. Distributed capacity along the coil only introduces confusion, spoils the sharpness of the tuning, and make precision impossible. It introduces the same kind of confusion as a submarine cable introduces into telephonic speech. The Leyden jar effect of a cable—that is, of a wire conductor separated by an insulator from an outside coating—prevents high-speed transmission and tends to smooth out the signals and make them indefinite.

“This effect in cables can be remedied by the introduction of coils at intervals, showing that coils are not in themselves deleterious. But they should always have as much inductance as possible in proportion to their resistance, so as not to introduce unnecessary damping.”

Prof. Morecroft, of Columbia University, has added a most understandable and helpful treatise to this discussion concerning coils:

“It would seem that such a simple thing as a coil could require but little analysis; that anyone could build a coil which would prove satisfactory when used in a radio circuit. Of course anyone can build a coil which will operate in

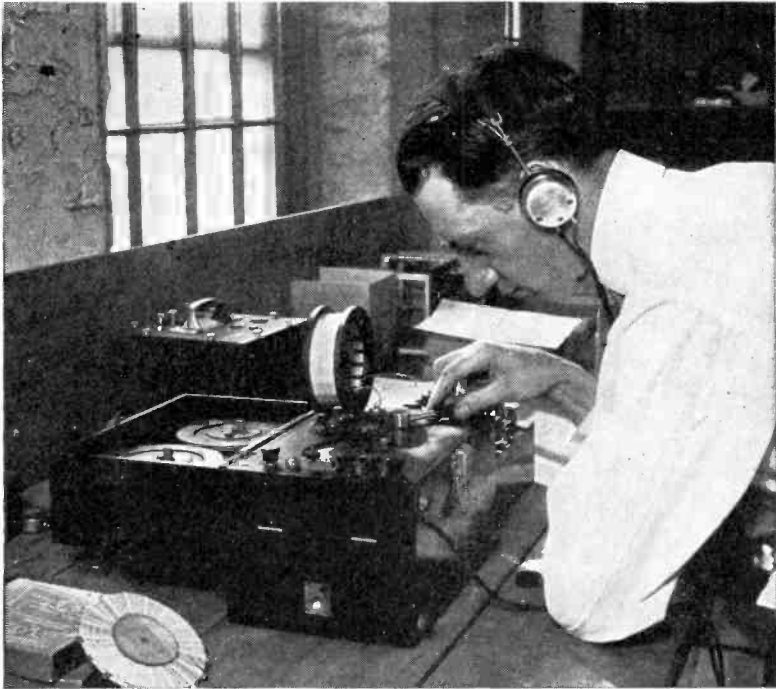

THE DAMPING QUALITIES OF A COIL CAN BE MEASURED

Figure T: In order to determine the damping qualities of any coil it is only necessary to measure its resistance and inductance. Calculation of the damping effect of a coil will indicate how sharply it will tune in a radio circuit.

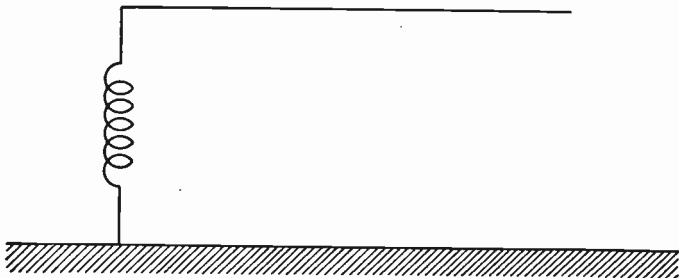

THIS CIRCUIT WOULD TUNE SHARPLY

Figure V: The inductance added to the circuit between the antenna and ground serves as a balance wheel to the electrical oscillations and keeps them swinging much longer than would be the case with the antenna shown on page 204.

a radio circuit; the question is—how good is the coil and how well will it operate compared with the best coil which can be built for the purpose?

“It is the purpose of this contribution to point out some of the factors which determine just how good a coil is and how well it should function.

“There are three so-called electrical constants which enter into all of our calculations in radio work; not only enter into our calculations but which also determine completely how well a set may operate. They are:

- The inductance;
- The capacity;
- The resistance.

“Resonance is, of course, the key-note of operation of all radio circuits; the product of the inductance and capacitance used in the circuit determine at what frequency resonance is obtained. The sharpness of this resonance (that is, the relative ease with which it lets through the desired frequency as compared with others of different frequencies not desired) is determined by the ratio of the resistance of the circuit to its inductance.

“It is evident that the characteristics of a coil, simple thing as it is, are well

worth while studying; this study soon shows that resistance and inductance at radio frequencies are not the simple things taught in elementary physics, but are rather complicated—so much so that theory alone cannot predict what the constants of a coil will be at high frequencies, so that recourse must be had to experimental determination.

“The student of electricity learns that if the voltage (in volts) of a continuous current circuit is divided by the current (in amperes) which flows through a circuit, the quotient will be the resistance of the circuit (in ohms), and that this resistance is constant unless the temperature changes. In an alternating current circuit the same quotient yields the impedance of the circuit, the impedance being made up of two components, resistance and reactance. If the current lags behind the voltage, in phase, the reactance is inductive; if the current leads, it is capacitive. The resistance of the circuit is not the same value at all as would be determined by continuous current test, using Ohm’s law for its calculation; in fact, a circuit which shows millions of ohms resistance to continuous current flow may have only a fraction of one ohm for a high-frequency alternating current.

“As Ohm’s law does not suffice to determine resistance in an alternating current circuit we must get a new definition which does meet the situation. This definition, which is applicable to all circuits for continuous as well as for alternating current (that is, it includes Ohm’s law as a special case) is

$$\text{Resistance} = \frac{\text{Power used in the circuit}}{\text{(current flowing in the circuit)}}$$

“If the power is given in watts, and the current in amperes, the resistance will come out in ohms.

“It might be questioned how this definition can be used in radio circuits—can we use a watt-meter to read the power used? The answer is “no”; the procedure indicated by the definition does determine the resistance but is not generally followed. We could put the circuit in a calorimeter, measuring the rate at which heat is developed, divide the amount of this heat by the square of the measured value of the current flowing, and so determine the resistance; but such a method is not suitable for rapid and accurate determinations.

“It is possible to so adjust the circuit that its reactance is zero, in which case the resistance is given by Ohm’s law.

$$R = E/I$$

“In another method the alternating current Wheatstone bridge is used, by which the resistance and reactance of the coil are both determined at once when the bridge is balanced. The bridge is probably not accurate at more than a few hundred thousand cycles a second so that the resonance method (making the reactance equal to zero) is the only one available.

“If the frequency of the power supply is known (as it will be by wavemeter determination) and the capacity used in

the circuit to establish resonance is accurately known, the inductance of the coil, as well as its resistance, is determined by the resonance test. So with a good wavemeter, and a well built and carefully calibrated condenser, with suitable thermocouples for current measurement, resistance and inductance measurements may be made with a fair degree of accuracy for frequencies as high as ten million or more.

“This contribution gives the results of a few measurements made by the writer in such a fashion; from these results certain conclusions may be drawn which are interesting to the radio enthusiast. By the radio enthusiast is meant the one who is interested in knowing *why* certain things are as they are, not the one who merely boasts that he furnishes the neighborhood with so much noise from his set that the police department have to censor him, or the one who hears so many distant stations that actually do not exist.

“Why should the resistance of a coil be different at radio frequencies than for continuous current?

“There are many things resulting in an increase in resistance for the high frequency alternating current which do not exist at all for continuous current or very low frequency alternating current. For continuous current all of the cross-sectional area of the conductor is useful in carrying current, whereas for high frequency, due to what is called the skin effect, but a small part of the copper may be useful in carrying current. The losses in bits of metal used in the construction of the coil (for terminals, for example) change the effective resistance of the coil, always making it greater than it is for continuous current. The material on which the coil is wound is in a high-frequency electric field, and even though it be a perfect insulator, permit-

ting no current at all to leak from one turn of the coil to the next, it is subject to losses called 'dielectric losses,' or 'dielectric hysteresis.' This loss increases directly in proportion to the frequency and so may give a substantial increase in the effective resistance of the coil at the high frequencies used in radio.

"It might be thought that this change in effective resistance with increase of frequency is not worth bothering about

—perhaps a few per cent. But such is not the case; the resistance for high-frequency alternating current may be many times as much as it is for continuous current. Thus one coil such as might be used in an ordinary receiving set had a continuous current resistance of 0.45 ohms; at 500 meters wavelength it had 3.5 ohms, and at 200 meters it had 18 ohms. In other words, the coil had forty times as much resistance as the

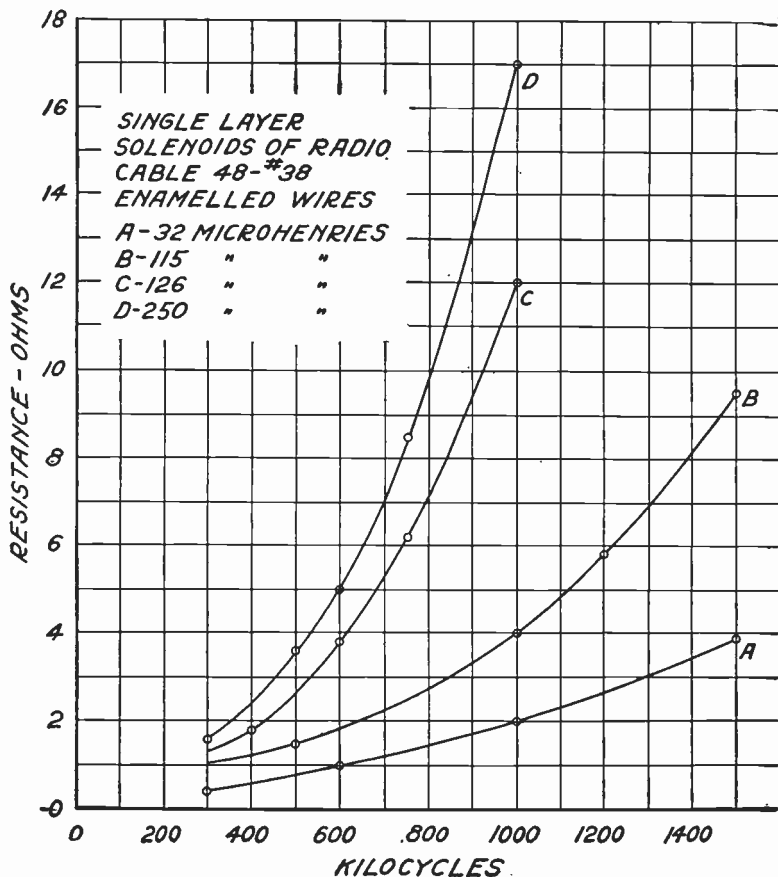

FIGURE W
A resistance-frequency chart of single layer solenoids of different values of inductance.

wire table for resistance of copper wires would predict. This was not a defective coil, but a good single layer solenoid of No. 20 solid copper wire.

"To show how the resistance of coils varies with frequency the curves of Fig. X are given; they are experimentally determined curves for ordinary solenoids such as are used in receiving sets of the better class. The wire of which the coils were made was of radio cable, made of 48 strands of No. 38 enameled copper wires properly bunched together. Up to frequencies above one million cycles a second the cable shows itself superior to solid wire, as the solid wire has not the same cross section as the cable but is of such a size that it winds the same number of turns to the inch. The continuous current resistance of the solid wire was only about one-half as much as that of the cable, showing there was more copper in it than there was in the cable. Above one million cycles, however, the solid wire actually becomes better than the much more expensive cable, or 'litzendraht,' as it is sometimes called.

"The superiority of the solid wire is well shown in Fig. Y, which gives the resistance of solid wire and cable coils of the proper number of turns to make them suitable for short wave sets. It will be seen that at the higher frequencies the solid wire has less resistance than the cable, although at the frequency used in broadcasting (about 833,000 cycles) the cable is considerably the better of the two. As to just where the solid wire becomes better than the cable will depend somewhat upon the form of coil; the conclusions reached from these curves holds only for coils of similar shape and method of winding. It is comforting for the amateur who 'builds his own' to know that the cable, costing about twenty times as much as

the solid wire, and which is also troublesome to tap, is but little better than the cheap, easily worked solid wire.

"For a given type coil, wound of a given kind of wire at a specified frequency, there is one coil which gives a better performance than one with either more or less turns; that coil having the greatest ratio of reactance to resistance will tune best, be most selective; to get this highest ratio a coil with the proper number of turns must be used.

"Using two and three layer banked winding solenoids, made of radio cable (48-38's), the ratio of reactance to resistance was found for various coils as given in Fig. Y. The coils were all of the same diameter (about 4 inches), and the length varied with the number of turns used. These curves indicate that to get the best tuning (greatest selectivity) a proper coil should be used for a certain wavelength. Thus, for tuning to 500 meters we should use coil A in preference to any of the others, but for 800 meters practically all of the coils are equally good. It must be borne in mind that the conclusions drawn from these curves, while in general correct for any form or type of coil, hold specifically true only for coils of this size and wound with the kind of wire used here; also that the losses in the condenser used in conjunction with the coil for tuning must be considered. In general if two coils have the same ratio of reactance to resistance, that with the smaller inductance is preferable, as it will require a greater capacity for tuning and the effective resistance of a variable condenser always decreases with increase of capacity.

"The resistance of the loading coils used in transmitting sets is an extremely important factor in the efficiency of the station. Unfortunately the requirements for tuning, as at present carried out, practically require that a coil of

heavy copper strip be used so that clips can be moved along them for adjusting the wavelength. The resistance of these coils is excessively high at radio frequencies. In one coil of heavy copper strip measured by the writer the resistance at 3000 meters was 350 times as much as its continuous current resistance; at 200 meters it would have been thousands of times as great as one would think, looking at the amount of copper used. In a certain one-kilowatt transmitting station the loading coil got so hot that it was uncomfortable to touch; it seems likely that two or three hundred watts were being used up in this coil, an amount of power which required an investment of perhaps \$200 in tubes to generate. It seems advisable to build the loading coil of heavy radio cable, of the proper number of turns to tune the antenna to a slightly lower wavelength than it is desired to radiate, and bring the circuit up to the desired wavelength by putting a good variable condenser in parallel with the antenna. If the loading coil of your transmitter gets appreciably hot it is a safe guess that the coil has a very high resistance and is inefficient.

"The coefficient of self-induction of a coil may be easily calculated when the dimensions of the coil and number of turns are given. If the coil is measured at, say, 1000 cycles the calculated value of L will be found the same as the measured value, generally closer than 1 per cent. If, however, the coil is measured at radio frequency the inductance may be found either slightly less or considerably more than the measured value. And in the extreme case what is evidently a coil measures up as a condenser!

"The reason that the measured value of L may come out smaller than the calculated value is because of the shift of

the current from a more or less uniform distribution throughout the cross-section of the wire at the low frequency, to a crowding to that side of the wire which is closer to the axis of the coil at radio frequencies. As this shift in the current is equivalent to a decrease in the radius of the coil, of course the measured value of L is smaller than the calculated one, as the formula assumes a uniform distribution of current. If radio cable is used in constructing the coil this effect cannot occur, so the value of L does not show a decrease as the frequency is raised; the effect occurs to the greatest extent in the strip coils used for transmitting loading coils.

"The apparent increase in inductance with increase in frequency exists in all coils, no matter how they may be built, and does result in an increase in the measured value of L at the higher frequencies, no matter with what kind of wire the coil is wound. In the solid wire, or copper strip coil, therefore, we may expect the inductance to decrease slightly at first as the frequency is raised and then to increase, whereas with cable wound coils the measured value of L will show a continual increase in L as the frequency is raised. This increase is due to the distributed capacity of the coil itself. Each part of the coil acts with every other part to form a kind of complicated condenser, so that the coil really should be represented as a coil in parallel with a fixed condenser, the capacity of this condenser being equal to the distributed capacity of the coil. This representation is not complete because actually the capacity of the coil changes with frequency, an effect which is generally neglected in treating the theory of coils.

"The effect of this distributed capacity is, in general, not detrimental, but may be so if the capacity is comparable to

that used with the coil for tuning purposes. In this case, as the capacity of the external condenser is only a part of the total effective capacity in the circuit, variation of its value does not accomplish tuning as sharply as if there were no capacity of the coil affecting the circuit.

“It might seem that distributed capacity in a coil is not objectionable, as we have to have a condenser connected to the coil anyway—for tuning pur-

poses. But such is not the case. It is best to keep this capacity as small as possible because the dielectric used in that capacity is poor compared to the dielectric used in the external condenser. The distributed capacity of the coil has cotton, paper, shellac, or enamel, for its dielectric, whereas the regulation tuning condenser is a very well built air condenser, and air is far superior to any other substance as a dielectric; it has no losses at all.

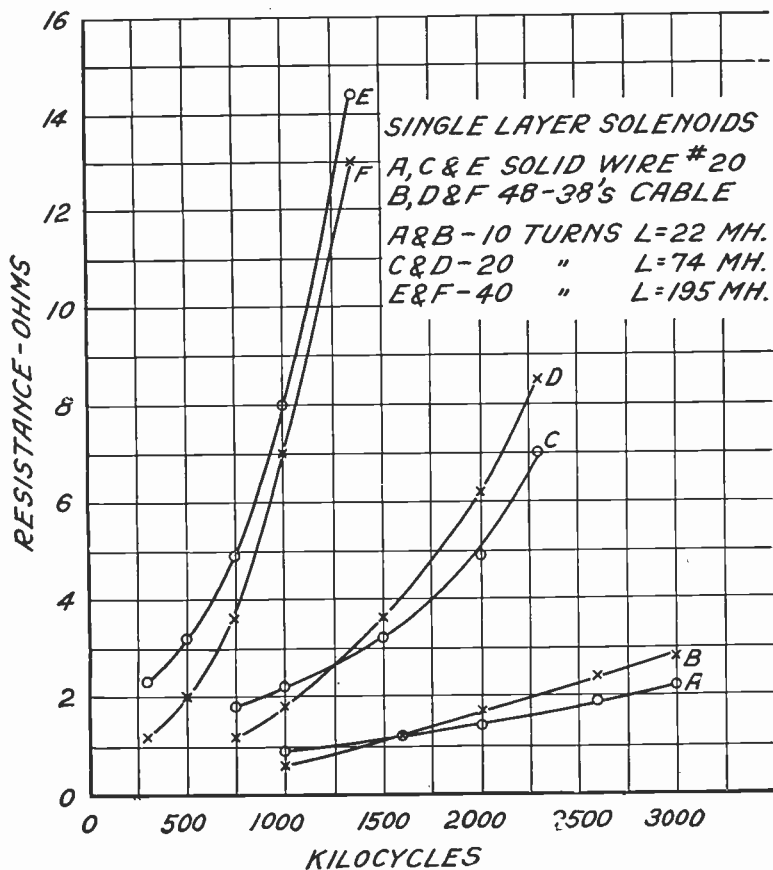

FIGURE X
 Another resistance-frequency curve for coils wound with No. 20 wire.

"The various turns and layers of a coil should be kept reasonably far apart if the distributed capacity is to be kept low, and the dielectric between layers and turns should be air, if possible. Several years ago the writer showed how such a construction could be carried out without too much difficulty. Using air for the dielectric between layers has the double advantage of low specific inductive capacity and also prevents leakage of current in passing from one layer of the coil to another.

"Many times a solenoid is furnished with many taps and a multipoint switch for tuning purposes; although this is a convenience it does not give as good results as a single coil of the proper number of turns. This is especially true if but a small fraction of the coil is to be used, say a quarter or less. In such

cases the coil acts as an auto-transformer, the used portion having comparatively high voltages induced in it and thus producing large unnecessary copper and dielectric losses in the unused portions. Also it is evident that the switch points mounted in the panel of bakelite or similar material constitute a condenser in parallel with the tuning condenser; in this connection it should be borne in mind that losses in the bakelite, or leakage across from one point to another, is, of course, just as detrimental as leakage in the coil itself.

"To prevent the losses in the unused portion of the coil it is best to build the coil in sections, an inch or more apart; many times it will be found advantageous to short-circuit that part of the coil which is not being used. This is especially true when but a small part of the

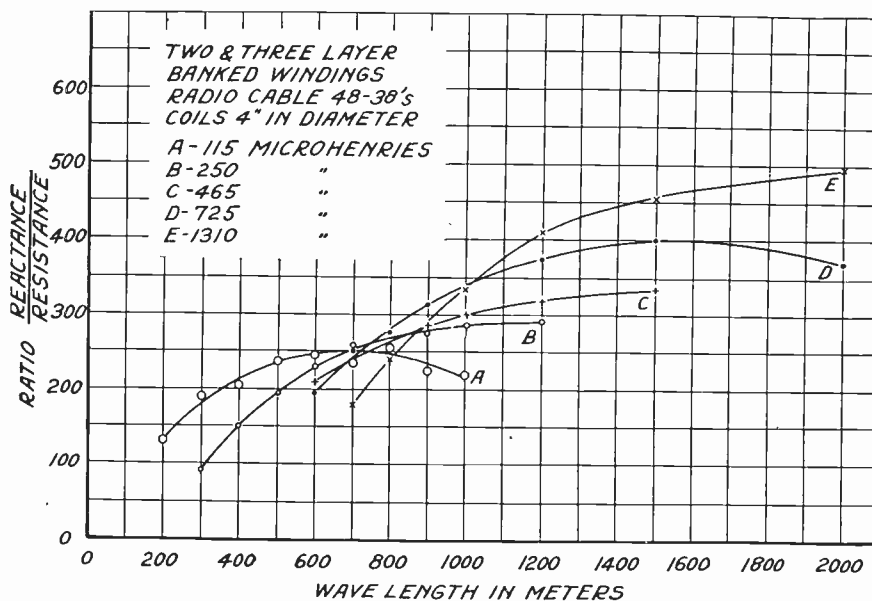

FIGURE Y

This chart shows the ratio of reactance to resistance for two and three layer bank-wound coils at different wavelengths.

coil is being used. Although there will be eddy current losses in the short-circuited part of the coil these losses may be less than if the coil were not shorted. There will be practically no dielectric losses in the unused parts of the coil, because the voltage in these parts will be low; and furthermore it is quite possible that there will be less current in the unused part than if it were not shorted,

strange as this may sound. If there are several sections in the unused portion of the coil it will not be necessary to short all of the unused part; shorting the section directly next to that part of the coil which is being used is, in practically all cases, almost as satisfactory and as a matter of fact it is in general easier to accomplish. These rules of practice may be very easily followed."

APPENDIX

A PLEA FOR EASY SPECIFICATION

By Sir Oliver Lodge

When working with ordinary coils and condensers in the laboratory, the specification of capacity in microfarads is convenient enough, and so is the specification of inductance in terms of henries or secohms. But when working in radio wavelengths, it is convenient to have the antenna capacity, and the inductances associated with it, expressed in terms of length because the geometric mean of those two lengths—that is, the square root of their product—gives the wavelength direct when multiplied by 2π , that is practically for rough estimate, by 6. Six times the square root of the inductance and capacity multiplied together is a close approximation to the wavelength; and in predetermining the inductance required for any given case this must surely be a handy rule.

Capacity in electrostatic measure is a length, and inductance in electromagnetic measure is also a length. The truth is that in all units—that is to say, in absolute measure—capacity is really K times a length, while inductance is μ times a length. And it is natural to express the one in static measure, under the convention that $K = 1$, and the other in kinetic—that is, magnetic—measure, with the totally different convention that $\mu = 1$. For the one has to do with charge, and the other with current.

The capacity of an ordinary amateur antenna is some simple fraction of its height or linear dimensions: about one-twentieth of the length of an isolated thin single wire measures its capacity. But the fraction may vary for different antennas from a twentieth to about a twelfth, as will be shown later. A microfarad is far too big a unit for convenience. A millimicrofarad, or even a micromicrofarad, has to be employed, and they are by no means convenient. The length corresponding to a microfarad is 9 kilometers. So a millimicrofarad is 9 meters, and a micromicrofarad is nine-tenths of a centimeter; that is to say, 10 micromicrofarads equals 9 centimeters. So that for a rough estimate, it may be taken as a centimeter, though it is a trifle smaller.

On the other hand, a henry is 10,000 kilometers. So

a millimicrohenry—or what is sometimes called a billihenry—is exactly 1 centimeter. While a microhenry is 10 meters, and a millihenry 10 kilometers.

Conversion from one set of units to another is always a nuisance. But after all a henry and its sub-multiples have no particular meaning which the imagination can seize hold of; whereas the length of a meter or a kilometer is easily imagined. Hence it might be well to have the coils used in radio thus marked—that is, marked in terms of length—using any unit of length that is handy for the purpose and suitable to the coil. Thus, take an antenna with a capacity of 1 meter, and put a coil of 10,000 meters inductance in series with it. The geometric mean of the two is 100 meters, and the wavelength, therefore, 600 meters.

The meter as a rule is the most convenient unit of length under the circumstances, since wavelengths are commonly so specified. But some people prefer to work in centimeters; and it is easy enough to remember that a billihenry is 1 centimeter. The farad is not a convenient unit. It was always much too big; but it can be remembered that a microfarad is equivalent to a length of 9 kilometers. In radio work, however, it is certainly more convenient to express capacity as a length, whether it be agreed to specify inductance also in that way, or not.

It is curious to note that a farad coupled to a henry would have a slow oscillation period of six seconds; and so give a quite inappreciable wave, 1,800,000 kilometers long. A microfarad connected to a henry of inductance would oscillate a thousand times in six seconds, and so generate a wave 1,800 kilometers long. Whereas a microfarad coupled to a microhenry would have a frequency a thousand times as great, and so might give a strong wave 1,800 meters in length; the same wave being also generated by a millimicrofarad coupled to a millihenry; which may be expressed as a 9-meter capacity and a 10,000-meter inductance.

The intensity of radiation increases very fast as the wave is shortened.

SECTION XI

The Improvement of Broadcast Reception

THE elimination of disturbing noises requires something more than intelligent manipulation of the tuning knobs. The interference may be of a dozen different kinds and it may have a dozen different sources and it is only by treating the subject in its entirety that we can hope to meet all of the problems that arise in this particular and very important phase of the radiophone art.

John V. L. Hogan, who is one of the greatest authorities on the design of radio receivers in the United States, contributes the following matter to the course and the student may read and absorb it knowing that no more thorough or accurate contribution has been made to this kind of popular radio literature.

There is really just one big problem facing those who listen to broadcast radio-telephone transmission—the attainment of perfect reception.

Already the technique of radio-receiver construction has progressed to the point that even the *average* set gives a reproduction of speech and music that compares favorably with the results obtained from the average phonograph. But there is no reason why even such progress should satisfy us, for the time is coming when radio reproduction will be much better than any phonograph can give.

Suppose we begin, then, by finding out what it is that is responsible for imperfect broadcast reception.

We may divide up the defects or difficulties into three main groups, *i.e.*, the effects that occur in the transmitting station, those that take place as the waves flash through space, and those that happen at the receiver.

We propose to go into more detail as to the matters concerned in receiving-apparatus design and use than as to the first and second classifications, for two reasons; in the first place, the receiver is in your own hands and you yourself can improve its operation; and in the second place, there is more room for improvement in the receiving system (as a general rule) than anywhere else. Nevertheless, we should understand something of the transmitting-station and wave-movement difficulties if we are to appraise properly the performance of our receivers.

Consider the transmitter for a moment. Here we must first produce a perfectly uniform and unvarying stream of radio waves of a single definite frequency. If the wave frequency varies during transmission the signals will appear to fade away and grow stronger again as the radio wave departs from and returns to the frequency that the



AN OLD-TIME "BROADCASTING STATION"

Figure A: The improvement made in radio transmission and reception since the days of the old "transmitting amateur" has been one of the outstanding accomplishments of the past three years. Until the advent of the present-day broadcasting station, amateur spark stations similar to the one pictured above and naval and commercial telegraph stations were the only transmitters that the radio fans could listen to.

listening receiving sets are adjusted to intercept. If the transmitted wave frequency remains constant during any one program, but varies from night to night or day to day, this sort of artificial "fading" will not be noticed, but signals from the station will be located at different receiving tuner settings at different times. Of course, such a variation in the wave frequency makes it difficult to receive from the station in question.

Keeping the transmitted wave steady is simply a matter of arranging the generating apparatus at the broadcasting station so that it will produce oscillations of uniform frequency, since the wave frequency must always be the same as that of the alternating currents that produce the waves. Fortunately

the job of maintaining constant frequency of oscillations is no longer very difficult; most broadcast transmitters do very well on this score.

The fluctuations in wave frequency that cause apparent fading of signals are, of course, slow. It may require several minutes for the wave to change to a value only a few percent from its initial frequency. What would happen, then, if the variations in wave frequency occurred more rapidly? There are several general effects, and how much of each will be observed depends upon the rapidity and extent of the fluctuation. If the wave varies from its average value ten times a second, we would expect to hear a fluttering sound when listening to the station. The loudness

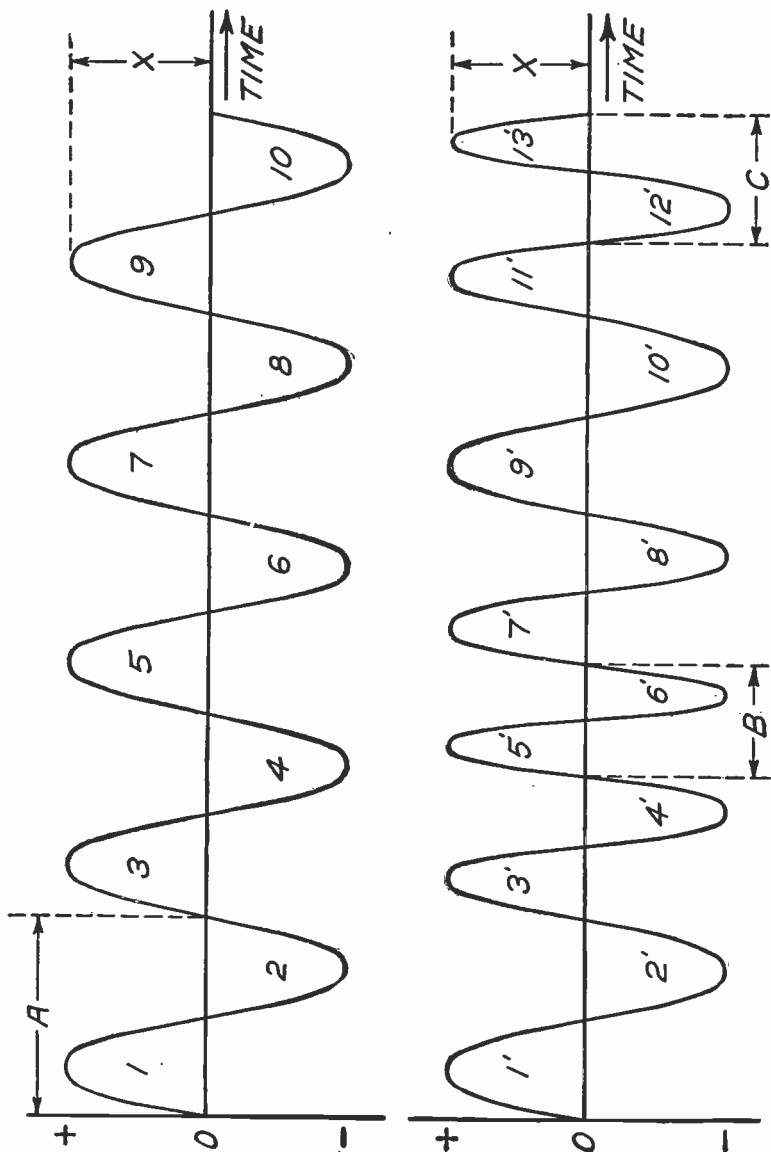

BROAD TUNING IS CAUSED BY CHANGES IN FREQUENCY

Figure B: The upper curve represents a perfect carrier wave. The lower curve shows how rapid changes in wave frequency spoil its uniformity and make close tuning impossible. Slow changes cause signal fading and the speeds in between make a warbling note in the receiver.

of the flutter would increase as the amount of wave-frequency change increased. If the rate of fluctuation were increased to twenty or thirty times a second the flutter would be changed to a low-pitched rumbling tone. Still more rapid fluctuations would result in higher-pitched musical tones in our receivers. All these noises, you should bear in mind, would be heard while listening to the unmodulated and supposedly quiet "carrier wave" of the transmitter in question. Further, they would be produced by the mere changes in wave frequency even though the amplitude or intensity of the emitted wave were absolutely uniform.

Now, let us suppose that the rate of frequency variation in the carrier wave is reduced to three or four times a second, and that the changes in value are not abrupt. The alterations in the carrier wave would not then produce a noise in the listening receiver, but we should be able to notice an effect that is quite different, namely, an apparent "broadness of tuning." It is not hard to see that, if instead of sending out a uniform carrier wave of 833,000 cycles a second frequency (corresponding to 360 meters wavelength), some particular station radiates at a frequency which slides up and down between 836,000 and 830,000 cycles, we cannot tune our receivers sharply to it at any single value between those limits.

Such fluctuations in carrier-wave frequency are undoubtedly responsible for some of the cases of broadness of tuning of broadcast transmitters that have been reported, and, even today, probably account for part of the poor quality of speech and tone consistently observed in listening to some broadcasters. Thus a loss of quality, or of fidelity in tone reproduction, that is generally blamed upon "poor modulation,"

may actually be caused by a very different thing. If you notice cases of wave-frequency fluctuation you can do a favor both to the broadcaster and to the radio listeners by writing to the station and telling its management in detail about your observations.

There is still another trouble that may be caused by the sending out of an incorrect wave frequency. Broadcasting stations are now licensed to radiate standard waves that have been chosen just 10,000 cycles apart in frequency. Waves so separated will not directly interfere with each other. But if, for example, station WRC in Washington, which broadcasts at 640,000 cycles (469 meters) were accidentally to increase its carrier frequency to 644,000 cycles, and if station WCAE in Pittsburg were to reduce its frequency from the assigned value of 650,000 cycles to a new figure of 646,000 cycles, the two station waves would obviously be only 2,000 cycles apart. With such small difference in frequency any two radio waves would directly interfere with each other. By the well-known beating or heterodyne action they would produce a whistling tone of 2,000 cycles pitch, about equal to that of the third C above middle C on the piano, in every radio receiver that was so tuned and so located as to receive both waves.

This whistling note might be only a faint sound in the background, if one of the two interfering stations were relatively far away, or it might be so loud as to ruin reception of either or both programs. This latter would be the case when the two stations were about equally distant from, or were received at about the same intensity on, the observing receiver.

There is no reason other than accident or carelessness for the occurrence of any such whistles caused by beating

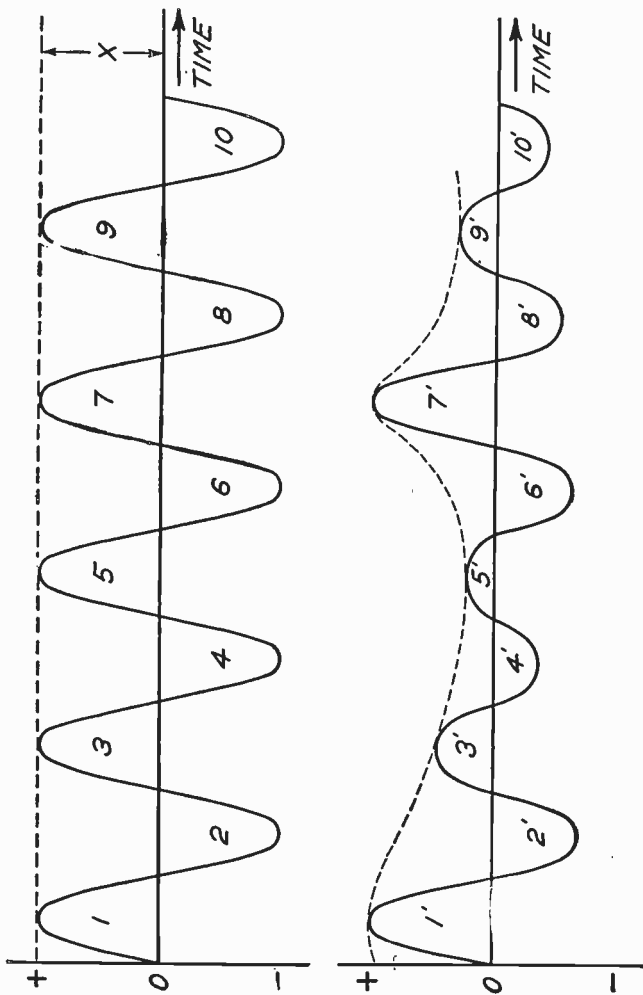

NOISY RECEPTION IS CAUSED BY CHANGES IN INTENSITY

Figure C: The upper curve represents a perfect carrier wave. The lower curve shows how variations in the power supply affect the carrier wave. Generator hum or steady sizzling and frying noises—which you hear between features on the program—are nearly all due to changes in the strength of the carrier wave.

between the waves of broadcast stations in the United States, with the single exception of the "Class C" group that is licensed to use only 833,000-cycle waves (360 meters) Any two Class C stations are likely to interfere directly with each other, and the interference may be, and often is, so severe as to ruin their programs. If you like to listen to some particular Class C station and you find that it is continually being spoiled by a more or less steady whistling note, you should tell that fact to its management and urge them to ask for reassignment to a Class A or Class B wave frequency that will not be so disturbed.

The great majority of high-grade broadcasting stations (and particularly those in Class B) have little or no difficulty with variations in their carrier-wave frequency. If we listen to such a station as heard in an oscillating receiver so that a beat note may be produced by the heterodyne interaction of the local oscillations and the carrier, we find that the beat tone is pure and constant in pitch. This means that the simple, unmodulated wave coming from that particular transmitter is uniform as to frequency and, consequently, that it is the ideal wave for bringing us radio-telephonic speech and music of high quality. If it is not so nearly perfect it will not serve so satisfactorily as a radio carrier wave.

Leaving the matter of frequency fluctuations, let us consider another possible defect in the radio wave as it is transmitted by a broadcasting station. This is a slow or rapid variation in the intensity of the carrier wave, which may occur even though the transmitter operates at a perfectly uniform frequency. The effects produced at a listening receiver by variations in the intensity or amplitude of the transmitted wave are in some ways like those caused by

changes in frequency, which have just been discussed.

For instance, if the wave intensity varies slowly, and by a considerable amount, it may produce at the receiver a corresponding variation in signal strength. If the intensity of the wave fluctuates rapidly, at a rate within the range of audible frequencies, it will make sounds in any ordinary listening apparatus and will be what is called a "noisy carrier wave." Such noises will, of course, be an obstacle to perfect reception of broadcast programs, and, at the transmitting station, they must be reduced to the practical minimum.

There are still other characteristics of the waves sent out by broadcast transmitters that may cause trouble in reception. One of these is the radiation of waves at more than one frequency, *i.e.*, at certain definite frequencies other than the single one that is authorized for the particular station. It is not uncommon for a transmitter to send out "second harmonic" waves at twice its normal frequency, and sometimes other waves go out at other and higher multiple or harmonic frequencies. As a rule this harmonic radiation is a good deal weaker than the main or fundamental wave, and consequently it does not carry so far. However, wherever it is heard, the program of the sending station will be received on the higher wave frequency, and this may cause substantial interference.

For example, let us imagine that the Memphis station, which uses a main wave of 600,000 cycles frequency or 500 meters length, were to radiate a strong second harmonic wave. This would necessarily be at 1,200,000 cycles (double the fundamental frequency), which corresponds to 250 meters wavelength. Such harmonic radiation would severely interfere with reception from

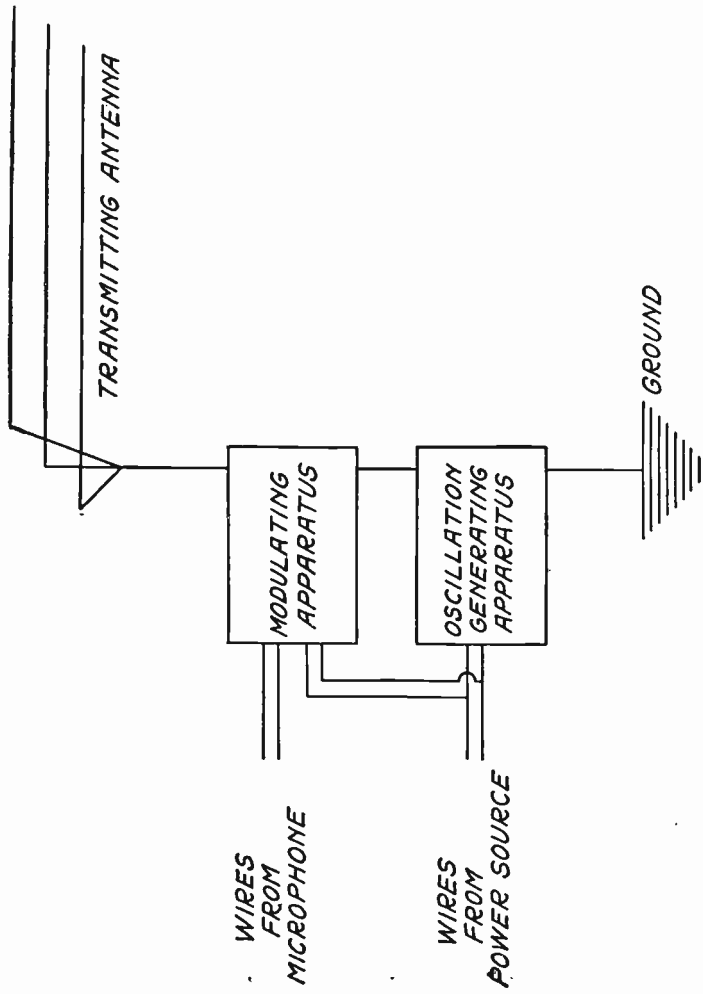

WHERE THE TRANSMITTING TROUBLES ORIGINATE

Figure D: Changes in frequency are due to the swinging of the antenna or local conditions within the transmitter. Uneven power supply or bad modulating apparatus cause a noisy carrier wave.

Class A stations using this 1,200,000 cycle frequency as their fundamental wave, as can easily be seen.

The extra radiation may not be at harmonic intervals, *i.e.*, at double, triple or quadruple frequencies, as in the above instances. Cases have been observed where a single station sent out several waves at relatively closely adjacent frequencies, and, consequently, set up strong interference that disturbed reception from a number of other broadcasting plants.

Generally speaking, there are four kinds of interfering noises that may come in with the radio waves you desire to receive.

The *first* of these is caused by variations in the carrier wave from the station to which you are listening, and we have already looked into the matter of frequency and intensity variations in these carrier waves.

The *second* kind of interfering noise is that caused by radio waves other than the one to which you are listening; interference of this kind may produce several quite different effects in your receiver.

The *third* kind of interference is that arising from natural or atmospheric electrical discharges, and is what we ordinarily call "static" or "strays."

The *fourth* type of noise is produced by electric power or signalling lines or the apparatus connected to them, and is usually called induction.

Let us go back for a moment to the first type of interference.

Noises caused by frequency fluctuations in the carrier wave being received have been fairly well covered. We have also studied the matter of intensity variations to some extent, and we have pointed out that an uneven power supply at the transmitting station, or the use of bad modulating apparatus, would cause a noisy carrier wave. Before

leaving the topic of "noisy carriers," as they are often called, it will be worth while to consider in a little more detail several of the ways in which they are set up. The ideal carrier wave for any radio telephone station would of course be absolutely uniform as to frequency and intensity. When no voice or musical signal is being sent out, the wave should not vary in any way. Such a uniform carrier wave, when received upon a non-oscillating receiving set, would produce no sound whatever in the telephones or loudspeaker. Consequently, when either music or speech was impressed upon this silent carrier wave it would be conveyed to the receiving station and there reproduced without any disturbing sound caused by wave fluctuations.

Now let us suppose that the transmitter which we are considering has a perfect carrier wave, within practical limits. That is to say, let us imagine that when we tune to the wave from this station we hear nothing except the telephonic voice or music. This will imply that the transmitter has a well-designed power source, so that no noises will arise from its irregularities. It also means that the modulating apparatus introduces no undesirable interference. If the modulator, in addition to quiet operation, has the ability to impress upon the carrier wave faithfully-copied variations corresponding almost exactly with the sound variations that strike the pick-up microphone, we have every reason to expect high grade transmission from the station.

But it often happens that a broadcasting transmitter has a carrier wave that is normally silent and free from frequency changes, together with a modulating system that is capable of high-quality tone production, yet that when we listen on some particular occasions

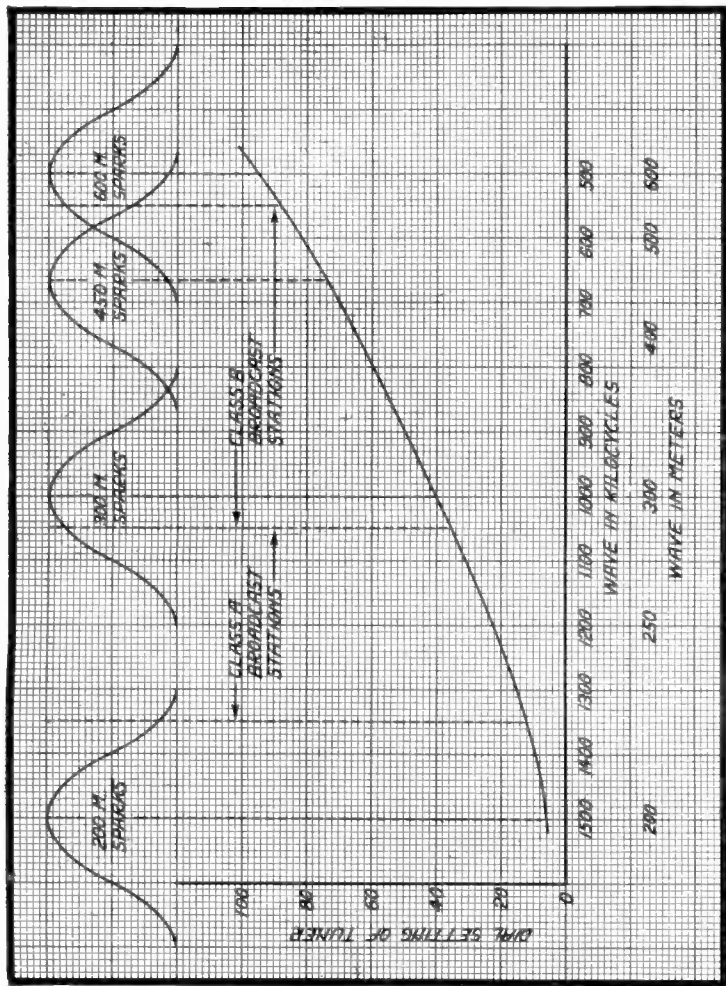

HOW THE SPARK SETS MAKE TROUBLE

Figure E: The curves at the top of the figure show how signals from spark transmitters of commercial radiotelegraph stations spread out over the broadcast wavebands. The reason for changing the spark-set wavebands is apparent from this illustration.

the signals are accompanied by noises and are not clearly reproduced by our receivers.

When this happens, many listeners are apt to say that the trouble is caused by "bad modulation."

As a matter of fact, the modulating operation of the radio transmitter may be perfect and the troubles may occur far away from the modulation apparatus of the broadcasting station. It is much more common, in well-planned broadcasting stations, for noises and distortion of this kind to develop in the pick-up microphone (and its amplifier and connecting line systems) than in the modulating apparatus itself.

If you know what to look for, it is not hard for you to pick out cases where noisy carrier waves are produced by the effects of the pick-up line that connects the microphone with the radio generating portion of the broadcast transmitter. Usually the short pick-up line that runs from oscillation generator and modulator equipment to a nearby studio is quite free from such influences, and thus when the station is broadcasting events from its studio there may be none of the interfering noise heard by radio listeners.

On the other hand, it is quite common for the longer pick-up lines that are used in transmitting "out-of-studio" programs (such as park concerts, sports, and so forth) to bring various kinds of noises into the radio sending apparatus. If the carrier wave, as heard between the announcements or the numbers of the program, is silent when transmission from the studio is going on, but noisy when outside events are being broadcast, you may be sure that the noise is a wave-intensity variation introduced by disturbances affecting the long pick-up lines.

Sometimes the sources of these noises

may be identified by listening closely; electric motors, stock tickers and telephone ringers all have characteristic sounds. Any of them may induce disturbing currents (in a microphone pick-up line) which, when conveyed to the modulating apparatus, will be impressed upon the outgoing radio waves and thus carried to your loudspeaker.

In the same way you may note variations in the quality of reproduction when listening to different program items that are broadcast from some particular station. If the speech is clear and distinct when the speaker is at the studio, but muffled and hard to understand when he is talking over a long pick-up line, you may be sure that the faulty transmission is not caused by "poor modulation" but by poor transmission to the modulating apparatus. The defects introduced by poor pick-up lines, which often will convey telephone currents of some frequencies far better or far worse than a good average value, are particularly noticeable in musical transmission. Often a poorly adjusted pick-up line so distorts the currents that the tones of individual musical instruments cannot be identified with certainty.

¶When you notice noisy carrier waves or distorted transmissions of the kinds we have just described, you will be doing a great favor to broadcast listeners generally if you will write to the management of the offending broadcasting station and tell them what you have observed.

But when you write, don't say that the trouble is caused by "bad modulation" if in fact the modulator is doing its best and the noise is introduced by the pick-up lines!

Next let us take up the second general type of interfering noises that come in with the waves.

This second type is radio wave interference. To make improvements in your

reception when it is disturbed by radio interference is not, as a rule, a matter of writing letters to the interfering stations. In the vast majority of cases the trouble can be completely remedied, or at any rate greatly reduced, by modification or careful adjustment of your receiver.

Radio wave interference is probably the greatest single cause of imperfect broadcast reception. It is, of course, true that there are many defective radio receivers in use, and that these sets reproduce noisily or with distortion, but so far as I can determine the great majority of receiving sets function correctly within the limits set by their design. We must now assume that your receiver is working as well as it can, and, in treating "outside" causes of receiving difficulties, limit ourselves to effects that occur in spite of a more or less approximate perfection in the individual parts and the assembly of the receiving set. If your set is not working well, and if you can locate the trouble within its circuits, you should repair it before giving any time to the matter of outside interference.

There are three main varieties of radio wave interference, and these have come to be known as "sparks," "whistles" and "cross-talk."

The division called "spark interference" should really include all types of telegraphic code disturbance, even though the interfering radio-telegraphic station is not of the spark type. Practically all interference of the code classification, however, comes from the old-fashioned spark transmitters that are still in use in so many radio-telegraph stations, and so all of it is generally blamed on sparks.

Interference from code transmitters is growing less as time goes on, because more and more spark sending stations are being re-equipped with modern

transmitters that cause less disturbance. Further, there is in formulation a plan to reduce the trouble from the spark transmitters still remaining in service, by transferring their operations to wave-frequencies farther removed from the broadcasting range. Assistance along these lines will assuredly be welcomed by broadcast listeners everywhere, but as great progress in either direction will necessarily take some time it seems well worth while to see what can be done to make receiving sets themselves less susceptible to spark interference.

Let us see, then, just what the spark interference problem amounts to.

Suppose that you are listening to a broadcasting station of which the wave frequency is 610,000 cycles a second, corresponding to a wavelength of 492 meters.

Your receiver may be sufficiently well tuned to prevent your hearing any other broadcasting stations, but still the broadcast program may suddenly be interrupted by loud dots and dashes that come in from some unknown radio telegraph transmitter. Whether or not you are disturbed by such code interference will depend mainly upon four factors. The first of these is the difference between the frequencies of the desired wave and the interfering wave. The second is the width of wave-frequency band occupied by the interfering wave. The third is the excluding power (or sharpness of tuning) of your receiver; and the fourth is the intensity of the interfering signal compared to the broadcast signal you desire to receive.

We should examine these four factors separately if we are to understand the situation, and if we do not understand the problem we are trying to solve there will be only an exceedingly remote chance of our making any progress. From some viewpoints it is one of the

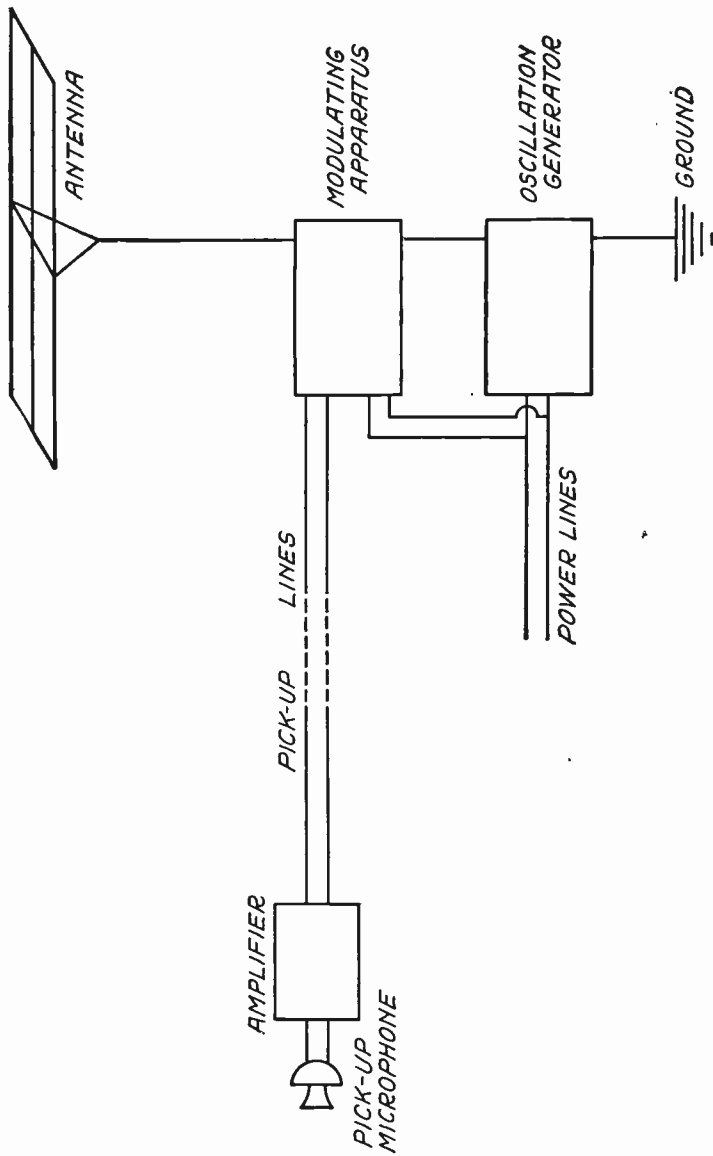

THE MODULATOR IS BLAMED FOR MOST FUZZY NOISES

Figure F: In reality the pick-up microphone, the amplifier and the pick-up lines shown in the diagram above are the sources from which many stray noises come to your loudspeaker.

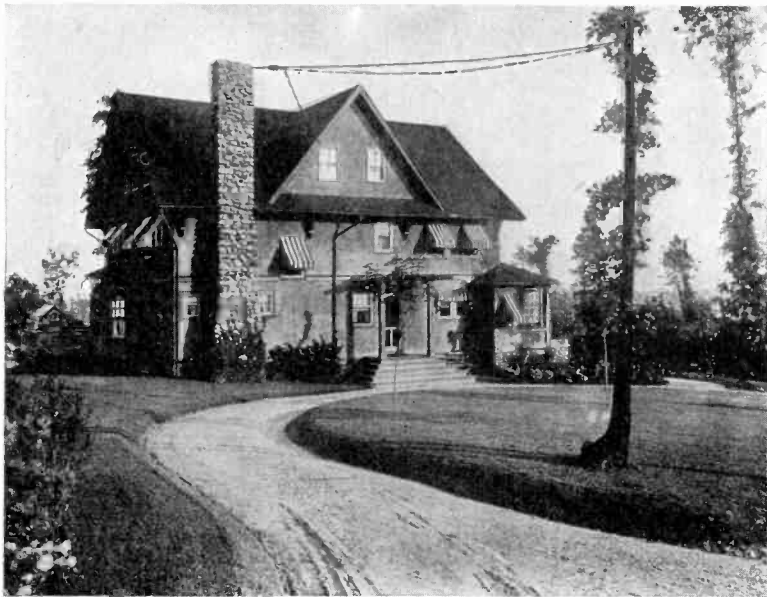

A SWINGING ANTENNA LIKE THIS CHANGES THE TUNING

Figure G: Antennas rock when the bough bends or the tree sways in the wind. If the wind blows the tree toward the house, the antenna sags down to the position shown in the dotted line. This changes the capacity of the antenna and is often the cause of fading signals.

misfortunes of present-day radio that the practical development of broadcasting has come so rapidly, for the demand for apparatus and services of all kinds has been too great and too sudden to permit sound engineering to be the rule rather than the exception.

Considering, then, the effect of frequency difference upon interference, it is not hard to see that with other conditions remaining unchanged we will have least trouble from interfering waves that are widely different in frequency from the wave we desire to receive. This is simply because any receiving set that has any pretensions to selective ability, or the power to respond well to signals of some particular (tuned) frequency while excluding signals of other (untuned) frequencies, will discriminate to

the greatest extent between waves of widely different frequency values.

What differences in wave frequency may we expect under today's conditions of broadcasting and marine radio-telegraph signalling?

The best and most concise answer to that question may be had from a tabulation of the various values of wave frequency in use, as shown below:

It is quite evident that amateur spark transmitters that use waves at or near the frequency of 1,500 kilocycles (1,500 thousand cycles or 1,500,000 cycles) will be likely to interfere with reception from broadcast stations that use the higher frequencies in class A, and that marine spark transmitters will often cause trouble in receiving from class B stations near the frequencies of 1,000 kc,

466 kc and 500 kc. There is little message traffic handled by ships at the high-frequency wave of 1,000 kc, and the Department of Commerce has assigned no broadcasting wave nearer to it than that of WSAI (Cincinnati) at 970 kc; consequently the 1,000 kc ship wave does not greatly trouble broadcast listeners. The 666 kc wave has been extremely bothersome, as it comes right in the middle of the broadcasting range:

666 Ship Interference
 670 WMAQ (Chicago)
 680 WOS (Jefferson City)
 690 NAA (Radio, Va.)

Regulations have been put into effect by the Department of Commerce, however, which have had the effect of greatly reducing the marine traffic transmitted at 666 kc, and this has been of great help to broadcasting. The most important marine traffic wave, of 500 kc, is still largely used by spark transmitters and still causes much interference for listeners who are receiving from KSD (St. Louis, 550 kc), KYW (Chicago, 560 kc), WNYC and WOAW (New York and Omaha, 570 kc), and some others which use the lower-frequency waves.

When you experience spark interference with your broadcasting reception, it is a good plan to tune your receiver to the interfering station for a moment. If your set is of one of the types in which the scale readings are more or less proportionate to the wavelength to which it is tuned, you can get a very fair idea of the wave frequency of the station causing the trouble. For instance, if WNYC comes in at 80 on your tuning dial and the code interference becomes louder as the dial reading is increased to 95, for example, it is evident that the interfering wave is in the neighborhood of 500 kc. If the interference is loudest near the tuning point for WJZ or WCAE, the bothersome station is probably using the 666 kc wave. If the interference is far down the scale it may come from 1,000 kc ships or 1,500 kc amateur transmitters. The radio-telegraph transmitters occasionally send out incorrectly adjusted waves (and both commercial and amateur stations sometimes offend in this respect); a little experience in observing interference as suggested above will aid you to determine this fact, and

Frequency Cycles	Wave-length Meters	Service
1,500,000	200	Amateur Radio-telegraph Transmitters
1,350,000 to 1,050,000	222 to 286	Class A Broadcasting Stations
1,040,000 to 1,000,000	288 to 300	Class B Broadcasting Stations
1,000,000	300	Marine Radio-telegraph Transmitters
1,000,000 to 670,000	300 to 448	Class B Broadcasting Stations
666,000	450	Marine Radio-telegraph Transmitters
660,000 to 550,000	455 to 546	Class B Broadcasting Stations
500,000	600	Marine Radio-telegraph Transmitters

640 kc KFI, WCAP and WRC (Los Angeles and Washington)
 650 WCAE (Pittsburgh)
 660 KDZE and WJZ (Seattle and New York)

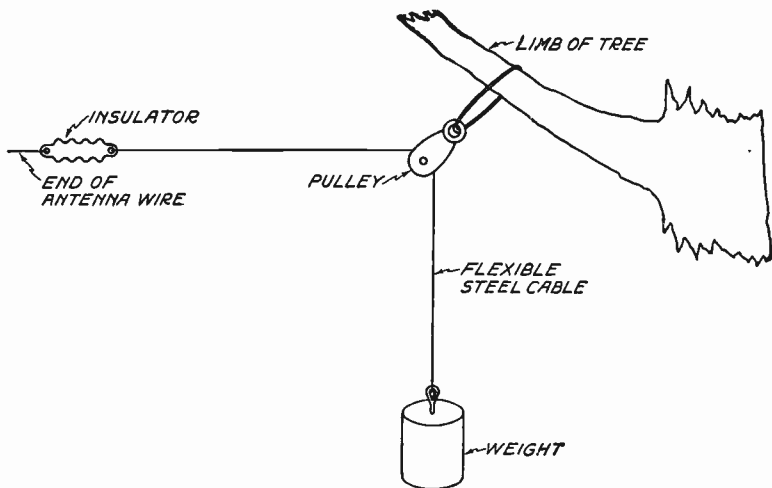

THE RIGHT WAY TO FASTEN AN ANTENNA TO A TALL TREE

Figure H: By using a pulley and weight fastened to the end of the antenna (as shown above) you can get rid of the trouble caused by the swaying of the tree in the wind. The weight takes up any slack in the wire and keeps the antenna always at the same tension and consequently always at the same distance from the ground.

you may be able to do some good by reporting your test to the Radio Supervisor in your particular district.

An odd thing about the transmitter defects is that their effects upon the receiver are in a number of respects like those of certain defects which may exist in the receiving set itself.

Where the difficulty in reception is caused by something that has gone wrong at the transmitting station, you have, of course, no direct cure available to you. You may write to the broadcasting station explaining the trouble and your observations upon it; and you should do that in every instance, for you will thus be helping not only yourself but thousands of other listeners. On the other hand, if the defective operation is to be blamed upon your own receiving apparatus, you have the opportunity of remedying it right before you.

All you need is a little information as to what produces these possible troubles in radio receivers, and a few suggestions as to how they may be eliminated.

It is probably worth while, therefore, to interrupt our discussion of transmitter troubles at this point so that we may consider for a moment some of the things that can happen at a receiving station and which will produce similar effects.

Unless you are able to determine definitely whether some particular phenomenon is due to a cause existing at the radio sending station, you will naturally hesitate to write to the broadcaster about it. There would be the distinct possibility that the trouble really lay in your own receiver and that the broadcast station management could do nothing whatever to help you!

Let us first take up the effects pro-

duced by variations in the frequency of the carrier wave received from a radio-telephone transmitter, so that we may find out what things can happen within your receiving set and there produce similar effects.

As we pointed out previously, fluctuations in the frequency of a carrier wave may occur slowly, or with moderate rapidity, or even at a high rate. The resulting effect will, of course, be different in each of these cases.

A slow change of carrier frequency will cause the signals heard in a sharply tuned receiver to vary slowly in strength as the wave swings in and out of resonance with the receiver. It is almost obvious that an identical effect would be produced if something caused the resonant frequency of the receiver to vary slowly, for then, assuming the carrier wave to remain fixed in frequency, the receiver itself would slowly swing in and out of tune. As the receiver's tuned frequency departed from the frequency of the carrier wave, the signals would necessarily weaken, only to become stronger again as the receiver returned to resonance with the wave frequency.

Possibly you are one of those listeners who has always thought that the frequency to which his receiver responded best was determined by the settings of the dials and by nothing else. An impression of that kind is certainly warranted by some of the discussions of tuning that have been written, but it is really far from the fact. Where we are considering only the closed tuned circuits of a receiver, that is to say, the circuits in which a coil is shunted directly by a condenser for tuning, it is safe to consider that the tuning depends mainly (if not entirely) upon the values of the coil and the condenser, and that some particular setting of the tuning

condenser is invariably best for the reception of some single wave frequency (or wavelength). On the other hand, where the antenna circuit is to be taken into account the situation is very different.

It is probable that most of the receiving sets in use require reasonably accurate adjustment of the antenna circuit in order to give good signal strength from moderately distant stations. Such adjustment means that the natural electrostatic capacity of the antenna, in conjunction with its inductance, must be balanced against the inductance of the coils and the capacity of the condensers that are connected in the antenna-to-ground circuit within the receiving set. The resonant wavelength of such an antenna circuit, or (which is another way of saying the same thing) the wave frequency that will best be received at any time, is controlled by the values of *all* these inductances and capacities. Thus, even though you may leave the adjustable coils and condensers within the receiving set at any fixed value, the slightest change in the inductance or capacity of your receiving antenna will change the "tune" of your receiver. If the change in the antenna circuit is slight, the effect may not be serious; also, if your receiver uses a broadly tuned (or so-called "aperiodic") antenna circuit you may not notice the variations. On the other hand, (and this is the situation with most of the receivers in use), if your antenna circuit is sharply tuned you will find that fluctuations in your antenna constants will make themselves felt to a serious degree.

It is a fortunate thing there are only two general causes for such changes in antenna capacity and inductance. One of these is the actual movement of the receiving antenna with respect to other

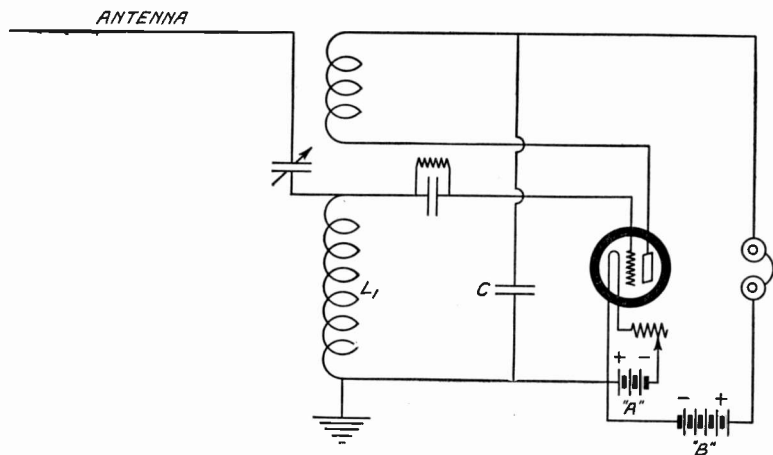

THE SINGLE CIRCUIT IS SENSITIVE TO ANTENNA CHANGES

Figure I: The secondary circuit is the most sensitive part of any receiver and in the single circuit the antenna is directly connected to this part of the receiver. Three-circuit sets, especially those in which the antenna is left untuned, are affected very little by changes in the capacity of the antenna.

conducting bodies in its neighborhood, and the other is the variation of capacity of other wires or conductors located near the antenna under consideration.

Taking up the first of these, it is not hard to see that if your antenna is a long wire, hung loosely so that it may swing in the wind, it will have a larger capacity when it dips down toward the earth than when it is drawn high above the ground. This is simply because the antenna wire acts like one plate of a condenser, the other plate being the conducting surface of the ground; we all know that the nearer the two plates of a condenser are placed together, the higher will be the capacity of that condenser. The changes of capacity produced by a slight swinging of the antenna wire may be so small as not to affect tuning appreciably, but as a practical matter it is not uncommon for received signals to fade out and swing in again as the antenna drifts back and forth in the breezes.

In most instances such variations in signal strength, caused by changes in the receiving antenna, sound very much like the signal intensity variations that are caused by frequency fluctuations at the transmitter. Indeed, they also sound a good deal like the common "fading" effects that are due to the little-known changes in space between the transmitter and the receiver. Usually, however, when the soaring of signal strength is caused by movement of the receiving antenna wires it is of more or less regular or periodic occurrence; that is, the signals swing in and out a more or less definite number of times per minute, corresponding to the mechanical swings of the antenna wires.

The obvious cure for this particular defect is to string your receiving antenna fairly taut, and if it is suspended from a tree or other support that can sway in the wind, to rig it with a weight and pulley so that it will not dip toward

the ground. This alone may not be enough, however, for if there are telephone lines, power wires or in fact any conducting bodies near the antenna, and if they can swing or move toward and away from the antenna wire, its effective tuning will be changed by their motions. For best results, then, you must not only prevent your own antenna from swinging but you must locate it out of the vicinity of all other conducting bodies that *can* move.

There is one infallible test by which you can determine whether variations in signal strength are caused by fluctuations at the transmitter, by changes in your receiving antenna constants, or by a "fading" effect in space between the sending and receiving stations. By connecting a simple tuned-antenna (single-circuit) regenerator to your antenna and tuning it to a moderately distant broadcasting station *while allowing the receiving set to oscillate*, you can find out whether the fluctuations are of frequency or of intensity. To do this, you should adjust the receiver to oscillate at a frequency just the veriest trifle different from the frequency of the carrier wave. This can be done by setting the tuning condenser or inductance as closely as possible "between the two whistles" that are characteristic of oscillating-receiver or heterodyne reception, and carefully tuning to one side or the other so that a slow beat-flutter in the signal is heard. Such exact adjustments are difficult unless you use a vernier or geared condenser, but in this case are not hard to obtain.

With the regenerator so adjusted, listen carefully to this fluttering sound produced by the slow beats between the carrier wave and the oscillations of your own receiver. If the flutter swings in and out, or if it turns into a musical tone of varying pitch, you may be certain

that frequency changes are taking place somewhere in the system. If the flutter or the low musical beat note remains practically constant, but the sounds increase and decrease in intensity, you may be sure that the carrier wave is constant in frequency, that your antenna does not swing enough to worry about, and that the fading is caused either by power variations at the transmitter or by fluctuations of the "carrying power" of the space between your receiver and the transmitting station.

Let us assume that this test shows, by the changes in pitch of the beat-note heard when you allow your regenerator to oscillate at a frequency very near to that of the carrier wave, that somewhere in the system there is a change of radio frequency going on. The next thing to find out is whether the frequency variation is at the transmitter or in your own receiver. This is easy. All you have to do is to set up a radio-frequency oscillating circuit (which may be another regenerative receiver) near, but not too near, to your own receiving set, and pick up the oscillations which it produces. Such an oscillator will generate radio-frequency currents of practically constant frequency for reasonably long periods of time and you should have no difficulty in producing a beat-note signal between its oscillations and those of your own receiver.

If this beat-tone is constant in pitch, even when the sound frequency is reduced to a very low note or flutter, you can assure yourself that your receiver's oscillation frequency is uniform and, therefore, that your antenna does not change appreciably in its constants under the conditions of your tests. It is a fair conclusion, having procured these results, that the frequency variation is occurring at the radio transmitting station upon which the observations were

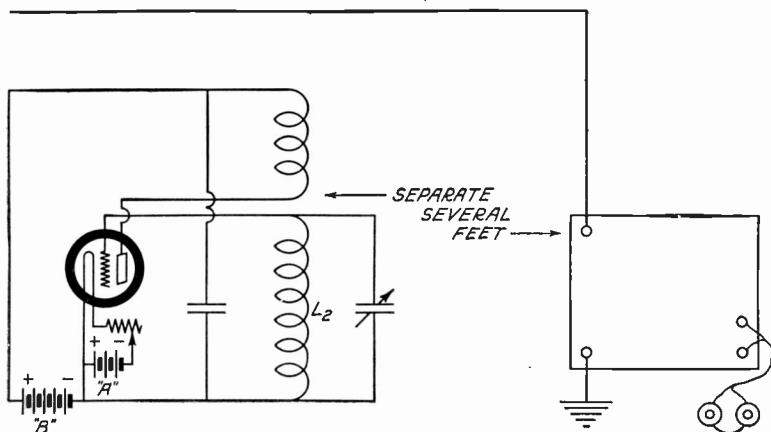

HOW TO TEST FOR VARIATIONS IN THE RECEIVING SYSTEM

Figure J: On the right is the receiving set or any other set which is to be tested. On the left is shown a circuit for an oscillator capable of producing continuous and steady radio-frequency oscillations. By tuning the two sets to the same or "beat" note, variations in the receiver will produce periodic howling noises.

taken. This can be checked by stopping your receiver from oscillating, tuning it to the transmitter in question and then adjusting the second oscillator (which uses no antenna, of course) to make beats with the wave currents from the broadcasting station. If these beats are of variable pitch, that is, if the beat or note frequency changes while you are listening and without your touching the receiving set or oscillator, it is proof that the carrier wave is varying in frequency and you are entirely justified in writing to the broadcasting station to ask them to steady things up so as to permit improved reception.

The second general cause of changes in the inductance and capacity of receiving antennas is even more serious than the mechanical swinging discussed above, but fortunately it does not happen so frequently.

Where a large number of receiving

sets are installed close together, however, as in the same apartment house, it often creates a great deal of annoyance. This second cause is the variation of capacity of conductors in the vicinity of the receiving antenna. For instance, if another receiving antenna is hung within fifteen or twenty feet of yours and is connected to ground through a receiving set, the operation of tuning that other instrument is likely to throw your receiver *out of adjustment*.

To illustrate this, let us assume that you have "tuned in" the signals that you desire to hear from some particular broadcasting station. This has been done, we will say, while your neighbor's antenna tuning condenser is set at 20° on the scale. If, now, he moves his condenser to 80° (for example) he may increase the effective capacity of his antenna, and, also, because your two antennas are close together, increase the

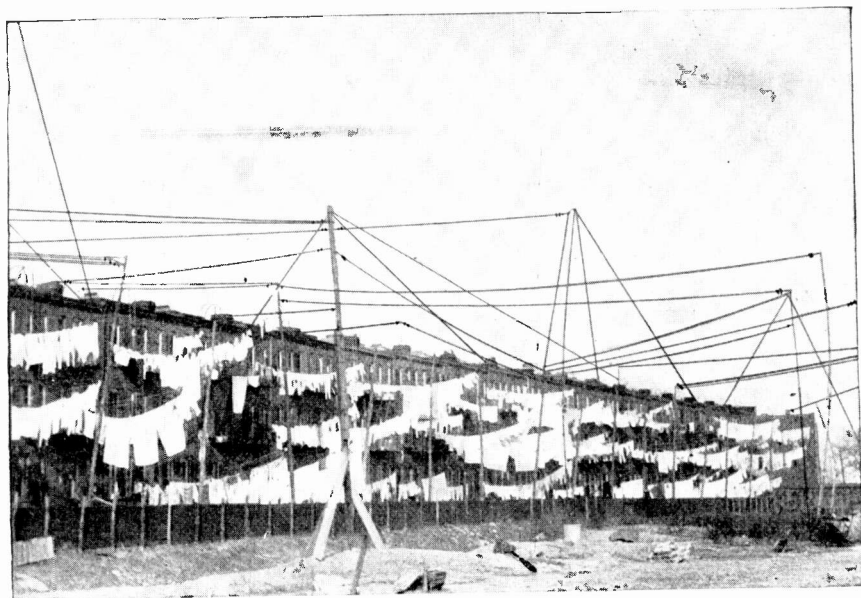

CARELESS TUNING CREATES RADIO CHAOS WHERE ANTENNAE ARE PLENTIFUL

Figure K: In neighborhoods where antennæ are strung close together, great care must be used in tuning; otherwise the set will break into oscillation and spoil the reception of every other nearby receiver.

capacity of yours. That would be likely to throw your receiver so far out of tune that the signals to which you were listening would vanish quite without warning, and you would have to re-tune your set to bring them in again. Should it happen that the act of re-tuning your receiver similarly disturbed your neighbor's reception, he would be likely to adjust his once more and thus again disturb your balance. Thus an exceedingly aggravating condition may arise, and *you may neither be able to enjoy the operation of your outfits.*

If you notice tuning effects of this kind, which are evidenced by the sudden dropping out of signals, or by their irregular weakening, or by their appearance at various different settings on your antenna tuning scale, first see how far

your receiving antenna is from other wires. If there is another antenna near it, get together with your radio neighbor and find out by experiment whether the adjustment of his set affects the tuning of yours and *vice versa*. If you interfere with each other in this way, try to work out a plan whereby your two antennas may be kept as far apart as possible, and after moving them to the new locations, try the test again.

Sometimes it happens that the two antennas cannot physically be separated far enough to prevent them from affecting each other; in such instances some improvement may be had by installing broad-tuned antenna circuits in both receivers, for the reactions caused by tuning coupled circuits will generally be less. Some loss in signal strength may

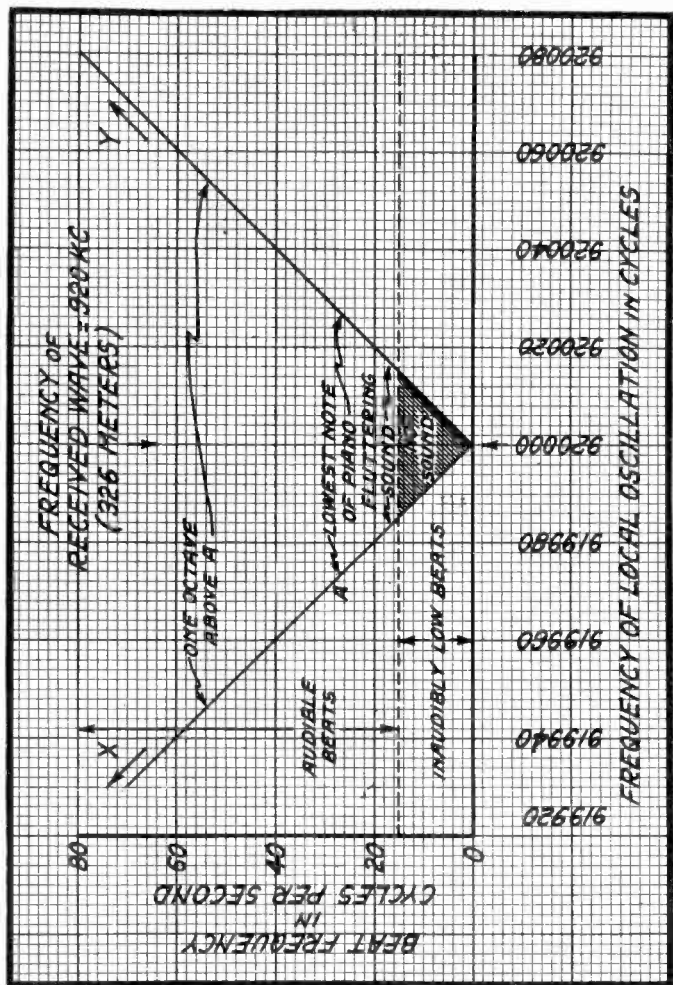

HOW A SILENT OR BEAT NOTE IS PRODUCED

Figure 1: When two high-frequency waves are near the same rate of oscillation, they reinforce each other and neutralize each other in regular sequences. If this sequence occurs at a rate above sixteen times a second, an audible note is produced in the telephones. The two sides of the Y in the diagram show the plotting of this note as one of the radio frequencies changes wavelength. The darkly shaded section marked "no sound" is the "beat" note.

be experienced, but as a rule it will be more than compensated for by increased convenience in tuning.

Neighboring antennæ are not the only conductors that change in capacity and thus affect tuning conditions. If your antenna runs close to a power wire or a telephone circuit, you may find that certain broadcasting stations tune in best at one setting sometimes and at other settings at other times. Where a certain wavelength is best heard on your tuner may then depend upon whether somebody's telephone is idle or is in use, or whether a certain elevator is running, or whether the lights in some particular house are turned on or off. The remedy for troubles of this kind is to follow the good old rule of keeping your receiving antenna as far as you possibly can from all other conductors, including wire lines and your neighbors' antennæ.

Although it is not at all difficult to handle a simple regenerative receiver so as to secure from it really remarkable gains in radio reception, there exists a widespread impression that great skill is necessary for its proper manipulation. This is perhaps due to two prime causes:

First, because many poorly designed regenerators, which are almost impossible to control properly, have been made or sold and are in use;

Second, because well planned and built receivers are frequently supplied with incomplete or even misleading instructions for operation and so puzzle unskilled users.

Radio phenomena, understandable enough when the fundamental reasoning underlying them is explained, are indeed baffling to the uninstructed novice; when one adds to the simple tuning effects the interesting and varied actions which the feed-back circuits produce, it is something of a wonder that in the tremendous recent growth of radio re-

ceiving more trouble has not been experienced.

In order to fix our ideas about the operation of the Armstrong feed-back, let us concentrate upon a simple circuit arrangement which is now in wide use and which is capable of giving excellent results with only simple adjustments.

Figure M. is a diagrammatic representation of this layout, which may be called the "single-tuned circuit" with inductive feed-back. It shows a simple aerial-to-ground circuit including a variable tuning condenser and a tuning coil which is preferably adjustable in steps and to which is inductively (and variably) coupled another coil. The terminals of the tuning coil are connected to the detector tube grid, through condenser C_1 and leak resistance R_1 , and to the negative side of the filament. The filament circuit includes the usual six-volt storage battery and a finely adjustable rheostat R_2 for controlling the temperature or brilliancy of the filament cathode and consequently its electronic emission. The plate circuit is completed through the second or feed-back coil above mentioned (frequently called the "tickler" coil), the telephone receivers and the "B" battery of about 20 volts potential—the telephones being shunted by a by-pass condenser C_2 .

For best results on the 360 meter wave length, which is common in radio broadcasting, the aerial capacitance should be not greater than about 0.0005 microfarad, and its natural wavelength less than 220 meters or so. These conditions will be met by a single wire antenna from 120 to 150 feet long (including the down-lead to the instruments) and from 40 to 60 feet above the earth. The tuning condenser should be variable over at least the range from about 0.0001 microfarad minimum to 0.0007 maximum capacitance. The

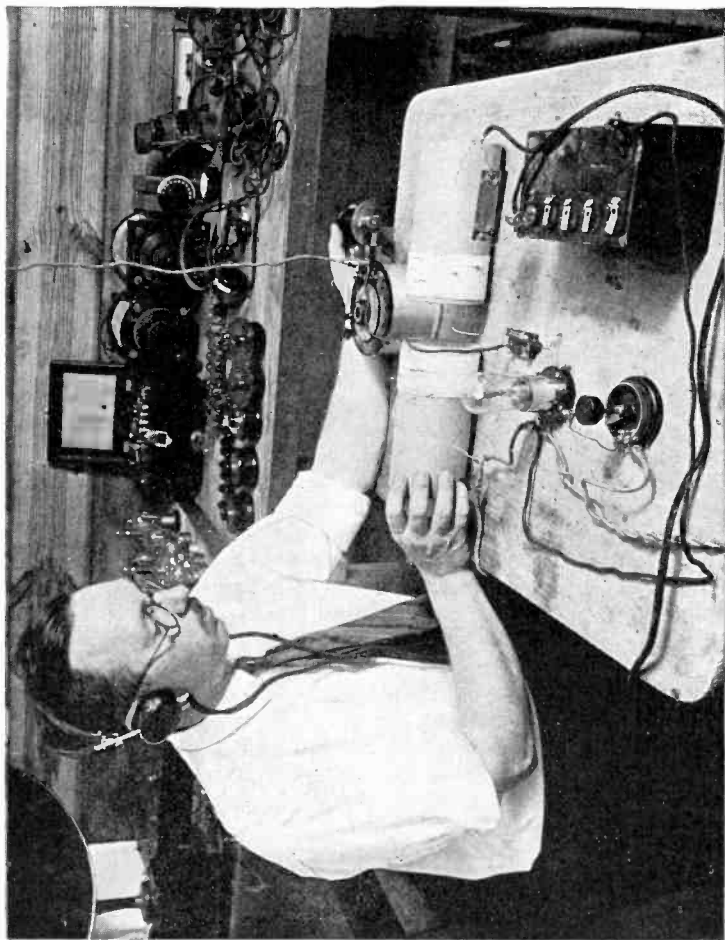

FIG. M1

How the single-circuit receiver should be connected. Mr. Hogan is here shown tuning the antenna circuit with the condenser (at his left), while controlling the amount of regeneration by moving the tickler coil nearer or farther away from the tuning coil.

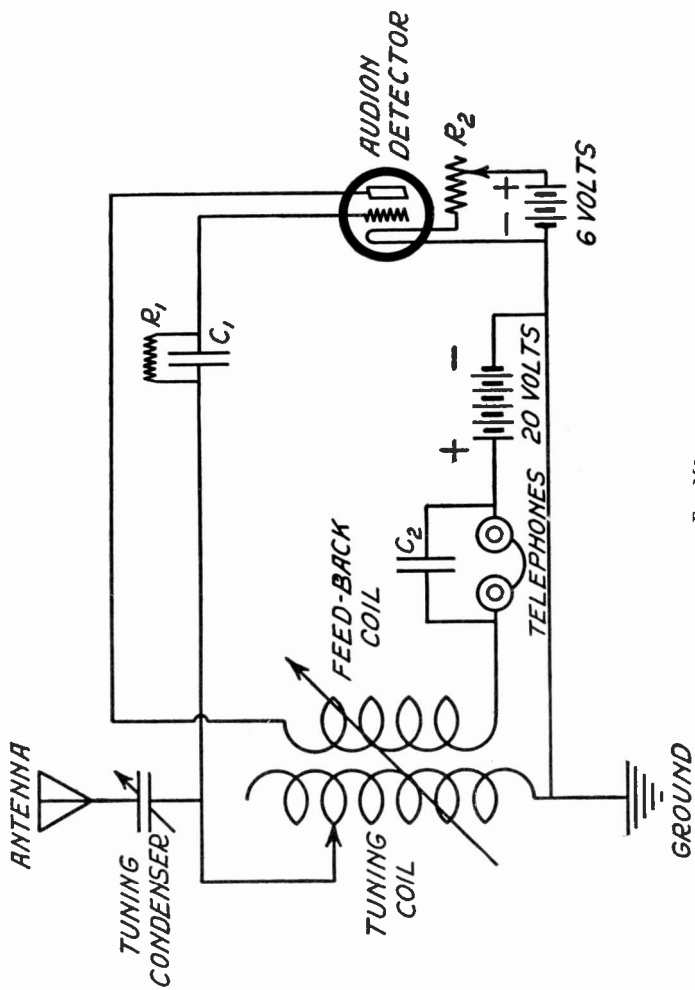

Fig. 112

The wiring diagram for the single-circuit oscillating receiver. This is the type of receiver that causes a great deal of radio interference because of the audio-frequency pulsations it transmits into the ether.

tuning coil should have an inductance in the general neighborhood of 50 to 100 microhenries, the exact value (which may in some cases be outside these limits) being determined largely by the particular antenna used. A coil of fifty turns of No. 22 B & S double cotton-covered magnet wire wound on a cylinder of $3\frac{1}{2}$ inches diameter and provided with taps at 20, 30, 40 and 45 turns will give good results in most cases. A "hard" vacuum tube like the VT-1 or UV-201 should be used for the detector, as its vastly increased stability is ordinarily to be preferred over the delicately adjusted higher sensitiveness of a gassy tube in regenerative circuits. A grid condenser C_1 of about 0.0003 microfarad, grid leak of 1 megohm and by-pass condenser C_2 of 0.005 microfarad will usually give good results. The filament rheostat will be of about six ohms total resistance.

This leaves only the feed-back coil for consideration; a winding identical with that suggested for the tuning coil will work well under most conditions. The two coils should of course be arranged to be easily moved with respect to each other, so that the amount of feed-back coupling can be varied conveniently. In working with wavelengths as short as 360 meters and capacitance values of the order of 0.0005 microfarad and less, changes in tuning are frequently produced by the additional capacitance introduced when one's hand is brought near the circuit to adjust it. In an experimental outfit these bothersome effects can be avoided by fitting the tuning condenser and the coupling with insulating control handles some twelve inches in length, which will permit adjustment without close approach of the operator's hand. When a set is built up in panel form, a grounded copper shield plate between the control knobs and the

instruments aids in securing compactness.

So much for the constructional fundamentals of a simple but effective regenerator.

It will be noted that there are only four variable elements in the entire system, namely: (1) the tuning condenser; (2) the tuning coil; (3) the coupling controlling the amount of feed-back, and (4) the filament rheostat. As the last-named item is not critical and as both the tuning controls produce the same general effect, it is fair to say that only two elements (the tuning condenser and the feed-back coupling) need be adjusted in the normal use of this outfit. The tuning condenser will ordinarily be of the semicircular multiple plate type having a total capacitance of about 0.001 microfarad; for easy adjustment in short wave working it is convenient to provide in addition a so-called "vernier" condenser, which has only two or three plates and which, when connected in parallel to the main tuning condenser, produces a change of tuned wavelength (for a motion through its entire scale of 180°) equivalent to only three or four degrees of the main condenser. The other adjustment—the feed-back coupling—may be controlled by turning a knob which varies the angular position of the "tickler" coil with respect to the tuning coil, or simply by moving the coils themselves nearer together or farther apart.

If you have purchased a regenerative receiver of the single circuit inductive feed-back type you will have no difficulty in these two adjustments; the handle usually marked "tickler" controls, from maximum to minimum, the amount of regeneration; and the resonant wavelength is varied by means of the "tuner" knob, supplemented, in some of the better instruments, by a

closely adjustable condenser called the "vernier," as described above. In setting up an assembled or home-made outfit, however, it is necessary to determine the proper or additive direction of feed-back coupling. To do this, first be sure that the circuit is wired exactly as shown in Figure M2; put into circuit the full 50 turns of each of the two coils, and place them some distance (at least 8 to 12 inches) apart on the operating table. Listening in the telephones, test the detector circuits by turning on the filament to normal brilliancy and making and breaking a connection of the 20-volt plate battery; if everything is all right a strong click will be heard in the telephones at each completion and interruption of the circuit. By varying the tuning condenser it should now be possible to pick up (and tune to maximum strength) some radio telegraph or telephone signals; perhaps it will be necessary, if your aerial is relatively large, to reduce the number of turns used in the tuning coil. If signals can be "tuned in," the proper current direction in the feed-back coil can easily be determined by moving it nearer to the tuning coil, for if the signals increase in strength as the coils approach each other everything is all right. On the other hand, if bringing the two coils nearer together produces a weakening of the signals, either the tuning coil or the tickler coil must be reversed end for end. Once having the relative directions correct, the amount of regeneration is, of course, controllable from minimum to maximum by moving the coils from a relatively widely spaced to a closely adjacent position.

If signals cannot be picked up while the coils are far apart, try varying the tuning condenser as the coupling between the coils is increased, first with one relative direction and then with the other. Radiophone or wireless tele-

graph messages may be intercepted at some wavelength, with the help of regenerative amplification, so that the proper relation of the coils may be observed. If no signals whatever can be heard at the time the apparatus is being tried out, you will have to rely upon the oscillation test. Listening in the telephones as before, slowly bring the tickler coil near to the tuning coil; as they approach, if the relative directions are correct, you will hear a single "cluck" in the telephones. This marks the point of increased regeneration at which the whole receiver begins to generate radio-frequency oscillations. On moving the coils apart these local oscillations will cease; by increasing the coupling once more a repetition of the "cluck" will be heard, indicating the recommencement of oscillations. If the two coils are wrongly directed with respect to each other it will be found either that these oscillations cannot be produced at all or that the two coils must be nearly touching each other in order to do so. The remedy is, as before, to reverse one of the coils. Instead of turning one coil end for end, the wires connecting to it may be transposed.

Now let us look a little more closely at the adjustments necessary to get best results.

The set must be so assembled that the oscillation or "cluck" effect just described can be secured easily at the working wavelengths; when the feed-back coupling is increased to the point where oscillations are generated, their presence can be detected by tapping the grid connection of the detector tube; on each contact of the finger this same characteristic cluck will be heard in the telephones. If your set will not work in this way it is not regenerating properly, and you will not get the best results from it until it is fixed up.

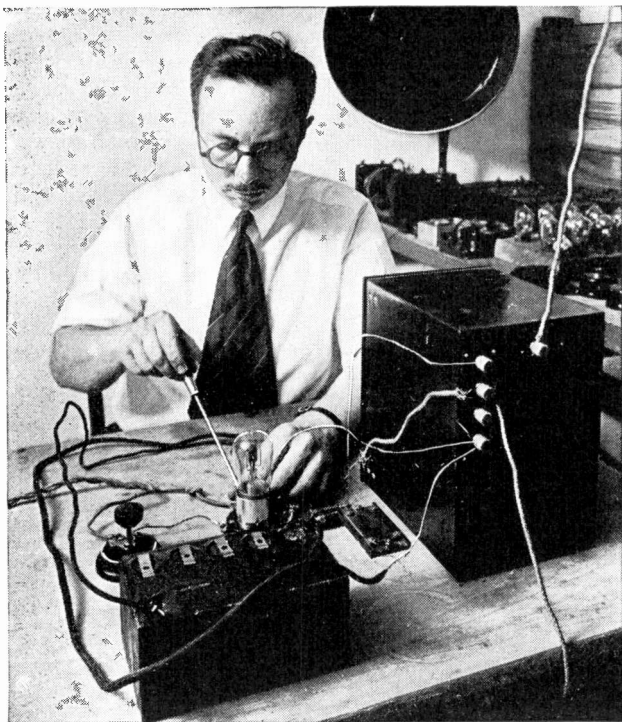

FIGURE N

In order to insure accuracy in his description of the way to tune a standard single-circuit regenerative receiver, Mr. Hogan actually performed the work in his laboratory—as these illustrations demonstrate. He especially warns the amateur against allowing the tube to oscillate, which causes interference to others in the neighborhood.

To pick up a signal of unknown wavelength, or one for which the tuning condenser setting is not known, the tickler coupling should be set at a point sufficiently loose (toward the minimum) to prevent the set from oscillating as the condenser knob is swung back and forth throughout its range. If the desired signals are not heard at any point of the condenser scale with the full tuning coil inductance in circuit, change the number of turns and swing the condenser handle again; when the tuning coil is re-

duced in inductance by cutting out some of its turns, the tickler coil can ordinarily be moved up closer to the tuning coil without causing oscillations to begin.

After you have found the best number of tuning coil turns and the best condenser position for the desired signals, move the tickler coil slowly toward the maximum coupling position; as the coupling is increased nearer and nearer to the point where the receiver starts to generate oscillations, the signals will grow louder and louder. The tuning

condenser should be readjusted slightly as the tickler coupling is increased, for the greater feed-back action makes the circuit more sharply tuned and a very exact setting becomes necessary in order to secure the loudest signals. It is for this final critical adjustment that the vernier condenser is so convenient.

The feed-back coupling cannot be increased indefinitely, for as the point where oscillations begin is closely approached the signals will not only increase in volume, but will show signs of distortion. This is particularly disadvantageous in receiving radiophone speech or music with amplifiers. When the oscillation point is reached or passed, the radio-frequency currents generated in the receiver react with those of the received wave to produce electrical beats which may entirely spoil the character and quality of the signals; hence the feed-back coupling should always remain on the side toward "minimum" from the oscillating point, for receiving radiophone, spark or other modulated wave signals.

There is another good reason, beyond the loss of signal clarity, for always keeping the tickler coupling below the oscillation-generating point; the radio-frequency currents set up in the receiving outfit by circuit reaction pass out of the receiver itself and into the aerial, there radiating electromagnetic waves of the frequency to which the set is tuned. Thus the receiver virtually becomes a continuous-wave transmitting outfit, which, although relatively feeble in power, is capable of creating severe interference for several miles around.

Every time you allow your regenerative receiver to break into the oscillating condition by increasing your tickler coupling too far, you send out radio waves from your antenna. Every time you hear in your telephones the loud

heterodyne whistle caused by interaction between the received carrier-wave and the oscillations generated within your outfit, the waves your set radiates are producing similar interference whistles in sensitive receivers near you. Thus you not only spoil your own reception, but also that of your radio neighbors in a zone of several square miles. All of us have heard interference produced in this way and have learned how aggravating it is. As this disturbance is totally unnecessary and nothing more than a demonstration of ignorance or lack of consideration on the part of "transmitting" receiving set users, no one who understands its causes and effects will want to create such interference deliberately.

While there is no hardship in tuning to an unknown telephone or modulated wave while keeping the regenerative receiver slightly below the just-oscillating condition instead of slightly beyond it, sometimes one finds it convenient to pick up a continuous wave by setting the receiver into oscillation and swinging the condenser knob back and forth until the heterodyne whistle is heard. This should never be done at wavelengths near the broadcasting wave of 360 meters; even at other frequencies it may produce bad interference. However, by equipping the receiver with a single radio-frequency amplifier in advance of the detector tube, the local oscillations may be kept almost entirely out of the aerial and this source of interference practically eliminated. Figure O shows a circuit arrangement of this kind; further details of it will be given later.

The ordinary audion is so much more effective when used with a well-designed feed-back circuit than in a non-regenerative outfit that there are comparatively few grid-tube sets used in the latter fashion.

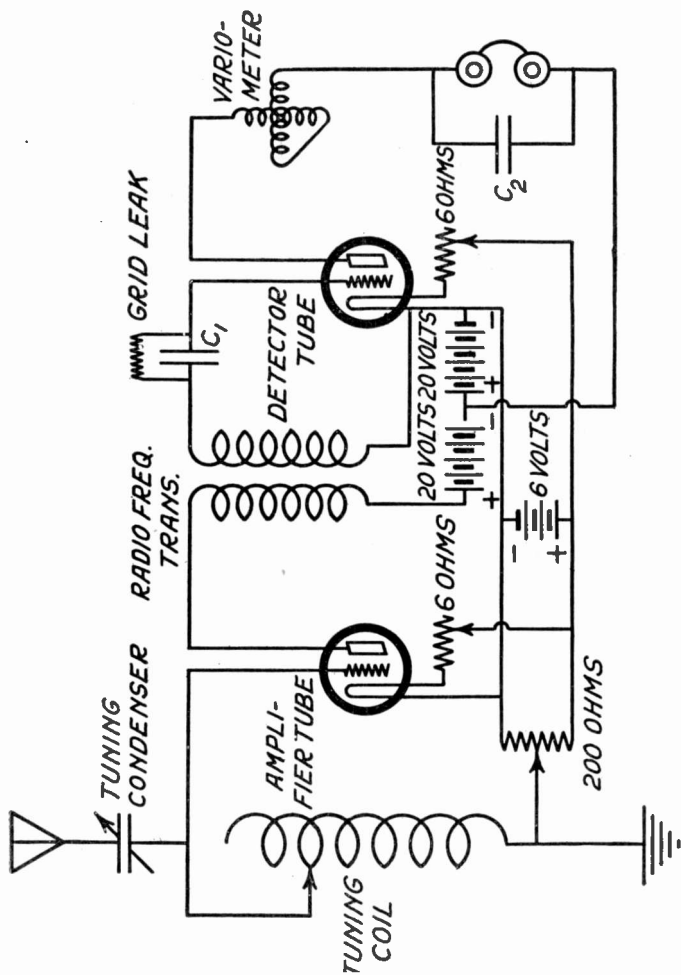

FIGURE 0

The diagram gives the proper connections for including one stage of radio frequency amplification in the regenerative set. By this means the set is prevented from re-radiating high frequency oscillations, which cause so much interference in the hands of inexperienced operators. Static is also reduced by this addition.

Regeneration has two points of especial utility:

First, it neutralizes a large part of the wasteful resistance in the ordinary aerial and in the receiver circuits (thus giving louder signals and better selectivity).

Second, it provides a convenient means for receiving continuous wave telegraphy or for picking up telephone carrier waves by employing the self-heterodyne method.

The first of these advantages is perhaps the more useful, especially when it is necessary to use rather poor aerials for receiving.

The second point represents a possibility that is of tremendous help to the individual user of a regenerator, but as it requires the set to be placed in the oscillating state, it may create a good deal of interference to reception by other listeners within a zone of several square miles.

This matter of interference caused by oscillating regenerators seems to be by no means as serious as it was some months ago. When radio novices were setting up feed-back circuits of all conceivable types and, in the absence of competent instruction, were allowing them to oscillate continuously and slightly off-tune from the broadcasting wavelengths, it was nearly impossible to receive a complete radiophone program. Of course these unskilled users themselves heard nothing but whistles, louder than the interfering tones they produced in their neighbors' outfits; largely as a result of this many of them have learned to use their receivers properly without allowing them to oscillate. Self-interest has thus brought about a great public benefit.

The ideal condition in which there will be no interference from regenerators has not yet been reached, however. Occasionally while listening to a broadcasting

station one hears the swinging beat note or whistle which proves that someone in the vicinity is tuning his receiver by the "heterodyne search" plan. In the suburbs of New York such interference nowadays is often only momentary, but there is no need even for that. It is entirely feasible to pick up long distance radiophone signals by tuning one's receiver with the feed-back set somewhat *below* the oscillating point, and if this is done it will cause no inconvenience to other listeners. Some otherwise good regenerators are so designed, however, that it is practically impossible to tune over even a rather small band of wavelengths without either readjusting the amount of feed-back or losing the benefits of regeneration. This is especially true of many of the plate-variometer outfits, in which helpful amplification can be had (for a single setting of the plate circuit inductor) only over a small wavelength range. Tuning beyond such limits results either in negligible regenerative amplifications or in the production of oscillations that may greatly disturb nearby receivers.

There are several ways in which one may get most of the useful features of regeneration without causing the radiation of interfering waves from his receiving aerial. With these arrangements it is feasible to pick up signals from distant stations by the heterodyne or beat-note method, and to increase signal intensity by regenerative amplification resulting, in part, from neutralization of circuit resistance. As they depend, however, upon the use of a radio-frequency repeater between the antenna and the feed-back circuits they will not permit great reduction of aerial resistance; it is consequently desirable to use these circuits with an antenna which is itself of sufficiently good design to be an effective wave-absorbing system.

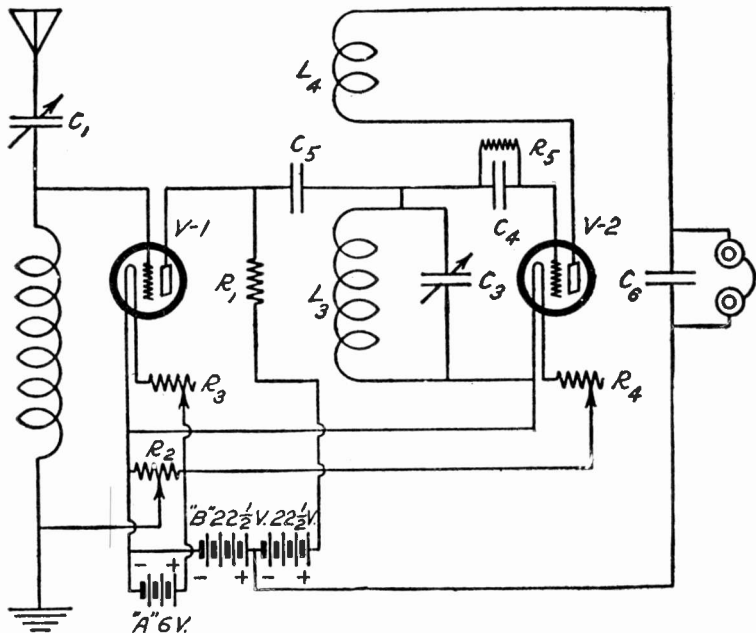

A SIMPLE CIRCUIT THAT INCLUDES A REPEATER TUBE

Figure P: A circuit with one stage of tuned radio frequency amplification with regenerative detector. This is the "hook-up" of the set pictured on the page following.

A simple circuit that includes such a repeater tube is shown in Figure P. Here the antenna is connected to the ground through a tuning condenser of about 0.0005 microfarad maximum capacitance and an inductor of some 50 or 100 microhenries. Across this coil is connected the input circuit of the repeater tube, as shown; the grid potential can be controlled, from 0 to 6 volts positive of the negative filament lead, by means of the potentiometer. The output circuit of the repeater tube contains the tuned primary of a short-wave inductive coupler; the balance of the circuit is the conventional transformer feed-back or "tickler" arrangement. In making the installation the only point

that requires special care is the choice of the proper constants for the coils and condensers that will enable the circuits to tune to the wavelengths it is desired to receive.

The operation of this circuit is a little more difficult than that of the ordinary single-circuit regenerator.

In the first place, there are two sets of circuits that can oscillate independently. The whole idea is to prevent the first tube (repeater) and the aerial from generating oscillations, and to confine this action to the second tube and its circuits (See Fig. Q).

In the second place, there are three tuned circuits (C_1-L_1 ; C_2-L_2 ; and C_3-L_3) and two couplings (L_2-L_3 and L_3-L_4) to

adjust. But once the proper constants are chosen and the outfit is correctly set for reception of some particular wavelength, it will not be found difficult to tune to others.

Probably the best way to start using this receiver is to connect it up as shown, then to light only the detector tube, to set coil L_2 as far as possible from L_3 and to couple the aerial coil L_1 to secondary L_3 . This makes the set a simple two-circuit regenerator with inductive feedback, and it may be tuned to a nearby broadcasting station in the ordinary

way. Thus one can find fairly closely the best values for C_1 , L_1 , C_3 , L_3 and L_4 . Of course the final tuning should be done with quite weak coupling between L_1 and L_3 , so that the inductance of each coil will not be too greatly influenced by the reaction of the other. There remains only the determination of proper values for L_2 and C_2 , and the co-ordination of the adjustments throughout the set.

This will not be difficult if the operator now removes coil L_1 from the vicinity of L_3 and couples L_2 and L_3

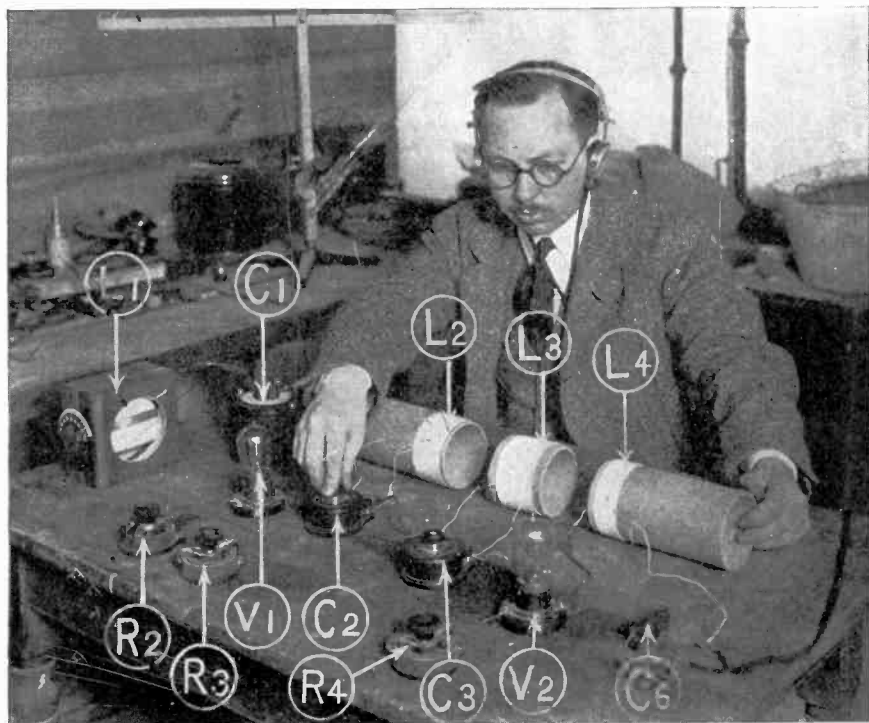

THE AUTHOR ILLUSTRATES THE "HETERODYNE-SEARCH" PLAN OF TUNING

Figure Q: Mr. John V. L. Hogan is seen adjusting the wavelength of the plate circuit of the amplifier tube with his right hand, while controlling the regeneration in the detector circuit with his left hand. The "heterodyne-search" plan of tuning may be used with this set, without causing interference to other sets in the neighborhood.

with moderate tightness—of course, turning on the filament of the repeater tube also. If the potentiometer contact is too near the *negative* end the repeater tube will be likely to oscillate as he adjusts C_2 and L_2 , so it is well to turn it well over toward the positive end of the potentiometer winding while he is making his first adjustments.

There is no reason why he should not use identical coils for L_2 and L_3 and the same kind of variable condensers for C_2 and C_3 . If he does this, he may set C_2 and L_2 to the same values that have just been determined to the best for C_3 and L_3 . Then the whole set can be tuned, simply by making compara-

tively small changes in the settings of the three condensers.

Once working, the antenna circuit may be left tuned to approximate resonance with the desired wave and the potentiometer set at a point well toward the positive end (so that the aerial circuit will not oscillate) and then forgotten, until the operator wants to make a substantial change in wavelength. For smaller variations the condensers C_2 and C_3 are handled just like the primary and secondary condensers of an ordinary two-circuit tuner, and the couplings L_2-L_3 and L_3-L_4 are handled like the primary-secondary and secondary-tickler couplings of such an outfit

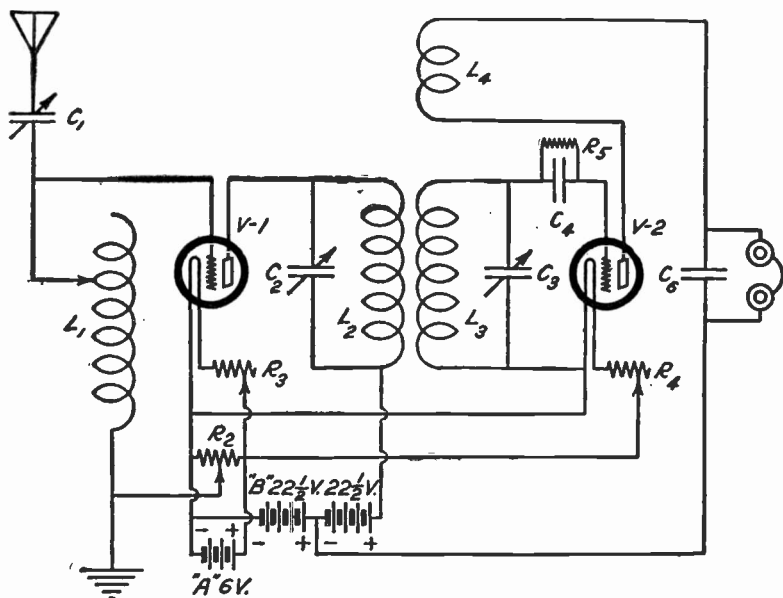

A REPEATER TUBE SET THAT IS EASY TO TUNE

Figure R: This is a diagram of the set illustrated on the following page. It shows one stage of resistance-coupled radio frequency amplification, with a tuned regenerative detector circuit. This circuit will be found to be easier to tune than the circuit shown in Figure P.

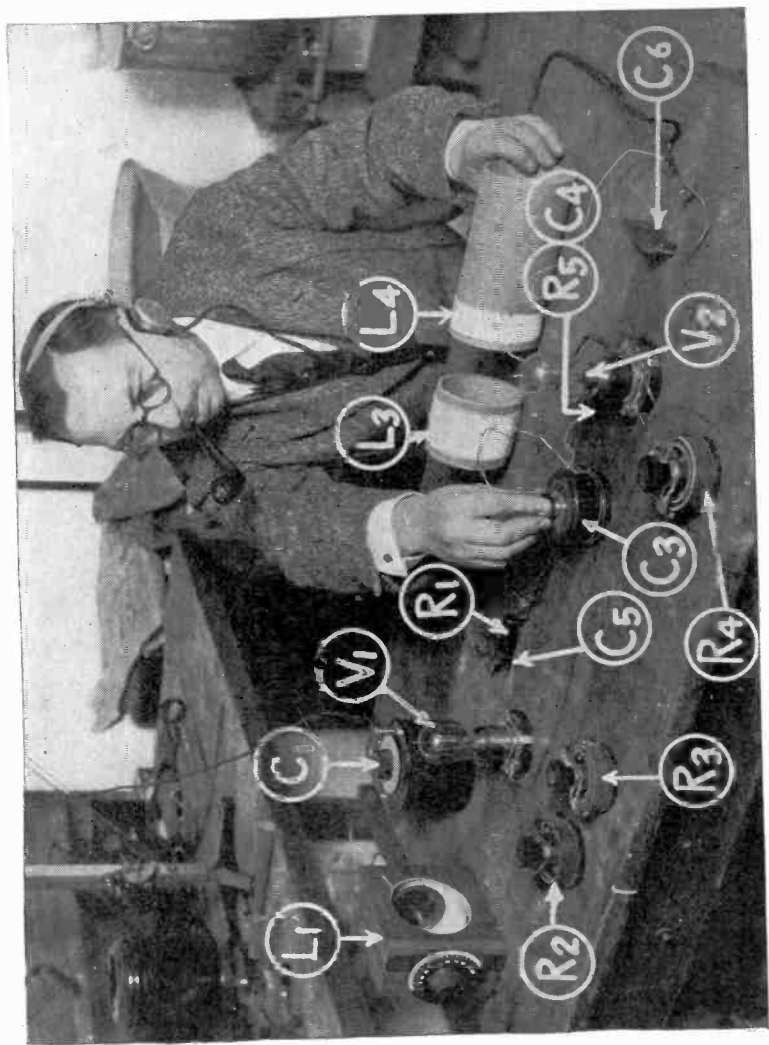

TUNING THE RESISTANCE-COUPLED SET

Figure 5: The designations of the parts, shown in circles on the photograph, correspond with the designating letters in the text and diagrams. If you want to try out these circuits, you will be able to identify the right parts, and hook them up properly. Mr. Hogan not only explains how to tune these circuits but he gives explicit directions for adjusting each instrument.

used with regeneration. He can throw these circuits into oscillation by moving L_4 nearer L_3 , in order to pick up carrier waves by means of the beat-tone method and he can thus get regenerative amplification and selectivity in these circuits. Yet the repeater tube will prevent the oscillations from feeding into the aerial circuit and radiating interfering waves.

The first tube is referred to as a radio frequency repeater rather than an amplifier because little amplification will be had at broadcasting wavelengths if the potentiometer contact is kept far enough toward the positive end to prevent the aerial system and the first tube from regenerating and thus tending to oscillate. By decreasing the positive potential thus applied to the grid the operator can take further advantage of regenerative amplification in this first tube and get considerably louder signals, but if he goes far in this direction he will be back where he started, for the repeater tube will begin oscillating if the coupling L_2 - L_3 is slightly reduced and the oscillations will be radiated as interfering waves.

Proper operation of this outfit requires the first tube to remain in the non-oscillating condition regardless of changes in the circuits; the regeneration supplied in the detector tube circuits is used for selectivity, amplification and heterodyne pick-up.

The constants for the instruments used in such receivers have been stated many times, but for the sake of completeness it may be well to repeat. There will be some deviation from normal, in a good many cases, to get best results; but a typical set of values of general utility is the following:

Condensers C_1 , C_2 and C_3 of 0.0005 microfarad maximum capacity, preferably fitted with verniers; coils L_1 , L_2 , L_3 and L_4 each 50 turns of No. 22 B & S double - cotton - covered magnet wire

wound on paper or bakelite tubes of $3\frac{1}{2}$ inch diameter, with taps at 20, 30, 40 and 45 turns; potentiometer 200 ohms; filament rheostats 6 ohms; grid leak 2 megohms; grid condenser 0.00025 microfarad; by-pass condenser 0.005 microfarad; tubes UV-201 or VT-1; filament battery 6 volts (storage); plate battery two or three $2\frac{1}{2}$ volt blocks. A good antenna would be a single wire from 100 to 150 feet long (including down-lead) with the horizontal portion some 40 feet or more above the earth. All of these values are stated for use on amateur and broadcasting wavelengths.

A little additional ease of adjustment may be had, at the cost of some selectivity, by using the circuit of Figure R. The elements are the same as before, except that C_2 and I_2 are omitted and R_1 and C_5 added. R_1 is a coupling resistor of about 50,000 ohms and C_5 a fixed condenser having about 0.0005 microfarad capacitance. With this arrangement the only important variables, once the set is adjusted to approximately the best condition, are C_1 , C_3 and the coupling between L_3 and L_4 .

It will be found that with the Figure R circuit there is much less tendency for the repeater tube to produce oscillations in the aerial circuit; and that the potentiometer contact can be moved much nearer its negative terminal. Further, the tuning is considerably simpler than that of Figure P. It will be noted that the plate circuit potential of the repeater should be increased to about 60 volts in order to offset in part the effect of the resistance unit R.

Either of these two circuits is capable of sharper tuning than the ordinary single-circuit regenerator and, on a good aerial, will give excellent results. With reasonable care in adjustment the user can do all the searching for long-distance stations he may desire, taking the full

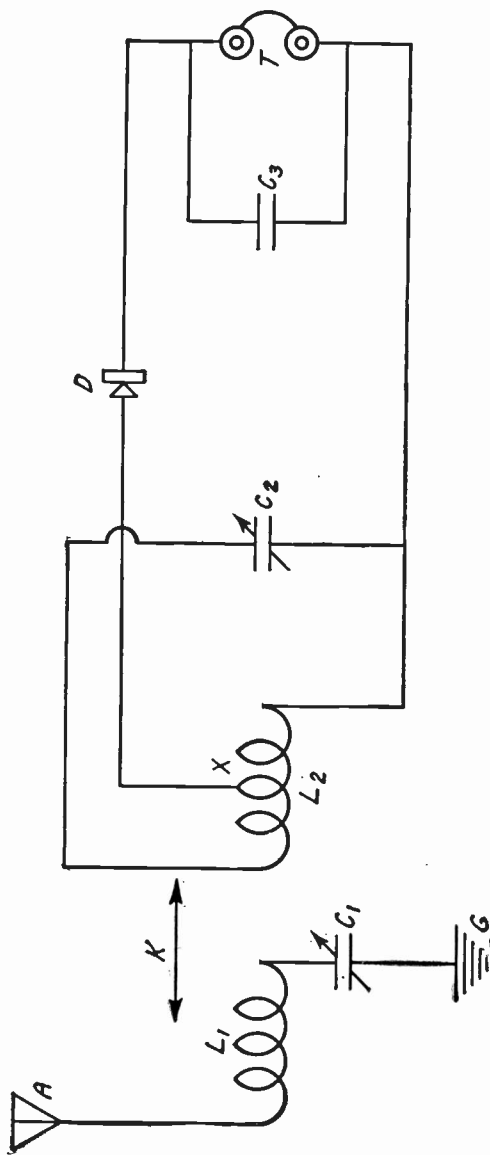

A CIRCUIT THAT WILL IMPROVE THE CRYSTAL RECEIVER

Figure T: This hook-up with a crystal detector will give high selectivity because of the coupled circuits and the method of tapping the secondary coil.

advantage of the beat-note for locating weak signals, and yet be secure in the knowledge that he is not interfering with his neighbors.

We have considered spark or code interference most specifically, and we saw that, although some improvement may be expected as a result of the reduction of the number of radio code messages being sent on waves that lie within the broadcasting range, we must go farther than this to get the desired relief. The situation will be greatly aided by the installation and operation of higher-powered broadcasting transmitters. But, it will take time to get these stations into operation. Meantime, we should improve our receivers so that they will better discriminate between the music and the speech and the undesirable code interference. This improvement must naturally be sought through increasing the selective power of our receiving sets.

It is well to remember that even the most nearly ideal radio receiver, from the point of view of selectiveness, will not entirely exclude interfering signals sent out by powerful and nearby spark transmitters. Nevertheless, most of the radio receivers in use are of types that can be substantially improved in their capacity to cut out spark signals, and, what makes the improvement of added value, they will at the same time become better able to choose between the signals of different broadcasting stations that operate on adjacent waves. Thus, while we are attempting to get more satisfactory conditions for listening to broadcast programs without interruption from ship or shore spark transmitters, we will simultaneously be reducing our troubles from "cross talk" or direct program interference between broadcasting stations.

We should consider next the way in

which two-tuned circuits may be used with crystal receivers.

The most satisfactory arrangement is to tune the antenna-to-ground circuit separately and to couple it transformer-fashion with a second tuned circuit to which the detector is directly connected. Such a receiver is shown in Figure T. in which the first or antenna-to-ground circuit is shown at the left extending from the antenna A through the primary coil L_1 and the primary tuning condenser C_1 to the ground connection G. The size of the coil and condenser to give best results, will depend up on the size of the antenna to be used. As a general rule, the larger the antenna is, the smaller the coil may be and the larger the tuning condenser that may be used.

For this sort of circuit it is desirable to use an antenna that is not too long and which is large or has great capacity through its umbrella-rib or parallel wire formation. If you have a single tall flag-pole or similar support, an umbrella antenna constructed on it is very effective. The individual wires should not be over 75 or 100 feet long, and all of them should be of the same length, including the down-lead to the receiver. If you have available two masts or points of support you will get good results from four parallel wires, each of which should be not more than 50 or 60 feet long, and hung at least three feet apart between spreaders.

With a fair-sized antenna of the sort just described, the primary condenser C_1 may be of .0005 or even of .001 mfd. capacity, and the coil L_1 may be chosen by trial so that the broadcasting waves come at intervals that spread well over the scale of the condenser. A good coil to begin with would have 100 turns of No. 22 DCC copper wire wound on a tube three and a half or four inches in

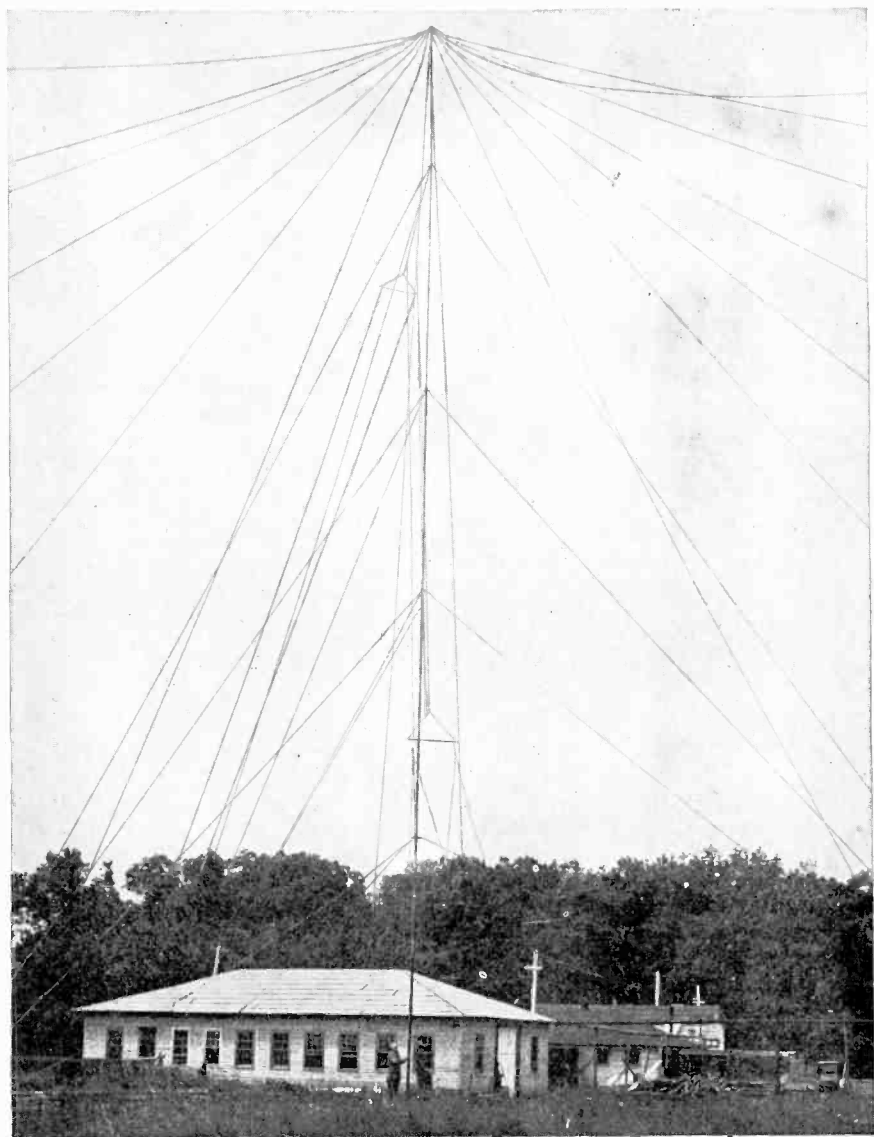

Signal Corps, U. S. A.

THE UMBRELLA ANTENNA HAS NO DIRECTIONAL EFFECT

Figure U: This type of aerial has a large electrostatic capacity on account of its numerous wires. The individual wires should be not more than 100 feet, and all of them should be as near the same length as possible. The down-lead should not be longer than the antenna wires.

diameter. If the antenna is of fairly high capacity, it may be found that the long-wave broadcasters "tune in" too far down the condenser scale. If, for instance, WEAJ (610 kc or 492 meters) tunes at less than 70 or 80 divisions on a 100-part scale, it is an indication that the number of turns on the coil may be reduced to advantage. The same indication may, of course, be obtained by noting the tuning point of any of the lower-frequency (longer-wave) stations such as KSD, KYW, WNYC, WCX or WIP. What is sought is to make the coil of such size that the lower frequencies tune at the maximum-capacity end of the condenser scale, because then the tuning adjustment will be most effective over a large part of broadcast wavelengths.

If the coil L_1 has too few turns for the antenna you are using, or, in other words, if the antenna is too small for the coil, you have the option of adding more wires to the antenna (it is not so good to increase its length) or of increasing the coil.

As a general rule, it is better to enlarge the antenna than to use more than 100 turns on the coil. You can, of course, tell whether the coil or the antenna is too small, because the medium-wave stations such as WJY, WGY or WFI will tune at the high-capacity end of the condenser scale instead of near the middle. Thus, if you cannot reach the longer-wave stations on your condenser dial, you will have to add turns to your coil or else increase the size of the antenna. Sometimes the use of a larger tuning condenser will do the trick. However, because the effective capacity of the whole circuit is limited by the capacity of the antenna, this does not help as directly as an increase in the coil would.

The tuned, secondary circuit consists

of the secondary coil L_2 and the secondary tuning condenser C_2 .

This is a simple closed circuit the tuning range of which depends almost entirely upon the size of the coil and the condenser. Forty turns of No. 22 DCC on a three-and-a-half-inch tube as the coil will ordinarily work quite well in connection with a variable condenser of .0005 mfd. maximum for C_2 . In making this coil you should tap it at the tenth, twentieth (midpoint) and thirtieth turns so that the detector connection may be attached, as will be described later. It may be that your present receiver contains the parts necessary for this secondary circuit. Some sets have a coil and a variable condenser in series with it for tuning the antenna circuit; and, if yours is one of these, you need only connect the antenna and ground binding posts together by a short piece of wire. Then, if the detector is connected across the coil within the set, your outfit will be like the secondary circuit of Fig. T, except that the lead from the detector will be connected to the left-hand end of the secondary coil instead of to the tap X.

Of course, your antenna and ground are to be disconnected from the set and connected to a separately tuned primary coil and condenser as described in the preceding paragraphs.

The detector circuit of Fig. T consists simply of the crystal detector itself, at D, an accumulating condenser of .001 or .002 mfd. (the size of this condenser is not particularly important) and the headphones.

The detector is not connected across the entire secondary coil, but instead its upper lead-wire runs to a tap on that coil as indicated at X. Ordinarily about half-way down the coil there will be the best average position for this tap, but, if still greater selectivity is desired in tun-

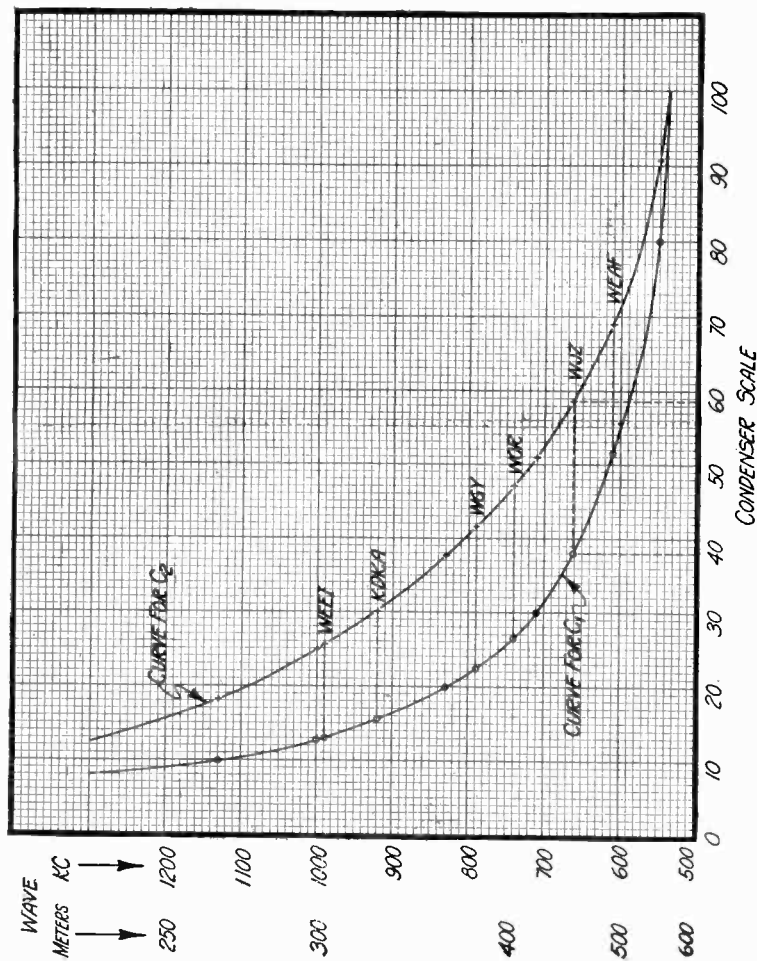

TUNING CHART FOR A SIMPLE-COUPLED RECEIVER

Figure V: The settings for any station may be found from this curve. For instance: WJZ at 660 kilocycles (455 meters) will tune at 39 on the primary and at 58 on the secondary. It is most convenient to plot these curves in kilocycles, as they are expressed in tens.

ing to strong signals, less than half the turns may be included between X and the right-hand end of the coil leading to C_3 . The greater the number of turns you place between X and the right-hand end, the louder the signals may be, but you will obtain less selectivity. Under some conditions the use of the midpoint tap will give not only greater selective power but also louder signals than a position for X including more turns in the branch circuit containing the detector. This, however, is a matter that must be determined by trial under your particular working conditions.

The only factor that remains to be considered is the coupling between the primary and secondary coils, which is indicated by the double-ended arrow marked K. This shows that the coils are intended to be relatively movable along the line of their common axis; you may fix L_2 in position and arrange L_1 so that you may slide it back and forth. It should be possible to move the coils together into the abutting or end-to-end position, or to separate them so that two or three inches of free space will separate their nearer ends. It is not necessary to make one coil slide within the other, as has been done in many old designs of couplers. Ordinarily the circuit will show very poor selective qualities with the coils in this position.

Having set up the circuit in accordance with the above suggestions, you will find it rather different in behavior from (and far superior to) the usual crystal receiver. To learn to use this improved receiver, it is well to begin with the two coils abutting and at a time when you are certain that several broadcasting stations in your neighborhood are transmitting. Also, you will need a test buzzer to make sure that your crystal is adjusted to a sensitive point. With the ordinary crystal set you will

hear something as soon as you start to adjust your detector, and, thereafter, turned adjustments will merely improve or hinder matters a little. With this outfit you should hear nothing unless your crystal is a sensitive condition and both your tuning condensers are properly set.

Therefore, begin by making your crystal respond strongly to the test buzzer, and slide the two coils close together. Listen in the headphones carefully, set the antenna or primary tuning condenser at 100 and then swing the secondary condenser slowly back and forth between, say, 60 and 100. If you hear nothing, set the primary condenser at 95 and search again with the secondary condenser. Continue to reduce the primary condenser in five scale-reading steps and swing the secondary condenser more widely through its scale as the primary setting becomes smaller. If your set is working and if there is any station that is transmitting within your range, you should "pick it up" without difficulty. Once you hear a station, find the best positions for both condensers and *write them down*. Try to get similar records for a number of stations throughout the wavelength range that your set covers. It may help you the first time you attempt to pick up these stations if you connect the detector across the entire secondary coil. If you have to do so, you should then tune for the same stations again and record the tuning settings when the midpoint tap X is used. You will be surprised by the improvement in tuning sharpness that the use of this X tap produces.

Having prepared a list of stations and their best tuning settings as above, mark it "K maximum" (indicating that it applies when the coils are as close together as possible—i.e., with the maximum coupling) and then go through the pro-

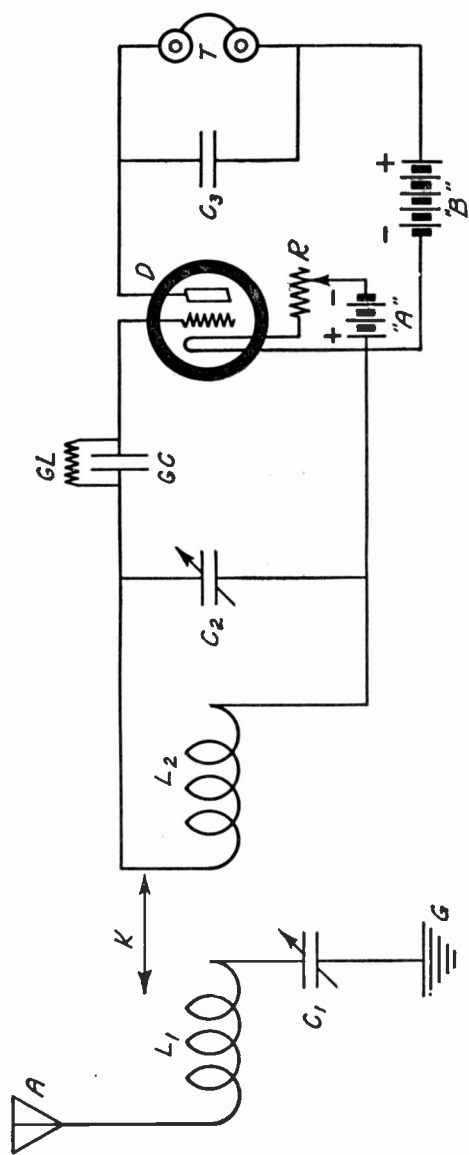

A SIMPLE VACUUM-TUBE HOOK-UP

Figure W: This is a type of selective circuit that employs tuned antenna and secondary circuits. If a WD-11 or WD-12 tube is used, the "A" battery need be only a single dry-cell and the "B" battery a small 22½-volt block.

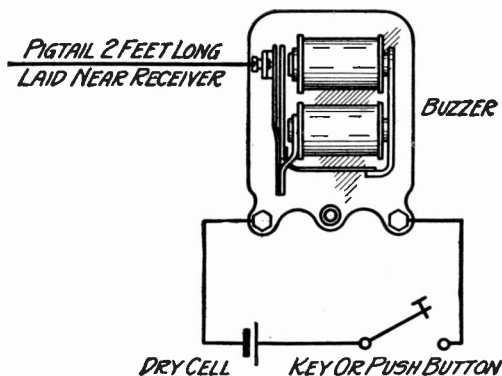

THE TEST BUZZER ARRANGEMENT

Figure X: An old electric door bell will perform the necessary work if the clapper is cut off and wired up, as shown above. When the buzzer is operated, an electromagnetic field around the pigtail will affect the receiving circuit; this effect will be heard in the headphones if the crystal detector is properly adjusted.

cess again with the ends of the two coils one inch apart. This will shift the tuning positions on both condensers somewhat, but the earlier records should be of considerable help to you in locating the stations under this new condition of looser coupling.

You will observe that the tuning will have sharpened up a good deal, and the signals in some cases may be a little weaker. Make a list of the settings for the several stations with "K one inch," for future reference. If this separation of the coils gives you adequate freedom from interference, you need experiment no further. You may find it worth while, nevertheless, to try a coupling distance of two inches or even more, and to reduce the number of turns in the detector portion of the secondary coil.

For your antenna and detector you will find some coupling and X tap position that give the best all around

results; and that is where you should conclude your tests. If you "log" the tuning settings for a number of stations under these conditions you can draw a tuning curve such as is shown in Fig. V, which will be of great assistance to you in locating the adjustments for other stations of which you know the wave-frequencies or wavelengths.

You will see at once that the foregoing instructions for operating a two-tuned-circuit receiver apply when you have built up the secondary circuit with a coil such as that described or when you are using the circuit of your old receiver as a secondary. You may have to use some ingenuity in mounting the antenna-circuit coil if you have utilized the old receiver, but this should present no real difficulty if you remember that it is to be arranged next to the secondary coil and with a common center line or axis.

It is perhaps not so obvious that the same general arrangement may be used

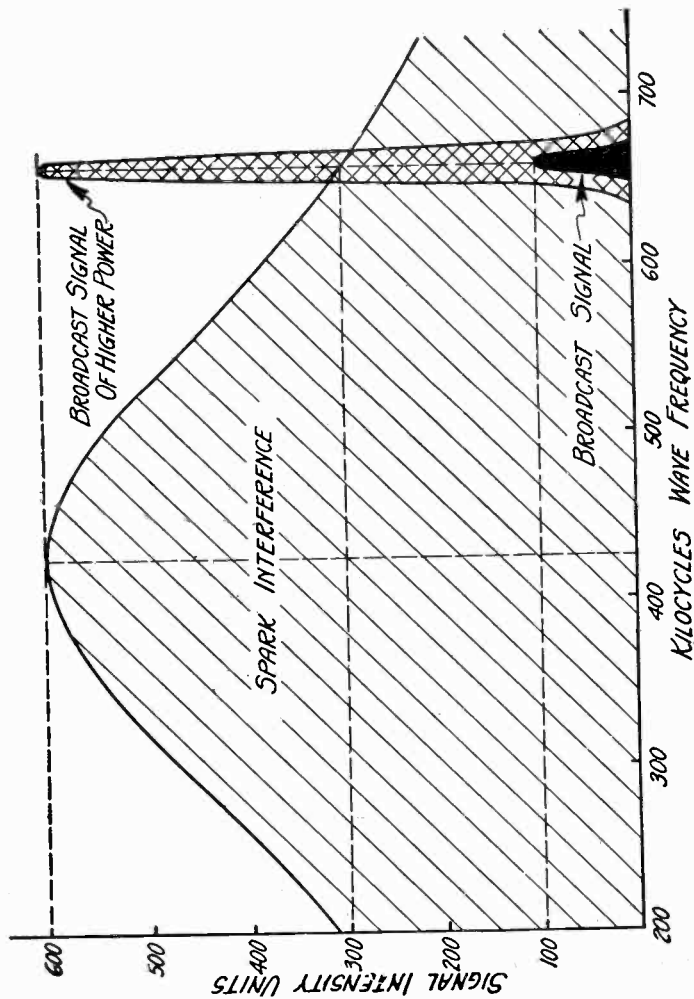

HOW HIGH POWER STATIONS CAN AVOID SPARK TRANSMITTERS

Figure Y: As long as the signal intensity of the broadcasting station is less than that of the spark set, interference will exist as shown graphically in the diagram. However, by increasing the intensity of transmitted signals as indicated above the broadcaster will break through spark "jamming."

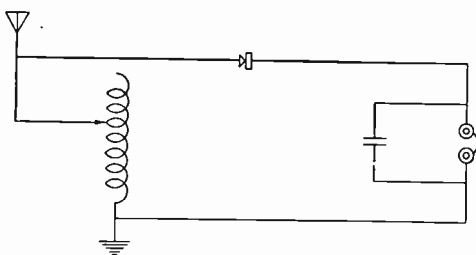

THE OLD-STYLE SINGLE-SLIDE TUNER HOOK-UP

Figure Z: Crystal sets wired in the manner shown in this diagram tune too broadly for satisfactory radio-telephone reception.

with a simple or non-regenerative vacuum-tube detector. The vacuum tube is two or three times as sensitive as the crystal, and requires no adjustment of contact points; consequently its use is often well worth while, even though it is more expensive and requires two sets of batteries.

Fig. W shows a very simple single-tube receiver circuit corresponding to Fig. T except for the change in the detector. The tap X has been left out, because the vacuum tube ordinarily does not affect sharpness of tuning in the secondary circuit as much as the crystal does; thus it becomes possible to connect its grid-filament circuit across the entire coil without much if any loss.

The principle of tuning and loosely coupling the antenna circuit may be applied to practically any receiver from the simplest crystal set, such as that described, to the most complicated superheterodyne. In most cases the change is well worth while, because of the freedom from spark interference and cross-talk that it gives, even though, as ordinarily applied, it requires the tuning of an additional condenser. With the large number of broadcasting stations

now in operation, and with the coming of higher powered transmitters, increased selectivity is particularly valuable.

It is feasible, moreover, to tune the antenna circuit at the same time and with the same motion that tunes the secondary or closed circuit by using equalized and simultaneously variable, double condensers. That invention (which I described some ten or twelve years ago in connection with commercial radio receivers) provides the ease of tuning that is characteristic of single circuits and besides the high selectivity of multiple-tuned circuits.

Interference with broadcast reception caused by spark transmitters was one of the topics that the Department of Commerce Conferences have studied with a good deal of care, and a number of recommendations have been made that should be directly helpful in improving the situation.

In increasing the number of wavebands or channels to be used for broadcasting, so as to allow the broadcast stations to operate with less mutual interference, the Conferences suggested a new grouping of wave frequencies and

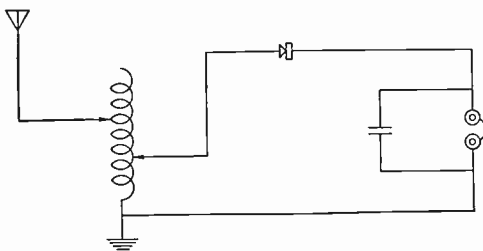

THE DOUBLE-SLIDE TUNER

Figure AA: The re-arrangement indicated in this diagram of a single-circuit tuner shows how selectivity may be improved whereby closer tuning for broadcasting can be accomplished.

a new classification of broadcasters, as shown in the table on this page.

Outstanding features shown by this

Frequency Cycles	Wave length Meters	Service
2,000,000 to 1,764,000	150 to 170	Amateur CW and ICW Radio Tele- graph
1,764,000 to 1,666,000	170 to 180	Amateur Radio Tel- e-graph
1,666,000 to 1,500,000	180 to 200	Amateur CW and ICW Radio Tele- graph
1,460,000 to 1,420,000	205 to 211	Class 3 Broadcasters (less than 100 watts power)
1,400,000 to 1,090,000	214 to 275	Class 2 Broadcasters (corresponding to old Class A)
1,070,000 to 550,000	280 to 545	Class 1 Broadcasters (corresponding to old Class B)
500,000	600	Marine calling and distress signals

tabulation, and features that are bound to help out our recent troubles from spark and other wave-interference, are the following:

1. The amateurs have agreed to eliminate spark transmission, thus freeing the high-frequency end of the broadcasting range of waves from this interruption.
2. The amateurs have agreed to restrict their radiotelephone experiments to the band between 1,666 and 1,764 kilocycles (170 to 180 meters) to aid in removing this sort of interference from the broadcast range.
3. The marine interests have agreed to stop the use of the old 1,000 kc (300 meter) and 666 kc (450 meter) waves, which caused so much trouble in broadcast reception.
4. The marine interests have agreed to use the 500 kc (600 meter) wave, adjacent the broadcast band, for calling and distress purposes only. Ship-and-shore message traffic will thus be handled upon the new lower-frequency channels more remote from the broadcasting waves.

It is only natural for all of us to hope that these various recommendations and agreements of the Conference can be put into practical operation at the earliest possible date. They are likely to

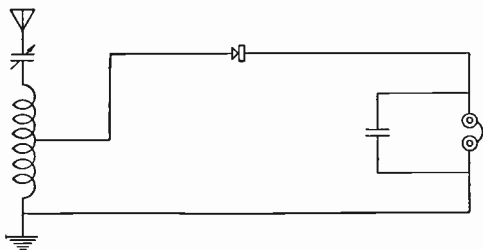

**A VARIABLE CONDENSER USED WITH THE
ELEMENTARY SET WILL HELP FIGHT THE
SPARK**

Figure BB: Introducing capacity in the antenna circuit as shown above will enable you to improve tuning with a single-circuit crystal set.

produce an immediate improvement in broadcast reception, though of course no one expects any or all of them to prove itself a perfect panacea that can overcome all difficulties. It still remains for us to do everything we can to improve the selection or discrimination power of our radio receivers, for unless we do our utmost in that direction we may expect to suffer interference from spark transmitters even under the new wave assignments.

You may wonder why the changes in working wave frequencies will not be sufficient to prevent the occurrence of such interference. It seems entirely unreasonable to many people that they should be disturbed, in receiving broadcast speech or music, by dots and dashes sent out at what appear to be widely different wave frequencies. For instance, even a reasonably selective receiver can take programs from WJZ (New York) on the 660 kilocycle wave without interference from WEAJ at 610 kc or WNYC at 570 kc. The frequency-differences are 50 and 110 kc respectively. Yet this same receiving set, while tuned to WJZ, may be badly interfered with by a ship at sea operating

at the nominal wave of 425 kc (706 meters), differing from WJZ's wave by 215 kilocycles!

Whereas a modern continuous-wave (CW) or interrupted-continuous-wave (ICW) radio-telegraph transmitter will work within a waveband less than one or two kilocycles wide, and produce little or no interference in receivers sharply tuned outside of that band, the old spark transmitter may spread out its signal splashes over all wave frequencies within a few hundred kilocycles!

Thus, a CW transmitter working at 405 kc can hardly be heard, if at all, in a good receiver tuned below 404 kc or above 406 kc, even though the receiving point is located relatively near to the sending station. On the other hand, a spark station having high damping might be heard, in the same receiver, on all settings from 200 to 700 kilocycles.

Some of you are perhaps now wondering why the radio art tolerates such inefficient use of the "ether" as is necessary when spark transmitters are permitted to operate. The answer is that the spark installations were in existence and were doing fairly satisfactory work long before the demand for more and more radio

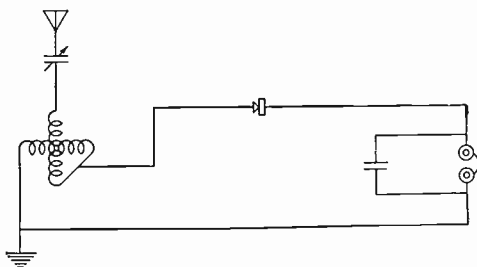

THE ADDITION OF A VARIOMETER WILL GIVE GREATER REFINEMENT FOR TUNING

Figure CC: The crystal set that is used with a variable condenser and variometer wired as in this diagram will meet ordinary needs for reception from super-power stations.

channels became as acute as it is today. All of these old sets on shipboard represent a substantial investment, and the amount of money involved in replacing or converting them is no small sum. They are gradually being changed-over or scrapped, however, and some day we may expect to see them only in museums.

But in the meantime, as has aptly been pointed out, traffic in the radio channels can be no more effectively regulated or utilized than could traffic on a boulevard where huge juggernauts fifty or a hundred feet in width were allowed to plunge along at will. We shall have spark transmitters with us for years, however, unless somebody loses patience with their propensity to tear through the radio channels, and, over the protests of their owners, legislates them out of existence.

What can we do in these spark-ridden years, then, to make the interference as little as possible? Is there anything that will help us to receive broadcast programs free from dot-and-dash interruptions?

Fortunately there is. We may take

advantage of the third and fourth factors of the problem (as outlined on a previous page of this Part). We may improve the excluding-power (or sharpness of tuning) of our receivers; and we may improve the intensity of the broadcast signal we desire to receive, as compared to the intensity of the interference.

The first of these items—the improvement of receiver selectivity—cannot cure the spark evil.

That is true because the spark station distributes its power all over a vast number of wave-frequencies, and, if you are at all near to the spark transmitter you will be likely to pick up some interference on any broadcasting wave no matter how sharply you tune to it. Nevertheless, there are some features of this interference problem that appear to have been overlooked in many quarters and yet which offer some hope to us.

Most broadcast receivers do not exclude interference from powerful, nearby stations even though they are capable of discriminating sharply between waves from distant stations. There is vast room for a general improvement along these lines, and it is this type of improve-

ment that will be helpful in cutting out spark interference. Incidentally, gains in this direction will also be valuable in reducing interference from "static" or strays, and from nearby radio telephone stations.

The second point of attack on the spark interference problem is one which the listeners can help only indirectly. It consists simply of increasing the power of broadcasting stations.

This is by far the most certain way to overcome all kinds of interference, as has been demonstrated again and again in all branches of the radio field. Years ago transatlantic radio telegraphy was attempted with transmitter powers as small as five kilowatts. Even with such small power signals were received at great distances, but only under the quietest and most favorable conditions. By increasing the power of the transmitters to as much as two hundred kilowatts the received signal was made six or seven times as loud, so that it could be distinguished through whatever part of the interfering noises could not be filtered out in the receiving apparatus.

The best broadcasting stations are using, on the average, something over one-half kilowatt of power. At distances of even fifty or one hundred miles the signals from such stations are often too faint to be heard clearly through interfering noises. To be sure, conditions are sometimes so good that the stations are heard over thousands of miles, but we must all admit that such long distances represent exceptional and not average day-and-night, summer-and-winter, performance.

Let us suppose that some particular evening you are receiving from a moderately distant half-kilowatt broadcaster whose signal may be said to have a strength of 100 units in your receiver. Now imagine that an interfering spark

"breaks through" with a received intensity of 300 units. Of course your reception will be spoiled. If, now, the broadcast station could quadruple its power, making it two kilowatts, the signal would be doubled to 200 units. This would still be too weak to be heard above the interference of even a few local spark transmitters.

But if the broadcast plant could be increased to twenty kilowatts, the received signal would rise to over 600 units in strength and would dominate the interference.

This is such a simple and positive way of overcoming many interference troubles that one wonders that it has not been more generally applied. The reason is probably that twenty kilowatt radio-telephone stations cost more than half-kilowatt plants, just as the big electric stoves used in some hotels cost more than household electric toasters. The hotel stove may use twenty kilowatts of power; the toaster uses about half a kilowatt. It is certainly high time that radio broadcast stations got out of the toaster class, so that their signals might override much of our present-day interference. It is profoundly to be hoped that more powerful broadcast stations will soon come into operation, and you can do a part toward advancing the art by encouraging such larger plants.

Having reviewed the possibilities in this direction, let us return to the matter of receiver selectivity and see what can be done to gain some freedom from interference by that means.

Of course there are all kinds of radio receivers in use for listening to broadcasting, and the various kinds have varying degrees of selectivity. Lowest on the list is probably the single-tuned-circuit crystal set, and since this is doubtless the least selective outfit in

common use, let us first find out what can be done to improve it.

If the receiver consists simply of a coil of wire connected in variable amounts (by a multiple-point switch or a sliding contact) between antenna and ground, and having the crystal, telephones and accumulating condenser shunted across the entire portion of the coil that is in circuit, we can do a good deal to improve matters. Probably the most effective step would be to connect the side-circuit containing the crystal and condenser across only *half* or even less of the active part of the coil.

Further improvement would be had, though probably less in amount, by cutting out the switch or sliding contact and putting a variable condenser in series between the entire coil and the antenna. This variable condenser would then be used for tuning. A still better arrangement would be a condenser and a variometer in series between antenna and ground, with the crystal side-circuit tapped across only half of the variometer.

This marks about the limit of what can be done with a single-tuned-circuit and crystal detector, though in any event it is a good plan to be sure that there are no insulation leaks or high-resistance joints in the antenna-to-ground circuit. Signal strengths in a receiver have often been doubled or trebled by the simple plan of scraping bright and re-splicing every connection in the circuit.

A considerably greater degree of freedom from spark interference can be had by converting the single-tuned receiver into one using two tuned circuits.

Since the adoption of the new wave-frequency (or, in the old phrase, wavelength) allocations for broadcasting, the number of transmitters that can be

heard by any receiving station has been substantially increased.

Under the former plan the transmitters were licensed to work at only two wave-frequencies—833 and 750 kilocycles a second (corresponding to 360 and 400 meters wavelength). If the broadcasters had lived up to the regulations no one would have been able to receive from more than two stations, one on each wave, at any one time. As a matter of fact it was found that so much interference developed when only the two waves were used that the station managements gradually tuned their transmitters to waves a few kilocycles either side of the specified frequencies. This practice, together with the division of operating hours among the numerous senders that desired to transmit in each locality, helped out the situation a good deal. Despite the fact that it resulted in two groups of stations, the larger group operating in the neighborhood of 833 kc and the other clustering about 750 kc and even though the waves were chosen more or less at random, the shifting away from the authorized wave-frequencies made possible what little choice of broadcast programs was enjoyed by radio listeners in the past.

Some novice listeners have complained that the wave-frequencies of the various stations are too close together and that it is not possible to hear programs from one station without simultaneously picking up music or a speech from other broadcasting plants.

These complaints have come only from listeners whose receiving sets are poorly designed or poorly manipulated.

It has been proved that receivers of only average selectivity, adjusted with only normal care, are fully capable of discriminating between various broadcasting waves that are said to interfere

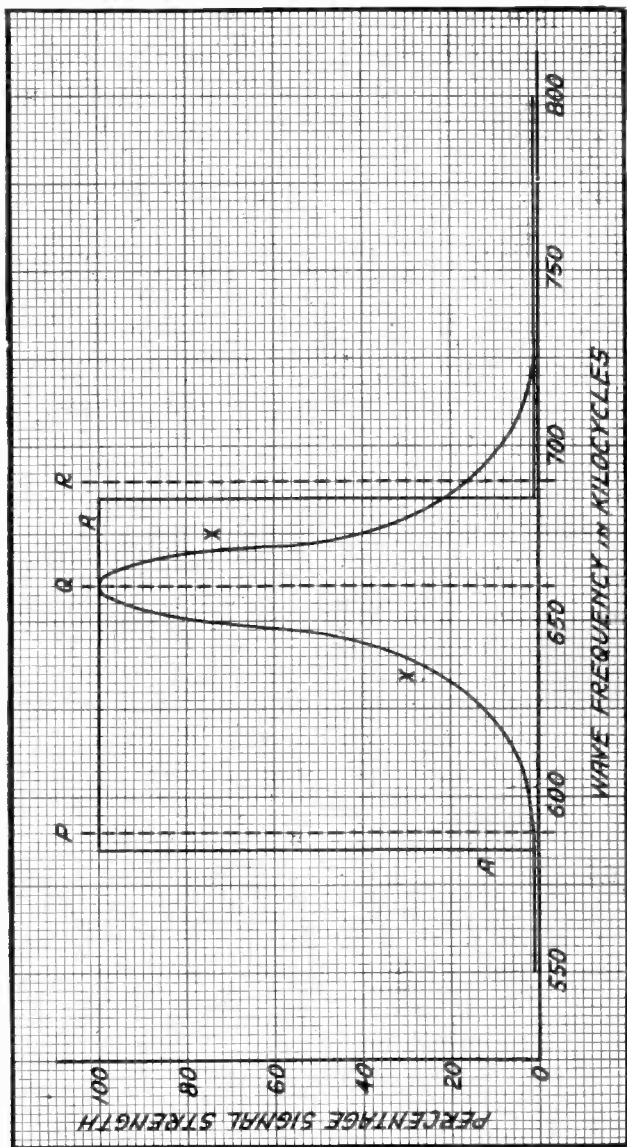

A WAVELENGTH-SIGNAL-STRENGTH CHART

Figure DD: The author's frequency-signal-strength chart which he uses to explain how a selective receiver and a broadly tuned receiver would act in regard to interference elimination.

with each other. If you are having trouble in picking out the station you want to hear, and in listening to that station alone, don't blame the wave assignments. Bear in mind that thousands of other people are having no trouble at all, and get busy on your receiver. Make it as highly selective as you can and enjoy the choice of programs that you will be able to get in that way.

Some of your neighbors (and probably a good many of them) have found that by sharp tuning they can hear any one of twenty or more stations at a time of "good nights" this season; last winter they were lucky to be able to choose more than five or six.

Let us look more closely into this matter of receiver selectivity.

The term is almost self-explanatory, it means the ability of a radio receiving outfit to select signals transmitted on one frequency of carrier wave from other signals that are simultaneously being sent out on waves of other frequencies.

Suppose we made a chart of some of the broadcasting wave-frequencies as in Fig. DD, where the different values are arranged along a vertical scale. In this figure, the localities to which the various wave-frequencies have been assigned are indicated, as well as the corresponding wavelengths in meters.

Toward the right-hand side Figure DD is drawn a heavy vertical line, marked AA, with an opening equivalent in width to 100 kilocycles. Imagine that this line represents the barrier set up by your receiving tuner; that no wave energy can get through at the frequencies opposite the line, but that the wave-frequencies opposite the opening can get through to operate your telephones. From the diagram it is quite

clear that a receiving set which admits a 100-kc. band (or continuous group) of wave-frequencies could simultaneously pick up signals from two of the New York stations, from Philadelphia, from Washington at 640 kc. and (if the signals were strong enough) from Pittsburgh, Chicago and a few others. This assumes that the particular set be located in the east; if it were on the west coast, it would simultaneously admit signals from San Francisco, Los Angeles and Portland.

Following the diagram's teachings a little farther we see that even a receiver so non-selective as this could choose between three New York stations at 610, 660 and 740 kc. Although in the position shown it admits both 610 and 660 kc. by turning the tuner controls to give resonance to the lower frequencies (which would have the effect of lowering the opening in the line AA) the 660-kc. wave could be cut out. By raising the admitted frequencies 40 kc. above the illustrated values, 610 kc. would be cut out but 740 kc. not yet admitted. On the other hand, so broad a tuner could not be effectively used with a very sensitive detector and amplifier, for the increased responsiveness of the receiver would bring in interference from the more distant stations.

Here we have the crux of the whole tuning situation. Your receiving tuner *must be more and more selective the more sensitive your detector and amplifiers, or the farther you desire to receive.*

If you are in the vicinity of two or three broadcasting stations that use well separated wavelengths, and if you are satisfied to limit your reception to those stations, a relatively dull detector (such as a crystal) and a tuner with 100 kc. selectivity may be all you need

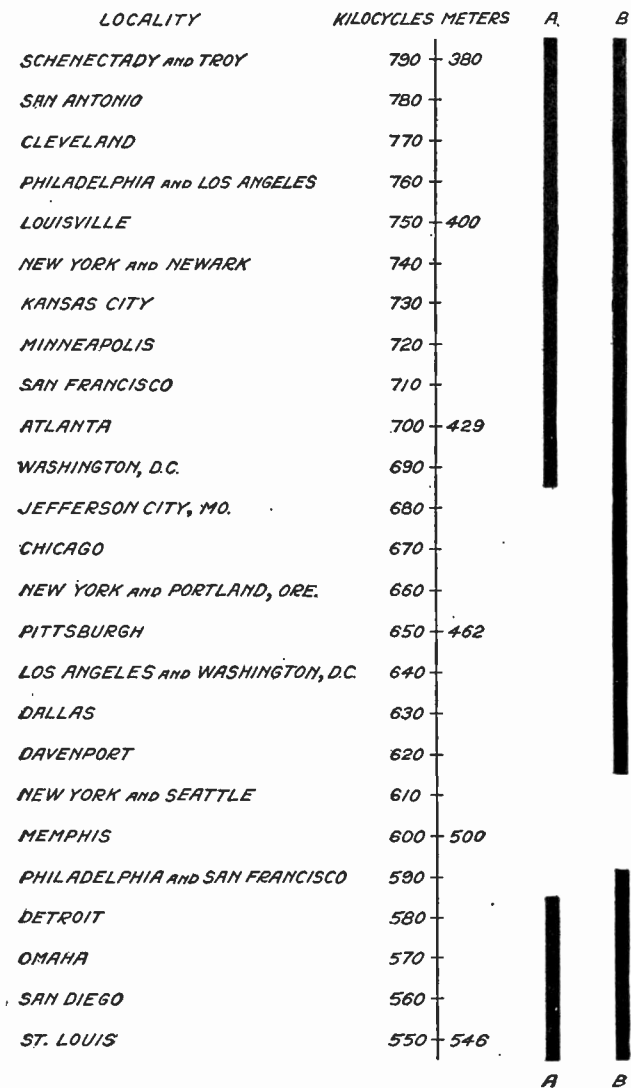

Figure EE: This chart shows how a broad-tuning set would include the signals of a number of stations at one time while the sharp-tuning set would get only one or two. The small gap in the dark heavy line at the extreme right of the chart would include only New York, Memphis and Seattle. This line is for a sharp tuner. The large gap in the second heavy line includes everything from Jefferson City to Philadelphia and San Francisco; this line is for a broad tuner and considerable interference would be experienced.

If, however, you want to reach out with amplifiers so as to hear Omaha, Detroit, Philadelphia or other stations whose wave-frequencies are not very different from each other, you will have to match your sensitive detecting system with a highly selective tuner.

You can see at once that the narrowness of the opening in the line AA (Fig. DD) is a measure of the receiver's selectivity. If this opening is made more narrow, say to a width admitting only a 20-kc. range at one time, as in BB, the receiver sensitivity may be greatly increased without bringing in interference, because the selectivity of the tuner has been much increased. With a tuner that would exclude all but 10 kc. at a time, one might use a sufficiently sensitive amplifying system to pick up any of the broadcasting stations in the United States without experiencing interference from any of the others. It is feasible to build receivers having even more than this extreme degree of selectivity.

The chart of Fig. DD is based on the assumption that the receiving tuner will admit freely, and with equal facility, energy received on any of the wave-frequencies that fall opposite the opening in the line AA but that at the end frequencies of this admitted band the tuner will cut off sharply so as not to admit any energy from waves outside the frequency limits marked by the opening. It is possible to build receivers that have practically this sharp cut-off characteristic, but the ordinary tuners that depend upon simple circuit resonance for their selectivity have a gradual or tapered cut-off on each side of a single frequency that they receive best.

Fig. EE compares these two characteristics, here the frequency scale is drawn horizontally and the vertical scale represents the percentage response that

the receiver would give to a signal of some definite intensity at all of the wave-frequencies illustrated.

In Fig. EE the square-shaped line marked AA corresponds to the barrier line and opening similarly designated in Fig. DD and represents a receiver that admits a 100-kc. wave-band with sharp cut-off at each end. It is easy to see that, at the setting illustrated, a wave of frequency 590 kc. (as used by some of the Philadelphia stations and indicated by the vertical dash line P) will produce 100-percent signals. A wave of frequency less than 585 would produce no response on account of the sharp lower cut-off. A wave of 660 kc. (used by WJZ in New York and shown at line Q) would give 100-percent response, but 690 kc. (Washington; line R); would be above the upper cut-off and give no signals.

Now look at the curve XX in Fig. DD, which shows the selection characteristic of an ordinary but reasonably good receiver. When set to give a maximum response to 660 kc. (line Q, as shown) signals on carrier frequency 690 kc. (line R) would give only about 15 percent full response, while other signals of 590 kc. (line P) would produce practically no sound in the telephones.

We might make a table showing the best signal strength that would be received by such a tuner for various differences of wave-frequency, using this resonance curve as a basis:

Difference from Resonant Frequency	Percentage of Resonant Signal
0	100
10	80
20	25
30	15
40	10
50	5
60	3
70	0

From such a table we can see just

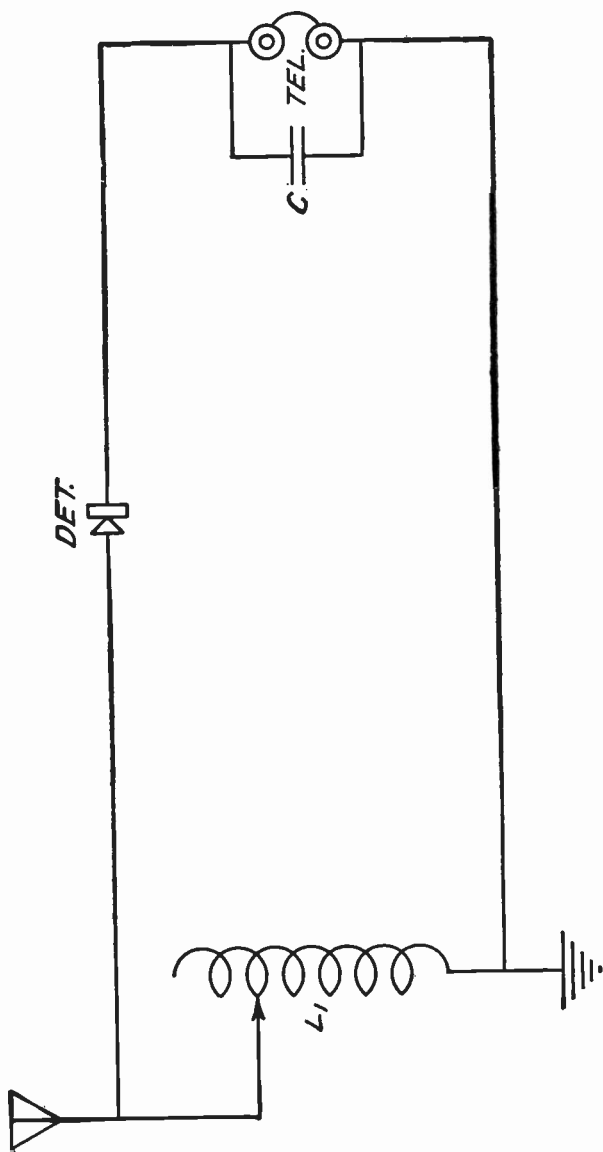

THE CONVENTIONAL SINGLE-CIRCUIT CRYSTAL RECEIVER

Figure FF: Many beginners who have this type of simple set are experiencing trouble with interference. The author tells us that the trouble may be lessened if not eliminated by changing over this circuit to the circuit shown in Figure HH.

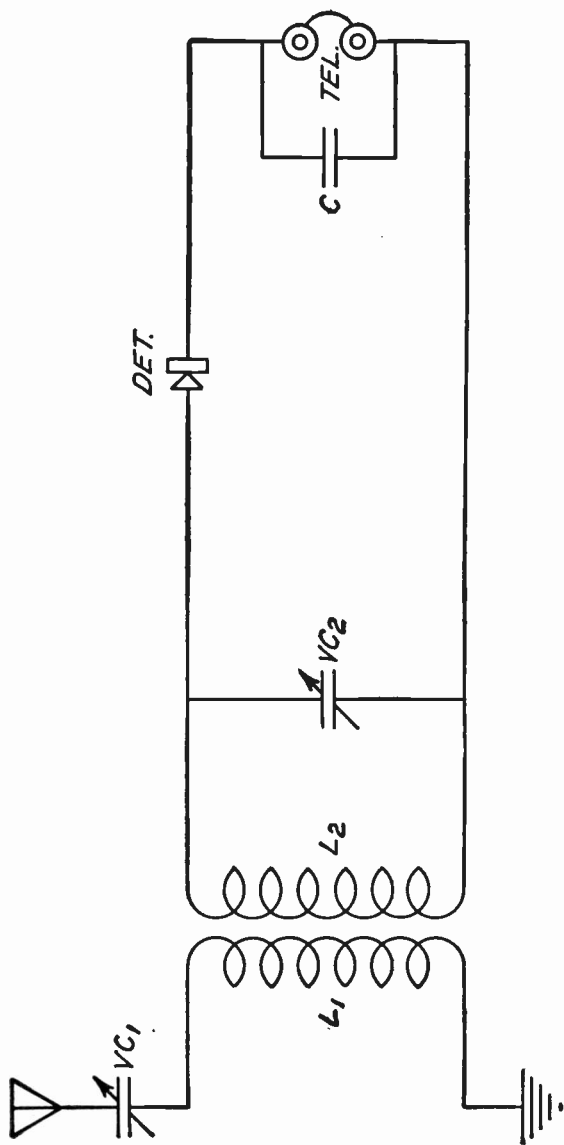

THE INDUCTIVELY COUPLED CRYSTAL CIRCUIT

Figure GG: This is the best crystal circuit to use from a standpoint of selectivity. It is even better than the hook-up shown in Figure CC.

what to expect in the way of freedom from interference. For instance, if instead of tuning to 660 kc. as shown, you adjusted to New York (WEAF) at 610 kc., the energies of signals from other stations would be as follows (New York being rated 100 percent because tuned to its maximum):

Memphis and Davenport—80 percent of their maxima.
Dallas and Philadelphia—25 percent of their maxima.
Washington and Detroit—15 percent of their maxima.
Pittsburgh and Omaha—10 percent of their maxima.
New York (WJZ) and San Diego—5 percent of their maxima.
Chicago and St. Louis—3 percent of their maxima.
Jefferson City and others—0.

Note that these relative signal strengths are given as percentages of the loudest possible signal your set could receive from any particular station, and that each percentage refers to the signal from the station in question and that only. In other words, this above table will not show the relative signal strengths in comparison with the signal from some one stations, such as the one to which the set is tuned. To get this information we must combine with the above figures another tabulation giving the *relative* signal strengths of the station in question. One or two examples will show how this can easily be learned and applied in the practical operation and control of radio receivers.

Suppose that with your receiver, under some particular condition, you can hear New York (WEAF) with intensity 100, New York (WJZ) with intensity 60 and Philadelphia (WIP) with intensity 20. If your tuner has the selectivity characteristic of curve XX in Fig. DD, can you expect to hear Philadelphia without even the faintest

interfering signals from either New York station?

To find out the answer we need only note that Philadelphia's wave-frequency is 590 kc and those of the New York stations 610 kc. for WEAF and 660 kc. for WJZ. The differences are 20 kc. and 70 kc.; if the receiver is tuned to WIP, the desired signals will be received at full 100-percent intensity or 20; WEAF's signals, being 70 kc. removed, would not be heard. But WJZ's signals, only 20 kc. away from WFI's would come in at 25 percent of their full strength of 60, or at 15 which is three-quarters as loud as WIP. Consequently WJZ would interfere with WIP under these conditions, and a more highly selective tuner would be required to receive signals from this particular Philadelphia station without interference.

What can one do to increase selectivity so that such interference can be prevented? The details of all the answers to that question would be enough to fill the space of several articles such as this, but we can at least set down some of the high spots:

1. If you are using a crystal detector with single-circuit receiver (the ordinary form of which is shown in Fig. FF), change over to the double-circuit receiver of Fig. GG. If you cannot do this, at least tap the detector circuit across only a *part* of the inductance coil as in Fig. HH.

2. If you are using an ordinary vacuum-tube detector, in a non-regenerative circuit, change to a good regenerative circuit, and preferably one which is coupled inductively to the antenna (as in Fig. II).

3. If your interference conditions are too severe to be overcome by a circuit of the type represented by Fig. II (a very unusual state of affairs), use a loop

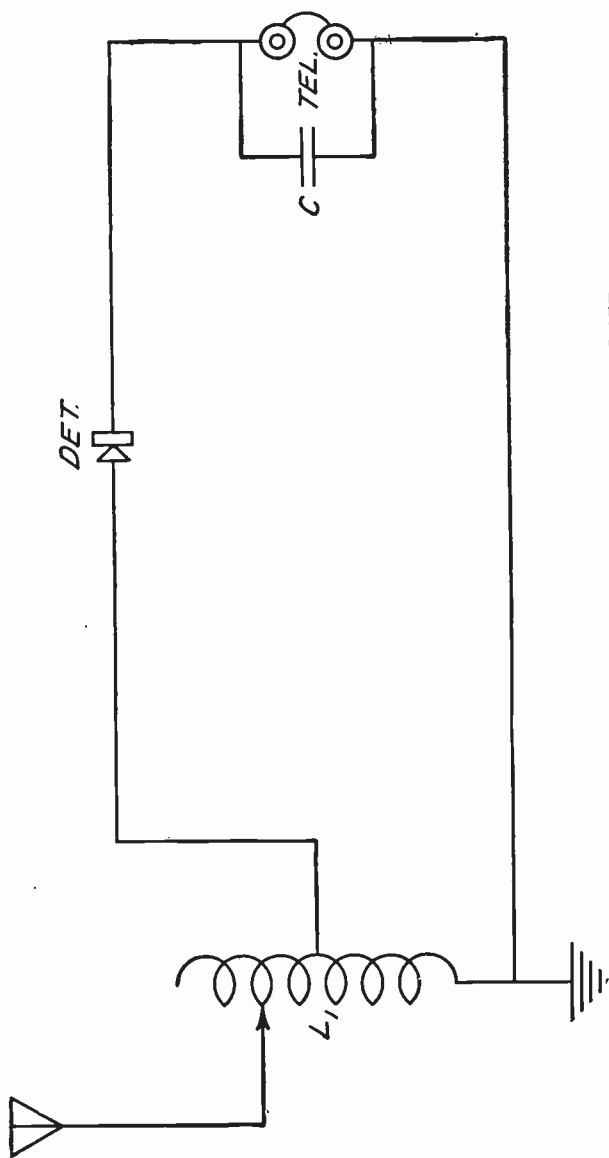

A DOUBLE-CIRCUIT CONDUCTIVELY COUPLED CRYSTAL SET

Figure HH: By using only a small part of the coil L_1 for the secondary circuit which contains the detector and the telephones, the selectivity is increased to a considerable extent over that obtained by the circuit in Fig. FF.

antenna with *tuned* radio-frequency amplifiers and regeneration, or, perhaps still better, with a super-heterodyne receiver.

Above all things, bear in mind that as much skill is required to operate a highly selective tuner as to drive a car through the heavy traffic encountered in a big city.

Don't expect to become expert in handling the tuner any sooner than the car. It is easy to pick up and enjoy programs from the local stations—as easy as it is to run a phonograph—but practice and patience are required to learn to hear all the available distant points through the local interference. But don't let that fact discourage you; you can do what others are doing, with a little perseverance, in really learning the facts about tuning.

If your object (or one of your objects) in radio receiving is to "get distance," get the most highly selective tuner and the most sensitive detecting and amplifying system that you can handle effectively, and work with it until you learn the tricks of manipulation. Your effort will be well repaid, and you will find that the new schedule of wavelengths makes these great results possible.

You may remember that when alterations that occur in the wave frequency are of substantial amount and that when they occur at a rate that is in the low audible range (say from fifteen to thirty times a second), you will hear a fluttering noise in your receiver, from the carrier wave of the broadcasting station.

A nearly identical noise may, however, be caused by variations in the *intensity* of the radiated wave, as was pointed out previously. If, when you are listening to some particular station, you hear such a noise between the

"numbers" on the program, your natural question will be: How can I tell whether this flutter is explained by frequency variations or by intensity changes in the radio waves?

You may also ask yourself whether or not the sound is the result of something going on in your own receiver, and therefore, whether it marks a defect for which you are yourself responsible.

Fortunately there are not many things that can happen in a radio receiver that will cause a fluttering sound in the telephones or loudspeaker. Furthermore, anything that does tend to make such a sound will probably have the same effect on all the signals you hear and is likely to keep on going even if no signals are being received. The logical thing to do, then, is to distinguish first between the home-made noises that may be produced by your receiver, and the transmitter-made noises that come in with the waves.

Let us suppose that when you are listening to some certain broadcasting station you hear a fluttering sound whenever the carrier wave is being received. It may be heard above and along with the speech and music that is sent out, or it may be so much weaker that you do not hear it except between the successive items of the program.

The first thing to do is to try detuning your receiver; that is to say, turning your tuning knobs (or one of them) a little away from the position where the signals are heard loudest. If the noise continues, you would be justified in concluding that it originated within the receiving set. To make sure, however, it is a good plan to disconnect the antenna so as to cut out the signals altogether; if the flutter is still heard you may be reasonably sure that something in the audio-frequency system is

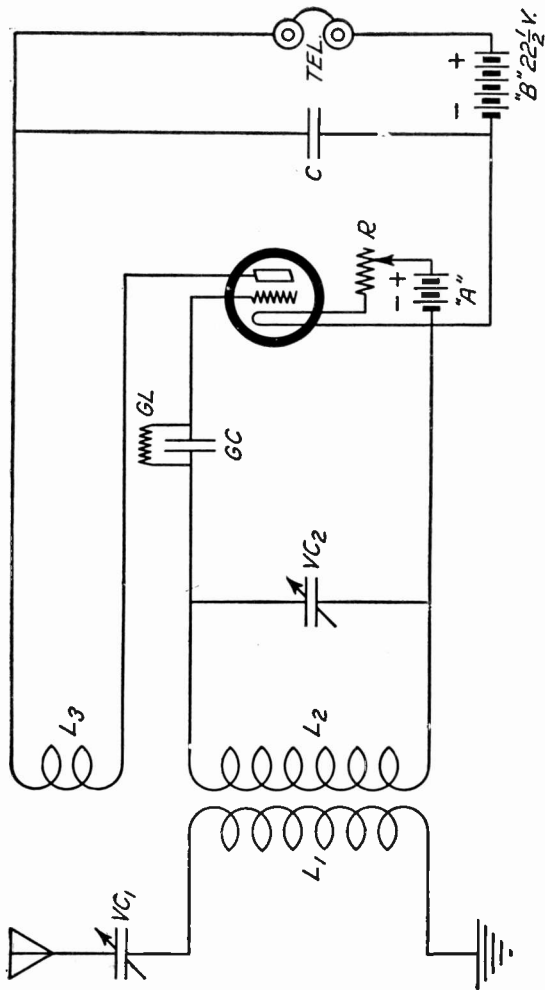

THE TRIPLE-CIRCUIT, VACUUM-TUBE, REGENERATIVE CIRCUIT

Figure II: By adding one more coil to your present single-circuit tuner you may greatly increase the selectivity and at the same time cut down re-radiation which is the most objectionable feature of the single-circuit hook-up.

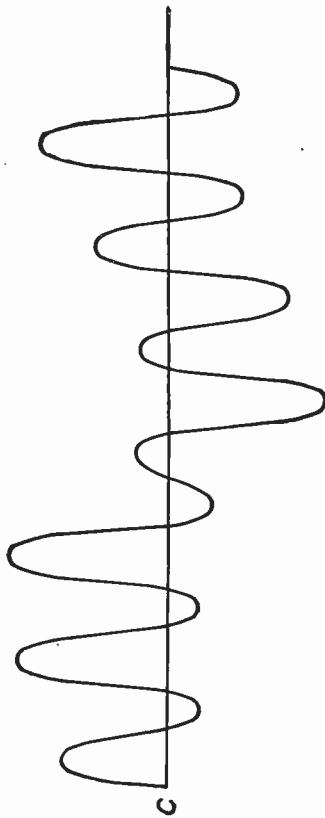
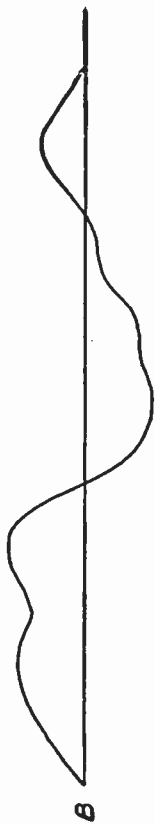
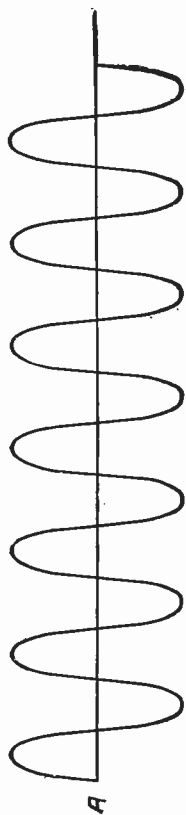

WHAT HAPPENS WHEN THE POWER SUPPLY IS NOT STEADY

Figure JJ: The upper curve A, shows the form of a perfectly oscillating wave. Curve B shows graphically the variations that sometimes take place in the voltage of the current supplied to the plates of the tubes. The lower curve shows the effect of this variation on the oscillating carrier wave.

wrong. Likely places for such trouble are in the amplifier circuit and sometimes in the grid-leak and condenser used on the detector tube.

On the other hand, the flutter may "tune out" with the signal, but change in pitch from a low note (or even a rattle) up to a high whistle, which gradually disappears as the pitch increases, while you detune. This is proof positive that your receiver is generating radio oscillations within its own circuits. It is very difficult to receive broadcast telephony satisfactorily under such conditions, and you should arrange matters so that the oscillations are prevented. To do this may require merely the change of position of one of the adjusting knobs, such as a "stabilizer," "intensity" control or "tickler," or it may be necessary for you to provide an additional adjustment.

Many home-made receivers (and a good many that are put out by the factories) insist upon oscillating at certain wavelengths and so prevent, or at least make very difficult, the proper reception of broadcasting.

One of the simplest and most effective cures for this trouble is to connect a variable and moderately high resistance directly in series with the ground lead, and then to "cut in" enough of this resistance to overcome the set's tendency to oscillate. A standard potentiometer of 200 or 300 ohms is often useful for this purpose (see Fig. KK). The trouble is most likely to occur in receivers that have radio frequency amplifier tubes, and is particularly common in reflex sets.

There is a third possibility which also indicates that the trouble is in your receiver. This is, that although the flutter vanishes when you tune out the station to which you began to listen, it comes in again in exactly the same way

whenever you tune to any other station. If the coming and going of the fluttering sound is accompanied by changes in pitch, as just described, it means that your receiver is oscillating. If the flutter does not change in character or sound, but merely in intensity, and if it appears whenever you listen to any broadcasting station, there is something wrong with your receiver. Whatever causes this kind of flutter will probably be in the radio-frequency circuits, as your tests will have proved that it requires the presence of radio currents to produce the sound. However, such effects are both rare and obscure, and no diagnosis that could be given without inspecting this kind of flutter set would be likely to be helpful. I mention the phenomenon with the idea of eliminating all the things that may occur in the receiver, so that you may have confidence in your observations if they point to a defect in the arriving wave.

And, so, we come to the situation where (1) the flutter tunes out when the wave from the particular broadcasting station you are investigating is tuned out, (2) the flutter does not turn into a whistle as it is tuned out, and (3) it does not reappear as you tune to the waves from other stations.

Under these conditions it is a fair conclusion that the irregularity that produces the sound exists in the carrier wave, and that it has its origin outside of your receiving station.

Your next problem, if you really want to know what is wrong, is to find out whether the noise is caused by frequency changes or by intensity changes in the wave. If the fluctuations are small there may be some difficulty in doing this, but the test is so simple that it is worth trying in any event.

If the frequency of the incoming wave changes from instant to instant, it

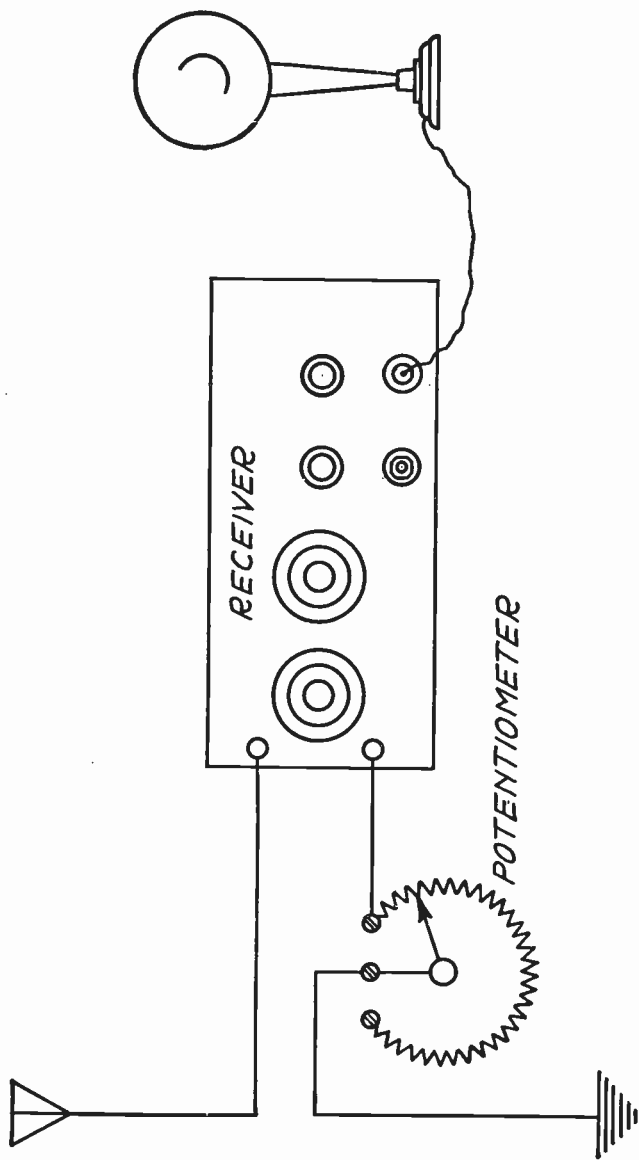

HERE IS A WAY TO STOP YOUR RECEIVER FROM SQUEALING
 Figure KK: A variable resistance of 200 or 300 ohms (an ordinary "A" battery potentiometer) connected in series with the ground lead can be adjusted to prevent the tendency of the receiver to oscillate on certain wave-lengths.

is evident that a sharply-tuned receiver will not hear all of the wave all of the time, so to speak, at any one tuning adjustment. To hear the station at full intensity at every instant, it would be necessary to change the tuner settings continuously so as to follow the variations in wave frequency. The general effect of such fluctuations is, then, to broaden the range on the tuner throughout which the signals are heard.

By comparing the broadness of tuning, or the number of degrees you may turn the tuning dial away from the loudest position without completely cutting out the station, you can get some information as to the constancy of the wave frequency.

If you take as a standard some other station whose carrier wave does not flutter, and which you hear at approximately the same intensity as the plant you are studying (and which preferably has approximately the same wave frequency) you may find, for example, that the signals tune out when you move the dial about three degrees away from the maximum setting. If, then, you find that equally loud signals from the station having the fluttering wave persist when you move the tuning dial six or eight degrees from the best setting, it is a good indication that the wave frequency of that transmitter is varying.

On the other hand, if both the standard and the fluttering waves tune out in the same way, the probabilities are that the noise is caused by intensity variations. In either case you should write to the manager of the broadcasting station that is sending out the noisy wave and tell him of your observations; he can check them up himself, and thus determine the possibility of improving his transmitter.

There are two other possible causes of flutters in the received carrier wave,

and as neither of them can be blamed upon your receiver or upon the broadcasting station, they should be mentioned here. If a second broadcasting transmitter, perhaps more than a thousand miles away, happens to be sending out a wave that is within a few cycles of the wave to which you are listening, the two will beat together. The beat will not produce a musical tone if the two frequencies differ by less than about 16 cycles a second, but it may cause exactly the sort of flutter we have been discussing. Such conditions are rare in practice, and should never occur except at the 833 kc. (360 meter) waves of the class C stations, for the Department of Commerce is doing its utmost to prevent undue duplication of wave frequencies among broadcasters. Occasionally a transmitter may get so far out of adjustment as to cause this effect, but the chance of striking so closely the frequency of another station is exceedingly remote. If you should hear two stations making low-frequency beats of this kind it is likely that you would find the wave frequency of either or both changing gradually while you listened, so that the flutter would drop out at one instant, come in again, change to a low musical note of varying pitch, return once more to a flutter, and so on. A condition of this kind should be reported to the broadcasting station whose signals are affected.

The second way that beat flutters may be made is by the reception, along with the signals you want, of waves sent out by an oscillating receiving set. The final effect is almost exactly the same as when you receive an interfering wave of the same frequency and intensity from a distant broadcasting station.

If one of your neighbors has a radiating receiver, and if, while it is in the oscillating condition, he tunes to the

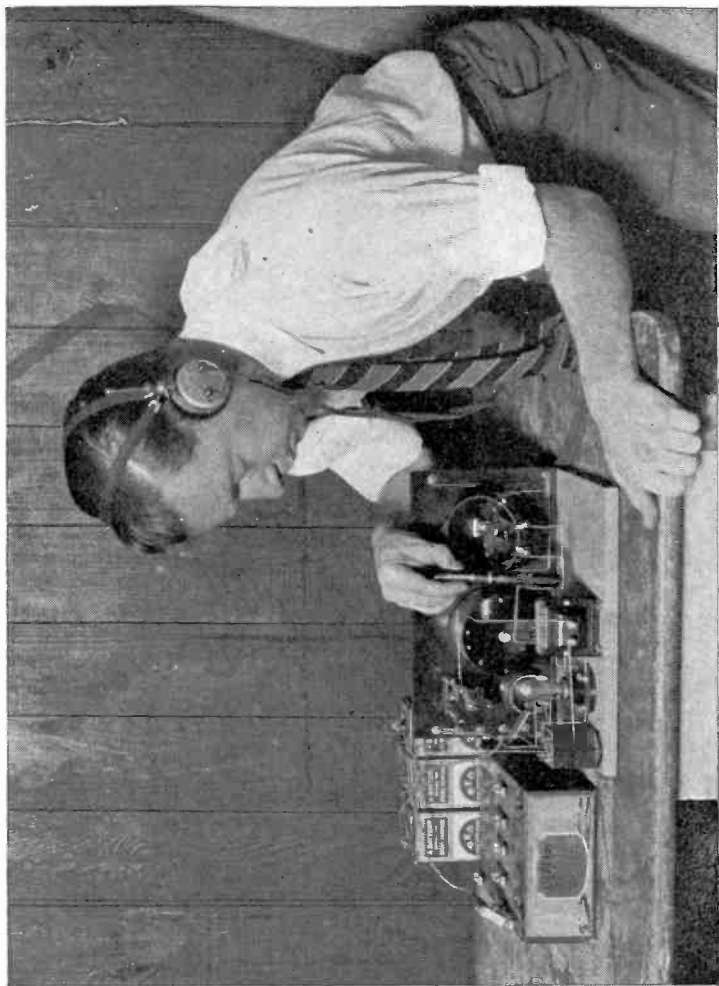

HOW TO SEARCH FOR POOR CONNECTIONS

Figure 11: With the antenna and ground disconnected, but the batteries hooked up and the phones on, it's easy to find a faulty connection. Press against each wire with the end of a hard rubber fountain pen or other piece of insulation and a grating or rasping sound will be heard in the phones when the poor connection is touched.

same station that you are listening to, radiation from his set will probably interfere with your reception. This is because, as has often been explained, any receiver that is so adjusted as to generate radio oscillations in its antenna circuit will act for the time being like a small transmitter.

Should your interfering neighbor tune his oscillating set to *exactly* the same frequency as the wave you desire to receive, you will *not* hear a beat flutter or note, but if he deviates from this exact frequency (or if the broadcasting station itself swings in frequency by even a few cycles), you will hear the fluttering sound that has been described.

Ordinarily you can tell whether such receiving interference is produced by a neighborhood "squealer" or by a distant broadcasting station, by observing the constancy of the beat note or flutter. It is unusual for a listener who uses a whistling receiver to leave his adjustments alone for more than a few seconds or at most a few minutes at a time. When he changes his tuner settings the beat noise will change correspondingly, usually turning into a musical note of gradually increasing frequency. When you hear such changes in the flutter you can be reasonably sure that the interference arises in your own vicinity, and that you will be repaid for making a tour among the radio listeners who operate sets near your home. Most of the people who allow their sets to give this sort of trouble do so through inexperience or lack of appreciation that they are interfering with other people's reception, and it is ordinarily not difficult to build up a co-operative spirit among a group of closely adjacent listeners that will permit all to receive without such bothersome interruptions.

We have now considered most of the phenomena that are likely to occur as a

result of frequency variations, either slow or rapid, in either the transmitters or the receivers; we have also looked into the possibilities of distinguishing between these various effects, so that any listener can find out whether the source of his disturbance lies in his own receiver or at a more distant point.

The next topic is that of noises produced by intensity variations either in the wave or in the response to the received signals.

If you hear unwanted noises while you are listening, the first thing to find out is whether they are produced by a defect in your own set or whether they come in with the waves. Much the same plan as suggested above for detecting frequency variations should be followed; if you hear the noises at all settings of your tuner, or if they continue when you disconnect your antenna, it is almost certain that something is wrong in your apparatus. Bothersome sounds of this sort, which persist even when no signals are coming in, can often be traced to poor connections in the set. If you bump your receiver with your hand while listening in the telephones, you should hear nothing but the ringing noise produced by the vibration of the tubes. If the tubes are well mounted on a cushioned base, you may not hear even that. If the jar causes a rattling sound in the telephones, or if the noises that you have been hearing are more violent, you should hunt for a loose contact in some of your instruments or wiring.

Of course, this crude "bump" test will not be helpful if your receiver is of the crystal type, without tubes; in such a set the chances of internally produced noises are fairly remote, though sometimes a shaking contact will cause them and, in any event, a bad connection will make the received signals

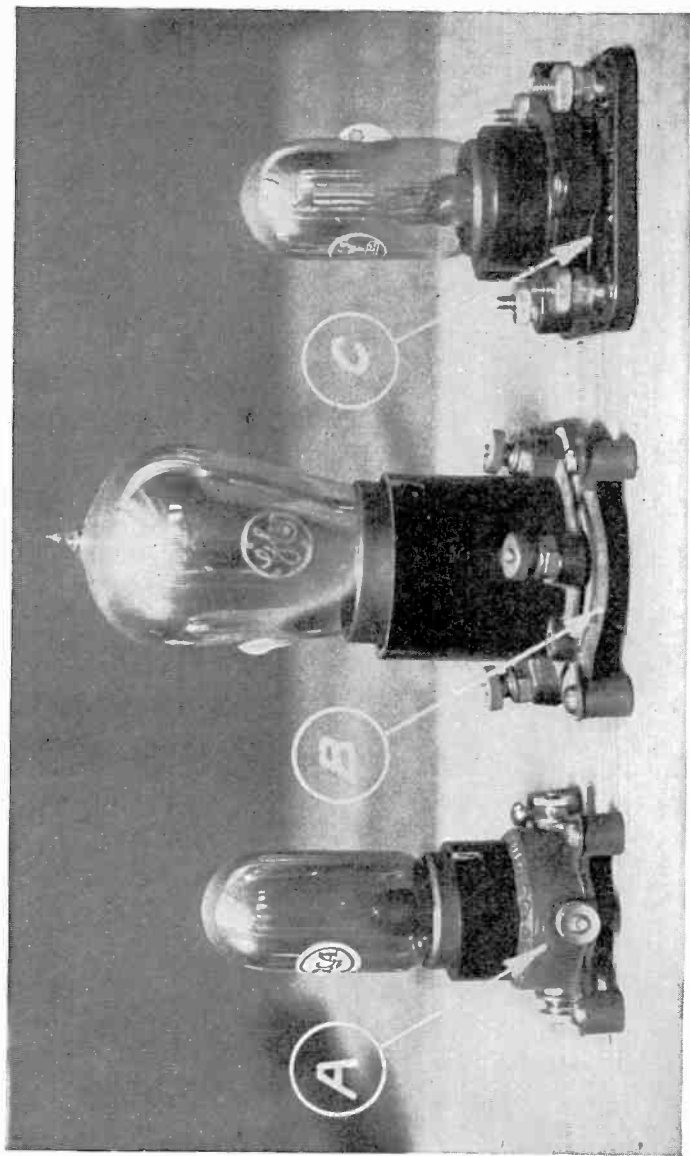

CUSHIONED SOCKETS HELP TO MAKE YOUR RECEIVER QUIET

Figure MM: Socket A is made with the lower portion of soft rubber. At B is a soft rubber platform on which a standard socket can be mounted. The socket on the right is made in two pieces held apart by springs at point C. With such sockets and with all connections tight, there will be no noises unless they come from outside.

weaker than they should be. The best way to test the contacts in a crystal set is to try to shake each of them with an insulating rod (like a closed fountain pen) while listening to signals; a bad connection will usually show up by making a noise or by stopping the signals when you move it.

If there are no loose contacts in your receiver, and you still hear irregular noises while the antenna is disconnected, you should look for the trouble in your

“B” batteries (which may have become run down and noisy) or in your detector grid-leak (which may have become microphonic or may not be of the correct value for the tube you are using). Should the noises not appear when you allow the set to remain untouched, but if they show up when you adjust some particular element such as a tuning condenser, a coupler or a potentiometer, you may expect to find a “floating” or irregular bad contact in that instrument.

END OF SECTION XI



From a photograph made for POPULAR RADIO

Sir Oliver Lodge

The foremost British physicist whose contributions to science have made him a figure of importance throughout the world.

"Congratulations to POPULAR RADIO and its successful endeavor to interest readers in scientific principles! . . . I consider that the vogue of wireless is a means of educating the public in some of the principles of science which have a bearing on their favorite pursuit, and that thus a few of them may be diverted into the paths of science. That is one reason why I make use of the opportunity which POPULAR RADIO seems to offer."

—SIR OLIVER LODGE

VOLUME III—CONTRIBUTORS

MORRIS STROCK, E.E.

R. HOFFMANN, M.E.

P. MCGINNIS, I.R.E.

C O N T E N T S

SECTION 12

Making Simple Radio Measurements. How wavemeters operate. How to calibrate wavemeters; the standard wavemeter, etc. How to measure antenna factors. How to calculate capacity, resistance, inductance, frequency, etc., by means of charts.

SECTION 13

Learning the Language of Dots and Dashes. The Continental Code. Means and kinks for code memory. How the U. S. Army teaches the code. Code practice. The requirements of the U. S. Department of Commerce for amateur licenses. How to take an examination. How to get an amateur's license. The radio districts, etc.

SECTION 14

Batteries, Battery Eliminators and Chargers. The principle of the storage battery. How to care for a storage battery. The hydrometer and how to use it. Different type of chargers; chemical, tube and magnetic. How to use chargers of different types. B battery eliminators; how they function, etc. The different types of storage B batteries. Classification of all types of chargers, B-eliminators, storage batteries and eliminator transformers on the present market.

SECTION 15

The Different Types of Receivers. The crystal receiver, and how it works. Non-regenerative circuits. Regenerative circuits. Reflex circuits. Radio-frequency circuits. Superheterodyne circuits. Neutrodyne circuits. Classifications and description of all the popular radio receivers on the present market.

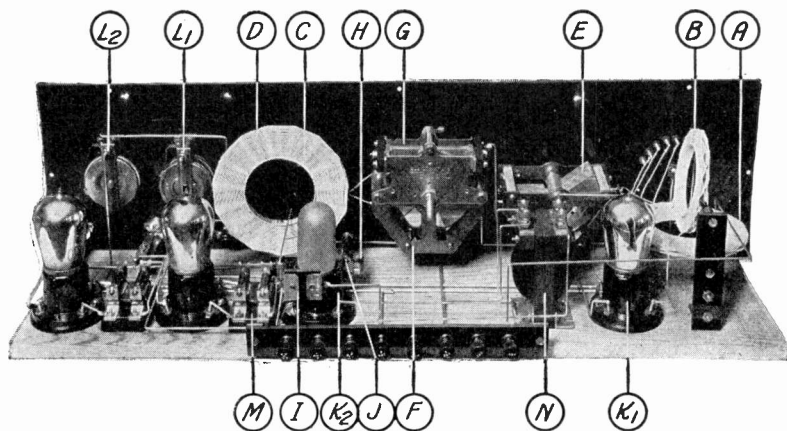

The Sections of the Everyman's Guide to Radio dealing with the various instruments keyed in this illustration may be quickly found by reference to the index below.

ILLUSTRATED INDEX

- A-B—Loose couplers and variometers, Section 10.
- C—Coils, basket wound, D—Coils, honeycomb coils, etc., Section 10.
- D—Radio frequency transformers, all types, Section 8.
- E—Condensers, variable types, Section 9 and 2.
- F—Condensers, variable vernier, Section 9.
- G—Condensers, variable and multiple, Section 9.
- H—Fixed condensers, Section 9 and 2.
- I—Fixed condensers, adjustable, Section 9.
- J—Grid leaks, Section 6.
- K1—Amplifier vacuum tubes and sockets, Section 6 and 16.
- K2—Detector vacuum tubes, Section 6.
- L1—Rheostats, Section 6 and Section 16.
- L2—Potentiometers, Section 16.
- M—Resistance coupled audio amplifiers, Section 7.
- N—Audio-frequency transformers, Section 7.

SECTION XII

Making Simple Radio Measurements

THE student will find in this part much valuable and understandable data concerning the calculation of inductance, wavelengths, capacity, and the like as well as a description of the simple devices with which these measurements may be made. No lengthy or involved formulae are included and any novice with a good grounding in arithmetic may arrive at accurate conclusions by means of the methods given.

Perhaps there is no more important instrument used for radio measurements than the wavemeter. It may be employed in a dozen and one calculations and, contrary to what might be expected, it may be constructed and operated by students of the science with little or no trouble.

A wavemeter is really a combination transmitter and receiver of the calibrated type. That is it may be adjusted to emit a wave of definite length and it may be set to receive a wave of definite length. In this way it is possible to calibrate transmitters and receivers by its use.

Every amateur who operates a transmitting apparatus ought to have a wavemeter—for his own protection. Yet few amateurs own one. No transmitting set can be adjusted properly for wavelength without the aid of an accurate wavemeter. In the proper adjustment of a spark transmitter a wave-

meter is indispensable, as a resonant condition between the closed and open circuits is far more essential for maximum efficiency than "antenna current."

In obtaining resonance in a tube transmitter, the amateur is usually guided by the use of various voltmeters, ammeters and milliammeters. But reliance should not be placed upon guess work in determining the length of the emitted wave. Our Government, through the Department of Commerce, has complete jurisdiction over radio communication and has designated the operating wavelengths of various classes of stations, and these wavelengths must be adhered to strictly in transmitting. The amateur who uses a wavelength greater than that to which he is entitled is in danger of forfeiting his license.

The amateur who wants to build his own wavemeter—and the task is not difficult—will find the following instructions of practical value. The apparatus here described is really efficient; for amateur purposes, indeed, it may well take its place alongside the justly famous Kolster decimeter. The specifications call for the following material:

1 pc. bakelite 3/16 by 8½ by 8½ inches.

1 Weston thermo-galvanometer No. 425.

1 1½ volt flashlight cell.

1 Century buzzer.

1 Rotary Switch lever.

2 Contact points.

1 Variable Condenser .001 mfd. with dial.

2 Binding Posts.

1 Suitable oak or mahogany case.

The schematic drawing Fig. B, shows the electrical connections; the dotted lines represent wires which should be of No. 14 solid-copper wire covered with cambric tubing.

In Fig. F is shown a circuit diagram, and in Fig. C a drilling plan of the panel. Across the binding posts A and B (Figs. B and F) are shunted the windings of the wavemeter coil which complete the

circuit through either the meter or the buzzer.

To calibrate the receiving set, place the wavemeter near the antenna lead-in wire, insert the desired coil across the binding posts A and B and place the rotary switch in the "on" position, closing the battery circuit through the buzzer and coil. Set the dial of the receiving set at zero and vary the position of the condenser dial on the wavemeter until the maximum sound is received in the head set that is connected to the receiving set.

Continue this process, taking readings

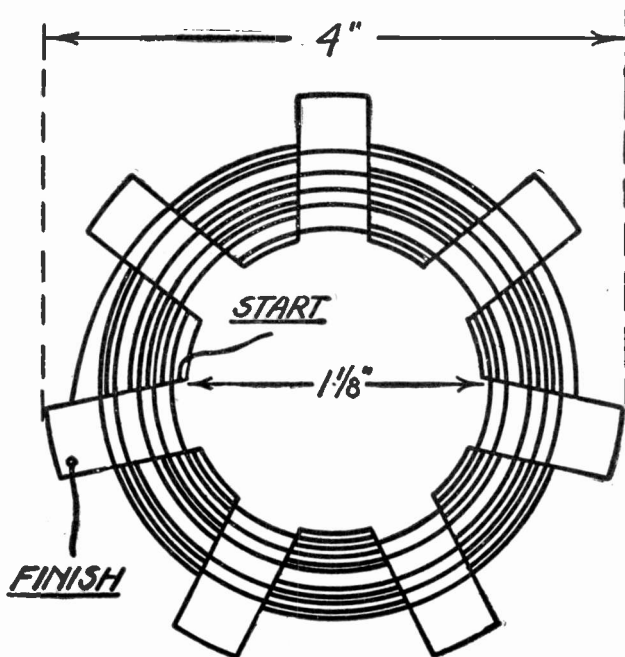

FIGURE A

How to make the coils. Coil 1 has 20 turns on it, and coil 2 has 42 turns. This is the only difference.

of the wavemeter dial when the receiving dial is set at zero, 5, 10, 15, 20 and on. Then by reference to the curve (shown in Figs. D and E) you can ascertain the exact wavelength of each of the various settings of the dial on the receiving set.

Once you have obtained the values at different points, you may plot a new curve for your particular receiver; thereafter you need merely to refer to this curve to learn at a glance the exact wavelength of an incoming signal.

This meter, it will be noticed, is also

equipped with two extra binding posts to accommodate a pair of telephones to be used in conjunction with the crystal detector as shown in the circuit diagram in Fig. F and in the photograph on page 16.

To tune a transmitting set, the only change necessary on the wavemeter is to move the rotary switch to the "off" position; when the transmitter is in operation, bring the wavemeter near the apparatus and move the wavemeter dial until the maximum deflection of the thermo-galvanometer is noted. By refer-

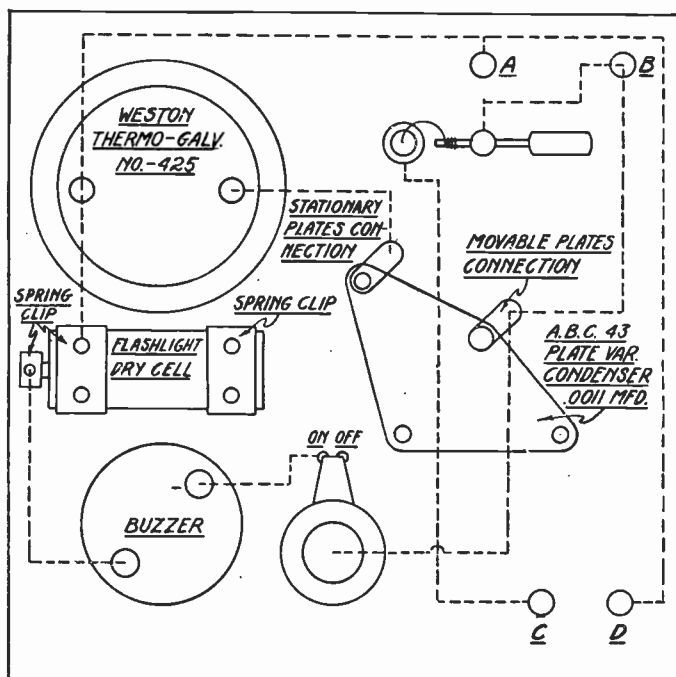

FIGURE B

Figure B shows a schematic drawing of the instrument layout with the circuit connections indicated by dotted lines.

ence to the curve you can immediately ascertain the exact wavelength of your transmitter.

Care should be exercised not to place the wavemeter too near the transmitter, as the thermo-galvanometer shown is very sensitive; the full scale deflection is equivalent to only 115 milliamperes. A thermo-coupled milliammeter of 0-100 scale will also be suitable for this purpose.

For construction of the coils across A and B, see Fig. A. If every detail is followed closely in making the coils, the curves shown in Figs. D and E

are accurate within a small percentage.

The instrument described will be a guarantee that you do not exceed the wavelength allotted to you.

An inductance coil or inductor is sometimes improperly called an "inductance." An inductance coil or inductor possesses an electrical property called inductance, but it also possesses electrical resistance and a certain amount of capacity when used in circuits at radio frequencies. The latter property is usually spoken of as "distributed capacity," as it is made up of innumerable small capacities between the various

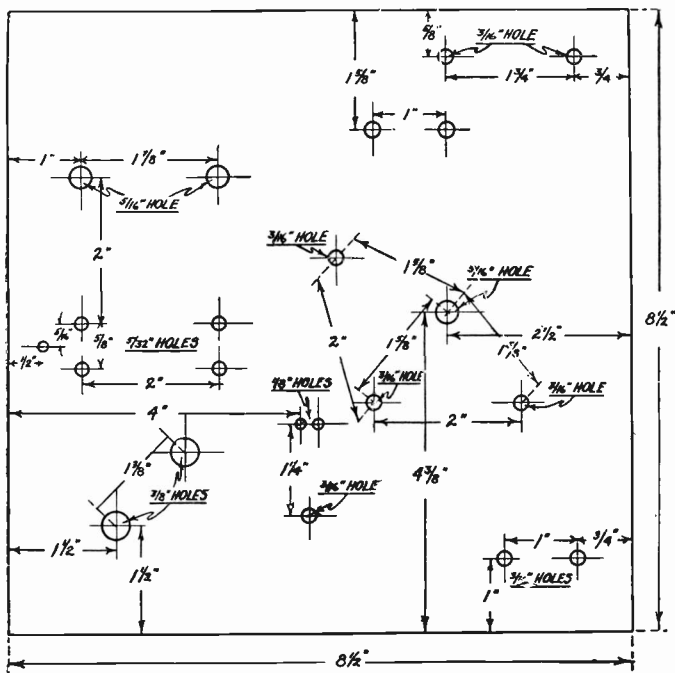

FIGURE C

Where to drill the holes in the panel. Follow this diagram and know exactly what size the holes should be and exactly where they should be drilled.

turns of wire in the coil and between the coil and surrounding objects.

Fig. I (a) represents the usual method of denoting an inductor in a circuit. If we take account of the distributed capacity, we might think of it as in Fig. I (b) where all the innumerable small capacities enter in.

The characteristics of an inductor which we will consider at radio frequencies will be the apparent inductance, the pure inductance, the distributed capacity and the natural frequency.

In measuring these characteristics, in addition to the inductor to be measured, it will be necessary to have one or

more calibrated variable condensers of different values sufficient to cover the desired range of frequencies or wavelengths, a calibrated wavemeter which may or may not be equipped with a buzzer, a pair of telephone receivers and a crystal detector.

First, we will determine the apparent inductance of a coil using the buzzer driven wavemeter as a driver and repeat the measurements using the radio-frequency generator as the driver. First connect the terminals of the inductor to the terminals of the calibrated variable condenser and connect the crystal detector and telephone receivers at one point of this circuit as shown in Fig.

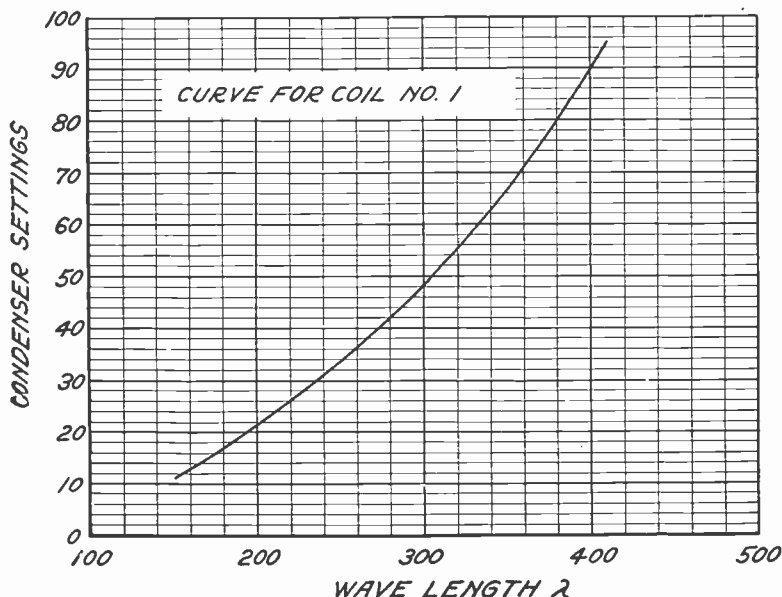

FIGURE D

The wavelength chart for coil number 1. Run along the horizontal line, which corresponds to the number on the dial of the condenser in the wavemeter for a given setting, until you strike the curve; then run down the vertical line to the bottom of the chart to find the wavelength. Thus for a setting of 21 on the condenser we find a wavelength of 200 meters, on which amateurs transmit.

J. The connections between the inductor and condenser should be as short as possible. The buzzer on the wavemeter is started and the wavemeter coil is brought near the coil under test so that the coupling between the coils is rather close. The setting of the variable condenser in the test circuit is then varied until the buzzer note is heard in the telephone receivers.

The coupling between the two circuits may now be loosened so that the buzzer note is heard only at a very definite setting of the condenser S,

which setting is recorded and also the setting of the wavemeter. If the condenser of the wavemeter is changed to another setting a different frequency or wavelength will be set up and another point on condenser C may be found. As many points as desired may be taken in this way.

Upon completion of these tests we will have two columns of data from which to make our calculations of apparent inductance, one column of condenser settings for which we know the corresponding capacity values, and a

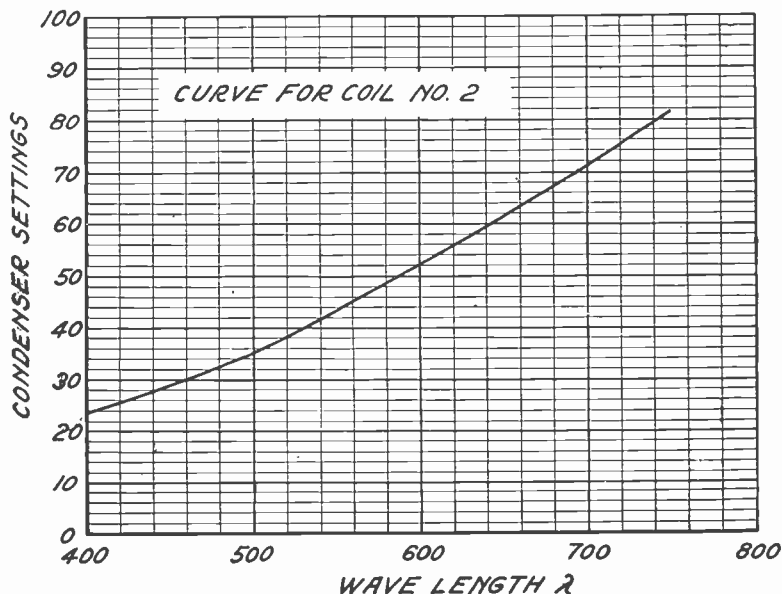

FIGURE E

The wavelength chart for coil 2. This chart is used in the same manner as the chart shown in Figure D. It will be noticed that coil 1 has a wavelength range of 150 to 400 meters and that coil 2 has a range of 400 to 740 meters. If the experimenter desires to make his wave meter a still more useful device by increasing its range beyond the points made possible with the two coils described, it is only necessary to make longer coils and to draw up curves to match them.

second column of condenser settings for which we know the corresponding frequency or wavelength values. These values might appear as shown in the first and third column of Table 1.

TABLE NO. 1

Determination of apparent inductance of coil

Condenser Setting S	Capacity, Micromicro-farads	Wavemeter Setting	Wave Length, Meters	Apparent Inductance, Microhenries
10.1	114.5	179.4	B3 822	1660
30.1	247.2	94.5	A4 1150	1506
50.2	375.8	4.5	B4 1400	1467
80.1	565	96.4	B4 1700	1440
139.9	951	36.8	C4 2188	1422
170.0	1144	81.2	C4 2400	1416

The apparent inductance in Table 1 was calculated from the following formula:

$$L_a = \frac{0.2818\lambda^2}{C}$$

Where

L_a = the apparent inductance in microhenries,
 λ = the wavelength in meters,

and
 C = the capacity in micromicrofarads of the known condenser.

The same measurement may be made with greater ease and accuracy by using an electron tube radio-frequency generator as the driver, a wavemeter to determine its frequency and a thermogalvanometer and single turn of wire to determine the resonance point.

The connections are indicated in Fig. K.

The procedure is similar to that given above in that the radio-frequency generator is started and the condenser in the circuit of the coil under test is varied until a maximum deflection is obtained in the circuit consisting of the thermogalvanometer and single turn of wire. The single turn of wire may be from four to six inches in diameter and is placed two or three inches from the coil under test so as to have its axis parallel to the axis of the larger coil.

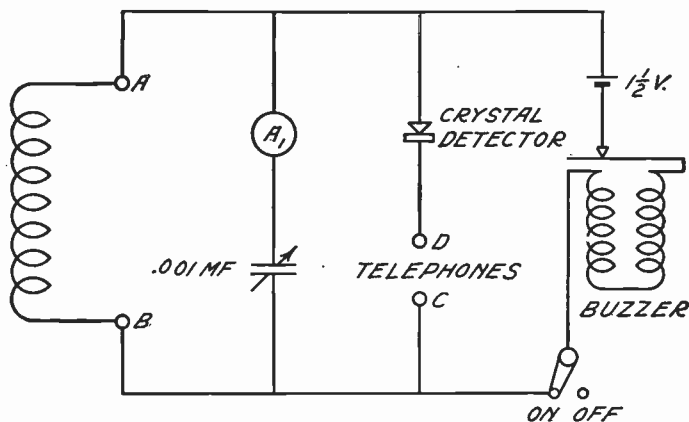

FIGURE F

This circuit diagram shows the electrical hook-up for the apparatus. Either coil 1 or coil 2 may be used across the binding posts in accordance with the wavelength range to be covered.

The coupling between the coil and generator should be kept as loose as possible and yet have a deflection in the thermogalvanometer which is readily seen. Having determined the resonance point, the setting of the condenser S is read and the wavelength of the generator is determined with the wavemeter. Several points may be obtained and a curve may be drawn showing the change in apparent inductance with frequency or wavelength. Fig. L shows the values of inductance and wavelength in Table 1 in plotted form.

If we should make measurements of

the inductance of this same coil, using direct current or alternating current at 1,000 cycles a second (for instance), we might find that the values we obtained that way would be somewhat less than the values we have just obtained at radio frequencies. This is because in the equation used above for calculating the apparent inductance it has been assumed that the only capacity present was in the variable condenser.

We stated at the beginning that the coil itself had some capacity in itself which we call distributed capacity.

We will now make a few calculations

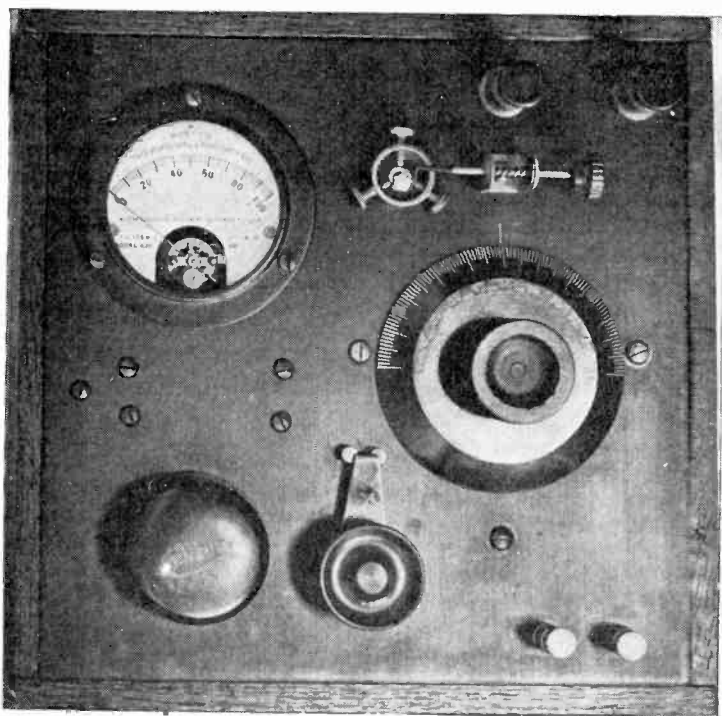

A PANEL VIEW OF THE COMPLETED WAVEMETER

Figure G: With this apparatus the amateur may check up on two important points—the wavelength of the signals that he is transmitting and the wavelength of the signals that he is receiving. No radio installation is complete without this important measuring instrument.

to determine the value of the distributed capacity of the coil. We may select three or more sets of observations from the data already taken in determining the apparent inductance. We will determine the capacity of the condenser and the wavelength of the generator for these points. After squaring the values of wavelengths, plot these values as ordinates against the corresponding values of capacity in micromicrofarads. (See Fig. M.)

If the measurements have been care-

fully made, these points will lie on a straight line which may be drawn through these points and extended to the abscissa axis, as in Fig. M.

It is seen that this line cuts the ordinate axis some distance from the origin and continues to the left of this axis. The distance OA, measured by the same scale as OC, is the value of the distributed capacity for the coil, and in this case is about 20 micromicrofarads.

One perhaps wonders how this small value of capacity, the distributed ca-

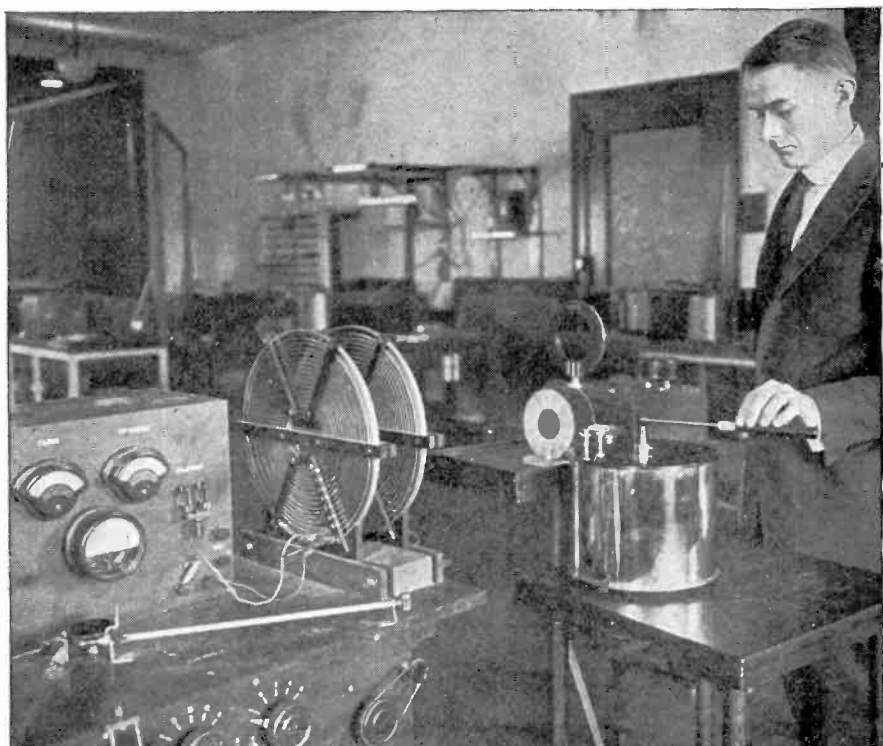

THE NECESSARY APPARATUS FOR DETERMINING THE CONSTANTS OF COILS USED IN RECEIVERS

Figure H: The small spiderweb coil under test is shown connected to a laboratory standard variable condenser with the oscillator at the left and the wavemeter in the background.

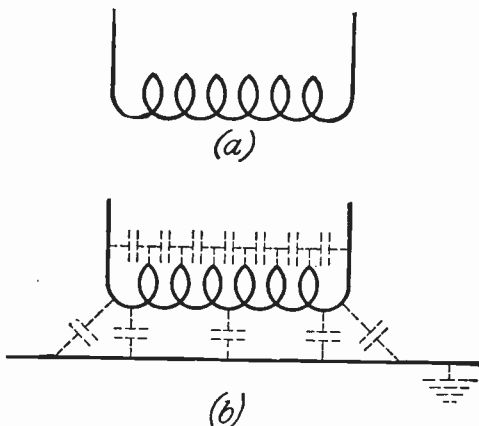

TWO VISUALIZATIONS OF INDUCTORS

Figure 1: The upper diagram (a) is the conventional inductance symbol. The lower diagram (b) indicates the existence of the distributed capacities of an inductive circuit that are never graphically represented.

capacity, enters into the fundamental equation for the wavelength of a circuit made up of an inductance coil and a condenser in series, which may be written

$$\lambda = K \sqrt{LC},$$

λ being in meters, K a constant, L the inductance in the circuit and C the capacity in the circuit. The quantity C in this equation is made up of the capacity in the condenser and the distributed capacity of the coil.

The pure inductance of the coil may be calculated from the equation:

$$L_p = \frac{0.2818\lambda^2}{(C + C_o)}$$

Where

L_p = pure inductance in microhenries,

λ = wavelengths in meters,

and

C = capacity of condenser in micromicrofarads.

C_o = distributed capacity of coil in micromicrofarads.

It was stated above that the distributed capacity of an inductor may be made up of innumerable small capacities between the various turns of wire in the coil. If this is true it would seem that a given inductance coil might have one or more frequencies or wavelengths to which it would respond or go into resonance. That is the case and one or more frequencies can usually be found at which the coil will be in resonance when the two ends of its winding are not connected to anything. To determine one or more of these frequencies the coil is placed near a radio-frequency electron tube generator and a resonance indicator consisting of a thermogalvanometer and a turn of wire are coupled to the coil. The frequency of the generator is varied until a resonance indication is observed, when the frequency or wavelength of the generator is measured with a wavemeter.

Fig. O shows the connections.

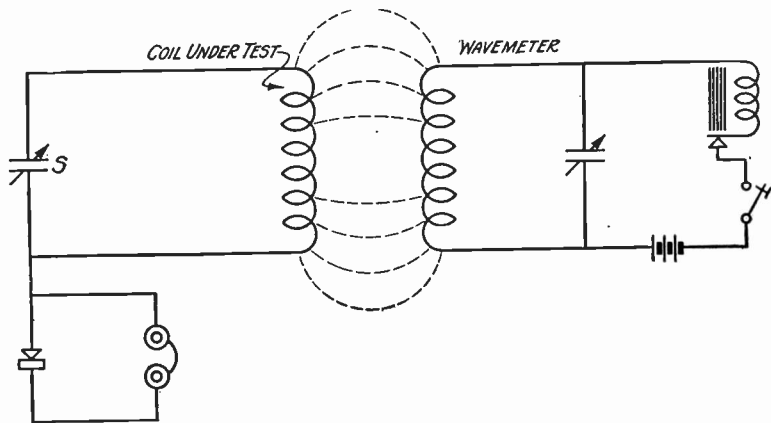

CIRCUIT DIAGRAM OF THE AUDIBLE MEASUREMENT METHOD

Figure J: This shows the hook-up that employs a buzzer-driven wavemeter to excite the circuit under test. A crystal detector and phones are connected to this circuit to determine its resonance point.

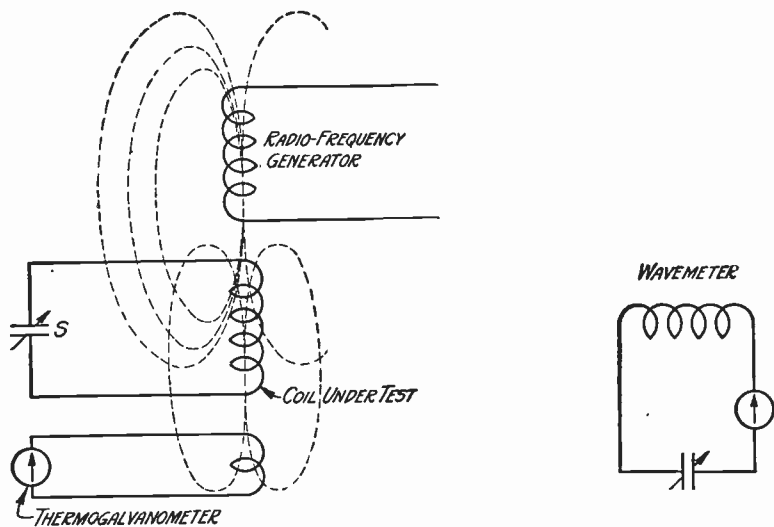

HOOK-UP OF THE SIMPLER AND MORE ACCURATE METHOD OF MEASURING FREQUENCIES

Figure K: This diagram indicates the mode of frequency determination that employs an electron tube radio-frequency generator as a driver, a wavemeter and a thermogalvanometer for indicating the resonance of the circuit under test.

The frequency giving the greatest indication in the thermogalvanometer will be the natural frequency of the coil and will be the shortest wavelength at which resonance may be found. The natural period is usually much higher than the frequency to which the coil would be in resonance if the circuit contained any capacity of such values as are ordinarily employed.

Measurements upon some coils will show little, if any, change of apparent inductance with frequency or wavelength and the distributed capacity will be found to be very small also. Measurements upon two spider-web coils gave such results, also the measurements upon a cylindrical spaced single layer

coil. Coils of these two types give sharp tuning in radio circuits and are well-suited for use in some radio receiving sets. The data given in the table is for a coil of 70 turns bank wound in four layers, and wound on a tube about $6\frac{1}{2}$ inches in diameter. The apparent inductance of this coil varied from 1,660 to 1,415 microhenries over the range from 820 to 2,330 meters. Its pure inductance or low-frequency inductance was about 1,390 microhenries and its distributed capacity about 20 micro-microfarads. All of these values may be changed by the *method of mounting the coil*, the *presence of metal objects* in the immediate vicinity of the coil and the *absorption of moisture* by the form upon

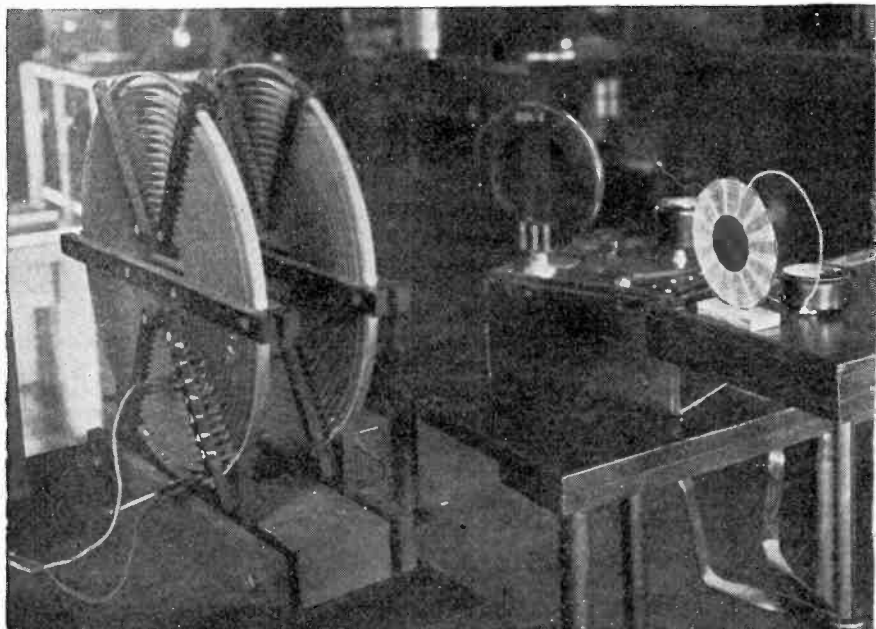

Harris & Ewing

THE EQUIPMENT FOR DETERMINING THE NATURAL FREQUENCY OF INDUCTORS

Figure L: The apparatus (from left to right) is a radio-frequency electron-tube generating set with pancake coils, a wavemeter, a spider-web coil under test and a loop of wire connected to a thermogalvanometer.

which the coil is wound. The consideration of these factors in coil construction is often overlooked.

All of the above remarks have been made concerning fixed inductors or coils. There are on the market continuously variable inductors often incorrectly called variometers. This is a misnomer because a meter usually is used to measure something, while in these instruments the inductance is simply changed and no measuring is done. Any of the above characteristics could

be obtained upon a variable inductor in much the same manner as explained above. Measurements of the inductance of such apparatus are often made at an audio frequency such as 1,000 cycles a second. Such results are absolutely useless for work at radio frequencies, as the apparatus behaves entirely different at audio frequencies. In many of the variable inductors where a large amount of insulating material is in the field of the coil, the distributed capacity becomes very large. Because of the large

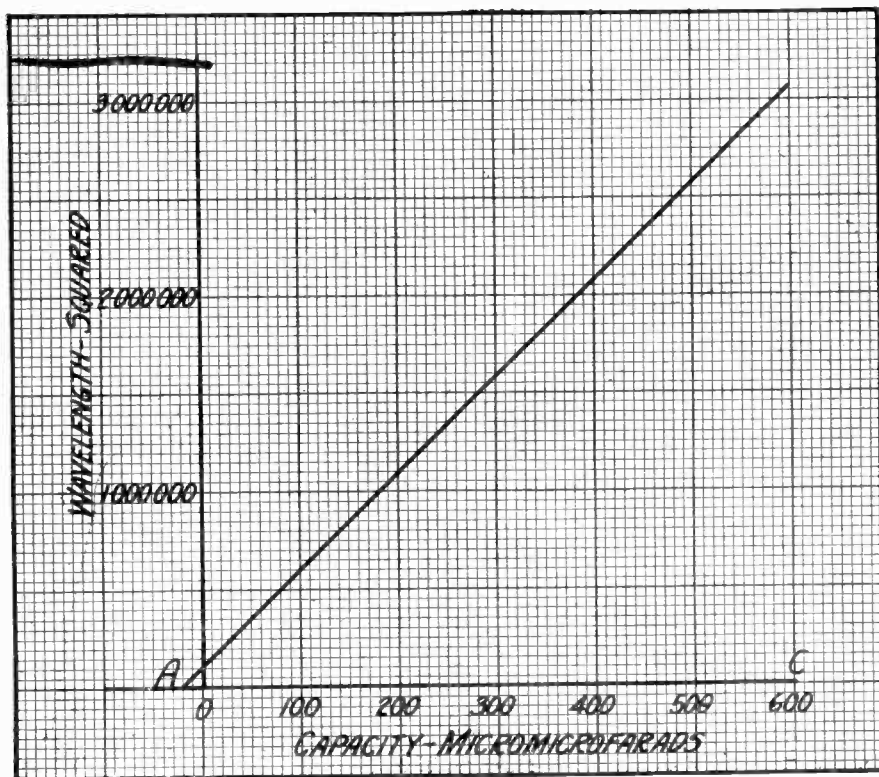

CHART OF THE SQUARE OF THE WAVELENGTH PLOTTED AGAINST CAPACITY

Figure M: If a coil had no distributed capacity, the straight-line curve shown above would pass through the origin 0. The distance 0-A represents the distributed capacity of the coil under test.

distributed capacity, the apparent inductance for any setting of the variable inductor will vary with frequency or wavelength. The apparent inductance for a given setting will be larger for the higher frequencies or lower wavelengths than for the lower frequencies or higher wavelengths. As the wavelength is increased the values will come closer and closer to the values obtained at audio frequencies, but it is obvious that measurements must be made at high frequencies if the results are to be employed for operation at these higher frequencies.

The primary standard of radio frequency of the Bureau of Standards¹ consists of two standard wavemeters which cover the frequencies in general

¹Published by permission of the Director of the Bureau of Standards of the U. S. Department of Commerce.

use, *viz.*, from about 18 to 4,600 kilocycles a second (16,650 to 65 meters). These wavemeters are similar in general construction, each consisting of a variable air condenser, four fixed condensers, a number of interchangeable inductors, and a resonance indicating device, all mounted in a fixed position upon a specially constructed movable table.

The variable air condenser is of about 0.001 microfarad maximum capacity and is a Bureau of Standards type of condenser, having its movable plates connected to a metal shield which is connected to ground when in use. Four shielded mica condensers are also provided having capacities of 0.001, 0.002, 0.004 and 0.008 microfarad, respectively.

For the one of the two wavemeters which serves as primary standard five

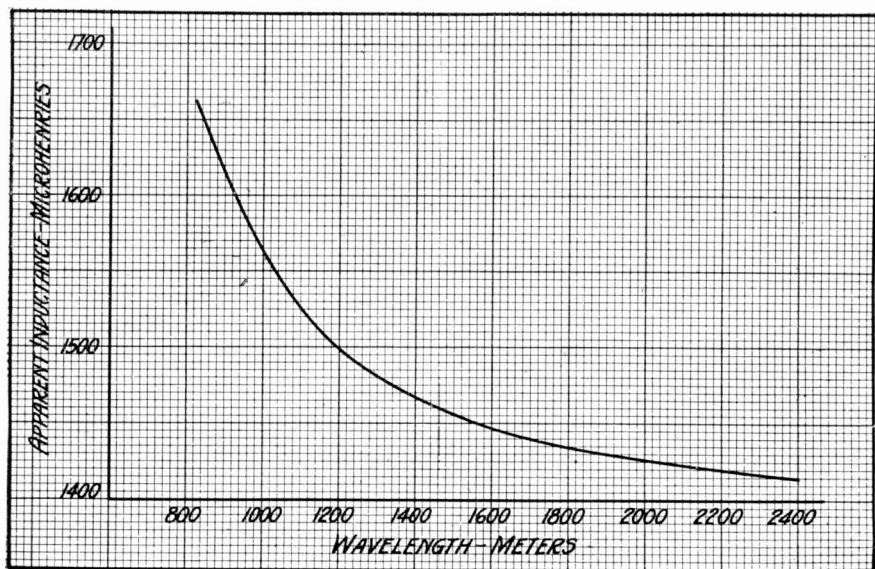

CURVE OF THE CHANGES OF APPARENT INDUCTANCE WITH WAVELENGTH

Figure N: This graph shows that the apparent inductance of a coil increases much more rapidly at the lower wavelengths or higher frequencies.

inductors are provided. Four of these five inductors are of the single-layer, spaced-winding type, employing skeleton frames of laminated phenolic-insulating material wound with high-frequency cable and forming coils of polygonal cross-section. The inductors are provided with terminals so that they are interchangeable. The three smallest coils are boxed in to prevent changes in the inductor constants from the displacement of a portion of the winding by handling.

The resonance indicator consists of two turns of heavy wire fixed in position near the wavemeter inductor and two indicating instruments. A thermogalvanometer is used for coarse adjustments and a crystal detector and direct current milliammeter for finer adjustments, the latter instrument permitting of much more accurate indication of the resonance point than the former.

In the wavemeters of this general design formerly used by the Bureau the condenser and inductors were mounted separately. After tests were completed with a wavemeter of this type, the condenser, inductor and connectors were put away in a case until needed again. There was always the chance of changing the calibration of the condenser by carrying it from one place to another, as well as the chance that errors might be introduced by using different connecting wires or by accidental bending of the wires.

Much of this chance of error was overcome by mounting permanently a standard variable air condenser and connecting leads for the coil terminals upon a table equipped with rubber-tired wheels.

The resonance indicator for the wavemeter built on this principle was a combination of a single turn of wire and

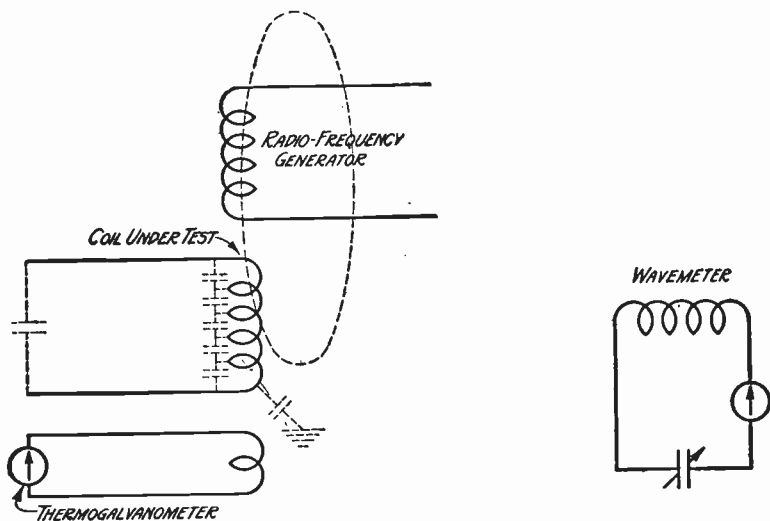

CIRCUIT DIAGRAM OF THE MEANS OF FINDING THE NATURAL FREQUENCY OF COILS

Figure O: With the coil under test left open, the wavelength of the circuit can be determined as in Figure K: (using the electron tube radio-frequency generator as a driver with a thermogalvanometer) and the capacity corresponding to this wavelength is the distributed capacity of the coil.

a Weston "thermogalvanometer" Model 425, the latter consisting of a thermo-element and a direct-current indicating instrument. The single turn of wire was mounted with its plane parallel to the turns on the wavemeter inductor but was not fixed in position. It could be moved along a line perpendicular to the axis of the wavemeter coil. The indicating instrument and the turn of wire were connected to the grounded terminal of the wavemeter. This wavemeter covered a range of from 30 to 4,600 kilocycles (10,000 to 65 meters) using a

condenser of about 0.001 microfarad capacity and six fixed inductors.

Among the improvements in a wavemeter of this type was the addition of the four mica condensers which could be connected in parallel with the variable air condenser in order to extend the range of the wavemeter. A micrometer adjustment for the movable plates of the variable air condenser was added also.

The wavemeter now in use is a still further improvement on this type. The connections to the inductor are made of

TABLE No. 1
CONSTANTS OF THE INDUCTORS FOR THE
PRIMARY STANDARD WAVEMETER

	INDUCTOR				
	E	F	G	H	L
Diameter, centimeters.....	12.5	12.5	22.8	27.9	38.0
Length, centimeters.....	6.6	7.1	9.4	15.4	18.2
Number of turns.....	8	22	39	96	320
Spacing, centimeters.....	0.8	0.3	0.2	0.2	0.1
Size of wire (high frequency cable).....	48x38	48x38	48x38	48x38	32x38
Distributed capacity, micro-microfarads.....	8	11	11	14	90
Pure inductance, microhenries...	9.2	56	382	2439	22880
Equivalent resistance, ohms for the frequency corresponding to a 10° setting of the air condenser.....	2.4	2.2	6.2	11.3	—
Same for 175° setting of the air condenser.....	0.4	0.7	2.0	5.1	—
Direct current resistance, ohms..	0.27	0.44	1.54	5.1	21.0

TABLE NO 2
RANGES OF VARIOUS COIL AND CONDENSER COMBINATIONS

Coil and Condenser Combinations	Frequency		Wavelength	
	Kilocycles per second		Meters (approximate)	
	10° setting	175° setting	10° setting	175° setting
E	4610	1500	65	200
F	1650	615	180	490
G	700	233	425	1285
G and I	241	172	1240	1740
G and II	174	142	1720	2110
H	280	93	1070	3220
H and I	95	68	3120	4380
H and II	70	57	4300	5280
L	73	29.5	4100	10160
L and I	30.3	22.0	9900	13600
L and II	22.3	18.3	13400	16400

3-millimeter brass rod forming a rectangle 25 by 29 centimeters. Four rods support the connections to the inductor. The two on the insulated side of the condenser are of Pyrex glass. Of those on the grounded side of the condenser, the support nearer the condenser is of brass and connection to the ground is made through its lower extremity. The support nearer the inductor is of laminated phenolic insulating material.

The resonance indicator may be connected either to a model 425 Weston thermogalvanometer or to a crystal

rectifier and direct-current milliammeter. The latter combination is much more sensitive than the former and permits much looser coupling between the radio-frequency generating set and wavemeter. The instrument shown in the photograph (Fig. P) has a full-scale range of 2 milliamperes, but when in use the current is usually kept between 0.4 and 0.8 milliamperes, which permits extremely loose coupling between the generator and the wavemeter.

The resonance indicator circuit is not grounded or connected to the wave-

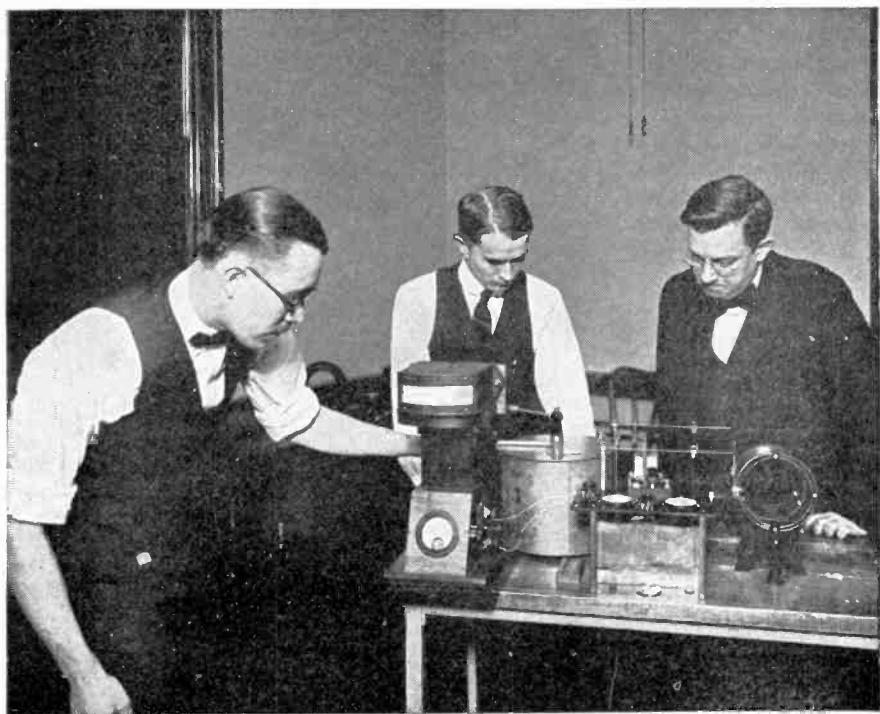

THE STANDARD WAVEMETER OF THE BUREAU

Figure P: Mr. Hall, is shown in the center, explaining the wavemeter to Dr. E. E. Free (at the right). The indicator instruments are shown at the left and the inductor at the right. Mr. O'Keefe (at the left) is adjusting the wavemeter to resonance.

meter circuit in any way. A greater deflection may be obtained by grounding that circuit at certain ranges of frequency, but this is noticed particularly with the crystal rectifier and milliammeter which is more sensitive than the other instrument. The increase in deflection is caused by the apparent increase in coupling with the generator resulting from connecting to the ground connection. This is noticed particularly with the smaller inductors, where there

is likely to be a change in the calibration because of the proximity of the two turns of wire which are at ground potential, to the wavemeter inductor.

This method of resonance indication permits of looser coupling than may be obtained with the indicator directly in the wavemeter circuit, except perhaps for the very high frequencies. When a crystal detector and a sensitive wall-galvanometer are used, the wavemeter may be from ten to twenty feet from

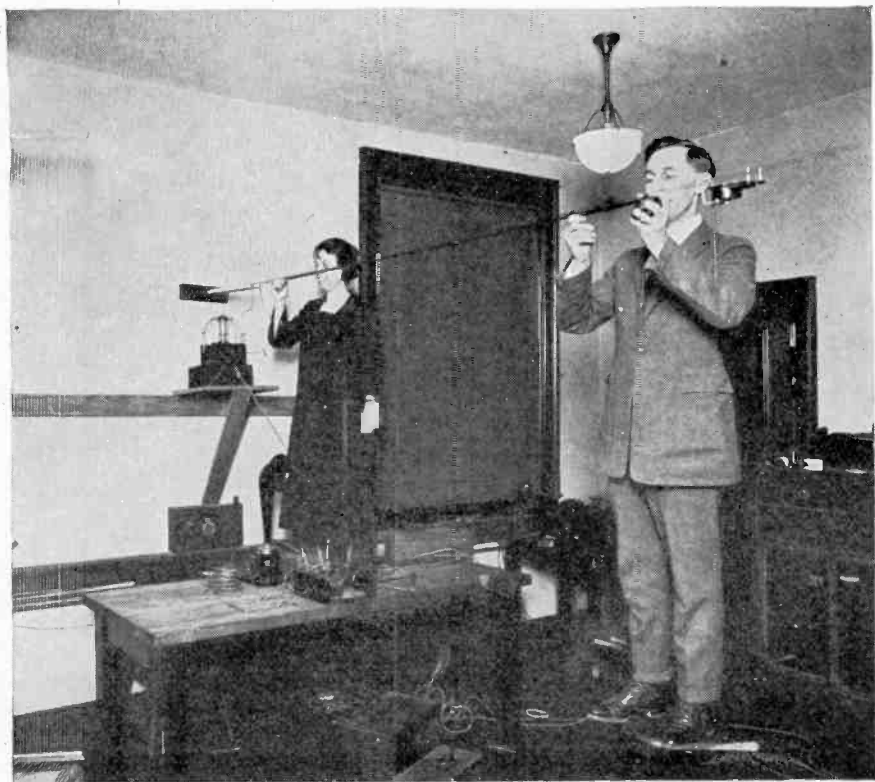

HOW WAVEMETERS THEMSELVES ARE STANDARDIZED

Figure Q: To check the readings of wavemeters the Bureau of Standards has devised a method of setting up very short standing waves on parallel wires and measuring these waves with a tapeline. The generator for the short waves is shown at the left. The photograph shows the method of measuring with the tape the position of a resonance point previously determined with the ammeter seen to the right of the operator's hands.

oratory. This precaution is important if the calibration is to be reliable.

The wavemeter is used with a ground wire attached to the shielded side of the air condenser. This reduces the error in noting the resonance point which is likely to be caused by capacity effects between the wavemeter circuit and the body of the operator. When making measurements of frequency the wavemeter is coupled to the radio-frequency generating set as loosely as possible.

The distance between the generating set and the wavemeter will vary from a few inches at high frequencies to several feet on lower radio frequencies. The operator always stands on the grounded side of the wavemeter, well away from the inductor.

The constants of the inductor coils and the frequency ranges attainable are given in the accompanying table. The precision of setting the wavemeter to a given frequency is dependent on the

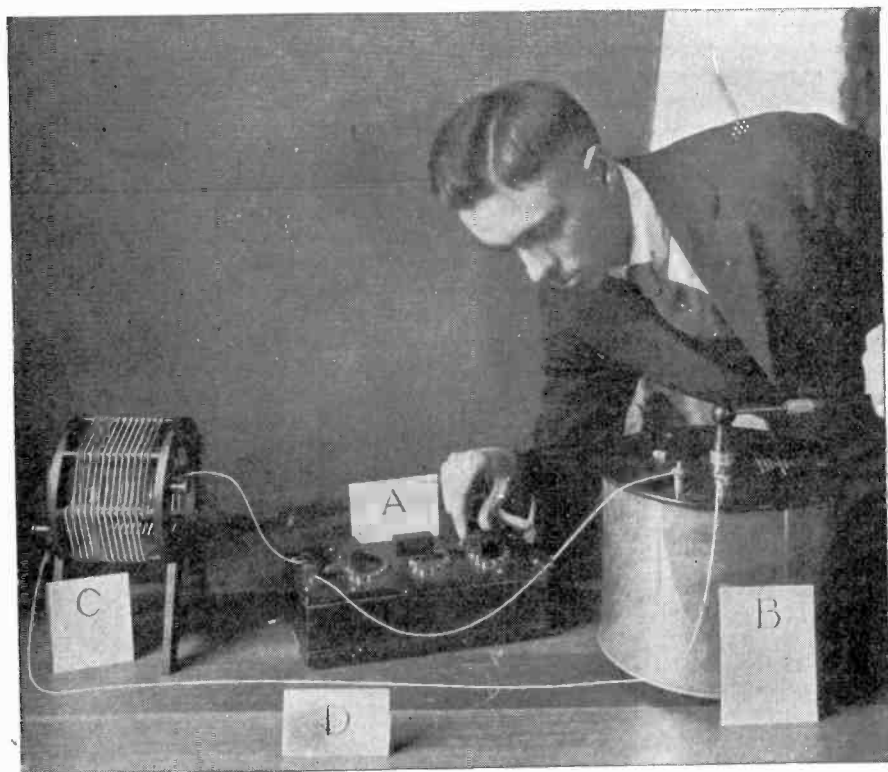

THE "PHANTOM ANTENNA" USED FOR LABORATORY TESTS

Figure T: One of the authors demonstrates the resistance box, A, which can be set at any value of resistance to be substituted for the resistance of the antenna; B, the variable condenser, which substitutes the capacity; D, the wire substituted for the ground, and C, the coil which furnishes the inductance which would be found in the real antenna.

sharpness of the resonance point as denoted by the resonance indicating instrument, which in turn will vary with the amount of capacity in the wavemeter circuit.

For capacity values such as are in general use at this time the precision varies from 0.2 percent for low condenser settings to about 0.02 percent with fixed condensers of about 0.002 microfarad capacity. In the majority of work with the wavemeter these values will vary between 0.1 percent and 0.03 percent. The precision of measurement may be increased by using more sensitive resonance indicators.

Whether an antenna is a poor or a good receiver of radio waves depends to a great extent upon its constants (electrical properties which can be determined by measurements or sometimes estimated or computed) and by another property of the antenna, "effective height."

The term "constant" is somewhat misleading because some of these electrical properties of an antenna vary greatly with the length of radio waves to which the antenna is tuned. But *at a particular wavelength* the constants of an antenna when used with a ground do remain much the same for a considerable period.

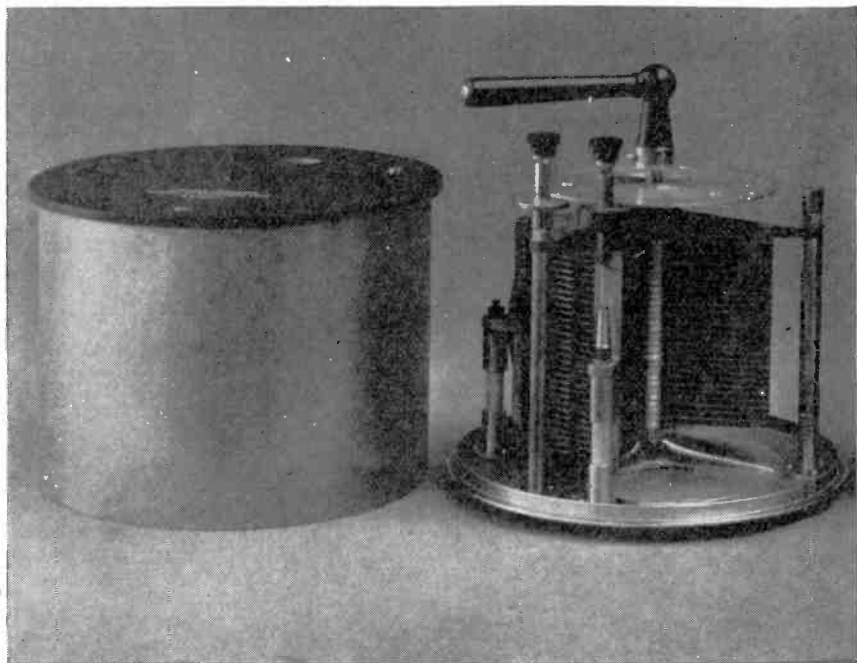

A DELICATELY CALIBRATED VARIABLE CONDENSER

Figure U: Here is shown a standard variable condenser which has been taken out of its protective casing. By rotating the black lever the rotary plates telescope inside of the stationary plates and the capacity of this instrument is varied.

What are the constants of an antenna?

- (1) Resistance;
- (2) Capacity;
- (3) Fundamental wavelength, and,
- (4) Inductance.

The resistance of an antenna is the opposition which it offers to the flow of the high-frequency (rapidly reversing) currents induced in it by the radio wave. High-frequency or radio frequency currents flow only on the surface of a conductor. Therefore if the surface area is increased the resistance will be reduced. Antenna resistance is a complex quantity, but it may easily be expressed in ohms.

The capacity of an antenna is a property which enables it to hold a certain electrical charge, and then to discharge this in the form of electrical energy through the receiving set to earth. Capacity is expressed in microfarads.

The fundamental wavelength of an antenna is the length of the wave to which it will respond when it is connected directly to earth. Thus if an antenna has a fundamental wavelength of 290 meters, electrical vibrations or oscillations will be set up in the receiving antenna by a transmitting station that is sending out signals of this wavelength.

The inductance of an antenna is a sort of electrical inertia which retards the changes in the rapidly reversing current induced in the antenna by the incoming radio wave.

On page 28 is shown an artificial antenna in which the required value of resistance is obtained by adjusting the box A and the required value of capacity by adjusting the condenser B; while a fixed value of inductance is obtained in the coil C. The wire D represents the conducting earth under the antenna. The condenser B consists of two sets of

overlapping plates which are at all times insulated from each other.

The interior of the condenser is shown in Fig. U. An antenna is a condenser in which the wires and the earth take the place of the two sets of overlapping plates. The coil C has about the same inductance as the average simple receiving antenna. If the wire in the coil is unwound and pulled out straight, its inductance is much less. This explains why the long wire in an antenna has so small an inductance value. In practice no attempt is made to secure a certain value of antenna inductance. The constants in the artificial antenna are "lumped"; in a real antenna they are "distributed."

If the inductance and capacity of an antenna (artificial or real) are increased, its fundamental wavelength is increased. (The capacity is more easily changed than the inductance.) The resistance has no effect on the fundamental wavelength, but if the resistance is increased the current induced by the radio wave is decreased.

Imagine that the inductance of the artificial antenna is "distributed," and that the coil C is the tuning coil of the receiving set. Then we may connect a variable condenser across the terminals of the coil, and thereby increase the wavelength to which the complete antenna system will respond. To decrease the wavelength of the system, we may insert the condenser in the wire leading from the right-hand terminal of the coil to the box A.

The artificial antenna on page 28 is a poor receiver of radio waves because its dimensions are so small that it cannot pick up much energy.

In Fig. V is shown an antenna (erected on the roof of the Radio Building at the Bureau of Standards) which is used for receiving from radio telephone

broadcasting stations. The antenna is 115 feet long and 18 feet above the roof. The lead-in wire (shown at the right end) is 45 feet long and passes down the far side of the building, and then through a window. The resistance of this antenna was measured first with a ground connection made to a gas pipe (inside ground), and then with a ground connection made to a pipe driven into the ground (outside ground) directly below the lead-in wire. The measurements were repeated with a single wire in the horizontal part of the antenna. The other constants were measured with the inside ground only as the particular kind of ground connection would make little difference. The results of these measurements are given below:

RESISTANCE WITH INSIDE GROUND

- At 1,110 Meters
- 14 ohms (two-wire antenna)
- 6 ohms (single-wire antenna)
- At 400 Meters
- 34 ohms (two-wire antenna)
- 43 ohms (single-wire antenna)
- At 360 Meters
- 45 ohms (two-wire antenna)
- 37 ohms (single-wire antenna)

RESISTANCE WITH OUTSIDE GROUND

- At 1,110 Meters
- (Not measured for two-wire antenna)
- 16 ohms (single-wire antenna)
- At 400 Meters
- 22 ohms (two-wire antenna)
- 23 ohms (single-wire antenna)
- At 360 Meters
- 23 ohms (two-wire antenna)
- 17 ohms (single-wire antenna)

CAPACITY WITH INSIDE GROUND

- 0.00053 microfarad (two-wire antenna)
- 0.00038 microfarad (single-wire antenna)

FUNDAMENTAL WAVELENGTH

- 230 meters (two-wire antenna)
- 190 meters (single-wire antenna)

INDUCTANCE

- 25 microhenries (two-wire antenna)
- 22 microhenries (single-wire antenna)

These results show that the resistance of an antenna varies with wavelength, and that at the shorter wavelengths it

was reduced by using a single-wire antenna with an outside ground connection. Antenna capacity decreases as the wavelength increases, and then becomes approximately constant. The higher fundamental wavelength of the two-wire antenna is due to higher capacity and inductance as compared with a single wire.

How may one determine the constants of an antenna?

Resistance can only be measured with special apparatus which is elaborate and expensive. It can *not* be computed. The other constants can be measured with less elaborate and, consequently, less expensive apparatus. It is also possible for one who owns a receiving set to measure these other constants with fair accuracy by adding a few simple pieces of apparatus.

Capacity can be computed, although in many cases it is necessary to make allowances for intervening objects, and other factors. On some antennae the computed capacity will check closely with that measured. In other cases the accuracy is not so good. In the formula

$$C = \frac{12.2h \sqrt{A} + 2.7 A}{1,000,000 \times h} \dots (1)$$

C = capacity in microfarads

h = height of antenna above ground in feet

A = area of horizontal portion of antenna in square feet

To apply this formula to a single-wire antenna, A is obtained by multiplying the length of the nearly horizontal portion of the antenna by 2.5. The result obtained for C must be multiplied by a factor as follows:

LENGTH OF ANTENNA (IN FEET)	FACTOR
30	1.12
40	1.16
50	1.2
60	1.24

70	1.28
80	1.32
90	1.36
100	1.4

Owing to conditions about the average receiving antenna, this result should now be increased by about 20 percent. The factor is not used when the antenna has more than one wire and in addition has a length less than eight times its width.

Fundamental wavelength in meters may often be accurately computed for a single-wire antenna by multiplying the total length of wire in feet by 1.37. Practical allowances can be made for an antenna of several wires close to obstructions, although the result will not be so reliable.

The inductance (L) of an antenna can not be accurately computed by a theoretical formula. It can be computed after one knows the fundamental wavelength (λ_0) and capacity (C), from the formula

$$L = \frac{\lambda_0^2 \dots \dots \dots (2)}{3,550,000 \times C}$$

If the reader has not the facilities for measuring antenna constants, he may determine them by applying the formula just given.

To illustrate the method some typical antennas will be considered. The preceding formulæ and the following examples apply to "L" antennæ—the type used in the majority of cases. If the lead-in is taken from the center, the capacity remains about the same, but the fundamental wavelength is decreased.

Example 1:

A single wire 80 feet long and 40 feet high; lead-in wire is brought down vertically from one end. The antenna and lead-in are clear of obstructions. If the ground connection is good, the resistance

of this antenna at 360 meters should not be more than 15 ohms.

To compute the capacity use formula (1) and let $h = 40$ and $A = 80 \times 2.5 = 200$. Substituting these values in formula (1)

$$C = \frac{12.2 \times 40 \sqrt{200} + 2.7 \times 200}{1,000,000 \times 40} = 0.000186$$

This value is multiplied by the factor 1.32 giving

$$C = 0.000245$$

increasing the value 20 percent gives

$$C = 0.000294 \text{ microfarads}$$

If the antenna is close to trees or obstructions, or if the lead-in is closer than one foot from the building, the capacity will be increased still more.

The total length of wire (vertical and horizontal) in this antenna is 120 feet. Multiplying this by 1.37 gives 165 meters as the fundamental wavelength. Add 10 percent to this value if the antenna or lead-in is close to obstructions.

Inductance is computed from formula (2) and is:

$$L = \frac{(165)^2}{3,550,000 \times 0.000294} = 26 \text{ microhenries}$$

The same method of computation may be applied to single-wire antennæ of various heights and lengths.

Example 2.

A two-wire antenna 40 feet long and 50 feet high with the wires three feet apart; the lead-in wire is brought down vertically from one end. With a good ground connection the resistance of this antenna, if it hangs clear in space, should not be more than 10 ohms at 360 meters. Because of its comparatively short length this type of antenna is likely to be erected in a restricted space. In this case its resistance may be in-

creased two or three times. The capacity is computed as before, using $A = 40 \times 3$, and is found to be 0.000192 microfarads. (If the wires are closer than 3 feet, the value of A is the same). Although the antenna has more than one wire, its length is greater than eight times its width; a factor of 1.16 is therefore used in obtaining the result. As before, buildings or obstructions which are very close will increase this capacity.

Multiplying the total length of wire (90 feet) by 1.37 gives 125 meters as

the fundamental wavelength. This antenna has a capacity somewhat higher than if a single wire were used. The fundamental wavelength is thereby increased. To allow for this, increase 125 by 15 percent. This gives 145 meters for the fundamental wavelength. Again increase this value by 10 percent if obstructions are near. Inductance, computed as before, is 23 microhenries.

What is the best receiving antenna?

This is not an easy question to answer; in fact it can not be answered at all un-

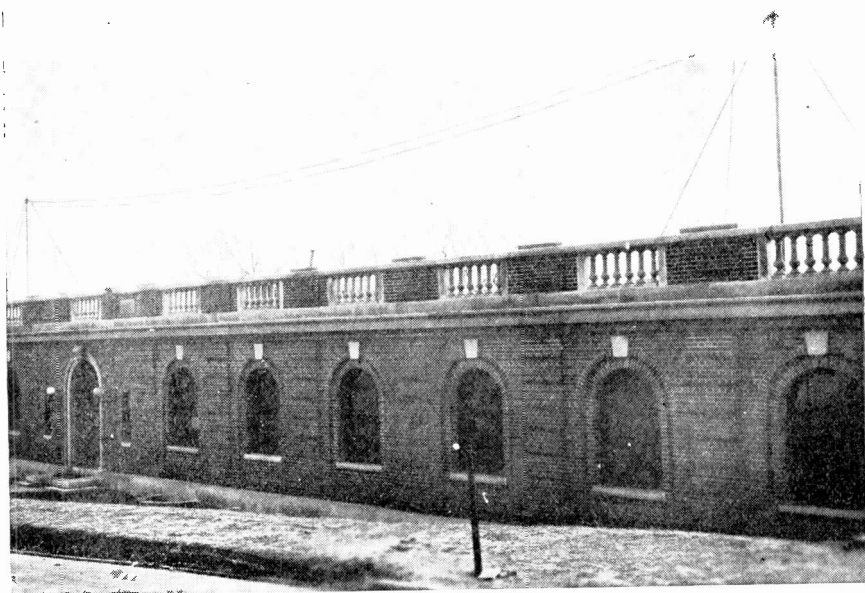

WHERE UNCLE SAM TESTS AMATEUR AERIALS

Figure V: A special two-wire testing antenna used by the Bureau of Standards in Washington. This is of the inverted L type, and was used for making the determinations explained in this article.

less one knows the location of the antenna and the type of receiving set.

If you have a receiving set with a regenerative tuner or one that employs some kind of radio frequency amplification it is not necessary to have a very high antenna; in some cases a high antenna may be a disadvantage. If you live in a part of the country where static is bad, a high vertical antenna (especially one of several wires) is undesirable. Instead, a single horizontal wire should be used. But if you have a receiving set with a simple (non-regenerative) detector and not more than one step of radio frequency amplification, it is well to have the antenna as high as possible, and also to keep it away from all obstructions. A receiving set connected in the ground lead close to the ground increases the effective height of the antenna and improves reception.

The following points apply irrespective of the kind of receiving set:

(1) Unless you are using an antenna near its fundamental wavelength or one which is exceptionally long compared to its height its directional effect will be slight and not worth considering.

(2) The antenna and lead-in should be kept as free as possible from swaying. The lead-in should be kept as far from obstructions as possible. The vertical part of an antenna is as important as the horizontal part. After the wire has entered the building, it must not be tacked to the wall.

(3) No. 14 copper wire is large enough for any ordinary receiving antenna and ground connection. Larger wire or stranded wire is better because it is mechanically stronger. Of course the greater the surface area, the lower the resistance, but in practice there are so many other features of resistance involved that a larger conductor than No.

14 is not necessary. It makes no difference whether the wire is bare or insulated.

(4) All connections, especially those made outdoors, should be soldered; this insures permanently low resistance. Ground connections to a pipe can best be made with a clamp; a clean surface for contact should be secured. It sometimes happens that a receiving station is situated where the soil is dry and where there is no natural ground connection; in this case a counterpoise (which is nothing but another antenna suspended near the surface of the ground, under the regular antenna) should be substituted. The counterpoise should consist of several parallel wires.

(5) Unless a high antenna is used, natural supports can usually be found. The ropes that support the antenna should have insulators inserted in them. Glazed porcelain is best, but oak blocks boiled in paraffin can be used.

(6) If the fundamental wavelength of the antenna is above 250 meters, a condenser connected in series with the wire leading to the receiving set should be used. If a fixed condenser is used its capacity should be about 0.0003 microfarad. To allow tuning to a wider range of wavelengths a special switch may be used in such a way that a variable condenser may be connected in series with the coil or shunted across the terminals.

(7) It is a good plan to take the lead-in from the center of the antenna instead of the end, when by so doing extra bends can be eliminated.

(8) A water pipe is a better ground connection than a radiator or gas pipe. An iron pipe driven several feet in moist earth may be used.

(9) A single wire will usually give as good results as several wires in the hori-

zontal portion of an antenna. If space is limited, two or more wires may be used.

This matter concerns antennas most effective in the reception of wavelengths between 200 to 450 meters.

A wavemeter is one of the most essential instruments used in radio. Now that so many transmitting stations have been given wavelengths close together, the wavemeter assumes even greater importance than formerly.

As its name implies the wavemeter is used to measure the wave emitted by a source of radio frequency oscillations.

The most important point to know about this wave is its length—how far it is from the crest of one wave to that of the adjoining wave. This distance is called the wavelength. This distance is related directly to the frequency number of waves or impulses a second, by the relation $\lambda = V/F$ where λ = wavelength in meters, V = velocity of electro-magnetic waves (about 3×10^8) meters a second) and F = frequency of electro-magnetic waves a second.

Radio frequency currents reverse the direction of their flow from (say) 10,000 to 30,000,000 times a second. Audio

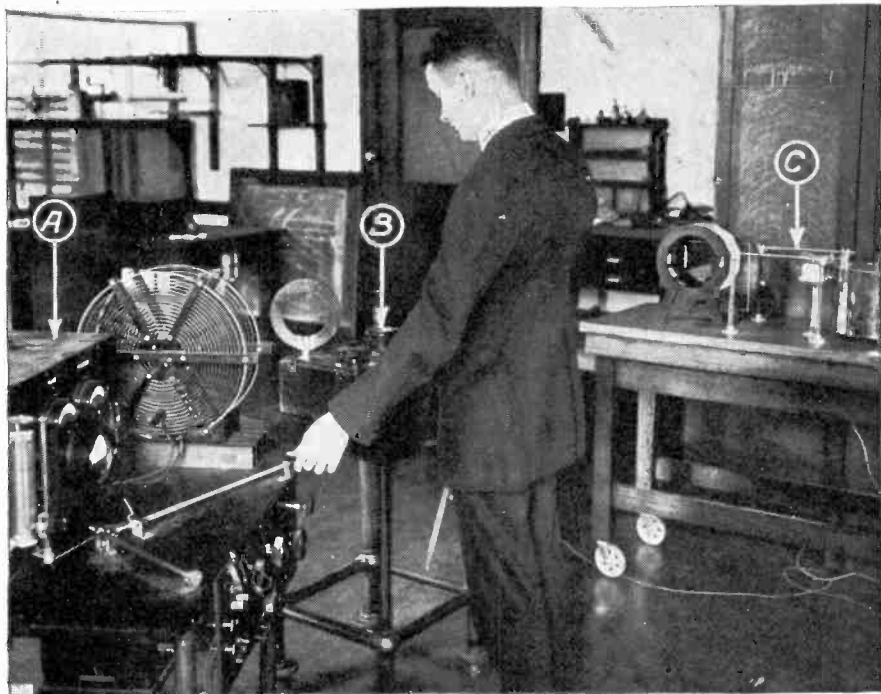

TESTING A WAVEMETER IN THE LABORATORY OF THE BUREAU OF STANDARDS

Figure W: To calibrate an unknown wavemeter B, a high-frequency generator A, is used for generating a wave which is accurately measured by the standard wavemeter C. Then the unknown wavemeter B, is tuned to the frequency of the incoming wave and the setting of the instrument checked.

frequency currents reverse the direction of their flow from 16 to 10,000 or 15,000 times a second. It is possible to build a frequency indicator that will respond directly to each alternation up to 500 or 1,000 cycles a second, but beyond that other means for determining the frequency may be employed, such as comparing the audible note produced to that of a known source, such as a tuning fork.

When we consider radio frequency currents we see at once that some other method of determining the extremely rapid alternations is necessary. This is done by employment of the principle of resonance and by taking advantage of the large current which flows in a radio

circuit that is in resonance with a "driving" circuit—that is, a circuit that emits waves or impulses of the same frequency.

Wavemeters may be of two types: receiving or transmitting. Both contain an inductance and a capacity. The inductance is usually made up of one or more interchangeable coils of different sizes, and the capacity is a variable air condenser.

The receiving type of wavemeter employs a means for indicating when the maximum current is flowing in the circuit. This is sometimes a visual means (such as a thermal galvanometer of some type, a small battery lamp or a vacuum tube filled with some inert gas

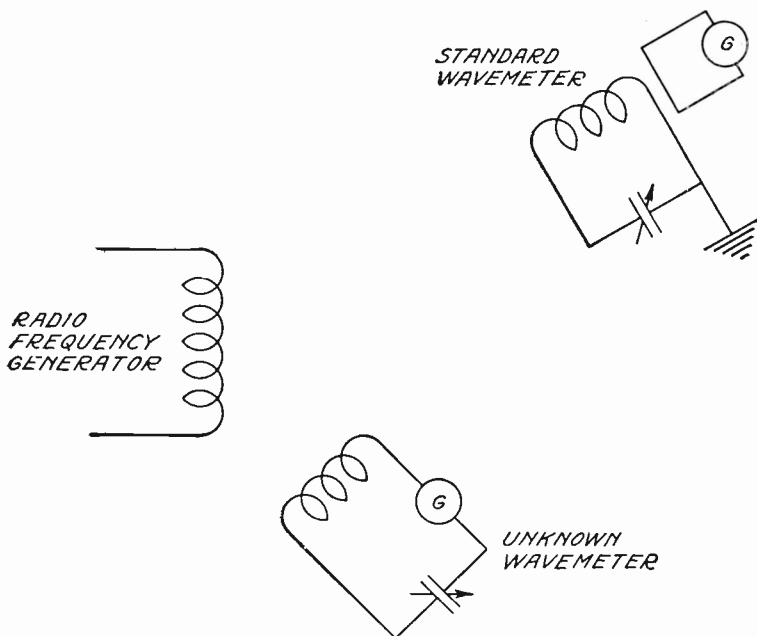

HOW TO CALIBRATE A WAVEMETER BY MEANS OF A HIGH-FREQUENCY GENERATOR

Figure X: Here is a schematic diagram that illustrates the method of calibrating an unknown wavemeter by means of a high-frequency generator and a standard wavemeter as illustrated by the set-up shown in Figure W. Resonance in this case is indicated by a galvanometer in the circuit of the unknown wavemeter.

like neon which glows when an electric discharge passes through it), or it may be an audible means, such as a crystal detector and telephone receiver.

The transmitting type of wavemeter usually employs a battery-excited buzzer. The buzzer energizes the wavemeter circuit by impact, and the latter discharges, causing an oscillating current to flow in the wavemeter, the frequency of which is governed by the values of inductance and capacity in the electrical circuit.

There are several methods of connecting the various resonance indicators to the wavemeter; each has its own merits. The purpose of this article, however, is not to discuss the relative merits of the

various connections, but to give a general idea of the method of calibrating a wavemeter.

The range of frequencies or wavelengths which a wavemeter will possess can be calculated readily beforehand, but an absolute calibration of the instrument can only be obtained by comparison with a wavemeter which has been calibrated or standardized.

The calibration of a wavemeter should not be considered to be exactly correct without regard to the time when the calibration was made. That this may be assumed was shown by a request received some time ago from a manufacturer of wavemeters, who asked for a copy of the calibration of a certain wavemeter.

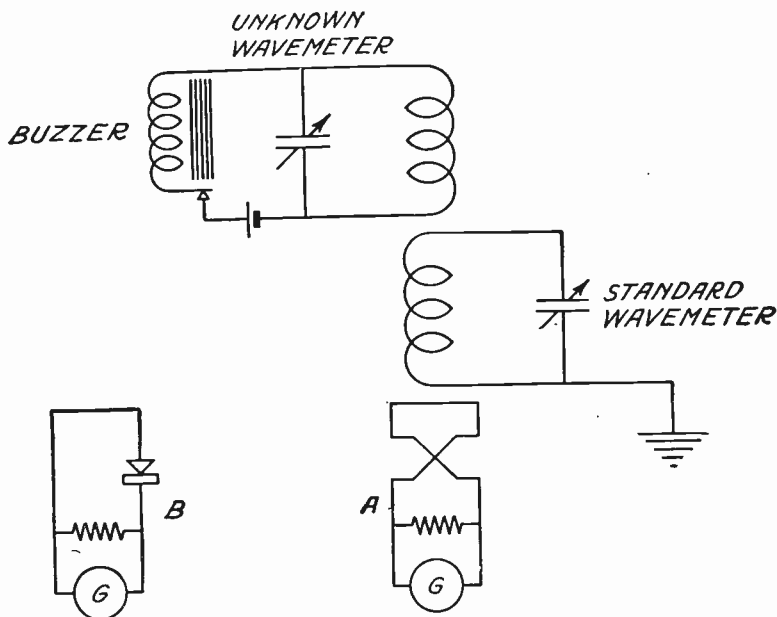

HOW TO CALIBRATE A WAVEMETER THAT HAS A UNI-LATERAL CONNECTION

Figure Y: To calibrate an unknown wavemeter employing a uni-lateral connection either a crystal detector may be used or else a milliammeter, as indicated by the dotted circle.

Upon looking up the data for this wavemeter it was found that the calibration had been made six or eight years ago, so that it could not be depended upon after so long a time.

For accuracy, a wavemeter should be checked up at least once a year.

In calibrating a wavemeter the following apparatus is required: a radio frequency generator capable of emitting any desired frequency over the range of wavelengths covered by the wavemeter under test, a standard wavemeter which is calibrated in terms of frequency or wavelength, the wavemeter to be tested, and a sheet of paper upon which to take data.

Five or more points should be selected

on the scale of the condenser of the wavemeter under test, at which tests are to be made. In selecting these points the extremes of the scale should be avoided. The lower ten degrees on the scale should not be used (except in extreme cases to obtain an overlap between two coils). This lower portion is avoided because of the small capacity in the wavemeter circuit in this region and the proportionally larger liability of introducing errors by reason of the proximity of other objects. The upper limit of the scale should be avoided because of the chance of error in the resulting calibration curve in case the scale is not set exactly correct with respect to the condenser plates.

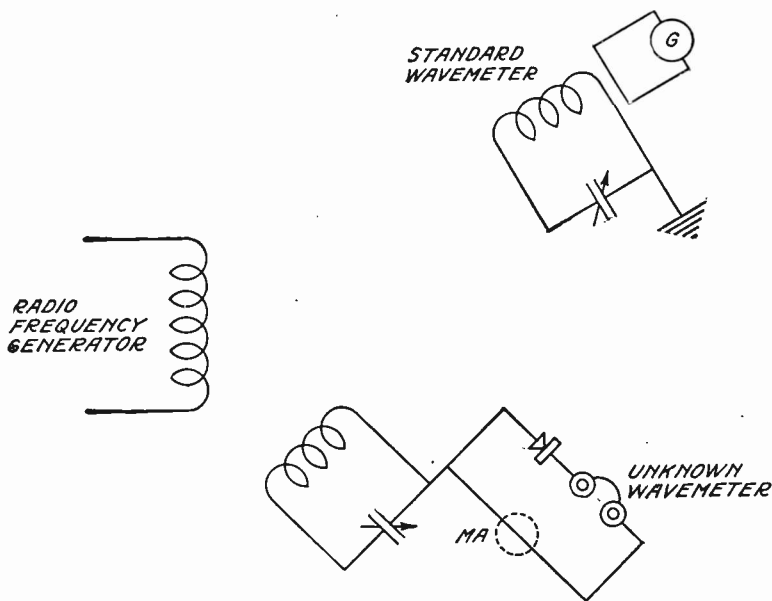

HOW TO CALIBRATE A WAVEMETER THAT EMPLOYS BUZZER EXCITATION

Figure 2: In this case no external generator is necessary. The standard wavemeter is moved up close to the generator; sometimes extremely close proximity is necessary on account of the small amount of energy emitted by the buzzer. The settings on the scales of the two instruments are then compared and the unknown meter is corrected to correspond to the standard.

In starting the calibration, the condenser of the wavemeter to be tested is set at the first point and the radio frequency generator is varied until resonance is indicated by the indicating instrument of the wavemeter. The condenser of the latter should then be varied slightly in each direction to determine whether true resonance has been obtained.

At times it is possible to appear to have reached the resonance point by tuning the generator to the wavemeter but if the wavemeter condenser is varied somewhat it may be found that resonance is obtained somewhat away from

the desired point. This may be caused by a reaction of the wavemeter upon the generator owing to too close coupling between the two, or it may be due to the capacity existing between the wavemeter and the operator's body. If a wavemeter is properly shielded this latter difficulty will not be observed, except perhaps near the minimum setting of the condenser.

A wavemeter, whether used for measurement purposes or in calibrating, should be coupled as loosely as possible to the source of power. If the wavemeter is coupled too closely to the generator it will react upon the generator.



Pacific and Atlantic

A "PRECISION WAVEMETER"

Figure AA: The Bureau of Standards has done some wonderful development work in designing and constructing standards of measurement. These standards include instruments for exact measurement of length, weight, velocity, pitch, and intensity in practically all fields where measurement can be made.

This condition is more likely to occur on coils of large inductance which have a large distributed capacity and a high resistance. It may be observed on the wavemeter by obtaining two *apparent* resonance points, by turning the condenser in opposite directions. These two points may be a fraction of a degree to several degrees apart. The only thing to be done in such cases is to move the wavemeter away from the generator (loosen the coupling) until but one point is observed.

Another reason for keeping the coupling fairly loose when calibrating the wavemeter is because the power that exists in harmonics of the fundamental frequency may be picked up instead of the fundamental frequency. A radio frequency generator does not have its entire power output at one frequency; it is distributed upon several frequencies which bear certain relations to the fundamental frequency or that obtained from calculations of the inductance and capacity in the circuit. The fundamental frequency has the greater part of the power, but the harmonics may have sufficient power to operate a sensitive detector. Usually no difficulty is experienced from tuning to harmonics when a hot-wire ammeter or thermogalvanometer is used as the resonance indicator.

After the generator is accurately tuned to the wavemeter at the point desired, the wavemeter is detuned and moved away from the generator and the standard wavemeter is brought up and tuned to the generator. The condenser setting of the standard wavemeter is then read and is entered on the data sheet opposite the proper condenser setting of the wavemeter under test. The identification numbers of all apparatus used should be kept so that errors will be avoided in computing results.

The standard wavemeter is next detuned and moved away from the generator and the first one brought up and the generator tuned to the second point. All points throughout the series of coils are obtained in a similar manner. After the first complete test is finished it is repeated and the average of the two values for a given point is taken, unless there is too much of a difference between the values. In such a case a third reading is taken at the doubtful point, and it is likely that two of the three readings will agree sufficiently well. Errors in measurement or calculation are sometimes apparent when the calibration curve is drawn, because one or more points fail to lie on a smooth curve joining the majority of the determined points. The frequency or wavelength for other settings of the condenser than those at which tests are made can be obtained by reference to the calibration curve.

The calibration of a wavemeter that uses a crystal detector and telephone receivers as a resonance indicator is made in the same manner. If an electron tube radio frequency generator is used, undamped waves are produced and a means of modulation must be provided to produce a response in the telephone receivers, such as applying an alternating potential to the grid circuit of the generator. It will often be found that the resonance point is quite broad and that it is difficult to determine the exact point of resonance. Sometimes when the unilateral connection of the detector and telephone receivers is used a sensitive direct current milliammeter may be connected in the circuit (as shown by the dotted circle in Fig. Z) without appreciably altering the resonance point. Then it is possible to obtain a sharp indication of resonance.

Before this method is used, the wavemeter should be tried out both ways to

determine if the probable error in using the millimeter is negligible. If the difference in resonance points by the two methods is significant, the millimeter should *not* be used.

When calibrating a buzzer-excited wavemeter, the condenser of the latter is set at the desired point and the buzzer started. The standard wavemeter is brought up and tuned to resonance with the buzzer wavemeter. Difficulties are often encountered here owing to the extremely small amount of power emitted by the buzzer wavemeter. Extremely close coupling between the two wavemeters is often necessary. The resonance indicator of the standard wavemeter may be a thermo-element instrument of the crossed-wire type, with a couple of turns of wire connected to two terminals and coupled to the inductance coil of the standard wavemeter, and the

other two terminals connected to a galvanometer, as shown at (a) in Fig. Y.

Another indicator that is suitable consists of a coil of a couple of turns, a sensitive crystal detector and a wall galvanometer, all connected in series as shown at (b) in Fig. Y.

Thus it is evident that in calibrating a wavemeter, whether of the receiving or the transmitting type, it is necessary to have a radio frequency current with a frequency or wavelength that corresponds to that of the wavemeter under test for the particular setting under consideration. This frequency will be determined by means of the resonance indicator of the calibrated wavemeter.

Wavemeters should be checked up with an accurately calibrated wavemeter at least once a year to be certain that the calibration has not changed.

One of the most important problems

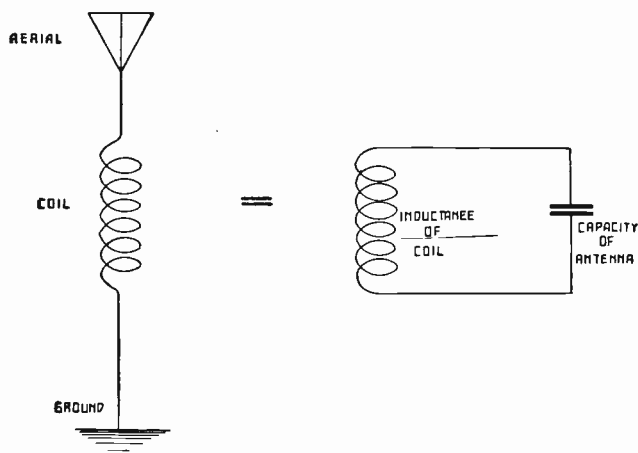

FIGURE BB

Calculations for an antenna circuit with a coil in series resolve themselves into a simple formula for wavelength of a coil with a condenser shunted across it. The condenser in this case represents the capacity between the antenna and the ground.

CAPACITY
IN
MICROFARADS

WAVELENGTH
IN
METERS

INDUCTANCE
IN
MICROHENRYS

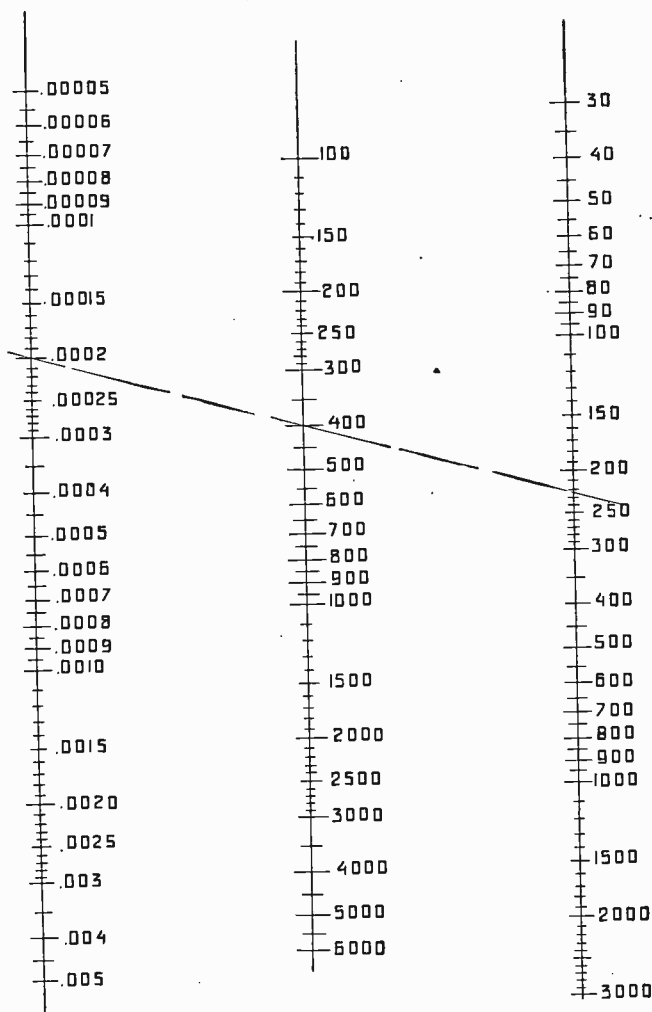

A CHART FOR DETERMINING THE CONSTANTS FOR YOUR SET

Figure CC: By merely laying his ruler across this chart (in the manner indicated by the diagonal line) the practical amateur may calculate the proper sizes for the condensers and the inductances of the set he proposes to build for use with a certain wavelength range. He need know little or no mathematics; the chart solves the difficult and intricate problems involved. The amateur has only to read from the chart this answer to his particular problem.

to confront the amateur who designs his own radio set is how to calculate the correct sizes of the inductances and the condensers for the various parts of a radio circuit for a given wavelength.

There are several mathematical formulas for determining these "constants" as they are called. But these formulas are usually so complicated that they are not much used by the ordinary amateur.

Most amateurs who design their sets resort to the "cut and try" system; that is, they wind a temporary coil with taps, connect it in the circuit, find the correct tap and then build a permanent coil with a corresponding number of turns on it. Sometimes they build a number of coils and try them all out in order to find the best size to use.

Fairly good results are often obtained in this way, but this method is obviously unscientific. It entails a waste of time, energy and money. It is better and more practical to use standard formulæ that will give the correct sizes for all parts to be built; further, these standard formulæ enable the builder to design his set on paper and then build it according to the recorded specifications; in that way he will know in advance just what the results will be.

For the benefit of the average amateur some of these standard formulæ have been simplified and are represented here in the form of "alignment charts."

These charts offer the most convenient possible way of solving equations which have three or four variables. They make it possible for the ordinary radio fan to use the charts without the aid of anything more than common sense and a ruler.

The prime problem to be dealt with in radio is that of "resonance" in the different circuits. In order to have resonance in a circuit, or in other words, in order to tune a circuit to any particular wave-

length, the circuit must contain inductance in the form of a coil, and capacity in the form of a condenser. A certain value of inductance and a certain value of capacity together in a circuit give it a certain wavelength; unless either or both of these values are varied, the circuit will absorb energy of no other wavelength.

The basic formula for the wavelength (W. L.) follows the equation:

$$W.L. = 1884 \sqrt{LXC} \dots\dots 1$$

wherein L is the inductance in microhenries and C the capacity in microfarads. The above formula is shown in chart form in Fig. CC.

In order to illustrate the method of using this chart, let us take the following problem: In Fig. BB we have a coil connected in an antenna circuit. This circuit is equivalent to a coil with a condenser connected across it—the condenser in this case being the capacity between the antenna and ground.

The example is this:

To find the proper value of inductance for this coil when used in an antenna circuit that has a capacity of .0002 microfarads, in order to tune up to 400 meters. With a ruler on the chart in Fig. CC, connect the value of capacity (.0002 mfd.) on scale 1, with the wavelength desired (400 meters) on scale 2. The answer will be found at the intersection on scale 3; it is 225 microhenries.

This same example applies to calculations for a secondary circuit in which the capacity will be the variable condenser connected across the coil.

To calculate a circuit that has two capacities (as shown in Fig. BB), we find first the resulting capacity which will follow the relation:

$$\frac{1}{C} = \frac{1}{C_1} + \frac{1}{C_2} \dots\dots 2$$

wherein c_1 , c_2 are the capacities connected in series and c is the resulting capacity. This formula is plotted on a chart shown in Fig. DD.

Let us take another example:

Find the correct value of inductance to use in a circuit shown in Fig. EE in which a condenser is placed in series with the antenna circuit, the antenna having a capacity of .00025 mfd. and the condenser a capacity of .001 mfd. to tune to 400 meters.

The first step is to find the resulting capacity of the two condensers with the aid of the chart in Fig. DD. Connect .001 on scale No. 1 with .0025 on scale No. 2 by a straight line and read at the intersection with scale No. 3 the resulting capacity of .0002 mfd. Having a capacity of .0002 mfd. and a desired wavelength of 400 meters, we find that we will need an inductance of 225 microhenries, as found in the first example we have given.

The chart shown in Fig. CC may also be used to find the wavelength, when the capacity and inductance are known, or to find the capacity when the inductance and wavelength are known. The general rule is this: Connect two known values on any two scales and the unknown will be found where the line crosses on the remaining scale.

The amateur is advised to keep these charts for reference, to be used along with additional charts on the design of coils necessary to get a certain value of inductance, and also with charts that will calculate the capacity of an antenna.

By the use of these charts the amateur may design his set with a definite knowledge of what wavelength range to expect when his set is finally put together and connected up.

When the amateur has finally decided what range of wavelengths he

desires to cover in his proposed transmitting or receiving set, and when he has determined the correct electrical constants for the coils which will cover this range, the next step is to construct the coils that will have these constants.

In other words, if the amateur wants to tune to a wavelength of 400 meters and he has an antenna with a capacity of approximately .0002 mfd., his primary coil should have an inductance of 225 microhenries. The question now is:

"What size of coil will I make that will give me this value of inductance?"

Of course the answer can be figured out mathematically by an engineer, but the average radio fan would find himself in water too deep for him if he should try to do it himself.

However, the simple alignment charts that accompany this matter have been prepared so that even the novice will find the answer to his problem in a few seconds. These charts are based on mathematical formulas, but all the reader must know is how to draw a straight line and how to read figures.

For the benefit of the more experienced amateur who understands something of mathematics, we will show how the alignment charts for inductance and design of a coil were evolved.

The formula for inductance of a coil follows the equation:

$$L = 4\pi^2 \left(\frac{d}{2}\right)^2 n^2 l K \dots\dots\dots 1$$

wherein

- L = the inductance required.
- d = the diameter of the coil in centimeters.
- l = the length of the coil in centimeters.
- n = the number of turns per centimeter.
- and k = a constant depending on the ratio d/l

As the correction factor k depends on the relation of the diameter and the

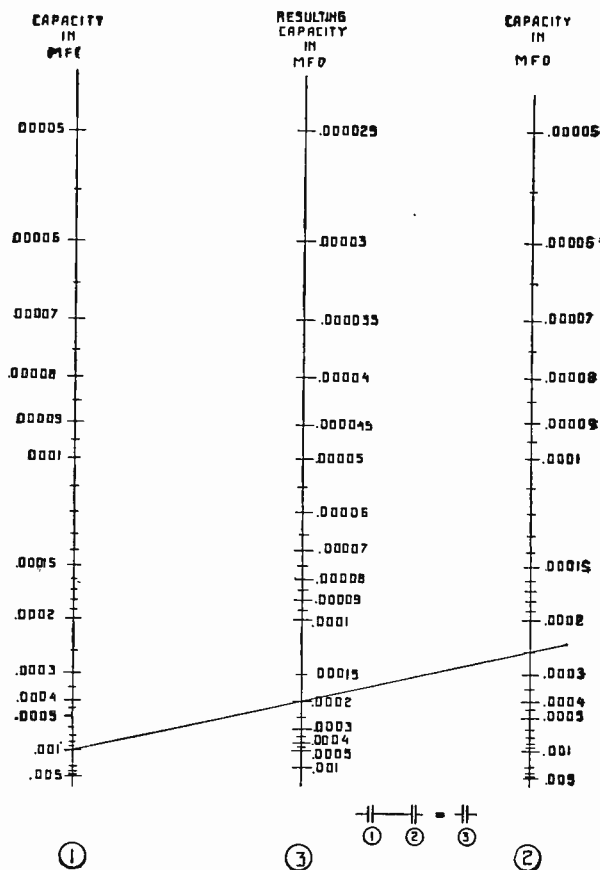

A CHART FOR CALCULATING THE CAPACITY OF CONDENSERS IN SERIES

Figure DD: The capacity of two condensers connected in parallel may be easily found by adding the capacities of each of the condensers together, which will give the capacity of the whole. But to determine the capacity of condensers in series is a more complicated matter. This chart indicates the answer to this problem; by laying a ruler across, as indicated by the diagonal line, calculations may be made.

length of the coil, we cannot, by means of the above formula, calculate directly the dimensions of a coil assuming the other three variables.

Therefore, in order to make the equation No. 1 available for a simple alignment chart, we will have to eliminate the coefficient k . We plot the correction factor against the ratio d/l on a sheet of logarithmic cross-section paper and substitute a straight line for the curve. By so doing we eliminate this troublesome feature of the formula, with results which will not differ perceptibly from the original values, within the practical limits of a coil design.

The equation for a straight line on logarithmic paper has the form:

$$y = cx^n \dots \dots \dots 2$$

where y and x are variables and c and n are constants.

One of the most important, but extremely uncertain, of calculations in radio engineering and design is the determination of the constants of the antenna system.

Under the term "antenna system" we understand the total construction outside of the set, connected to it in order to transmit to or receive signals from a distant radio station. These include the antenna proper, grounds, fire-escapes, bedsprings, or any other aerial system used to radiate or collect energy.

Previously, we showed that for a certain wavelength we require a certain amount of capacity and a certain amount of inductance. To use the first

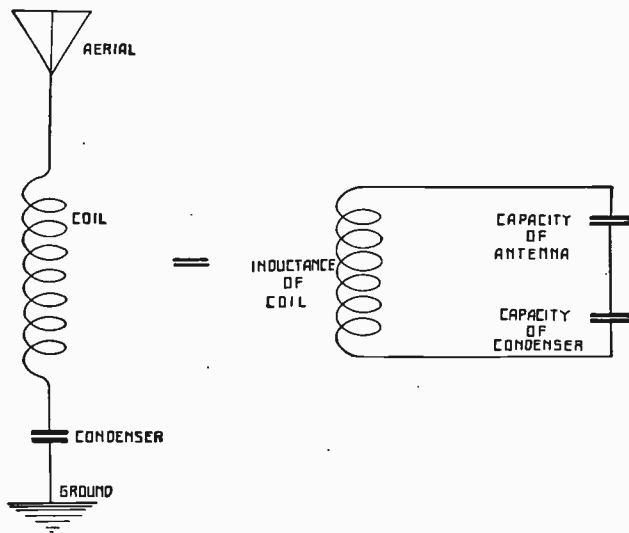

FIGURE EE

To calculate an antenna circuit with a coil and a condenser in series resolves itself into a formula for a coil with two condensers in series with it. One of these capacities is the condenser and the other is that between the antenna and the ground. These are added together by means of the chart in Figure DD.

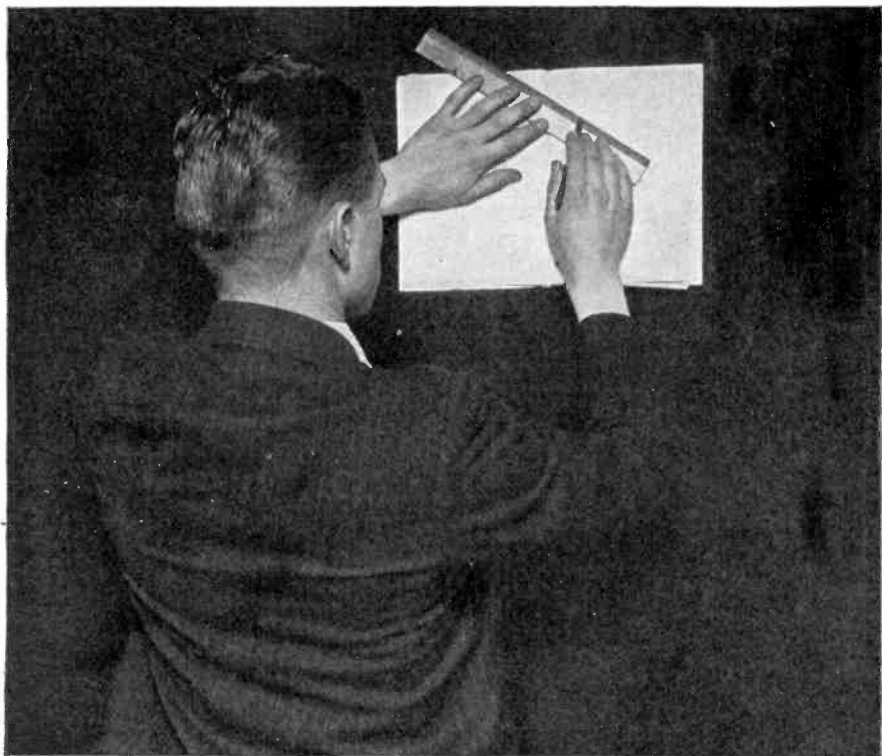

Figure FF: Lay your ruler across the alignment chart, as described in this article—and read off at a glance the answer to your problems in calculations.

two charts, however, we were required to know the amount of capacity incorporated in the design of our antenna, in order to calculate the correct coil to use with our antenna for a given wavelength.

In this matter, then, we are introducing a chart that gives us the capacity of our antenna, with the requisite amount of accuracy to calculate the proper inductance for the coil to use with it.

To take advantage of simplicity, without deviating from accuracy—and the practical radio engineer always welcomes simplicity—we will neglect the induc-

tance of the antenna, as it is small in comparison with the inductance of the coil to be used with it. This will not materially affect our calculations.

The chart Fig. JJ for calculating the capacity and fundamental wavelength of our antenna system is derived from data obtained from many experimental tests and laboratory experiments on vertical and horizontal antennas.

We will readily see by trying a few calculations on imaginary antennæ (with the aid of the chart) that the longer and wider (or the more wires used) our antenna is constructed, the

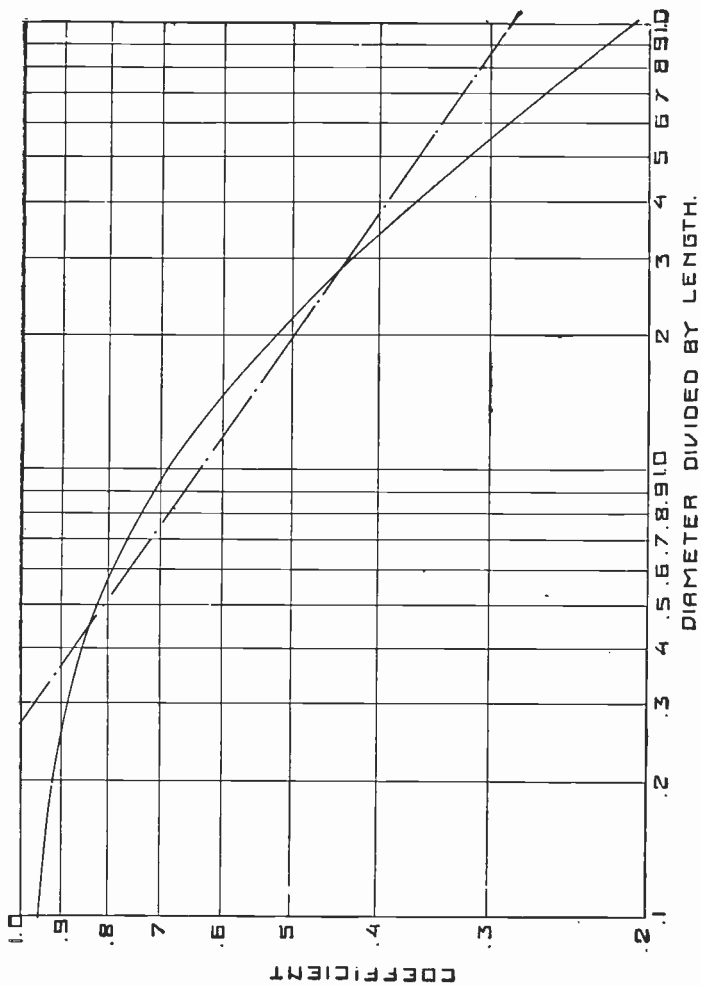

A STEP IN THE PREPARATION OF THE CHART

Figure GG: In this diagram we have the correction factor k , plotted against the ratio $d-l$, which is shown in the form of a curve. In order to eliminate the factor k from the formula used in the charts, this curve has been replaced by a straight line with results that do not differ perceptibly from the original values in the original curve.

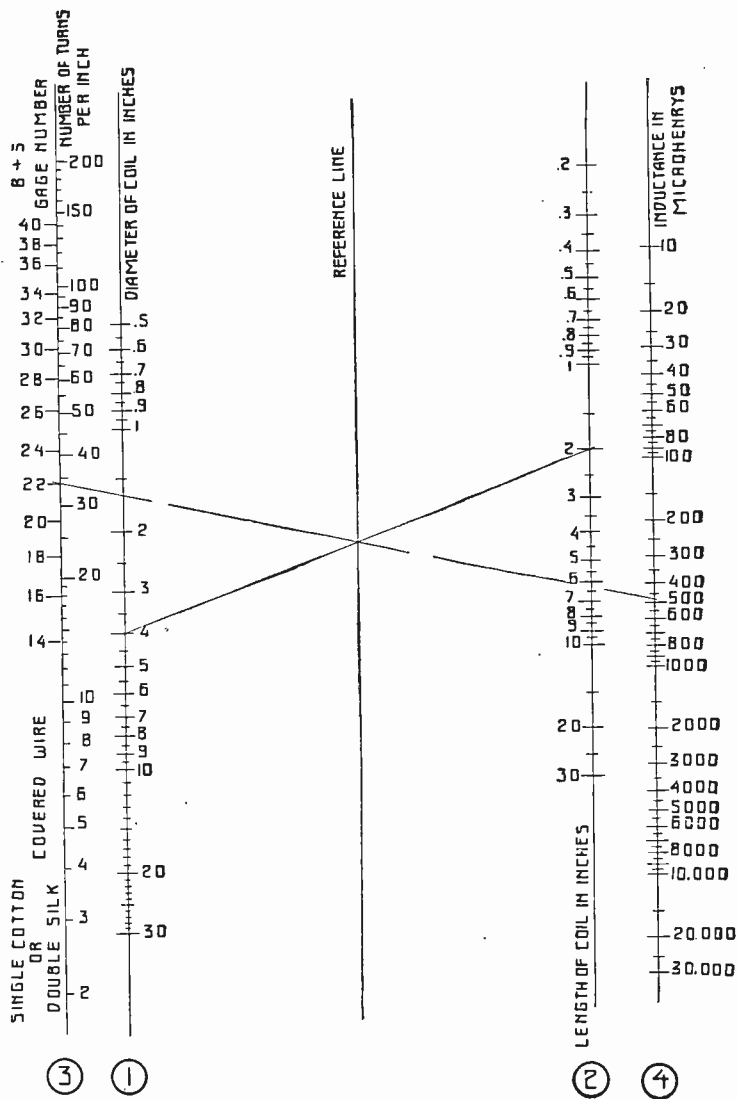

USE YOUR RULER ON THIS CHART—

Figure HH: As described in the accompanying text—to learn the exact dimensions of the coil you need.

more capacity it will have, and the higher up it is suspended the less capacity it will have.

The chart has five scales.

Scale No. 1 indicates the effective length of the antenna (figuring the full length of the horizontal part and half the length of the vertical part.)

Scale No. 2 contains the width of the antenna; (it also indicates the imaginary width to use for the single wire antenna). When more than one wire is used, the width will be the distance between the outer wires. The wires should be spaced not closer than two feet and not farther apart than four feet in order to be effective.

Scale No. 3 indicates the value of the effective height from the ground.

Scale No. 4 gives the resultant capacity in microfarads.

Scale No. 5 gives the approximate natural fundamental wavelength of the antenna, which corresponds to the values on the Scale No. 1, and in accordance with the standard formula:

$$\lambda = 1.38 l$$

wherein λ = the natural wavelength of the antenna in meters,

and l = the length of the antenna in feet.

Let us work out the following example in order to understand clearly how to use the chart:

We have an antenna with a 45-foot horizontal, single-wire stretch, a 40-foot vertical lead-in, and a 10-foot ground connection.

Taking the full amount for the horizontal wire (45 feet) and half the amount for the vertical part

$$\frac{(40 + 10)}{2} = 25 \text{ ft.}$$

We will have an effective length of $(45 + 25) = 70$ feet.

Connecting 70 on scale No. 1 with the mark "single wire" on Scale No. 2, and

then connecting the point of intersection (of this line we have drawn with the reference line) with the effective height of the antenna $(40 + 10) = 50$ feet, on Scale No. 3, we may read the resulting capacity of the antenna on Scale No. 4.

The approximate natural wavelength of this antenna would be about 97 meters.

In these days of modern radio when the multi-stage radio frequency amplifier, the super-heterodyne receiver, the super-regenerative receiver, and the various reflex circuit receivers have been coming into more or less general use, the loop antenna for receiving has been brought more into prominence.

The three outstanding advantages of the loop type antenna—its directional effect, the simplicity of tuning and the absence of the troublesome and bulky outdoor antenna—are important to the city fan who is interested in receiving only.

There are several standard receiving sets now being placed upon the market that incorporate the loop antenna. However, there are many people who make their own sets, and who are experimenting with radio frequency amplification who have occasion to design and build their own loop antennas.

And the question "How many turns of wire shall I wind on the loop" is not often answered correctly.

For their benefit we have prepared this chart, that tells exactly how many turns of wire to use for a given wavelength range. A loop antenna is almost universally tuned by placing it in shunt to a good variable condenser and this is all that is necessary in the way of tuning.

First of all, the wavelength range should be decided upon.

Then the size of variable condenser should be chosen for use with the loop.

With these two points determined the prospective builder may easily calculate



KNOW THE CAPACITY OF YOUR AERIAL!

Figure II: Everyone who uses either a receiving or transmitting set employs an antenna of some kind, and the value of his set is largely dependent upon the efficiency of it.

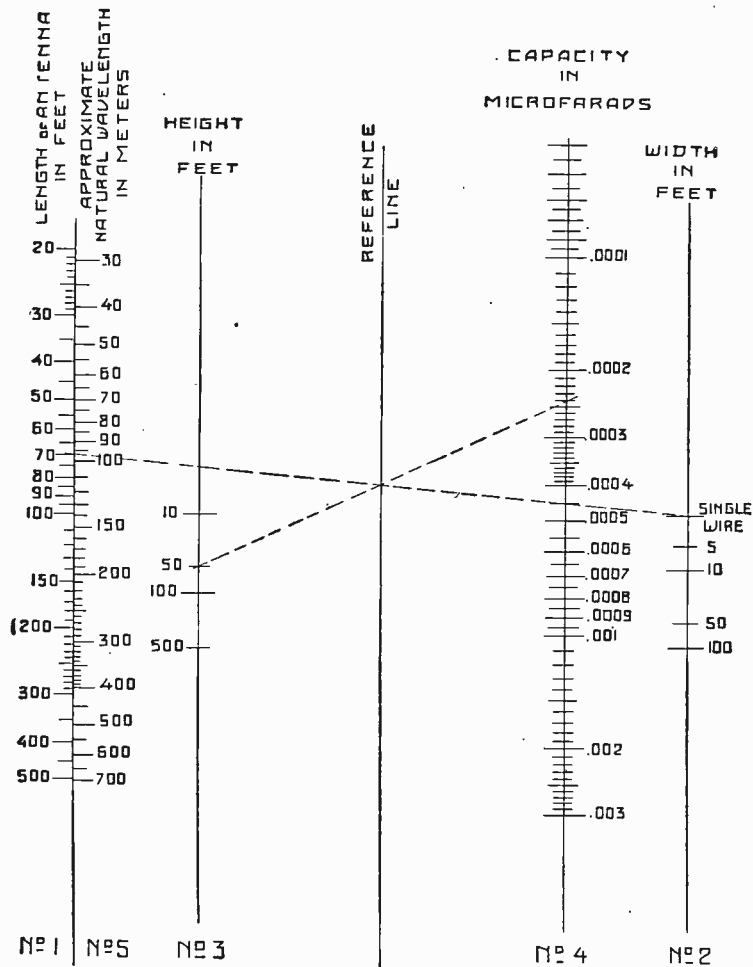

HOW TO USE THE CHART FOR DETERMINING THE CAPACITY OF YOUR ANTENNA

Figure JJ: With a ruler, connect the effective length of your antenna (scale No. 1) with the width of the antenna (scale No. 2). Then connect the effective height of the antenna (scale No. 3) with the intersection of the first line and the reference line. Carry the line out over scale No. 4—which will indicate the capacity of the antenna.

the necessary inductance which must be used in the loop to cover the wavelength range chosen. A previous chart tells you how to do this.

When this inductance is known, you may then use the chart in the present instruction, for calculating the correct number of turns of wire to use to give the required inductance value.

The accompanying chart (Fig. LL) is based on the square form of loop, on which the wires are spaced $\frac{1}{2}$ an inch apart.

This form of loop should not be mistaken for the spiral loop.

When you use the chart, connect values on scale No. 1, with values on scale No. 3, with a ruler and read the number of turns required on scale No. 2.

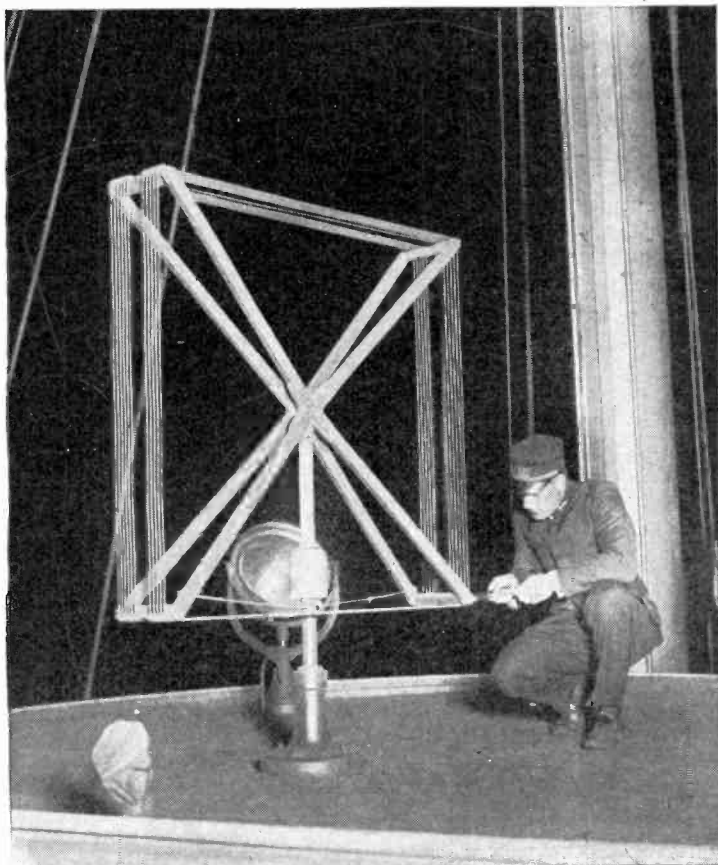

Kadel & Herbert

A LOOP ANTENNA INSURES HIGH SELECTIVITY

Figure KK: When used with supersensitive amplifying systems it is a valuable aid in doing away with static and interference. The loop shown here is located on the deck of a Navy compass station.

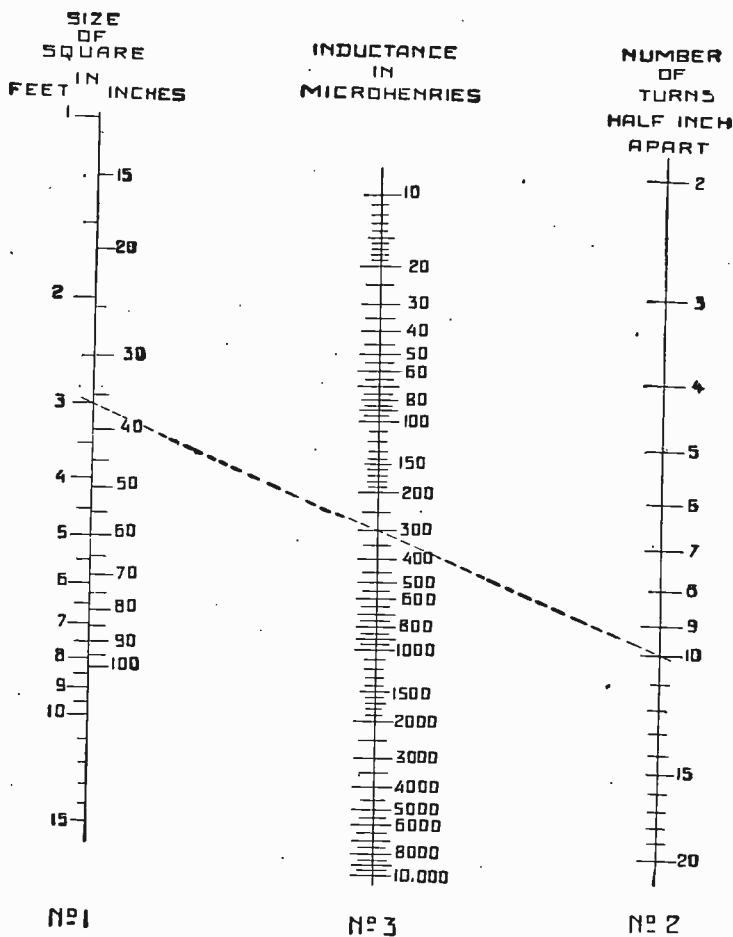

HOW TO USE THE CHART

Figure LL. PROBLEM: If you should want to build a loop antenna that would have a dimension of three feet to a side, and you wanted to incorporate in the loop enough turns of wire to give an inductance of 300 microhenries, how many turns would you wind on it?

SOLUTION: First, connect the value 3 on scale No. 1, with the value 300 on scale No. 3, with a ruler, and carry the line out over scale No. 2. Then observe the value on scale No. 2 where the line crosses the scale—which value would be the correct number of turns of wire to use.

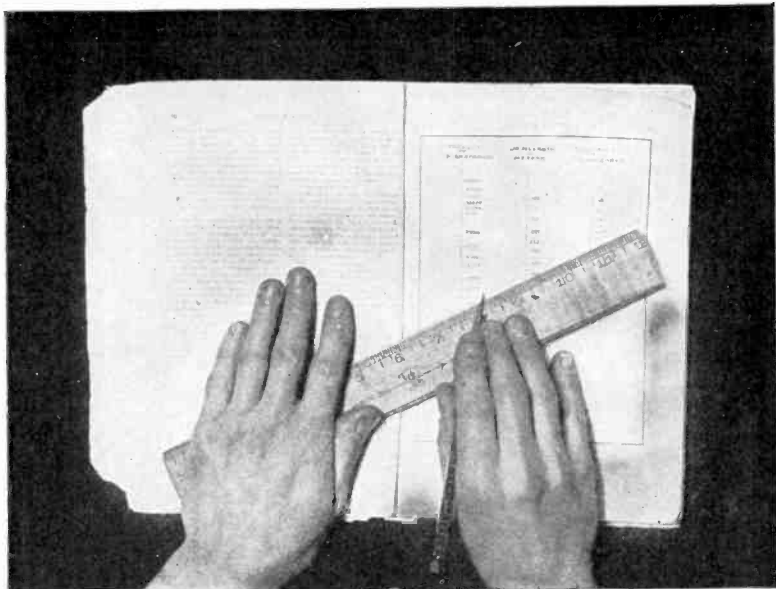

ALL YOU NEED IS A RULER, A PENCIL AND A PAIR OF HANDS

Figure MM: By means of the table on page 59 the amateur who builds his own apparatus may calculate in an instant the design for a condenser that will have a pre-determined capacity, or find out the capacity of a condenser that is already built.

Example:

To build a loop on a square form, 3 feet on each side, with the wires spaced $\frac{1}{2}$ inch apart to have a total inductance value of 300 microhenries. How many turns of wire should be used?

With a ruler, connect the size of the loop (3 feet), on scale No. 1, with the desired inductance value (300 microhenries) on scale No. 3. If this line, connecting the two points is extended over to scale No. 2 it will cross at the correct number of turns (10 turns).

Alternating current may be transformed from one voltage to another by the use of a transformer that consists of a primary and secondary winding wound on an iron core.

The transformers are used to "step up" or to "step down" the voltage of the current.

The "step up" transformer may be used for the CW (continuous wave) transmitting stations; the "step down" transformer may be used for supplying low-voltage current for charging storage batteries. Some form of rectifier must be used in the latter case.

The fundamental formula for the transformer is

$$E = 4.44 f F_m n 100,000,000.$$

Where E = the effective value of the impressed voltage.

f = the frequency.

F_m = the maximum value of the magnetic flux.

and n = the number of the primary turns. The magnetic flux is

$$F_m = A. df \dots \dots \dots 2$$

where A = the area of the cross-section ($\frac{1}{2}$ square inch for $\frac{1}{2}$ KW, 1 square inch for 1 KW).

df = suitable flux density per square inch to be assumed as 60,000.

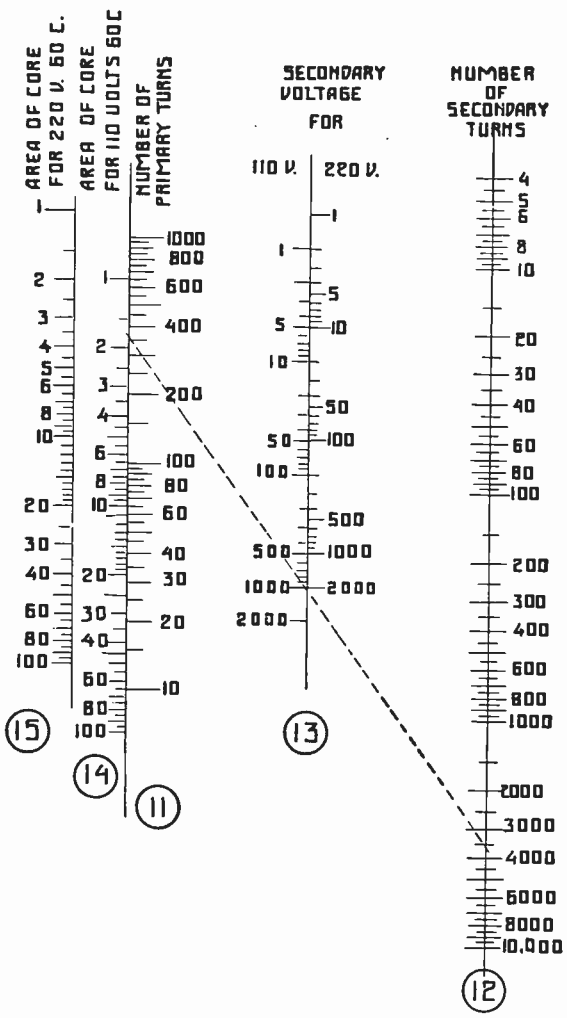

THE TRANSFORMER CHART

Figure NN: This mathematical chart enables you to calculate the proper design for your transformer for alternating current work. How to use the chart is fully described in the text.

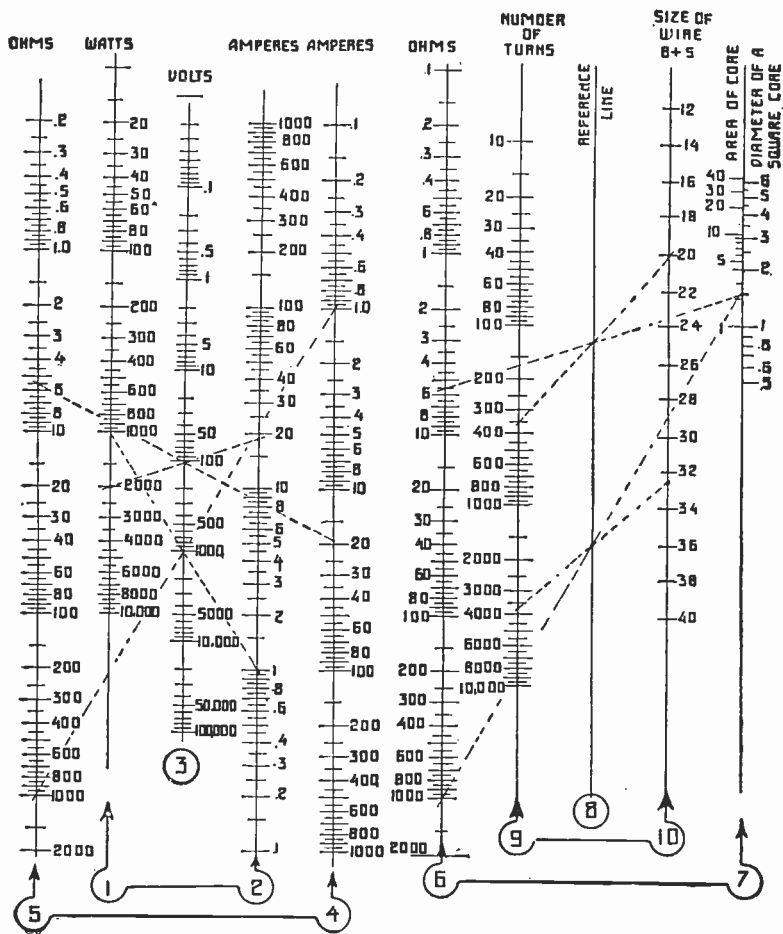

FIGURE 00

From equation (1) and (2) and assuming a frequency of 60, we will have the number of primary turns:

$$P_n = 6.3 \text{ Volts/Core Area} \dots\dots 3$$

The efficiency in a well-designed transformer is very high, but for simplicity we will assume a 50 percent efficiency, so that a rheostat can be connected in series with the primary.

The ratio of the secondary voltage and the primary voltage is equal to the ratio of the number of the secondary turns and the primary turns.

In order to simplify the above mathematical operations and the evaluations of the equations, a chart has been substituted and is here illustrated with the aid of an example:

The example is to design a transformer having a 1,000-watt input from a lighting current of 110 volts, 60 cycles, an output of 1,000 volts, at 50 percent efficiency. The area of the core is assumed to be 2 square inches. The current to be calculated for the primary will be then 2,000 watts.

Connect 2,000 on scale No. 1 (Fig. OO) with 110 on scale No. 3 and read at the intersection with scale No. 2 the resulting 18 amperes; then connect 18 on scale No. 4 with 110 on scale No. 3. You will find the line intersecting scale No. 5 at 5.5 ohms which will be the maximum resistance in the primary circuit.

Looking at scale No. 14 (Fig. NN), we find the cross-section of 2 square inches connected with 350 on scale 11, which is the number of the primary turns.

Connect 5.5 on scale No. 6 with 2 on scale No. 7, then connect the intersecting point on the reference line No. 8 with 350 on scale No. 9. We find the line intersecting scale No. 10 at 20 which is the minimum thickness of the wire in B & S gauge to prevent overheating. We can take No. 14 to 16 wire.

The secondary unit will give us 1,000 watts with a voltage of 1,000. Connect 350 on scale No. 14 with 1,000 on scale No. 13; the line will intersect the scale No. 12 at 3,700 which is the number of the secondary turns. Connect 1,000 on scale No. 1 with 1,000 on scale No. 3; (Fig. NN) the line will intersect scale No. 2 on 1; then connect 1 on scale No. 4 with 1,000 on scale No. 3. We find the line intersecting the scale No. 5 at 1,000 which is the resistance permissible in the secondary circuit.

Connecting 2 on scale No. 7 with 1,000 on scale No. 6, the line will intersect the reference line No. 8; this intersecting point connected with 3,700 on scale No. 9 gives us the required wire, No. 33 B & S gauge on scale No. 10. For efficiency a wire of No. 34 to 36 could safely be employed.

For 220 volts read values on scale No. 15, but take point of calculation across to scale No. 14.

Previously we have given the calculation of a fixed condenser which follows the equation:

$$C = .0000002248 A K/d$$

where C is the capacity in microfarads, A the area of the effective plates in square inches, D the distance between the plates and K the dielectric constant, which in our case—for air—will be 1.

The area of the plates will be very closely figured by taking the area of one rotor plate and multiplying by the number of the plates *less one*, as the capacity effect is accomplished *between* adjacent plates. From an economical standpoint mostly, an odd number of plates is used.

The thickness of the plates is measured with a sheet-metal gauge, the space between the plates may be measured by using various thicknesses of blank wire; the heaviest wire which could be placed

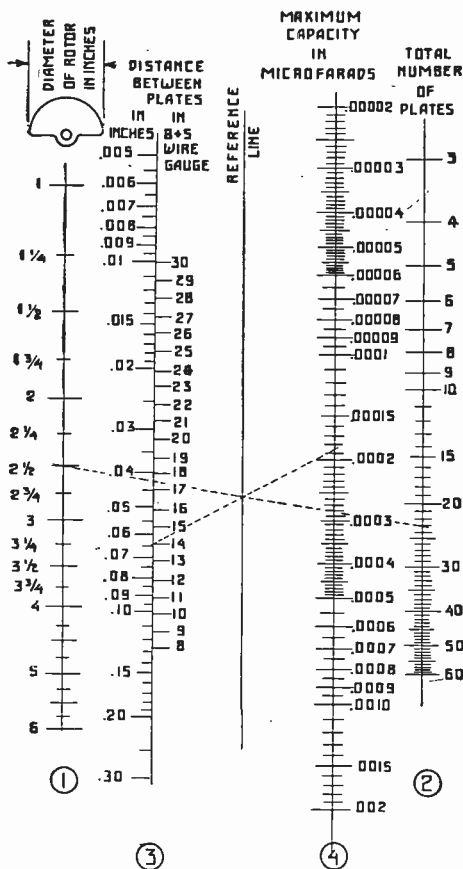

THIS CHART WILL HELP SOLVE YOUR CONDENSER PROBLEMS

Figure PP: This diagrammatic drawing will give you, at a moment's notice, the maximum capacity of any make of variable condenser, whether it contains 11, 17, 23, 26, or 43 plates. It does not matter whether the condenser has a spacing between plates of anywhere between .005 to .3 inch, the chart will tell you the capacity. This is important in buying a new condenser for a given circuit where a given capacity is necessary.

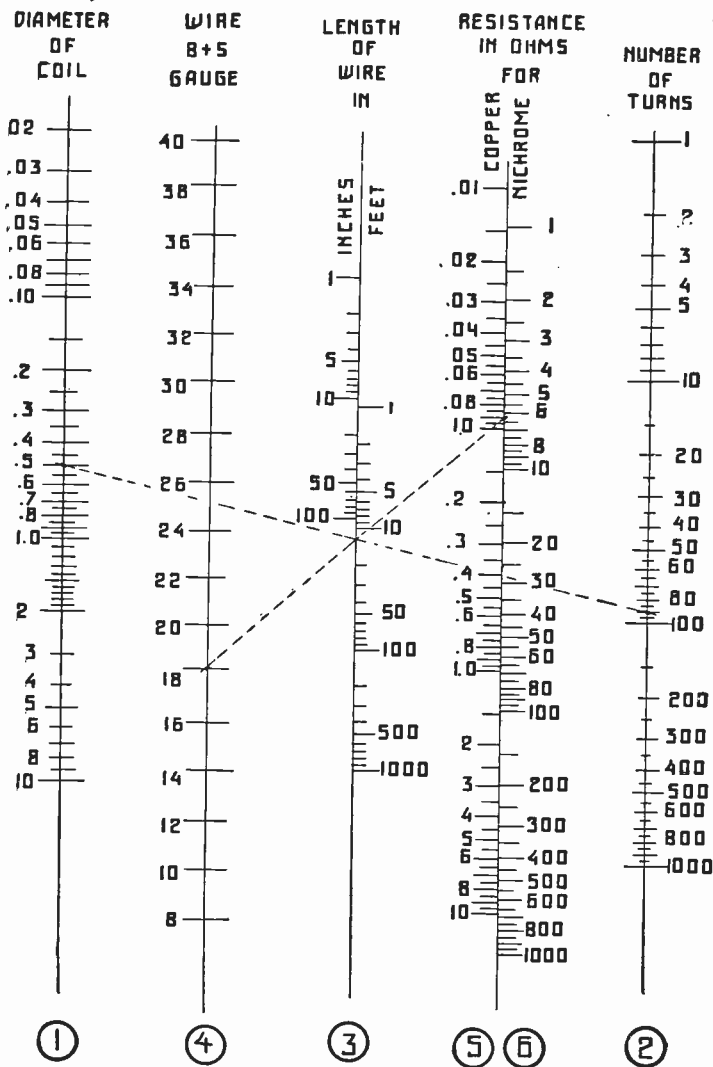

HOW THE RESISTANCE CHART IS USED

Figure QQ: You must first determine the diameter of the coil upon which you are to wind the resistance wire. Then you should decide what size of wire you want to use. The chart will give you the resistance of the wire and the number of turns you should wind on to get any specified resistance.

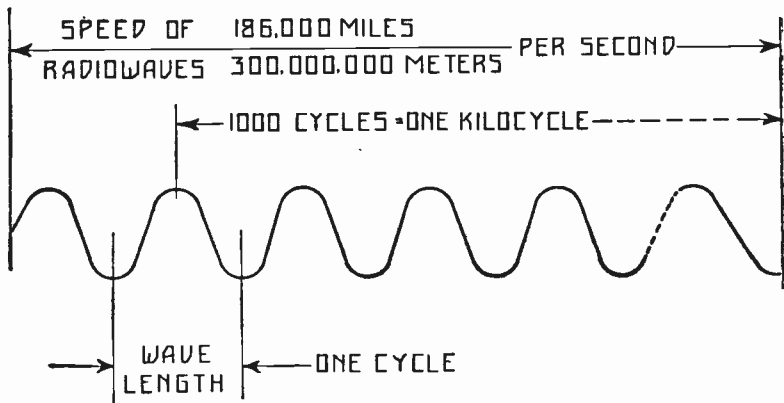

Figure RR: A simple chart that shows the relation between wavelength and frequency. The distance from crest to crest is the wavelength; this corresponds to one cycle, or a complete reversal of the alternating current that produces the wave.

between the plates will be taken as to be equal to the distance between the plates.

Another close method could be used with simplicity to measure the distance between plates by cutting small strips from the middle page of this course and placing them between the plates, multiplying the maximum number thus obtained by .003" (which is the thickness of the paper), resulting in the distance in inches.

Knowing the distance between the plates and the diameter of the rotor will be sufficient to calculate the maximum capacity of the condenser with the aid of the accompanying chart, Fig. PP.

For example: a condenser has a rotor diameter of $2\frac{1}{2}$ inches, 21 plates and a distance of No. 18 gauge wire between the plates. Connect $2\frac{1}{2}$ on scale No. 1 with 21 on scale No. 2, intersecting at the reference line; then connect the intersection with 14 on scale No. 3 and read the maximum capacity of .00017 microfarads on scale No. 4.

Materials used for transmission and distribution of electric energy are conductors which have a certain resistance. This resistance is measured in ohms.

The resistance of a wire is inversely proportional to the cross-section of the wire; that is, the thinner the wire, the higher is the resistance.

The standard thicknesses for wires, in electrical engineering, follows the B. & S. wire gauge and most handbooks have reference tables for the resistance of a standard length of wire.

Copper has almost the lowest resistance of any of the conductive materials. Assuming the resistance for copper as a unit, we can find the resistance for various materials by multiplying the resistance of copper by the following figures, if the same length and thickness is taken:

Silver.....	by	.94
Copper.....	"	1.00
Aluminum.....	"	1.7
German Silver.....	by about	20
Monel Metal.....	by	26
Mercury (quicksilver).....	"	53
Nichrome Alloy.....	"	68

A rheostat is a device for controlling the resistance of a circuit. The rheostat plays a large role in most electrical circuits; especially in radio work. For standard material German silver or

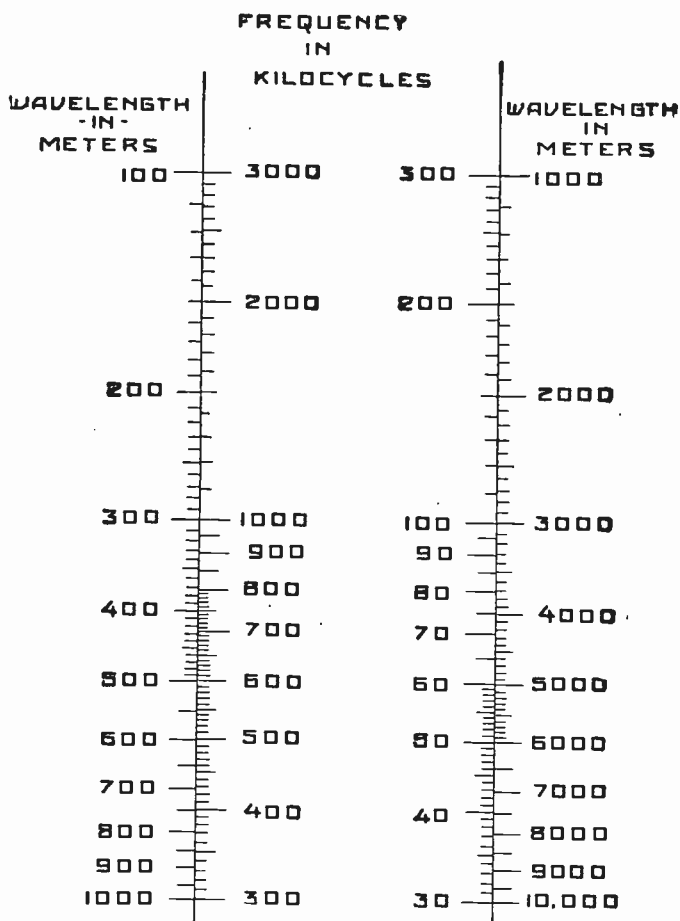

**NOTE: ONE KILOCYCLE EQUALS
ONE THOUSAND CYCLES**

HOW TO USE THE CHART

Figure 55: On the outer edges of the two upright lines are given the wavelengths in meters, with their corresponding frequencies denoted opposite them between the two sets of upright lines. Thus, for a wavelength of 300 meters, the corresponding frequency is 1,000 kilocycles a second, and for a wavelength of 3,000 meters, the corresponding frequency is 100 kilocycles a second.

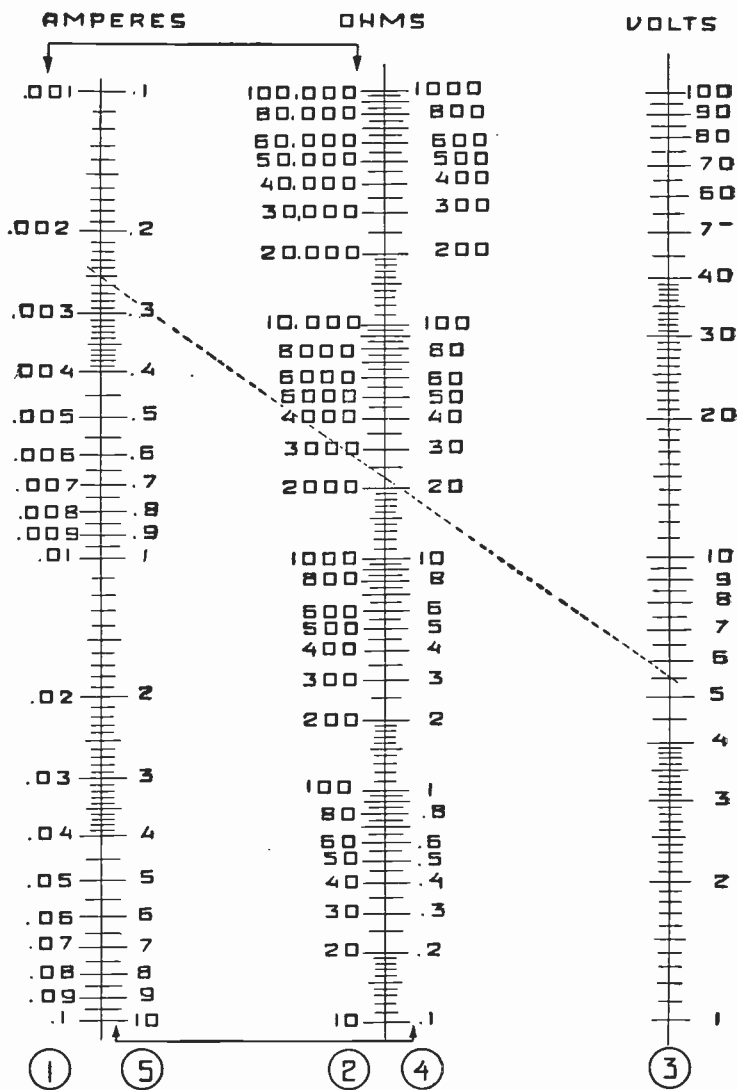

MAKE YOUR CALCULATIONS ON THIS TABLE

Figure 1T: The text tells you just how to determine the proper resistance to use with a certain type of vacuum tube and a certain voltage "A" battery. There are a great many other uses that you will find for this handy chart in connection with the calculation of Ohm's Law.

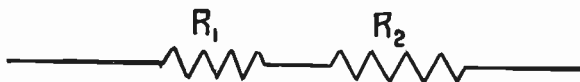
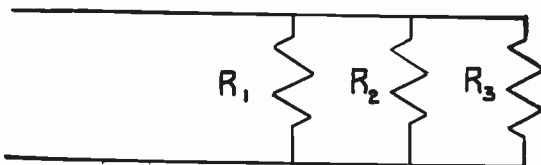

FIG. I. .



TWO WAYS OF CONNECTING UP RESISTANCES

Figure UU: The figure at the top shows resistance in series; the figure at the bottom shows them in parallel—which are often confused in calculating resistances.

nichrome wire is used and wound into the shape of a coil.

The method of calculating the resistance of a rheostat is simplified by the use of the chart illustrated on page 52.

To find the resistance of a No. 18 wire, 12 feet long, connect 18 on scale No. 4 with 12 on scale No. 3 and read, for copper, on scale No. 5. The result is .09 ohms. For nichrome, on scale No. 6 the result would be 6.2 ohms.

To calculate the resistance of a coil rheostat half an inch in diameter, having 90 turns, made of No. 18 B. & S. nichrome wire, connect .5 on scale No. 1 with 90 on scale No. 2 intersecting the reference line on scale No. 3, giving a total length of 12 feet.

Then connect the intersecting point on scale No. 3 with 18 on scale No. 4 and read the resulting resistance of 6.2 ohms on scale No. 6.

This table will help you greatly in the design of special rheostats of various resistances.

The speed of any ether waves is approximately 186,000 miles a second or 300,000,000 meters.

The length from the crest of one wave to the next one (see Fig. RR), completing one cycle, is called the *wavelength*.

The number of waves passing a fixed point in a second is the frequency of the electric oscillations.

If we take a wavelength of 600 meters, to find the frequency per second we divide 300,000,000 by the wavelength, which in this case is 600. This will give us 500,000 cycles. The amount runs into a high number and, therefore, we can substitute for 1,000 cycles, one kilocycle (as kilo means always thousand in the metric system), giving us 500 kilocycles.

It therefore follows that the multiplication of the wavelength and the number of kilocycles must give us the figure 300,000.

To facilitate the calculation of wavelength and frequency the accompanying chart (Fig. SS) has been prepared.

Simply read the wavelength and corresponding frequency from the same horizontal line crossing the two vertical lines at the desired frequency or wavelength you wish to convert.

The amount of current that flows

RESULTING RESISTANCE

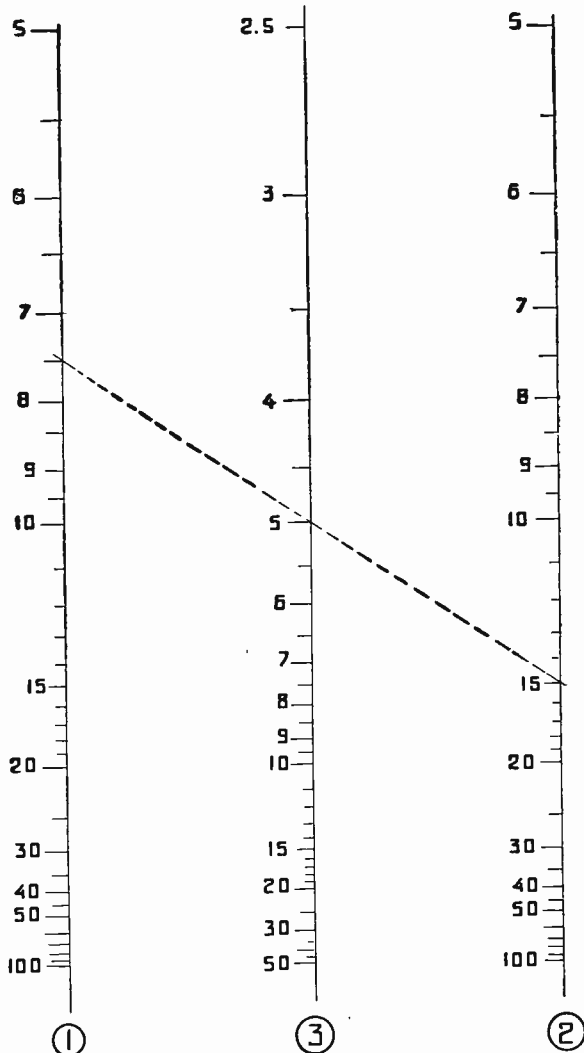

HOW TO USE THIS CHART FOR FIGURING YOUR RESISTANCES AT A GLANCE

Figure VV: Put your ruler on line 1 at the number of ohms of one rheostat connected in parallel and join it with the number of ohms of the other rheostat on line 2; then read the effective resistance on line 3. The dotted line shows how it is done.

in a circuit depends upon the voltage of the battery and upon the value of the resistance in the circuit. The equation—called Ohm's Law—applied to above conditions, states that the current is equal to the voltage divided by the resistance or

$$I = E/R$$

wherein I denotes the current measured in amperes, E is the electric pressure (voltage) measured in volts, and R is the resistance, measured in ohms.

Ohm's law is equally applicable to direct current (DC) and alternating current (AC) circuits, but in the latter case the above simple relations must (in general) be modified. Ohm's law is correct only for solid conductors at ordinary temperatures; in radio work it is used to calculate the resistance required, in a rheostat, for the proper operation of a filament for various tubes and the various voltages supplied.

For example:

Using a WD-12 tube, which requires a current of .25 amperes at a filament voltage of 1.1, we can find the necessary resistance by transposing the above formula, so that the resistance is equal to the voltage divided by the current. Substituting the above values, we have:

$$R = \frac{E}{I} = \frac{1.1}{.25} = 4.4 \text{ ohms}$$

which is the resistance of the filament.

Using a 6-volt storage battery (6.6) we will have an additional voltage of 5.5 volts, which should pass through a resistance current of .25 amperes.

We therefore divide 5.5 by .25 and find the necessary resistance to be 22.0 ohms, which is the additional resistance required for the circuit. Adding a certain amount of resistance, allowing for filament control, we find we will have to use a 30-ohm rheostat for this purpose.

For handy calculation, a chart is attached (Fig. TT) which can be used in the same manner as any one of the charts previously published.

For the above example, connect 5.5 on scale No. 3 with .25 on scale No. 5 and read (on scale No. 4) the resulting resistance of 22.0 ohms.

The amount of current which will flow in any given electrical circuit can be calculated by the use of Ohm's law, which has been dealt with previously. The equation for this law takes into consideration a single resistance or several resistances connected either in series or in parallel.

The combined resistance of a number of units which are connected in series as shown in Fig. UU, is the sum of the separate values according to the equation:

$$R = R_1 + R_2 +$$

The effective resistance of a number of units connected in parallel as shown at 1, can be calculated by the equation:

$$1/R = 1/R_1 + 1/R_2 + 1/R_3 +$$

If you use the accompanying chart (Fig. VV), the equation for resistances in parallel may be solved graphically. You need only to draw a straight line from one known resistance picked out on No. 1 scale to the value of the second resistance on No. 2 scale and the resulting resistance value can be read off at the point where the line you have drawn intersects scale No. 3.

For example: Assume that we have two rheostats connected in parallel and the individual resistances of the rheostats are $7\frac{1}{2}$ ohms and 15 ohms respectively. To find the effective resistance of the circuit we connect $7\frac{1}{2}$ on scale No. 1 with 15 on scale No. 2 and we find the effective resistance to be 5 ohms which is the point at which the

line will intersect scale No. 3. If these same two rheostats were connected in series the resulting resistance would be $22\frac{1}{2}$ ohms.

To obtain the resistance of a number of units some of which are connected in series and others in parallel in the same

circuit, the effective resistance of the parallel portions of the circuit are obtained separately by the use of the chart and then these figures are added directly to the values of the resistance units which are connected in the circuit in series.

END OF SECTION XII

SECTION XIII

Learning the Language of Dots and Dashes

THE student of radio code grows impatient with his perfectly good mind when he tells it again and again that "da de da da" is the letter "Y", and he wonders how any mind can be so stupid. He is too harsh with himself.

Even when the student has progressed more or less steadily, and when he is about fast enough to secure a first grade license, his mind often seems to make no progress for weeks and even months at a time. Some students quit in disgust at such a time, little knowing that success waits just around the corner and that their minds have been working faithfully all the while.

Success does not come by speeding up the progress of copying down the letters as they are sent, but rather by forming new habits of hearing entire words and even phrases without paying specific attention to the individual letters which form them.

The radio code is a foreign language. No one could speak a language fluently if he stopped to spell each word to himself, no matter how fast his mind might work. He must think in phrases which he has heard so often that his mind forms them almost automatically.

The operator who copies forty words a minute usually strains less than the beginner who copies ten. His mind does not work faster than the mind of the beginner; it merely works with fewer acts.

As the experienced operator sits at his typewriter and copies an important message coming, perhaps, from a statesman or a king, he changes the paper in his machine. He even tells a joke to another operator beside him, and maintains his normal rate of speed although he may have been working eight hours. He is at ease, and has none of the worry of the beginner who strains to catch every letter separately as it comes to him.

But he was once a beginner himself, and he strained his mind before he learned a better way. He first learned the dots and dashes which go to make up letters, and he learned them slowly, thinking them over as he went to sleep perhaps, and wondering when he would ever distinguish between Q and Y.

Some schools prefer that the students learn the letters by sound only and ask them never to look at charts which show the dots and dashes used for each letter. They may be in the right, for the sense of hearing is the one which is most concerned, and the sense which must be developed.

Not all minds are alike, however, in their processes of learning. The mind with the strongest visual memory no doubt makes better progress at the start by looking at a chart; such a mind must listen to the buzzer for the auditory sensation of the letter, and then refer to its visual memory to identify the letter by

its arrangement of dots and dashes.

The visual process is a roundabout way, of course, and must soon be discarded for the simpler system of auditory memory. The auditory system of teaching, without the chart, is quite likely the best, although there is no way to prove it.

The beginner with a keen visual memory may often startle his friends with his rapid start, but learning the code is a true art which has no short cut, and sooner or later he slackens his pace, and his friends overtake him.

An ordinary mind can remember six figures when they are spoken, and can usually repeat them, both forward and backward. Some minds, of the keen visual type, can retain as many as ten or more figures "in the mind's eye," and repeat them at leisure. If such a mind exists in a class, and the instructor sends ten letters at a time, the student with the unusual mind can retain the letters and set them down at leisure usually to the astonishment of his classmates, most of whom have been unable to receive more than two or three of the letters.

Such a student will stand well in his class always, but if he is to become a fast operator, he must discard the visual processes and learn to write letters, words, and then phrases as he hears them.

Learning the code is much like solving a puzzle. Little Willie in the fourth grade humiliates his venerable old grandfather by learning the trick of it before grandfather, with all his great store of knowledge, has obtained a good start in finding the solution.

The code, in its democratic way, offers the same lengthy task to the old as well as the young and to the quick as well as the slow.

As the long and short buzzes come to

the ear in a complex maze, the mind at first strains and can make nothing out of the confusion. It sounds like "oodle oodle de oodle" to the novice. The student in the classroom is almost as much at sea, even though the signals are much slower.

He is unable to distinguish between the letters at all until suddenly some feature catches his ear and helps to fix the signal in his mind. The single dash for T and the single dot for E are distinguished first as a rule, and other letters fix themselves in the mind much more slowly.

Perhaps the beginner discovers that the signal for Q is like the warning whistle of a train as it approaches a crossing; two long notes, a short one and then another long one. Thus, the similarity helps him to recognize Q when it comes to him slowly, but he must forget the similarity later if he is to become a fast operator. He will not have time to think "train whistle" before his pencil writes Q. He must make his actions more simple and automatically write Q just as a German says "rot" or a Frenchman says "rouge" or a Spaniard says "roto" when he speaks of the color red.

He must not be discouraged if his pencil stands still when the buzzes of the letter Q come to him, even though he knows perfectly well, a second later, that the letter was Q. A mother must point many times to a hat or coat and say "red" before her baby finally understands, and the college instructor finds the same difficulty in teaching a foreign language.

If the mind is kept continually open and sensitive to the signals it will after a time eliminate errors and discover short cuts. The beginner who is discouraged needs only to recall his efforts in first learning to put on his collar and tie his necktie. His fingers were slow,

and he invented many ways of pushing collar buttons through button holes until he found himself one day doing the trick seemingly without thinking anything about it.

During the process of learning the code, there are dull days, weeks and

even months, during which periods the student seems to make no progress at all. Such apparently inactive periods may be caused by discouragement or inattention; perhaps the copying of messages seems too easy. At any rate, there is at least one period in the code student's

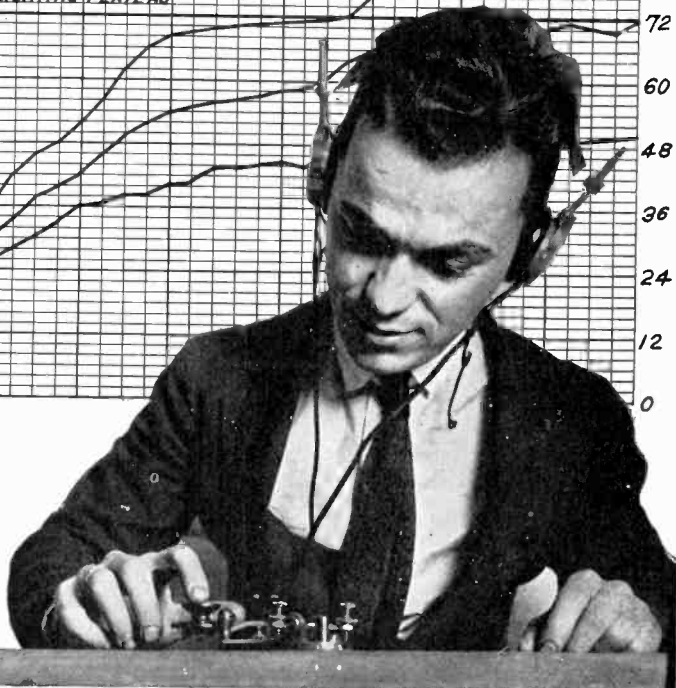

HOW THE STUDENT PROGRESSES

The speed of the beginner in learning the code is indicated in this graph. The lower line shows his development in learning it letter by letter, the middle line, word by word, and the top line, phrase by phrase.

progress as shown in the accompanying chart, when his mind seems to be at a standstill.

The curves shown on the chart represent the progress of a group of students who were learning telegraphy. The curves show in a general way how a student can expect his mind to act. In the curve marked "receiving" an inactive period or "mental plateau" is shown to occur during the fourth and fifth months of the student's efforts.

The accepted explanation of the plateau is thus set forth by Prof. R. S. Woodworth, of the Department of Psychology at Columbia University:

"The plateau is the figurative indication of a natural slowing down in the progress of the student during a period of study, and is followed ordinarily by signs of renewed impetus caused by the adoption of improved methods."

To progress from the plateau stage it is necessary not to increase the speed of the acts which the mind has already learned to perform, but to learn new habits of hearing words and even phrases in their entirety. Such new habits can come only from continued practice; while the mind seems to have gone stale, it is really getting a fresh start in a new direction as is shown decidedly by the abrupt upward trend of the curve after five or six months.

The plateau may come at the end of three, four or five months, and it may last much longer than a month or two depending upon the individual's alertness. It is a bugbear to the student who does not understand it, but he should not be discouraged, for it comes to all beginners, regardless of their ability.

The beginner should learn, by all means, to "copy behind," that is, to write down the words several seconds after they are sent. This is the only safe

method, for if he tries to keep up with the ticks he is apt to anticipate them and, hearing the first half of a familiar word, write the whole word and thus make mistakes.

Experts can copy from six to ten and even twelve words behind, depending upon their power to remember the words. They find it good practice to keep behind, for the meaning of the sentence may help them to make out a word of which they were not quite certain.

To shift from copying letters to copying words often stumps the student. At first he is sure to miss many of the words and his copy is hopelessly incomplete. He thinks it is better to copy letters, leaving out uncertain ones and trusting that he will catch enough letters to make out most of the words. He hates to miss an entire word. It seems stupid to him.

He should realize that he is starting all over again, in a sense, and that he is learning *words* and *phrases* instead of *letters*. He must think of letters only when they come to him detached or in coded messages. He will find that such "mixed" messages will be easy enough; he will copy the words readily and will have plenty of time to think of the detached letters and figures.

The word-habit will cause many mistakes at first, but after a time it will not only be simpler but superior in accuracy.

Copying with a typewriter is much faster than with a pencil after the operator has learned the keys. A single movement in pressing a typewriter key takes the place of a series of movements in making a letter with a pencil.

To send with a telegraphy key is much easier than to receive at first; that is because the fingers always know just what to do. As the chart indicates, a speed of some twenty words a minute is attained with almost steady progress.

INTERNATIONAL MORSE CODE AND CONVENTIONAL SIGNALS

TO BE USED FOR ALL GENERAL PUBLIC SERVICE RADIO COMMUNICATION

1. A dash is equal to three dots.
2. The space between parts of the same letter is equal to one dot.
3. The space between two letters is equal to three dots.
4. The space between two words is equal to five dots.

A	Period
B	Semicolon
C	Comma
D	Colon
E	Interrogation
F	Exclamation point
G	Apostrophe
H	Hyphen
I	Bar indicating fraction
J	Parenthesis
K	Inverted commas
L	Underline
M	Double dash
N	Distress Call
O	Attention call to precede every trans-
P	mission
Q	General inquiry call
R	From (de)
S	Invitation to transmit (go ahead)
T	Warning—high power
U	Question (please repeat after)—
V	interrupting long messages
W	Wait
X	Break (Bk.) (double dash)
Y	Understand
Z	Error
Å (German)	Received (O. K.)
Ä or Å (Spanish-Scandinavian)	Position report (to precede all position
Ç (German-Spanish)	messages)
É (French)	End of each message (cross)
Ñ (Spanish)	Transmission finished (end of work)
Ö (German)	(conclusion of correspondence)
Ü (German)	
1	
2	
3	
4	
5	
6	
7	
8	
9	
0	

11-6860

THE KEY TO THE INNER CIRCLE OF THE ETHER

Fifteen minutes of study a day for a period of a month will give the average man (or woman) sufficient knowledge of the code to enable him to read most of the amateur signals. A buzzer practice set may be obtained for about two dollars.

The plateau in learning to send is not marked, although the hand can actually be made to think in words instead of letters and can acquire trains of action. A slight plateau is shown in the curve after about two months of practice. It is at this time that the hand is learning to send words instead of letters, and is busy learning the trains of action which form common words.

Perhaps the most obvious train of action in every day life is demonstrated unconsciously when we dress and undress. Almost everyone at some time has started to take off his shoes only and has suddenly awakened from his absent-mindedness to find that he has removed his hose and perhaps other garments as well.

The victim of such absent-mindedness has formed a train of action in undressing. He has followed this train in the same way for years, and when he once starts his mind on the train by removing his shoes, he continues without conscious effort.

In the same way the muscles of the hand learn to send common words in code. The operator has only to think the word; he does not think the letters. And his hand ticks it out. Common words such as "the," "and," "but," and "in" are learned almost at the outset. Endings of words such as "ing" and "ion" become automatic; after long training the hand acquires an extensive vocabulary of words which it sends in trains.

After three or four months the hand has approximately reached its muscular limit in the speed of sending letters and its progress from that time on comes in sending word trains which are not slowed down by the brain that thinks of each letter.

After a certain point in training is reached, sending is learned much more

slowly than receiving because the mind can be trained to work much faster than the fingers; if a typewriter is used the operator can receive much faster than he can send. He can eventually find time to correct the sender's mistakes as he writes the message down.

Most beginners have heard of the "glass arm," but most of them do not take proper care to prevent it.

If the key is operated with the fingers or with the muscles of the hand, the continual strain will sooner or later cause temporary paralysis when the operator attempts to send with a key; this condition is known in the trade as the "glass arm." The operator may be able to write and use his hand in any other way, but when he attempts to send a message with a key, his hand and arm become rigid and will not obey him.

Almost any good operator can show the beginner how to place his fingers lightly on the key and make the movements with his wrist in the proper manner.

Progress at first will be much slower than would be the case if the student used his fingers to form the dots and dashes, but in the end the wrist movement is much the speedier. A tired hand or wrist is a danger signal and shows that the method of sending is wrong. A perfect wrist movement will enable an operator to send for hours, causing him little more fatigue than would come from writing a letter or other mild exercise of the hand and forearm.

CODE LEARNING DONT'S

1. DO not let your thoughts divert to other things. Form the habit of concentrating. It is the basis of all success in learning the code.
2. WHEN you memorize the code,

INTERNATIONAL RADIOTELEGRAPHIC CONVENTION

LIST OF ABBREVIATIONS TO BE USED IN RADIO COMMUNICATION

ABBREVIATION	QUESTION	ANSWER OR NOTICE
PRB	Do you wish to communicate by means of the International Signal Code?	I wish to communicate by means of the International Signal Code.
QRA	What ship or coast station is that?	This is
QRB	What is your distance?	My distance is
QRC	What is your true bearing?	My true bearing is degrees.
QRD	Where are you bound for?	I am bound for
QRF	Where are you bound from?	I am bound from
QRG	What line do you belong to?	I belong to the Line.
QRH	What is your wave length in meters?	My wave length is meters.
QRJ	How many words have you to send?	I have words to send.
QRK	How do you receive me?	I am receiving well.
QRL	Are you receiving badly? Shall I send 20?	I am receiving badly. Please send 20.
	for adjustment!	for adjustment.
QRM	Are you being interfered with?	I am being interfered with.
QRN	Are the atmospherics strong?	Atmospherics are very strong.
QRO	Shall I increase power?	Increase power.
QRP	Shall I decrease power?	Decrease power.
QRQ	Shall I send faster?	Send faster.
QRS	Shall I send slower?	Send slower.
QRT	Shall I stop sending?	Stop sending.
QRU	Have you anything for me?	I have nothing for you.
QRV	Are you ready?	I am ready. All right now.
QRW	Are you busy?	I am busy (or: I am busy with). Please do not interfere.
QRX	Shall I stand by?	Stand by. I will call you when required.
QRY	When will be my turn?	Your turn will be No.
QRZ	Are my signals weak?	Your signals are weak.
QSA	Are my signals strong?	Your signals are strong.
QSB	Is my tone bad?	The tone is bad.
QSC	Is my spark bad?	The spark is bad.
QSD	Is my spacing bad?	Your spacing is bad.
QSF	Is transmission to be in alternate order or in series?	My time is
QSG	Transmission will be in alternate order.
QSH	Transmission will be in series of 5 messages.
QSI	Transmission will be in series of 10 messages.
QSN	What rate shall I collect for?	Collect
QSK	Is the last radiogram canceled?	The last radiogram is canceled.
QSL	Did you get my receipt?	Please acknowledge.
QSM	What is your true course?	My true course is degrees.
QSN	Are you in communication with land?	I am not in communication with land.
QSO	Are you in communication with any ship or station (or: with)?	I am in communication with (through).
QSP	Shall I inform that you are calling him?	Inform that I am calling him.
QSQ	Is calling me?	You are being called by
QSR	Will you forward the radiogram?	I will forward the radiogram.
QST	Have you received the general call?	General call to all stations.
QSU	Please call me when you have finished (or: at o'clock)?	Will call when I have finished.
*QSV	Is public correspondence being handled?	Public correspondence is being handled. Please do not interfere.
QSW	Shall I increase my spark frequency?	Increase your spark frequency.
QSX	Shall I decrease my spark frequency?	Decrease your spark frequency.
QSY	Shall I send on a wave length of meters?	Let us change to the wave length of meters.
QSZ	Send each word twice. I have difficulty in receiving you.
QTA	Repeat the last radiogram.
QTE	What is my true bearing?	Your true bearing is degrees from
QTF	What is my position?	Your position is latitude longitude.

* Public correspondence is any radio work, official or private, handled on commercial wave lengths.

When an abbreviation is followed by a mark of interrogation, it refers to the question indicated for that abbreviation. 11-6860

THE NUCLEUS OF A UNIVERSAL LANGUAGE

These abbreviations are observed internationally; they constitute what is, in effect, the beginning of a world tongue. Every amateur who applies for a license to transmit must pass an examination on this list.

make it an "intelligence test" by mastering it in a given length of time.

3. **ONCE** you have learned the code and you "miss" a character, do not stop and try to think of it. It will come to you the next time. If the group is a word, the character can be filled in; otherwise you have lost the entire group. The habit of holding on to characters, temporarily forgotten, retards the progress in speed.

4. **THE** beginner who insists on counting the dots and dashes invariably confuses one character with another, particularly when trying to copy speed.

5. Go over the characters in your mind in between times; not by so many dots and dashes but by the sound. For instance **Y** is—dah-dit-dah-dah.

6. **EACH** code character is a musical sound. Memorize it in that way. If you must begin by counting the dots and dashes, do so. But save time and acquire speed by reverting to the sound method as soon as possible.

7. Do not attempt to put a character down before it has been completed. Read ahead and write at least one or two characters behind the key.

8. **IN** copying well behind the key there is ample time to determine doubtful characters before you come to them, to space the groups or words properly and to make a neat copy.

9. **THE** habit of writing two or more characters behind the sender comes from retaining groups or words in the mind; that is, by having someone send press, word at a time, which must not be written down but connected in the mind and called off as completed. Begin with short words, sent slowly, and increase in length and gradually in speed.

10. **THE** habit of trying to guess the words and attempting to write them down before they have been completed

is a bad one. In many instances the word turns out to be other than that expected and the result is that you become disconcerted and lose the rest of the message.

11. **MAKE** the characters legible. I's and E's, T's and L's and K's and H's, for instance should not resemble each other. Dot the I's and J's, cross the T's and distinguish M's, N's and U's from each other.

12. **WHEN** you send, round out the characters properly. Make the dashes of equal length the dots in proportion, and evenly and equally spaced.

13. **DON'T** try to send fast at first. Learn to form the characters correctly; then send slowly and work up in speed as you grow in proficiency.

14. **AVOID** jerky sending. This is generally the result of holding the muscles stiff. Let the forearm rest on the table; let the muscles relax and put the movement in the wrist. This rests the arm and makes it easier to form the characters correctly.

15. To send fast is one thing; to send fast correctly is another. Become known for having a good "fist" by first practicing slowly and carefully.

16. **THE** habit of letting the fingers come in contact with the metal of the key while sending is a bad one. It will eventually result in a shock.

17. **WHEN** you make an error in transmission make two interrogation marks, instead of series of dots, and then begin the word anew.

18. **SEPARATE** the heading of the message from its body by a break or double dash; likewise the body and signature.

Every "ham" in the United States is welcome to know how the Signal Corps directs an entire battle by radio with less than a score of characters wrong in the messages exchanged. This

is the attitude of Lieutenant Colonel J. E. Hemphill, head of the Signal School at Camp Alfred Vail, New Jersey, where the latest and best methods of instruction are employed.

They know what is the matter with the "fist" of every beginner at the key at the Signal School, and they know just how to go about teaching him to copy at a lively clip and to become practically letter perfect.

The camp literally bristles with antennas, and when there is a sham battle in progress the woods about the camp are alive with messages which are sent with precision and copied in a style which is a distinctive feature of the school's training. Messages are not written, but actually printed by the operator.

To one who is used to copying messages in the usual "long hand," as he would write a letter, any system of printing seems impossible. He realizes how fast he must write to copy at a good speed, and how slow he must go if he prints. He does not take into consideration how many unnecessary movements he makes when writing and

how many of these he can eliminate by correct printing.

The Signal School has developed a unique system of printing which is an outstanding monument of efficiency both in saving time and insuring accuracy. The accompanying chart on page 78 shows how few actual strokes need be made in forming the letters of the alphabet and the numerals.

The first letter on the chart is a decided shock to any operator who has been making the letter "u" in the usual way. It requires only one stroke, whereas in ordinary script it would require two or three similar movements, depending upon the position of the operator's pencil at the beginning. The round dot shows the beginning of each stroke, and the arrow shows the direction.

There is no letter on the chart which requires more movement of the fingers in printing than in writing. In actual practice the system is found to be nearly as fast as any method of writing and by far more accurate and legible.

Perhaps the chief advantage of printing lies in the fact that when one char-

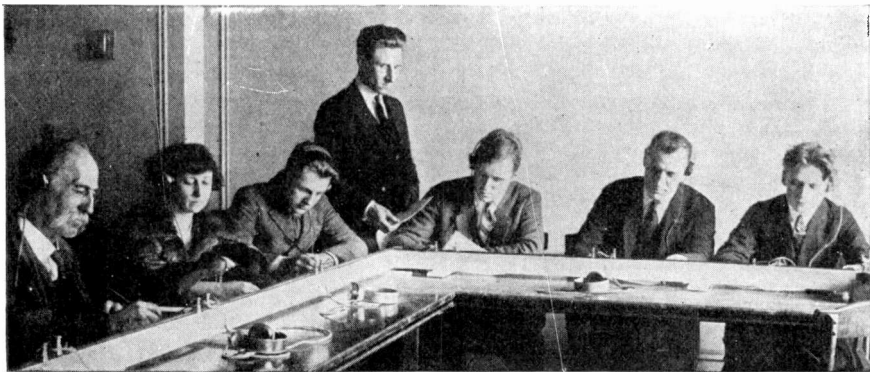

LEARNING WITH EXPERT INSTRUCTION

Code learning is largely a matter of becoming familiar with certain combinations of sounds and the student is not always in need of expert instruction.



A GRAPHIC RECORD OF A POOR "FIST"

This record of a student's message is made on an undulator—an apparatus that consists of a paper tape moving at a uniform rate under a pen which is fed with ink by a syphon action. The pen moves back and forth across the tape in perfect time with the student's manipulation of the key and is, therefore, a picture of his message as he sends it.

acter in a word is missed, the remaining characters are formed perfectly enough so that the word can be made out. Although the army is anxious to have all letters perfect because most messages are sent in cipher, tests prove that its method of printing is practical for all purposes.

Just as all soldiers take the same length of step after they have been in service for a while, all army operators have the same handwriting when it comes to copying messages. Any officer can read the penciled message of any private, no matter how fast it has been copied.

There are many operators outside the army, especially the "speed merchants," who can not read their own hasty writing after it "gets cold."

This never happens at the Signal School, because all messages look alike, the old, the new, the hot and the cold. Last year's log is as readable today as ever.

There are a number of script characters which are easily confused, such as "m," "n" and "i" when they are written together hastily, whereas the same letters written the army way are easily told apart. The letter "n" is printed with one stroke running in three directions only. When the letter is made in this manner it saves the time required to make the final downward movement of the script letter and when it is finished it is easily distinguishable from any other character.

The letter "y" has an unusual form which is the result of long experiments

and genuine inventive ability. The first stroke is like the letter "v" and the second completes the character in a way which distinguishes it positively, even though the operator may be somewhat careless in forming it.

An extra stroke is added to the figures 1 and 0, so as to distinguish them from the letters I and O. The 1 is underlined and the 0 has a line drawn through it. The extra strokes do not delay the operator, however, because the code gives him the time of five dashes for the 0 and four dashes and a dot for the 1.

One of the chief arguments for adopting the printing system is that no operator can avoid copying abbreviations and unusual words and combinations of letters which are strange to him and which he must write plainly if he is to make a perfect record.

Europe is now so close to America, from a radio point of view, that almost any American amateur is apt to hear a foreign station sending in a foreign language. When such a thrill comes he is glad to know all the tricks of his trade and to fill his log with the prize. The commercial operator also knows the value of accuracy in messages of importance.

The "fist" of the army operator also receives much consideration at Camp Vail, for there is usually a point in the training of an operator where his ability to receive increases faster than his ability to transmit.

When the operator is struggling to copy ten or fifteen words a minute, he sometimes develops a wrist movement

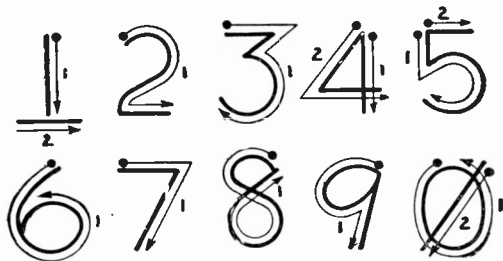
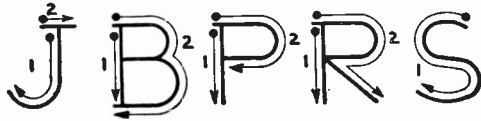
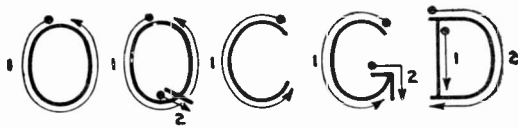
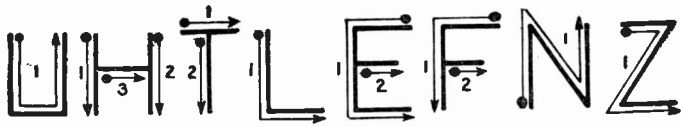

THE APPROVED METHOD OF WRITING CAPITALS. TRY IT YOURSELF!

Students at Camp Vail are taught to move the pen or pencil in the direction of the arrows shown on each letter. This method of transcribing messages received by radio eliminates mistakes, and it may be faster than ordinary writing.

which enables him to send twenty or twenty-five words a minute, but as he progresses his hand lags. He may, after some months, be able to copy at the rate of thirty or thirty-five words a minute, but there are few operators who can send well at that rate.

The man in an army class has an advantage over a man who struggles alone at home with PX and with other "hams" who are as slow as he, but the army has rules which will help any beginner, and many who are advanced, if they have the courage to follow them.

It is usually difficult for a man to forsake his speed of nine words a minute because he has a wrong wrist movement and start over again at the rate of three or four, but if he is going to be successful he must treat his arm right. His fingers, which have been trained for many other delicate tasks, perhaps, are little good to him in working a key, and this is the hardest blow to the beginner.

He can seize a key tightly with his fingers and play a lively tune on it after a few days if he is a good mechanic or an artist in any other line where manual skill is required. His wrist movement is too awkward at first to be of any value to him, but if he is to gain any great amount of proficiency, he must forget the nimbleness of his fingers and use them merely as loose and clumsy flappers to rest almost carelessly on his key.

The chief value of his thumb and finger lies in keeping his hand from sliding off the key. The real work, the snappy dots and dashes with which he will soon punctuate the ether are made by his wrist, moved largely by his forearm.

As the radio code is received by way of the ears, it is obvious that the proper way to learn it is by *sound* and not by *sight*.

The best method of learning the code

is to have an expert send each letter over and over again until the beginner knows that letter by sound without stopping to think that it is made up of just so many dots and dashes.

Most radio fans are not so fortunate as to have an expert operator at their command to teach them the code.

Here is a novel way to learn the code that will give the proper swing to the letters. By this method you can practice when you are walking to the office or on the stroll after lunch. If you recite a code letter according to this system for every step you take on even one long afternoon walk, you will get a good working knowledge of the code.

To begin with, the number and relation of the dots and dashes that make up each letter of the code alphabet should be memorized until you can give the code equivalent of any letter without looking at the paper. Be sure to consider the dots and dashes as combinations of the words "dit" and "dah" rather than as so many periods and dashes.

In general, consider one step equal to a dash, three dots or a space.





Thus, letter B would be *dah-dit-dit-dit* with the *dah* long enough to last for one step and the three *dits* following evenly during the next step.

There are exceptions, of course, but the chart shows how to time the dots and dashes with your steps.

Remember always to leave a space one step long between letters. And when you get to the point where you are making words and sentences, leave a two-step space between words.

Try it!

Dots are made by raising the wrist with a slight quiver. A series of dots is made by only one upward movement of the wrist, and such movement should require no strain upon any of the

LETTER					
A	$\overline{\text{DIT-DAH}}$				
B	$\overline{\text{DAH-}}$	$\overline{\text{DIT-DIT-DIT}}$			
C	$\overline{\text{DAH-DIT-}}$	$\overline{\text{DAH-DIT}}$			
D	$\overline{\text{DAH-}}$	$\overline{\text{DIT-DIT}}$			
E	$\overline{\text{DIT}}$				
F	$\overline{\text{DIT-DIT-}}$	$\overline{\text{DAH-DIT}}$			
G	$\overline{\text{DAH-}}$	$\overline{\text{DAH-DIT}}$			
H	$\overline{\text{DIT-DIT-DIT-DIT}}$				
I	$\overline{\text{DIT-DIT}}$				
J	$\overline{\text{DIT-DAH-}}$	$\overline{\text{DAH-}}$	$\overline{\text{DAH}}$		
K	$\overline{\text{DAH-DIT-}}$	$\overline{\text{DAH}}$			
L	$\overline{\text{DIT-DAH-}}$	$\overline{\text{DIT-DIT}}$			
M	$\overline{\text{DAH-}}$	$\overline{\text{DAH}}$			
N	$\overline{\text{DAH-DIT}}$				
O	$\overline{\text{DAH-}}$	$\overline{\text{DAH-}}$	$\overline{\text{DAH}}$		
P	$\overline{\text{DIT-DAH-}}$	$\overline{\text{DAH-DIT}}$			
Q	$\overline{\text{DAH-}}$	$\overline{\text{DAH-}}$	$\overline{\text{DIT-DAH}}$		
R	$\overline{\text{DIT-DAH-}}$	$\overline{\text{DIT}}$			
S	$\overline{\text{DIT-DIT-DIT}}$				
T	$\overline{\text{DAH}}$				
U	$\overline{\text{DIT-DIT-}}$	$\overline{\text{DAH}}$			
V	$\overline{\text{DIT-DIT-DIT-}}$	$\overline{\text{DAH}}$			
W	$\overline{\text{DIT-DAH-}}$	$\overline{\text{DAH}}$			
X	$\overline{\text{DAH-}}$	$\overline{\text{DIT-DIT-}}$	$\overline{\text{DAH}}$		
Y	$\overline{\text{DAH-}}$	$\overline{\text{DIT-DAH-}}$	$\overline{\text{DAH}}$		
Z	$\overline{\text{DAH-}}$	$\overline{\text{DAH-}}$	$\overline{\text{DIT-DIT}}$		

LEARNING THE CODE WHILE WALKING

The even swing of march time forces you to recite the code letters properly. The faithful use of this system will help to speed up the recognition of code characters when they are received.

muscles of the arm, the wrist or the fingers. When the proper quiver of the wrist is mastered, five dots can be made with the single upward movement as easily as one.

The dash is made with the downward movement of the wrist. As the dash is longer than the dot, it gives the wrist plenty of time to move downward.

At Camp Vail an undulator can be switched to the key of any pupil whose sending is ragged, and he can see upon a tape just what mistakes he is making. Such a visual record is nothing short of a revelation to many operators, because few can hear themselves as others hear them.

The novice is invariably astounded when he first learns that one operator can know another by his sending just as he would know a voice over the telephone. When he gets farther into the subject of dots and dashes, however, he finds that there are few "fists" which have no foreign accent.

The undulator reveals such a brogue or stuttering on the part of an operator's hand by means of an ink line on a paper tape. The undulator used at Camp Vail feeds ink with a syphon action through a hollow point which is vibrated back and forth across the paper tape as the operator taps the key. As its response is instantaneous, the student's defects are revealed at once when his record is compared with a perfect model.

It has been found that practice with some kind of coded message is more beneficial than with messages which can be understood by the man who copies them. A few press messages are sent occasionally to enliven the lesson.

The amateur who practices with his neighbor often finds it unhandy to plan new code messages constantly, and so he resorts to sending the news of the day

from a daily paper. To make a code message out of a newspaper story, however, it is only necessary to send the story backwards. Starting at the end of the story, the operator can send five letters at a time, just as they come, with a pause in between each group of five letters. When he has finished, he can readily check the message by reading it backward.

There are two reasons why men at Camp Vail take pride in being real amateurs. The first is that they cannot tell when an amateur is going to contribute to radio science in a way which will be a valuable aid to his government, and the second is that they are interested in developing amateurs and helping them. The response of "hams" during the war has earned for them a definite place in the activities of the Signal Corps.

The set used for local work at the camp is perhaps more representative of the American "ham" station than any other. It consists of four five-watt tubes, and it is worked with the army call letters, BS6. This little set so far has reached out some 300 miles with only 1.5 amperes in the antenna.

Experiments are constantly made with this little outfit to help the amateur.

Officers in charge of this development work are among the best technical radio men of the country and they are genuinely interested in amateur radio.

Because of the difficulty of mastering this code language and the necessity of keeping the ether free of inexperienced novices, a license is required before one is permitted to operate a transmitting apparatus. As thousands of radio fans have learned in the last few months, no license of any sort is required by the government for a receiving set in the United States.

Just as the immigrant who comes to this country reads the preamble to the Constitution to prove that he can command the English language sufficiently to make his way about, so there is a minimum speed requirement in the use of the Continental Morse code for passing the amateur's test. The operator must be able to send and receive ten words a minute, and has to understand the international abbreviations, two of which are "SOS," the signal of "distress" and "QRM" meaning "Interference."

But why is a license necessary for

operating a radio telephone transmitter? The reason is sufficient.

Sending stations are apt to interfere with one another. The number of wavelength bands is so relatively small for the great amount of traffic that is already being sent over them—that considerable regulation is necessary in order to give an equal chance to all. Of course the control must be centralized in one place, or disputes would arise which would end in the hopeless deadlock of two small boys, one saying, "My mother says I can play in your yard," and the other, "My mother says you can't." In

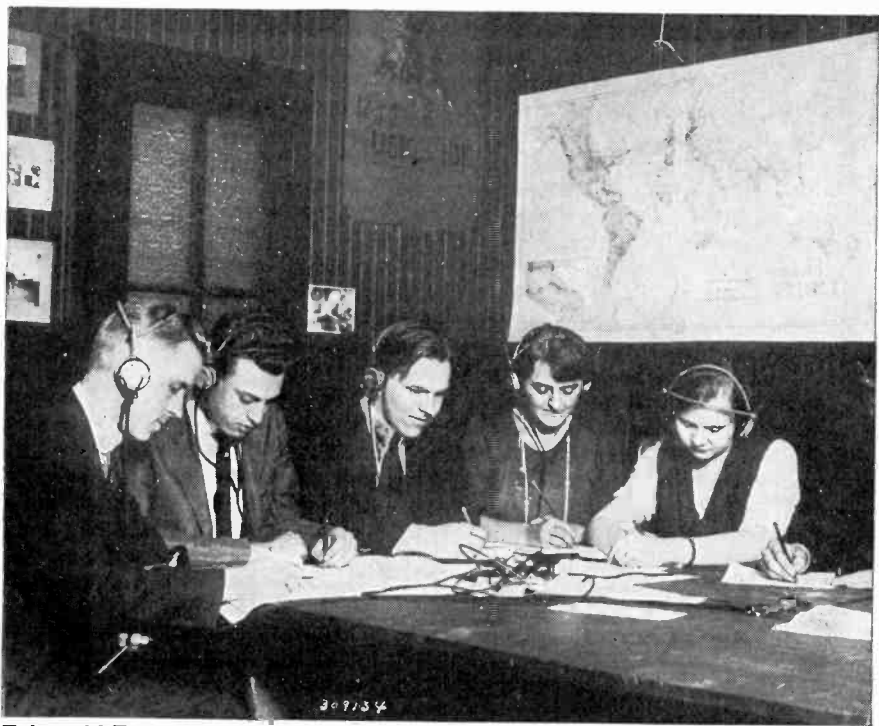

Underwood & Underwood

A CLASS OF APPLICANTS STUDYING THE CODE

You must be able to receive ten words a minute in order to qualify for the amateur first-grade license. This requirement is not difficult to obtain.

fact, it would be worse, for there would be no strong right arm to settle the matter. So Congress has provided the arm to start with, and power to regulate radio communication has been vested in the Secretary of Commerce, who administers it through the Commissioner of Navigation. The present law makes no difference between radio telegraph and radio telephone.

If you are an American citizen, it is not difficult to get a sending operator's license, provided, of course, that you know the Continental Morse code. The first step is to find out who the district Radio Inspector is and get in touch with him.

The United States is divided into nine radio districts; the area of each is based upon its population and need for radio supervision.

The First District comprises the New England States, and its Inspector is at the Customs House at Boston. The Second District has its headquarters at the Customs House at New York City and takes in the counties of New York State along the Hudson River, Long Island, and the northern part of New Jersey. The rest of New Jersey, southeastern Pennsylvania, Delaware, Maryland, the District of Columbia, and Virginia are included in the Third District. This Inspector's office is at the Customs House at Baltimore, and he has jurisdiction also, at present, over the Fourth District, which is composed of the southern Atlantic Coast States: North and South Carolina, Georgia and Florida; and the island of Porto Rico. In the near future, the Fourth District will have its own inspector, with headquarters at the Customs House at Savannah.

District Number Five takes in the southern states west of District Four, and extends as far north as the northern

boundaries of Tennessee, Arkansas, Oklahoma, and New Mexico. Its Inspector is at the Customs House at New Orleans. The Sixth District takes in the southwestern corner of the United States: Utah, Arizona, Nevada, and California, and also extends itself to take in Hawaii. Its headquarters is at the Customs House at San Francisco. Seattle, Washington, is headquarters for the Seventh District, and its Inspector is to be addressed at 2301 L. C. Smith Building. This district comprises Wyoming, Montana, Idaho, Oregon, Washington, and Alaska. The Eighth District takes in the rest of New York not included in District Two, the rest of Pennsylvania not included in District Three, West Virginia, Ohio, and the lower peninsula of Michigan; its Inspector is at the Federal Building in Detroit. The Ninth District takes in all that is left; its northern boundary follows the Canadian border east from North Dakota through the middle of Lake Superior, then curls down through Lake Michigan to the northern boundary of Illinois. Its Inspector has his headquarters at the Federal Building in Chicago.

Having written to the Radio Inspector of the proper district, the prospective operator receives application blanks for his examination. Examinations are usually held at the offices of the district Radio Inspectors, but Inspectors may arrange examinations at other places in their districts when they deem it necessary.

The examination consists of two parts: A practical test on sending and receiving in the Morse Continental code, at which a speed of ten words a minute must be attained; and a written examination on the adjustment and operation of the prospective operator's apparatus and the regulations of the International Conven-

Official call, 2 2 A

Number 873

LICENSE FOR (General) AMATEUR RADIO STATIONDEPARTMENT OF COMMERCE
BUREAU OF NAVIGATION
RADIO SERVICE

Pursuant to the act to regulate radio communication, approved August 13, 1912,

Done at New York, NY, on the 28 day of December, 1922, a citizen of the State of New York, county of New York, city or town New York, street East 175th Street, No. 154

having applied therefor, is hereby granted by the Secretary of Commerce, for a period of two year, on and subject to the restrictions and conditions hereinafter stated and revocable for cause by him, this License to use or operate the apparatus for radio communication (identified in the Schedule hereinafter) for the purpose of transmitting private radiograms or signals, notwithstanding the effect thereof outside beyond the jurisdiction of the State or Territory in which the said station is located. *Provided*, That no interference other than may result, under the restrictions contained in this License shall be caused with the radio communication of stations of the Government of the United States or licensed stations.

1. The use or operation of apparatus for radio communication pursuant to this License shall be subject also to the articles and regulations established by the International Radiotelegraphic Convention, ratified by the Senate of the United States and caused to be made public by the President, and shall be subject also to such regulations as may be established from time to time by authority of subsequent acts and treaties of the United States.

2. The apparatus shall at all times while in use and operation be in charge of a person or persons licensed for that purpose by the Secretary of Commerce, and the operator of the apparatus shall not willfully or maliciously interfere with any other radio communication.

3. The station shall give absolute priority to signals or radiograms relating to ships in distress; shall cease all sending on hearing a distress signal; and shall refrain from sending until all the signals and radiograms relating thereto are completed.

4. The station shall use the minimum amount of energy necessary to carry out any communication desired, and the transformer input shall not exceed one kilowatt.

5. The station shall not use a transmitting wave length exceeding 200 meters.

6. The station shall not use a transmitter during the first 15 minutes of each hour, local standard time, whenever the Secretary of Commerce by notice in writing shall require it to observe a division of the time, pursuant to the Twelfth Regulation of the act of August 13, 1912.

7. The President of the United States in time of war or public peril or disaster is authorized by law to cease the station and cause the removal therefrom of all radio apparatus, or may authorize the use or control of the station or apparatus by any department of the Government upon just compensation to the owner.

8. The Secretary of Commerce and Collector of Customs or other officers of the Government authorized by law may at all reasonable times enter upon the station for the purpose of inspecting and may inspect any apparatus for radio communication of such station and the operation and operators of such apparatus.

9. The apparatus shall not be altered or modified in respect of any of the particulars mentioned in the following Schedule except with the approval of a radio inspector, or other duly authorized officer of the Government.

Name of naval or military station, if within 3 nautical miles, None

Power: Plate Transformer input, 80 W.; Antenna: Type (T, J, etc.) Inverted L

Height, 60 (in feet); Horizontal length, 80

Wires: Number in vertical part, 1; in horizontal part, 1

The normal sending and receiving wave length shall be 200 meters and the station is authorized to use the following additional wave lengths, not exceeding 200 meters: 200, 250, 300, 350, 400, 450, 500, 550, 600, 650, 700, 750, 800, 850, 900, 950, 1000, 1050, 1100, 1150, 1200, 1250, 1300, 1350, 1400, 1450, 1500, 1550, 1600, 1650, 1700, 1750, 1800, 1850, 1900, 1950, 2000

This License expires on December 28th 1924

Witness my hand and seal
Assistant Secretary of Commerce.

Received at New York,
Department of Navigation.

Delivered by Henry K. Berglund
Place New York, N. Y. Date December 26th 1922

*Strike out "one" if the station be within 3 nautical miles of a naval or military station, where no strike out "one" shall be in effect 1,200, or if the station be within 3 nautical miles of a naval or military station, not to exceed 1,200.

THE STATION LICENSE

This is the document that permits you to use your amateur transmitting station. It is issued to any American amateur who has already installed his transmitting antenna and planned his set and who can pass the tests that qualify him for the operator's license. This license is good for two years—providing you conform to the rules.

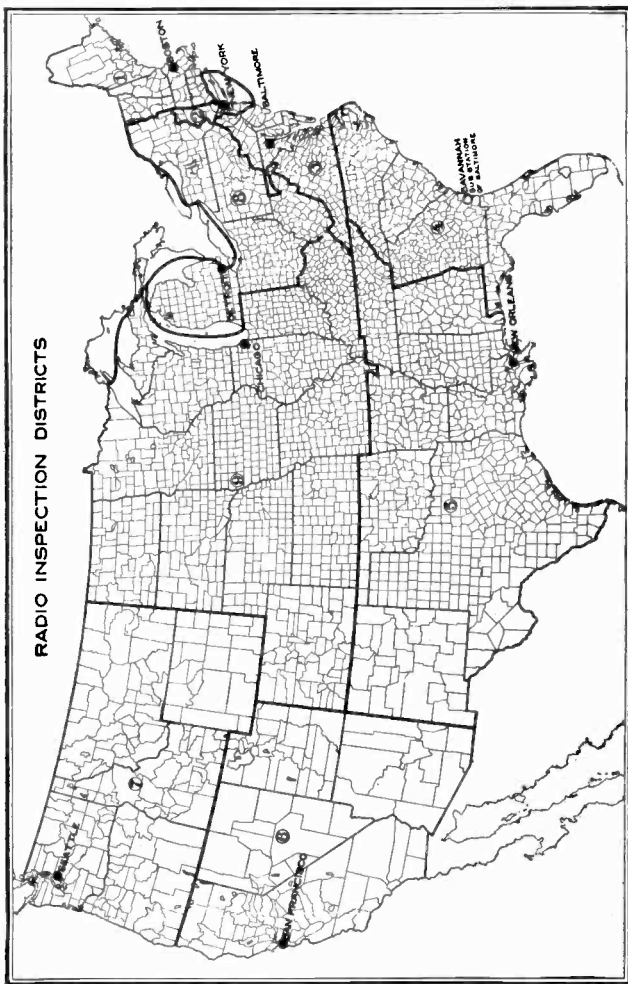

THE NINE "RADIO DISTRICTS" OF THIS COUNTRY

Each district has a Radio Inspector who is in charge of the radio experts who control the operation of all stations, issue licenses to operators and stations and who check up the wavelength of all transmitting stations within their districts.

tion and Acts of Congress "in so far as they relate to interference with other radio communication and impose certain duties on all grades of operators."

The Radio Laws and Regulations of the United States, Part II, Section 121, states:

"Amateurs, before applying for their operators' licenses, should read and understand the essential parts of the International Radiotelegraphic Convention in force and sections 3, 4, 5, and 7, of the Act of August 13, 1912. The Department recognizes that radio communication offers a wholesome form of instructive recreation for amateurs. At the time its use for this purpose must observe strictly the rights of others to the uninterrupted use of apparatus for important public and commercial purposes. The Department will not knowingly issue a license to an amateur who does not recognize and will not obey this principle. To this end the intelligent reading of the International Convention and the Act of Congress is prescribed as the first step to be taken by amateurs. A copy of the radio laws and regulations may be procured for this purpose from the radio inspector or from the Commissioner of Navigation, Department of Commerce, Washington, D. C., but they are not for public distribution. Additional copies may be purchased from the Superintendent of Public Documents, Government Printing Office, Washington, D. C., at a nominal price."

If the applicant is so far away from the district headquarters that the expense of going there for examination would be too great, he may obtain a second-grade amateur operator's license without examination upon submitting evidence that he is qualified to hold a license. To do this, he gets an operator who holds a license to examine him on sending and receiving in code and upon

the other requirements, or he may go before a local radio club for such an examination. He sends in the statements of those who have examined him, and, if these are satisfactory, a second-grade license is granted him, subject to later inspection and examination by the Radio Inspector of his district. An amateur second-grade operator's license is usually granted for eight months. It may be revoked if the holder refuses to offer himself for examination when given opportunity to do so.

After receiving his operator's license, the applicant's sending apparatus is inspected and tested, and he is assigned his call and wavelengths. The call consists of a number followed by two, or more, letters. If the Inspector cannot go over his set at once, the amateur receives a temporary station license for use until his apparatus can be inspected.

Most amateur sending stations are classed as "general amateur stations," and their transformer input of power is 1 kilowatt or less. There are, however, "restricted amateur stations" whose input must not exceed one-half kilowatt. This restriction is placed upon stations located within five nautical miles of a naval or military station.

It is interesting to note that in all laws relating to radio supervision, distance is measured in nautical miles. The nautical mile is 6076.1 feet, or about $1\frac{1}{8}$ land miles.

Each operator must have two licenses, the operator's license and the station license. These licenses are renewable at their time of expiration. Radio Laws and Regulations, Part III, Section 153 (b) says:

"Operators holding licenses for grades other than commercial, who submit satisfactory evidence to the examining officer showing actual operation of radio apparatus for three months during the

last six months of the license term, may be issued new licenses without examination. Otherwise, applicants for renewals will be examined in the usual manner."

No charge is made for any license or examination.

Having received his licenses, it is incumbent upon the operator to keep the rules and regulations which apply to his section of the ether. The first of these, which in these days of broadcasting seems a little bizarre, is secrecy. This is required, in fact, even of those who only listen.

"No person or persons engaged in or having knowledge of the operation of any station or stations shall divulge or publish the contents of any messages transmitted or received by such station, except to the person or persons to whom the same may be directed, or their authorized agent, or to another station employed to forward such message to its destination, unless legally required to do so by the court of competent jurisdiction or other competent authority. Any person guilty of divulging or publishing any message, except as herein provided, shall, on conviction thereof, be punished by a fine of not more than two hundred and fifty dollars or imprisonment for a period of not exceeding three months, or both fine and imprisonment, in the discretion of the court."

But, of course, the rules and regulations were made originally for commercial operators.

Another rule strictly prohibits ship or coast stations from sending unnecessary signals. This applies to amateur as well as commercial operators. Trials and practice are allowed only at times and under conditions that make interference with other stations negligible, and even then the experimenters are cautioned to listen in frequently for distress signals, which have right of way over every-

thing else. Commercial operators not infrequently have their licenses withdrawn for sending unnecessary signals.

Transmission of profane language is forbidden by another rule.

Every licensed operator is assigned a wavelength upon which he must send, and he must be careful not to overstep his limits and interfere with other communication. Willful or malicious interference constitutes a misdemeanor under the law, and is punishable by a fine of not to exceed five hundred dollars or imprisonment not to exceed one year, or both. It is often difficult for amateur operators to be sure that they are sending within their proper wavelengths, and the Bureau of Navigation has recently issued the following warning to them: "The Bureau has received a number of complaints recently of amateur stations using wavelengths in excess of those authorized in their licenses, which has resulted in much unnecessary interference. Amateurs should, if possible, have their wavelengths measured (*with a wavemeter*) to avoid violating the law."

In sending messages, the operator must give his call letter. This gives other operators a chance to take it up with him if his messages are interfering with those of other operators. Little trouble is experienced with operators sending without a license. There is a strong sentiment against such a practice among licensed amateur operators, who are very proud of their licenses, and they are quick to object when messages are sent out under irregular call letters. If such a rebuke does not silence the unofficial sender, and he becomes a pest, complaint may be made to the Radio Inspector of the district. If a reprimand from the district Inspector is not sufficient, the might of the law may be invoked against him, and the case turned over to the District Attorney. But

trouble of this kind is rare. The American boy is a law-abiding citizen.

The inspecting force of the Bureau of Navigation for regulation of amateur operators is fast becoming inadequate. The district inspectors' offices being at the seaboard leaves the great interior of the country almost without supervision. The work of inspecting outgoing vessels to see that their radio outfits are in perfect working order is by far the most important duty of the Bureau of Navigation. Vessels upon the high seas are dependent upon their radio sets for all their communication with the rest of the world, and in time of danger it is vital that radio messages can be sent. It is for this reason that inspectors' head-

quarters must be at the principal harbors of this country.

But since July 1, 1922, when a slightly larger appropriation was made available to the Bureau of Navigation for radio inspection, extension of the service of the district radio inspectors has been increased, and provision has been made to cover fully every large city in the United States. It is, of course, impossible for the Government to place inspectors in every state and every town at the present time.

Eight grades of licenses are issued by the Bureau of Navigation: (1) Commercial extra first grade; (2) commercial first grade; (3) commercial second grade; (4) commercial cargo grade; (5) com-

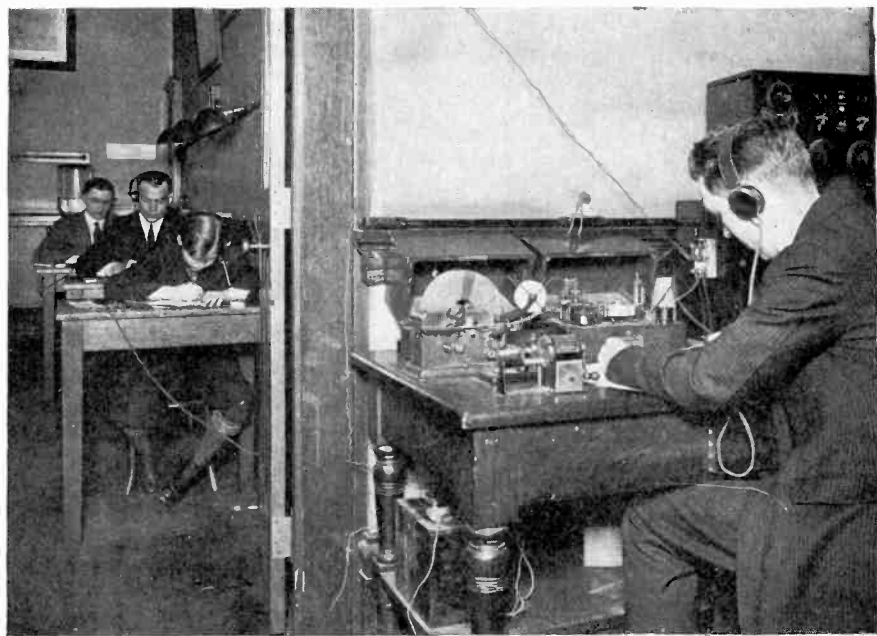

HOW APPLICANTS FOR A TRANSMITTING LICENSE ARE EXAMINED BY THE RADIO INSPECTOR

A typical scene in the inspector's office. In this case the assistant radio inspector is sending "code" to applicants who are located in the next room with phones on their heads, copying down as much of the test messages as they can. The test papers are then corrected by the inspector and rated for speed in reception.

NUMBER
21538

The United States of America

DEPARTMENT OF COMMERCE
BUREAU OF NAVIGATION

LICENSE

RADIO OPERATOR, AMATEUR FIRST GRADE

This is to certify that Levie Johnson
 has been examined and shown to have a knowledge of the adjustment and operation
 of apparatus and of the regulations of the Radio Telegraph Convention and the Act of
 Congress insofar as they relate thereto, and to have a practical knowledge of radio communication and to have a certain
 status on all grades of operators sufficient to entitle him to a license, and he is hereby
 licensed as required by law. Radio Operator, Amateur, First Grade for two years.

The candidate was examined and shown to have knowledge (excellent or good)
 in the following additional subjects:

- (a) general adjustment, operation and care of apparatus. Good
- (b) transmitting and sound reading fundamentals. Good
- (c) general knowledge of international regulations and Acts of Congress to regulate radio communication. Good

Richard B. Beaman Secretary of Commerce
Ad. J. G. Spector Inspector
 New York, N.Y. November 11, 1924
 Made at New York, N.Y. on November 11, 1924
 1. Examinations required 2. Examinations required

THE AMATEUR OPERATOR'S LICENSE

This is the coveted document that is issued to you after you have passed the required examination. It is good for two years and is issued without fee other than the trifling cost of the notary's seal.

mercial temporary permit; (6) experiment and instruction grade; (7) amateur first grade; (8) amateur second grade.

The commercial extra first grade is the highest license granted radio operators by the Government. It is issued to operators whose trustworthiness and efficient service entitle them to extra confidence and recognition. It may be earned by commercial first-grade operators who have put in eighteen months satisfactory service on sea or land during the two preceding years and have not been penalized for violation of the radio laws and regulations, upon passing a special examination. In the examination a speed of at least 30 words a minute, Continental Morse, and 25 words a minute, American Morse, must be attained. The technical questions and the questions on the radio laws and regulations will be considerably wider in scope than those for commercial first grade, and a higher percentage is required, 80 or better on a score of 100.

The commercial first-grade applicant must know how to adjust, operate and care for his apparatus, correct its faults and change from one wavelength to another. He is required to transmit and receive by car at a speed of not less than 20 words a minute in Continental Morse. For these tests a word is agreed to consist of five letters. He must also know how to care for a storage battery and other auxiliary power apparatus, and he will be examined upon his knowledge of international regulations of radio communication and the requirements of the Acts of Congress to regulate radio communication. An operator who holds

a commercial first-grade license or a commercial extra first-grade license is qualified for employment at any ship or land station.

The commercial second-grade examination covers the subjects given for the first grade, but the questions asked are not as comprehensive in character. To operate in this class, a speed of only twelve words per minute is required.

All American steamers carrying radio outfits must keep a continuous watch for distress signals. On cargo vessels, one first or second-grade operator is required, but the man to relieve him may be any member of the crew or other person qualified to recognize the distress signal when it is included with other words and to recognize the call signal of his own ship. He must also be able to test the apparatus with a buzzer to determine whether it is properly adjusted to receive signals.

All the foregoing are licenses granted to commercial radio operators. There is another license which, while classed as a "commercial grade," may be issued to amateurs. It is known as the Experiment and Instruction grade. It has, however, no reference to the instruction of radio operators as such, but is required by those who operate stations carrying on scientific experiments but are unable to obtain commercial operators' licenses. To obtain this license the operator need know only the essential parts of the radio laws and regulations and be able to recognize distress and "keep out" signals, but he has to satisfy the Radio Inspector that his scientific attainments warrant his receiving a license of this class.

END OF SECTION XIII

SECTION XIV

Batteries, Battery Eliminators and Chargers

A STORAGE battery is really not a battery but a container for electric current—a sort of electrical receptacle which will hold and deliver a definite quantity of electric current. It differs from the ordinary chemical battery or cell (a battery is a group of cells) in that no destructive chemical action takes place between its elements. Take the ordinary dry cell as an example for illustration. The dry cell is not rechargeable and its metallic element (zinc) is consumed in the generation of current. The generation of current not only gradually exhausts the zinc but the active chemical agent (sal ammoniac) as well.

In a storage battery or cell nothing is consumed but certain chemical changes take place every time a battery is charged and discharged. When a cell is charged, electric energy is stored as chemical energy and when the cell is discharged this chemical energy is converted back into electric current and is available as such at the terminals of the device.

In radio reception, storage batteries are used both to light the filaments of the vacuum tubes and to place the proper electrical charge upon the plates. When used to light the filaments, the storage battery is referred to as an "A" battery and when used to place the correct charge upon the plates of vacuum tubes, it is called the "B" battery. In the former case the terminal voltage of the

battery is six and in the latter it may run anywhere from $2\frac{1}{2}$ to 100 or even 150 volts.

The six volt storage battery is always made up of three cells connected in series so that their voltages will be added. When fully charged, a single cell will deliver current at a voltage of 2.2. Thus a $2\frac{1}{2}$ battery would have about 11 cells.

The lead-plate storage battery, is made up of electrodes that contain active elements of lead peroxide and sponge lead as the positive and negative materials respectively, immersed in a dilute solution of sulphuric acid.

When fully charged and in good condition, the positive plates have a dark reddish-brown or chocolate color, while the negative plates are gray or slate colored. The plates may be readily distinguished by their color and also by the character of the active material on them. The lead peroxide is hard, like soapstone, while the negative material is soft and can be readily cut into with the finger-nail. The negative material is pure lead which has been reduced to a sponge-like form.

On discharge, the electrolyte (the solution) combines with the active materials of the electrodes and, on charge, the active materials are reduced to their original condition. The chemicals extracted from the electrolyte are released and returned to the electrolyte. It follows then, that the density of the

electrolyte is greater at the end of charge than at the end of discharge, and also that the active material on the plates expands as discharge proceeds.

The unit of capacity of any storage battery is the *ampere-hour*. This is generally based on an eight-hour rate of discharge.

Thus a 100 ampere-hour battery will give a continuous discharge of $12\frac{1}{2}$ amperes for eight hours. Theoretically it should give a discharge of 25 amperes continuously for four hours, or 50

amperes for two hours. As a matter of fact, however, the ampere-hour capacity *decreases* with an *increase* of discharge rate.

The capacity of a cell is proportional to the exposed area of the plates to which the electrolyte has access, and depends on the quantity of active material on these plates.

The capacity of batteries depends, therefore, on the size and number of plates in parallel, their character, the rate of discharge and also the tempera-

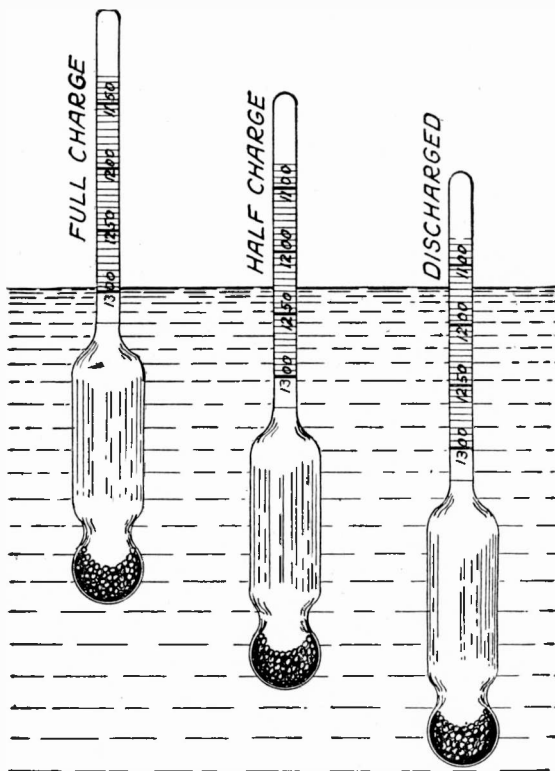

WHAT THE HYDROMETER READINGS MEAN

Figure A: When the hydrometer sinks down so that the level of the top of the solution is near 1,100, as shown at the right, the battery is practically discharged and should be recharged at once until the hydrometer floats up to nearly 1,300 as shown at the left

ture. Taking the eight-hour rate of discharge and temperature of 60 degrees F. as standard, the capacities which obtain in American practice are from 40 to 60 ampere-hours a square foot of positive plate surface (equals number of positive plates in parallel multiplied by the length by the breadth and by 2). If the capacity under the above conditions is taken at the eight-hour rate as normal, the table below shows the decrease in capacity with increase in discharge rate for average

plates of American manufacturers:

	<i>8-hour rate</i>
8-hour.....	100 percent
6-hour.....	96 “
4-hour.....	88 “
2-hour.....	70 “
1-hour.....	48 “

The voltage of any storage cell depends only on the character of the electrodes, the electrolyte density, and the condition of the cell, and is *independent* of the size of the cell. The voltage of the lead sulphuric-acid cell, while on

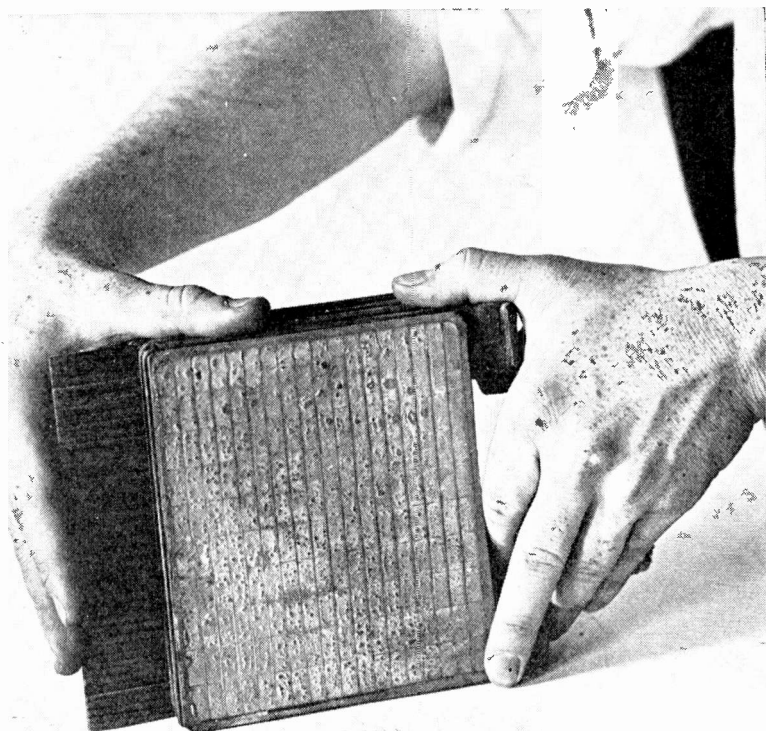

INSERTING THE SEPARATORS BETWEEN THE PLATES

Figure B: A thin sheet of wood or perforated rubber is used as insulation between each positive and negative plate to prevent them from making contact with each other and thus cause an internal short-circuit.

charge is from 2 to 2.5 volts, while on discharge it varies from 2.0 down to 1.7 volts.

The density of the electrolyte is measured with an instrument called a hydrometer (Fig. A and J), which is immersed in the liquid and floats with a greater or less amount projecting above the surface of the liquid according to the density or dilution of the liquid. It has a scale on the upwardly projecting portion, on which the degree of density may be read. Where cells are so small that

the hydrometer cannot be immersed in the electrolyte, it is customary to use a combination syringe and hydrometer which draws up into itself some of the liquid from the cell.

In addition to an effect on the voltage and electrolyte density, the temperature also influences the capacity and efficiency. The capacity of a cell, at discharge rates of eight hours or less, increases with the temperature. If the capacity at 60 degrees F. is taken as normal, the increase of capacity will be

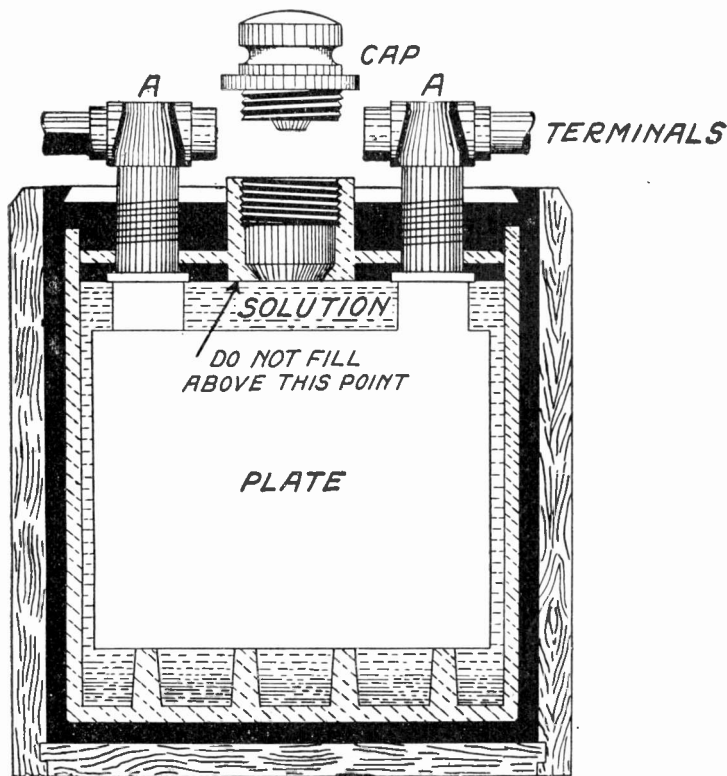

HOW THE STORAGE BATTERY IS PUT TOGETHER

Figure C: Inside the outer wooden case is the rubber jar that contains the plates and solution. The black area is the pitch composition that is run in between the case and the jars. Note the ridges in the bottom of the jar that support the plates and provide room below them for the sediment to collect without causing a short-circuit.

about one percent for discharges at four-hour rate, and at the two-hour rate the increase is about two percent, for each degree increase in temperature.

The electrolytic action seldom penetrates to a depth greater than 1/16 of an inch at ordinary discharge rates, so that where the thickness of the active material, measured from the surface of the electrolyte to the conducting plate, exceeds this amount, the portion in excess of this thickness is practically useless.

In order to obtain any desired capacity, the proper number of plates are assembled in a cell, all the plates in one cell being necessarily in parallel, the positives being joined together in one group and the negatives in another group, interleaved with the positives. Customarily, the number of negative plates exceeds the number of positive plates in each cell by one, so that the extreme end plates of each cell are negative plates. The plates of similar character in a cell are joined together by so-called burning the plate terminals to a common bus-bar, which is also lead. The burning is in reality a lead-welding process, in which the heat of an oxy-hydrogen blow-pipe is used to melt the parts together. This is the universal method of joining up the lead work in battery installations.

The plates are assembled in containing cells usually made of hard rubber. The cells are, in most cases, provided with upwardly projecting ribs and on these ribs the plates are supported. As the alternate electrodes are at opposite potentials they must not come in contact with each other, otherwise an internal short-circuit will result which will discharge the cell and injure the plates. In order to prevent this, some spacing arrangement or method of separation is necessary. The separators are made of

specially treated pieces of wood or rubber. The illustration in Fig. B shows one of these spacers as well as the method of inserting it between the plates.

The troubles to which batteries are most commonly subject are:

- First*; loss of capacity;
- Second*; loss of voltage;
- Third*; corrosion of electrodes;
- Fourth*; distortion and fracture;
- Fifth*; shedding of acting material.

Nearly all these except the third are directly traceable to over-discharge, although overcharge and impurities in the electrolyte are important factors.

It has been shown on discharge, that a portion of the active material which enters into the chemical combination with the electrolyte is reduced to lead sulphate. Since this sulphate is mixed with the uncombined active material, the whole mass retains its conductivity to a large extent and does not expand to a harmful degree if provision is made for a reasonable amount of expansion in the plate. If discharge be prolonged, however, beyond the proper point, it produces an over sulphation which manifests itself in a variety of ways. The lead sulphate deposits in white crystals on the surface of the plates. Its excessive increase in volume closes up the pores in the plates, thus reducing the true active surface. The expansion either causes the active material to loosen and fall from the supporting grid, or with certain types of plates, it will distort the electrode, and in some cases fracture it. The distortion usually takes the form of a warped surface and is known as "buckling."

Over-discharge may be caused by the prolonging of the current from the battery on discharge; by internal discharge, produced by impurities in the electrolyte, and by accidental short-circuiting

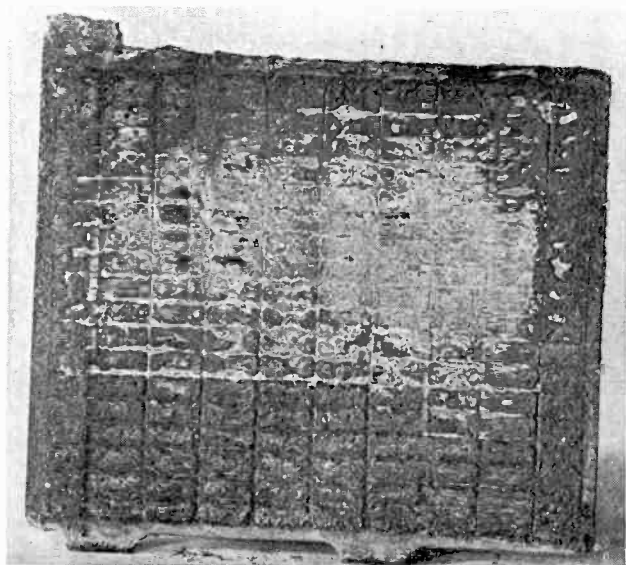
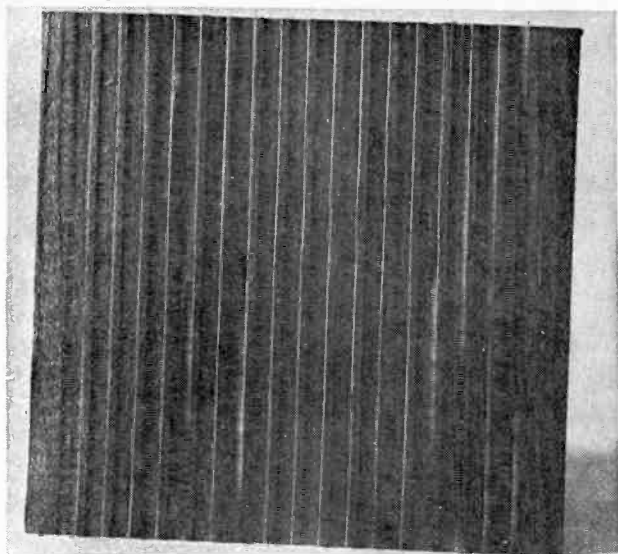

A SPOILED PLATE AND A SEPARATOR

Figs. D and E: Above is shown a wood separate, while the picture below shows a badly sulphated plate caused by over discharge.

of the plates, which last frequently occurs inside the cell. Internal short-circuiting may be caused by buckled plates which are so far distorted as to crack the wood separators and come in contact with each other, but it is most likely to be caused by active material deposits which accumulate in the bottom of the cell. When this sediment has reached such a thickness that it touches two electrodes of opposite polarity it will short-circuit the plates to a greater or lesser degree and cause over-discharge with the attendant troubles above named.

A little care will greatly prolong the life of a storage battery. A few random hints may not come amiss.

For purposes of illustration let us consider a six volt, sixty-ampere-hour bat-

tery of the lead-acid type, which has been discharged and needs recharging.

Such a battery may be recharged in several ways. If you have direct current, you may use a few thirty-two candle power lamps, connected in multiple as shown in Fig. I. If you have alternating current, a number of rectifiers that are on the market will serve the purpose, such as the Tungar bulb rectifier or the magnetic rectifiers. These rectify the alternating current and turn it into direct current, as all storage batteries must be charged with the direct current.

Before you put the battery on charge, make sure which is the positive and which is the negative terminal of the battery. The positive is marked "Pos." or + or is painted red; the negative is

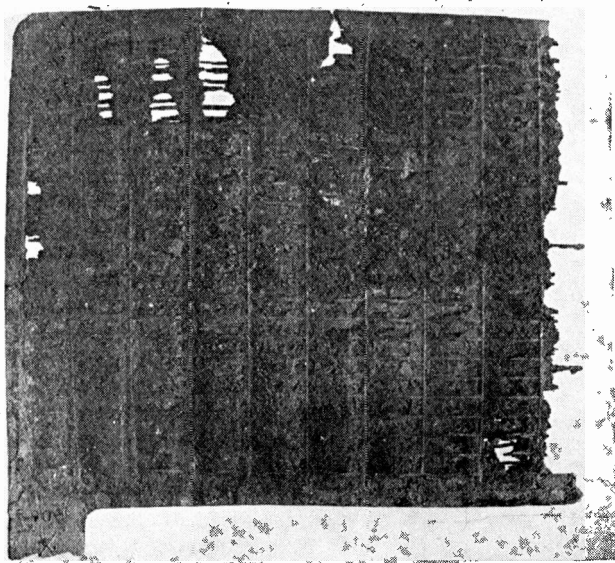

TOO HIGH CHARGING CURRENT RUINED THIS PLATE

Figure F: After years of service, the positive plates gradually go to pieces. This plate gave out long before its time because of excessively high charging rates and prolonged over-charging. The large amount of gas produced under these conditions loosens the active material and it drops out.

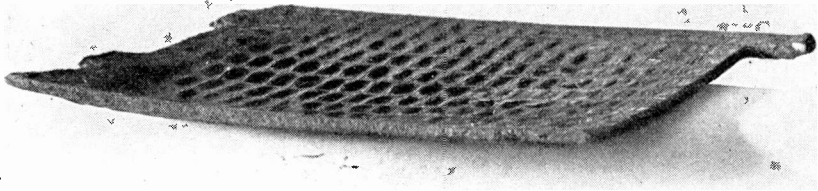

THE RESULT OF OVER-DISCHARGING

Figure G: When current is drawn from the storage battery, the acid in the solution combines with the plates and increases the volume of the material in them. When carried beyond the proper limit, this causes the plates to swell and buckle.

marked "Neg." or —, or is painted black. The polarity of the charging wires (if they are not marked), may be determined by placing them in a glass of water to which a teaspoonful of salt has been added; if you do this make sure that the wires are not too close together. Fine bubbles of colorless gas will collect on the negative wire under water.

The positive terminal of the battery must connect with the positive wire of the charging circuit and the negative terminal of the battery must connect with the negative wire of the charging circuit.

The battery is now on charge. The direct current flows through the plates and the solution, causing a chemical action which takes off that part of the solution that had combined with the material in the plates during the discharge and returns it to the solution again. Great care should be taken that the charging rate is not greater than the correct charging rate of the battery. (This is usually shown on the manufacturer's nameplate).

Let us assume that the charging rate of the battery is five amperes and the battery is a sixty ampere hour type. Therefore we will charge it for twelve hours. For example: $5 \text{ amperes} \times 12 \text{ hours} = 60 \text{ ampere hours}$. However, this should be determined by means of a

hydrometer or hydrometer syringe. By inserting the end of the syringe in the filling holes of the battery and by drawing up enough solution to float the glass bulb inside of the instrument, the reading of the scale at the surface of the liquid gives the strength of the solution which must be between 1.250 and 1.350 when the battery is fully charged.

Another way of making sure that a battery is fully charged is to leave it on charge for two or three hours after each cell has started to gas or bubble. However, everyone should have a battery hydrometer to test his battery.

Upon discharging the battery, let us assume that we are using a detector and one step of amplification. The two vacuum tubes used are drawing about two amperes between them. The battery has but sixty ampere hours of current; therefore $60 \div 2 = 30$ ampere hours. This means that we can only draw two amperes for thirty hours.

The battery is now fully discharged and must be recharged immediately. However, a battery of sixty ampere hours' capacity that has two amperes drawn out of it should never be discharged for more than twenty-five hours. This leaves some life in the battery, which lengthens the total life of it.

Hydrometer readings should be taken

at least once every week and pure distilled water should be added to the solution at least once every week, so that the plates are always covered. The full charge hydrometer reading of a lead-acid cell should be between 1.250 and 1.300 and the battery should never be discharged below a hydrometer reading of 1.18. The lead-acid cell has a fully charged voltage of 2.2 volts and discharged voltage of 1.8 volts.

Another type of battery is the Edison cell battery. The positive or nickel plate consists of one or more perforated steel tubes, heavily nickel plated and filled with alternate layers of nickel hydroxide and pure metallic nickel in thin

flakes. The tube is drawn from a perforated ribbon of steel, nickel plated, and reinforced with eight steel bands, equidistant apart, which prevent the tube from expanding away from and breaking contact with its contents.

The negative or iron plate consists of a grid of cold rolled steel, nickel plated, that holds a number of rectangular pockets filled with powdered iron oxide. These pockets are made up of a finely perforated steel, nickel plated. After the pockets are filled, they are inserted in the grid and subjected to great pressure between dies which corrugate the surface of pockets and force them into good contact with the grid. The elec-

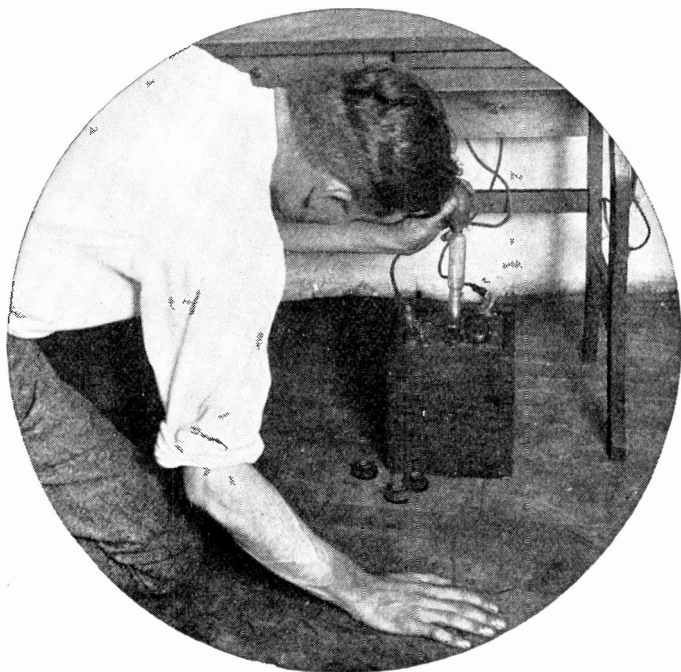

TAKE YOUR HYDROMETER READING ONCE A WEEK

Figure H: The full charge hydrometer reading of a lead acid cell should be between 1,250 and 1,300, and the battery should never be discharged below a reading of 1.18.

trolyte consists of a 21 percent solution of potash in distilled water with a small percent of lithia. The density of the electrolyte does not change on charge or discharge. The Edison cell has a fully charged voltage of 1.2 volts and a discharge voltage of .9 volt. The Edison cell may be overcharged or over-discharged, or even short-circuited,

without injury to the plates. The lead cell, if allowed to remain idle, will lose its charge, and if left in a discharged or a partially discharged condition for any length of time, deterioration of the plates will take place. The Edison cell will retain its charge for a long time and is not damaged by being left in a discharged condition.

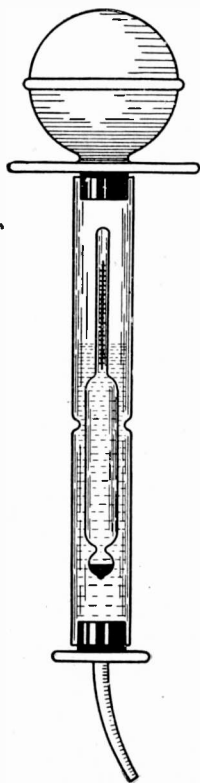

A SPECIAL RADIO HYDROMETER

Figure J: The battery solution is drawn up into the outer glass tube of the hydrometer syringe by means of the rubber bulb at the upper end. The narrow part of the floating indicator is graduated, much like a thermometer, to read in "specific gravity." The point where the surface of the liquid crosses the scale on the float gives the correct reading.

Never leave your storage battery discharged for any length of time, and do not try to use it when it is run down, or it will become permanently injured.

Data for the construction and operation of home battery charging equipment has been included in the following paragraphs for those who care to assemble their own devices at low cost. The reader who is not interested in home-made equipment will also gain a more practical knowledge of battery operation and maintenance if he reads through the following instructions:

The charging of a storage battery is a problem that has to be solved by every radio enthusiast who operates a

vacuum tube set. A storage battery may well be compared to a living organism, which soon dies and must be discarded if it is neglected. On the other hand, a little regular care, water and food—which in the case of the storage battery is water and charging—prolongs its life over a long period.

When a storage battery is discharging, the acid in the electrolyte (liquid) mixes and combines with the active material of the plates. For this reason the specific gravity of the electrolyte, which depends entirely upon the ratio of acid to water, varies as the battery becomes charged and discharged. When the battery has completely discharged

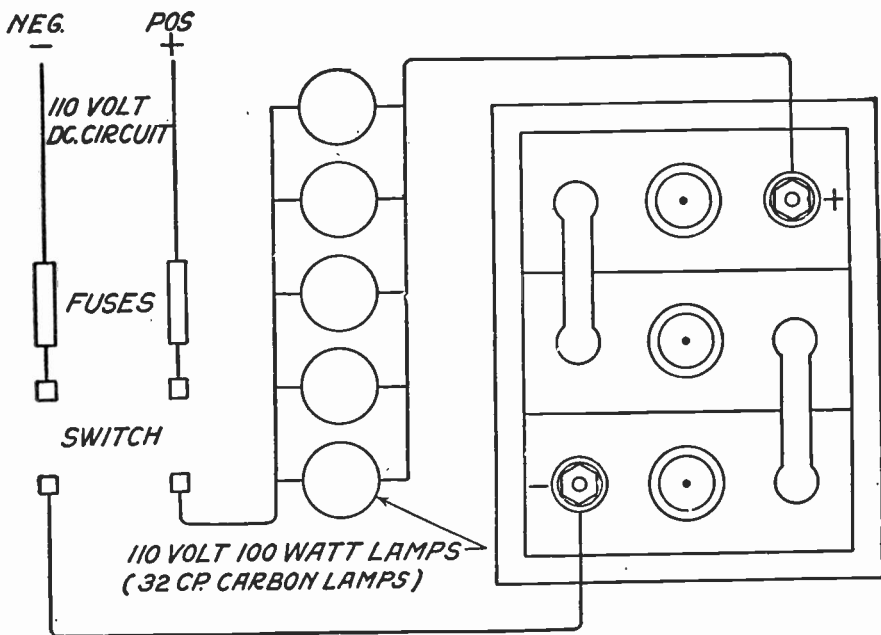

A CIRCUIT FOR CHARGING YOUR BATTERIES FROM THE D. C. LIGHTING MAINS

Figure I: This diagram illustrates the connections that should be used with a 110-volt D.C. lighting circuit through a bank of lamps. Be sure that the positive terminal of the lighting main is connected to the positive terminal of your battery

most of the acid has gone from the water and combined with the plates, leaving an electrolyte that consists largely of water.

When the battery is charged the reverse action takes place; the acid is driven out of the plates back into the water. If all of the acid is not thus driven out, the battery is not completely charged. If this happens a number of times the acid tends to clog up the porous active material (spongy lead) of the plates and the battery become sulphated.

It is seen that the route taken by the acid is either into or out of the plates and that this direction of movement is controlled by the direction in which current flows in the battery. When a battery is discharging, the direction of the internal e.m.f. between the plates is from negative to positive as shown in Fig. K, and that during charge the flow is in the opposite direction. It is necessary, therefore, that the charging current flow in one direction only; in other words, that direct current be used. An alternating current cannot be used because the direction of flow changes periodically. This is shown in the oscillogram in Fig. L.

In this diagram the electromotive force takes a positive direction for $1/20$ th of a second and a negative direction the next $1/120$ th of a second; $1/60$ th of a second is necessary for a complete reversal of current. Such a current is a 60-cycle current; it is the kind supplied to most lighting circuits.

If a rectifier or some other method of eliminating one direction of flow is introduced in the circuit the pulsating direct current that is shown in Figure M results. The lower or negative side of the curve shown by dotted lines is the flow eliminated by the rectifier.

While it is true that the rectified current does not maintain a steady value while flowing, it is uni-directional and therefore suitable for the charging of storage cells.

There are many ways of rectifying an alternating current. Some of the most commonly used and efficient pieces of apparatus are the mercury-arc lamp rectifier, the Kenotron and the Tungar rectifiers, the mechanical rectifier, and the type of rectifier to be described in this part, called the electrolytic rectifier.

The electrolytic rectifier is perhaps the one most easily made by an experimenter who has only a few tools. A photograph of the completed rectifier and resistance is shown in Fig. N. The following materials are necessary:

- 2 mason fruit jars—pint size;
- 2 strips of aluminum; size—6 inches by 1 inch by $1/8$ inch;
- 2 strips of lead, size—6 inches by 1 inch by $1/8$ inch thick;
- A few ounces of borax;
- 4 terminal posts.

The construction is so simple that a lengthy explanation is unnecessary. A close study of the photograph will show that the two strips are bent and hung over the edge of the jar into the electrolyte.

The electrodes as noted in the list above are of lead and aluminum, cut to the sizes given in the list.

The electrolyte consists of two pints of water to which has been added about three heaping teaspoonfuls of borax. A new electrolyte should be prepared and substituted every few weeks. This is necessary because the electrolyte becomes saturated with aluminum particles which come off the positive plate and mix with the electrolyte, thereby

lowering its resistance. The lead plate does not wear away.

The jars used are the pint size mason fruit jars which may be purchased in any hardware or grocery store.

The terminal posts should be one-inch round head brass machine screws with two nuts. Their size should be $8/32$ or $10/32$ thread.

The jars should be set into a wooden rack as shown in the photograph. A rack such as the one shown can be made of whitewood and stained any desired color. The electrical terminals used should be heavy enough to form low-resistance paths for the large current.

While in operation the rectifier "boils" due to the heat produced by the current

that flows through the electrolyte between the lead and aluminum electrodes. The water is therefore evaporated and it is necessary to add water to take the place of that lost by evaporation. It is not necessary to add more borax; this element does not reduce itself by evaporation.

A connecting lead-wire to hook the rectifier up to the lighting circuit is necessary. This should be as long as required and should have a screw plug fitted to one end so that it may be screwed into a light socket. Spring clips should be soldered to the other ends for clipping it onto the rectifier and resistance terminals as indicated in Fig. O.

A double-pole double-throw switch to

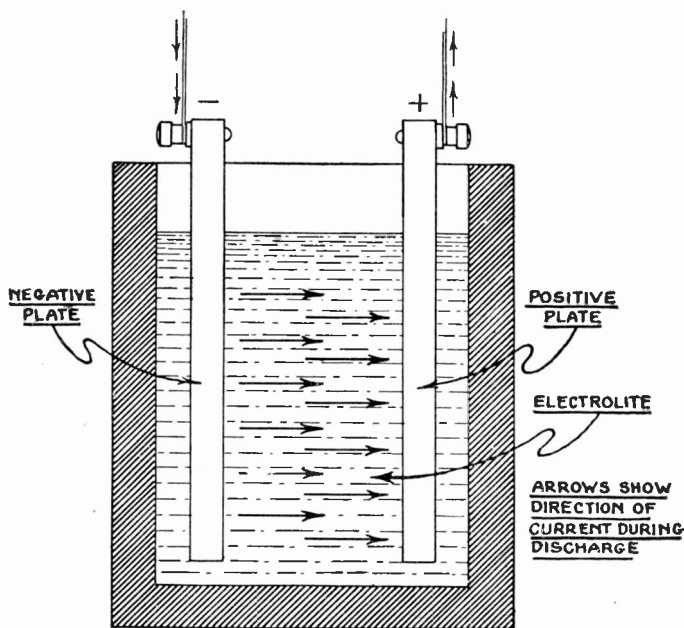

HOW A BATTERY DISCHARGES

Figure K: When a battery discharges the current flows outside the battery, through the circuit, from the positive terminal to the negative terminal. The flow inside the battery is from the negative to the positive, through the electrolyte, as indicated by the arrows.

change the battery from charge to discharge will be found convenient and may be connected as in Fig. O.

It is important that the two sets of aluminum plates and the two sets of lead plates be connected together, with the jars paralleled and also that the aluminum strip electrode of the rectifier be connected to the positive terminal of the storage battery. If the polarity is not marked on the battery it may be determined in any of the following ways:

1. Cut a potato in half, and insert the two leads from the battery; a green formation will take place around the positive terminal.
2. A direct current voltmeter will read correctly only if connected positive to positive and

negative to negative. Get a reading on the voltmeter and note the markings on the connecting posts.

3. Dip the terminals of the battery into a glass of water into which a little salt has been dropped, being careful not to let them touch; bubbles will appear at the negative terminal.
4. Use a polarity indicator; this may be purchased in any electrical supply store.

The rectifier and storage battery should be installed in the cellar near the electric meter. This, of course, will necessitate running two wires up to the radio set but it removes the possibility of any of the sulphuric acid coming in contact with furniture and carpets.

If the battery is installed in any place

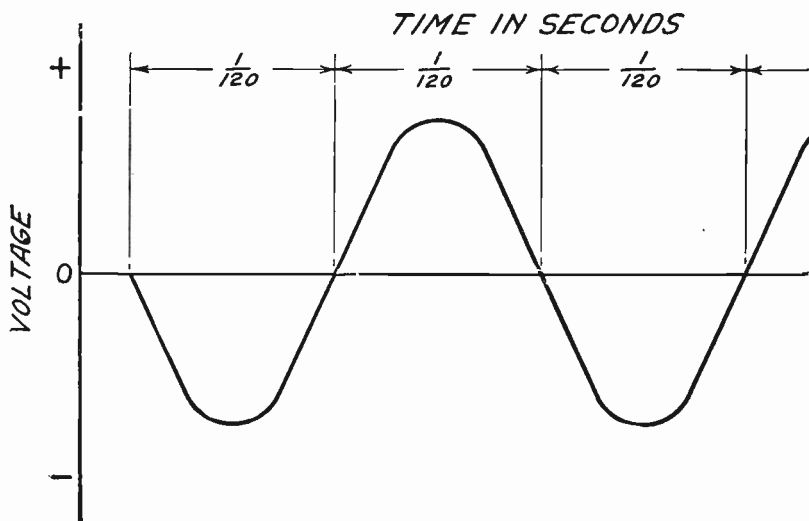

AN ALTERNATING CURRENT WAVE BEFORE RECTIFICATION

Figure L: The ordinary lighting current in most homes is 110 volts, 60 cycles, A. C. This means that the current reverses its direction of flow 120 times a second. In this form the current is useless for charging a battery

where it may injure fabrics or furniture, it should be kept scrupulously clean. It is well, any way, to keep the lead connectors and terminals coated with vaseline. Always unscrew the caps while the battery is on charge so as to allow the gases which are generated to escape.

The generation of gas (shown by bubbling) in the electrolyte while the battery is being charged indicates that the battery is nearing the full-charge point. After this has been going on for four hours it is safe to assume that the battery is fully charged. Providing the capacity of the charger matches the battery.

It is necessary to insert a resistance in the line; such a resistance may be a 100-watt lamp or a water rheostat, made as shown in Figure P.

The jar for this should be 6 inches by 8 inches in size. The electrodes should be lead and carbon. Connect the lead

to the negative side of the line. The electrolyte should consist of pure water to which has been added a half teaspoonful of salt.

Practical application has shown that only two rectifying jars are necessary for the ordinary 40 or 60 ampere-hour battery. If, however, a battery of larger capacity is to be charged, three jars in parallel may be used to cut down the time necessary for charging. Two jars may be used in any case, but the higher the capacity of the battery the longer the time that is necessary for charging.

Before the completed rectifier is put into use it should be connected across the lighting circuit line for several hours until the plates have taken on a crust or deposit. The plates are then said to be "formed."

This is necessary because the rectifier, when it is first connected to an alter-

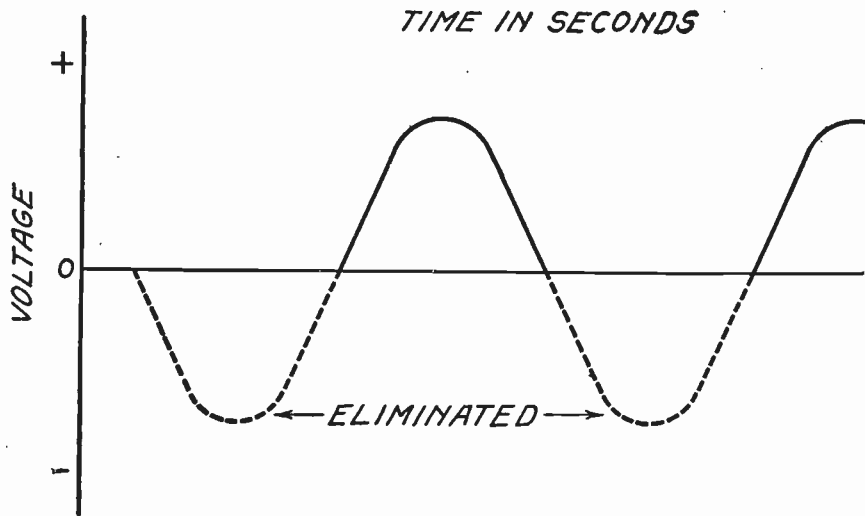

AN ALTERNATING CURRENT WAVE AFTER RECTIFICATION

Figure M: After passing an alternating current (such as indicated in Figure L) through a battery charging rectifier, which "cuts out" one-half of the alternations, a pulsating direct current is left which can be used to charge a storage cell.

nating current line, acts only as a resistance, and if it were connected to the battery without first having the plates formed, it would allow alternating current to flow through the battery.

In other words, the rectifying action of this type of cell depends on the chemical action which takes place in the thin crust or deposit on the aluminum plates, and if the plates are not first formed they will not rectify efficiently.

The only part that has to be replaced in the cell is the aluminum plate, which eats away after a period of usage.

The above type of rectifier has been used for many months by the designer, and it has given him uniformly* excellent results and the cost per charge has been extremely low.

There are many different types of battery chargers on the market and some of them are designed to charge direct from the direct current mains while others are constructed to operate on alternating current circuits. It is easy to see that it is only necessary to reduce the voltage when a battery is to be charged on a 110 volt D.C. circuit. Charging the battery by connecting it directly to a circuit of this voltage would overcharge the device so rapidly that it would soon succumb to the mistreatment. Direct-current charging devices are usually made up of a series of resistance coils so arranged as to get the proper voltage drop when they are used in connection with direct-current circuits. Sometimes a number of electric lights are used in place of the resistance

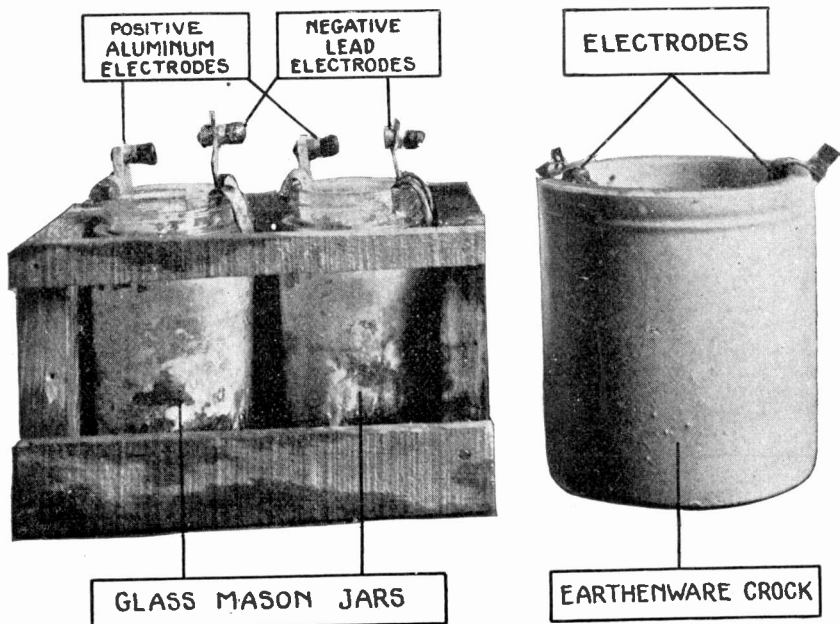

A COMPLETE CHEMICAL RECTIFIER AND WATER RHEOSTAT

Figure N: The rectifier jars are set up in a wooden rack, and an earthenware crock is used to hold the electrodes of the water rheostat. With these two units the radio fan may charge his own batteries at home from the A.C. lighting mains at small cost.

but this is really a wasteful method since the lights must be kept burning while the battery is charging. It is easy to see that something more than a resistance must be placed between a lighting circuit carrying alternating current and a storage battery to be charged. A mere resistance will not suffice because the alternating current will have no charging effect whatever on the battery. This is so because the current has no definite polarity. One instant one side is negative and the next instant it is positive. The charging apparatus must not only reduce the potential of the circuit but it must also rectify the alternating current; that is, change it to a unidirectional pulsating current with the positive and negative polarity. Rectification for purposes of battery charging may be carried out in a number of different ways. There is what is known as a magnetic or vibrating recti-

fier. This is really mechanical rectification brought about by means of a vibrating armature. This vibrating armature which is caused to vibrate by the alternating current impulses, is arranged with a system of contacts so that when it is in motion it functions as a polarity changing switch. It is by so changing the path of the electric current that the current is kept going in a single direction. It will be seen that a vibrator would not have to operate very rapidly to keep pace with a 60-cycle current.

We see in Fig. Q a sketch representing a well-known type of vibrating rectifier. In this instrument the current is allowed to pass only in one direction. When it reverses itself it is prevented from entering the terminals of the battery. The voltage is brought down to the proper level by a small step-down transformer which we see illustrated diagrammatically in connec-

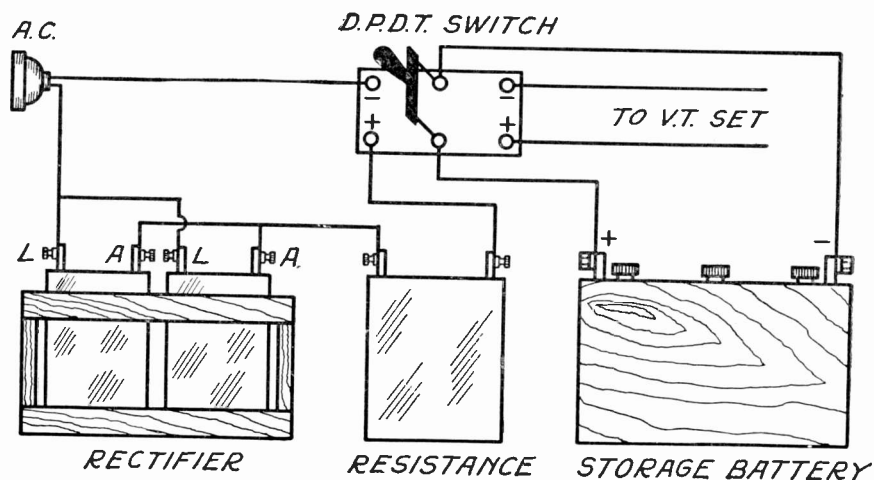

HOW TO WIRE UP A CHARGER

Figure Q: The circuit diagram for connecting up a rectifier, the rheostat, the storage battery and the change-over switch. By throwing the switch to the left the battery is put on charge and by throwing it to the right the battery is connected to the vacuum tube receiving set.

tion with the sketch. A fuse is inserted in series with the ammeter so that the circuit will be protected should a "short" develop on the secondary side of the transformer. The two coils A and B function to operate the armature. When the device is in use the ammeter will register the number of amperes that the battery on charge is taking. If the charger is operating efficiently this charging rate will taper off as the battery becomes filled. It may start at 5 or 6 amperes and taper down to 1.

Here it might be helpful to say something about the indications that a healthy battery will give while it is being charged. It is advisable to remove the filling caps from the cells so that the battery will gas freely for this is one of the indications of successful charging. If the battery is not gassing freely or does not gas at all, it is prob-

ably not charging. In the case of a magnetic type of rectifier, the trouble may be traced to a number of things. The fuse may be blown and in such a case the ammeter would register zero current. It may be also that the clips on the charging wires have not made proper contact with the terminals of the storage battery. Storage battery terminals are very difficult to establish connection with due to extreme corrosion of the metal that is brought in contact with them. Sometimes the filing of the clips on the end of the charging wires and on the battery terminals will overcome this trouble. Although it is not necessary to constantly adjust the contact points of vibrating rectifiers, they do in time become misplaced and it is necessary to move the adjusting screw or screws until a point is reached where the ammeter indicates that the battery

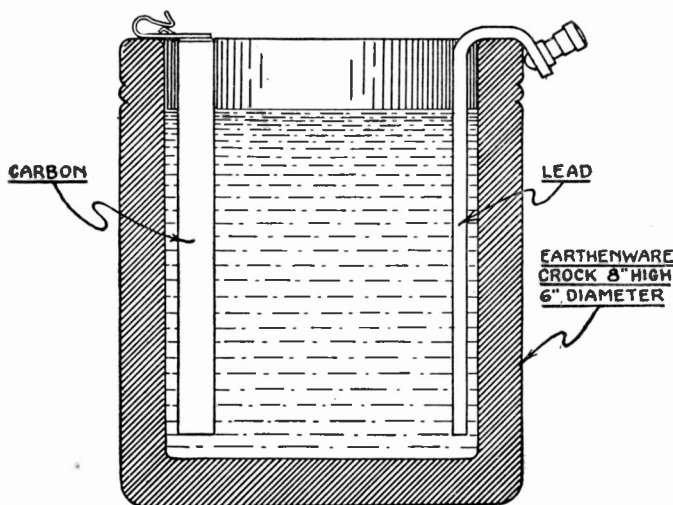

HOW A WATER RHEOSTAT IS PUT TOGETHER

Figure P: The rheostat consists of an old earthenware crock which is filled with water to which has been added a half-teaspoonful of salt. The lead and the carbon electrodes are then immersed in the liquid on opposite sides of the crock.

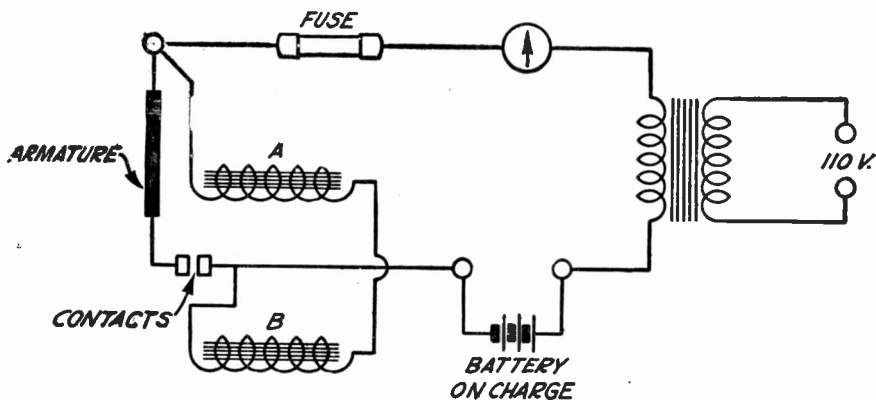

CONNECTIONS OF A BATTERY CHARGER

Figure Q: One of the schemes of connection used in a conventional magnetic charger for storage batteries. The small transformer at the right is of the step down type, bringing the voltage from 110 down to approximately six. Practically all magnetic battery chargers on the market are operated on this principle.

is receiving its normal charging current. Contacts on these devices also burn and it is necessary to eventually replace them with new ones that may be supplied by the manufacturer.

The cautious student will see that when two or more batteries are charged at one time the method of connecting them is important. Since the voltage of the rectifier is usually in the neighborhood of six and since the voltage of a storage cell is about 2.2 more than three cells in series could not be charged. All radio A batteries are made up of three cells connected in series and when it is desired to charge more than one A battery the batteries must be connected in parallel as will be seen by reference to the sketch Fig. R. These parallel connections leave the voltage of the entire battery still six but the current consuming capacity of the system is doubled providing the two batteries are of the same ampere hour capacity. Hence it will take twice as

long to charge the two cells. More than two batteries in parallel is not advisable and as a matter of fact is quite beyond the capacity of the average type of magnetic rectifier. Some of them will "carry on" but they become dangerously hot and might cause trouble unless watched very carefully.

Since radio broadcasting has been commercialized, storage battery manufacturers have accommodated radio users with storage B batteries that may be charged and recharged many times before they are finally exhausted. These batteries are usually put out in 22½, 45, 90 and 100 volt capacities. By dividing every one of these figures by two we arrive at the number of cells in each battery. The cells are sometimes in glass containers and sometimes in rubber containers.

It is impossible to charge radio B batteries with a magnetic charger or any other type of charger used in the conventional way. It is evident that

we cannot hope to charge a 45-volt producer with a 6-volt source. That would be like trying to force a 6-lb. stream of water against a 45-lb. stream. By following out certain directions however, simple provisions may be made so that B batteries can be charged from a vibrating rectifier.

We have shown in Fig. S how such connections are made. The accessories necessary follow.

- 1 2-socket plug.
- 1 porcelain socket.
- 1 60-volt lamp.
- 3 standard attachment plugs.

These plugs are connected up with standard flexible lighting cord as shown in Fig. S. Since the fuses used in magnetic rectifiers are usually of the plug type it is only necessary to remove the fuse and insert the plug as shown. This system works only when the A battery

is being charged at the same time. Omission of the A battery will unbalance the whole system and make it impossible to charge B batteries.

It is a comparatively easy matter to charge an A or B battery from a direct-current circuit since it is only necessary to insert the proper regulating resistances. Such resistance units are available on the open market and they may be connected with a switch as illustrated (Fig. T). In this way it is only necessary to throw the switch over to change the battery connections from the radio set to the charger. All of the connections can be permanently made.

Unless a voltmeter is available it is difficult to determine when a battery is completely recharged. When a battery has been successfully recharged it should cease to gas freely and its temperature may go up considerably. The sides of a battery will always be slightly

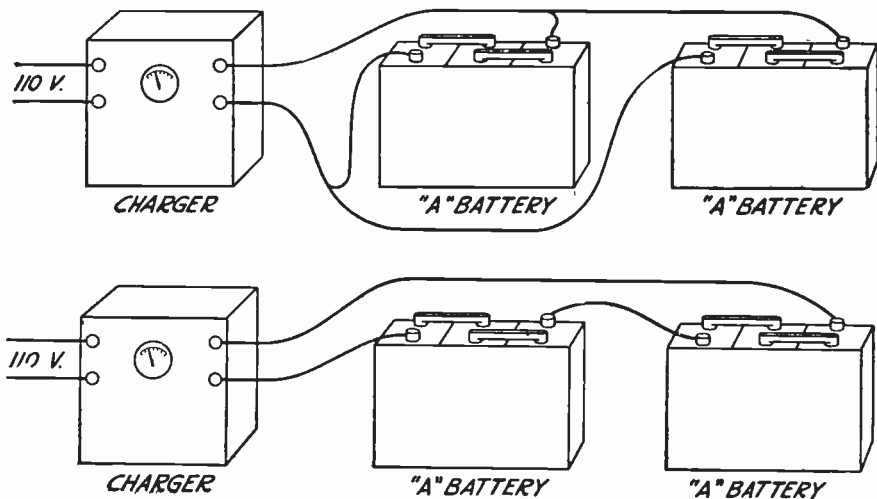

RIGHT AND WRONG METHODS OF CONNECTING BATTERIES

Figure R: The diagram above shows the correct method of connecting two six-volt storage batteries to a six-volt magnetic or vacuum tube charger. The method illustrated at the bottom should never be employed unless a twelve-volt charger is available.

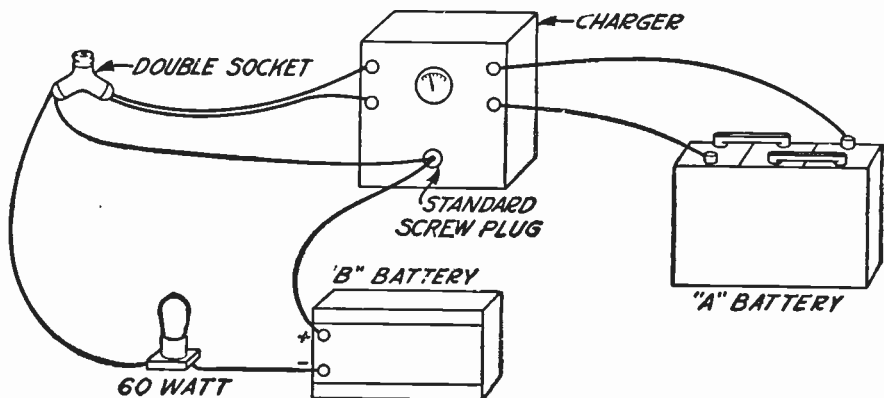

HOW TO CHARGE A B BATTERY

Figure 8: How a B battery is charged with a magnetic charger. This must be done while a six-volt A battery is on charge. The connections shown must be slightly different for the different makes of chargers on the market.

warm after it has been charging for some time. The safest practice is that of applying the voltmeter.

It is not wise to leave batteries in an uncharged condition for any great length of time. In the case of the ordinary lead plate battery this is very dangerous practice and usually results in permanent injury to the cells. If batteries are to be left for a long period (two or three months) unused it is advisable to first give them a good charging. They may then be left either in the wet or dry state. That is, the electrolyte may be poured off or it may be left in. If the electrolyte should be poured off and replaced, chemically pure water, which is available at every battery charging store for 25 cents a bottle, should be used. Water from the city source always contains a sufficient quantity of certain chemicals to destroy storage batteries even when introduced in small amounts. This is especially true of B batteries where the plates are smaller and more delicate and consequently more susceptible to abuse,

either chemical, mechanical or electrical.

Those who object to the hum of the magnetic type of rectifier may desire to invest in the tube type of rectifier. This is more quiet in operation and charges a battery just as thoroughly as the types dealt with previously. In this type of rectifier an exceptionally heavy two element vacuum tube of special construction is used to rectify the 110-volts of alternating current. Of course a step-down transformer is employed in connection with the tube so that the proper voltage will be available at the terminals. Such chargers are used in exactly the same way as the magnetic chargers and all connections save those for charging B batteries are the same.

There has recently come to the American market numerous devices called B battery eliminators. It is the function of such equipment to take current from the lighting circuit for the purpose of placing the requisite charge upon the plate of vacuum tubes, a function heretofore performed by storage

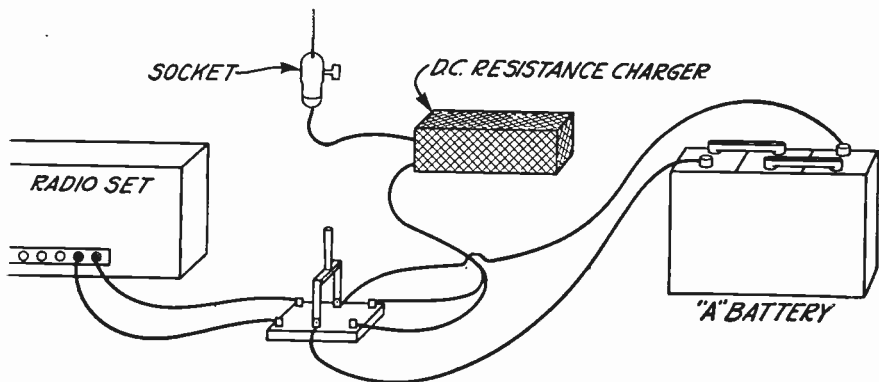

CHARGING FROM THE D. C. MAINS

Figure T: It is only necessary to use a small resistance unit in connection with a D. C. circuit when storage batteries are charged. This illustrates the method of connecting it to the line.

B or dry-cell B batteries. It should be plain to the student that we could not take the raw direct or alternating current from a socket and place it upon the plate without producing distortion in the music. For this purpose we must employ an absolutely unvarying and uniform source of voltage. Even a direct current taken from the lighting socket will be unsuited because of the very considerable commutator ripple. This commutator ripple causes a hum which is quite noticeable in the loud speaker. It stands to reason that alternating current without being rectified and smoothed out would be hopelessly unsatisfactory because of its constant reversals. At one instant there would be a negative charge on the plate and at the next instant a positive charge, while we know from experience that an unvarying positive charge is necessary.

What B battery eliminators do then is to take 110 volts of direct current or alternating current and doctor it up so that it is available for plate use instead of A and B batteries. Of course no

rectification is necessary in the direct current types as we shall see by referring to Fig. V. Here we will find pictured a choke coil, two 4-mfd. condensers and two resistances. The heavy paper-condenser and the choke coil are used in connection with this set to "iron out the ripples" as engineers put it. The tendency of the condensers and the choke coil to eliminate the depressions or the variations in voltage, thereby cutting out the hum that would be present if the 110 volts should be connected directly to the plate. The object of the resistances is simply that of permitting the user to tap off different voltages. It is evident that 110 volts is the maximum amount that could be used with this sort of equipment. As a matter of fact it is really a little less than this for the choke coil has an appreciable resistance which must be overcome at a sacrifice in potential.

The device just described is so simple and functions so beautifully in connection with direct current circuits that the more ambitious reader may wish to

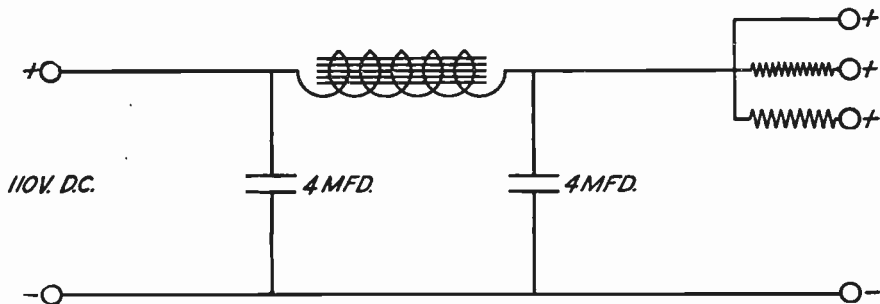

THE PRINCIPLE OF THE B BATTERY ELIMINATOR

Figure U: Here the connections used in a simple type of B battery eliminator are given. This type, however, is designed only for use in connection with a 110-volt direct current circuit.

construct it. The 4-mfd. condensers are available in any large radio shop and the choke coil may be the primary of an ordinary audio-frequency transformer. The secondary connections of the transformer are not used. The two resistances shown are No. 10 Bradley-ohms.

Alternating-current B-battery eliminators are of necessity much more involved than the type just described. Two different types are available. One is a chemical type in which rectification is brought about by a chemical cell similar to that described in the earlier part of this particular portion of the course. After the current is rectified it is put through a circuit similar to the one just described, in which the ripples and irregularities of the line voltage are smoothed out. The other type of alternating-current B-battery eliminator employs a special type of rectifier tube in place of the chemical cell just mentioned. This tube has a filament and a plate and is usually constructed along the lines of the original Fleming valve save that it is capable of handling a large volume of current and is built along modern lines. The filter circuit, which is the smoothing out circuit, con-

tains inductances and condensers arranged in some fashion similar to that employed in connection with the direct current B battery eliminator which was described previously.

Dry cells intended for B battery use do not need to have a very great current capacity and consequently they may be very small in size. This makes it possible to mount a large number of them in a small space so that a battery giving the required voltage does not take up much more space than an ordinary heavy duty dry cell of the type employed for door bells. B batteries are usually made in two voltages $22\frac{1}{2}$ and 45. These classifications are further divided into two sizes, the small and large $22\frac{1}{2}$ and the small and large 45. Of course, the larger sizes last longer because the cells are larger and are able to deliver a greater volume of current over a greater period.

There is really little that a user of B batteries can do in the way of proper care save refraining from short circuiting the terminals. Due to the small cells it is a very easy matter to permanently injure a B battery by allowing it to remain upon a short circuit for only a short time. Batteries should also be

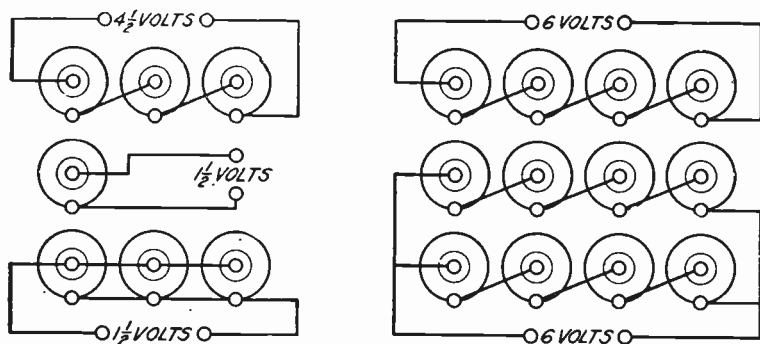

HOW TO CONNECT BATTERIES

Figure V: How batteries are connected to obtain various degrees of voltage and current.

kept in as cool a place as possible for they rapidly deteriorate in an abnormal temperature. Extreme deterioration can usually be detected by blisters that rise on the surface of the sealing wax. The battery may also bulge at other points and if tested under these conditions with a voltmeter it will be found that the voltage has dropped considerably. There is no practical way of reviving B batteries although many radio fans may feel that some of the various chemical treatments do some good. The trouble, expense and muss caused is entirely out of proportion to the results achieved.

The failure of B batteries is indicated in radio sets by a reduction in volume and if the batteries are in a very bad condition by noises caused by extreme chemical action. It is, of course, advisable to have a small pocket volt-

meter on hand to test the batteries when it is felt that trouble is arising from this source. Such voltmeters can be placed directly across the terminals of the large and small batteries without any danger to the instrument. If the hands are sensitive a small shock may be felt from the 45-volt size; but it is usually nothing more than a tingle. However, people sensitive to shock and especially children should not permit their fingers to come across the terminals of two of the 45-volt size connected in series. Such a combination will deliver quite a substantial jolt.

Since ordinary dry cells of the heavy duty type are being used so much nowadays with the dry cell tube the reader may find something of value by referring to Fig. V. Here he will find diagrams showing the different ways in which dry cells are connected for different voltages.

SECTION XV

The Different Types of Receivers

SINCE broadcasting has come into its own our research workers, under the impetus of competition, have added many new types of receivers to the list of those available for public use. Some of these outfits have represented distinct new departures in principle while others have been mere adaptations of the standard circuits. It is a very easy thing to disguise a radio circuit so that the novice cannot identify it, and many youngsters have gained considerable notoriety through the newspapers in developing circuits with new names and old principles.

In this work of classifying radio receivers we had best start at the very bottom of the ladder and give our first attention to the crystal set. In Fig. A we have what is known as a single circuit crystal receiver. By single circuit we mean that we have but one tuned circuit which is the antenna circuit. In reality this is a two-circuit receiver, although for practical purposes it is said to have one circuit. The two circuits that we refer to are the open circuit (aerial circuit) and the closed circuit (tuning coil, detector, and 'phones.) Sometimes this is referred to as a close-coupled circuit because the circuit involving the 'phones, tuning coil and detector are connected directly to the aerial circuit.

An improvement over this single circuit receiver can be made by replacing the single slide tuning coil with a loose coupler, that is a two-coil tuner with the coils inductively arranged, one within the other. It is plain that we have two circuits here, the aerial circuit which is sometimes called the primary circuit and the circuit involving the 'phones and detector which is sometimes called the secondary circuit. The coil in this circuit is also called the secondary coil. The advantage of this two-circuit crystal receiver lies in its ability to tune more sharply and to give a greater signal strength.

Crystal receivers may be elaborated upon by introducing more circuits and by adding variable condensers and fixed condensers, but the money that would be necessary to increase the efficiency of a crystal receiver would be so great an amount that it could be used in the purchase of a vacuum tube outfit. Consequently it would be folly to launch off into an extended discussion of this subject.

If we will refer to Fig. C we shall be given an opportunity to study the various circuits involved in a single vacuum tube receiver containing but one tube which, naturally, is the detector tube. Here we have first the grid circuit. The grid is always connected directly to the

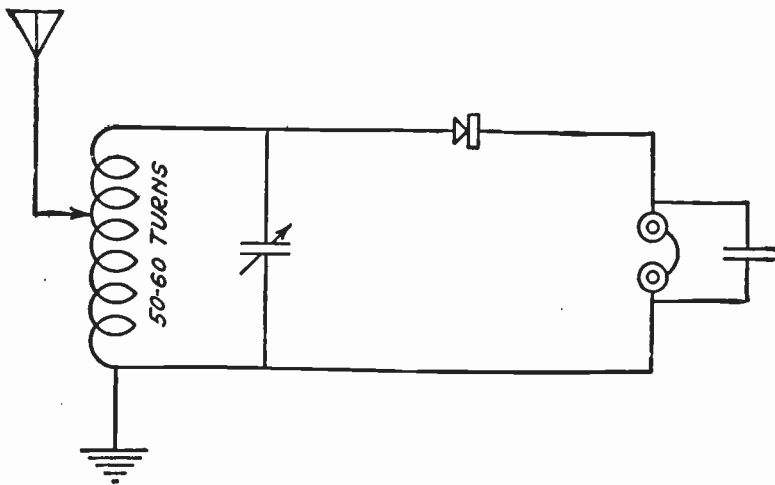

THE SINGLE-SLIDE TUNER

Figure A: This is one of the most simple radio sets that could possibly be assembled. By leaving the system untuned the tuning coil could be eliminated but the aerial would have to be of the correct size for the wave to be received.

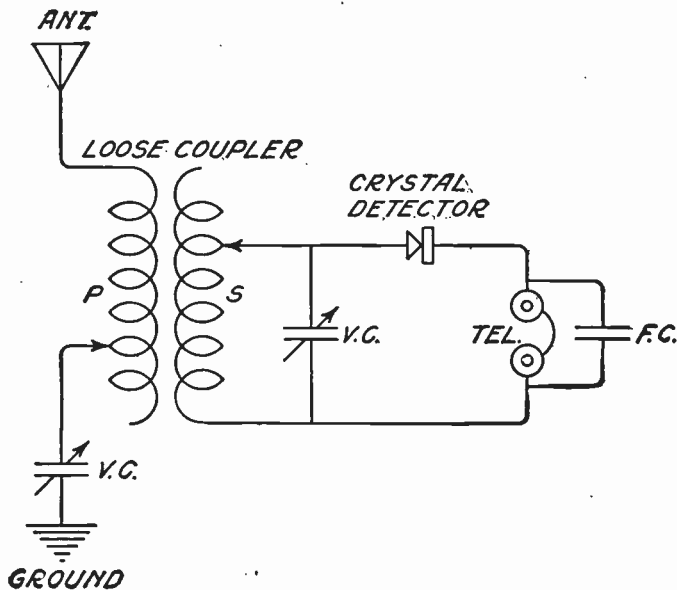

A LOOSE-COUPLED CRYSTAL RECEIVER

Figure B: Here we have a more complicated type of crystal receiver employing two coils inductively related to each other. Louder signals and greater selectivity is claimed for this type of receiver.

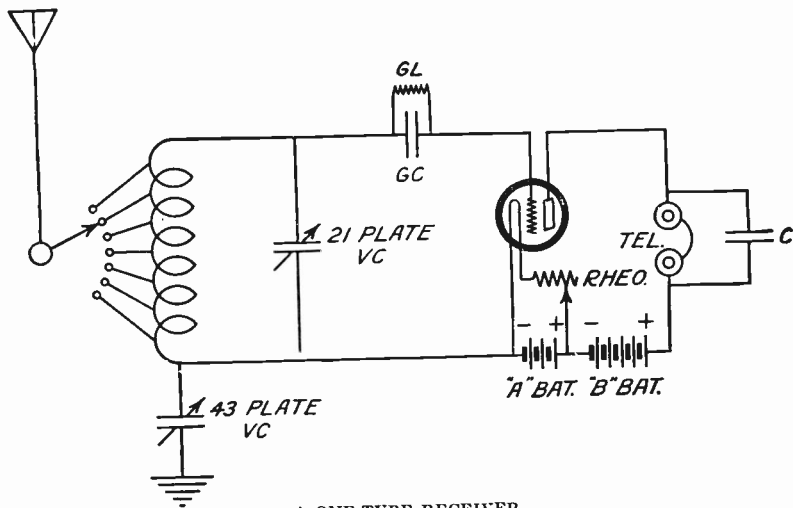

A ONE-TUBE RECEIVER

Figure C: Here is perhaps one of the most practical and simple single tube receivers that could be assembled. The receiver could be made more sensitive by using the regenerative principal.

tuning device. Next we have the filament circuit which involves the rheostat for the control of the A battery current, the A battery itself and the filament of the vacuum tube. It will be noticed that this A battery circuit forms part of the grid circuit as a unit. The third circuit is the plate circuit which is often referred to as the output circuit. This involves the plate of the vacuum tube, the B battery and the telephones or loud speaker. It will also be seen that this plate circuit makes connection with the filament circuit.

In Fig. D we have added two amplifying tubes to the simple circuit shown and it will be seen that we have added several more circuits to the layout illustrated in Fig. C. We have added two more grid circuits, two filament circuits and two more plate circuits. It will also be noticed that we have added another B battery, since a single battery cannot be used for detector and amplifying tubes working together. The

detector must always maintain its own private source of plate-current supply. It is good practice however, to use but a single 45-volt B battery on a two-stage amplifier.

In Fig. E we will find a single tube receiver which is called a single circuit receiver because only the antenna circuit is tuned. This is really not a single circuit receiver because it has the plate, filament and grid circuits. It is only because but one circuit is capable of being tuned that it has been mis-named the single circuit receiver. It might be well to point out here that it is the single circuit receiver that causes so much annoyance by interference in neighborhoods where it is used. It is a prolific producer of squeals and squawks and every squawk and squeal produced is radiated into space to be picked up by perhaps hundreds of receivers in the neighborhood.

Before going further with our discussion of radio receiver types let us for

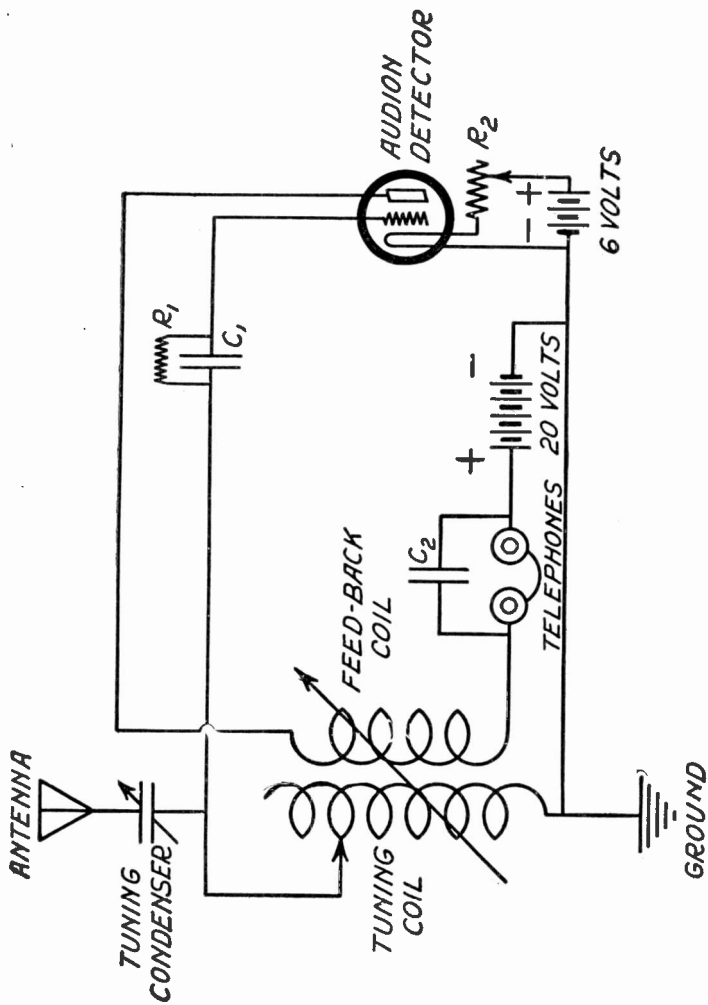

A DISTURBER OF RADIO PEACE

Figure E: Here is a single-circuit regenerative receiver which causes so much interference with reception. This combination is at once a receiver and a transmitter and causes squeaks and howls in neighboring receiving sets. It is a good circuit to avoid.

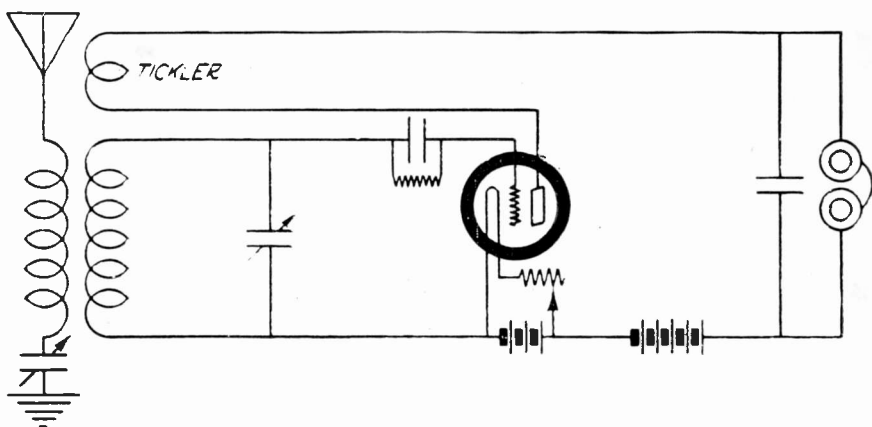

THE TICKLER THAT CAUSES REGENERATION

Figure F: Here a small coil is inserted in the plate circuit and placed in inductive relationship to the secondary of the tuning device. Thus energy is fed back from the plate circuit to the grid circuit.

a moment take up the subject of the regenerative receiver. The single circuit receiver which was depicted in Fig. E was regenerative and very similar to the one shown in Fig. F, which represents the conventional Armstrong hookup. If we study Fig. F closely we shall see that we have nothing more or less than a regular detector and tuner, the only difference between it and a non-regenerative circuit being that a small coil is inserted in the plate circuit and that this coil (which is called a tickler) is brought up so that it is in line with the secondary of the loose coupler. In this system part of the output current passing through the telephones and plate circuit is re-impressed upon the grid of the vacuum tube and re-amplified. This results in a great reinforcement of the signal strength, and the process is sometimes referred to as "feedback", and such circuits are sometimes called self-amplifying circuits, since the vacuum tube is made to serve as a detector and an amplifier. Regenerative or feed-

back circuits may be adjusted by changing the position of the tickler coil in relation to the secondary coil of the loose coupler. When the coupling is made too close an audio-frequency squeal which results in impressing too much energy upon the grid circuit takes place which makes reception impossible. The position of the tickler is simply changed until this squeal disappears and normal reception is secured.

There is another much used method of securing this regeneration or feedback effect, and this is done with a double circuit receiver shown in Fig. G. Here two variometers, one in the grid circuit and one in the plate circuit, are used. The energy transfer is brought about by adjusting the variometer until the grid circuit is resonant with the plate circuit. When both circuits are in tune, the feed-back effect will take place and greater amplification will be produced. While this circuit is exceptionally sensitive it is at the same time difficult to control and unless controlled intelli-

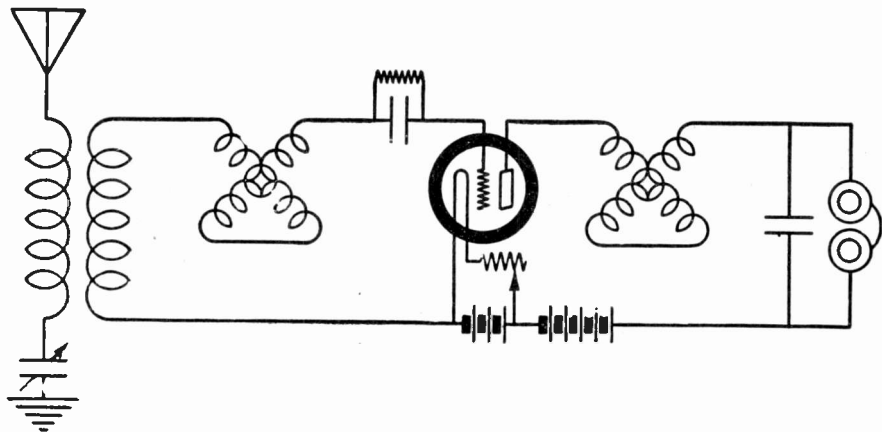

THE TWO-VARIOMETER REGENERATOR

Figure G: Here regeneration is produced by tuning the plate circuit to the grid circuit using the two variometers illustrated.

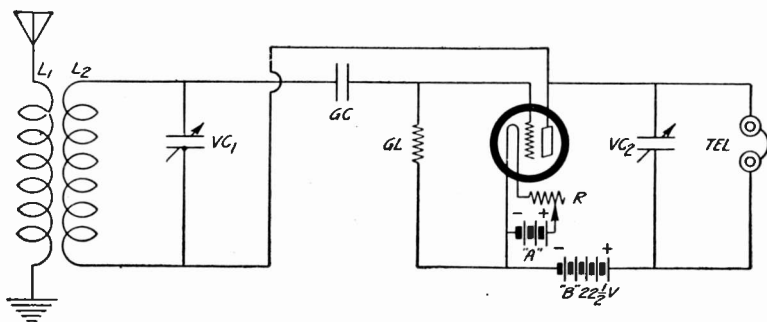

REGENERATION WITH CAPACITY FEED BACK

Figure H: In this case regeneration takes place not inductively but capacitively through the natural capacity of the vacuum tube used in the circuit. This principle is little used however.

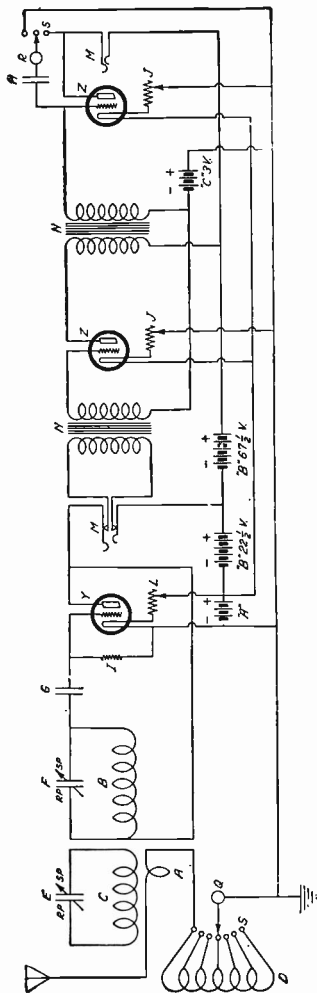

THE COCKADAY FOUR-CIRCUIT, A GOOD MODIFICATION OF THE REGENERATIVE PRINCIPLE

Figure 1: Here is a regenerative set constructed along original lines. Four independent circuits are used and exceptional results in selectivity are accomplished.

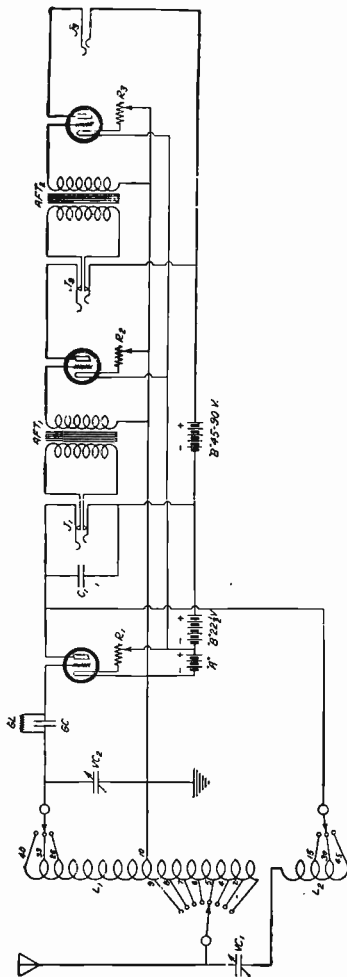

THE RHEINHARTZ RECEIVER

Figure J: Here we have still another modification of the regenerative principle of reception. The Rheinhartz receiver has been vastly popular with the transmitting amateurs.

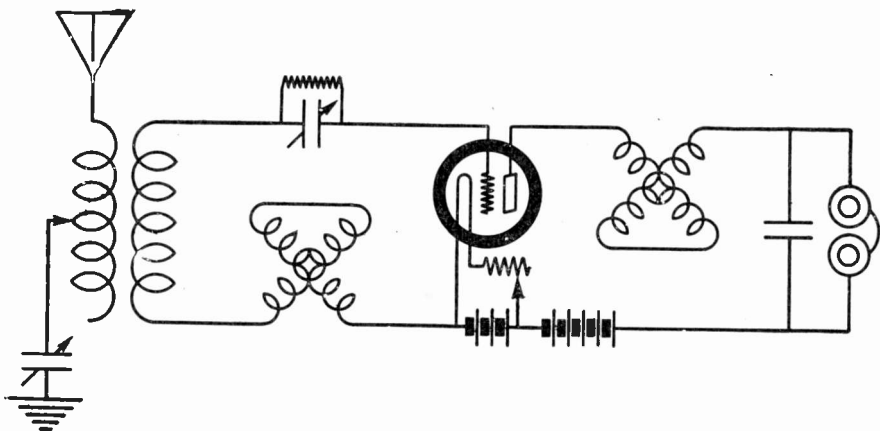

ANOTHER TWO-VARIOMETER RECEIVER

Figure K: This receiver is exactly the same as that illustrated in Figure G save that one variometer is connected in a different position. This is included to show that, although the instruments of a radio set may be connected in slightly different position, the operating principles may remain the same.

gently it is practically impossible to obtain good reproduction.

There are many modifications of the regenerative circuit first discovered by Armstrong. In some cases a capacity feed-back as shown in Fig. H is employed. Here there is a capacitive transformation of energy between the plate and grid circuits. As a matter of fact it is not always necessary to use a condenser for it usually happens that the capacity between the grid and plate is sufficient to bring this result about especially with American made tubes which have large plates and grids. English tubes, due to the ban on regenerative receivers in that country, are made with exceptionally small elements so that the capacity between them is small, hence these tubes are very good for radio-frequency amplification.

The only two really original adaptations of the regenerative circuit that have appeared since the advent of

broadcasting are the Cockaday four-circuit tuner and the Reinhartz tuner. In each case the improvement has been brought about in the development of a selective tuning device. Cockaday achieves greater selectivity by employing the arrangement shown in Fig. I. Here four independent circuits can be traced in the tuning arrangement, the real feature being that, although involved, the circuit may be tuned with exceptional ease, and with a single knob. The four circuit tuner possesses features that closely approach the ideal tuning arrangement. Great selectivity with what practically amounts to unit control is something that engineers have been aiming at since 1922.

In Fig. J we see the second worthwhile adaptation of the regenerative principle which has been developed by Reinhartz, the American Amateur Ace who is recognized in his art on both continents.

In Fig. K we find another regenera-

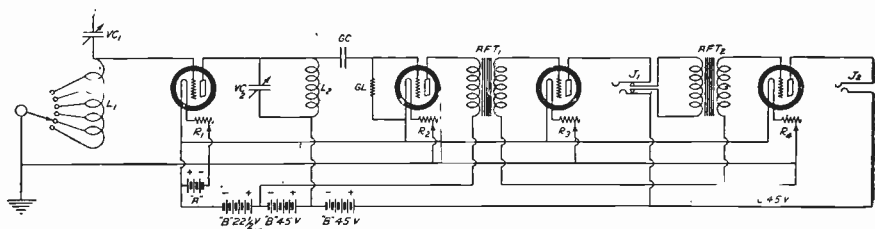

REGENERATION WITH A TUNED GRID CIRCUIT

Figure L: Here we have a variable condenser used in the grid circuit of a regenerative set to bring about resonance.

tive circuit with a few improvements and refinements which help to bring about more agreeable results especially in the matter of control which is so important to the novice. This is a two variometer circuit, or more technically, a tuned plate and grid circuit which involves a variable grid condenser.

In Fig. L there is another version of the tuned plate circuit with the grid circuit controlled by a variable condenser of large capacity in place of the variometer described in connection with the previous receiver. While we are on the subject of reception by regenerative sets it might be advisable to broaden the discussion so as to include brief instructions in operation.

Before a regenerative set of the single circuit type can be operated successfully the novice must learn to control the regeneration; especially the audio-frequency regeneration. This audio-frequency note, which very often develops into an annoying squeal, is developed by the detector, and the amplifying system, of course, functions and makes it much louder than it would be with the detector alone.

There are really two ways of putting a regenerative detector into a responsive condition. One is to turn the filament rheostat until a point is reached

just this side of squealing. In such a condition the loud speaker or telephones will emit a rushing sound of rather low intensity. Under such circumstances the detector will be in a most sensitive condition, and it should, by a little further adjustment of the filament rheostat, bring in very clear signals. There is still another way of adjusting single circuit receivers and this is to bring the filament rheostat to a point beyond that where noise is first heard into another zone of comparative silence. Here again a hissing sound will be registered which indicates a condition of high sensitivity.

Sometimes detector tubes in regenerative circuits are much too sensitive to oscillate because of too high voltage on the plate. It often happens that even $22\frac{1}{2}$ volts, which is the regulation amount for detector tubes, is too high and must be brought down to $16\frac{1}{2}$ volts before the tube will function normally. If a regenerative circuit gives trouble by breaking into oscillation, the reduction in B battery voltage is one of the first remedies that should be tried. It might be said in general that a regenerative set regardless of type is most sensitive to broadcasting and telegraphic signals when the detector is on the verge of breaking into audio-fre-

quency oscillation. The filament rheostat should be brought up as far as possible and it will be found in general that the music will become slightly distorted just before the receiver breaks into a squeal.

The three-circuit regenerative set similar to the one involving the two variometers and the loose coupler is, of course, a little more intricate for tuning but it should not completely baffle the novice if he follows the instructions given below. The initial operation is that of lighting the vacuum tubes and bringing the detector up to its position of maximum sensitivity. The amplifying tubes should never be worked beyond a point where clear reception is possible. Pushing the tubes may allow one to gain a little in volume but the quality of the reproduction is offensive to musically sensitive ears.

Having brought the set to a sensitive condition, it merely remains to tune in a broadcast wave. Of course, this operation is done with the aerial or primary circuit, for we could not hope to enmesh a wave unless it was first caught in the aerial system. The next operation is that of bringing the secondary circuit to a point where it will be resonant with the aerial circuit. This is done by moving the variometer or variable condenser and the position of the secondary coil on the vario-coupler. If this operation is done properly, the signal strength should now be built up to a point where further adjustment in connection with the variometer in the plate circuit should bring the output current to maximum amplitude.

The principle of reflexing has been widely used in radio but so many variations have been made and so many different types of reflex sets have been placed upon the market and described

in publications that it would take a fair sized volume to deal with the properties of all of them. The best that we can hope to do in this particular part of our manuscript is to outline in as practical a way as possible some of the principal receivers of this type. First, however, let us go into the general matter of reflexing. Let us assume that we have connected up in a simple reflex circuit a crystal detector and a vacuum tube. By employing the reflexing principle it is possible to make this one vacuum tube perform two functions. Current can be led to it from the aerial and amplified at radio frequency. It may then be passed on to the crystal detector where it is made audible. From this point it may be passed through the vacuum tube again and amplified at audio frequency. Thus it is seen that this single vacuum tube functions as a radio-frequency amplifier and audio-frequency amplifier simultaneously. In such a case we have a single tube receiver giving results often comparable and sometimes superior to those obtained with more conventional three-tube combinations.

In Fig. M we have a four-tube reflex circuit in which the reflexing is done through two tubes only. The first three tubes function as radio-frequency amplifiers and the incoming signal passes through these tubes before it reaches the detector where it is brought down to an audible range. The output of a detector is then fed to tubes 2 and 3 where the current is amplified at audio frequency.

In Fig. N we have still another reflexing system where the first three tubes are used both as audio-frequency and radio-frequency amplifiers. However, the quality of this combination would not be as good as the qual-

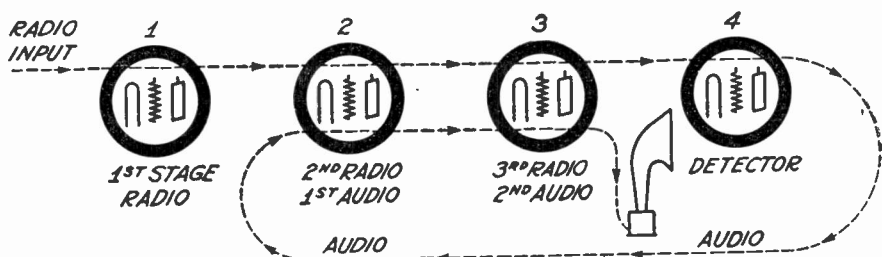

A FOUR-TUBE REFLEX

Figure M: In this set, two tubes of a four-tube set are caused to perform two separate functions, acting both as audio and radio-amplifiers simultaneously. The effect is that of six tubes.

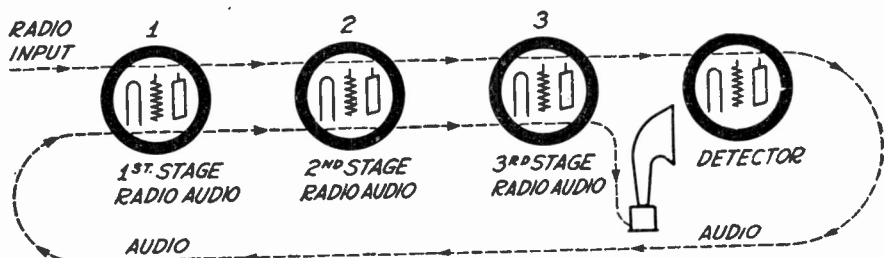

ANOTHER FOUR-TUBE REFLEX RECEIVER

Figure N: The first three tubes here are caused to do double duty and we have in a four-tube receiver the working equivalent of seven tubes. It will be noticed that the first three tubes are used as both audio and radio-amplifiers.

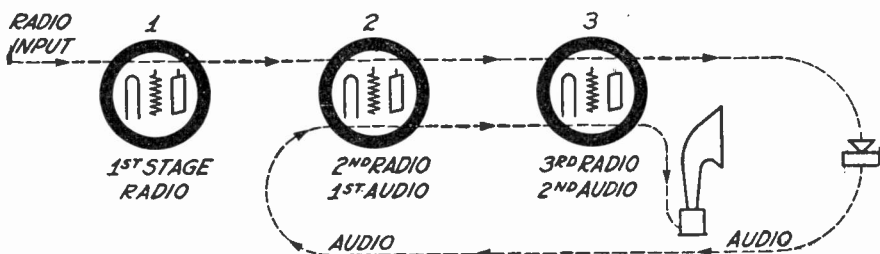

A THREE-TUBE REFLEX WITH CRYSTAL DETECTOR

Figure O: Here the reflex principle is used with a crystal detector, which, although not as sensitive as the vacuum tube detector, is found suitable when the current is amplified before it is detected.

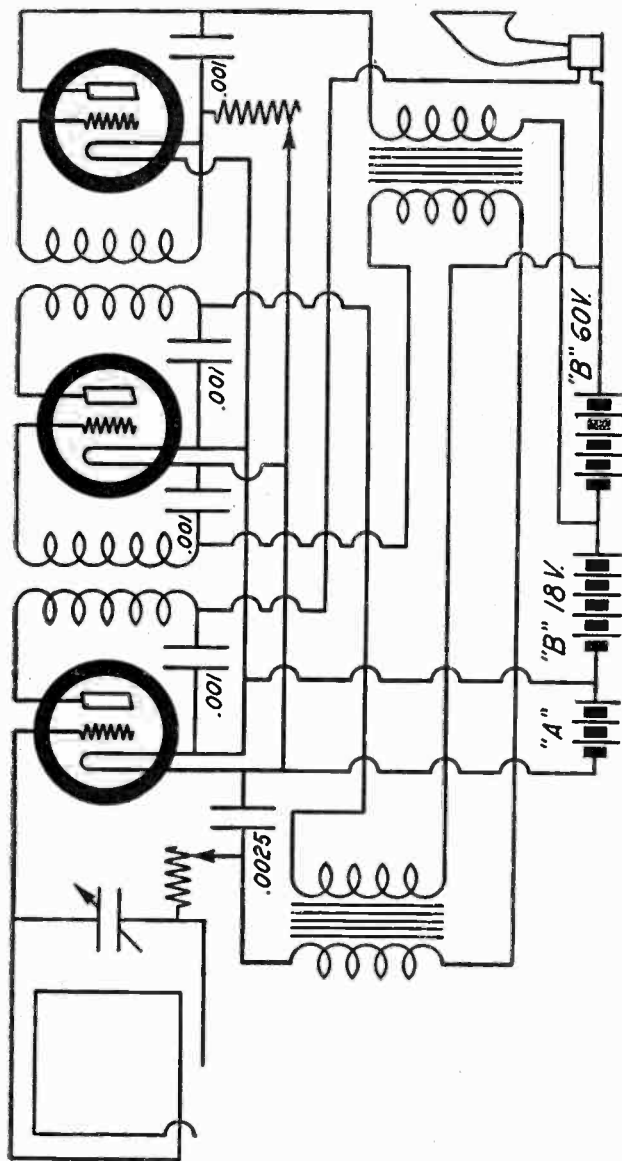

A REFLEX PRINCIPLE IN PRACTICE
 Figure P. Here is the hook-up of a Grimes inverse duplex receiver involving the reflex principle. Three tubes are made sensitive enough so that a loop aerial may be employed.

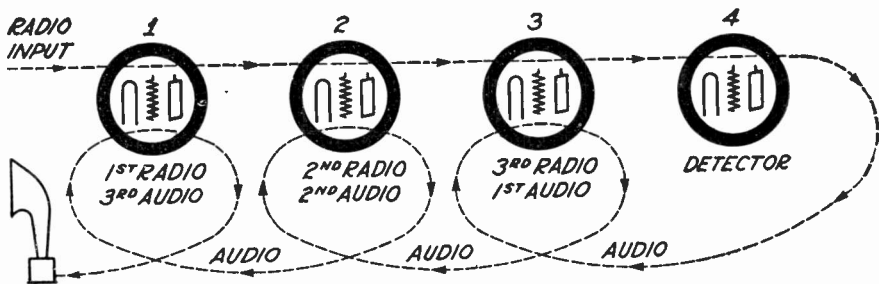

STILL ANOTHER PRINCIPLE OF REFLEX ACTION

Figure Q: Here is the Grimes principle illustrated in a simple way. It is this reflex principle that is employed in the receiver illustrated at Fig. P.

ity of the reflexer shown in Fig. M.

In Fig. O we have a reflex outfit very similar to the one shown in M save that three tubes are used, a crystal performing the function of a detector tube.

Grimes, a radio experimenter who has done a great deal of research work in reflexing, has constructed a receiver in which the current takes the path shown in Fig. Q. It will be seen that the current reverses on itself. It will also be noted that the output is taken from the first tube which is both a radio- and audio-frequency amplifier. The circuit used in carrying out this principle is illustrated in Fig. P. The receiver shown is a three-tube Grimes reflex and standard radio material is used throughout.

In the past a great deal of trouble has been experienced with radio-frequency amplifiers because of audio-frequency regeneration taking place between the various circuits involved. This regeneration, even though carefully guarded against, would take place because of the capacity coupling established by the elements of the tubes used. Professor Hazeltine of Stevens Institute, Hoboken, N. J., developed the neutrodyne principle to eliminate this disadvantage of radio-frequency amplifiers. In Fig. R we have a circuit which in a

way describes the Hazeltine method. The phantom condenser connected between the grid and the plate of the vacuum tube represents the always present capacity between the tube elements. The capacity directly opposite this, at the bottom of the drawing is a neutralizing capacity, which tends to stabilize the system and to prevent audio frequency regeneration. This neutralizing condenser takes various forms, but in all cases it is adjustable so that the right capacity can be inserted to overcome the tendency previously mentioned. In the construction of every homemade neutrodyne the real trouble will come in the work of neutralizing the capacity in the tubes of the radio-frequency amplifiers.

In Fig. S we have placed before us what is without doubt the most sensitive and practical combination of radio instruments that can be devised at the present time. This is Armstrong's superheterodyne, and although, large, clumsy and intricate it is an instrument of marvelous sensitivity and will, if properly constructed and intelligently manipulated, afford music of a pleasing character.

Let us see what happens when signals are picked up by the loop in the super-

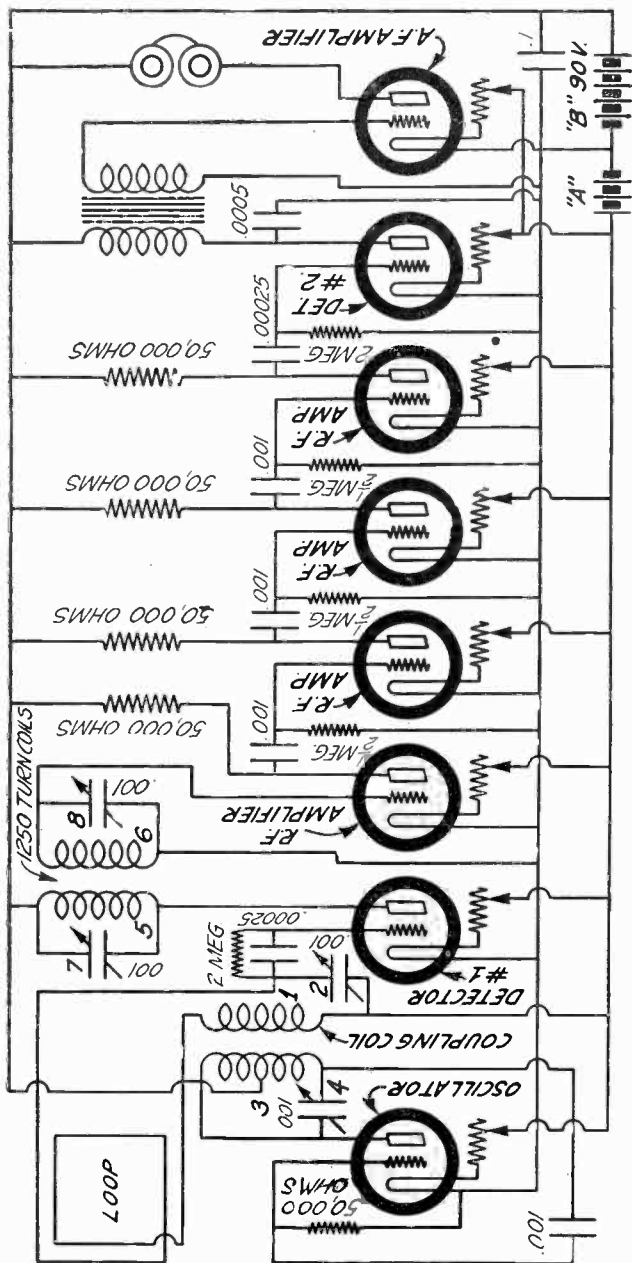

THE COLOSSUS OF RADIO--THE SUPERHETERODYNE

Figure 8. Here is an exceptionally good hook-up of a super heterodyne circuit which affords marvelously sensitive reception with a great degree of quality providing the engineering is done correctly. This is an eight-tube receiver and should have a normal receiving range of 2,500 miles when used with the correct type of aerial.

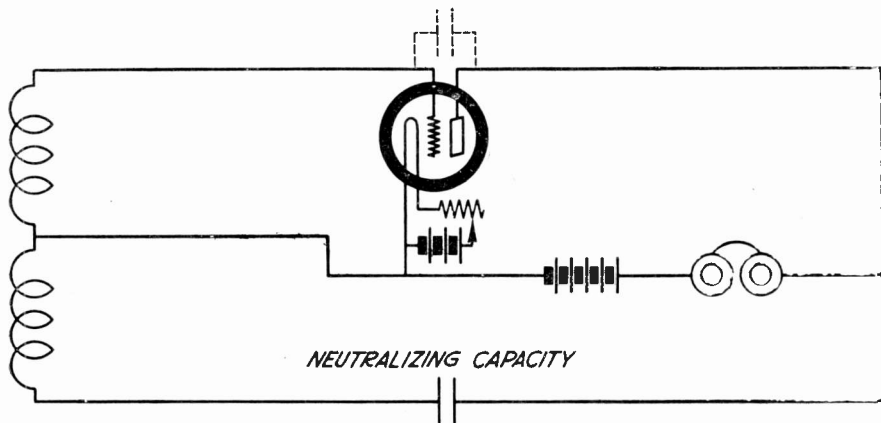

THE HAZELTINE NEUTRODYNE

Figure R: This diagram shows how the capacity of a tube, which is indicated by the dotted lines, can be neutralized by placing a capacity in the position shown. This has the effect of preventing vacuum tubes from oscillating through capacity feed-backs which results from the capacity between the elements of the tube.

heterodyne. It will be noted that this loop is in series with a small coupling coil (1). Connected across the loop and the coupling coil is a 43 plate condenser (2). This particular circuit should cover a wavelength range from about 175 to 600 meters. The inductance (3) and the condenser (4) form a tuned circuit which determines the frequency of the local oscillations. This local oscillation is nothing more or less than a vacuum tube set up to oscillate as it might in an ordinary regenerative receiver. It is made to oscillate at a given frequency depending upon the wavelength of the station being received. It is always adjusted to a frequency

50,000 cycles less than the signal frequency. The output of the first detector will make available this frequency modulated with the desired signal of audio frequency. The 50,000 cycle output is tuned to by means of the two tuned circuits containing coils 5 and 6 and condensers 6 and 7. It is then amplified by the 4-stage resistance coupled amplifier. The signals are then detected by detector (2) and amplified at audio frequency. Briefly this is the principle of the super-heterodyne but as in the case of the reflex many variations are possible and each experimenter has his own particular idea as to what is best to use.

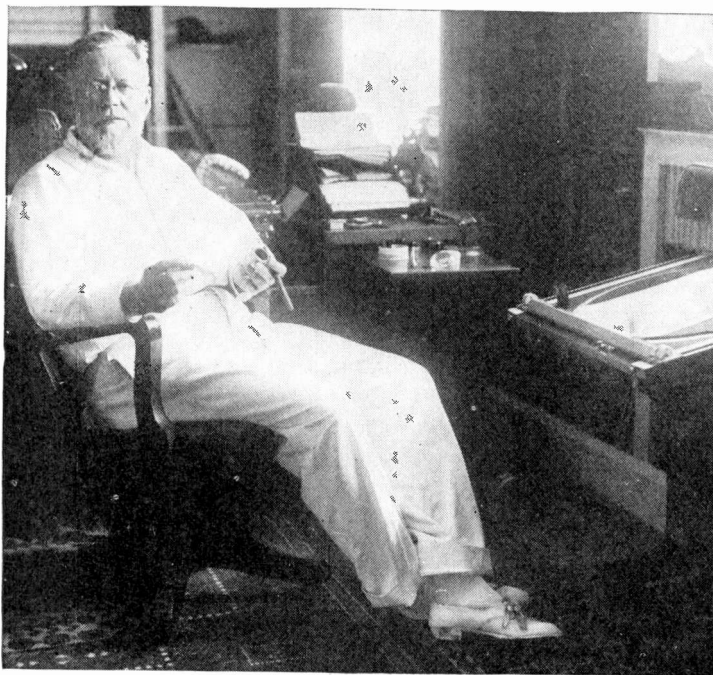

From a photograph made for POPULAR RADIO

Dr. Reginald A. Fessenden

The inventor of the first sensitive detector and one of the most extensive holders of radio patents in the world.

"I congratulate all wireless workers on the fact that in POPULAR RADIO they have a publication which is absolutely independent of all commercial interests. This means a great deal in these days of propaganda. As a rule, I do not read many of the so-called 'popular articles,' but these are so up to date and so authoritative that I am glad indeed to get them, and the fact that they are so lucid that anyone can understand them without previous technical training is a remarkable achievement in this field of work."

—DR. REGINALD A. FESSENDEN

VOLUME IV—CONTRIBUTORS

G. MARCONI, Ph.D.
DR. LEE DE FOREST

PROF. J. H. MORECROFT
MAJ. GEN. GEORGE O. SQUIER

DR. HENRY SMITH-WILLIAMS
MR. P. RANGER

C O N T E N T S

SECTION 16

Important Radio Accessories. Rheostats, potentiometers, meters, jacks, dials, switches, verniers, detectors, coil mountings, loudspeakers, etc. Specifications and description of all important radio accessories.

SECTION 17

The Wonders of Radio Transmission. How waves are generated with vacuum tubes. How the voice is impressed upon radio waves. How the different popular radio transmitting circuits function. Beam transmission. The use of very short waves. Arc transmitters. How radio waves are made to follow a wire in wired wireless. How pictures are transmitted by radio. How movies and colored pictures are transmitted by radio. Radio-dynamics; the control of distant mechanism by radio waves. How the vacuum tube makes the movies talk.

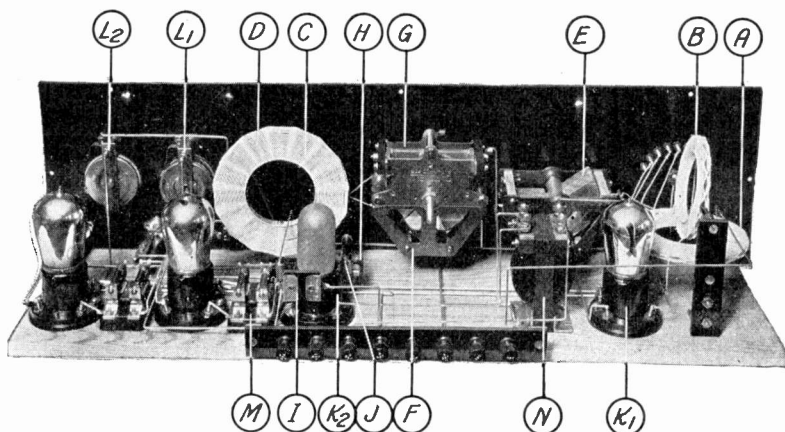

The Sections of the Everyman's Guide to Radio dealing with the various instruments keyed in this illustration may be quickly found by reference to the index below.

ILLUSTRATED INDEX

- A-B—Loose couplers and variometers, Section 10.
- C—Coils, basket wound, D—Coils, honeycomb coils, etc., Section 10.
- D—Radio frequency transformers, all types, Section 8.
- E—Condensers, variable types, Section 9 and 2.
- F—Condensers, variable vernier, Section 9.
- G—Condensers, variable and multiple, Section 9.
- H—Fixed condensers, Section 9 and 2.
- I—Fixed condensers, adjustable, Section 9.
- J—Grid leaks, Section 6.
- K1—Amplifier vacuum tubes and sockets, Section 6 and 16.
- K2—Detector vacuum tubes, Section 6.
- L1—Rheostats, Section 6 and Section 16.
- L2—Potentiometers, Section 16.
- M—Resistance coupled audio amplifiers, Section 7.
- N—Audio-frequency transformers, Section 7.

SECTION XVI

Important Radio Accessories

ALTHOUGH more of an essential than an accessory, reproducing devices usually come under the latter classification. There are two different types of reproducers, the telephone receiver and the loud speaker. There is little electrical or mechanical difference between the telephone receiver and the loud speaker, and the distinction seems to be made largely on the basis of quantity of sound produced. If a conically shaped horn is attached to an ordinary telephone receiver so that the sound waves generated by the telephone receiver are guided through the horn, we have the effect of a loud speaker. Without the horn, which has the effect of amplifying the waves generated by the reproducer, it would be necessary to hold the device to the ear to render the sounds clearly audible.

In a later Section we shall have occasion to learn in detail how sound waves are impressed upon electric currents through the medium of a device called the telephone transmitter. It is the function of the telephone transmitter to convert sound waves into corresponding fluctuations of current. When a sound wave strikes the diaphragm of a telephone transmitter, the current flowing through the transmitter is made to "vibrate" in exact sympathy with the acoustic disturbances.

It is the sole function of a telephone

receiver or a loud speaker to convert these fluctuating, sound-carrying currents back into audible sounds. This, too, is done through the aid of a vibrating diaphragm. Only the diaphragm is caused to vibrate by the fluctuating currents instead of by sounds as in the case of the transmitter. If we refer to Figure A we shall see a diagram of the simple mechanism involved in the conventional type of loud speakers and telephone receivers. The fluctuating currents, which we will recall are produced by the action of the telephone transmitter, are allowed to surge through the electromagnets illustrated. The diaphragm, which is mounted very close to the pole faces of the magnet, will be caused to take on a sympathetic vibration. In the case of radio, the vibration of the diaphragm of the loud speaker or telephone will be in exact sympathy (providing it is a good telephone or loud speaker) with the movement of the diaphragm in the microphone at the broadcasting station. The transmission of sound between the two points is practically instantaneous.

Let us return to Figure A. When the fluctuating sound-carrying current passes through the coils of the reproducing device, it naturally sets up a magnetic field which will be strongest at the ends of the coils. This magnetic field cannot be uniform so long as the current

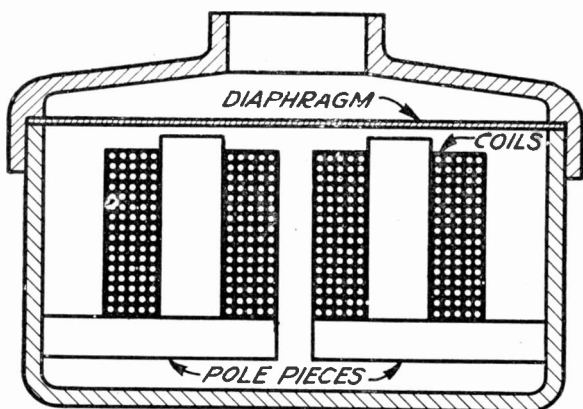

CONVENTIONAL LOUD SPEAKER CONSTRUCTION

Figure B: This loud speaker is really a form of telephone receiver with accommodations made for the attachment of a horn.

producing it is of a "vibratory" nature. If we had some means of seeing magnetic fields we should find that the field above an excited loud speaking element would be vibrating in sympathy with the distant transmitter whether of

the wire or wireless type. Since this highly agitated magnetic field acts on the iron diaphragm the iron will also get into step and make a brave effort to follow the rapid changes. Sometimes the diaphragm succeeds very well in

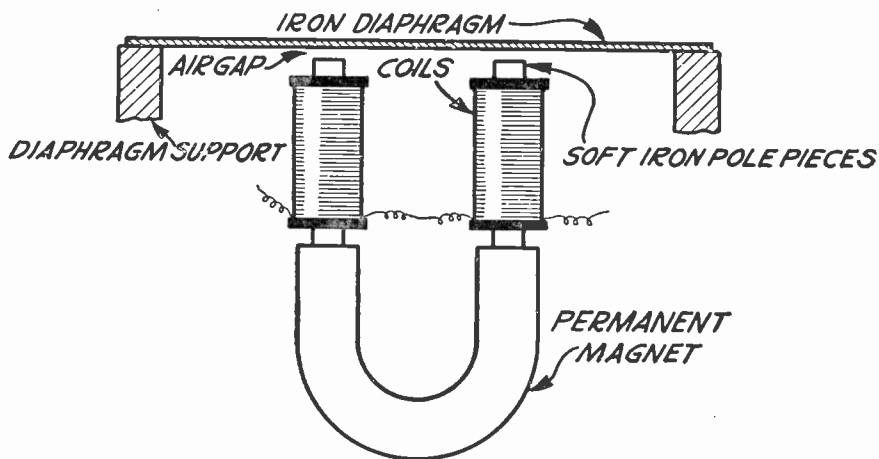

PLAN OF THE LOUD SPEAKER

Figure A: This shows the schematic arrangement of coils and diaphragm used in a loud speaker or telephones.

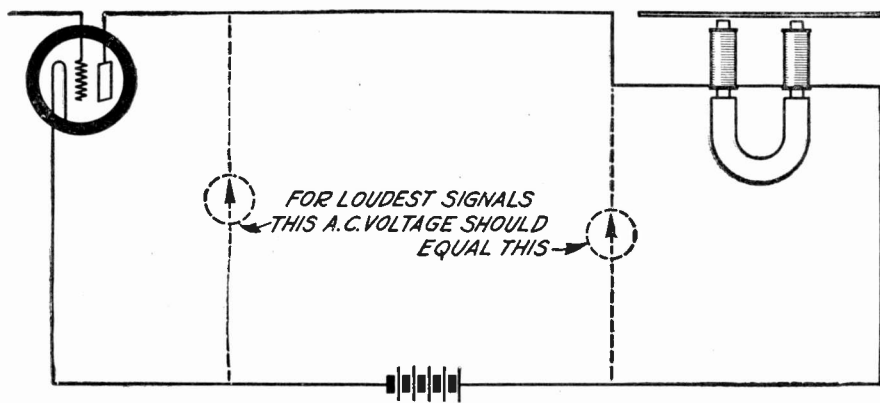

RELATION BETWEEN VACUUM TUBE AND LOUD SPEAKER

Figure C: According to electrical laws, for the most efficient operation the impedance or resistance of the last vacuum tube should match the impedance or resistance of the loud speaker. This is like saying that the alternating current voltage across each should be the same.

good loud speakers and other times it acts very badly as in poorly designed loud speakers.

In passing it will be seen that the diaphragm must be of thin sheet iron, otherwise it will not be sufficiently susceptible to the minute current changes. If the reader is observant he will notice that the coils of the speaking element in Figure A are wound upon the poles of a permanent magnet. He will further reason that the permanent magnet must exert a constant attraction for the diaphragm and that the diaphragm will tend to be pulled down toward the pole faces whether or not a current is passing through the coils. This is very true but this action facilitates rather than impairs the sympathetic vibration of the diaphragm.

All permanent magnets used in telephone receivers and loud speakers do not take the shape shown. Various systems are employed and the permanent magnet usually takes some compact form so that the unit is saved from being bulky and heavy.

The distance separating the poles of a permanent magnet from the diaphragm of a loud speaker is important, because upon this rests to a large extent the sensitivity of the device. In the interests of electrical efficiency it is evident that the pole faces should be as close to the diaphragm as possible so that the magnetic lines of force developed by the fluctuating current will have a minimum of air space through which to travel. Air, it will be remembered, is a most reluctant transmitting medium for magnetism and magnetic lines of force find it difficult to traverse any great distance without being very much the worse for it. Yet it will be seen that the movement of the diaphragm must be allowed for in setting the pole faces of the magnet. If the latter are set too close to the diaphragm, the diaphragm will strike them and this will have a dampening effect which will tend to destroy the quality of the transmitted music or voice. For this reason, some manufacturers have equipped their loud speakers with an adjusting screw which

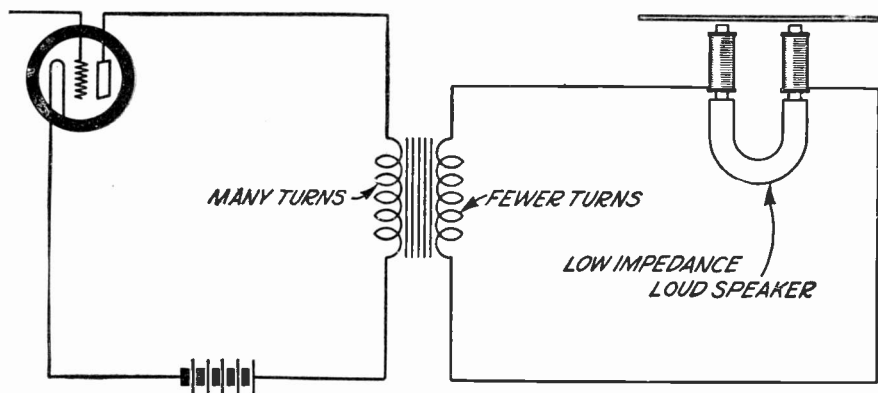

THE LOUD SPEAKER AND THE TELEPHONE TRANSFORMER

Figure D: The proper method of connecting an output transformer to a loud speaker is shown. The transformer illustrated in this case is a special one with a high resistance primary and low resistance secondary.

allows the user to regulate the distance between the pole faces and the diaphragm. This permits a loud speaker to carry extra large volume without rendering the device inoperative.

It may perhaps be helpful to add a few words concerning the exact function

of the diaphragm. We have seen how the diaphragm is made to vibrate with the distant diaphragm. Air rests at the usual pressure upon both sides of the diaphragm and it is natural that any vibration of the diaphragm will be communicated to the air. This is exactly

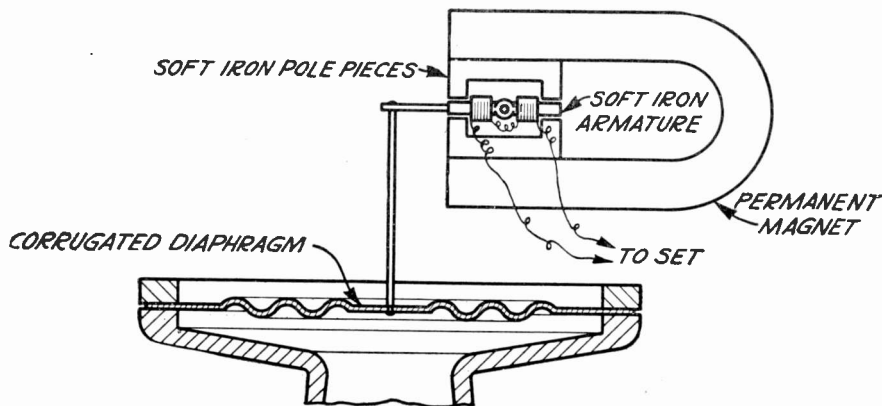

BALANCED ARMATURE LOUD SPEAKER

Figure E: This loud speaker was invented by Baldwin and its main feature is that there is no permanent strain on the diaphragm.

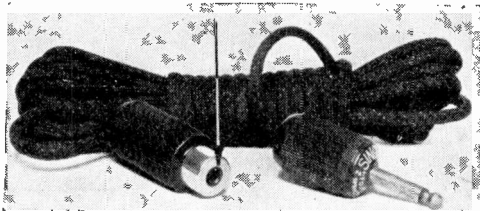

PLUG AND EXTENSION CORD

Figure F: This shows the conventional type of radio plug with an extension cord which permits the user to move the loud speaker about the room.

what happens and the air will be found to follow faithfully every minute movement of the diaphragm.

It is unfortunate that we cannot set the air into direct vibration without the use of some moving intermediary like the diaphragm of a loud speaker or telephone receiver. We can never hope to reproduce the complicated vibration of a symphony with absolute faithfulness while we depend upon a highly inefficient medium like a diaphragm. Those who have studied the physics of sound even superficially have been shown that

every body has a sound or frequency period of its own. For instance, a tuning fork may have a period of vibration of exactly 256. This is determined not only by the physical dimensions of the fork but also by its physical shape. Every body has its own sound frequency or the frequency to which it will respond most efficiently. A cigar box, a half dollar, a kitchen table, a telephone pole; all such things have their own frequency periods and a diaphragm is no exception. Every diaphragm used in a telephone or loud speaker has its own special sound

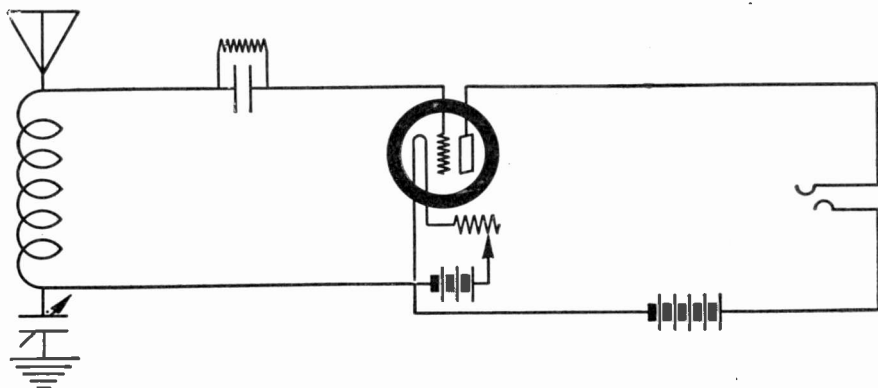

SIMPLE JACK CONNECTION

Figure H: How a two-pole jack is connected to a simple one tube radio receiver.



1



2

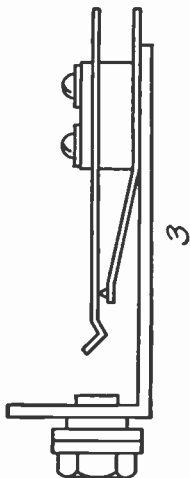

3

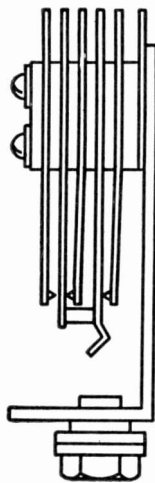

4

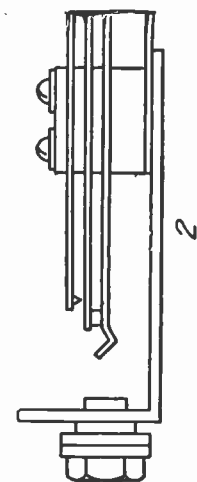

5

FIVE MEMBERS OF THE JACK FAMILY

Figure C: While there are many different types of jacks designed to bring about different connections, the five shown are most used in radio receivers. The purpose of each one is described in the diagrams and the text.

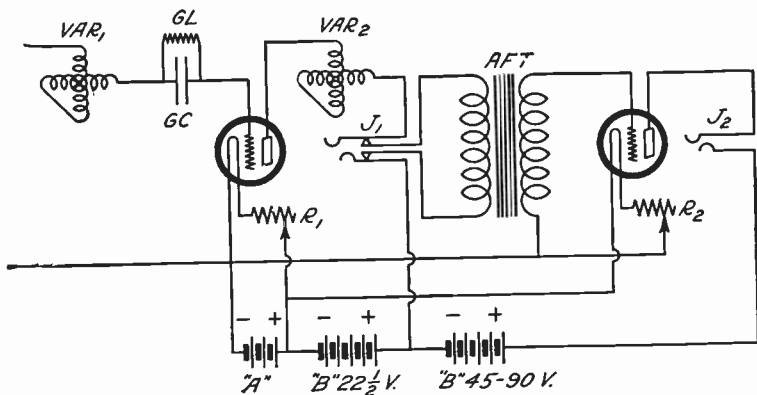

CONVENTIONAL USE OF JACKS

Figure I: By the use of the jacks shown the detector may be used alone or with one stage of amplification.

period which will depend upon (1) the thickness of the diaphragm (2) the diameter of the diaphragm and (3) the particular alloy or metal from which it is made.

There is always one particular frequency which will find the diaphragm most sympathetic and which will represent its highest point of efficiency. We do not mean in stating this that a diaphragm cannot be made to vibrate to sounds having a frequency above or below this natural period. However, it is physically impossible for the diaphragm to reproduce other frequencies with the same degree of faithfulness that it is able to reproduce a frequency near that of its own period. With these conditions holding we cannot expect a loud speaker to respond perfectly to the woodwinds, the bass viols, the kettle drums and brasses of a symphonic orchestra, nor can we expect such a diaphragm to respond with equal efficiency to the voices of baritones, tenors, contraltos and sopranos. Further

research in connection with loud speakers will have to do with the problem of either obviating entirely the diaphragm or finding some diaphragm that will handle a wide range of sound frequencies with fairly reasonable efficiency.

The conventional form taken by most loud speakers is shown in Figure B. The diaphragm is clamped solidly between the case holding the magnets and the cap or top which is screwed to the case. The aperture to which the horn is attached permits the sound waves to pass freely into the small end of the cone.

Trouble with loud speakers takes a number of different forms and perhaps the most prevalent one and the one least suspected by the average lay operator is that of overloading. By overloading we refer to the practice of permitting too heavy a current to flow through the magnets. The radio set with which the loud speaker is used is probably operated at its maximum and the heavy current surging through the magnet pulls the

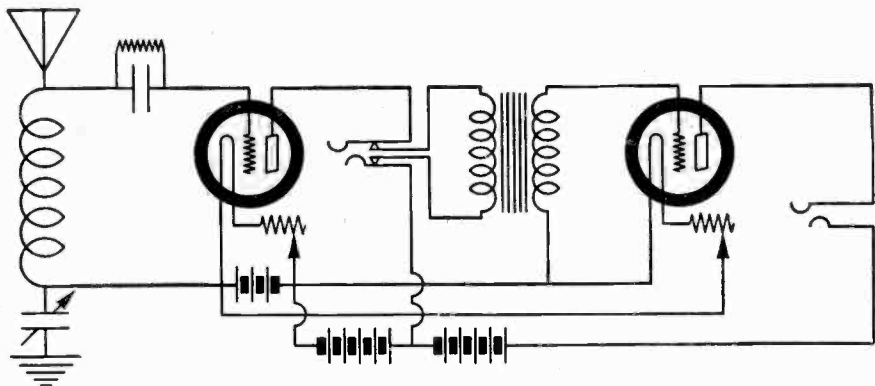

USING JACKS WITH TWO TUBES

Figure J: It is the function of the first jack to cut out the amplifying tube so that the detector may be used alone.

diaphragm down until it hits the pole faces. This results in a high pitched crackle, a sound that resembles metal touching metal. Of course the only remedy for a condition of this kind is that of reducing the current output of the set by retarding the filament current of the vacuum tubes. Nothing is gained by operating a set at high volume; indeed much is lost. The quality will be poor and there is imposed upon the

A and B batteries an unnecessary drain. It should be the rule of every set owner to operate his receiver at the lowest point consistent with good hearing. With the adjustable type of loud speaker the set may be operated at high volume without danger of striking if the adjusting screw is manipulated until the crackling sound is eliminated. However, the quality will be a disappointment to anyone who has a good ear for music.

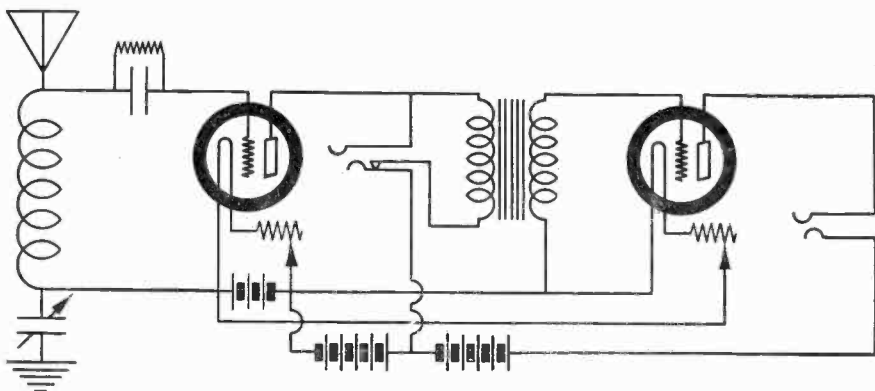

ANOTHER WAY OF USING TWO JACKS

Figure K: Here the action illustrated above is performed by a three-spring jack.

A loose diaphragm is another possible source of distortion and this is always remedied by the simple expedient of screwing down the cap of the speaking unit more tightly. Incidentally the owners of good loud speaking units are warned against the practice of removing the diaphragms for little or no reason or simply through insatiable curiosity. In being removed the diaphragm is very apt to be bent and if it is bent it becomes practically useless. Even the slightest indentation in the diaphragm can be responsible for bad behavior. If the diaphragm of a telephone or loud speaker must be removed it should not be lifted with the finger nails. Due to the constant pulling down of the permanent magnet any lifting done in this way may bend the diaphragm and destroy its efficiency. Diaphragms should be slid off their seat and slid back again. This preserves their flatness which is most essential to good reproduction.

Still another cause of not necessarily bad reproduction but weak reproduction is failing B batteries or A batteries. This is mentioned in connection with loud speakers because some new receiver operators may blame the loud speaker for weak reproduction when the blame should really rest with other parts of the radio set. Tubes that have been used for a long time can cause both poor and weak reproduction. The only way in which a loud speaker can cause weak reproduction is through the loss of magnetism in its permanent magnet. This, however, should not take place for several years, and any suspicion that the loud speaker has lost part of its magnetism can be confirmed or denied by the simple expedient of removing the diaphragm and conducting a simple experiment. The edge of the diaphragm is placed against the pole faces. If

there is enough magnetism left in the permanent magnet to hold the diaphragm on end, the trouble is undoubtedly located elsewhere. Although this is more or less of a rough and thoroughly unscientific test, it is of great value in locating trouble of this nature.

Before we go into the subject of other types of loud speakers it would perhaps be wise to say something about the resistance of both telephone and loud speaking devices. So many lay operators are confused to the point of believing that resistance is an indication of sensitivity. Ignorant or unscrupulous dealers have sold headphones on the strength of their being wound to a resistance of 4000 when a 2000-ohm telephone of good manufacture would probably perform just as efficiently if not more so. All of this illicit traffic based solely on the gullibility of unwary purchasers could have been avoided by brief instruction in the meaning of resistance and its application to reproducing devices.

It is not the resistance of a reproducer magnet that counts so much as the number of ampere turns of wire that are carried by the magnets. To put it briefly, a magnet used for reproducing sound modulated currents through the medium of the vacuum tube should have as many turns of wire as possible in as small a space as possible. For this reason very small wire is used with very thin but highly efficient insulation. Such wire is usually enamelled with a current-resisting medium.

It is more scientific to calculate the resistance of telephone receivers and loud speakers with alternating current at from 500 to 800 cycles than it is to use direct current. A receiver measuring 2000 ohms with direct current may run as high as 20,000 ohms with alter-

nating current of 800 cycles. In such cases the resistance is usually referred to as impedance and instead of saying that a 'phone or loud speaker has an alternating current resistance of 20,000 ohms we say it has an impedance of 20,000 ohms. Impedance is always used with alternating current.

There is an old rule in electricity that states that maximum current from an electric cell will flow when the resistance of the external circuit will be equivalent to the internal resistance of the cell. This holds true with practically every electrical circuit and the vacuum tube and loud speaker are no exceptions. If the last vacuum tube has an impedance of 20,000 ohms between its filament and plate, the loud speaker to operate most efficiently should have the same impedance. Unfortunately, this matching of impedance cannot be brought about with extreme perfection because the voltage across the loud speaker terminals is found to vary with the sound frequencies carried by the modulated current whereas the voltage across the tube elements remains practically constant and is not influenced by the sound frequencies. Reference to Fig. C will help the reader to understand the condition that holds.

It has often been found convenient to produce loud speakers with a very low impedance, but in such cases it is advisable to insert between the loud speaker and the reproducing device an audio-frequency transformer with a secondary impedance that will match the impedance of the vacuum tube employed. The method of connecting such a combination is illustrated in Figure D. The battery shown in series with the plate and secondary of the transformer is the B battery.

In Figure E we have a loud speaker

which represents a severe departure from the conventional types that we have been investigating. We have here a loud speaker that is built on the Baldwin or balanced armature principle. It will be noticed that no electromagnet is brought in proximity to the corrugated diaphragm, but instead a small rod is fixed to the center of the diaphragm with the opposite end connected to an armature suspended on delicate bearings between the poles of a powerful permanent magnet. Since the pulling force of each pole of the magnet is equal and in opposite directions there will be no constant strain on the diaphragm as in the case of ordinary reproducers.

There is wound upon the soft iron armature a small coil and the current impulses from the radio set are permitted to flow through this coil. It is this fluctuating current that causes the armature to vibrate in the permanent field. This vibration is communicated to the small rod connecting the armature with the diaphragm and the diaphragm is thus made to keep step with the armature. Loud speakers of this type are remarkably sensitive and usually provide very good quality.

In the cone type of loud speaker, wherein the diaphragm takes the form of a large paper cone about 12 inches in diameter or more, units of this construction are generally employed. The unit is so mounted that the connecting rod between the armature and the diaphragm is attached to the apex of the cone.

Since jacks and plugs are so universally and abundantly employed in all types of radio receivers, and since they are used largely for the purpose of making connections with loud speaker horns and telephones, it will be advisable to take up their construction and intelligent employment at this time.

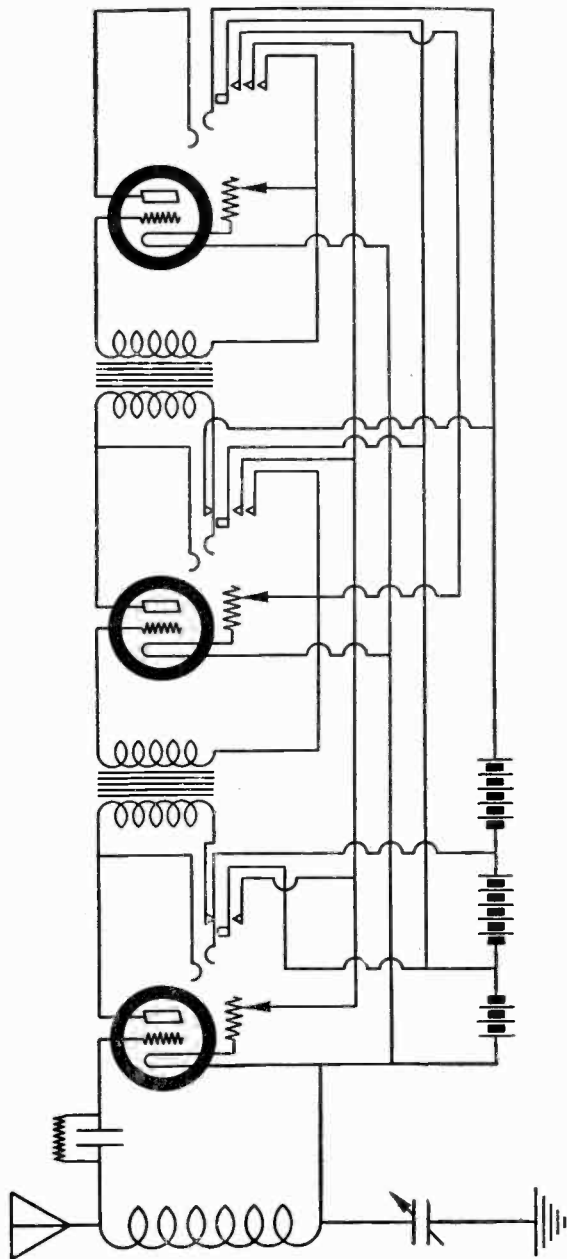

HOW THE MORE COMPLICATED JACKS ARE EMPLOYED

Figure 1: By tracing the connections for these jacks the reader will note that they also control the filament current of the vacuum tubes not in use. For instance, when the detector alone is used the filament current of the two amplifying tubes is automatically cut off.

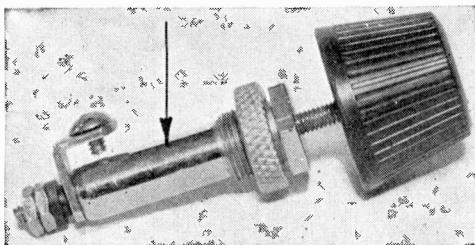

CARBON PILE RESISTOR

Figure O: This resistance unit is operated by varying the pressure on a pile of carbon disks. This varies the resistance.

In Figure F we will see the photograph of an ordinary plug which has been standardized for use in connection with all jacks. That is one fortunate thing that has happened in radio, the standardization of the dimensions of principal parts of all jacks and plugs. Although the various plugs and jacks mentioned each have their individual merits they are all interchangeable.

The plug in Figure F has an insulated covering so that the user may employ it without danger of grounding the set through his body or receiving a shock from a high-potential B battery. The

projecting part of the plug is made up of a sleeve with a rod fixed concentrically within it. The rod and the tube or sleeve are insulated from each other and one is connected to one tip of the telephone cord while the other is connected to the other tip. Various patented means have been devised for holding the tips of the cord to the plug and in some cases it is only necessary to insert the tips. They are held in position by a spring arrangement and the tip will be released only when a small lever or button is pressed. After all a plug is nothing more or less than two terminals

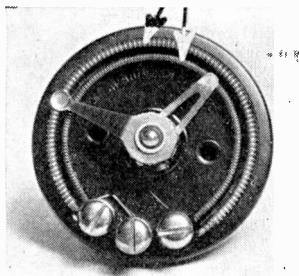

COMBINATION RHEOSTAT

Figure M: This rheostat is provided with two windings and two control handles. One winding serves as a potentiometer and the other as a filament resistance.

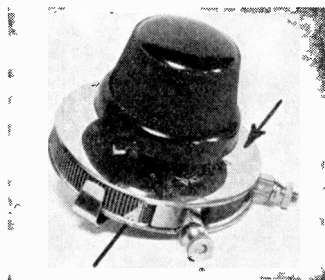

SIMPLE RHEOSTAT

Figure N: This shows another type of rheostat or variable resistance with but a single winding. The binding posts for connections are shown at the side.

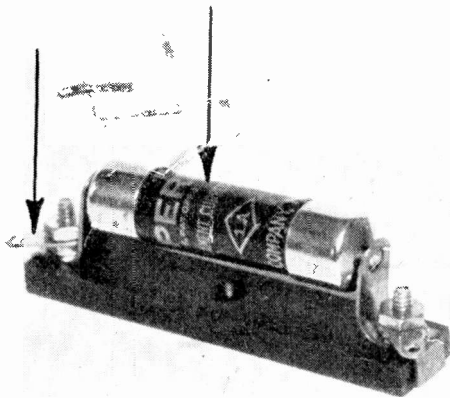

AUTOMATIC FILAMENT CONTROL

Figure R: This filament control is made up of a small piece of special alloy wire sealed in a glass tube. This automatically controls the filament current of the vacuum tube as will be explained in the text.

mounted on the end of a loud speaker cord. The jack is a device used to make connection with the peculiar kind of terminals used on a plug. The convenience sought in these two devices is a fast and reliable means of connecting and disconnecting.

In Figure G at 1 we will see a very simple type of jack. This is usually referred to as a single circuit jack

because connections may be changed in only one circuit at a time. The plug is inserted and the sleeve of the plug makes contact with the bushing through which it passes. Thus the bushing is grounded in the frame. The projecting prong, which is of spring brass or phosphor bronze, slips up onto the rounded end of the rod within the sleeve and thus we have established a double connection.

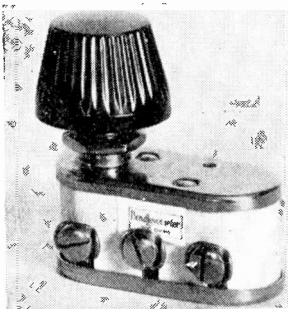

ANOTHER CARBON PILE RESISTOR

Figure P: Here is a potentiometer type of resistor built up on the carbon pile principle. Grid leaks are also made in this form.

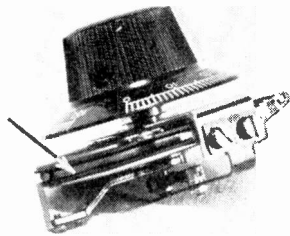

ANOTHER RHEOSTAT

Figure Q: Here is another conventional rheostat of the wire type. It is made up in various resistances from 6 ohms to as high as 30 ohms.

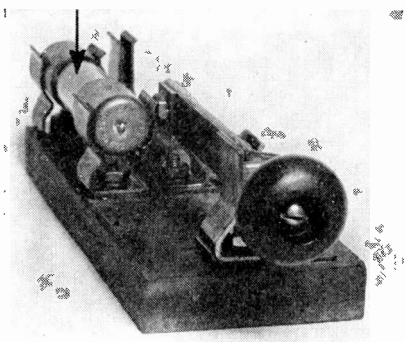

LIGHTNING ARRESTER COMBINATION

Figure T: On this block there is mounted a lightning arrester and a ground switch.

Of course the spring member is insulated from the frame of the jack by an insulating block. Connections are soldered, one to the frame and one to the flexible or spring member.

If we desire to use a jack of this nature in connection with an ordinary single tube radio set it will be employed in the manner shown in Figure H. Inserting the jack between the two contacts shown would establish a connection through the telephone receivers.

If the reader will study the various types of jacks shown in Figure G together with the diagrams I, J, K and L he will understand how many different functions may be performed with these devices. Jack No. 2 in Figure F not only connects the telephones but also lights the filaments of the vacuum tube, acting as an automatic switch. When the plug is taken out of the jack, the spring members return to their normal position and the filament current is

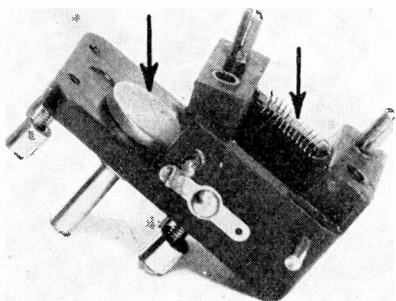

HONEYCOMB COIL MOUNTING

Figure S: This mounting is made to accommodate honeycomb coils with standard bases.

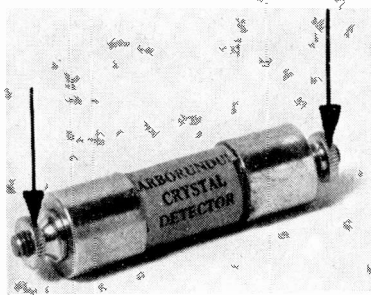

PERMANENT CRYSTAL DETECTOR

Figure U: By mounting a crystal in a very special way the adjustment may be kept permanent. This shows a sealed-in crystal of this type.

interrupted. When the plug is inserted in Jack No. 2, the lower spring member is forced up just enough to bring the two top spring members into contact thus lighting the filaments of the vacuum tubes. Jack No. 5 is a highly complicated one and when a plug is inserted in it it not only connects the telephones

but lights the filament and disconnects both terminals of the following audio-frequency transformer.

On many radio sets we find three or more jacks. The first jack permits the user to plug the 'phones in on the detector alone; the second one allows the use of the detector and one stage of

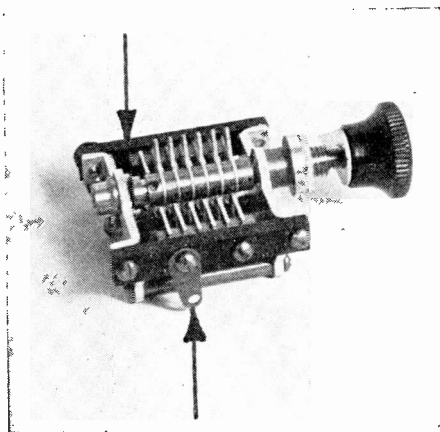

MIDGET CONDENSER

Figure V: By using this midget condenser in connection with a standard size, small changes in capacity may be brought about. This replaces the vernier dial.

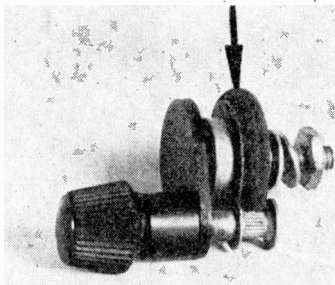

VERNIER ATTACHMENT

Fig. W: By permitting the periphery of the rubber wheel pointed out to come in contact with the edge of a condenser dial vernier tuning may be accomplished.

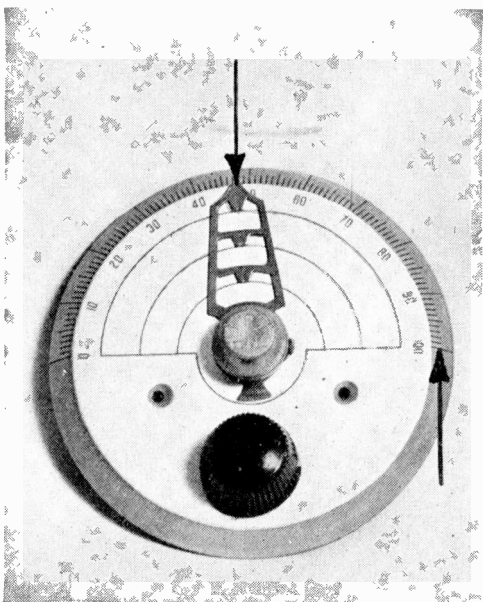

GEAR TYPE VERNIER

Figure X: This vernier operates with internal gears which permit the condenser shaft to turn very slowly through the high gear ratio.

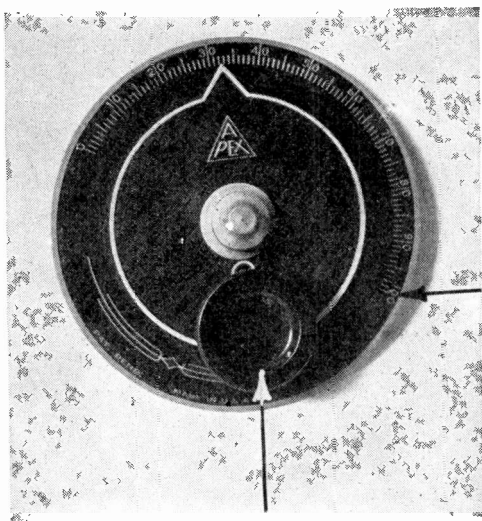

ANOTHER VERNIER DIAL

Figure Y: This shows another type of dial used to make very small adjustments on variable condensers.

audio-frequency amplification while the third jack receives the total output of the set. References to Figure I will show how this is accomplished.

In Figure J we have a simple jack stationed at the detector which cuts the audio frequency out automatically when the 'phones are inserted. In Figure K we have a jack performing a similar function but the jack is of a different type having three spring members instead of four as in Figure J. In Figure L we have a highly complicated circuit in which the filaments of the vacuum tubes are controlled. The first jack controls one filament, the second jack two filaments and the third jack three filaments. By using the proper jacks automatic circuit control is brought about efficiently and quickly.

Rheostats and potentiometers (the latter are usually employed for fine

divisions of voltage) take on two distinct forms both of which are illustrated in Figures M and N. The one in Figure M has a double winding. Sometimes one winding is for the control of the filament current of the vacuum tube and the other winding is made to serve as a potentiometer for grid bias. Then, too, there are certain rheostats on the market with double windings, each one for the control of one vacuum tube. It is simply a method used to combine two rheostats in one for the purpose of simplifying construction. Rheostats of this particular design will be found to have two control knobs, one for each winding.

It is important that the proper rheostat be selected for the tube with which it is to be employed. The table given in Section 6 will help in the matching of rheostats with tubes. If the resistance

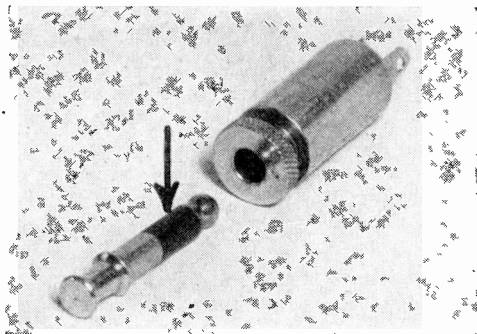

LOCK SWITCH

Figure Z: This shows a filament switch, the plug of which may be placed in the pocket. This is in event the owner does not care to have the set tampered with in his absence.

of a rheostat is too high for the filament of a tube, insufficient current will pass and the tube will fail to function at normal efficiency. If the current consumption of the tube is too great for the wire on the rheostat, the wire will heat up and burn the fibre strip upon which it is wound. This invariably destroys the rheostat and may set fire to the receiver.

Due to the constant sliding of the connecting arm of a rheostat over the wire, trouble is sometimes had with poor connections at this point. Such trouble can usually be corrected by a simple set screw which releases the slider arm and permits it to be adjusted to the shaft.

The type of rheostat and potentiometer shown in Figure O was brought out two years ago and has been found very practical. It embodies a pile of carbon discs and the resistance through the pile of discs will be lowered or increased by varying the pressure exerted upon the discs by the adjusting knob shown in the photograph. By carefully designing a device of this nature, it is possible to produce a regulator that will give a beautiful regulation of current. Rheostats, potentiometers and

grid leaks are made on this principle.

In Figure P we have another form of carbon pile rheostat for the regulation of filament current. This is included to show that current regulators of this nature can take different forms. In Figure Q we have still another type of wire wound rheostat constructed for use in connection with vacuum tubes. There is also on the market a device which automatically adjusts the filament current of vacuum tubes. This is illustrated in Figure R. It is made by sealing a wire of the proper resistance in a glass tube. If the vacuum tube is inclined to draw too much current, the wire becomes heated, its resistance increases and the current is automatically adjusted. The automatic filament controls have a low resistance at low temperatures but a high resistance at high temperature. In other words, the metal wire used has a high coefficient of resistance. These filament controls are made for all standard tubes.

In Figure S we have a much used accessory which is more or less essential when honeycomb coils are used for wavelength adjustment. This is a double coil mounting with the standard

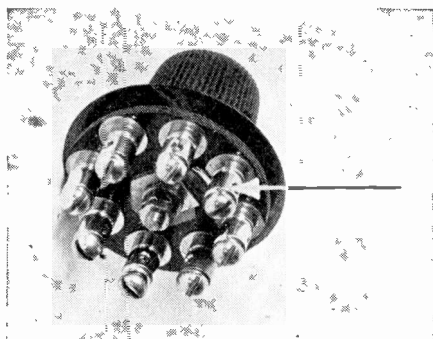

INDUCTANCE SWITCH

Figure AA: This inductance switch is so constructed that the connecting posts are back of the panel. This makes for neatness and practicability.

honeycomb plug so that the coils can be plugged in with a good electrical connection. With this particular type of mounting the shaft to which the arrow points passes through the panel and is

equipped with a regular dial. The other arrow points to a spring member which permits the inductance between the coils to be varied when the dial is rotated. Honeycomb coil mountings

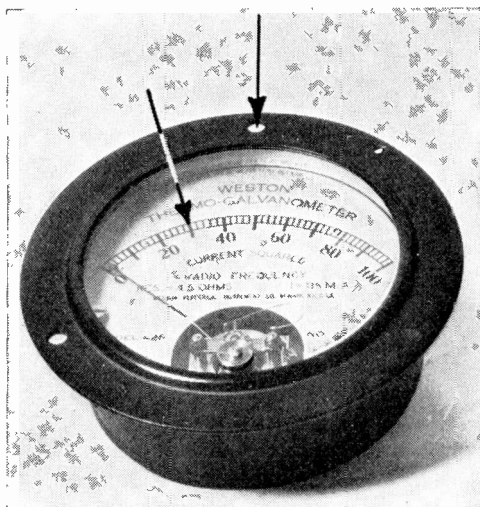

ELECTRICAL METER

Figure BB: Small panel meters of this type are used on the more complicated receiving sets to indicate filament voltage, B battery voltage, filament current, etc.

also come provided for three coils. These are usually used in regenerative circuits with one mounting provided for the tickler coil.

Lightning arresters take on a multitude of different forms. Some are of the vacuum type and others simply employ a small spark gap mounted in a glass cylinder. The arrester illustrated in Figure T is also equipped with a double-throw, single-pole switch which permits the user to ground his antenna when the receiving set is not in use during a heavy electrical storm. Some arresters are made for inside use and others for outside use.

In Figure U we have a conventional form of permanently fixed crystal detector. Detectors of this type are usually made in the form of a tube with the crystal sealed in in some very special manner so that no further adjustment is needed.

In Figure V we have a vernier variable condenser. This is really a midget condenser which is used in connection with larger condensers so that exceptionally small changes in capacity can be brought about. This permits sharper tuning and naturally eliminates some interference.

When vernier condensers are not employed, vernier attachments similar to that shown in Figure W may be used in their stead. Here we have a small wheel with a rubber periphery which is caused to make contact with the edge of the tuning dial. By turning this wheel through the agency of a small knob, the tuning dial is driven by friction and due to the great difference in size or to the ratio of the circumference of the dial to the rubber covered wheel,

a large movement of the latter will cause a small movement of the dial.

Figures X and Y show two other vernier attachments which operate on the gear principle. Reducing gears are housed behind the dials and a slow motion is imparted to the condenser shaft through this agency.

There are multitudes of switches for use in connection with radio sets, but the two principal types are shown in Figures Z and AA. In Figure Z we have a filament control switch which is used on receivers that are not provided with filament control jacks. Operating this switch either turns on all the tubes of the set or turns them all off. One of the features of the particular switch shown is that the plug may be placed in the socket so that the set cannot be operated without the owner's permission.

The switch shown in Figure AA is called an inductance switch and it is one of a great many types. The knob of this switch is mounted on the outside of the panel while the binding posts which are connected to the wires of the inductance which is to be varied protrude behind the panel. This is an improvement over the old method of mounting contact points on the outside of a set with a switch lever to play over them and make the connections.

In Figure BE we have an electric meter of the type used in radio. Both voltmeter and ammeter are employed and in the case of wavemeters, galvanometers or milliammeters of the same size are employed. Such meters are used to check up B battery voltage, measure the drop in filament voltage, measure filament current consumption, etc.

SECTION XVII

The Wonders of Radio Transmission

IN what follows we shall have the opportunity of gathering in some particularly interesting facts about the marvels of modern radio transmission as it is related to the control of distant mechanism (a science called radiodynamics), the transmission of moving and still pictures as well as transoceanic telephony and what has become known as "wired wireless."

Before launching into these absorbing topics it might be wise to first acquaint ourselves with the basic principles of vacuum tube transmitter operation for all of the modern accomplishments mentioned above are based upon this device and its functions. First, let us permit Mr. L. M. Cockaday to tell us how sound waves are converted into electric currents:

"Sound exists only in our brains. We ordinarily say that sound 'travels.' It does not. Indeed, it does not exist at all outside of our brain, for sound is merely a record on our brain produced by a sound 'wave.'

"If there were no human beings on earth, there would be no sounds on the earth—for there would be no brains upon which the sound waves could make a record. Sound waves might be created, but no sounds would be recorded.

"What, then, is a sound wave?

"First of all, we are sure that a sound wave is not a wave of sound, inasmuch

as sound does not exist outside of the living body. From its very name we learn that it is a wave—a wave that makes a record on our brain. But what kind of a wave? A wave in what? Here we have a clue.

"Sound waves are waves in air. We are sure of this because sound waves do not pass through a vacuum. They must have some sort of a medium (such as air) through which to travel.

"The earth is covered with a blanket of air which at any certain point has a fairly constant density; the molecules of air are fairly evenly spaced, in other words. When Milady sits at the opera on a warm evening, she languidly passes a beautifully feathered fan before her face. Little thought she gives to the fact that she is producing a 'wave in the air,' or in other words, an 'air wave.' But she is. In one sweep of the fan the molecules of air are crowded together in front of the fan and spread far apart in the region in back of the fan. A wave is produced; it strikes her face; she feels it.

"This wave is exactly like a sound wave, except that it is produced about once in every few seconds, whereas a sound wave is produced at the rate of from 16 to 20,000 times a second. Air waves which are produced at these frequencies (16 to 20,000 waves a second) then, are called 'sound waves.' We call them sound waves because the human

ear responds only to air waves of these frequencies. We say we cannot hear some sounds because they are too low or too high in pitch.

"A sound wave, therefore, is an air wave of a frequency that can be picked up by the ear and that will produce sound records on the brain.

"How do we hear sounds?"

"Science tells us, in the study of anatomy and physiology, that the ear consists of an outer sounding-board or reflector, which concentrates the sound waves and leads them into a tubular passageway to a thin stretched diaphragm called the ear-drum. This ear-drum vibrates in time with the sound wave impressed upon it and produces a nerve impulse (something like an electric current) which travels along the 'hearing' nerves up to the brain, where it is recorded directly on the brain. This brain record *is* sound. It will be seen that the sound wave does not travel to the brain, but it is converted into an impulse by the ear, which *does* travel to the brain.

"If we study the diagram in Figure A we will understand how the ear vibrates in time with the sound waves which pass by it.

"Here we have a picture of a man with his mouth open and producing one single air wave or sound wave. Before the man spoke the air density in his vicinity was even; the air molecules were undisturbed. This could be illustrated by drawing lines in front of him with equal spacing, showing an equal spacing of the air molecules. However, when he speaks and a sound wave issues from his mouth in ever-widening circles, the air molecules are displaced.

"If we could automatically stop a sound wave and make it visible so that we could examine it, it would look

something like that shown in the diagram. A human ear in the portion of the wave shown at 1, would be in a region of normal air density as shown by the curve A drawn on the diagram and therefore the ear-drum would be in a normal position, as shown, giving a normal impulse to the brain. In this position of the ear-drum we hear nothing, as the brain records only *variations* of the strength of nerve impulses.

"If the ear were in the position 2 (in relation to this stationary wave), it would be in a region of low air density or low pressure (see the curve A at this point), and the ear-drum would curve outward on account of the partial vacuum outside of the ear. This would produce a lesser nerve impulse to be transmitted to the brain.

"If the ear were in the position 3, it would be in a region of high air density or high pressure (see curve A at this point) and the ear-drum would curve inward on account of the pressure outside of the ear, and a greater nerve impulse would be transmitted to the brain. Thus 'sounds' or records of sound waves are produced in the brain which have the same frequency as the original air waves that pass the ear.

"The ear, then, changes sound waves into nerve impulses which have the same time and energy characteristics as the sound waves themselves.

"Someone may say: 'If science understands what the ear is, and how it works, why is it that it cannot devise an artificial ear that can record sound waves?'

"That is just what science has done. It has developed a device that changes sound waves into impulses in exactly the same general way as the ear does, except that the impulses are of an electrical quality and travel over wires

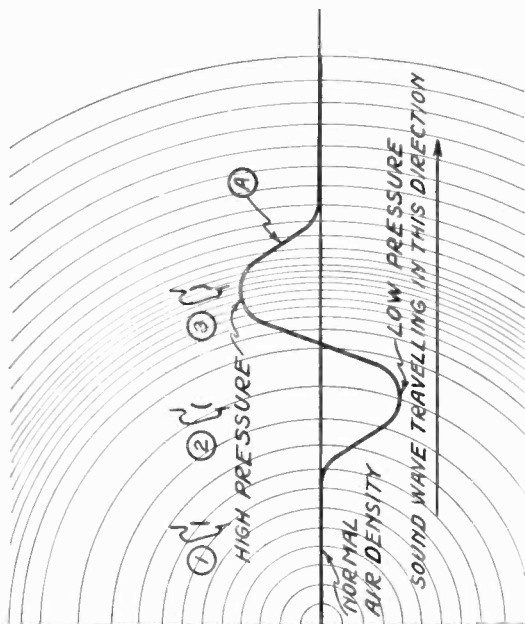
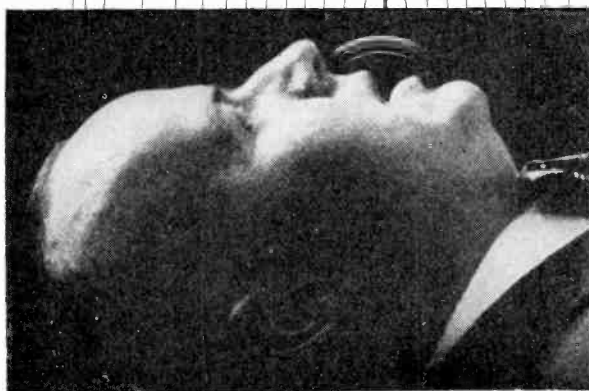

WHAT HAPPENS WHEN WE SPEAK

Figure A: A diagram that shows how sound waves spread when the vocal organs or any other source of sound is brought into play.

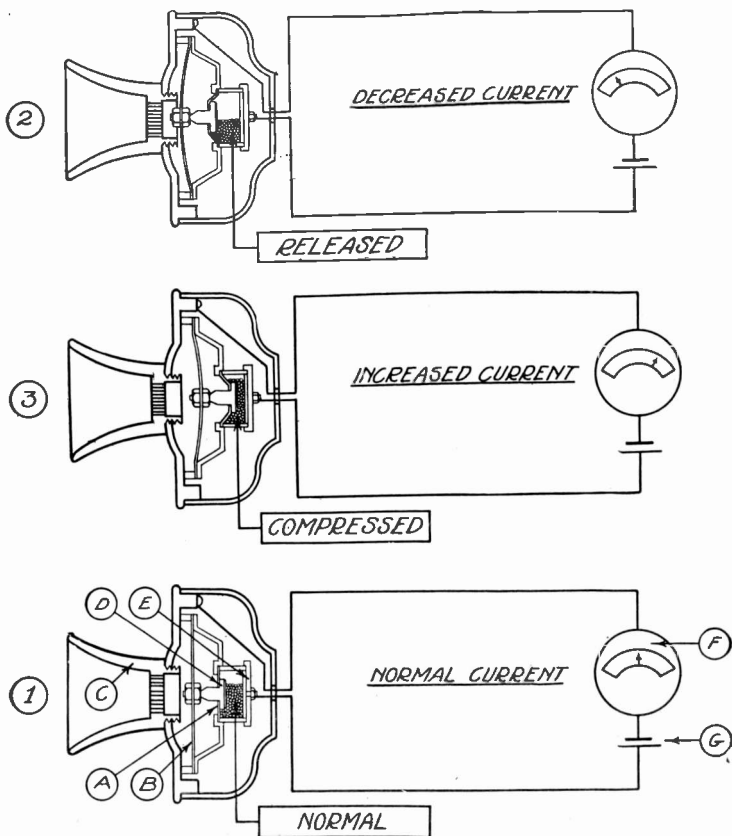

HOW THE ELECTRIC CURRENT THAT FLOWS THROUGH A MICROPHONE VARIES WITH THE SOUND WAVES IMPRESSED ON THE DIAPHRAGM

Figure B: A microphone consists of a collector horn (C) and a diaphragm (B), to which is attached a plunger contact (D); this passes through a flexible insulating disc (A), which forms one end of a cylinder (E), which contains the carbon grains—all of which are shown in (1) above. A current from a battery (G) passes through the circuit, which includes the carbon grains; this current is registered on a meter (F). When the diaphragm is vibrated, first on one side and then on the other, by sound waves [as shown in (2) and (3)], the carbon grains are released and compressed, respectively, and a smaller or greater amount of current flows through the microphone. This variation of the strength of the current that flows through the microphone is directly in proportion to the strength of the sound waves which come from the voice or the musical instrument, and which are impinged against the diaphragm.

instead of being nerve impulses which travel over organic wires called 'nerves.'

"This brings us to our last question:

"How does this instrument, the microphone, change sound waves into electric currents?

"This is really very simple, as we shall see. First of all, this artificial ear (the microphone) consists of an outer sounding board C (shown at 1, Figure B), which gathers up the sound waves and impresses them on the diaphragm B. On the back of this diaphragm, fastened to it and free to move with it, is a sort of plunger contact D. This plunger contact passes through a flexible insulator disc A, which forms one wall of a cylindrical box E, which is filled with carbon grains. The cylinder is connected in an electrical circuit in such a way that the electric current from a battery G has to pass through the carbon grains in its path around the circuit. The only way it can pass through the carbon grains is to pass from one grain to another as they make contact with one another. If they are pressed tightly together a large current will flow through them, and if they touch each other only lightly, a small current will flow through them. If, for experimental purposes, we connect a measuring meter F in series with the circuit, we will be able to read the value of current flowing. If no current flows through the meter, the pointer will be at zero at the left of the scale, and as the current increases the pointer will travel over the scale to the right, recording an increase of current in accordance with its deflection.

"Now if we place a microphone in position 1 (in Figure A), in place of the human ear, the diaphragm will be in a normal position and the pressure exerted on the carbon grains contained by the cylinder E will be normal, and therefore

a normal current will be measured by the meter F, flowing through the electrical circuit.

"The diagram in Figure C further illustrates the normal value of the current that flows through the microphone, by the straight line just above the outline of the microphone with the diaphragm in position 1.

"Now imagine the wave (Figure A) to be passing by the microphone until the microphone is in position 2. The diaphragm will now be curved outward. Referring again to Figure B, at 2, we see that when the diaphragm is curved outward it draws the plunger contact with it, and this lessens the pressure on the carbon grains. They are released and touch each other lightly and the current flowing through them is decreased. See how the current value falls off, for this condition, during the time when the diaphragm is in this position (2), Figure B.

"When the wave has advanced so that the microphone finds itself in the position 3 in Figure A, the surface of the diaphragm will be curved inward.

"Referring, once more, to the diagram (at 3) Figure B, we see that the diaphragm pushes the plunger contact into the cylinder, compressing the carbon grains tightly together so that the resistance is decreased and a large current flows through them, as indicated by the meter F. Now see how the current gains in strength during the time when the diaphragm is in this position (3) in Figure C.

"If you compare the shape of the curve of the sound wave, in Figure A, which is a measure of the air density, you will see that it corresponds exactly with the shape of the electric current wave in Figure C, which is a measure of the current density."

Now that we have an accurate idea

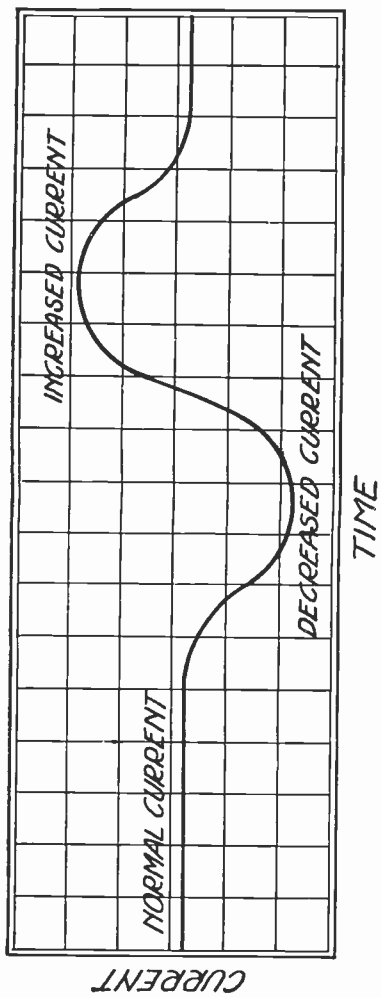

HOW DIAPHRAGMS SWING WITH SOUND WAVES

Fig. C: This diagram shows how the electric current that flows through a microphone varies with the strength of the sound waves. The currents for the three positions of the diaphragm shown in Figure B are indicated.

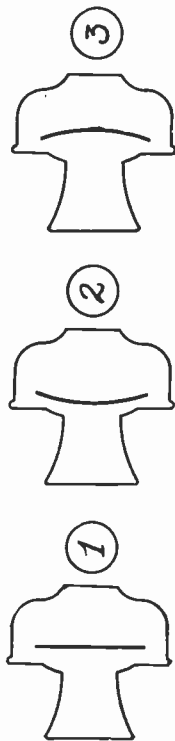

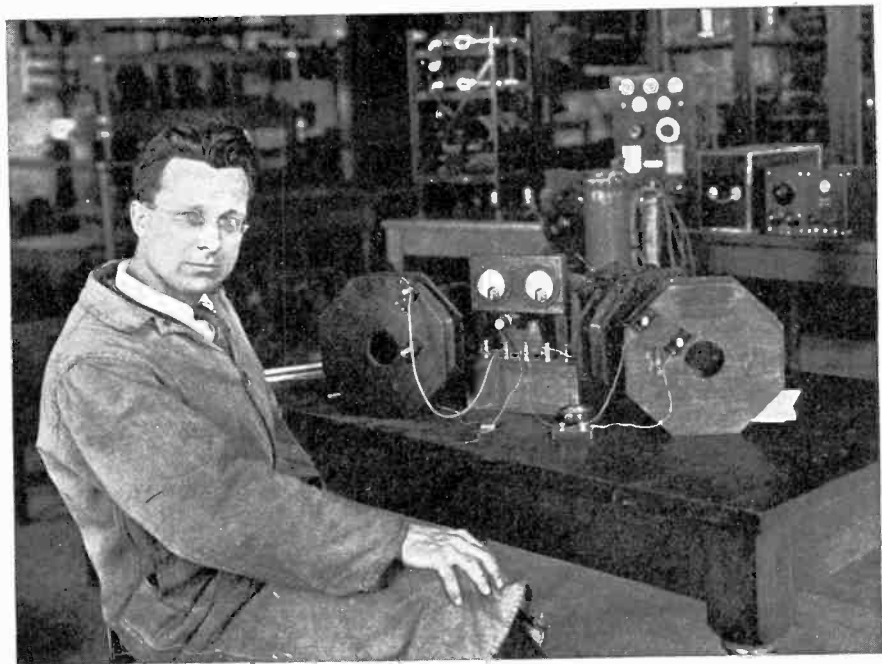

A MASTER OF ELECTRICAL THEORY

Prof. Morecroft of Columbia University who has made many valuable contributions to the literature of radio communication.

of the electro-mechanics involved in the transmission of sounds over wires by the aid of the simple telephone transmitter and receiver, let us see how the vacuum tube is arranged so that it will be able to create radio waves and impress these sounds upon them. Prof. Morecroft of Columbia University, is a master of vacuum tube operation and the following matter has been prepared by him:

“The vacuum tube is a device which, by a peculiar action, can take continuous (or direct) current power from a battery or generator and transform part of it into alternating current power. The frequency of the power generated

by the oscillating tube is determined entirely by the electrical constants of the circuit; the amount of power it is possible to generate is determined primarily by the size of the filament and plates of the tube, and secondarily by the adjustment of the circuits.

“To anyone at all familiar with the ordinary laws of the electrical circuit it will seem strange that a source of continuous power supply can, by means of such a device, be changed to an alternating current power supply. The ordinary laws of electrical circuits seem to prohibit just such an occurrence. If we have a generator that gives a continuous voltage and we connect a circuit of any kind

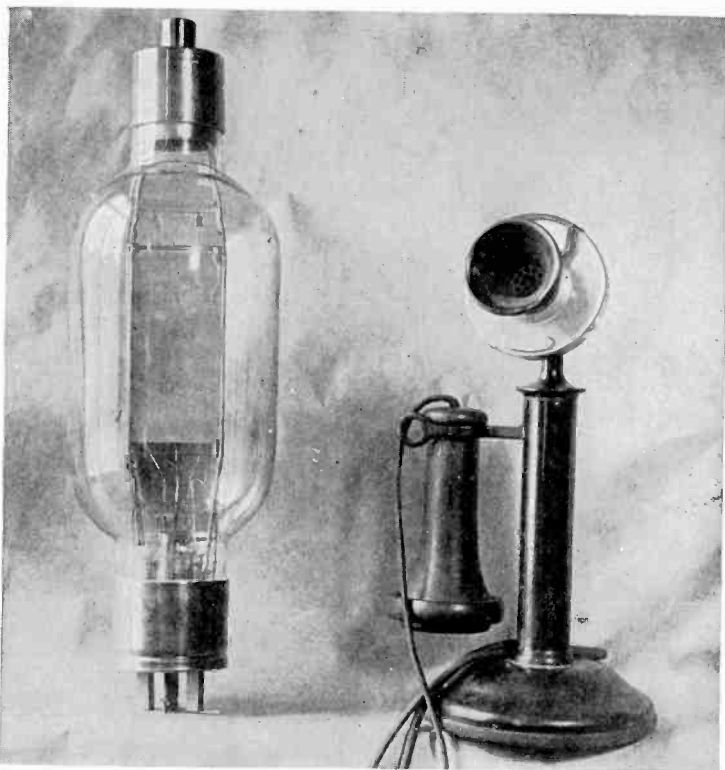

Paul Thompson

A GIANT VACUUM TUBE, AS COMPARED IN SIZE
TO A TELEPHONE INSTRUMENT

Figure D: Tubes of this size ($\frac{1}{2}$ kilowatt) are used for transmitting only. Of the various names applied to such tubes, ranging from "radio bottle" and "Aladdin's lamp" to audion, the term "triode" is coming into general use among scientists.

to the terminals of this generator we expect to get a flow of continuous current, and practically always we do so. How then is it that the vacuum tube, or triode, as it is gradually being re-named, can transform such a continuous energy flow into an alternating energy flow?

"It is first to be pointed out that there are many occurrences in our everyday life where just such phenomena are taking place, yet we scarcely notice them—occurrences in which a simple, straight-

forward push or pull makes something vibrate backwards and forwards. In fact, it seems likely than the present popular study of radio, including such things as the triode, will react to make us observe more closely many of the ordinary events that take place around us, which we do not understand and which have many points of similarity with radio. The oscillating triode certainly has a place in this category; an attempt to understand its action will

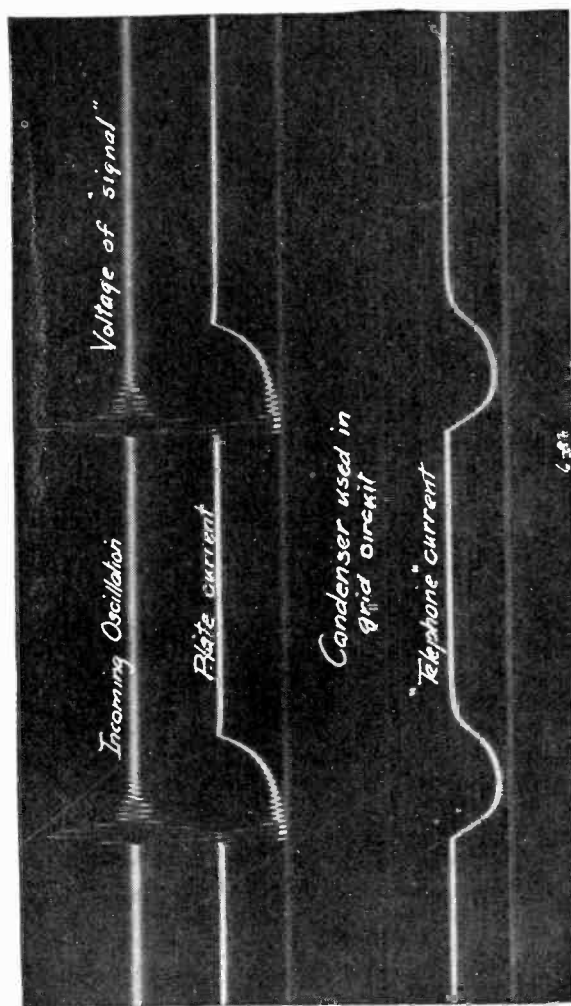

From a photograph loaned by Prof. J. H. Morecroft

A PHOTOGRAPH OF AN ELECTRICAL VIBRATION

Figure E: This picture is termed an "oscillogram." It shows in graphic form how a vacuum tube that is used with a condenser in series with the grid, detects a high frequency signal.

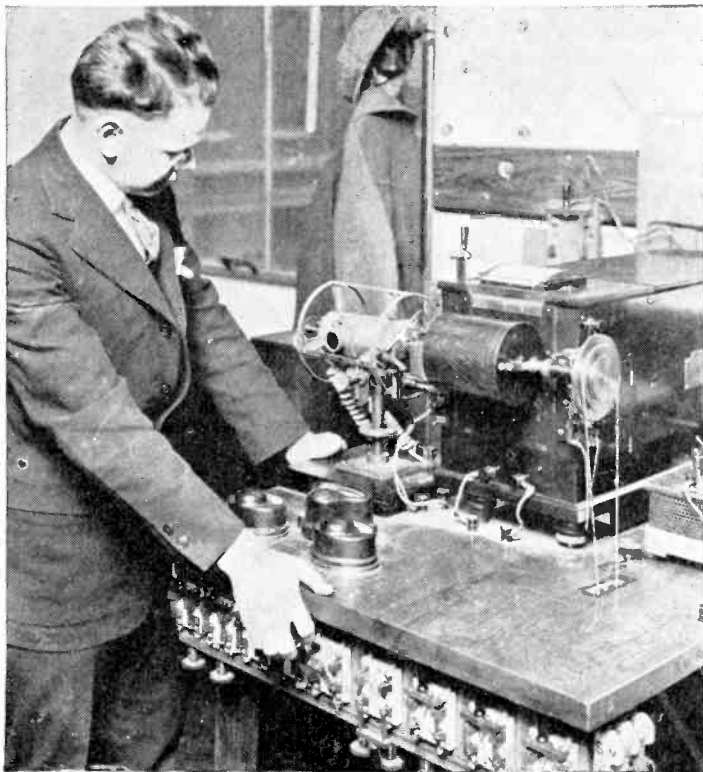

General Electric

THE OSCILLOGRAPH—A MACHINE THAT PHOTOGRAPHS ELECTRIC CURRENT

Figure F: The film end of an oscillograph box, showing the arc lamp in the spring tube at the left and control switches, vibrators, electric shutters and field magnets. The kind of picture that such a device produces is shown on page 77.

surely make us pay closer attention to many events taking place around us which we have never questioned, although we have understood them no better than we understand the triode.

“Everyone who has studied physics in high school knows that sound is a to-and-fro motion in the air, that it is a vibratory action in which energy flows past the ears at a non-uniform rate; the flow of energy goes from a maximum to

zero with a frequency depending upon the musical pitch of the note. Thus the sound from a violin string, giving the middle C, is really caused by a compression and rarefaction wave in the air which sends energy past our ears in the form of ‘pulses’ at a regular rate of 256 a second. The question should occur to anyone who hears such a sound: how can the man’s arm, which is evidently exerting a uniform pull on the violin bow,

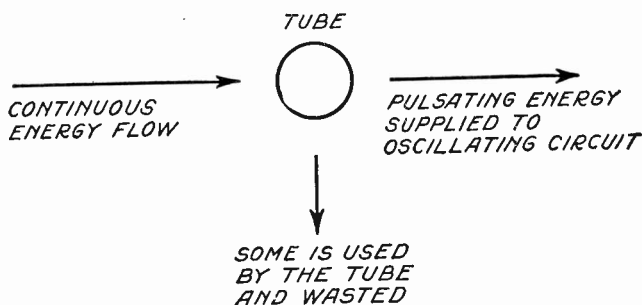

FIGURE G

The elements of an oscillating tube. This diagram illustrates in simple form the action that takes place within the oscillating vacuum tube.

send off energy at the rate of 256 pulses a second? Certainly the man's muscles are not causing that phenomenon directly.

"The answer to this question, although the phenomenon is a common one, is not simple; it can probably be accurately given by no one who reads this article. The question has probably not even occurred to any one of them, yet we frequently hear nowadays the question: 'What makes a triode oscillate?' It is a case of the unusual; the violin string is so simple that everyone thinks he knows how it works. But the vacuum tube seems much more complicated in its action. As a matter of fact it is easier to get an exact solution of the action of the triode than of the violin string.

"What makes the brakes of a train or automobile give off such a shrill squeal when they are suddenly applied? Does the driver actually vibrate the brake shoe thousands of times a second? Evidently not. What makes the balance wheel of a watch continually oscillate back and forth when the main spring is evidently trying always to push it in the

same direction? What makes the steam rush out of a whistle in pulses, giving off high-pitched musical notes when it could apparently flow through the hole through which it is escaping more easily if it came out uniformly—in which case no sound would be given off at all?

"Will a toy balloon, towed behind an automobile, proceed uniformly through the air or will it vibrate sideways, even though the towing string is exerting a uniform forward pull? Why does a flag flutter in the breeze?

"These cases could be multiplied without number; it seems in many instances that Nature would rather do things in an oscillatory fashion than in a straightforward fashion.

"We should not be surprised, therefore, in view of the actions just outlined, if the electrons in the triode, on their way from the filament over to the plate, may be made by certain circuit connections to proceed at a variable periodic rate rather than flow uniformly as the continuous current generator or battery in the plate circuit tends to make them do.

"The elements of an oscillating tube

circuit are as shown in Figure G. The plate circuit generator with its associated choke coil delivers a continuous flow of energy; this energy coming to the tube may be partly used up in the tube and partly flow on to the output circuit, which is the place where the high frequency power oscillations are started. The oscillating circuit may be made to act on the tube, so that the energy is supplied to the circuit in pulses, thus serving to keep it continually in oscillation. This action is much the same as in the escapement of a watch, which lets energy flow into the balance wheel in pulses—the pulses being so timed as to maintain the oscillatory motion of the wheel.

“The period, or frequency of oscillation of the balance wheel, is fixed by the effective mass of the wheel and the size of spring used; shortening the spring will increase the frequency and lengthening the spring will lower the frequency. This is what is accomplished by the ‘faster’ and ‘slower’ adjustment of your watch.

“As the electrical constants of the oscillating circuit determine the frequency of the alternating current that is generated, it might be presumed that any frequency could be generated at will. Such is nearly the case. With one of the ordinary tubes obtainable for small transmitters the writer has produced frequencies as low as one cycle a second by use of large inductances and condensers, whereas the same tube with the smallest inductances and condensers feasible has generated ten million cycles a second. These are not necessarily limits; it is possible for one who has large and efficient coils to go lower than one a second and by using proper care in the selection and arrangement of the apparatus the upper frequency can be pushed as high as three hundred million cycles a

second—a wide enough frequency range to suit almost everyone!

“The amount of power output of an oscillating tube is limited entirely by the amount supplied by the continuous current machine that furnishes the power to the plate circuit; only a certain fraction of this can be transformed into alternating current power. The power supplied by the continuous current machine is equal to the product of its voltage and current, hence to have a large output from a tube its plate circuit must be arranged to stand high voltage and its filament must be sufficiently large to liberate a great many electrons without operating the filament at such a high temperature that its life would be short. In the smaller tubes used for transmitting about 500 volts pressure is used in the plate circuit and a current of about 30 milliamperes is permissible, thus requiring from the plate circuit generator 15 watts of power. As an efficiency of 30 per cent is common in these tubes as generally used, the amount of alternating current power available is about 5 watts, which is the rating of the small transmitting tubes.

“For more power, larger filaments are required and the arrangement of connections in the tube must be such that high voltages may be applied between the plates and filament. Tubes are now being made for experimental purposes which permit an electron current from filament to plate of 60 amperes and which permit a voltage in the plate circuit of 15,000 volts. As the efficiency of these larger tubes can be made much higher than it is for the smaller tubes (just as is the case for any electrical machinery) we may figure on an efficiency of 80 per cent to 90 per cent, so that the output would be measured in the hundreds of kilowatts. Of course, these

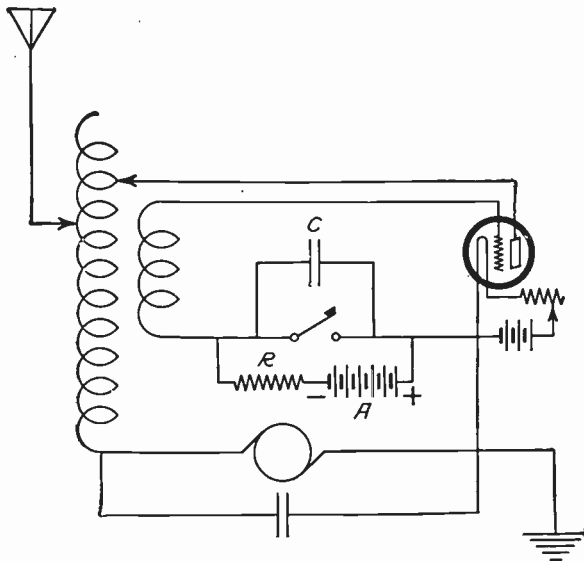

FIGURE II

A circuit that employs a small battery and a resistance to keep the grid negative while the sending key is "up." This prevents any current flow through the tube while the key is in this position.

powerful tubes cannot follow the same constructional lines as the smaller tubes; they are made of metal instead of glass, and all the parts of the tube must be arranged for cooling by circulating water through jackets properly built into the tube.

"For a given tube, well constructed and evacuated, there are two prime factors which serve to limit the safe output: the safe filament temperature and the safe plate temperature. Excess values of either will materially shorten the life of the tube.

"An oscillating power tube may be either separately excited or self-excited, the same as any continuous current generator. In case but one tube is being used it must evidently be self-excited, but if three or more are used better re-

sults will be obtained by using one of them (self-excited) to excite the grid circuits of the others. The writer has always found it possible to get more power out of three tubes by using one of them as an exciter and the other two as power amplifiers than if all of them were used to deliver power to the antenna. It is easier to control the various required adjustments for separately excited tubes than for those self-excited.

"It is especially advisable to use separately excited tubes for short wave telegraph transmission because of the greater constancy of the frequency generated; if self-excitation is used the frequency of oscillation is determined by the capacity of the antenna and any change in this capacity will affect the frequency sent out. If double frequency

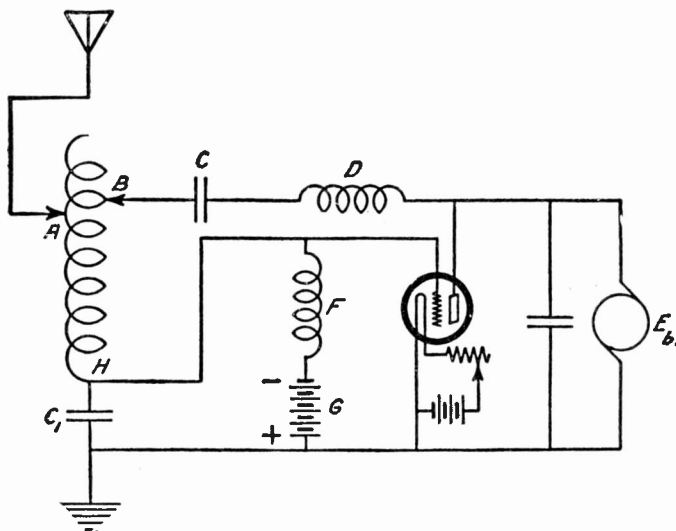

FIGURE I

An oscillating circuit that is adaptable for use by amateurs for transmitting. By insertion of the proper modulating apparatus this circuit may be used for telephony.

amplifiers (Armstrong's super-heterodyne) are used for receiving, the reception will be comparatively poor.

"The safe output of an ordinary tube is fixed by the heating of the plate. The largest tubes used by amateurs have a safe plate rating of 250 watts. If the tube is adjusted for 50 percent efficiency it is evident that the maximum safe output of the tube is 250 watts. Suppose that by a suitable adjustment the efficiency could be raised to 90 percent, what would be the safe output of the tube? Again the safe output would be fixed by the fact that there must be no more than 250 watts used on the plate, but with 90 percent efficiency, when the loss on the plates is 250 watts, the output of the tube will be 2250 watts; that is, the possible output has been increased something like ten times!

"It is easy to state the conditions

which must be obtained in a tube to get its maximum efficiency for any given filament current and plate voltage, but it is not quite so easy to furnish these conditions on an actual set. A comprehensive study of the question of triode efficiency was made by the writer, with the assistance of Mr. Trap Friis, and the results were published in the Proceedings of the A. I. E. E. for October, 1919. This seems to be the only work on record in English that shows the necessary conditions for maximum efficiency and how to obtain them.

"The grid potential and plate potential of the tube fluctuate as the tube generates alternating current power, generally following the form of a sine wave. For best conditions the plate voltage must fluctuate an amount nearly equal to the voltage of the machine in the plate circuit. For example, if a 500-

volt generator is used in the plate circuit the plate voltage should fluctuate from about 50 volts to 950 volts, the exact amount depending somewhat on the structure of the triode. The proper value of the lower limit (50 volts) is very important in determining the efficiency, but it can only be given accurately when the exact characteristics of the tube are known. The article cited above deals with this point in detail.

"The grid potential must fluctuate by an amount about equal to the fluctuation of plate voltage multiplied by the factor $W_0/2$ where W_0 is the theoretical voltage amplification factor of the tube, generally about five for the small power tubes sold for amateur use. The amount of grid bias voltage (always negative) should be so chosen that when the grid voltage has its maximum positive value it is nearly equal to the minimum plate voltage. This condition may be obtained either by the use of a C battery of small dry cells or by the use of a suitable grid condenser and grid leak. In either case a high frequency choke coil should be placed between the grid and ground (filament connection) to prevent the use of excessive power in exciting the grid.

"Not only must the proper magnitudes of grid and plate voltage fluctuations be obtained, as given above, but the relative phases of the two must be accurately adjusted. The phase of the two must be exactly 180 degrees apart, so that the maximum positive grid potential occurs simultaneously with the minimum value of plate voltage. This is an important point to observe if the maximum output of the tube is to be obtained, and is the most difficult condition to fulfill when the tube is using self-excitation.

"The fourth condition has to do with

the load circuit. In the case of separate excitation the natural frequency must be the same as the frequency of the exciter and for either separate or self-excitation, the effective resistance of the antenna circuit, between the two points where the tube supplies the alternating current power, must be equal to the alternating current resistance of the plate circuit of the tube. This is nearly equal to (but always somewhat less than) the voltage of the B machine divided by the continuous current furnished by this machine.

"It is possible, of course, to put the transmitting key directly in series with the antenna circuit if but little power is being generated, if opening the circuit at the point selected does not also interrupt the current from the B machine. It is generally better, however, to put the key in the grid circuit, thus cutting off the excitation of the tube when no signals are being sent out.

"Whenever possible the key should be so placed that when the key is 'up' no plate current flows from the B machine; in this case when no signals are being sent (all the time the key is up) the plates are being cooled off and also not so much power is used from the B generator. If this connection is properly made the safe output of the tube is nearly twice as much as if this precaution is not observed.

"Thus if a tube is rated at 12 watts safe power on the plate and the above condition is satisfied, the circuit may be adjusted so that when the key is down the power dissipated on the plates is 20 watts, and still the plates will not overheat.

"In the case of highly evacuated tungsten filament tubes this may be accomplished by leaving the grid 'free' or 'floating' when the key is up; with oxide

coated filament tubes this free grid is a dangerous condition and should never be tried. The free grid of a well evacuated tungsten tube will practically always be negative, thus cutting the plate current down to a very small value. The free grid of an oxide coated filament tube may suddenly go positive, in which case the plate current increases to a dangerous value and the tube is spoiled in a few seconds; in fact, they many times 'blow up,' breaking all the internal structure.

"For these oxide filament tubes it is best to have the key so inserted that when it is up the grid is forced to a proper negative value by a battery of small dry cells, as indicated in Figure H. With the key up the voltage of cells A forces the grid to become so negative that the plate current is brought to practically zero and when the key is down the cells are 'shorted' through the high resistance R, which is sufficiently high (say 50,000 ohms) so that the current which flows from the cells doesn't materially affect their life. A small condenser C across the switch points will eliminate whatever slight sparking might occur. Using this scheme it is possible for a small hand key to successfully control kilowatts of power in the antenna.

"When the conditions for best efficiency are obtained it often happens that the tube is sluggish in 'picking up' when the switch is closed, thus not permitting rapid sending; for this reason as well as for the others cited above, it is best to have the power tubes excited by a separate tube, which is continually left in the oscillating state.

"Of course, everyone finds his 'best' circuit by using that in which he gets most power out of his tubes. But any circuit which permits the fulfillment of

the conditions analyzed will be as efficient as any other.

"A circuit certainly as convenient as any is shown in Figure I. This is the one used most frequently by the writer. A coil H, A, B, is wound with sufficient inductance so that combined with the capacity of the antenna it will give frequencies considerably lower than any which it is desired to generate. It has about twelve taps, say every second turn is brought out for making connection to it by a clip. Condenser C_1 is a mica condenser with four or five values, the minimum being about equal to the antenna capacity; a better but more expensive set-up uses a variable condenser in this place. F and D are high frequency chokes of about one millihenry each. C is an insulating (or blocking) condenser of say 0.1 microfarad. G is the biasing battery of a few small dry cells; for the ordinary 5-watt tube 20 cells will do.

"The wavelength sent out is controlled by the position of contact A. The grid excitation is controlled by the size of condenser C_1 ; it should generally be about twice the capacity of the antenna. The position of contact B affects the wavelength slightly but its principal function is to make the effective resistance of the antenna, as measured between contact B and ground, equal to the plate circuit resistance of the tube. The amount of bias voltage in battery G affects the efficiency of the tube primarily; this, and the capacity of the condenser C_1 , should be varied together in adjusting for maximum efficiency. For small power the sending key can be placed in the antenna circuit between condenser C_1 and ground. If the maximum safe output is desired the grid should be excited through a condenser and the key arranged as shown in Figure H.

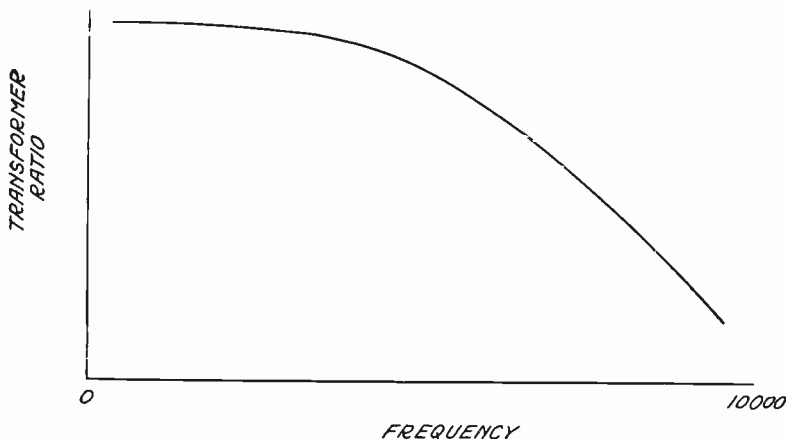

FIGURE K

Curve showing how the voltage transformation ratio, for a modulation transformer which has a great many secondary turns, decreases with an increase of frequency.

“For the single tube transmitter this circuit arrangement seems as good as any.

“When a vacuum tube is used to generate the high-frequency power sent off from the antenna by a radio telephone transmitter, the very rigid control which the grid potential exerts over the plate current offers a ready means for modulating the plate current—and the plate current controls the amount of power which the tube supplies to the antenna.

“An arrangement suitable for a small transmitter that uses one tube is shown in Figure J. When proper coupling is used between coils L_1 , L_2 , and L_3 the tube will oscillate and supply alternating current to the antenna, the frequency of which is approximately that fixed by the inductance and capacity of the antenna circuit.

“The amount of plate current which

the D.C. generator B supplies to the tube is determined by the potential of the grid of the tube, and this potential is controlled in turn by the voice currents set up by microphone M, acting on the grid through transformer A. The condenser C_1 , is advisable as it facilitates the oscillation of the tube; it must not be more than about .001 microfarad, however, otherwise distortion of the speech will result.

“In some sets there is also connected across the secondary of transformer A, (called the ‘modulation transformer’) a resistance of about one megohm; it is supposed to improve the quality of the speech. The condenser C_2 , is advisable, not only to facilitate the setting up of oscillations but also to protect the insulation of the armature of machine B, which is subjected to high-frequency dielectric losses if not shunted by this condenser.

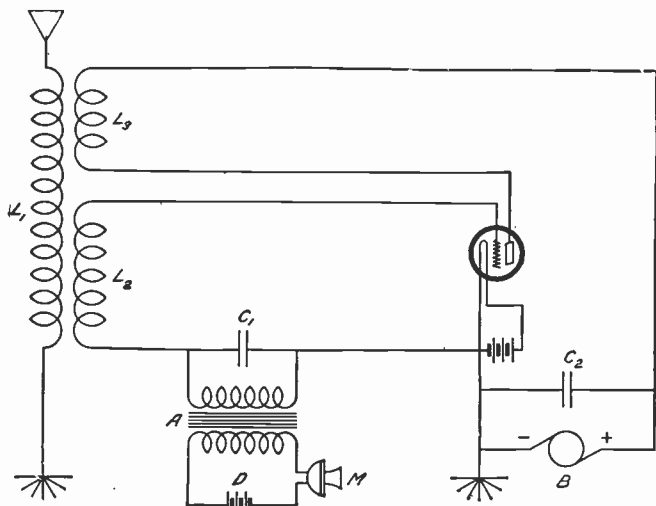

FIGURE J

The circuit diagram for a low power single-tube telephone transmitter that employs the grid method of modulation.

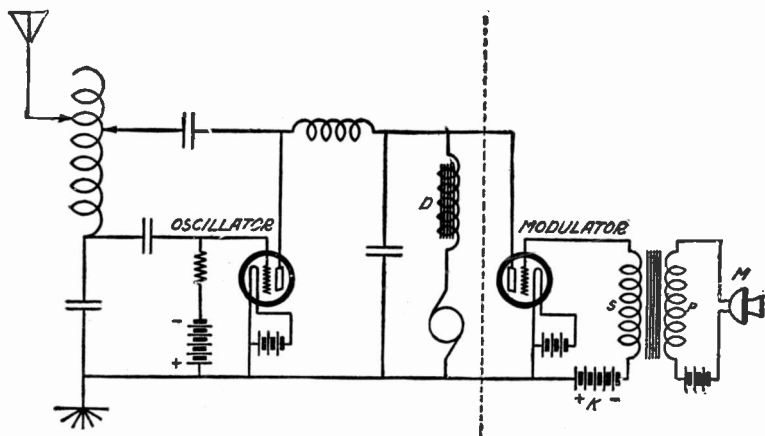

FIGURE M

This diagram shows how to wire up a set employing Heising modulation. All the apparatus shown at the left of the dotted line is in the oscillator circuit and the apparatus at the right of this line is connected in the modulation circuit. This is the scheme of modulation used at all the larger broadcasting stations.

“The modulation transformer A, must be especially designed for the microphone and tube with which it is to be used. It generally has a fairly high transformation ratio, sometimes as much as twenty-five to one.

“The primary coil, in series with the microphone, must be of low resistance, as low as that of the microphone itself

even with but little fluctuation in the primary current sufficient voltage will be induced in the secondary to properly modulate the antenna output. Such a high ratio would require a great many turns of fine wire in the secondary, however; this would be sure to bring about speech distortion as the consonants, the high-frequency waves of the voice,

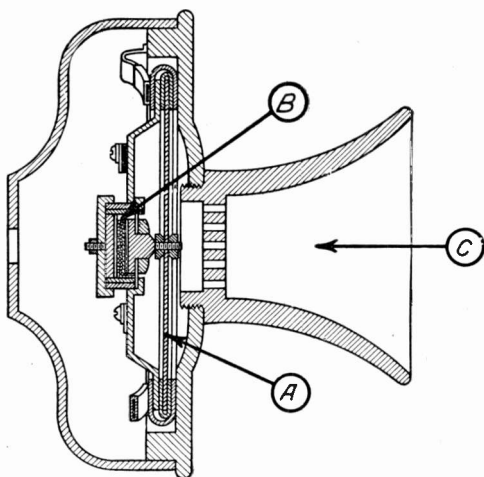

HOW SOUND WAVES ACT ON THE CARBON GRAIN MICROPHONE

Figure L: The sound waves enter the mouthpiece C, and vibrate the diaphragm A, which causes the carbon grains B, to be compressed and released, thus varying the current that flows through the microphone.

or lower; if not, the variation in microphone resistance, brought about by the voice waves, will not materially affect the current from battery D, and if this current does not fluctuate there will be no voltage induced in the secondary coil and so the tube output will not be controlled.

“It might seem advisable to wind the transformer with an extremely high ratio (say five hundred to one), so that

would not be repeated through the transformer.

“The voltage transformation ratio of a transformer is not the same for all frequencies; if the secondary has a great many turns this ratio decreases very rapidly for the higher voice frequencies.

“This effect is suggested in Figure K which gives the ratio of transformation for such a transformer; for the high voice frequencies the ratio is much less

than for the lower ones, so that the high-frequency consonants would not come through the transformer with their proper relative magnitude and the voltage affecting the grid potential would be deficient in consonant sounds. The power radiated from the antenna would thus be deficient in the high-frequency sounds of the voice and the speech received by the listener would be drummy and indistinct, no matter how good the receiving set might be.

"It is to be pointed out, however, that even if the quality of the speech sent out by the broadcast station is excellent, an improper adjustment of a regenerative receiving set will always make it seem poor. A transmitting station is frequently blamed for poor speech quality when actually the quality is spoiled right in the receiving set itself; we shall analyze this point later.

"The scheme given in Figure J, which we have just examined, called *grid modulation*, is not all that might be desired because even with the best adjustment it is impossible to obtain a high percentage of modulation (which causes wide variations in the antenna current) without getting poor quality.

"As long as we are content to change the amplitude of the antenna current by perhaps 25 percent (or in other words get 25 percent modulation) the quality of received speech is fair, but when it is pointed out that in radio telephone transmission *it is the change in amplitude of the antenna current brought about by the voice and not the actual antenna current*, which determines how far the signal will carry, it is evident that some scheme that will permit greater modulation is to be desired.

"Such a one is indicated in Figure M; in Europe it is called *plate modulation* or *choke-coil modulation*, but in the United

States it is styled the Heising scheme of modulation, because Heising was responsible for its development in this country.

"This Heising method of modulating the antenna current is almost universally used in the better class broadcasting stations of today; although it is expensive to install and maintain compared to the other schemes, the quality of speech obtained when it is properly adjusted makes it far superior to any other method so far devised.

"Many radio enthusiasts seem to object strenuously to this scheme because they have to 'waste' half their tubes; only half of them are oscillating to produce antenna power and their antenna current is much less than when they connect all their tubes in parallel to act as oscillators to supply power to the antenna, and modulate by the grid method.

"With all the tubes acting as oscillators the antenna current is about 50 percent greater than when connected for the Heising modulation scheme; hence it seems as though the Heising scheme must be inferior to the other. But we have to again emphasize the fact that such a judgment is based on a misconception as to what radio telephony really is; as stated before, the reading of the antenna ammeter is no criterion at all regarding the usefulness of a set to transmit telephone signals—it is the *variation of antenna current* produced by the voice that measures the station's efficiency and *not the antenna current itself*.

"One transmitting station that has two amperes of current in the antenna as read on the hot wire ammeter, using the Heising modulation scheme, should be able to telephone twice as far as is possible for another station that has a

much greater antenna current with a less perfect system of modulation.

"In some of the large stations used for broadcasting it has sometimes seemed advisable actually to use more tubes for modulators than were used for oscillators.

"The set shown in Figure M has only two tubes; in the average 500-watt broadcasting station two oscillators operate in parallel and either two or three tubes (of the same size as the oscillators) are connected in parallel with each other to act as modulators. The connection scheme shown in Figure M was used extensively during the war for Signal Corps sets and for the sets used on naval vessels. The circuit is divided by the dash line to indicate the two parts; all the apparatus to the left is used to make the oscillator function to furnish the high-frequency power to the antenna while that to the right is the required addition to the circuit to speech-modulate the antenna power.

"The two tubes, oscillator and modulator, both draw their plate current through the iron-core choke coil D; for the ordinary five-watt tubes this coil should have an inductance of about two henries. The grid biasing batteries and filament current of both tubes are so adjusted that the plate current of each is equal and equal to about half the total possible plate current, fixed by the amount of electron emission from the filaments.

"In Figure O (Page 91) is shown the static characteristics of the two tubes (supposedly the same for each); the grid of each tube is so adjusted in potential that the current taken by each is equal in amount to AC of Figure O, this equality of currents to be obtained when the oscillator tube is oscillating and no speech is acting on the microphone of

the modulator. This means that the grid battery K of the modulator must have the voltage OB and that the grid battery voltage of the oscillator, plus whatever resistance drop there is in the grid leak due to the grid current taken by the oscillator, is also equal to OB.

"As the amount of grid current flowing in the oscillator tube depends upon the adjustments of inductance, coupling, etc., the proper amount of grid battery for the oscillator cannot be obtained when the oscillator is not operating; an ammeter should be put in the plate circuits after the set starts to oscillate and the amount of grid battery adjusted to give equality of plate currents (the currents in the two plate circuits will not then be equal when the set ceases to oscillate). The amount of plate current in the oscillator, AC, corresponds to a certain definite amount of power in the antenna.

"If the grid of the modulator tube is now made to go up and down in potential, about the point B of Figure O, the plate current of this tube must go correspondingly up and down. As both tubes get their plate currents through coil D, however, and as this has sufficient choking action (the technician says it has sufficient *reactance*) to maintain the current through itself essentially constant, the plate current of the oscillator must go down and up by the same amount that the modulator current goes up and down. The sum of the two currents must continually be equal to twice the current AC.

"This means that if the modulator current decreases to the value AE, (Figure O), the oscillator plate current must rise to AG so that AE plus AG is equal to twice AC. As stated before, the power in the antenna depends directly upon the amount of plate current



BUILDING A SET THAT EMPLOYS THE HEISING SCHEME OF MODULATION

Figure N: In this type of set one tube is used as an oscillator and another tube (of the same power) is used as a modulator. The circuit diagram for this set is shown in Figure M, which indicates how to connect the two tubes in the correct way.

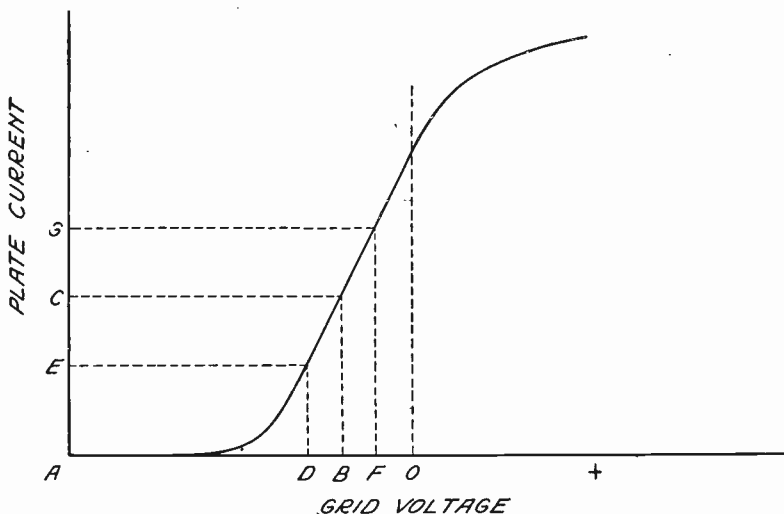

FIGURE 0

The characteristic curve for the tube. This chart is shown in order to make clear the action of the modulator and oscillator tubes as explained by the author in the text. The curve actually shows the increase of plate current caused by an increase of voltage applied to the grid circuit.

supplied to the oscillator tube so that it is evident that the microphone M, controlling, through the modulation transformer S-P, the grid potential of the modulator tube, actually controls the amount of alternating current in the antenna. Moreover, the control exercised by this connection scheme is such that the fluctuation in amplitude of the antenna current represents the voice waves actuating the microphone M, more faithfully than is the case for any other modulation scheme so far tried.

"In the large broadcasting stations the microphone does not directly control the potential of the modulator tube grids, so it is necessary to use some intermediate tubes for amplifying. Thus the microphone into which the broadcaster talks works into an ordinary resistance-coupled, two- or three-tube speech-amplifier which controls the grid poten-

tial of a five-watt tube; this tube controls the grid potential of a fifty-watt tube, which, in turn, acts directly on the grids of the modulator.

"In this manner have the skilled researchers in this branch of radio communication developed that wonderful system of control by which the microwatts, sent out by the voice, control, accurately and instantaneously, the kilo-watts of power necessary for communicating the hundreds and thousands of miles which are now easily covered by all of the best radio telephone stations."

We know that electric waves may be produced by the sparks of high-voltage transformers and by the oscillatory currents generated by vacuum tubes. It might surprise us to learn that arcs similar to those employed in street lighting are prolific producers of undamped radio waves when they are employed in

the proper circuits. Arc transmitters have proven so efficient since their introduction by Poulsen some years ago that they are used a great deal for high-power communication.

A brief reference to Figure Q will acquaint us with the general method used to connect all arc transmitters. It will be observed that a condenser is connected across the arc. It is the action of this condenser that sets up the high-frequency undamped currents. In a way, the action is similar to that occurring in a high voltage circuit of an

old fashioned spark transmitter save that continuous waves are generated.

In the following paragraphs we shall learn something of the modern application of the arc in the science of wireless communication.

The first arc transmitters designed for use on ships were cumbersome affairs, as every experienced marine radio operator knows. They occupied as much space as the first spark transmitters. The old arc chambers were designed on a generous scale, and with the auxiliary equipment just about filled the

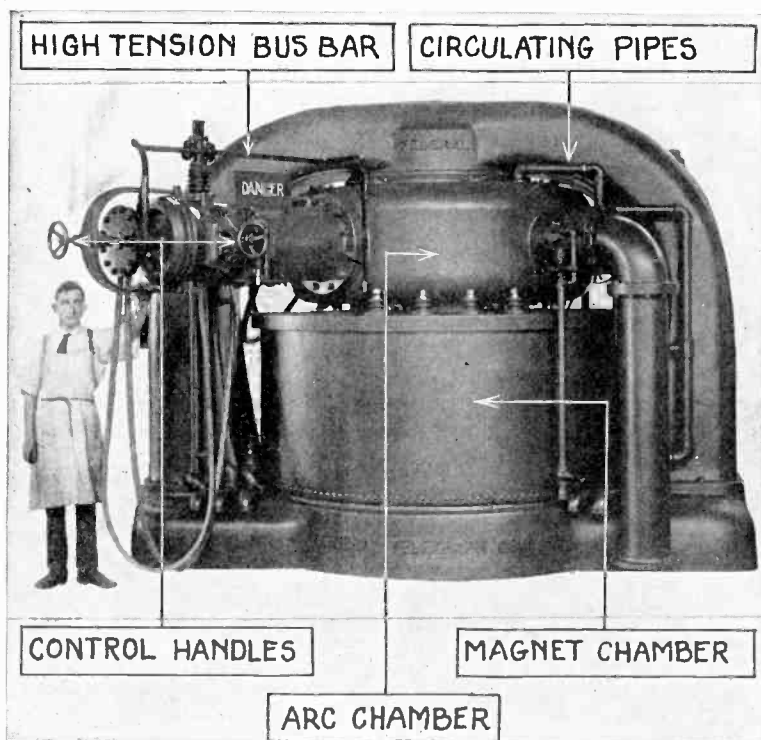

THE GRANDFATHER OF ARC TRANSMITTERS

Figure P: This huge arc converter has long been used in trans-Atlantic telegraphy. It employs 1,000 K.W. of power—ranging from 200 to 500 times as much as is used for the new type of transmitter described in this Part.

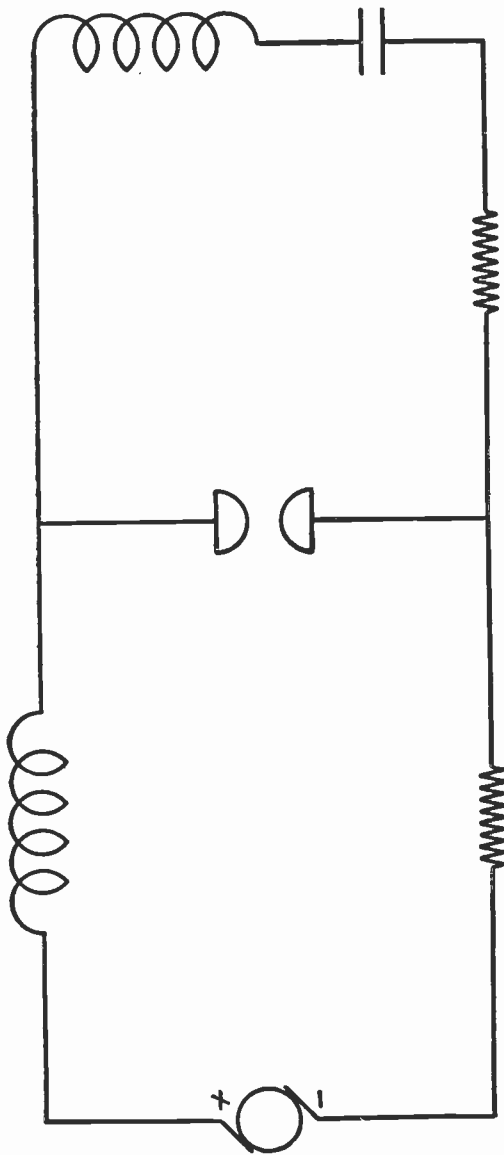

AN ARC THAT ACTS LIKE A VACUUM TUBE

Figure Q: When a condenser is placed across an electric arc in the manner illustrated, the arc immediately generates oscillations like a regenerative vacuum tube. Such a circuit properly connected to an aerial will create radio waves just as efficiently as vacuum tubes and with far greater efficiency than can be obtained with any spark or high voltage discharge method.

all too limited space of the vessel's radio cabin.

This unwieldy apparatus is now being replaced by a new and compact machine known as the panel transmitter, which can be included in a space 6 feet high on a floor space measuring only 24 by 20 inches for both the 2 K.W. and the 5 K.W. sizes.

This space may include the motor generator, but it does not provide for the water cooling tank or for the lighting switch.

As the result of practical and persistent experiment, an apparatus has been developed that is automatic in its operation; to switch from sending to receiving is but a matter of pressing a button.

The auxiliaries and motor generator are designed for a 110-volt direct current supply, the usual source aboard ship, while the radio frequency portion is designed for an average ship antenna that has a capacity of approximately .002 mfd., with an average fundamental wavelength of 440 meters and a high frequency resistance of 6 ohms at 600 meters.

Four wavelengths can be used by adjusting one switch, the transmitters generally being adjusted to 600, 1800, 2100 and 2400 meters. However, the 2 K.W. units have one high wavelength less than the 5 K.W., and provision is made for a 300-meter instead of the 2400. This is required by law.

For receiving with non-oscillating equipment, a modulating device is used which allows damped wave transmission at 300 and at 600 meters.

As shown in Figure S, the upper panel is confined as far as possible to high frequency apparatus and leads. The open section in the center carries the arc chamber, the gas pressure regulator, the modulating device, the water pump and

the carbon rotative mechanism; the two latter mechanisms are driven by the same motor. The lower control panel contains all the low tension and high tension direct current devices and leads.

Figure S shows a complete mounting of the transmitter and its auxiliaries. The ship's mains are brought to the panel through the main fused switch.

After the set is wired, and with the Send-Receive switch turned to "send," operations may proceed as follows:

1. The motor generator is brought to full speed by the automatic starter, which is of the current relay type.
2. The generator field circuit is closed.
3. The main line (generator) circuit is closed.
4. The water circulating pump and the rotating carbon device are started.
5. The potential coil of the arc striking relay operates, closing its secondary contacts; this in turn closes the circuit to the arc striking solenoid.
6. Before the cathode (carbon) is drawn in to strike the anode, the starting resistor is connected in series with the arc and with the generator.
7. As soon as the arc is struck, the hydro-carbon magnetic needle valve automatically operates and the cathode slowly draws away from the anode, the proper action being regulated by an oil dash pot. At the same time the current coil of the arc striking relay predominates over the potential coil and the secondary contacts of the relay open again, allowing the cathode to withdraw from the anode. Again the starting resistor is shorted, and the arc is allowed to draw full power.

In the 110-volt leads an overload relay is provided; when the current in the circuit is abnormal it flows through the cur-

rent coil of the relay and this draws up an armature, breaking the circuit. The armature is held by a potential coil and cannot be released without disconnecting the ship's mains from the panel.

A relay similar to the overload relay is inserted in the generator leads, but in this case an overload opens the main line

contactor (solenoid type), and this opens the positive side of the generator line.

The normal full load voltage of the 5 K.W. unit is 375 volts, variable by a generator field rheostat, and the normal full load current ranges from 12 to 15 amperes. Meters are provided with readings in generator volts and amperes;

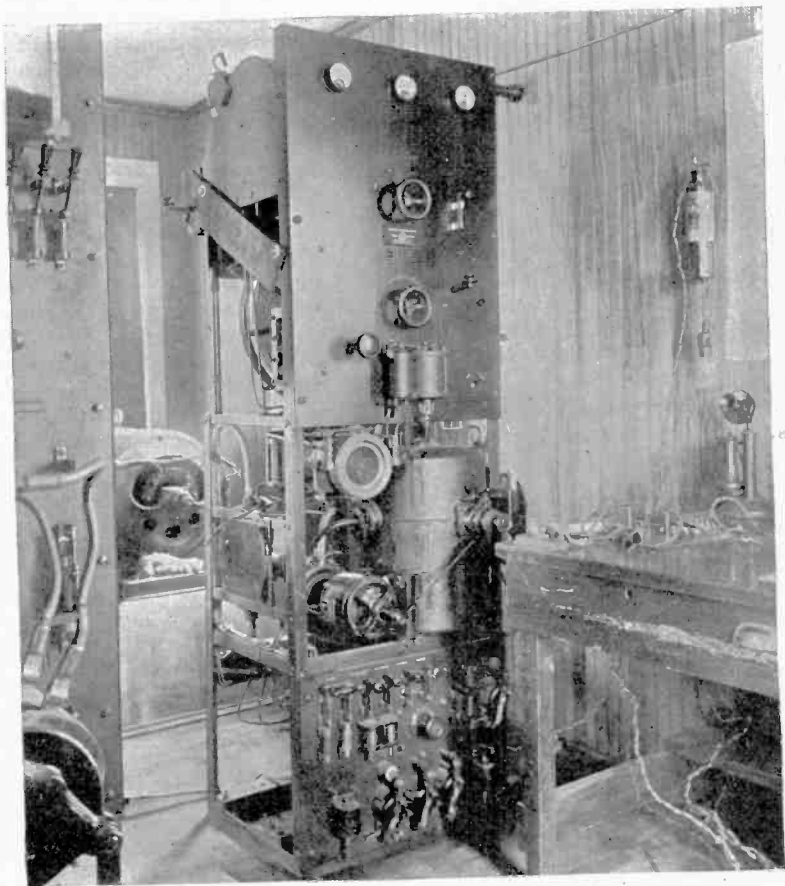

THE ORDINARY ARC TRANSMITTER INSTALLATION ON SHIPBOARD

Figure S: The apparatus in this case is a 2 K.W. arc transmitter on the U. S. S. Vulcan. The cabinet in the lower left corner contains the receiver, all the rest of the apparatus scattered about the cabin are the various parts of the arc equipment.

the product of these two readings gives the arc input in watts.

A radio frequency meter ranging from 0 to 30 amperes for the reading of antenna current is also provided. At 1800 meters a fair antenna current would be 18 amperes, assuming a 5-ohm high frequency resistance for the antenna. The antenna input would be of approximately 1620 watts, with an arc efficiency of approximately 30 percent.

The arc chamber is cast in two pieces. These are split about one-third of the way down, and in them are screwed the pole pieces. A water cooling duct of one complete turn is cast in the main chamber section.

The field coils are wound in four sections, one in the upper portion and three in the lower portion. They are wound with square cross-section asbestos-covered copper wire and are connected in series. Additional insulation in the form of empire cloth insulation is provided between coils and chamber.

Connected directly with the chamber, and at ground potential, is the cathode, its distance from the anode, or arc distance, regulated with a control handle. The cathode holder can be removed instantly from the chamber, and a new carbon may be inserted without tools.

The anode is, of course, insulated from the chamber. It consists of a solid copper tip held by a large copper tube. Within the large tube is a smaller one, also of copper. The water from the cooling system enters through the small tube, plays directly on the solid tip and returns through the large tube. Then it goes through the one-turn duct in the chamber back to the cooling tank and from there to the circulating pump. During a period of continued use, carbon will collect in the arc chamber; this may

be cleaned out when the anode is removed.

Hydro-carbon is supplied to the arc by vaporizing alcohol; when the alcohol drips on the hot electrodes it automatically vaporizes. The pressure of the gas in the chamber is kept constant automatically by a regulator that has a diaphragm similar to that in an ordinary gas meter, and poppet valves are provided to prevent dangerous explosions. It has been found that when this gas is supplied to the arc it tends to keep the oscillations stable and allows the arc to handle a greater amount of power.

Unlike the high-powered arc transmitter, this set does not emit a "compensating wave." Signalling is accomplished by switching the anode terminal from an absorbing circuit to the antenna circuit, and when the key switches the anode lead the anode must always be connected with either or both of these circuits in order to sustain the arc.

The absorbing circuit consists of a condenser, a resistor, and an iron plate resistor, the complete circuit having approximately the same characteristics as the average antenna.

The iron plate resistor is a variable unit, and it is possible to adjust the absorbing circuit so that it will draw exactly the same input as the antenna circuit. In other words, when signalling, the anode is first connected to the absorbing circuit and then to the antenna circuit; the arc input remains constant as indicated by the meters.

The transfer key is of the relay type and is remotely controlled by a single telegraph key at the operating table. An auxiliary handle protrudes through the panel so that the transfer key may be operated directly by hand in case of an emergency.

To change wavelengths with an arc

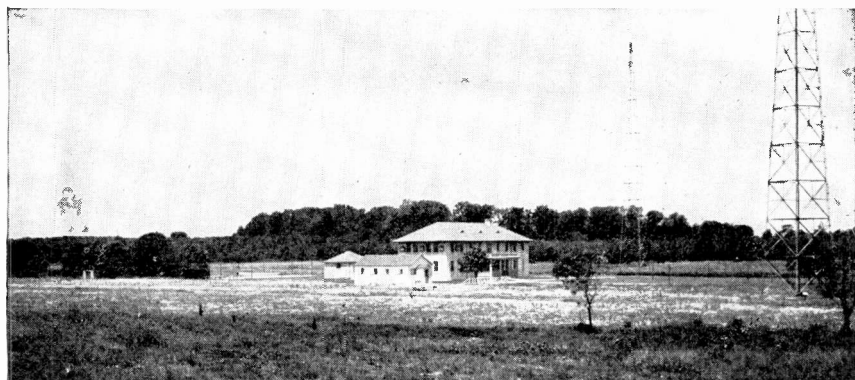

EXPERIMENTAL 'PHONE STATION

Figure U: From this radio telephone station at Deal Beach, N. J., the tests with ships at sea were conducted.

transmitter it is only necessary to vary the amount of inductance in series with the antenna, or to vary the antenna constants. In this case the desired change is reached by inserting the proper amount of inductance in series with the antenna. The main inductance consists of a large Bakelite-Dilecto tube, wound with a heavy Litzendraht wire nearly $\frac{3}{8}$ inch in diameter. The inductance is wound in sections and the sections are bank wound. Taps are taken off at every section.

It is apparent that fine wavelength adjustment is not possible when the inductance is varied by taps in every section, so a compensating inductance is provided. This consists of one flat spiral of strip copper, which can be varied by a handle on the front of the panel.

There is in the wavechange switch a total of eight positions for the four wavelengths, the extra position for each wavelength cuts in the compensating inductance for fine adjustment.

For example, if the desired wavelength is 2,400 meters, the wavechange switch is turned to the right "half" por-

tion of 2,400 meters and the wavelength is measured and found to be 2,600 meters. Another section of inductance is cut out of the main inductance, increasing the frequency and the wavelength is then found to be 2,356 meters. Next, the compensating inductance is increased and the wavemeter read, the frequency decreasing until the wavelength is increased to exactly 2,400 meters. A permanent clip is then substituted for the variable contact and that contact is used again to adjust the other wavelengths.

To produce damped oscillations a modulator system is used. This consists of a few turns of heavy Litzendraht wire in inductive relation to the main inductance. These turns are periodically short-circuited by a special commutator which has a certain number of bars connected together. When current flows through the main inductance and these turns are shorted, the wavelength is decreased approximately $7\frac{1}{2}$ percent. The speed of the commutator and the number of common bars were selected to give a 400-cycle note, while the re-

sulting decrement is just enough to provide sharp tuning and yet insure being heard when transmitting.

If the operator wishes to reduce his power when he hears land, he may insert a 10-ohm resistance in series with his antenna, or he may reduce his arc input.

The water cooling tank has a sight level glass and controlling valves, and is

usually mounted on the bulkhead with a casting provided for the purpose. Water connections are made with a special hot water hose, and in winter alcohol is mixed with the water to prevent freezing. Of course salt water can never be used as it would short-circuit the anode to the ground.

Excellent work has been done with

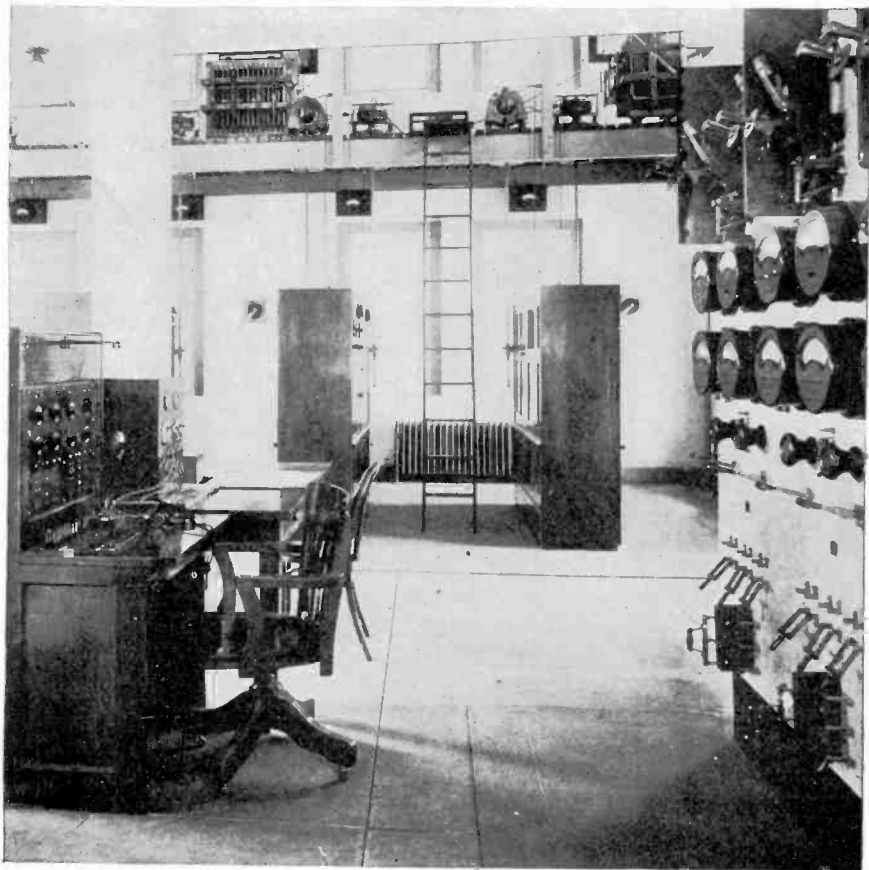

WHERE THE RADIO CALLS WERE RECEIVED

Figure V: At the desk in the foreground -at the operator in the Deal Beach Station when the two-way conversation with the "America" was carried on. The tube sets are in the background and the antennae connections are on the balcony

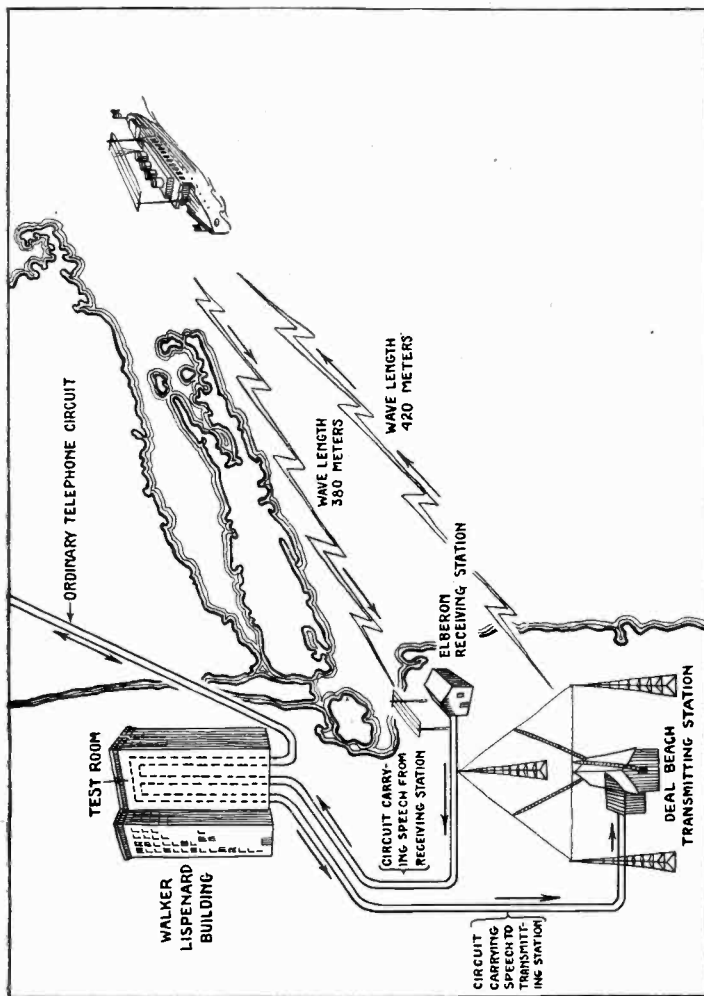

RADIO WAVES HITCHED TO WIRES

Figure W: This diagram shows how the wireless impulses from the ship were transferred to the telephone circuit and carried into a country home in Connecticut.

these new transmitters. A 5 K.W. unit installed at Babylon, N. Y., when radiating only 8 amperes at 2,100 meters was reported by a tug stationed in the harbor at Hamilton, Bermuda. The tug had a standard Navy receiver with a two-stage amplifier and reported that the signals were readable ten feet from the phones.

Another unit installed on the S. S. *Minnekahda* has worked the Cuxhaven Station at distances approximating 2,000 miles. Cuxhaven uses a quenched spark gap.

Two-way talk by radio that enables a man at sea to talk over the land telephone lines is the latest achievement of the far-speaking art. The flawless performance which was given when the commander of the incoming ocean liner *America* talked when he was 360 miles at sea with H. B. Thayer, who was in his home at New Canaan, Connecticut, is a significant forecast of a new year. Mr. Thayer, then president of the American Telephone and Telegraph Company, was naturally interested in the development of the relations between the telephony of the air and that which follows the throbbing wire. The test in which he took part on the night of March 5, 1923, is only one of a series which was begun for the purpose of bringing people in the cities in touch with their friends on ocean-going vessels.

One of these days James Wilberforce Smith, or whatever his name may be, will sit in his stateroom in mid-ocean and call up Mrs. Smith to tell her what he had for dinner. He cannot go into too intimate detail, of course, for owners of radio-phones all over the world almost have a chance to listen in. They did just this the other night when Captain Rind and Mr. Thayer were talking of

the future of telephony. Radio fans all over the eastern part of the country knew all about the feat, as the conversation was naturally broadcast.

Experts may not consider it such a remarkable feat to join wire and vibrant air, but the communication of the *America* with the shore did much to make practical a whole lot of theory. That the change can be made satisfactorily was shown by the interesting tests made with the coastwise steamship *Gloucester*, from which speech was first sent by wireless to the shore, then transmitted across the Continent to the Pacific coast, and then relayed by radio once more to Catalina Island. When the World War was over, the company, as radio fans will remember, conducted long telephone communications between Arlington and the Eiffel Tower in Paris.

Many a radio amateur, in a spirit of experiment, has invited some friend who has no receiving set to listen to something choice which he has detected in the air. Merely by placing the receiver of the radiophone over the transmitter of the ordinary telephone, he can entertain an auditor with some entertaining selections. On the lines of this unauthorized practice, and, of course, with much greater precision, the company itself connected up the wireless with its own land wires. To do this it employed its wireless stations at Elberon and at Deal Beach, N. J., and such apparatus as it required in its big operating station in the skyscrapers at No. 24 Walker Street, New York City, where a group of company officials had gathered.

Owing to many factors with which every radio amateur is familiar by experience, there are obstacles to perfect communication which must be overcome in such experiments. The waves used in sending and receiving would have

burned each other up, so to speak, had the two stations not been separated by the mile and half of sands. The voice of the captain of the *America*, as is shown in the accompanying diagram Fig. W., was carried over the sea for one hundred and twenty leagues to the Elberon station. There it was so modified that its waves were made of such frequency as to make them audible over the land lines with which it was connected. When Mr. Thayer replied to Captain Rind his words followed the metal strands to the station at Deal Beach, and were then amplified and cast out into the air, where they were duly received on board the steamer. The two stations, on the New Jersey beach, although so widely separated, were doing fine team work. The two currents—the

going and the coming current—as far as the ship was concerned, passed through the plant in Walker Street, where greater power was imparted to them, for distribution to the telephone subscribers who cared to listen to this historic interchange of greetings.

By the use of various duplex devices the captain of the *America*, who did not have a mile and a half of beach for leeway, was able to talk into the 'phone and to hear at the same time. His voice, going through the vacuum tubes, was easily spread in every direction and was caught up by the station at Elberon. Thus the two-way talk proceeded without interruption and Mr. Thayer and the captain conversed quite as easily as they might have done had they been in adjoining offices in the city. The in-

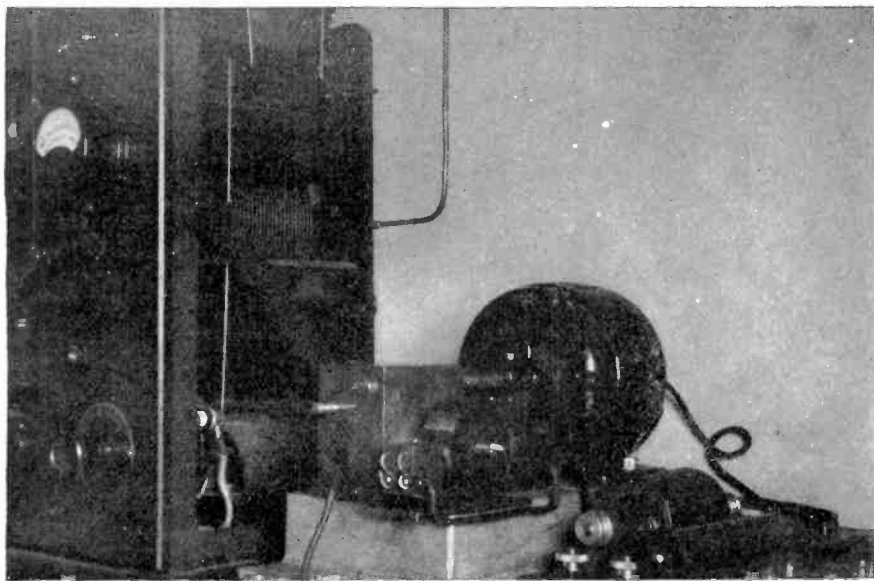

THE AUTOMATIC RADIO TRANSMITTER

Figure X: This is the type of apparatus that is installed aboard lightships and light stations. It is used for transmitting automatically in connection with the use of the radio compass.

stantaneous replies to questions and greetings was an admirable demonstration of the new method.

It is a bit early to predict just how far-reaching this innovation will prove to be. It certainly should become of great value for communications between captains of vessels and the agents or owners ashore. Instead of a long interchange of wireless telegrams, it would give the same direct and clear understanding of orders as might be obtained by those concerned had they sat facing each other across a flat top desk. The need of just such direct interchanges has often been apparent in emergencies.

While the functions of radio and wire transmissions are so radically different, yet they may be harmonized in many ways. The message which comes by wireless over many liquid leagues may in the first place be caught by the receiving sets of many alert fans. This was actually the case when the *America* was approaching. For the ordinary purpose of business, however, the network of land wires that reach all parts of the nation by telephone and telegraph are a powerful aid in the dispatching of information which is sent in throbbing from the realms of ether. The outcome of the latest liaison between wire and wireless will be followed closely by the disciples of radio.

Since we have just discussed the use of radio-telephony at sea, it may be interesting to tell of another very important use to which radio is put in making sea travel safe as well as more convenient. This device, which is also comparatively new and which has supplied a most valuable service since its introduction a few years ago, is known as the radio compass.

Blanketing banks of fog, obscuring curtains of snow and veils of pouring

rain all too frequently lower the visibility of navigational marks and beacons and arouse anxiety in the man upon the bridge when steering his vessel toward a dangerous coast.

More craft are wrecked or lost by reason of fog than through any other condition of the weather. Thousands of lives and millions of dollars' worth of property are thus sacrificed annually. Sudden temperature changes will turn the clear air above the water into an enshrouding mist, and the seafarer may find his objective shut out from view when the way ahead of him seemed plain sailing. A slight deviation from a prescribed course may make all the difference between safety and disaster.

Day or night, fog is ample reason for alarm, inasmuch as it is so easy for the navigator to make a mistake when groping onward toward his unseen haven. Lighthouses and lightships are no less essential as guides while the sun is above the horizon, and when these nautical mileposts, so to speak, are no longer visible, treacherous currents may swerve a vessel from the path of secure advance.

The radio compass is the outcome of radio phenomena which the man of science has turned to good account. Fully a decade back it was noticed that radio signals had a directive element; that is, they were heard loudest along a certain line when the receiving instruments were swung through an arc. Accordingly, during 1916 and 1917, arrangements were made by the U. S. Lighthouse Service and the Bureau of Standards for experimental tests between ship and shore stations for the purpose of devising some form of radio control. Those researches gave promising results, but the work was halted when the country entered the World War.

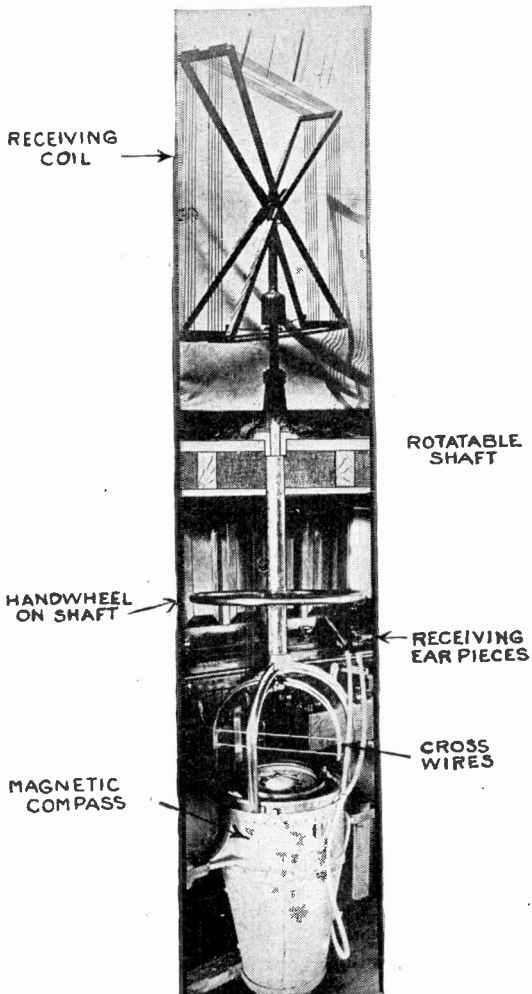

RADIO FOG COMPASS

Figure Y: A cross section through the chart house of a lighthouse tender equipped with a radio compass receiving outfit. The loop of the receiver is mounted outside on the deck of the ship while the control handle for turning it is inside the cabin.

During the period of conflict, the radio experts of the U. S. Navy evolved a type of radio compass, and they established a large number of shore stations to help such ships off the coast as were already provided with radio signalling equipment. The method consisted of an exchange of signals between the distant craft and one or more land stations, where, by radio cross-bearings, the vessel's position was determined and the information transmitted to her. To be effective, the inquiring ship had to have someone aboard who was capable of both sending and receiving radio code-signals. The system adopted by the Lighthouse Service operates differently, and the mariner himself ascertains the location of his boat; it is not needful for him to send a radio signal to do this.

As long ago as 1888, the German physicist Hertz made use of a coil for determining the source or direction of arriving radio waves, and the radio compass produced by F. A. Kolster of the Bureau of Standards is based upon a kindred sensitive or responsive element. His coil aerial is nothing more complex than ten turns of wire around a rectangular frame about four feet square. This frame is carried by a rotatable shaft. When the coil lies parallel with the path of the oncoming radio waves the signals received can be heard loudest, and when the coil is at right angles to the radio waves the signals are faintest. (This action was described in connection with loops back in Part V.) Therefore, all that the listener has to do is to swing the frame until the tell-tale dots or dashes are strongest and clearest. At that moment the pole of his coil is pointing directly at the sending station.

So far, so good, but this in itself is not enough to put the seafarer out of danger.

This is how the device works from this point:

Suppose the fog-bound ship is traveling due north and that the signals are sharpest when the coil is on an east-and-west line. How is the operator to tell whether the transmitting station is off to the right or to the left of him? This knowledge is essential to his safety; he must not steer toward the open sea when his objective is in the opposite direction. In its initial form, the Kolster radio compass was deficient in this particular, but it has been modified by the addition of what is termed a unidirectional feature. This simple attachment makes it practicable to pick up a signal's maximum intensity only when a marker is pointing right at the generating station.

Two parallel wires set one above the other and supported by a U-frame attached to the lower end of the rotatable shaft and suspended immediately above the magnetic compass, enable the man at the helm to compare the course of his vessel with the direction whence come the guiding radio signals. This information, however, while helpful, does not give him his distance from the sending station, and this he must have so that he may head his ship toward his unseen goal without fear of running upon intervening or submerged obstacles. Therefore, radio signals have to be picked up by the navigator from a *second* station, and its bearing also checked by the magnetic compass. When a line is drawn on the chart from each of the two stations, which agree with the magnetic-compass readings, the off-shore point of intersection of the two lines indicates the geographical position of the groping craft. This is made plain in the accompanying diagram, Fig. Z. It is a simple matter of triangulation-nautical surveying.

While the fundamental principle of the radio compass has been known for more than three decades, much study has been required to bring the apparatus

to its present dependability. Nearby wiring, rigging, smokestacks, ventilators and steel masts induce what is called "re-radiation." These "radio echoes" of

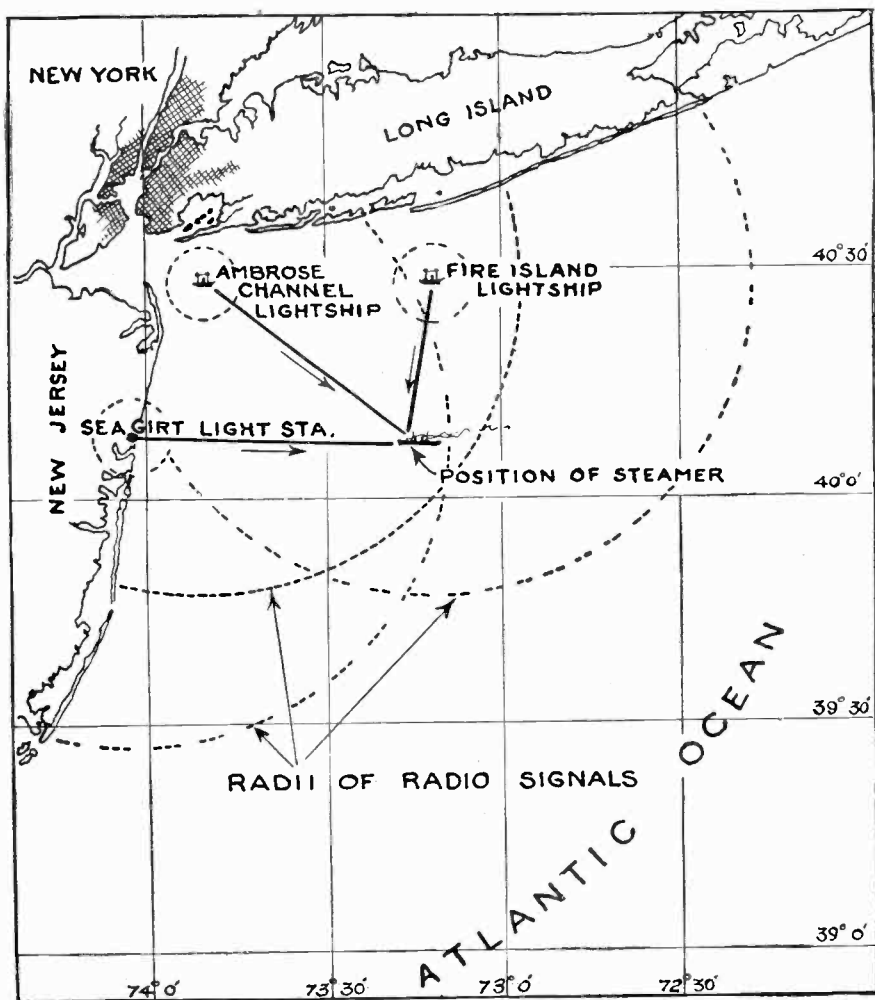

HOW RADIO SIGNALS DETERMINE A SHIP'S POSITION

Figure Z: This diagram shows the radio-compass stations at the approach to the port of New York. Each station sends out distinctive signals; by taking radio cross-bearings from two or more of the stations, a ship nearing the coast can determine her position even though the lightships and the lighthouse are invisible.

primary radio waves at first caused a good deal of confusion to the listener at the radio compass. Researches by the U. S. Bureau of Standards have shown how this source of error can be neutralized; and a radio compass can now be calibrated to offset these disturbances just as a magnetic compass can be compensated against the effects of neighboring masses of iron and steel.

The ordinary telephone receivers, if used by the operator of the direction finder, would be apt to deflect the needle of the magnetic compass if brought close to that instrument. To prevent this, a special radio receiver is located at a little distance from the magnetic compass, and the signal sounds are conveyed through rubber tubing to the ears of the man at the radio compass.

The radio transmitting apparatus built for the U. S. Lighthouse Service is designed to operate automatically; each set propagates a series or a group of distinctive signals. This is indicated on the map drawing that illustrates the three radio-sending installations adjacent to the entrance to the port of New York, at Sea Girt, New Jersey, and also aboard the Ambrose Channel and the Fire Island lightships. In addition to the characteristic signal of each generating unit the tone of each signal is sufficiently individual to prevent confusion.

A number of lighthouse tenders now carry radio compasses, and their skippers have repeatedly demonstrated the value of these aids when traversing the waters in the vicinity of New York during the prevalence of a fog. On a run of about forty-three miles, for example, the tender *Tulip* was directed entirely by radio compass. While her commander was not very familiar with the use of the instrument he was able,

nevertheless, to bring his boat within 800 feet of Fire Island Light Vessel, which was his objective. He did this with but three readings of the radio compass, and the last of these was taken when the tender was fifteen miles away from the lightship.

The advantages of the new system of guidance have been summed up thus:

1. The navigator may obtain bearings himself, and is not dependent upon others for the accuracy of the results.
2. Any number of vessels may obtain bearings simultaneously and as frequently as they desire without interfering with one another.
3. No knowledge of radio telegraphy is necessary on the part of the radio-compass operator.
4. Transmitting stations, being automatic, may be supervised by the employees of existing lighthouses or light vessels. No additional personnel is needed.
5. The direction finder aboard a craft may be used for locating at sea other vessels that are transmitting signals, and this may be a means of preventing collisions in times of thick weather.

Experience up to date warrants the belief that the radio compass will do much to rob seafaring of some of its hazards and that it will go a long way toward reducing yearly the number of catastrophes due to low-visibility. The general adoption of the radio compass would appear to be inevitable.

It is known to all of us that every radio message is broadcast with equal intensity in all directions. For some years now, scientists have been trying to devise a means of directive communication. In such a system the waves, instead of being sent out in all directions and to all points of the compass, would

be concentrated into a beam and the beam would be directed to the station with which it was desired to communicate. It is believed that such a scheme would allow greater distances to be covered with less power and that less expense would be involved in the erection and operation of long-distance radio telegraph stations.

Senator Marconi has been working diligently with this problem for the past

nine years and his efforts have yielded some very startling results. It is fortunate that Senator Marconi contributes an explanation of his marvelous system in his own words:

"Twenty years ago I got the simple letter 'S' transmitted for the first time across the ocean from England to Newfoundland without the aid of cables or conductors. Those first feeble signals which I received proved once and for all

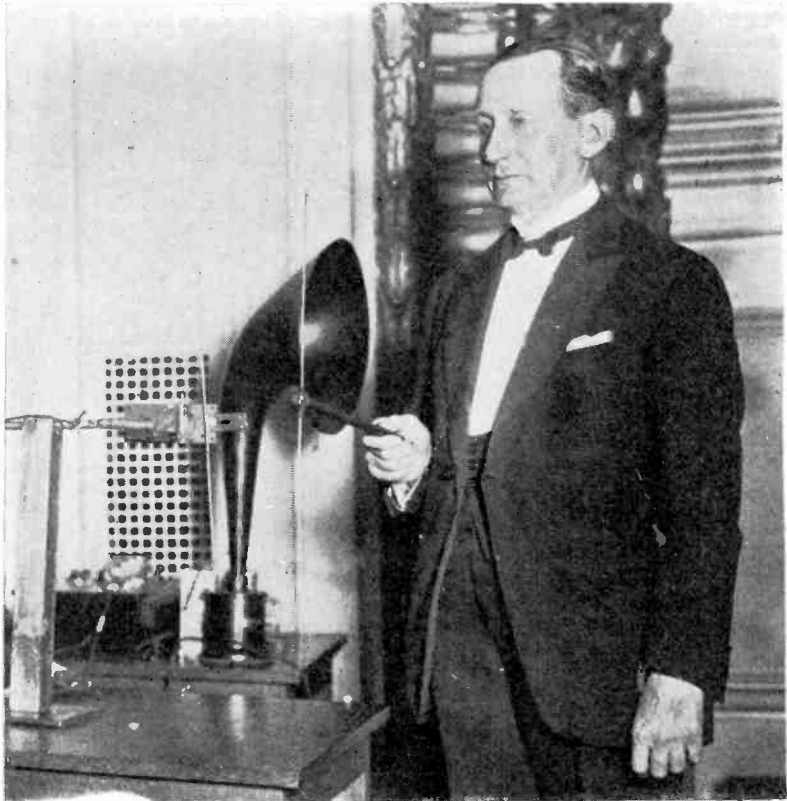

© Kadel & Herbert

THE MAGIC WAND OF THE MODERN MAGICIAN

Figure AA: With such marvelous accuracy may a beam of radio be directed by means of the "projector" which Senator Marconi is demonstrating, that it will actuate relays, one at a time, ring bells and operate receiving sets located at various points in a room as the beam is revolved.

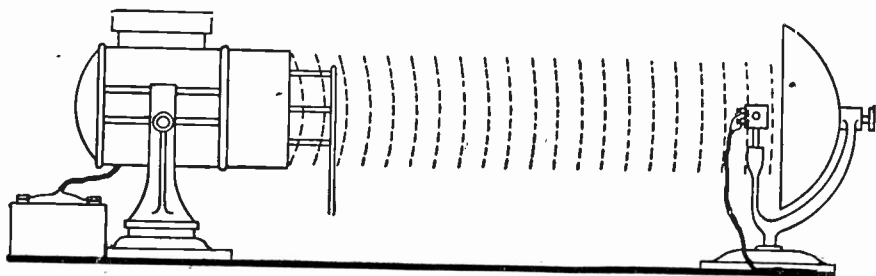

USE OF SKELETON REFLECTORS

Figure BB: Another new system for projecting a beam. Both the light and the radio beams are dependent on the same phenomena of electromagnetic wave motion. This system uses a radio beam which is invisible.

that electric waves could be transmitted and received across the ocean and that long distance radio telegraphy—about which so many doubts were then entertained—was really going to become an established fact.

“Radio has already done much for the safety of life at sea, and for commercial and military communication. From now on it is destined to bring new (and until recently even unforeseen) opportunities for recreation and instruction into the lives of millions of human beings. New designs and new uses of vacuum tubes are likely to work quite as many new wonders in the future as they have in the past.

“Great possibilities lie in the development of these tubes, especially in their connection with short wave transmission, a somewhat neglected branch of the art. Yet radio waves only a few inches long have many advantages over the waves now used, which range in length up to twelve miles. Such short waves can be more easily moulded to carry the human voice, and receiving sets tuned to them would be less disturbed by static and interference. Indeed, much of my time is now devoted to experiments with the short wave, particularly for use in the secret trans-

mission of messages. So free from interference is this short wave field that I am reminded of my earliest experiments, when the entire field was practically clear and the vast territory of radio was unexplored.

“As early as 1899 I showed how it was possible, by means of short waves and reflectors, to project the rays in a beam in one direction only, instead of allowing them to spread all around, in such a way that they could not affect any receiver which happened to be out of the angle of propagation of the beam. I also made tests in transmitting a beam of reflected waves across country over Salisbury Plain in England and pointed out the possible utility of such a system if applied to lighthouses and lightships, so as to enable vessels in foggy weather to locate dangerous points around the coasts. At that time I also showed that a reflected beam of waves could be projected across the lecture room to actuate a receiver and ring a bell only when the aperture of the sending reflector was directed toward the receiver.

“Again in 1916 I took up the investigation of the subject with the idea of utilizing very short waves combined with reflectors for certain war purposes; in this work I was assisted by Mr. C. S.

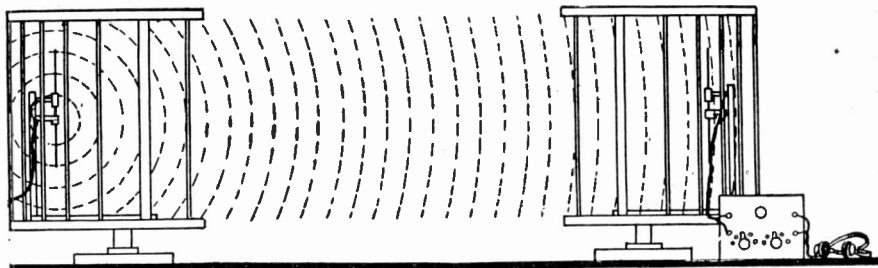

HOW BEAMS TRAVEL

Figure CC: A new system of communicating along a beam of light. A light wave is directed in a narrow path from a searchlight and picked up by a reflector which concentrates the waves on a light-sensitive cell which records the signals

Franklin. We used waves only two and three meters long. With these waves disturbances caused by static are almost non-existent; the only interference experienced came from the ignition apparatus of automobiles and motor boats. These machines apparently emit electric waves from 0 to about 40 meters in length; perhaps the day will come when they will be required to have their ignition system screened or to carry licenses for transmitting! During these experiments I observed that one of the short wave receivers acts as an excellent device for testing, even from a distance, whether or not one's ignition system is working right. Some motorists would have a shock if they realized how often their magnetos and spark plugs are working in a deplorably irregular manner.

"The transmitting reflector used to concentrate the waves into a ray or beam, in these experiments, was arranged so that it could be revolved and the effects were studied at a distance with receiving apparatus.

"Mr. Franklin has calculated the polar curve of radiation into space in the horizontal plane, which should be obtained from reflectors of various shapes, by assuming that the waves leave the

reflector as plane waves of uniform intensity, with a width equal to the aperture of the reflector. The calculated curves agree well with the observed results. Reflectors with apertures up to $3\frac{1}{2}$ meters wavelength were tested and the measured polar curves agreed with the calculated values.

"At first the range of the signals was only six miles. Later, on a 15 meter wave generated by an electron tube at the Carnarvon station, we transmitted over a distance of seventy-eight miles to one of the mail boats on the Irish coast. The important fact noticed was that there was no rapid diminution of the strength of the signals after the ship had passed the horizon line from Carnarvon. It was easily proved later that clear speech could be exchanged at all times between Hendon (London) and Birmingham, a distance of ninety-seven miles, by using reflectors at both ends.

"For these tests, the power supplied to the tubes employed was usually 700 watts. The aerial was rather longer than half a wavelength and had a radiation resistance which was exceedingly high. The efficiency of the input to the tubes to aerial power was between 50 and 60 percent and about 300 watts could be actually radiated into space.

Speech heard with this arrangement is usually strong enough to be just audible with a shunt of from $\frac{1}{4}$ to $\frac{1}{2}$ ohm across a 60 ohm telephone.

“When both reflectors are disconnected and out of use, speech is only just audible with no shunt. Average measurements indicate that the value of the energy received when both reflectors are

used and the waves concentrated in a beam, is about 200 times that of the energy received without any reflectors. It would seem that here is one possible solution to secret radio communication, the use of directed beams of magnetic waves.

“During the continuous wave tests at Carnarvon, it was found that simul-

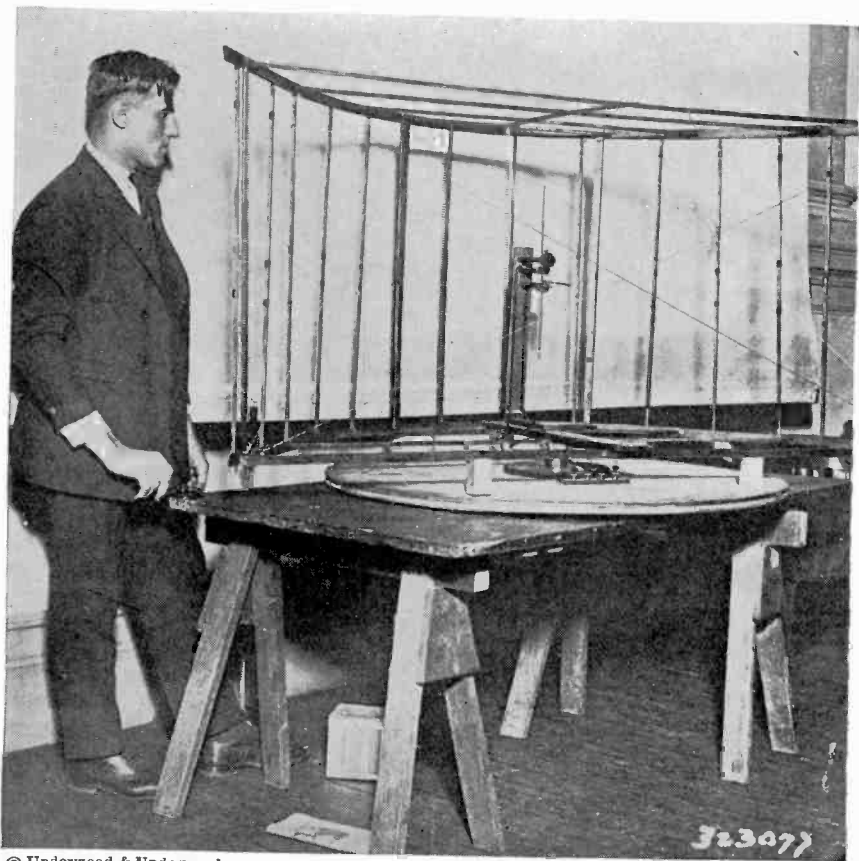

© Underwood & Underwood

A WORKING MODEL OF THE MARCONI REFLECTOR

Figure DD: This is the apparatus for concentrating the radio rays in one single beam. The small vertical object at the center of the reflector is the oscillator. The length of the waves propagated by this miniature antenna system is only about one or two meters

taneous transmission and reception was possible on the same aerial. This system is now being used successfully for duplexing, as it avoids all switching from transmitting to receiving.

"Besides giving directional working and economizing power, reflectors are showing another unexpected advantage, an advantage which is probably common to all sharply directional systems. It has been noted that practically no distortion of speech takes place, such as is often noticed with non-directional transmitters and receivers, even when using short waves.

"The results between Hendon and Birmingham easily constitute a record for radiotelephony in respect to the ratio of distance and wavelength, as Birmingham is 10,400 wavelengths from Hendon. We consider that these results represent only what could be obtained from a first attempt, and not what could now be done by utilizing the experience gained.

"A new wireless beacon has recently been developed at Inchkeith Island in the Firth of Forth, near Edinburgh. By means of a revolving directive beam of radiated energy which it produces, ships at sea can ascertain the position of the lighthouse in thick weather. With a 4 meter wave generated by a spark transmitter and a beam reflector, signals have been sent which were readily distinguishable on a ship seven miles away fitted with a single tube receiver. The reflector made a complete revolution every two minutes, and a distinct signal was sent at every half point of the compass. This enabled the ship to determine the bearing of the lighthouse accurately within a quarter point of the compass, or within 2.8 degrees.

"With the revolving beam the exact periods of maximum reception are not

easy to judge by ear, but the times of starting and vanishing are easy to determine, as the rate of rise and fall of the signals is extremely rapid.

"By means of a clockwork arrangement a distinctive letter is sent out every two points and short signs mark intermediate points and half points. This is done by contact segments arranged on the base of the revolving reflector.

"These short directional waves resembling a beam of light decrease in strength so gradually when traveling over water that the distance of the transmitting station may readily be estimated.

"Still another help to navigation may be found in the reflected beam wave. Hertz showed that electric waves can be completely reflected by sounding bodies. In some of my tests, I have noted the effects of reflection and deflection of these waves by metallic objects miles away.

"It seems to me that it should be possible to design apparatus by means of which a ship could radiate or project a divergent beam of these invisible rays in much the same manner as a searchlight, in any desired direction so that if they should meet another ship they would be reflected back to a receiver screened from the transmitter. This would reveal the presence and bearing of nearby ships in fog and heavy weather, even though such ships were not provided with radio equipment."

Now we come to the subject of "wired wireless" or the transmission of sounds over electric waves that are made to follow wires. Dr. Henry Smith-Williams has supplied a very intelligent explanation of this system in the following:

"If the textile workers of America had been able to braid silk a little faster (or, to be accurate, a good deal faster), there would probably be no such thing as 'wired wireless' known to radio science today-



From a photograph by Paul Godley

**"SECRET MESSAGES CAN BE SENT
BY RADIO"**

So states Senator Marconi, whose recent experiments with short waves (some of them only a few inches in length) that can be focused like a beam of light is opening up a line of development in radio communications that has heretofore been regarded as closed. This picture of the Senator was snapped by Paul Godley during a visit to the Marconi yacht "Elektra," which is practically a floating radio laboratory.

"Of course you do not see the connection unless you happen to know the story. The application is simple, however; Major-General George O. Squier, known to everyone as the originator of the wired wireless method, explained it personally at the outset of the paper in which he made popular announcement of his discovery. This is how it happened:

"The 'key problem' in the procurement of essential Signal Corps supplies in the United States during the World War was the production of the necessary braiding machines for finishing insulated wire. The wire itself could be obtained; rubber insulation could be obtained; and there was no dearth of cotton thread for making the braid—but machinery for braiding the thread was inadequate, and could not be rapidly supplied.

"All the braiding machines in the United States in September, 1918, could produce the braided covering for only eight hundred miles of twisted pair insulated wire a month—and the American forces alone required forty thousand miles a month! And as if this was not bad enough, the allied council decided on October 1, 1918, that it would be necessary for the United States to furnish all of this type of wire used by the allied armies in the field, beginning March 1, 1919. The estimated minimum requirement was 100,000 miles a month, or more than twelve times the capacity output of all the American machinery in existence.

"Confronted with this situation, the United States Signal Corps, with General Squier at its head, not unnaturally realized the desirability of finding a substitute for braided cotton thread.

"The Signal Corps found it. Indeed, it found something not merely 'just as good,' but in many respects vastly bet-

ter. Confronted with the shortage of braiding machines, General Squier said, in effect: 'Let us try electron tubes instead.' Asked to supply 100,000 miles of braided cotton a month, he said: 'I will give you an unlimited quantity of electromagnetic waves instead.'

"Succinctly stated, what General Squier did was to run a bare wire of phosphor bronze (number 18, such as is used for Signal Corps field antennae) across the Washington channel of the Potomac River from the Army War College to the opposite shore in Potomac Park, letting it sink to the bottom and lie there absolutely unprotected. Not only was the wire not insulated, but pains had been taken to clean it entirely and free it from any grease or other material that could in the least protect it. A standard Signal Corps radio telephone and telegraph set was directly connected to each end of the wire; one set served as transmitter and the other as receiver. At the receiving end, the bare wire was directly connected to the grid terminal of an electron tube in the receiving set and the usual ground connection was left open. Tuning the wire to a frequency of about 600,000 cycles a second, excellent telegraphy and telephony were attained.

"'This experiment,' declared General Squier, 'demonstrated the possibility of transmitting electromagnetic waves along bare wires submerged in water, and the use of an electron tube as a potentially operated device on open wire for the reception of signals.'

"That statement shows the characteristic modesty of the true scientist. For the simple experiment had really resulted in a fundamental discovery, foreshadowing the opening up of an entirely new department of radio science of almost inexhaustible possibilities.

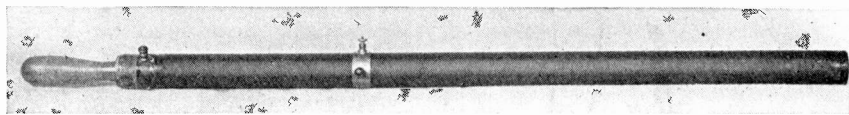

A DIVINING ROD FOR WIRELESS WAVES

Figure EE: This remarkable miniature coil antenna—a trifle larger than an ordinary walking stick—collects radio impulses when it is turned and pointed in the direction whence the impulses emanate.

"If, one of these days, you are able, sitting in your New York office, to take your telephone receiver off the hook and have a chat with a friend in London, it will be because General Squier was led (owing to the shortage of braiding machines) to find out whether he might not send a message along a bare wire under the Potomac.

"There are many interesting things to be told about General Squier's further experiments, which include successful tests of the bare wire as a carrier of messages when laid along the moist earth, and even buried under the soil; but before we come to these, let us consider the question as to how and why the electromagnetic waves follow the wire and are thus led to a definite goal, instead of radiating out into space and becoming rapidly attenuated as in ordinary radio transmission.

"This question, however, can be answered only provisionally. We have to do with an extremely puzzling phenomenon. Only a very bold or reckless theorizer would have predicted, with any measure of confidence, the results which were actually attained. Ninety-nine radio operators in a hundred would have dismissed the notion that a wireless message could be sent along a wire as absurd. The very phrasing seems self-contradictory. It is more than likely that General Squier himself was not over-confident about the success of his

experiment. But his imagination conceived the thing as possible; and presently his ears told him that the possibility had become a reality. 'Wired wireless' was an accomplished fact, whether or not a theory could be found to make it plausible.

"The discoverer himself was content for the moment to go on with his experiments, avowing no theory by way of explanation. Doubtless that was the part of wisdom. Certainly it is better not to hamper a practical discovery by harnessing it too closely with theory at the outset. Nevertheless, no one can thoughtfully consider the phenomenon without at least attempting to form a mental picture of things that are happening along the course of the strand of copper wire that is so magically holding the electromagnetic waves in leash.

"Of course it is not to be supposed that the electromagnetic waves travel in or even on the wire. By definition, these waves are undulations in the ether of space, which is supposed to be the universal medium, occupying the interstices between the electrons that are conceived as the ultimate particle of matter. According to one theory, the electron itself is only a whirl in the ether. In any event, the ether appears to ignore the very existence of matter, passing between the molecules of the most solid substance more freely than water passes through a sieve, inasmuch as there is no

friction. The electromagnetic waves with which ordinary radio deals are not altogether unaffected by material substances, but to an amazing degree they appear to ignore obstructions. As an illustration, we have just seen that the electromagnetic waves of General Squier's experiment followed the course of the wire laid along the bottom of the Potomac, apparently ignoring the presence of the water. Yet they obviously did not ignore the wire altogether—otherwise they would not have followed it.

“It was not the wire itself, in all probability, that enchained the electromagnetic waves, but the electric field about the wire. An electric field, according to accredited theory is merely the condition (of ‘strain’ or what you will) that exists in the ether surrounding an electron or group of electrons. When electrons are in transitional motion, their transit is manifested in what we term a current of electricity, and the motion of the electric field about them establishes a condition that we term magnetism. The moving electric field is parent to the electromagnetic wave; so perhaps it is not strange that an electromagnetic wave in being should have affinity for the electric field surrounding a copper wire that chances to lead out from the source of its origin.

“At first thought it seems odd that the electromagnetic wave should follow a bend in the wire; but we must reflect that the electromagnetic waves of ordinary radio do not travel in a straight line, but follow the curve of the earth's surface. Possibly the electro-static conditions of the lower atmosphere have to do with the course of ordinary radio waves somewhat as the electric field about the wire has to do with the directed waves of General Squier's experi-

ment—the earth's surface itself representing, in this view, a magnified wire-surface. The familiar fact that radio messages are rapidly dissipated in the daytime, when the upper atmosphere is believed to be charged with electrons from the sun, possibly gives support to the analogy.

“All this is mere theory, however, which the reader may find more or less satisfactory according to the bent of his mind but which can neither add to nor detract from the force of observed facts, to which we now return. The traditional apple falling from the tree on the head of Sir Isaac Newton bruised the philosopher neither more nor less because of the theory of universal gravitation.

“The experiment of sending messages along the bare wire under the Potomac having thus succeeded beyond all reasonable expectation, a question naturally rose as to whether the experimenters might have drawn a false inference from their observations. Might it not be that the portions of wire out of water at either terminal had acted as antennae, and that the electromagnetic waves had passed directly through the air, as in ordinary radio transmission, or along the surface of the water?

“To answer that question, the simple procedure was adopted of cutting off the main portion of the wire, leaving only the short aerial portion at sending and receiving stations, and a few feet under water. But now messages were no longer transmitted; and this negative result was very properly interpreted as demonstrating that the messages previously sent and received had in reality been directed along the wire.

“Sundry other confirmatory experiments having been made with a submerged wire, attention was directed to

the possibility of conveying a directed message along a wire lying on the ground. A bare No. 16 wire was laid on the surface of the earth connecting the main laboratory of the Signal Corps and a small field station one and three-quarter miles distant. The radio telephone

instruments used were standard sets utilizing an oscillating transmitter of the electron tube type. The transmitting current was about one hundred milliamperes, at any of the wavelengths available with these sets, ranging from about 200 to 550 meters. It was found

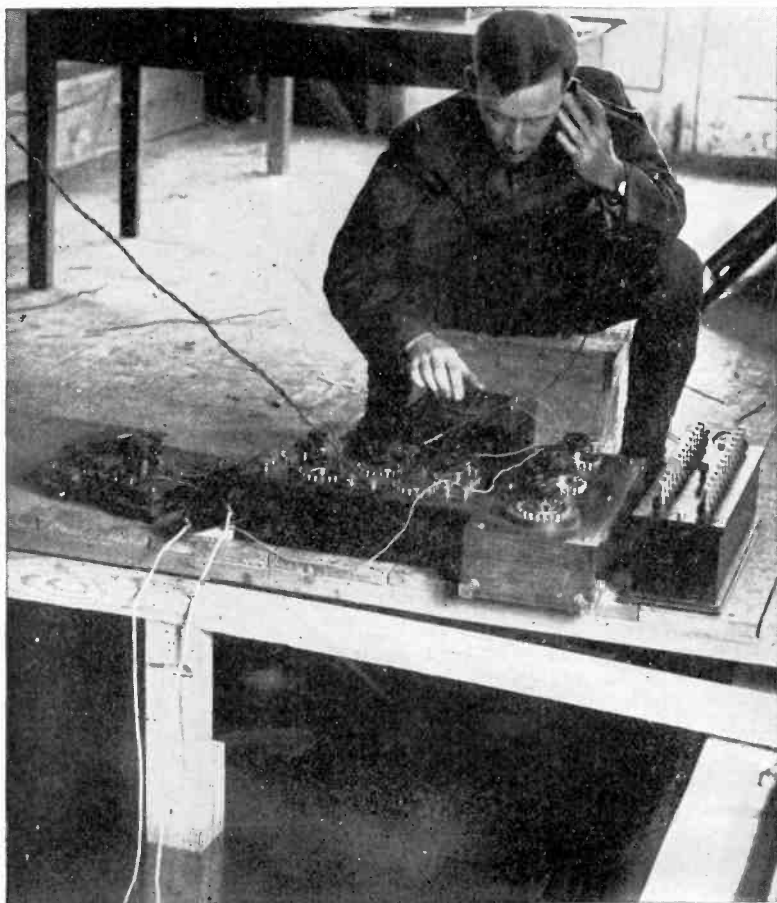

MEASURING THE HIGH FREQUENCY RESISTANCE OF WIRE UNDER WATER

Figure FF: An experimenter at work on the impedance bridge in the Signal Corps laboratory at the Bureau of Standards in Washington.

that good telephone communication could be made with this equipment.

"As the next important step in the series of experiments, the bare transmitting wire was buried in the earth to a depth of about eight inches. The bare No. 16 wire was laid in a plowed furrow and a second furrow was plowed alongside, completely covering the wire. The soil was moist, sandy loam, only a few feet above tide water.

"The wire thus buried conveyed the electromagnetic current as before, and satisfactory communication was established for the distance of about a mile.

"To make the experiment more definitive, tests were made with the buried wire not laid on a straight line, but turning at various angles. Were the

wire serving only as an ordinary antenna, it was reasoned, signals would be detected in the direction of a prolongation of a straight portion of wire; but in reality the test showed that signals could be detected best in close proximity to the wire itself in all its parts, proving that the electromagnetic waves turned the corners in order to follow the wire.

"Although the soil did not prevent the passage of the message-carrying waves, it did exercise a curious influence, screening them and in effect preventing their escape from the region of the wire. Proof of this was found by moving an exploring coil along the line of the buried wire. The detecting instrument, held just above the surface, failed to reveal a signal; but when a short length of the

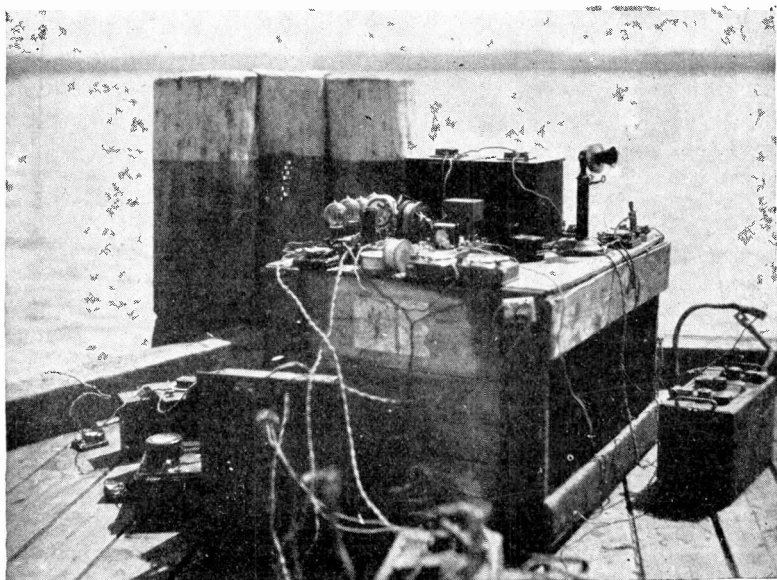

WHERE THE EARLY EXPERIMENTS WERE MADE

Figure GG: The original transmitter used in the submarine wireless experiments between Fort Hunt, Va., and Fort Washington, Md. The bare wire over which the signals were sent is shown going over the edge of the dock at the left.

wire was exposed by removing the earth, signals were at once appreciable, and these disappeared when the earth was put back over the wire.

"General Squier comments on the importance of this phenomenon from the standpoint of military usage. It is obvious that with a buried wire radio messages could be sent in secrecy, a desideratum well nigh impossible of attainment with aerial messages.

"The successful termination of the experiments above described may be said to have established the principle of 'wired wireless' beyond controversy. The importance of the discovery was so patent as to excite universal interest. Although the original tests had been made to meet war-time needs, it was clear that the new method would have abundant peace-time applications as well. The possibility of sending several messages along the same wire simultaneously at once suggested itself; and it was believed, with reason, that adaptation of the method will make feasible the transmission of messages to and from moving trains. Let it here suffice to note, however, that General Squier, whose earlier experiments in multiplex telegraphy are well known, stated in his early report that the applicability of the new method to multiplexing was self-evident. It is obvious to anyone familiar with the general principles of radio transmission that it should be possible, by using different wavelengths, to send several messages simultaneously in either direction along a single wire, each message indistinguishable except to the particular instrument tuned to receive it.

"Practical experiment was presently to demonstrate the validity of this assumption. In the meantime experiments designed to throw light on less patent features of the new method were

undertaken, particularly in the Signal Corps research laboratory at the Bureau of Standards. One object was to determine the electrical constants of bare wire submerged in water when subjected to high frequency currents.

"At the Bureau of Standards a tank was available 125 meters long, 2 meters deep, and 2 meters wide. Two wires placed in the tank served as a to-and-fro conductor, constituting a complete transmission line immersed in water. Using an electron tube oscillator as transmitter, measurements were made to determine the apparent impedance of the system with the remote end short-circuited and also open-circuited. Even at the preliminary stages, the observations as to capacity and leakage of the wire were found highly interesting.

"'It was seen,' says General Squier, 'that at low frequencies the capacity is extremely large, about 1,200 microfarads a kilometer, the equipment of an entire Atlantic cable, but the capacity diminishes very rapidly as the frequency is increased, and at a frequency of about 40,000 cycles a second, it practically vanishes. The leakage increases with the frequency up to about 5,000, and then begins to decrease slowly as the frequency is increased. The results were surprising, particularly the high capacity values at the low frequencies. The experiments apparently show that frequency of the current used has a marked influence on the behavior of water as a medium, and is entirely different from what it would be for direct or low frequency current.'

"Tests of this character, while of great theoretical importance (and that means always, potentially, of practical importance), have not the popular interest that attaches to the observations that were made by General Squier and

his associates at an early stage of the investigation with the aid of resonance wave coils of various dimensions. The use of the coil was originally resorted to in order to secure high potential points at the receiving end of the line without losing the advantage of tuning, the circuit being open, and the grid directly connected to the line. Adjustment was obtained either by moving along the coil the end of the wire connecting the grid, or by sliding along the coil a narrow metal ring connected to the grid, this constituting a capacity coupling between the grid terminal and the coil.

Coils were made up of wavelengths ranging from 250 meters to 1800 meters.

"One such coil, for example, was about four and a half inches (11.5 centimeters) in diameter and about twenty-three inches (58 centimeters) in length, with thirty-four turns of the wire per centimeter, and gave a fundamental wavelength of 1700 meters.

"This little instrument proved a veritable divining rod. Connected to an antenna or a bare wire in water or earth, as in General Squier's experiment, it can not only be used for tuning, but at the same time wave development on the

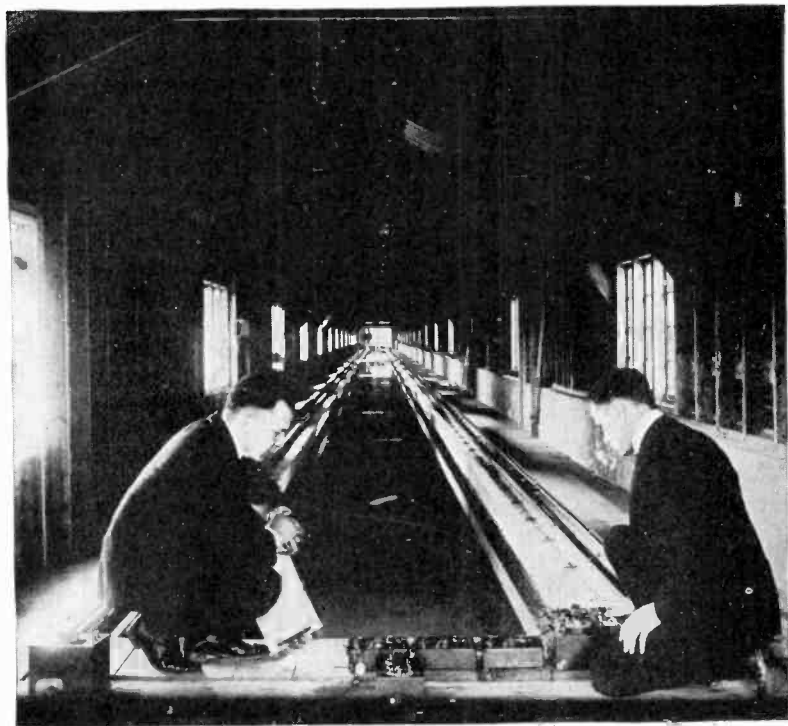

WILL THE WAR OF THE FUTURE BE FOUGHT IN SUCH LABORATORIES?

Figure HH: In this tank, 125 meters long, the radio experts of the United States government are carrying on their research work that has led to important changes in communication systems.

coil permits a test of the highest potential point, or point of greatest sensitiveness. More than that, the resonance wave-coil can be substituted for the ordinary antenna, itself constituting a complete antenna system. The coil may be grounded at one end or it may be entirely free. In either case it may be utilized to receive radio signals.

“It may be noted,” says General Squier, “that in an antenna of this kind all the electrical constants, inductions, capacity and resistance and the electromotive force induced in it by the incoming signals are of a distributive character, which makes it in a sense an ideal wave-conductor.”

“Even that does not tell the entire story of the little resonance coil. The discovery was presently made that it possesses also remarkable directive properties. If the coil is turned about, so that its position in relation to the direction of the electromagnetic waves of ordinary radio is modified, there is a constant change in the voltage and current distribution on the coil, and a corresponding shift in the position of the point of maximum potential. If the coil is held at right angles to the direction of the transmitting station from which the electromagnetic waves are coming, these waves beat evenly against it, as will be obvious, and so produce a condition of uniformly distributed electrical constants. There is a point of maximum potential, varying somewhat with the length of the coil, frequency, and terminal conditions. This maximum may be determined in moving the terminal of the grid of an electron tube along the coil. In practice a narrow metal ring that slides freely along the coil is used. But if now the coil is turned to point more or less in the direction of the transmitting station, so that

the electromagnetic waves come against it slantwise, the point of maximum potential shifts, owing to the difference in time at which the waves strike the oblique surface.

“Here, then, is a direction-finder comparable to the familiar looped antenna which can be so turned as to reveal the plane in which the electromagnetic waves are moving. But the resonance coil goes beyond this, for it was found that when it is moved about until its longitudinal axis is parallel to the direction of the electromagnetic waves (in other words, until it is pointed toward the transmitting station from which the waves emanate), the potential maximum loop, which has shifted along the shaft of the instrument, is duplicated by another loop of substantially the same amplitude at the opposite end of the coil. If now the pointing instrument is moved about a little, so that its axis is slightly out of parallel with the waves, it is observed that the potential loop at one end has greater amplitude, and that this is the end pointing toward the transmitting station—the north of the compass needle, so to speak.

“Evidently, then, manipulation of the little wire-wound divining rod (Page 114), held in the hand and tested with a sliding ring connected with the receiving grid, makes it possible to determine the direction of the transmitting station from which the signals proceed—a matter of tremendous significance as no one needs to be told. A looped antenna used, let us say, in Baltimore, does not tell whether the message comes from Philadelphia or from Washington. But the magic coil gives the answer.”

Major-General George Squier, the inventor of the “wired wireless” system of radio communication, proposes the use of this system for the purpose of supply-

ing music and entertainment to the hundreds of thousands of American homes now wired for electric service. The plan is outlined in the words of the inventor of the system:

"Broadcasting was impossible without an audience. As soon as an audience was provided, broadcasting was possible, and it began. The audience

was provided by the boy amateurs—by the youthful tinkerers who for four or five years had been playing with coils and sparks and antennæ—who had been trying, night after night, to get through a few dots and dashes to the other boy enthusiast in the next block. This amateur audience was ready and waiting for the broadcaster; its existence

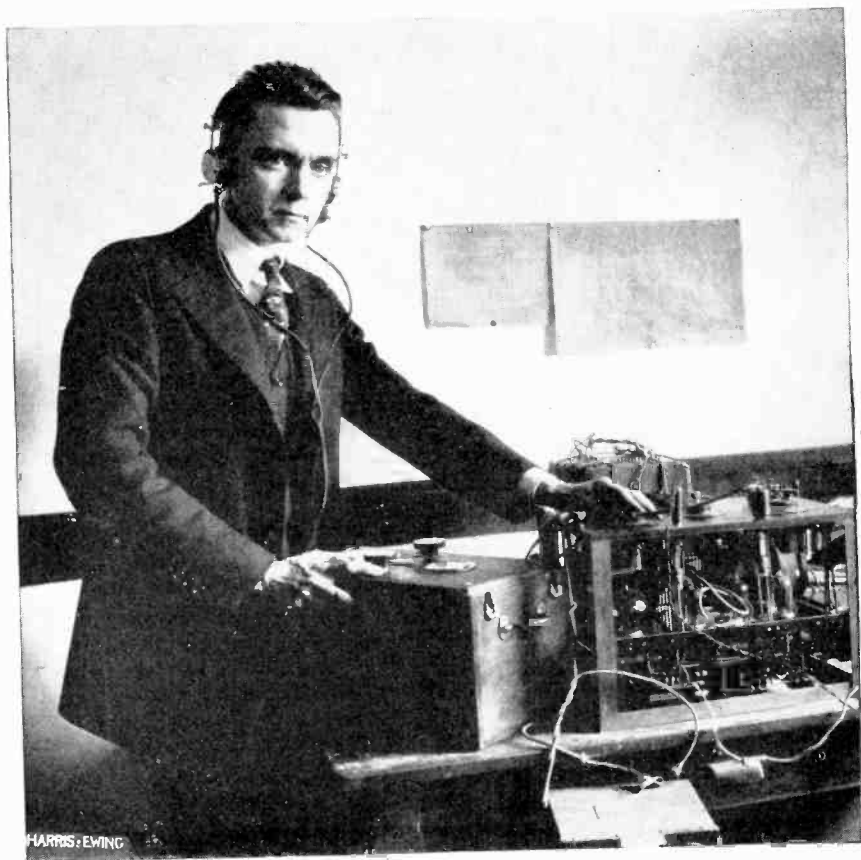

A RADIO RECEIVER THAT USES A TELEPHONE WIRE AS AN AERIAL

Figure II: The scheme for transmitting radio programs to subscribers only is brought within the realms of possibility by this super-phone, or "line radio duplex transmitter and receiver," developed by R. D. Duncan, Jr., head of the research laboratory of the Signal Corps. The device may be attached to the ordinary desk telephone.

is what made broadcasting such an instantaneous success.

"The present conditions in radio are training a larger audience. Father and mother have joined the boys around the radio set. It has been estimated that about five million people listen in every evening on the broadcast programs.

"What are we going to do with this audience?"

"Amateur radio prepared the audience for broadcasting. Broadcasting is now preparing another audience, a larger one—for what?"

"Some people seem to think that broadcasting is a fad; they believe that people will return for entertainment to the phonograph, to the motion picture and to the spoken drama. They believe, so they say, that the radiophone is a temporary craze.

"I do not think so. What happened to amateur radio? In one sense it passed, but it passed into a far bigger thing. It passed into radio broadcasting. Radio broadcasting as now conducted may pass in its turn. I imagine that it will. But it will pass into something else, into something bigger and better, something more useful to men and to society.

"The basis of a democracy is education. Unless we can properly educate our children and our immigrants, the American idea of government will fail. And no one can be educated solely in school. Far more important is the atmosphere at home; the background, good, bad or indifferent, against which the family life goes on. Is this a background of good books, good music, intelligent conversation? Or is it a background of crime news from the papers and of neighborhood gossip?"

"Think of what radio can do to help this situation. Radio can go a long way

toward supplying whatever kind of home background the country needs its citizens to have. Inspiring music, the uplifting words of great teachers, the everlasting principles of our political fathers, can be poured every day and hour into the waiting ears of all our citizens—poured in to form the minds of children, to revive the courage of the common man, to instruct and set right the newcomer from foreign lands.

"The country can *make* us listen, all of us. It will be so easy to listen that we cannot escape. We will not want to escape. Comfortably, each one of us beside his own library table, in his favorite chair, without cost or exertion or the annoyance of dressing up, there will come to our ears at the turn of a little knob the best thought and the finest artistry of all the world.

"And to our children's ears no less. To our children radio will bring the intellectual background which only the very rich have been able to provide, a background of exquisite sound. The poorest nursery can have its interior decoration of music, its aural furnishing, as now we put bright pictures on its walls. For nurseries and for all the house we can replace mere noise with controlled harmony. Already the music of the Marine Band, which all of us help to support, is not confined to Washington; it is broadcast regularly. Already any little town in Maryland or Virginia can have its radio set and its loudspeakers—can gather in the evening at the band stand for its own concert by this world-famous organization. Yet this is only a beginning of the work of the radio engineer as an educator. Soon we will be measuring culture by watts.

"And as to the more permanent social influences of such daily aural backgrounds, what might be, for instance,

the influence on business morality if fifty people heard each day the simple and persuasive eloquence of the Sermon on the Mount?

"This is exactly what radio can do. The radio engineer will be, I firmly believe, the prophet and the architect of a new social era, the inventor of the first successful system for the education of all the people.

"For this to come about we need only two things:

"*First*: we must simplify the radio receiver, and

"*Second*: we must avoid, somehow, the present confusion of broadcast messages, the overcrowding of the ether.

"Both of these improvements can be made, and can be made easily.

"The Bureau of Standards has pro-



YOU CAN "PLUG IN" THIS RECEIVING SET ON YOUR ELECTRIC LIGHT CIRCUIT

Figure JJ: That the ordinary electric light wiring can serve as aerials for "wired wireless" reception has been demonstrated by this receiving set devised by the Bureau of Standards under General Squier's direction. It is possible that the electric light corporations of the future will furnish the broadcast service—to customers only.

duced a vacuum tube equipment which works on an ordinary electric lighting circuit. This may eliminate from the radio set the present type of battery. The principle of the resonance coil, developed in the laboratories of the U. S. Signal Corps, not only accomplishes the virtual elimination of static but reduces the laborious and uncertain tuning to a single operation, to the mere sliding of a contact arm along a coil. These two advances remove the main reasons why the present-day radio set is overcomplicated and is too hard to manage and adjust. The next step is get rid of the

aerial. This can be done easily by using the electric light wire or the telephone wire.

"Every house has two avenues through which the outside world comes into it, the electric light wire and the telephone wire. Already the massed network of these wiring systems is prodigious in extent. The United States is one vast grid of wire. If some jinn could dissolve away all the brick and iron and concrete of the buildings of lower New York, leaving only the electric light wires, the form of the buildings would be as visible as before. Each

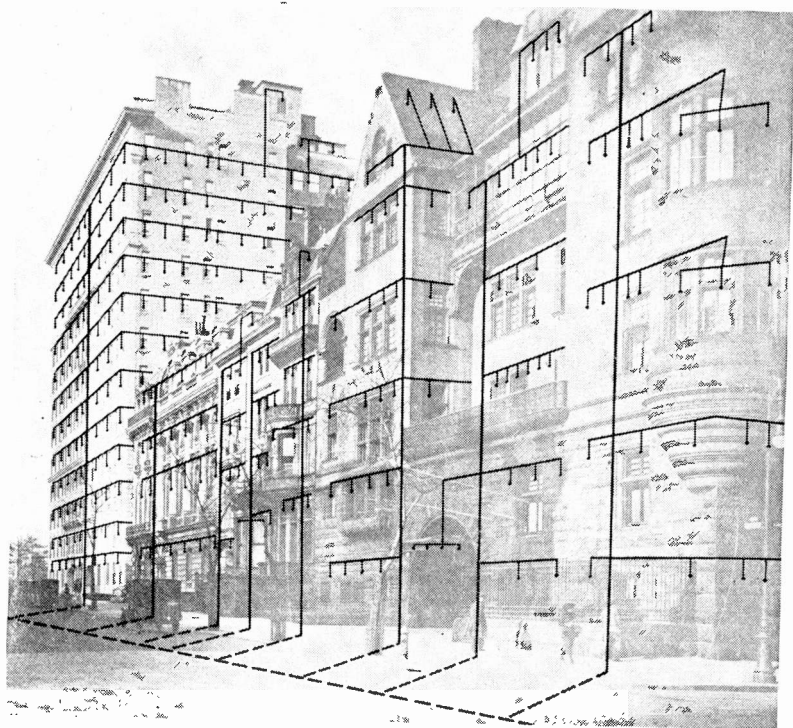

THE WIRE SKELETON OF A CITY BLOCK

Figure KK: The possibilities of bringing radio programs into buildings by way of the telephone and light circuits is illustrated by this diagram. If all the brick and iron of our city structures were dissolved away, the forms of the buildings would still be indicated by the wiring

floor, each wall, each room would be represented by a cage of intercrossing wires. The telephone wires make another system equally complete and complex, in fact, since the telephone system is continually changing its configuration as its calls are plugged in and out.

"Each of these vast networks of wire is really a cage aerial, a three-dimension antennæ system. The electric light wires and the telephone wires of New York pulsate every instant with all the potential changes due to every wireless message passing through the ether. Each Marconigram from Europe is recorded, pulse by pulse, on these two independent networks of wire.

"Both of these networks come into your house. Why not use them to get your radio signals? What is the use of spoiling your roof with troublesome and unsightly acrials, or filling up your parlor with complicated loops? The light and telephone wires are there. They have been laboriously and skillfully insulated from the ground and protected against lightning. Why do this all over again for a little private wire system of your own? Why not forget about your own private aerial and use those already available to you?

"With proper apparatus there is no danger to or from the wires, no interference with their use for light or telephone service. All the music and speech which is pulsating through the ether, all this wonderful potential background of education, comes into your house anyway through the two avenues, namely, the light wires and the telephone wires. The radio set of the future—I believe, of the very near future—will be some simple apparatus which you can plug into any light socket, or connect to any telephone. It will be something which you can buy in any drug store. It will be

something dependable and standard, which you do not have to 'set up' or 'install.'

"When we get this we can begin to count on developing an intelligent, well-meaning and broadminded public opinion.

"The difficulty of an overcrowded ether can be met with equal ease. The work of the Signal Corps on carrier current radio, or 'wired wireless,' is well known. By this system radio waves can be sent over ordinary wires. This is already in use for telephone service over power or telegraph wires and for superposing two or more telephone conversations on the same wire.

"By the use of this system anything could be broadcast over the electric light wires of a city. Items of local interest only need not be loaded on the ether for everybody to hear; the local wire systems will carry the load instead.

"For instance, department store advertising is of real interest to people who live near the store. It is not of interest to listeners a thousand miles away. It will be necessary to distinguish between local news and general news; between local civic matters and general governmental ones. The use of the local wire systems for broadcasting by radio permits one to make this distinction effective.

"Like the use of the electric light wires as acrials, this broadcasting over them will interfere in no way with their proper purpose of carrying current. Several power companies are understood to be experimenting already with the idea of furnishing their customers with broadcast entertainment just as they now furnish them with electric light.

"These, then, are the three developments in radio which I can see near at hand.

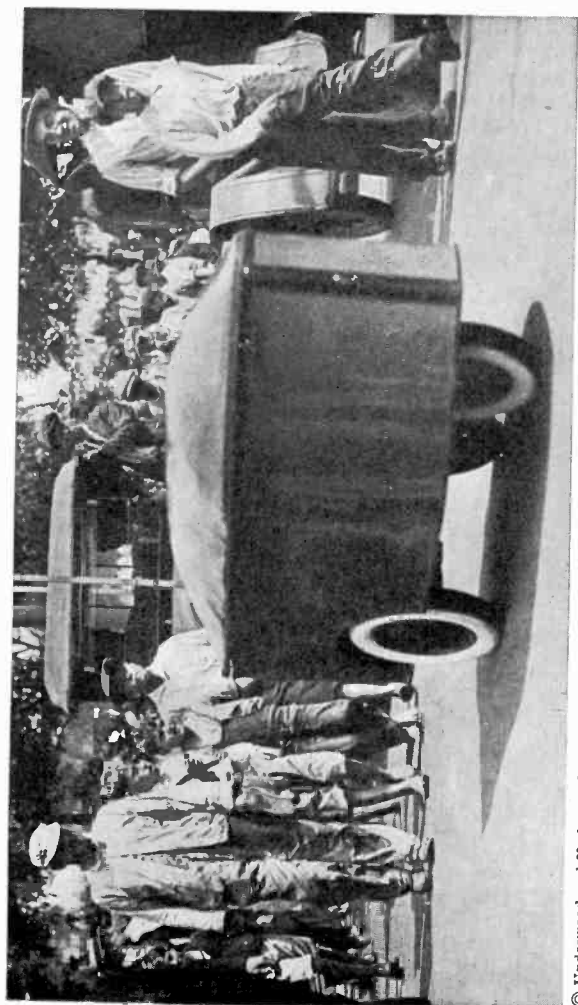

© Underwood and Underwood

A SMALL RADIO "TANK" WINDING ITS WAY THROUGH CROWDED TRAFFIC

Figure LL: A spectacular demonstration of a radio-controlled automobile—the forerunner of a radio-controlled tank—was given in the streets of Dayton, Ohio, on August 5, 1921, at an hour when the traffic was heaviest. This car was developed by Captain Raymond E. Vaughan, Chief of the Radio Branch of the Engineering Division of the Air Service, U. S. A., at McCook Field. The car was eight feet long, three feet high and two and a half feet wide. It was propelled by motor and storage batteries at a speed ranging from four to ten miles an hour, and was controlled entirely by wireless signals transmitted from an automobile that followed in its rear; Captain Vaughan states "the controls would be effective at a distance of 50 miles and could be operated from an aeroplane as well as from the ground." It was stopped, started, reversed, steered; made to blow a horn, ring a bell and fire a pistol by the pressure of buttons on an automatic transmitter that sent out various combinations of dots and dashes that caused certain controls in the car to function. The "brains" of Captain Vaughan's car is the selector—an apparatus about as large as a saucer which decodes the combinations of dots and dashes and puts the desired controls in operation within a quarter of a second. Any one of the twelve controls can be made operative in less than one second. The possibilities for operating war-machines on the same principle give these demonstrations a prophetic significance.

“First: the simplification and standardization of the receiving set.

“Second: the use of light wires and the telephone wires as aerials for everybody.

“Third: the use of local power systems for local broadcasting.

“Through these three developments there will come to every man’s home a stream of the best things of the world—a stream to be tapped and enjoyed when he wishes, to be shut off by the simple turn of a switch when he does not; a stream out of which he may select what pleases his fancy or meets his changing needs.

“Thus will the radio engineer provide a new cultural background for humanity, a new and powerful agency for the advancement of mankind.”

The control of distant mechanisms by radio waves has grown to be a very important development of the radio art and many astonishingly marvelous experiments have been made to prove the practicability of such remote operation. Here again Dr. Henry Smith-Williams has contributed a most enlightening manuscript on the subject and the reader is bound to find in it a pleasantly understandable outline of how such system functions:

“No radio apparatus exhibited recently that has attracted anything like the popular attention bestowed on Mr. E. P. Glavin’s mystifying little automobile that is controlled by wireless.

“I use the word ‘mystifying’ advisedly, even though there is no secret as to the way in which Mr. Glavin accomplishes the wonder. A wonder it remains, however, even after the fullest explanation. The greater your knowledge of radio, in fact, the more fully you will agree to that.

“You see Mr. Glavin standing at the side of the room, a solid-figured man

with gray hair and strong, thoughtful face; you are at once struck with his resemblance to that other wizard in the field of electricity, Thomas A. Edison. The little automobile (Fig. NN), somewhat boatlike in shape and with a mast that heightens the resemblance, stands in the middle of the floor. It is indeed a prosaic looking vehicle; its metal covering might give the impression that it is a model of some new type of armored ‘tank.’ At a distance, your only clue to its real character is supplied by the coil of wire that ascends as a spiral about five or six inches in diameter that winds about the mast from bottom to top, where there is a little electric signal light. On closer inspection you might see within the open body of the vehicle a series of electric batteries and sundry mechanical devices, but even that glimpse would probably make you not much the wiser, even if you are a skillful mechanic. About the only obvious feature is a central wheel, the rim of which projects into the body of the little car, to which the propelling mechanism is attached. The single front wheel, it may also be noted, serves to guide the vehicle to left or right, just as a bicycle is guided. But there is no bicycle handle or other mechanism in sight by which the wheel might be turned.

“Mr. Glavin, standing perhaps twenty feet away from the car, raises his hand. You note that the signal light at the tip of the mast flashes, but nothing more tangible happens. Another slight motion of Mr. Glavin’s hand. Now the car starts forward and begins its strange journey. It glides along at a moderate pace, like a tank leisurely charging the mass of spectators, but before it reaches them it circles to the left, and moves back toward the point from which it started.

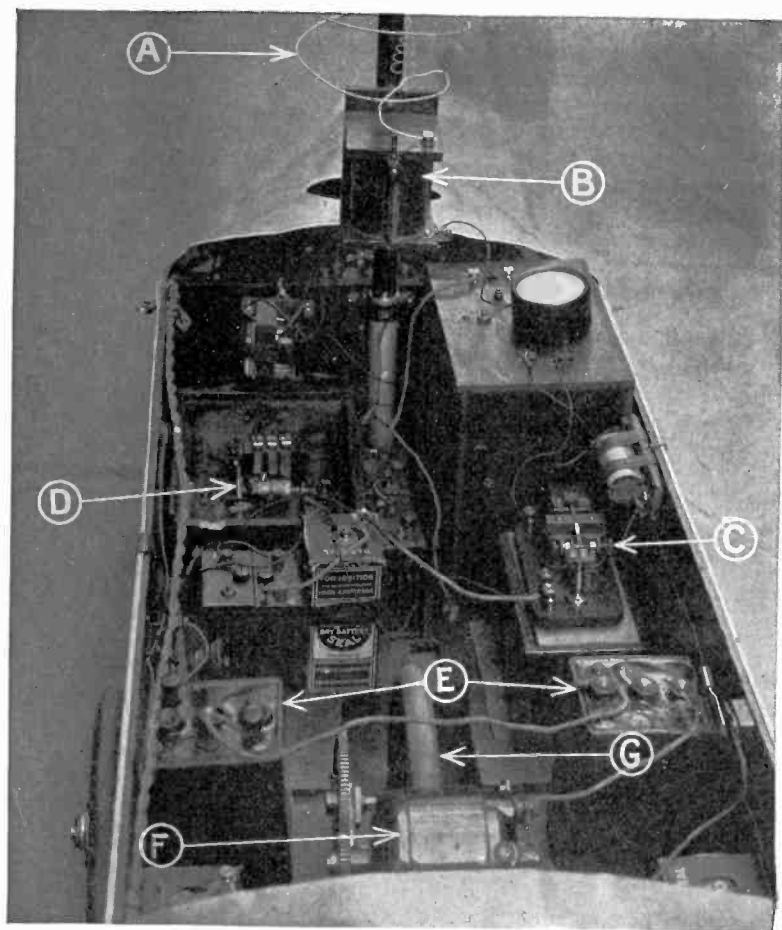

INSIDE INFORMATION ON THE CONTROLS OF THE RADIO CAR

Figure MM: The essential working parts, by means of which the vehicle is controlled, are as follows: A is the spiral antenna; B is the tuning coil; C is the sensitive relay operated by the feeble radio currents; D is the control switch which is set into action by the closing of the contacts of the relay; E are the storage batteries which furnish the electrical power to the motor F, and G is the propelling wheel.

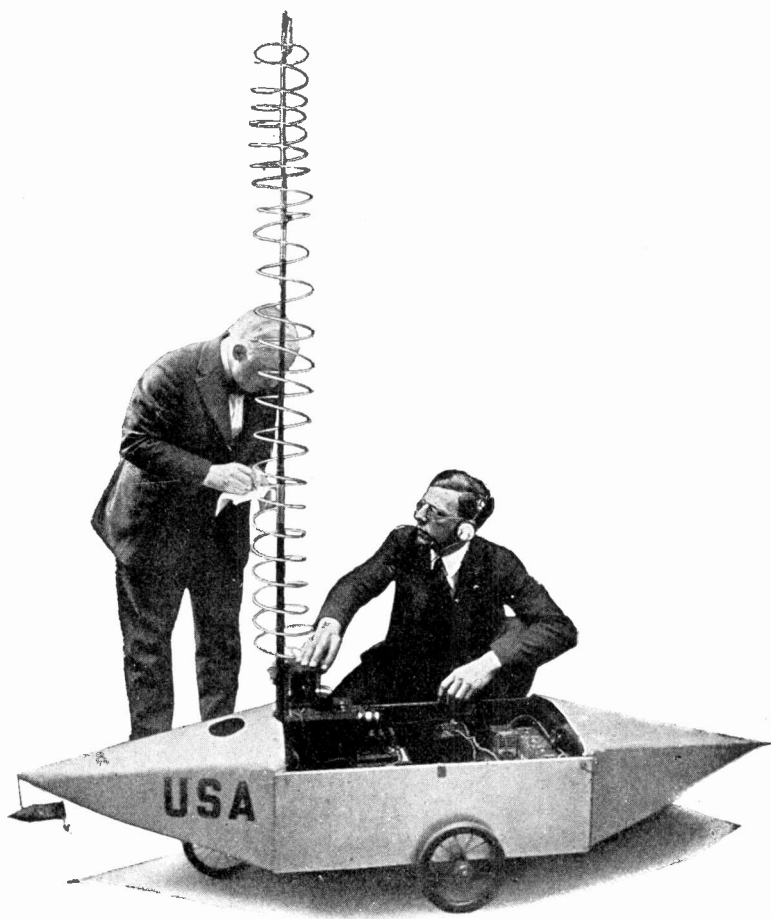

THE GLAVIN "MYSTERY MOTOR CAR"

Figure NN: The motive power is furnished by a storage battery; electromagnetic waves from the aerial throw the current in and out of circuit. How this is done is the essence of the device.

"Mr. Glavin's face is impassive, but from time to time he lifts his hand with a little movement as of salutation; each time he does so you note that the car changes its course. It circles to right as well as left; it cuts a big figure eight; with seeming intelligence it turns its prow just in time to avoid collision with the spectators.

"I chanced to be standing beside Mr. Glavin on one of the occasions when the car was making such a journey.

"'Now I will have it come around and stop right in front of us,' he remarked quietly. A wave or two of the hand and the thing was done! It was hard to avoid the feeling that this weirdly responsive little vehicle, as it circled about and came toward us and stopped respectfully four or five feet away, was manifesting actual intelligence and consciously responding to the mandate of its master.

"There was a time when an exhibition like that would have been labeled 'wizardry,' and an interpretation would have been put upon the word that would have boded ill for the exhibitor. The word 'wizardry' still applies, but it now has scientific instead of superstitious implications. The medieval interpretation would have condemned the inventor for consorting with evil spirits, the modern interpretation explains that he is juggling with electromagnetic waves in the ether.

"There is, as I have said, no mystery about the method of operating Mr. Glavin's device. Every observer is aware that the little car makes its pilgrimage under radio control. Everyone knows that when the director lifts his hand he is merely signalling to the radio operator a short distance away. The operator touches a telegraph key connected with an ordinary transmitting

apparatus that operates in connection with a short two-wire aerial. Everyone knows that the electromagnetic waves sent out from the aerial are caught up by the receiving coil that is spiraled to the mast, thus constituting a receiving antenna, and that it is the impulse thus coming to the radio apparatus stored within the body of the little car that determines its movements.

"But this knowledge does not take away the mystery. To see that little vehicle, under no man's hand, start and move about in an intelligently directed path, stop, and start again and finally make its way to the stall that is its temporary home, and stop there—quite as a horse makes its way to its own stable—is to witness a scientific miracle that yields place to few others in genuine mystery. The builder of radio apparatus can tell how the thing is done in mechanical terms. The mathematician can calculate the energy involved. But no man can give what could properly be called a full explanation of the mystery.

"It is possible, of course, to go a little more into detail as to the precise steps of the series of processes by which a wave of the hand appears to be translated into the propulsion of a vehicle—not only appears to be, but really is so translated, if we accept words in their proper meaning.

"But what takes place within the mechanism of the vehicle when the wireless impulse is received from the transmitting aerial?

"At the outset it must be understood that the radio waves which determine the activities of the little car do not supply the energy of propulsion. By no possibility could they do that. The electromagnetic waves that come from the aerial could no more turn the driving wheel and propel the vehicle than could

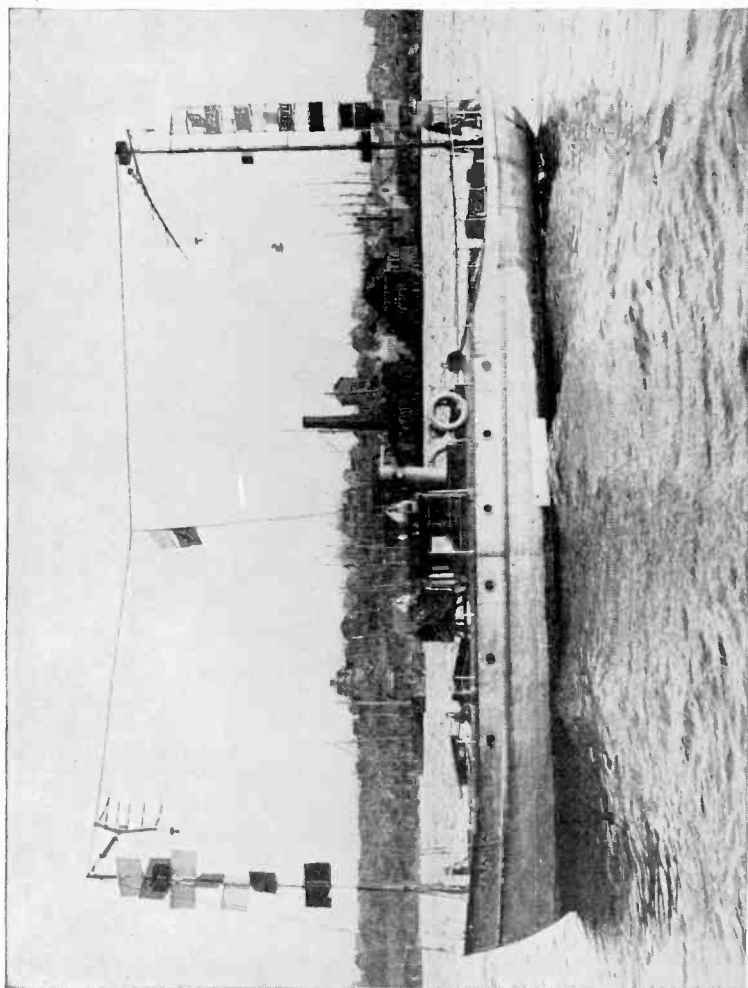

International

A FORERUNNER OF A RADIO-CONTROLLED NAVY

Figure 00: Several years ago the youthful "wizard" of Gloucester, Mass., John Hays Hammond, Jr., attracted world-wide attention by demonstrating how a yacht could be directed by radio impulses sent over a distance of several miles. These experiments were followed by the development of radio-controlled torpedoes.

the same feat be accomplished by those other electromagnetic waves termed rays of light which pass from Mr. Glavin's hand to the eye of the operator of the radio-telegraphic key. The radio waves convey more energy than the light waves, to be sure; but in no conceivable way could they convey enough energy to propel a vehicle weighing eight pounds, let alone eight hundred.

"Most of the observers are well aware of that. They understand that the actual propulsion of the wireless car is effected by a storage battery which is a part of the internal mechanism of the car itself. A little dynamo that differs in no essential from the dynamos that propel other electrically-driven vehicles—from automobiles to trolley cars—metamorphoses the energy of the storage battery to energy of molar motion—and turns the wheel. The electromagnetic waves from the aerial serve only the function of the motorman on the trolley car, they throw the electric current in or out of circuit.

"It is the way in which this is accomplished, however, that constitutes the essence of Mr. Glavin's invention.

"This statement does not do full justice to the problem. It is necessary not merely to throw on and shut off current, enabling the car to start and stop (which is all that the motorman on the trolley is called upon to do), but it is necessary also to provide for the lateral guidance of the car, a duty of which the motorman is relieved by the railway irons. The feat of Mr. Glavin's radio-automaton might better be likened to the task of the automobile driver who not only starts and stops his car but turns it to right and left.

"Mr. Glavin labored with this problem for nine years before he solved it to his satisfaction. The inventor himself

would probably qualify that phrase and say that he labored nine years before he got the car to operating as it now does, and that even now he feels that he has made only a tentative solution of the problem and is by no means satisfied with it as an ultimate achievement.

"But the present achievement is notable enough to satisfy most inventors and to excite the wonderment of all beholders. The mechanism involved, so Mr. Glavin assures us, is relatively simple; important mechanical devices almost always are simple when perfected. In this case, the mechanism that shunts the current from one circuit to another consists of a small drum actuated by an electromagnetic dog-and-ratchet arrangement. Released by one signal, the drum rotates enough to bring a brass collar in contact with poles of the battery, thus establishing a circuit that lights the electric lamp at the top of the mast head. A second signal releases the drum and permits it to turn into the next position, where another brass collar establishes the circuit that enables the dynamo to actuate the propelling wheel. The motorman has turned his lever and established the circuit, and the car is in motion.

"Now comes the third signal, and this (while leaving the propulsive current in circuit) permits another shift of the drum, bringing into action an electrically-driven power that turns the guiding wheel to the left. The car now circles to the left until the next signal brings the wheel back again; then it will go straight ahead again until the sequential signal turns it to the right.

"There are twelve signals in the entire series, and the successive shifts of the drum necessarily take place in an unvarying sequence. Straight ahead—turn to the left—straight ahead on a

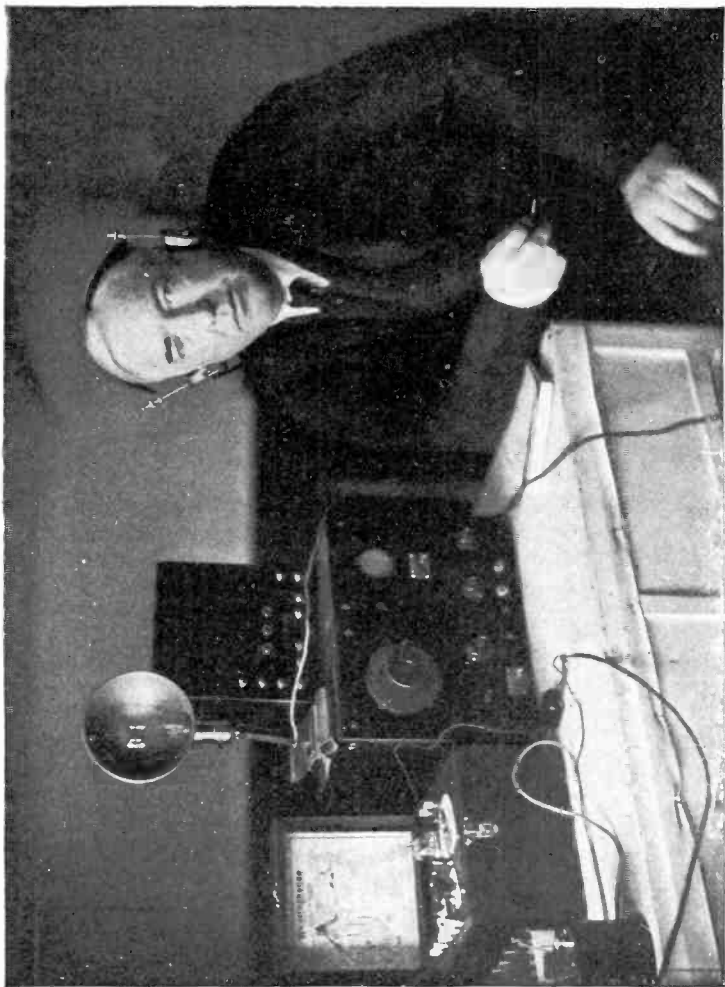

HE LABORED NINE YEARS TO MAKE HIS RADIO CAR WORK

Not so many generations ago this inventor, E. P. Glavin, would have been condemned for consorting with the evil spirits that propelled and guided his miniature motor car. Modern science, however, knows that he is merely juggling with electromagnetic waves in the ether—until ultra-modern science disproves the existence of ether and proclaims another explanation of the phenomena of radio.

new tangent—turn to the right—straight ahead on a new tangent—turn to the left—and so on. There is no way of changing the succession of the signals.

“Nevertheless, the car can be made to take any desired course—as can the man-driven automobile. If Mr. Glavin wishes the car to make its first turn to the right instead of to the left, he merely gives three signals in rapid succession after the vehicle is under way. The

three signals can be given in less than a second's time with the result that the drum will shift so rapidly, that the left-turn circuit and the back-to-center circuit are passed before the wheel has fairly begun to respond and the turn-to-right circuit appears to have been directly established. In other words, the undesirable signals were ‘jammed’ and rendered inoperative.

“Such, then, are the essentials of Mr.

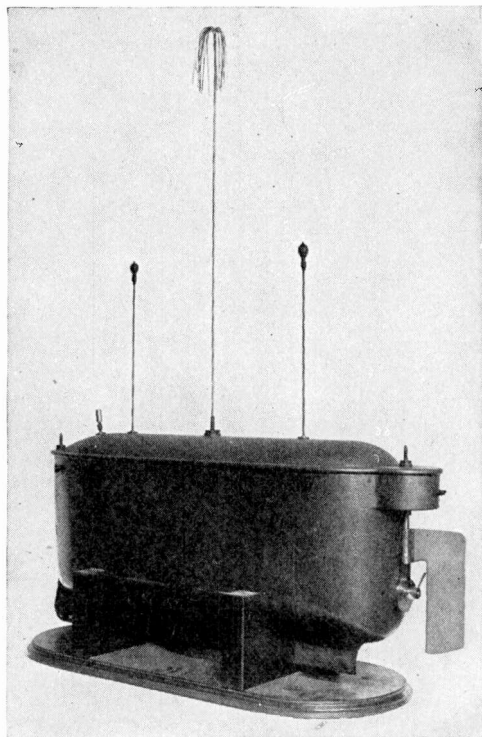

TESLA'S FAMOUS "TELAUMATON"

Figure PP: As far back as 1895 Nikola Tesla gave demonstrations in New York of this radio-controlled boat. It was eight feet long, and was operated in a large tank. The inventor made the boat go through many evolutions, turn lights on and off and fire miniature guns—to the consternation of the public to which radio was practically unknown.



A PICTURE THAT CROSSED THE ATLANTIC IN 20 MINUTES

Figure QQ. This is one of the photographs (of a street scene in London) that was sent from England in the radio photographic tests. These experiments prophesy the publication of pictures of important European events in the daily press of America as soon as in the newspapers abroad.

Glavin's invention. In a sense it is simple, yet of all radio marvels, few are more thought-provocative than this."

Perhaps the greatest marvel of radio transmission is the feat of translating a photographic print into a series of electrical impulses that may be reproduced at a distant receiving station as an intelligent replica of the original. While

we have many such systems, each with its own particular features and faults, the basic principles involved are practically the same and the description of two of the most widely divergent schemes will give the reader a fairly broad understanding of this growing branch of the radio art.

The Ranger system of photographic

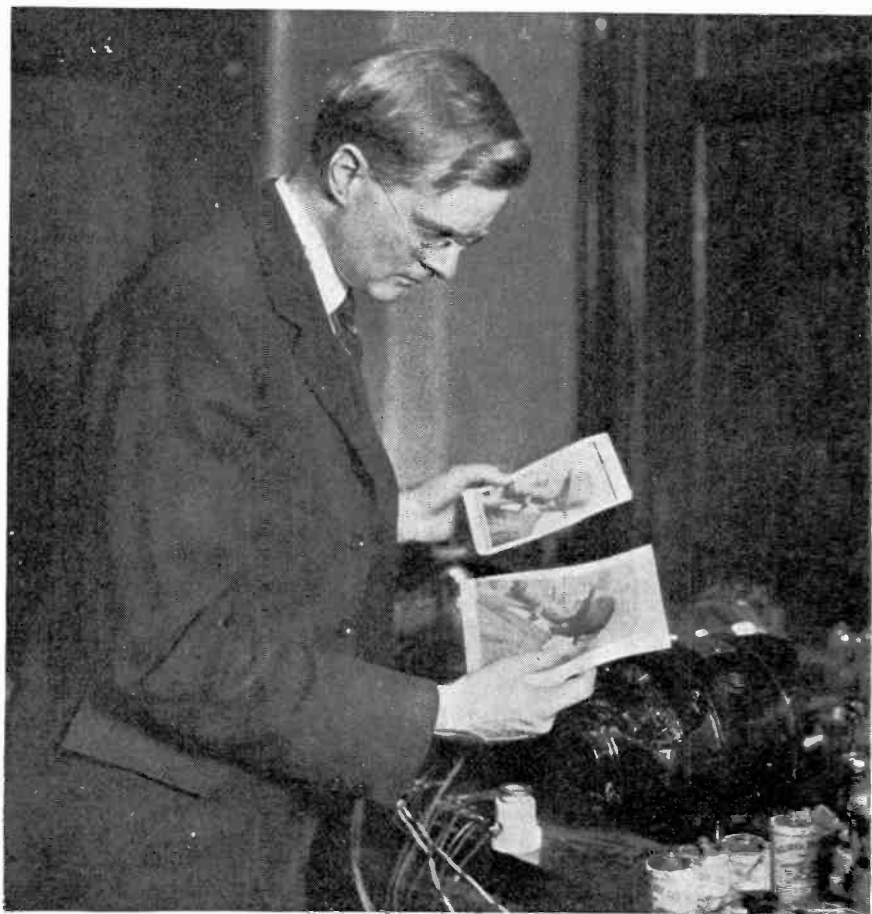

A RADIO CAMERA WITH A 3,000 MILE FOCUS

Figure RR: The inventor is here comparing an original photograph with its transmitted duplicate.

transmission has been successful in trans-Atlantic work and it is perhaps the most simple scheme in use at the present time, a fact that makes it admirably suited for popular description. Mr. Ranger, the inventor, tells of the operation of his machine in his own words:

"Behind any development or invention there must be first the desire for its

particular accomplishment. This desire has long been behind the transmission of pictures by radio and it has finally culminated in the demonstration some time ago when picture after picture was successfully transmitted from the City of London to downtown New York by the Radio Corporation of America's high-powered transatlantic system.

"Set up in the laboratories were loud-

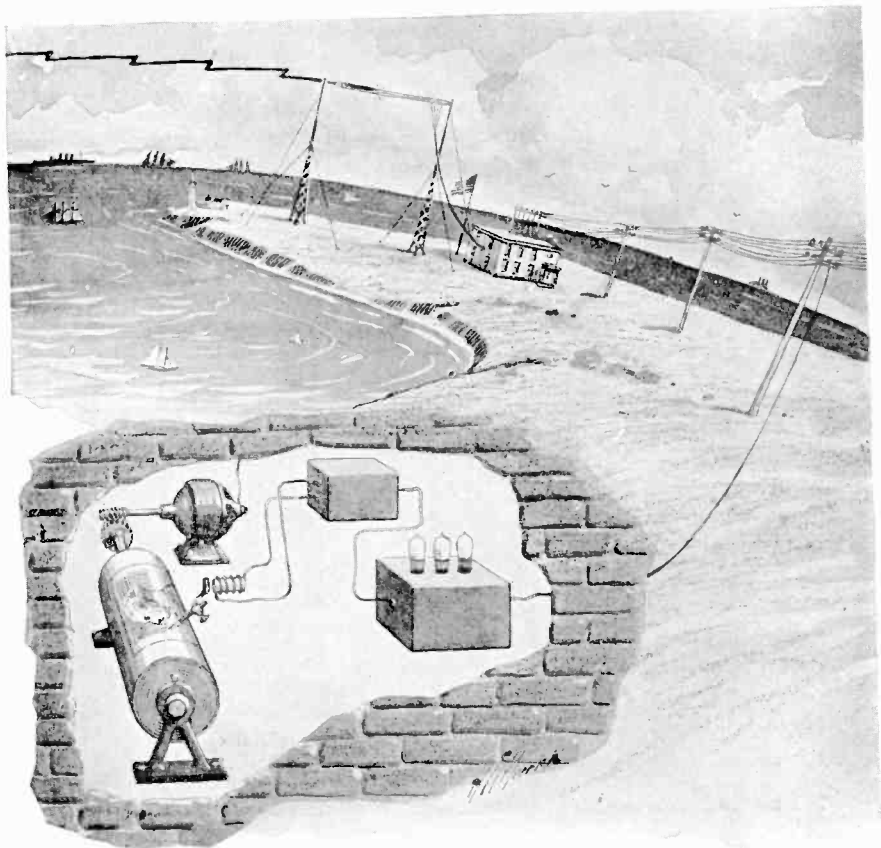

HOW THE PICTURES SPAN THE ATLANTIC

Figure 55: The photographs and printed documents are sent from London by wire to a radio station. They are received by an American station as indicated on this page. From the radio station the electric impulses are relayed to New York and are recorded, as shown, on the cylinder by the special pen.

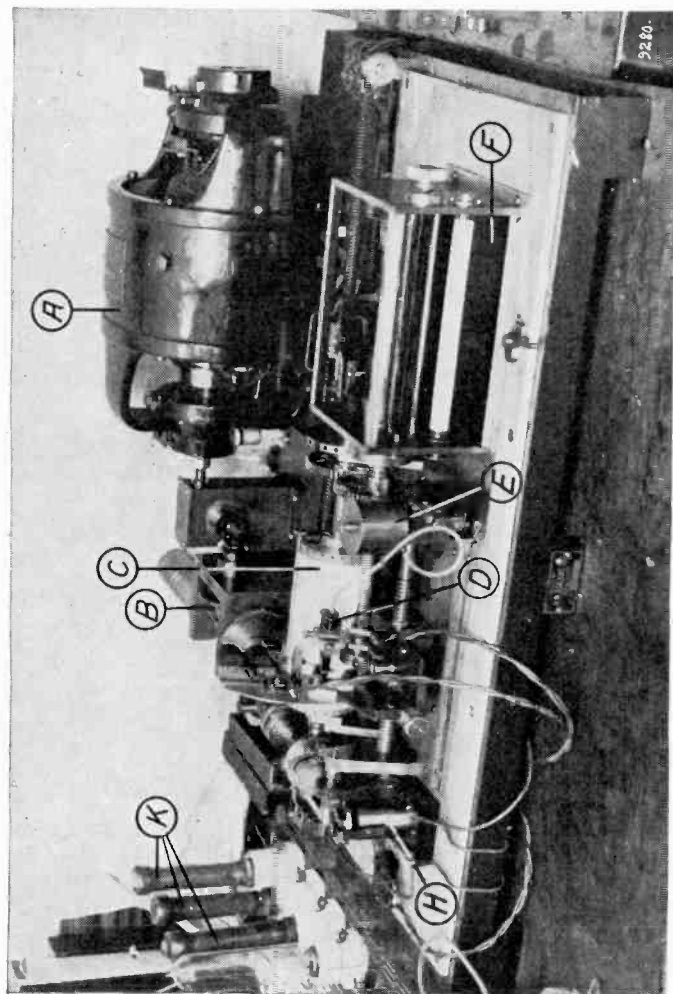

THE RECEIVING AND RECORDING APPARATUS

Figure TT: A in the picture above is the driving motor that runs exactly at the same speed as a similar motor at the sending end. B is the gear that runs the cylinder. C on which the picture is recorded by the special pen D. At H is a magnet that shifts the pen like a typewriter carriage. E is an ink reservoir for the pen. While the pen makes a picture, a ray from an electric light makes a duplicate within the camera box F.

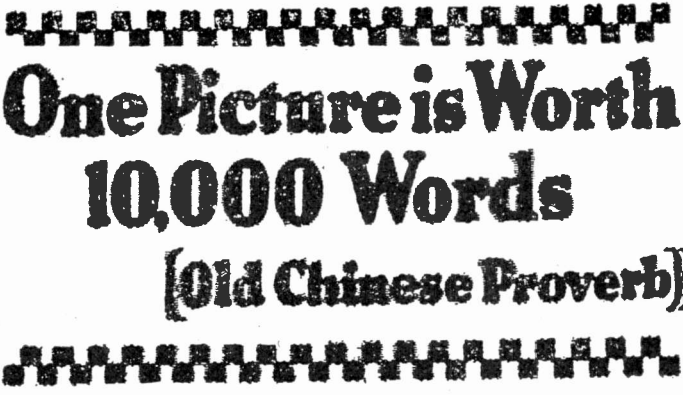

One Picture is Worth 10,000 Words

[Old Chinese Proverb]

HOW PRINTED DOCUMENTS ARE RECEIVED BY RADIO

Figure UU: At a public demonstration of the Ranger apparatus a full-page advertisement, complete with reading matter and pictures, was transmitted from London within a few minutes, ready for reproduction in a New York newspaper.

speakers amplifying the signals coming in from England; but instead of the radio code signals with which most broadcast listeners are familiar, this picture talk seemed to be an incongruous collection of buzzing noises—not particularly rapid in succession and with more or less of a halting characteristic. Nevertheless, they were the shorthand indications which were accomplishing the registration in New York City of the photographic impulses that originated from Radio House, London.

“Mr. Donald G. Ward, an engineer, had gone across to London only three weeks before to set up a ‘board’ about 3 feet by 4 feet in size, on which was mounted a fair-sized motor which is used to rotate a glass cylinder. This motor revolves at an exact speed determined by a vibrating tuning fork which sees to it that, in spite of load or electric current variations, the mo-

tor will keep rigorously geared to time.

“The glass cylinder supports the photographic film to be transmitted. The film may be either a positive or negative, but from an operational point of view it is usually found convenient to use a positive print so that the operator can judge better of the values which should be brought out as the solid black and the pure white of the picture. Inside the glass cylinder is a powerful, although small, electric light which, with its appropriate lenses, sends a beam of light through the film at one point at a time as the drum rotates into a light proof box inside of which is a photo-electric cell

“This cell is the ‘photoradiographic eye.’ The electrical resistance of this cell changes in accordance with the amount of light which falls upon it and in this way takes care of the shading of the picture in transmission.

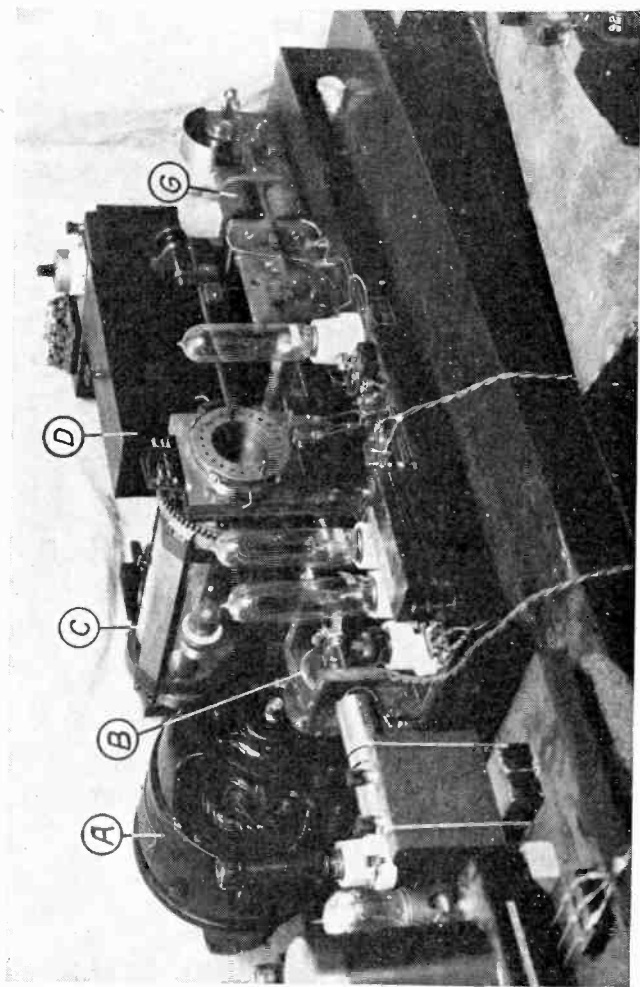

THE RADIO PHOTOGRAPHIC TRANSMITTER

Figure VV: A is the synchronous motor and B is a gear that connects it with the cylinder C on which the photograph to be sent is fastened. D is the camera box that is shifted by the magnets G while the varying lights and shades of the photograph are being converted into electric impulses

"The photo-electric cell functions practically without any lost motion. That is, the instant the slightest change in the amount of light reaches the cell, a corresponding change in the output current of the cell takes place. In this way the 'eye' of the transmitter is able to 'see' even the tiniest light variations; in fact the 'eye' sees and records electrically millions of different current impulses as the films sweep by the light beam from inside the cylinder.

"The photo-electric cell is, therefore, responsible for reproducing an infinite number of different electric current values which correspond with the light or dark areas of the pictures that are being transmitted.

"In order to cover all of the original film, the glass cylinder is rotated back and forth; in this way the entire surface is eventually exposed to the piercing light beam. The film rotates through an angle equal to the width of the picture, and the electric camera itself advances down the length of the picture one notch at a time. Thus, line upon line, the whole picture is covered.

"After the signal impulses or electric waves from the photo-electric cell pass through a series of vacuum-tube amplifiers, they are fed into a modulating device ready for transmission. The electrical interpretation of the picture is then transmitted over land wires from the London laboratory to the high-powered transmitting station of the Marconi Wireless Telegraph Company, Ltd., at Carnarvon, Wales. Here the electric impulses on the land wire operate small relays which turn on and off the high value currents that flow from the 200-kilowatt generator to the antenna system. This high power electrical energy leaving the antenna in interrupted impulses, similar to dots and

dashes of the telegraph code, creates the ether waves which carry the photograph 3,000 miles through space to the receiving station on this side of the Atlantic, located at Riverhead, Long Island.

"The development of the photoradiogram transmitter has purposely been carried on in connection with the established radio-transmitting stations, now engaged in sending radiograms daily between Europe and America. Thus the new device does not require the preparation of any special radio circuits for efficient operation.

"At Riverhead, Long Island, in the Radio Corporation's central receiving station, the operator tunes in to the Carnarvon station. He receives the picture just as he would receive a radiogram, but instead of dots and dashes which he can read he receives an undecipherable series of electrical impulses. These impulses pass through a bank of vacuum-tube amplifiers and are then sent by land wire to the laboratory of the corporation, located in the building in Broad Street, New York.

"Here this unintelligible code, carrying the photograph, is translated back into black and white, recording the original picture much in the style of a stippled engraving.

"An 'unscrambling' device in the laboratory then decodes the complex photo message and gives each individual electrical pulse of energy a definite task to perform in reassembling the picture.

"The picture is reproduced in duplicate at the receiver, both on a paper record and on a photographic film. The paper upon which the record is made is wrapped about a rotating cylinder, which, in size and appearance, much resembles the early type wax phonograph record. A specially constructed fountain pen bears against this just as the

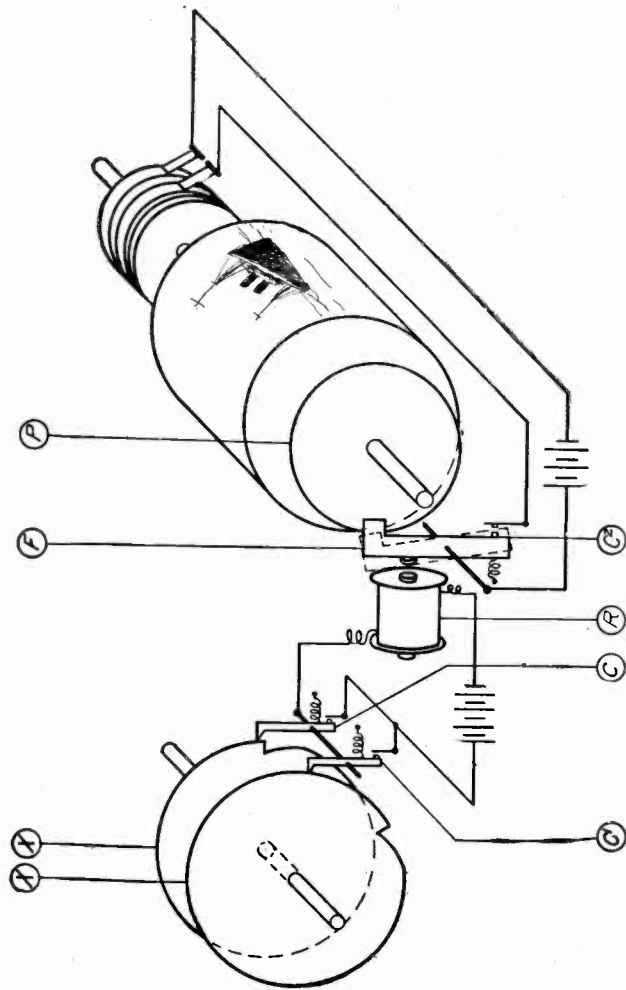

HOW THE PERIODS OF REST AND ACTION ARE CONTROLLED

Figure WW: This diagram illustrates how the two crypto discs XX control the periods of rest and revolution of the cylinder P by means of an electrical relay.

needle of the phonograph does on a record. The pen is attached to an electrically-controlled lever in such a way that every pulse of electrical current which passes through the magnet coils of the relay lever draws the pen to the surface of the paper, making a fine ink mark. A changing current fed through the magnet coils causes the pen to wiggle in step with the current impulses, thus giving the artistic stippling effect in the reproduced picture.

"One of the outstanding requirements in sending pictures by radio or wire is absolute synchronism of the sending apparatus with the receiving device; otherwise distortion will occur. If the receiving apparatus should lag the slightest particle of time behind the transmitting set, the received picture would be blurred and unrecognizable.

"This necessary synchronism is maintained by the use of special driving motors, one geared to the transmitting cylinder and the other geared to the receiving cylinder. These motors although separated by 3,000 miles maintain the same speed. This is accomplished by the aid of the tuning forks already mentioned.

"Chief of the features of this photoradiographic system may be mentioned the fact that the entire operation at transmitter and receiver is in broad daylight. This immediately removes the process from the laboratory stage, which necessitated dark rooms and many other special provisions and brings it into a category of usual commercial equipment.

"The building up of the received picture is a fascinating sight, even to those who have watched it as it became more perfect day by day. This is particularly true when it is realized that it is originating more than 3,000 miles away, and

that those particular dots are being formed nowhere else but right on the receiving cylinder in New York City. No human hand could hope to imitate the precision of the small special fountain pen which puts down, here and there, dots or dashes, then leaves an open space which gives the pleasing effects of the finished picture.

"If the same picture is transmitted twice, the dots do not occur in exactly the same spots on each picture; in other words, each and every transmission is individualistic, although the resultant pictures when held at a little distance are absolutely identical. In other words the dots come in seemingly, hit or miss, but it all depends upon the chance way in which the picture first starts, so that the succeeding dots will take up their proper places with mathematical exactness to give true tonal value to the picture.

"So it seems that this photoradiographic art will soon come to have a real place in communication; particularly as facilitated by the rapidity of radio waves."

One of the greatest obstacles in the transmission of pictures and documents, especially important documents, is that of secrecy. Anyone equipped with the necessary receiving apparatus may intercept the picture message by attuning their device to the transmitting station. Eduoard Belin, a capable French experimenter, has invented a method of sending pictures with what would seem to be positive secrecy. Mr. Belin tells how he does it in the following pages:

"The transmission of pictures and documents by radio is an accomplished fact. It has been done by many with more or less success, depending upon the method and apparatus that has been employed.

wires, and a combination system somewhat similar to those used in safes, which may be adjusted to form 999,999 different combinations. There is, therefore, but one chance in a million for the message to be intercepted by a station even if it is equipped with the proper apparatus. As an added safety, however, during the interval when no part of the picture is being sent, a special device fixed on the machine sends false signals—a feature which makes it absolutely impossible to receive the documents unless the receiving operator knows the combination number and adjusts its apparatus so that it is exactly synchronized with the transmitter. I have named the apparatus that accom-

plishes this feat, the 'crypto,' from the Greek word *cryptos*.

"The crypto is composed of six discs that have cut on their circumference nine slots that are numbered from 1 to 9; these may be adjusted to form any desired combination of six figures. Once set at the proper place, a blade is set in the slots, thus making of the discs a unit which turns at the proper speed and that closes contacts in a certain order that depends upon the combination.

"Figure WW shows how at every turn the contact C, is closed, releasing by means of a relay R, the cylinder P, that bears the picture or message.

"The crypto discs make one-sixth of a turn every second while the cylinder P,

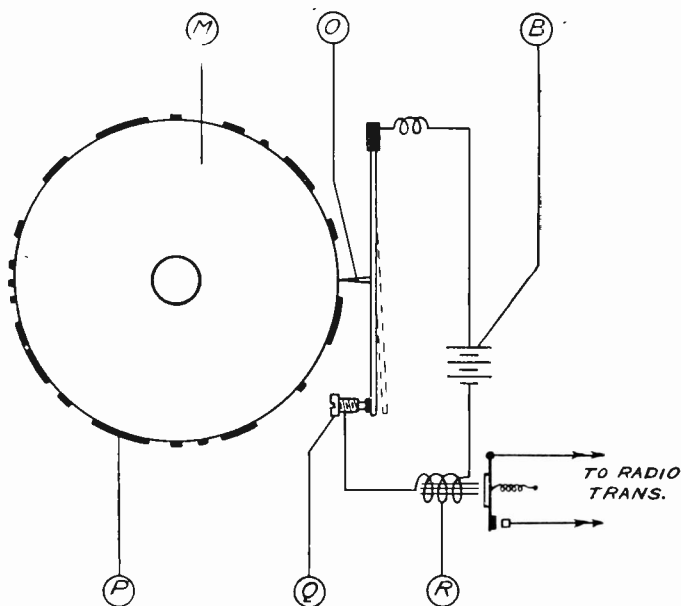

HOW THE CRYPTO DEVICE TRANSMITS THE CODE

Figure YY: On the disc M, the dot and dash characters P, are printed by raised portions which, by means of a needle O, close a switch Q and a relay R, thus sending a signal to the radio transmitter.

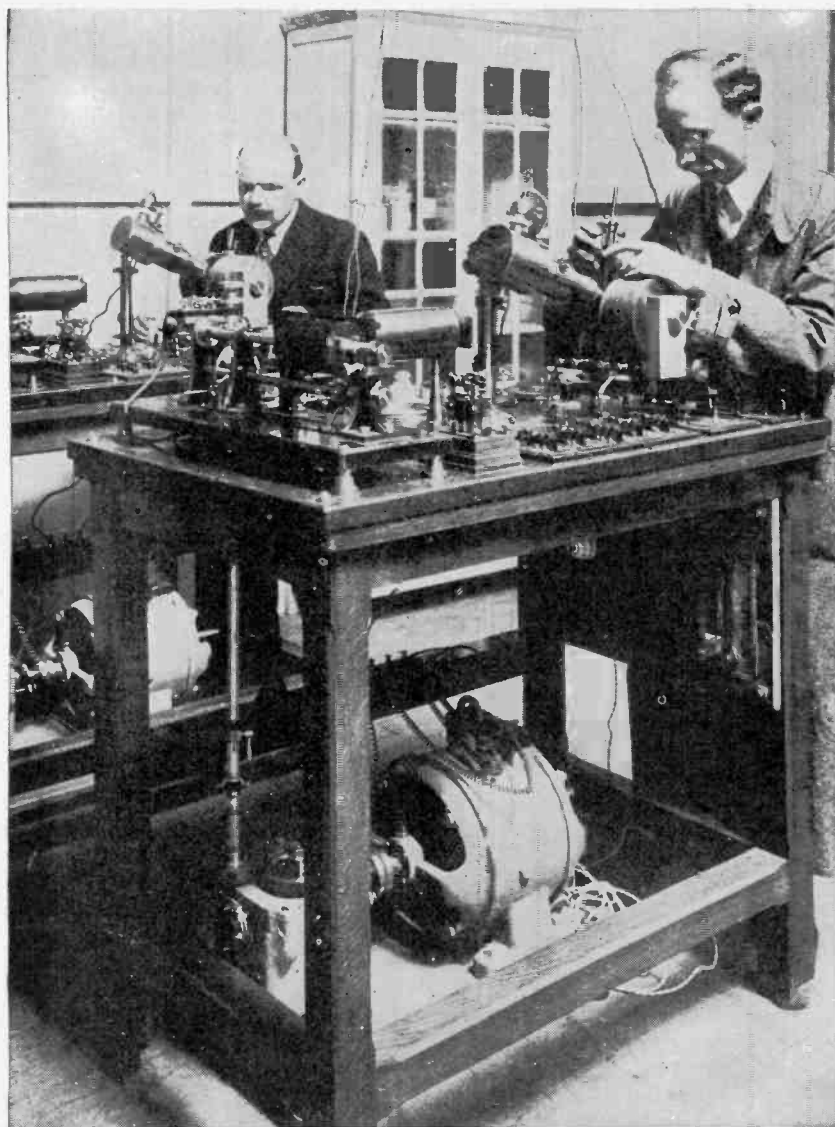

International

THE RADIOCRYPTOTELESTEREOGRAPH IN OPERATION

Figure 22: Here are shown the two complete machines, one for transmitting and one for receiving pictures by the Belin process. Both machines are run by synchronous electric motors, and the receiver is timed by a radio impulse sent out at regular intervals so that both the transmitter and the receiver will keep in time; otherwise the pictures would be deciphered incorrectly and would be reproduced merely as a meaningless jumble of light and shade.

accomplishes one revolution in two-thirds of a second; therefore, when the contact C, is closed, the relay R, attracts the finger F, locking the cylinder and at the same time closing the circuit of a magnetic clutch which couples the cylinder to the rotating shaft; these operations are made instantaneously.

"As the contact C, is only momentary the relay R, is energized for only a fraction of a second and the finger F, is attracted just long enough to release the cylinder, coming again in contact with the cylinder P, and sliding on its edge until it falls again in the slot, stopping it and opening the circuit of the clutch at C¹. The same cycle of operations happens every time one of the contacts C or C² are closed. For the sake of clarity, only two contacts are shown in the sketch, but six contacts are used in the crypto, one for each disc.

"Figure XX illustrates clearly the method of operation, as it shows the periods of work and rest of the cylinder. The six breaks on the discs are numbered and are supposed to be set for the combination 913285.

"The efficient time of rotation of the cylinder upon which is fixed the picture that is being sent, is two-thirds of a second, and may be taken as twenty-thirtieths of a second. If the discs are adjusted to form the combination number 913285 (for example), there will be before the 1st turn of the cylinder, a rest period of ten-thirtieths; at the beginning of the 2nd second, the cylinder of one turn rotates in two-thirds of a second, and stops during thirteen-thirtieths of a second, before it starts for the 3rd turn, and so on; the inactive time is determined by the arrangement of the discs.

"As may be seen, therefore, the pic-

ture is sent at irregular intervals, which makes it necessary for the receiver to be exactly synchronized so as to start exactly at the same time as the transmitter. If but a single figure in the number is wrong, the lag at every turn would increase and put the whole system out of tune, and the results on the receiving cylinder would be unintelligible, as several spots would be reproduced at irregular intervals. The false signals disc, in other words, would produce some extra spots which would render the picture or message absolutely unreadable.

"All these operations are made at every turn and happen every second. The time required to send a picture or message being about $4\frac{1}{2}$ minutes.

"The vital factor in my machine is the synchronism which insures the transmitter and receiver turning at the same speed. It includes a clock that has a contact system which closes a local circuit every second. By means of an adjustment at the receiver, the contact may be made exactly at the same time as at the transmitter. The operator at the receiving end listens to the tick of the transmitting clock which closes the circuit of the radio transmitter, and adjusts the contact so that the local circuit of the receiving clock is closed at the same instant. Once this is adjusted, both transmitter and receiver are started and the picture sent.

"The picture to be sent is photographed on a gelatin plate which is developed and stuck on a brass cylinder over which a needle contact slides in the same fashion as the needle of an old style phonograph or of a dictaphone. The motion is such that the needle covers at each turn one-hundred-and-twenty-fifth of an inch, which has been found sufficiently accurate to reproduce de-

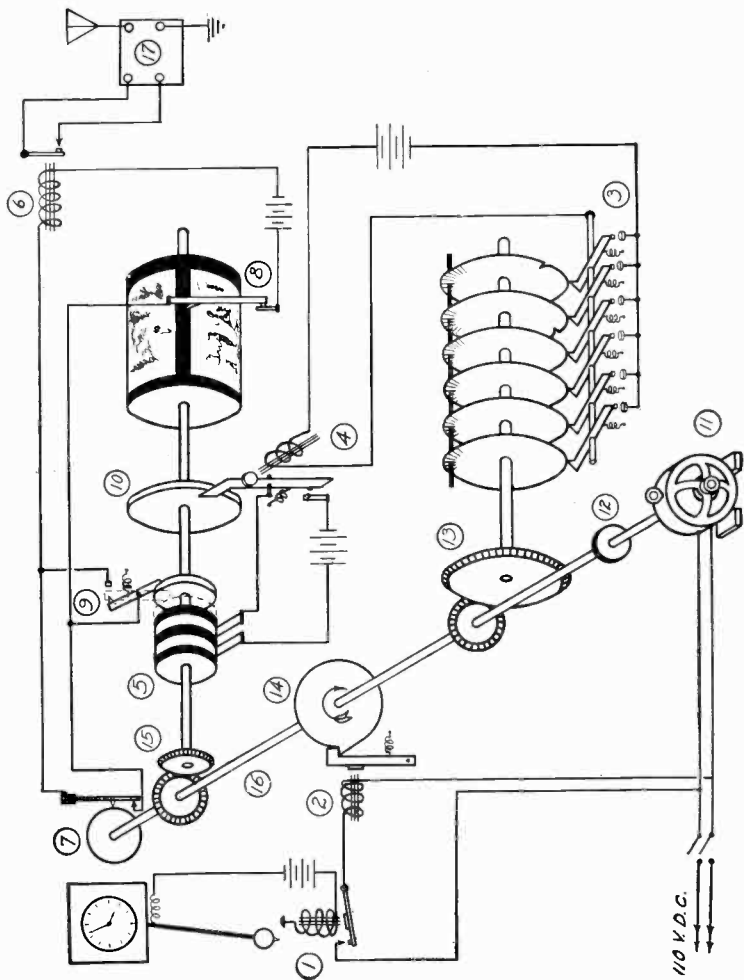

THE COMPLETE TRANSMITTING APPARATUS

Figure A8: This schematic drawing shows how the apparatus insures the complete secrecy of the transmission. With this device there is less chance than one in a million that pictorial enveloping may be accomplished.

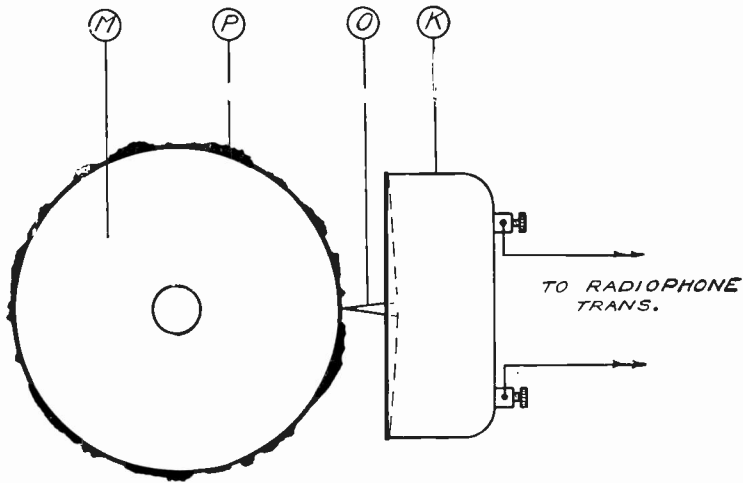

HOW PICTURES ARE TRANSMITTED

Figure B3: For transmitting photographs and other pictures that require half-tone effects this device is used instead of that pictured in Figure YY. The microphone follows all of the various shadings between white and black, whereas the switch device can only distinguish between pure white and deep black.

tails. Every time a black part of the picture passes under the needle it opens a local circuit, for these black parts are in relief; when the gelatin is developed, the white parts of the picture are eaten away by the developer and form a depression. (See Figure YY.) Every time the local circuit is opened, the current of the battery, B, is interrupted and the circuit of the radio transmitter, controlled by the relay, R, is closed, thus sending a signal.

"Figure A3 shows the complete transmitter with the crypto apparatus that insures complete secrecy of the transmission. The transmitter is operated by an electric motor upon the shaft of which are mounted a friction device, the necessary gears, the synchronizing disc and the small wheel that produces the false signals. Every second, when the clock makes a contact, the relay 1, is closed; the 110 volts that energize it

flows through the relay 2, releasing the synchronizing disc which is stopped at every turn when the tooth catches on the arm of the relay. The motion is therefore transmitted to the cylinder and the picture sent as explained previously.

"The purpose of the tooth on the synchronizing disc is to stop the cylinder at every revolution during a fraction of a second. The reason for this will be explained later. As the cylinder stops at every turn in the same position exactly where the picture ends, the contact 8, is closed, but at the same time, as the magnetic clutch 5, is released, the switch 9, is opened and is pushed back by the steel disc when released; this puts in circuit the 'static machine' 7, composed of a disc corrugated so as to imitate a picture. This disc, which turns all the time with the motor, sends artificial signals that operate the radio transmitter in the

same manner as if the contacts were made by the picture. However, while the picture is being sent, the 'static disc' is short-circuited.

"The receiving apparatus is similar to the transmitter except that the cylinder upon which the sensitive film is stretched is enclosed in a light-proof box that has but one opening about the size of a pin-hole. The received current passes through the 'string' of an Einthoven galvanometer which normally obstructs a beam of light concentrated through a fine slot. When the needle passes over a black part of the picture at the transmitter, a signal is sent and causes the galvanometer string to deviate at the receiver, thus unobstructing the light beam which passes through the pin-hole, and thereby making an impression on the film.

"When the entire message or picture is sent the film is developed and prints are made in the usual way. Either a negative or a positive may be received at will by merely adjusting the galvanometer so that the string obstructs the light when a signal is sent. The reason why the cylinder that supports the pictures at both the transmitter and the receiver are stopped at each turn is that it has been found by experiment that the ordinary synchronizing systems are not reliable, and that it is almost impossible to keep the two cylinders turning at the same speed unless one uses a correcting system. In our apparatus, the correction is made at every turn by having the main shaft stopped by the tooth on the synchronizing disc. Every second both cylinders start at the same time, thereby preventing any great variation to be introduced while the machines are running, even in the cases of slight speed variations that are caused by the motors.

"This apparatus, which may be built in a compact form, has been used in experiments carried on aboard airplanes for sending sketches and messages from a plane to the ground. Very shortly I intend to transmit pictures from Europe to America.

"The process, as here described, permits only the transmission of pictures in black and white. This is on account of the equipment of the radio stations, which can send only dots and dashes. However, when a radio telephone station of sufficient power is available, the stylus that presses against the picture, fixed on the cylinder, may be replaced by a microphone that has a needle mounted in the center of the diaphragm. Half-tones may, therefore, be sent, as the microphone transmits all the variations of thickness of the gelatin, as shown in Figure B3.

"At the receiving end, a Blondel oscillograph is substituted for the Einthoven galvanometer, so as to permit the reproduction of all the values of the picture. ^{say is}

"The oscillograph is composed of a strong electromagnet, in the field of which is an armature made of fine silver or gold wire in the shape of a long loop. Upon the wire is stuck a tiny mirror, that reflects a beam of light that is projected upon it. When the picture is being sent, the microphone modulates the radio waves in the same way as the voice does, and at the receiver the modulated current is sent through the armature of the oscillograph. This variable current, passing through the loop of fine wire, twists it more or less, and thus moves the mirror attached to it and deflects the beam of light—as shown in Figure C3.

"The beam of light passes through a screen that is shaded from black to

white, interposed between the galvanometer and the lens; this concentrates the beam upon the film. As the light is of variable intensity, a half-tone picture is received with all the details and shades of the original."

Is it possible to transmit radio pictures in color? This is a logical question for a layman to ask and the surprising part of it is that the question can be answered in the affirmative for this great technical feat has actually been performed. As a matter of fact, the sys-

tem used is amazingly simple when one stops to think of the miracle worked.

In order to understand all that is involved in transmitting a color photograph over a telephone line, it is necessary to outline the processes of making a color picture by the three-color process. The three-color process depends for its possibility on the fact that all colors may be copied with a high degree of fidelity by the mixture of three colors which are called primary colors. These colors are red, green and blue.

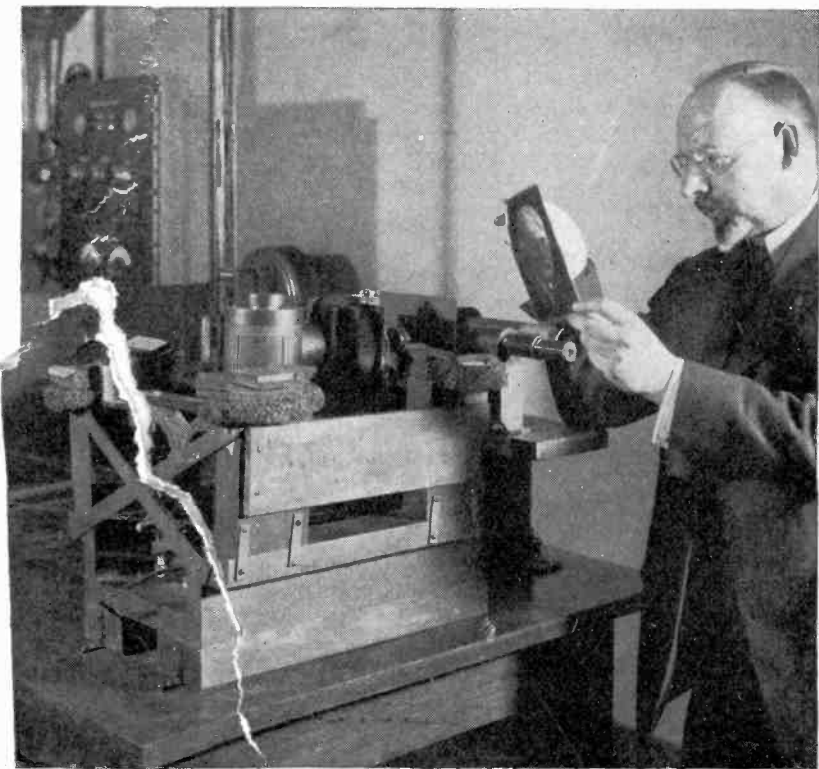

THE RECEIVING APPARATUS FOR COLOR PICTURE TRANSMISSION

Figure D3: The unexposed film is just below the hands of Dr. H. E. Ives, the illuminating engineer, who worked on this development. The lense to the left is the "light valve" that controls the light beams thrown on the film from the lamp house at the extreme left.

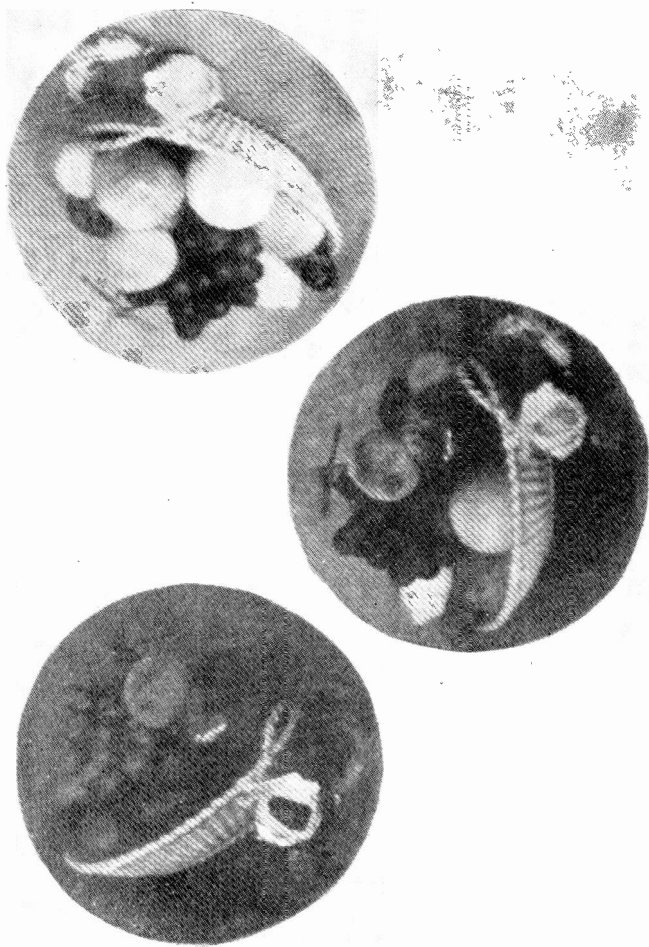

A. T. & T. Co.

THE POSITIVES OF THE THREE KEY-NEGATIVES AS THEY ARE RECEIVED

Figure E3: These negatives serve in the same way as engraved plates for printing in colors; each is a key to the primary colors, yellow, red and blue.

Mixing red, green and blue light, as for instance by means of three projection lanterns, each one furnished with a proper colored glass over its lens, enables us to make white light when the three colors are in a given proportion of intensity, and all other colors, including yellow, orange, violet, blue-green, and so on, when the proportion of the three primaries are altered.

The process of making a three-color photograph then consists in all cases of making three negatives of the original object each through a color filter, as it is called, which in combination with the color sensitiveness of the photographic plate makes a record of the amount of one of the primary colors which will be needed to mix with the others to reproduce the color of the original object. Thus the filter corresponding to the red projection lantern above considered must transmit light from a photographed object to the amount which red light is going to be used in order to copy the color of the original. An orange, for instance, will be recorded partly through the taking filter for green; since red and green light are to be mixed to produce the orange color.

When the three record negatives are obtained they may be used to make a color picture in any one of several different ways. Transparency prints from the negatives may be placed in three projection lanterns and projected on a white screen in red, green and blue light; the three images being accurately superposed one on the other. Or three transparent films may be prepared which are to be laid one over the other. In this case the colors to be used are not red, green and blue but the complementaries, that is, the colors which mixed with these make white; they are blue-green, crimson and yellow. The

object here is not to add lights to each other as was done with the lantern, but successively to absorb the primary colors from the white light. Accordingly the red record is printed in blue-green, so that where the red record is black, the transparency film will obstruct all the red light coming through; the green record is printed in crimson, the blue record in yellow.

It is now obvious that in order to send a three-color photograph over the wires, all that is necessary is to send three black and white record transparencies made from the original three-color negatives. One of the accompanying illustrations shows in black and white the three separate impressions of a single picture, which if they were printed in the proper colors and superimposed would give a colored reproduction. In making the positives for transmission, each one was turned at a different angle in order that the structure of fine lines which is introduced in the process of transmitting over the telephone wires would appear in each received picture at such an angle as to prevent geometrical patterns when the three were superposed. Also the differences in the photographic density of the three records is clearly shown, corresponding to differences in color in the original object. The actual transmission time of the three positives together was about 20 minutes, which included the time for changing and making adjustments of the apparatus between each picture.

Regarding the applications of telephone transmission of colored pictures, there may be an important field in the production of three-color transparency lantern slides of news subjects. Lantern slides can be made from the transmitted photographs in a very few min-

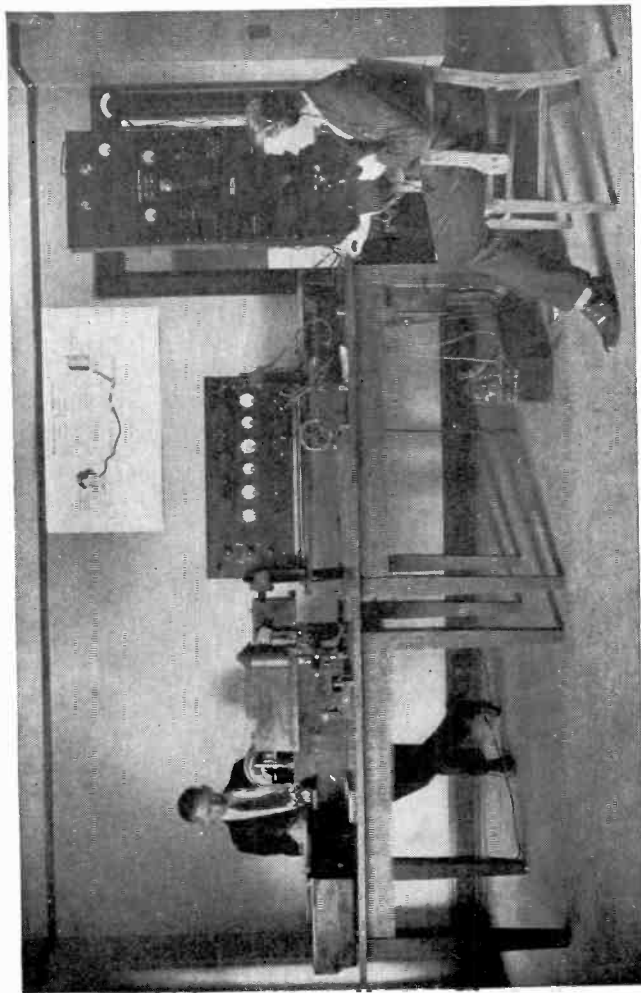

A. T. & T. CO.

THE EYE AT THE SENDING END THAT PICKS OUT THE COLORS

Figure 18: On the extreme left is the synchronous motor for rotating the film which, with the photoelectric cell is under the dark cover just behind the lamp house. The large case with the dials contains the amplifier for enlarging the output of the photoelectric cell.

utes and could be shown to large audiences so quickly as to offer promise of their utilization in photo-news service in such places as moving picture houses. Lantern slides in color would give additional interest to such a service. For this purpose it is of course necessary to have available color cameras capable of making the original three-color negatives with such short exposures under practical lighting conditions as to be able to cover all kinds of subjects. Recent developments in photographic speeds, lenses and apparatus offer promise of the early availability of such three color negatives.

Having accomplished the transmission of still pictures, it is evident that the restless, inquisitive mind of man would go out in search of a system to transmit moving pictures. Those who understand the optical trick employed to give the illusion of motion in moving picture projecting machines perhaps know that the transmission of radio movies involves only the speeding up of still picture transmission. If it should become possible to transmit sixteen pictures in one second of time, the feat of moving pictures by radio would be accomplished.

C. Francis Jenkins, a Washington inventor, has come very close to making radio moving pictures a reality and with the great progress he has made it is only a matter of time before a polished system will be completed. Watson Davis, a well-known writer on technical subjects, describes a visit to the Jenkins laboratory:

"When I talked to C. Francis Jenkins over the telephone and he asked me to come up to his laboratory, I was not surprised and startled that he and I could talk over a copper wire. Telephoning is a common performance. Even the

nightly radio voices in the ether are no longer the marvel they were a mere two years ago.

"But, when Mr. Jenkins asked me to watch a screen in his laboratory which was shut off from the rest of the room and when I *saw* him wave his hand to me, although my back was turned to him, it was unusual.

"I was seeing by radio!"

"But Mr. Jenkins has done unusual and unprecedented things before. Every ordinary motion picture projector contains a vital principle invented by him. Readers of radio literature know also that he has within the last year made it possible to send diagrams, messages written in Chinese characters, and even photographs by wire and radio.

"Sending and receiving sets for transmitting still pictures by radio were in his laboratory, and it was plain that this apparatus for radio vision, a new assembly of disks, motors, lenses and lights, was related to the more finished and mature equipment that has been successful in sending pictures and diagrams through thin air.

"In reply to my hardly pronounced 'How?' Mr. Jenkins showed how he had made the movement of his fingers and hand visible by radio. The apparatus seemed extremely simple, certainly no more complex than the telephone when Bell first operated it. A magic lantern, the same as thousands in ordinary use, was projecting its shaft of light through a disk that revolved at high speed. The light fell on an opening in a rectangular box, supported, much like a small camera, on a heavy tripod placed half way across the room. From the black box on the tripod, wires ran to a radio transmitting set that was heavily screened to keep stray and troublesome electric currents from getting in the

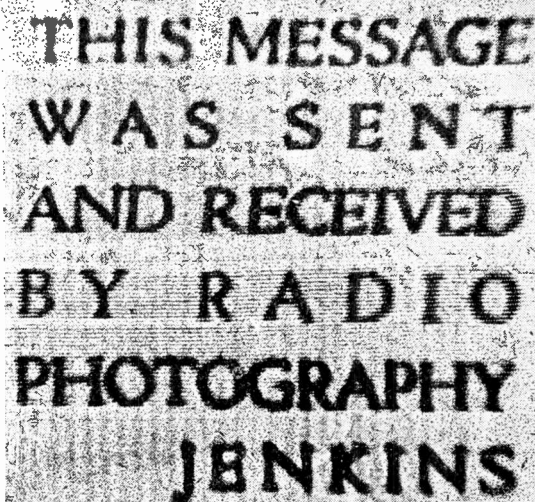

THIS MESSAGE
W A S S E N T
A N D R E C E I V E D
B Y R A D I O
P H O T O G R A P H Y
J E N K I N S

AN EXAMPLE OF FACSIMILE REPRODUCTION OF READING
MATTER (OR PICTURE) BY THE JENKINS MACHINE

Figure G3: The transmission of a "still picture" by radio was the first step in the transmission of motion pictures—which are but a series of still pictures. Now the inventor is transmitting actual scenes directly from the moving objects.

way. When a wave of the hand was to be transmitted, Mr. Jenkins simply inserted his fingers into the space where the lantern slide holder of the ordinary stereopticon is placed.

"The object of the whirling disk and stereopticon, Mr. Jenkins told me, was to impress the shadow of the moving fingers and hand, portion by portion, upon the light-sensitive cell that was contained in the camera-like black box on the tripod. How this is done will be explained later. But the result is that the variations in light that this cell

receives are translated into variations in electric current, just as the variations in sound that enter the telephone transmitter exit upon the wires as variations in electric current. The shadow of the moving fingers, now in the form of varying electric current, was fed into the radio transmitting set and handled in exactly the same way as hundreds of jazz concerts are broadcast every night.

"The receiving antenna in the case of this demonstration was only a few feet away from the sending antenna on the

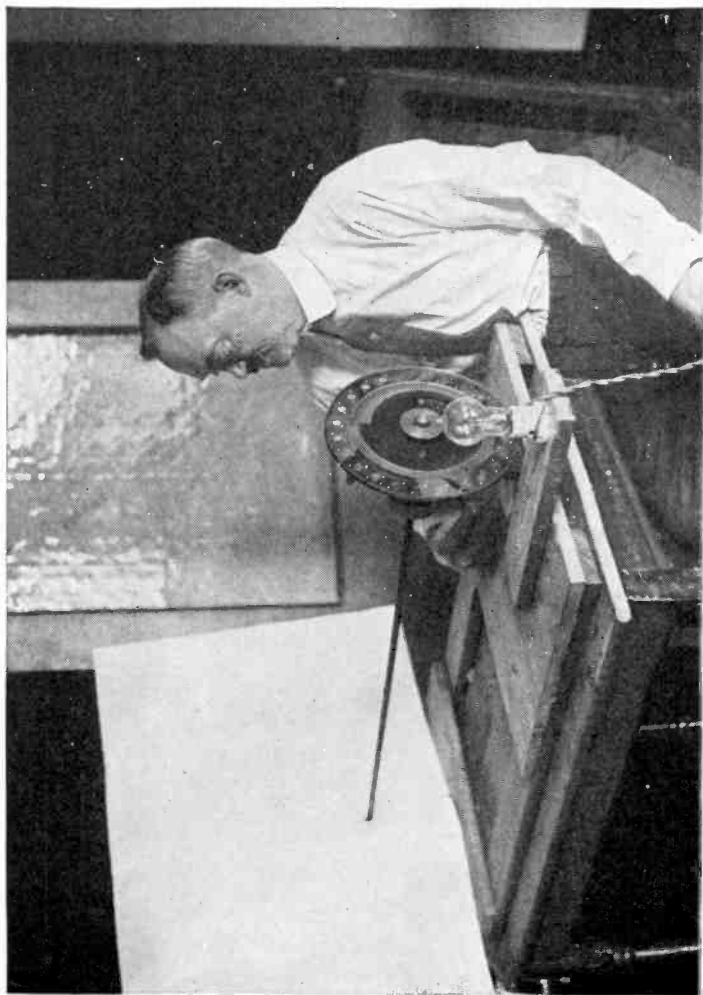

THE ESSENTIALS OF THE RECEIVING SET FOR RADIO-VISION

Figure H3: The lamp shown in the picture receives a varying electric current and transforms it into variations in light, which are taken by the multiple lens disk and thrown onto the screen in the background in the form of a picture. The motor driving the disk is located behind the screen.

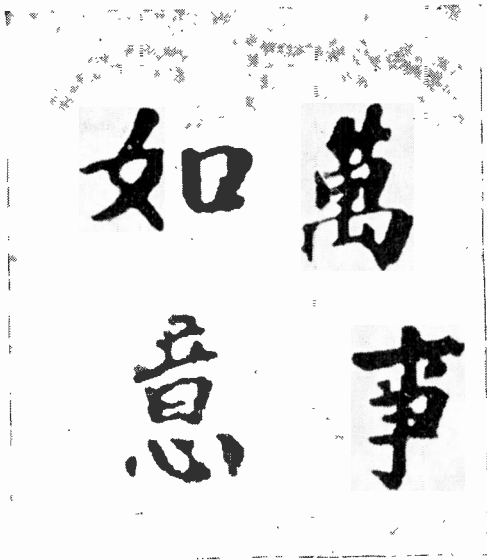

AS IT WAS SENT—

Figure 13: This is the original Chinese message that was handed to the radio operator for transmission at the sending station. Its Chinese significance is "Ten thousand joys on your journey."

roof of the Jenkins laboratory, but for a short distance that wave of a hand went through the ether in the form of radio waves. After being picked up by the receiving radio set, these impulses were changed back into an electric current and sent to the radio-vision receiving set.

"This receiving apparatus consisted of just four essentials: a lamp that changed electric-current variations into light variations, a whirling disk similar to the one in the transmitter, a lens, and a picture-receiving screen.

"Radio vision is as much a matter of optics as electricity, and since light and electricity are both members of the big family of ether waves, differing only in length, there is no reason why they should not work amicably.

"Yet there is no question but that the radio part of radio vision plays second fiddle to the whirling disk. These rings of lenses make radio-vision possible. They take the wave of the hand and impress it portion by portion on the light-sensitive cell; they take the rapidly fluctuating light and change it into a moving picture.

"The human eye is easily pleased and slurs over minute imperfections. All of the halftone illustrations in our newspapers are nothing but areas of coarse dots, sixty to the inch, that our eyes obligingly turn into pleasing pictures. That is a very useful optical trick and it is used by Mr. Jenkins in sending still pictures by radio and also in his process of radio vision.

"Again, speed can be used to fool the

如
萬
意
事

—AND AS IT WAS RECEIVED

Figure J3: This is the message as it was received by the radio operator and handed to its Chinese addressee; it is practically a perfect reproduction in somewhat grayer tone.

eye. Getting fooled is not always unpleasant, because it allows us to enjoy motion pictures. In the theaters, sixteen photographs appear on the screen each second, and that is speedy enough to make it seem to our eyes that the motion is in the objects in the pictures, not in the pictures themselves. And this optical illusion is used by Mr. Jenkins in radio-vision.

"Lines, not dots as in the halftone, very close together, are the structure of both pictures and vision by radio. These lines of light are swept across the progressing picture by the whirling disks. Light is the paint and the whirling disk is the brush in radio pictures and vision.

"In the Jenkins apparatus for transmitting still pictures, the whirling disk

has a prism curled around its circumference. Prismatic lenses, as almost all of us have observed, have a way of persuading light to deviate from its straight path. The disks used in transmitting still pictures by radio are made entirely of glass, and the prismatic lens is ground on the circumference. This is, however, the equivalent of many lenses since it is of varying thickness. And this causes a beam of light, projected through it while it revolves, to be swept from one side to the other or up and down.

"Two of these disks are used to project the photograph upon the transmitting light-sensitive cell in Jenkins' pictures by radio apparatus. One disk covers the picture in one direction while the other covers it at right angles to the first, and one of these disks operates

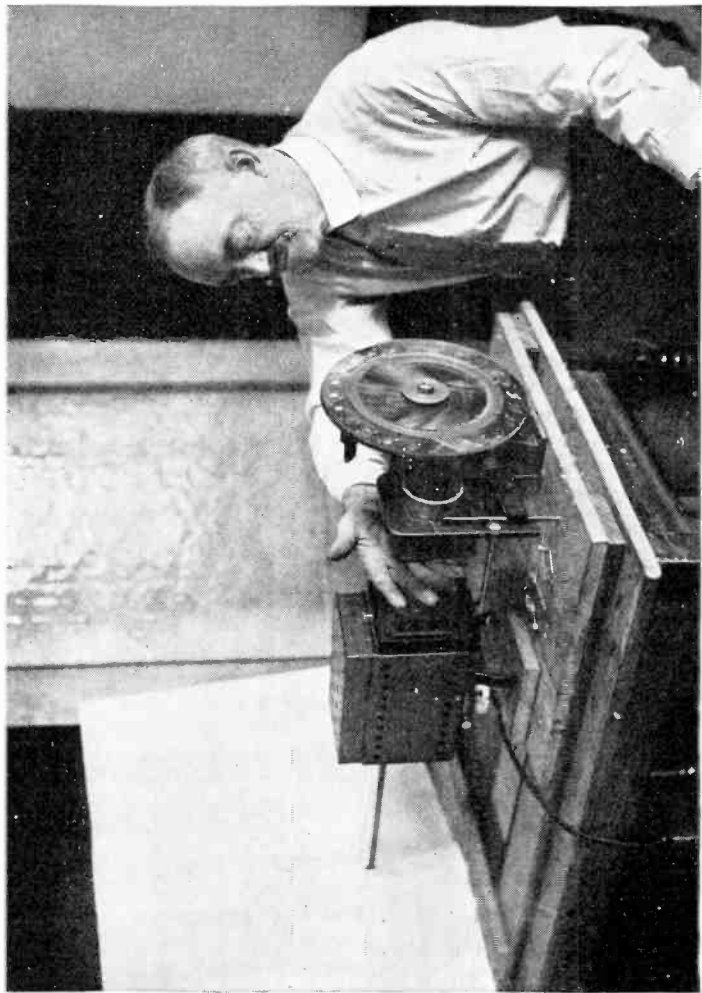

THE SIMPLE APPARATUS THAT SENDS A WAVE OF THE HAND BY RADIO

Figure K3: The inventor, C. Francis Jenkins, is placing his hand in the stereopticon which throws a beam of light on the multiple-lens disk. This disk impresses a picture of his hand upon the light-sensitive cell (which is across the room and not shown in the photograph) and this cell translates variations in light to variations in electricity.

many times faster than the other so that the effect, in both sending and receiving, is the drawing of lines across the picture very close to each other. In sending still pictures, this operation takes about a minute.

"To transmit motion, the sending must be speeded up so that at least sixteen pictures are transmitted each second instead of one picture in several minutes. Compared with this, ordinary motion pictures such as we see in theaters, are comparatively simple. At the movies whole photographs are projected on the screen all at once, and they are thrown on and taken off so rapidly that the eye cannot detect the separate projections but blends them together into continuous motion of the objects in the picture. In radio vision the picture is projected on the screen portion by portion, but to produce the effect of motion or actual vision a complete picture must be built up every sixteenth of a second. Prismatic disks that produce only one picture a minute are obviously too slow.

"So Mr. Jenkins has devised a new form or disk, that contains lenses that combine the function of covering the picture vertically and horizontally. In the apparatus that he demonstrated, the disk was so made as to produce one complete picture with each revolution. It contained forty-eight lenses in all. Each of these was, in effect, a combination of a rather flat convex lens and a prismatic lens. The lenses varied by having the prismatic part thick on one edge for the first lens and then gradually changing their angles until the thickness was on the other edge for the last or forty-eighth lens. For all lenses the convex portion was the same. Thus in this compound lens both horizontal and vertical motion of the light was obtained. The forty-eight lenses forming

a prism of varying angles shifted the scene once horizontally, while each convex lens by its vertical motion swept the scene over the light-sensitive cell in one-forty-eighth the time of the horizontal shift. Thus each scene was impressed on the cell as forty-eight horizontal lines spaced close together. The speed necessary for the production of continuous motion in the radio-vision receiving apparatus was sixteen revolutions a second or 960 r.p.m.

"Exactly the reverse process takes place in the radio-vision receiver. The dismembered scene enters the lamp of the receiver as a fluctuating current, strong where the light of the transmitted scene was strong, weak where it was weak. Faithfully the lamp reproduces light, and the whirling disk with its dual-purpose lenses sweeps the scene on the screen just as its twin in the transmitter swept it on the light-sensitive cell.

"It is a shadowy wave of the hand or movement of the fingers that is produced. A picture composed of only a few horizontal lines, varying in light intensity along their lengths, cannot be expected to be very distinct or detailed.

"But even shadowy motion such as was produced was a demonstration of the important possibilities that the method holds. Increase the number of lenses that produce each picture to several hundred and the detail will come.

"In another important way, the radio-vision apparatus differs from the radio-pictures outfit. The light source in the receiver must vary quickly with variations in the incoming current. The ordinary lamp that is speedy enough for still pictures by radio cannot make the pace necessary for radio vision. Mr. Jenkins is using a corona glow lamp, in

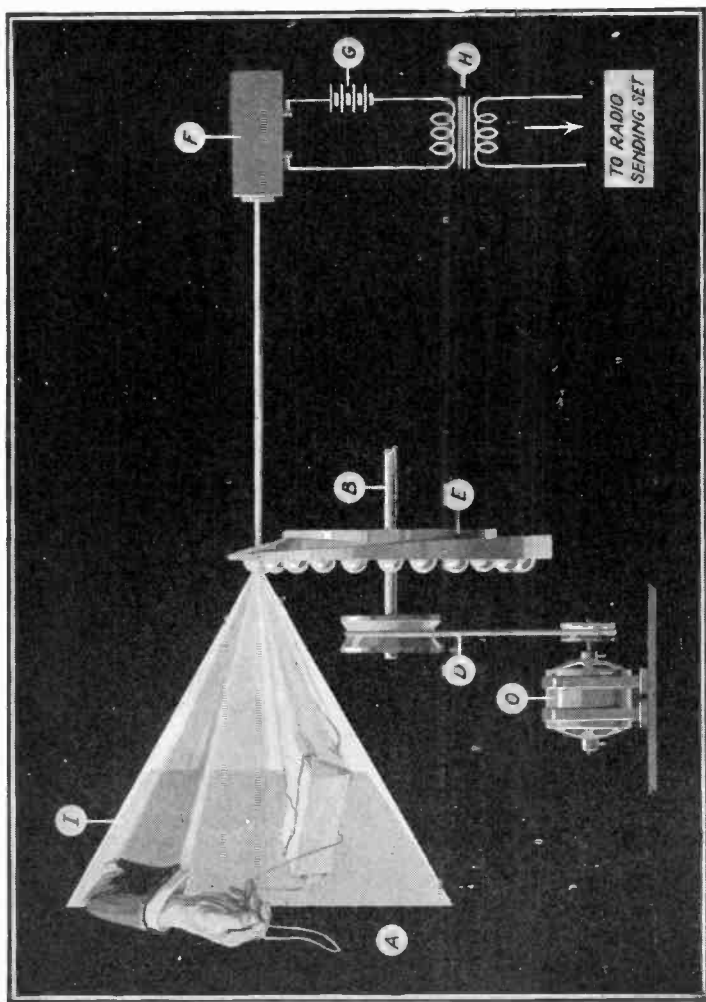

THE RADIO TRANSMITTER FOR MOTION PICTURES

Figure 18: The light I, from an object A, is focused one strip at a time, through lenses on the rotating disk E, onto the light-sensitive cell F. Electric current from the battery G, is modulated by the light and sent out by radio in the usual way.

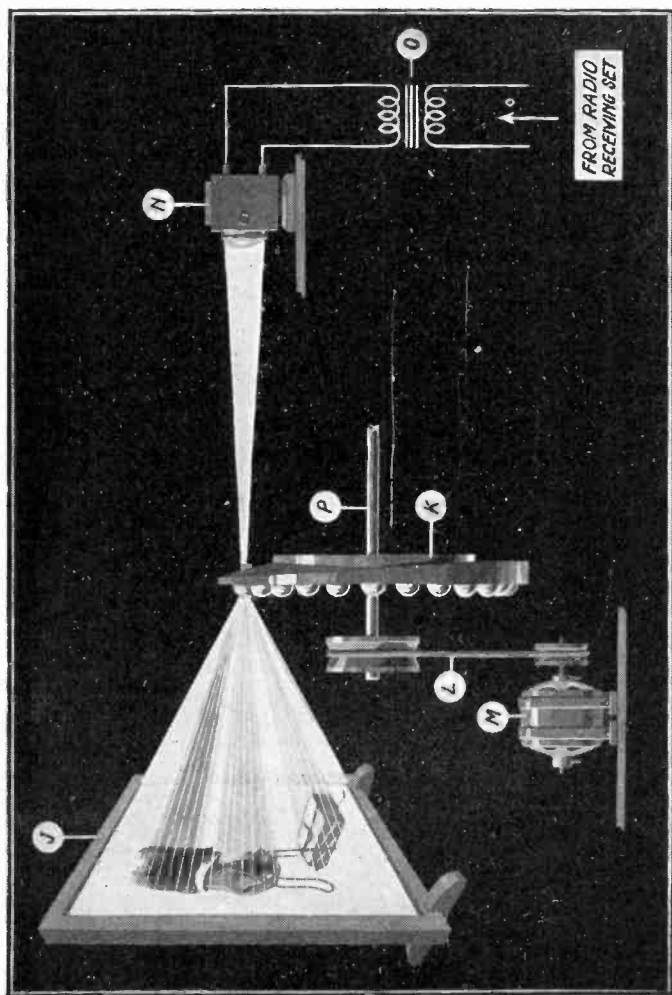

HOW THE RADIO MOVIES ARE RECEIVED

Figure M3: Radio impulses are communicated through the transformer O, to the device N, which reconverts them into pulses of light. These pulses, passing through the lenses on the rotating disk K, produce an image of the original object on the screen J.

which the gas around the internal electrodes gives off the light. The lamps are filled with neon, one of the rare inert gases. With this kind of lamp the lag is sufficiently small but the intensity of light is not great and efforts are being made to obtain lamps of the same principle that are more suitable.

"The question of synchronism, of keeping the disks of the transmitting and receiving sets running exactly together, Mr. Jenkins says, is a simpler problem in radio vision than in radio transmission of pictures. The pulleys used are conical and the speed of the disks can be regulated by sliding the belt slightly to such a degree that synchronism can be obtained more easily than the picture is framed in ordinary motion-picture projection today. In the experimental set that was demonstrated, disks of both the transmitting and receiving sets were driven from the same motor for the sake of simplicity in operation.

"The transmission of pantomime by radio has been accomplished. There is no reason why the receiver should not have been in New York rather than in Washington next to the radio-vision transmitting set.

"The perfection of the invention has not yet reached the point where actual scenes in all their lights and shadows can be reproduced or motion pictures distributed to the hearth and home. But the experimental apparatus devised by Mr. Jenkins gives promise eventually of our being able to see in New York at nine o'clock in the morning what 'will occur' the same afternoon at two o'clock in London.

"Mr. Jenkins simply moved his hand and fingers when he made his demonstration. With those moving shadows radioed on the screen, I could hardly re-

frain from hoping that he would form a shadowy rabbit or bird with a long neck or some other strange animal such as all of us have made or seen for the amusement of children. Tony Sarg and his marionettes might well produce pantomime by radio vision when the process is slightly perfected.

"In fact, it is a hope of Mr. Jenkins that he will be able to devise a low-priced piece of apparatus that will take pantomime entertainment into the home just as bedtime radio stories now are received with so much glee by eager childish ears."

Closely allied with the subject of radio movies is that of talking movies, for both these engineering feats are made possible with the aid of the little vacuum tube, a device that is accomplishing more marvels than the author of "Arabian Nights" could have dreamed of. The future will no doubt not only bring radio moving pictures alone but the added feature of talking will also be possible. Lee De Forest, whose active imagination and untiring efforts gave the world the vacuum tube, has applied it to talking moving picture and in the paragraphs that follow he describes his new system in his own way:

"Talking movies are an accomplished fact. Perfect synchronism of speech and action has been attained, and this success is another triumph for that wonder worker of radio, the audion amplifier. The talking movie depends upon the use of the tubes to amplify the minute electric currents with which it is necessary to work and it is no exaggeration to say that the vocalization of the motion picture would never have been accomplished at all were it not for the fact that the motion picture technicians had available to them the perfected inventions of the radio engineer.

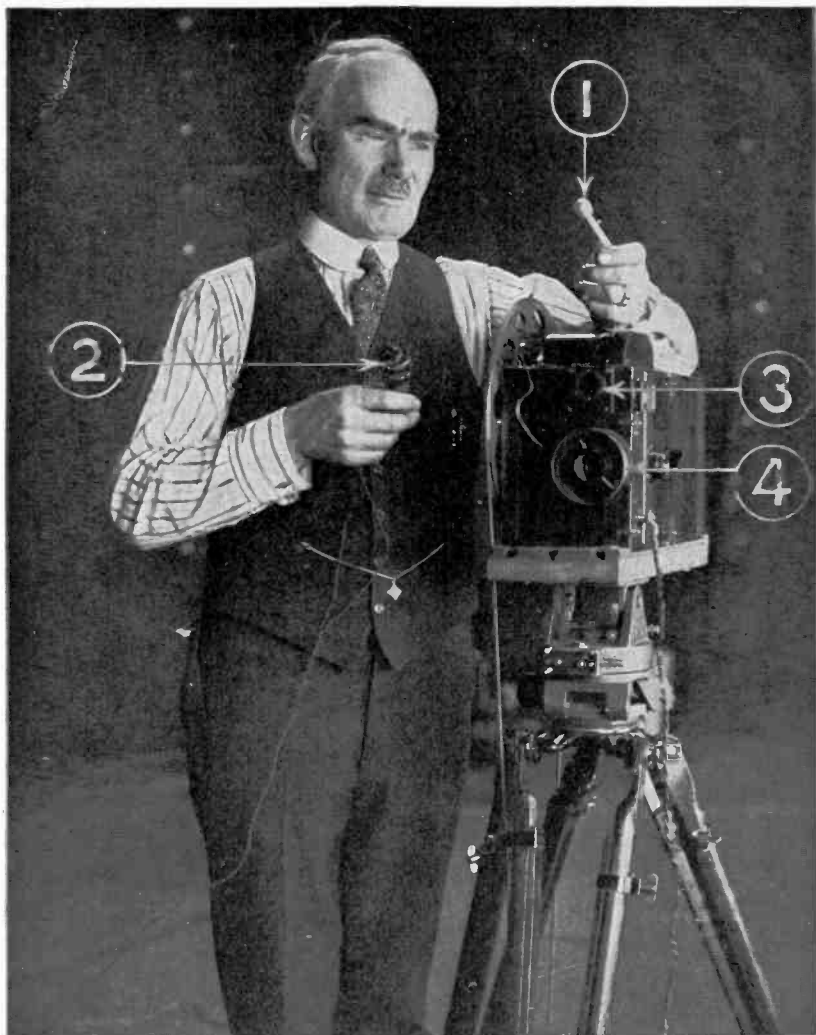

THE CAMERA THAT RECORDS BOTH ACTION AND SPEECH

Figure N3: Dr. Lee De Forest is here demonstrating his new and remarkable invention. He is inserting the "photion" (1) into its proper socket. This photion (coined from the words "photograph" and "audion," meaning literally an audion that takes photographs) is the secret of the phono-film machine. The microphone that receives the voice is shown at (2); the opening (3) leads into the chamber that contains the apparatus that converts sound into light waves. (4) is the regulation shutter equipment used on every motion-picture camera. The records of both motion and sound are thus recorded on the photographic film.

"The earlier attempts at talking movies, fiascoes which we all remember so well, depended upon schemes for connecting together an ordinary phonograph and an ordinary motion picture machine. The phonograph was supposed to repeat a certain sound at the exact instant that the appropriate action took place on the screen. To make the two machines run precisely at the same rate there were complicated arrangements of governors and regulators. In one of the processes, for instance, small holes were punched at intervals in the film. Compressed air escaped through these holes much as it does through the holes in the paper roll of a piano player and this escaping air was supposed to regulate the speed of the phonograph so that it would play its record at a rate exactly equal to the rate of progress of the film.

"None of these devices worked very well. Not only were there delicate mechanical or electrical adjustments which frequently got out of order, but there was another difficulty, one which would be entirely unforeseen, probably, by anyone not actually experienced in the motion picture business. This was the disturbance of the record caused by breakages of the film.

"Once in a while when you are watching the pictures in a motion picture theater you will see the picture suddenly disappear, leaving a blank white screen. This means that the film has torn in two. The young man in the projection room does a little fast work and presently the picture goes on again as though nothing had happened. But before that particular film can be used again its torn ends have to be trimmed off so that they are even and then stuck together again with film cement. This makes the film an inch or two shorter than it was before.

"So far as the picture is concerned, this shortening makes no great difference. There are sixteen separate snapshots to the foot of film and the loss of one or two of them is not even perceptible when the film is projected. But suppose that the film is one which has been carefully synchronized with a phonograph record. If you leave out an inch or two of film the sound record gets behind the action by just that much. After three or four breaks have been made and fixed you will hear the sound of a fall, for example, a second or two after it has really happened. It will sound like an echo.

"It is not possible to avoid occasional breakage of the film and this was the reason why experienced motion picture engineers were always rather skeptical of any scheme for mechanically synchronizing films with phonograph records. What was needed, they thought, was some way of recording the sound record on the film itself so that the sound record and the sight record would be synchronous and inseparable automatically.

"This is exactly what the new talking movies are. In my process, for instance, which I call the 'Phonofilm process,' the record of the sounds is registered in the form of a narrow strip of lighter and darker hairlike lines running crosswise, at the edge of the film, like the rungs of a tiny ladder. This record is produced at the same time that the pictures are taken, by a photographic process. When the film is run off these sounds are reproduced.

"The 'photographing of sounds' is new only in details. Scientists have been photographing sounds for many years and by half a dozen different processes. The beginning of the story takes us back to 1879 and to Dr. Alexander Graham Bell, the inventor of the telephone.

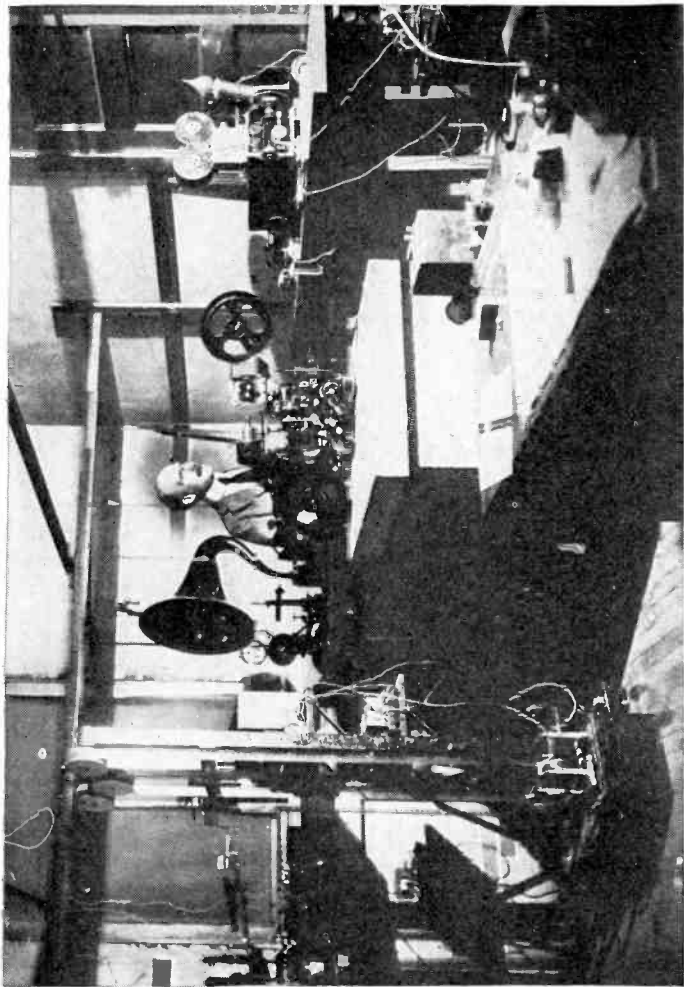

THE LABORATORY OF A DOCTOR WHO IS A "VOCAL SPECIALIST" ON FILMS

Figure 08: The workroom of Prof. J. T. Tykocner, of the University of Illinois, who has developed a talking motion picture film that uses a special shutter actuated by sound waves instead of the moving mirror or phonion on which Dr. De Forest's invention depends

"When Dr. Bell was working out the telephone he gave a good deal of attention also to other ways of transmitting speech. Perhaps the telephone might turn out a failure and some different device might have to be substituted. Among other things he tried out a way of talking along a beam of light. One day in 1879 he stood in his garden and actually talked for over two hundred yards along a beam of sunlight reflected from a little mirror which he held in his hand.

"The secret was in the mirror. It was made out of very thin glass and it was not perfectly flat. Instead it had a slight spherical curvature as though it had been cut out of the side of a very large globe of glass. The beam of light was reflected from this curved surface.

"Back of the mirror was a mouth-piece into which Dr. Bell spoke so that the sound waves of his voice struck against the back of the mirror. These waves made the mirror vibrate just as the diaphragm of a telephone vibrates when you speak into it. And when the mirror vibrated its curvature changed, it became alternately a little flatter and a little more curved. This affected, of course, the amount of light reflected from its front surface. The beam of light fluctuated in strength and these fluctuations were found to correspond exactly to the sound waves, which were beating against the back of the mirror-diaphragm, just as the electric currents in a telephone transmitter correspond to the sound waves which strike against its diaphragm.

"Dr. Bell's device was really a telephone in which a mirror took the place of the usual transmitter and a ray of light took the place of the electric current in the wire.

"In 1879 there was no particular use

for such a device. The motion picture was still a dream. The electric telephone proved to be successful and the light-telephone—Dr. Bell called it a photophone—dropped out of sight. He did not attempt to photograph the sound waves.

"But might not such a device have its use in war? The Germans thought so and in 1890 they financed the investigation of one Ernst Walter Rühmer on this same problem.

"Rühmer did not use a mirror. He selected a totally different principle, the principle of the electric arc. He used an ordinary old-fashioned arc lamp, in the circuit of which was a microphone. When he spoke into the microphone, the sound waves affected it and it, in turn, affected the brightness of the arc; producing fluctuations which corresponded, as in Dr. Bell's device, to the pulses of the sound. This fluctuating light from the arc Rühmer sent out in a searchlight beam miles across the country to a receiving station where its pulses could be converted back again into audible sound.

"During the war the Germans revived and improved this old method of Rühmer's. An apparatus devised by Dr. H. Thirring is said to have been in use at times on the Western front. Many a searchlight beam watched incuriously by our scouts as of no importance may have been carrying light-borne words which our intelligence department would have enjoyed hearing. But Dr. Thirring's work was not known until after the armistice and the possibility that a photophone was being used went unsuspected.

"The British Admiralty, however, were working along similar lines, though for a different purpose. They were seeking a method of telephoning between

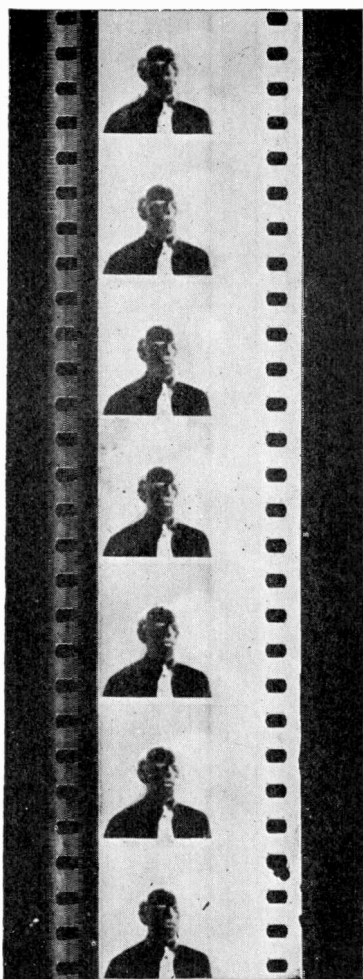

A STRIP OF TALKING FILM
(Actual Size of Negative)

Figure P3: This negative was made by Dr. De Forest's new phonofilm process. The hairlike lines at the right of the strip of sprocket holes on the left is the record of sound. During projections, a beam of light passes through this record onto a photo-electric cell and converted first into an electric current, amplified by vacuum tube amplifiers and finally reconverted back into sound by means of a loudspeaker.

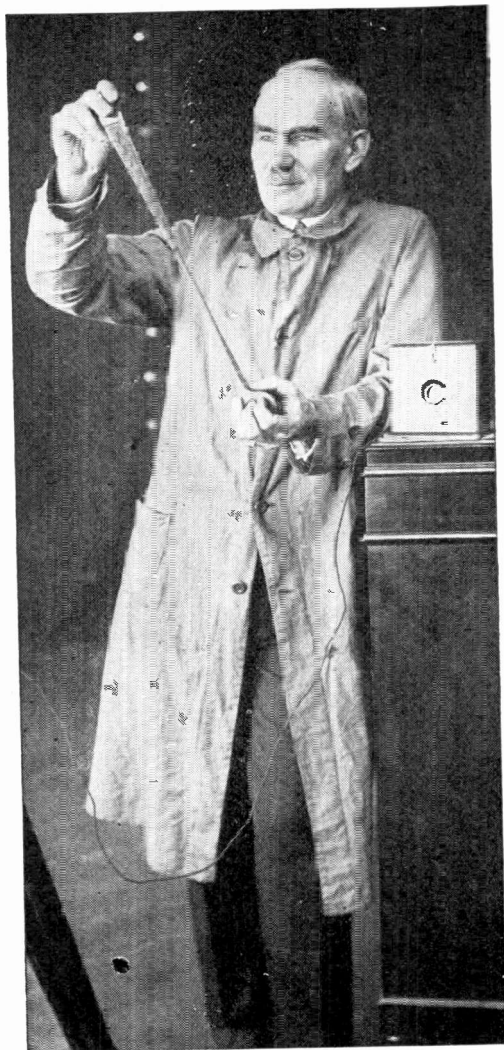

A SCIENTIST WHO UTTERS SPEECH THAT WE CAN SEE

Dr. De Forest—best known to radio fans as “the man who put the grid in the radio bottle,” or in more scientific terms, the inventor of the audion or three-element vacuum tube—is here revealed in his laboratory inspecting a motion picture film that records both the movements of his lips while speaking and also the sounds that issue from them. Long before the advent of the vacuum tube, however, Dr. De Forest was experimenting with “wireless” telephony; many old-timers among the radio amateurs of New York recall the thrilling experimental days when his squeaky and distorted voice-tones, transmitted by arc and high-frequency spark telephones, filled the ether with early promises of the marvels that were to come. The square box at the inventor’s elbow, with the small circular opening, contains the new type of microphone especially developed for the talking films.

ships at sea. Dr. A. O. Rankine, the distinguished physicist who conducted their investigations, did not use the arc method. He used a vibrating grating attached to a diaphragm, like that used years before by Dr. Bell and was so successful that he was able to talk for a distance of eight miles over a beam of sunlight only six inches in diameter. The familiar heliograph used in all armies and navies to exchange dot-and-dash signals by means of a beam of sunlight became capable of serving as a telephone as well.

"None of these things had any immediate application to the movies. Even in 1918 no one seemed to see that these new war inventions contained the answer to the old problem of how to make the movies speak.

"The first person to see this connection, or the first, at least, to actually make it effective, was Bergland in Sweden. Early in 1921, he exhibited to a group of scientific men a machine in which sound was recorded by means of a moving spot of light reflected from a tiny mirror. Sound waves were made to vibrate this mirror, and the mirror vibrated just as Dr. Bell's mirror did, but it was arranged so that the vibration took the form of back-and-forth swings instead of changes in curvature. These swings made the little spot of reflected light move back and forth across a moving photographic film, and the result was a wavy line photographed on the film. The waves in this line, the ups and downs of it, were found to correspond exactly to the pulses of the original sound. From this line the sound could be reproduced.

"According to the published descriptions of it, Bergland's original machine was merely a sound recorder. It produced a record of sound just as a phonograph does but it recorded this on a

strip of photographic film instead of a disk or cylinder of wax. In applying his invention to the making of a talking motion picture Bergland used two films side by side. One film received the picture just as it does in an ordinary motion picture camera. The other film received the wavy line which was the sound record. As the picture was taken the two films were moved forward by the same shaft. In this way, Bergland undertook to obtain exact synchronism between the two films.

"But it is reported that he did not. Motion picture film always shrinks and changes a little as time goes on. Separate pieces of it do not always shrink equally. Then the holes in the margin of it, into which fit the teeth of the sprocket arrangement which moves the film, sometimes wear a little larger, so that the motion of the film is not quite uniform. These difficulties and others like them, it is said, interfered with the perfect agreement of Bergland's two films. It was necessary, or highly desirable, to put the two records actually on the same single strip of film.

"Even while Bergland was working in Sweden this last step was being taken by another inventor in England. Only a few weeks after the Bergland tests Mr. Grindell Mathews announced the perfection of a camera which photographed the wavy line of the sound record and the successive pictures of the scenic record actually on the same film. The sound record was made in the same way as the Bergland camera, by means of a tiny mirror swung back and forth in correspondence with the waves of sound.

"This gave to the world for the first time a process in which the sound and the picture could not help being synchronous, since both of them were recorded on the same film strip.

"It might seem that not much could be added to this but in developing the phonofilm we have succeeded, I think, in improving in at least two particulars any of the previous processes for a

speaking film. The first of these improvements is what we believe to be a better way of photographing the sound. The second is an improvement in a part of the apparatus which I have said noth-

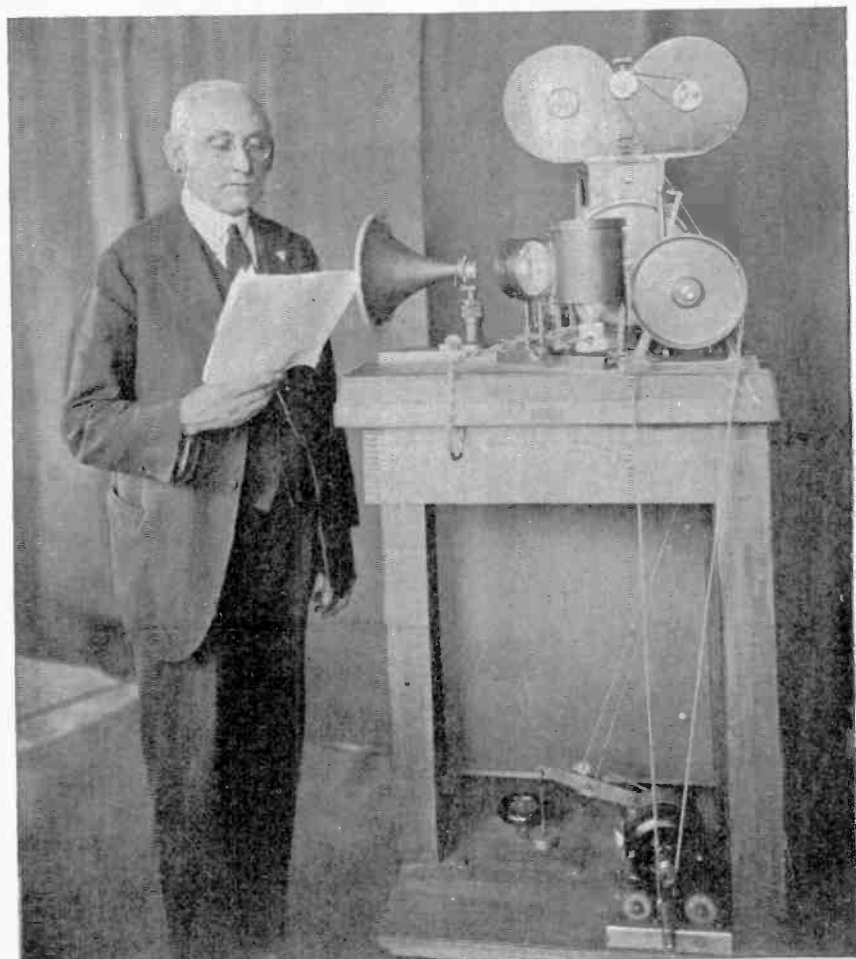

General Electric

HE PRODUCES SOUND BY MEANS OF A VIBRATING MIRROR

Figure 98: What is in effect a motion picture photograph of the human voice, reproduces in the form of a graph that records vibrations, is the invention of Dr. Charles A. Hoxie. His machine is called the "Pallephotophone," and it not only "photographs" sound but reproduces it with most amazing clarity and power.

ing about so far, the part which translates the sound photograph back again into real sounds which we can hear.

"If you look inside the camera which we use in taking the phonofilm the only unusual thing you will see is a small glass tube about the size of your little finger. When the apparatus is operating, this tube glows with a brilliant violet light. It is the new invention, which we call the 'photion.' It is the thing which we use to photograph sound.

"The tube contains a special mixture of gases which it took me over three years of experiment to perfect. When an electric current is passed through the tube, this gas mixture becomes luminous. It is the gas which produces the violet glow.

"Perhaps you have seen lately some of the neon-filled glow lamps which are being used to attract attention in stores and shop windows. A tube of bent glass, often shaped into words or letters, contains a little of this neon gas, about one thousandth of one percent of which is contained in ordinary air. When a high frequency electric current is sent through this neon-filled tube, the gas glows with a soft reddish light which is pleasant and attractive. The photion works on much this same principle. Of course, the gas in it is not neon and the glow is violet, not red. But it, too, is a gas glow excited by an electric current.

"If you watch carefully the glow of a photion in operation you may be able to see that the light is not absolutely constant. It flickers a little. Pulses of greater brightness alternate with brief instants when the glow is a trifle dimmer. This means that the photion is translating sound into light. The rapid flickers and pulses which you see mean that you are literally seeing speech.

"The photion tube is excited by a

high frequency electric current, modulated by the voice in exactly the same way as in a small radio-telephone transmitter. This part of the apparatus is in fact identical with the radiophone transmitter.

"In the electric circuit which operates the photion and which causes it to glow we insert a highly special substitute for the microphone and one or more vacuum tubes as amplifiers. This ground receiver picks up sound waves and converts them into pulses of electricity. The electric pulses, after being amplified sufficiently, control the radiophone which is exciting the glowing photion and affect its light. The flickerings of this light, its rapid brightenings and dimmings, correspond exactly to the waves of sound which enter the microphone.

"This shows you how the phonofilm process transforms sounds into light; but how does it photograph them, how do we secure a permanent record of them on the motion picture film?

"This is how. The glowing photion is in a little chamber by itself inside the camera and this chamber is light-tight except for one tiny slit only one millimeter long and a fortieth of a millimeter wide. The moving film on which the motion picture is being taken runs past the photion chamber in such a position that the edge of the film passes just under this slit. The light from the photion streams through the slit and is photographed on the film, making the strip of tiny hairlike lines already described; a darker line for each instant when the photion is brighter, a less dense line when the light of the photion is a little more dim.

"This little ladder of lighter and darker lines is our photograph of sound, our answer to the problem of recording



THE FIRST MAN TO TRANSMIT SOUND ON BEAMS OF LIGHT

Back in 1880 Dr. Alexander Graham Bell invented the "photophone," by means of which speech was transmitted 200 yards on a ray of sunlight reflected from a curved mirror. In the picture above the good doctor is revealed as a diving Bell; it was snapped while he was emerging from the Williamson submarine tube in the West Indies, shortly before his death.

successfully both the sight and the sound. The width of the sound photographs is always the same. The *intensity* of the light, and that alone, is varied by the sound. This feature distinguishes the phonofilm from all other methods, and permits a more faithful reproduction of every light and shade of sound than is otherwise possible. And by this photion or phonofilm method, it is seen, there is complete absence of any mechanical moving parts, nothing in the entire system up to the final diaphragm of the loudspeaker which can introduce a natural period of vibration of its own, tending to distort the original sound, in recording or in reproduction. So far as the taking of the movie is concerned, this is the whole of the story.

"But how is one to get this back into real sound again? How is the sound record on the film to be reproduced when the motion picture is run off in the theatre?"

"Consider first what the problem is. The taking of the talking motion picture involved two successive conversions of one kind of vibration into another kind. First the waves of sound were converted into electric waves by the microphone. Next the electric waves were converted into light by the photion. Now we must do these same two things in reverse order. On the finished film is our little ladder of darker and lighter lines. A ray of light can be made to shine through this ladder and the strength of the light that gets through will correspond to the

lines on the ladder. As each dark line passes across, the light transmitted will be momentarily dimmer. This gives us, to start with, what we finished with when the movie was taken, namely, a light which flickers in exact correspondence with the waves of sound. The problem is to convert these flickers back again into real sound.

"Most of the previous investigators and inventors have made this light-sound conversion by means of the metal selenium, a metal which has the property of changing its electrical resistance when light rays fall on it. But no one was satisfied with selenium. It was too erratic and undependable, too slow in recovery.

"Years ago the same Dr. Hertz who discovered the waves now used in radio made another discovery. He discovered that plates of certain metals gave off electrons when they were illuminated. Every radio fan knows that the filament of a vacuum tube gives off electrons when it is hot. Dr. Hertz's metal plates did the same thing, only they did not have to be hot. All that was necessary was that light of some kind should be falling on them. This discovery was the beginning of the photoelectric cell.

"In modern forms of the cell, the metal plate which is to give off the electrons is in a vacuum inside a sealed glass bulb. It looks a good deal like a glass egg with two short glass tubes about the size of lead pencils sealed into it, one at each end. The light shines into this egg from one side. On the other side, facing the light, is the plate of the sensitive metal, usually of the rare metal potassium or the still rarer one, rubidium.

"When hit by the light the metal gives off electrons and the number given off a second changes with the strength of the light. The more light, the more elec-

trons. You see at once what the pulsating light which shines through the sound record on the film will do. It will cause the electron emission inside the photoelectric cell to pulsate also. More or fewer electrons will be given off in exact correspondence with the sound waves which were originally photographed on the film.

"This makes the first of the two conversions which we saw to be necessary, the conversion of the light pulses into electric ones. The next conversion, the one into real sound, is made in the usual fashion by amplifier tubes and a special telephone. The electron current in the photoelectric cell is feeble, but even one tube will amplify it until it will operate a telephone. Four or five tubes will make it strong enough to operate a loud-speaker and fill the largest motion picture theatre.

"This gives you the whole process. Suppose we are taking a motion picture in which, let us say, Buster Keaton falls downstairs. For each step there is a bump and the sound wave of each bump makes a little flicker in the glow of the photon. This flicker records itself on the little ladder of lines which is being photographed on the film. Wherever that film goes, whatever is done with it, there is the record of Mr. Keaton's bump side by side with the view showing just how he came to make it.

"Then some day the film is shown in a theatre. The light of the projection machine shines through one of the pictures and shows a visual image of Mr. Keaton's downfall. At the same instant another light shines through the sound record. This light sees, so to speak, the sound image of Mr. Keaton's bump. It carries this image on to the photoelectric cell. The cell instantly transforms it into an electron image of the sound of

the bump and hands this on to the audi-on amplifier. The amplifier strengthens it into a greater sound and hands it on to the loudspeaker which lets out, in its turn, a loud bang and we who sit, watching and listening, hear the misfortunes of Mr. Keaton at the same instant that we see them.

"And at *exactly* the same instant! For all these changes and conversions happen with almost inconceivable rapidity, with the speed of electric currents which come close, most of them, to the 186,000 miles a second which is the speed of light.

"From the special viewpoint of the radio engineer there is one particularly interesting aspect of these various conversions of vibrations between light and sound and electricity. It is that they constitute a kind of modulation just like the modulation of continuous waves of radio telephony by sound waves.

"Light is, of course, an electromagnetic wave just like the radio waves except that its wavelength is very much shorter, or, in other words, its frequency is tremendously higher. Instead of the frequency of about 800,000 a second which characterizes the ordinary broadcasting wave, light has frequencies measurable only in quadrillions a second, wavelengths defined in millionths of a millimeter.

"Now in ordinary radio telephony the modulation consists merely in superimposing the low frequency waves of sound, which have from 20 to about

5000 vibrations a second, onto the moderately high frequency waves of the continuous wave radio. The sound wave goes out, one might say, as a passenger on the radio wave. Similarly, in the phonofilm, the function of the photon is to superimpose these same low frequency waves of sound first onto the higher frequency waves of the radio telephone and then onto the still higher frequency waves of light. The passenger is the same but is traveling on a different train, a train of much shorter cars. In ordinary radio modulation we speak of 'audio' frequency and 'radio' frequency. In these new light conversions we must speak of audio frequency in relation to what we may call 'photo' frequency, this being the tremendously high frequency of the waves of light.

"And just as there are various ways of producing the modulation of radio frequency by audio frequency, so there are various ways of superimposing sound waves on light. The photon is one of these ways. The mirror methods of Dr. Bell and of Dr. Rankine are others. The arc method of the Germans is still another. And two other methods, two newer ones, have been announced within the past year in the United States.*

"And now what does this mean for the movies? Granted that a real talking movie can be produced about which there now seems little doubt, will this cause any serious change in the present methods of producing motion pictures and of presenting motion picture plays?

*One of these methods is that of Professor J. T. Tykociner of the University of Illinois. This, too, has been applied to the making of talking movies. In place of the moving mirror or the photon, Professor Tykociner uses a special mercury arc lamp. The light of this lamp, modified in intensity by the vibrations of the sound, falls onto the moving film, where it is photographed to make a strip of shaded lines not unlike the record on the Phonofilm.

The other new method has been announced by Dr. Charles A. Hoxie of the Research Laboratory of the

General Electric Company. His device appears to depend on a moving mirror, which would make it an improved form of the method used by Bergland in Sweden and by Mathews in England.

In all of these methods, the curved mirror of Dr. Bell, the arc of Rühmer and Thirring and Tykociner, the shaking mirrors of Rankine and Bergland and Mathews and Hoxie, and in the photon, the result accomplished is the same. It is the superposition of an audio frequency signal on photo frequency waves of light.—Editor.

"The motion picture experts do not agree in their answers to these questions. Most of them seem skeptical. They do not expect, they say, any immediate public favor for a talking movie no matter how perfect it is. The reason they give is a psychological one.

"The essence of a successful motion picture, they say, is their ability to create an illusion. The images on the screen do not look exactly like the actors. They are just a jumble of black and white masses and lines and dots. Our favorite stars look lifelike to us because we have become used to this. We recognize the lights and shadows of the screen as symbols, much as the multitude of little black lines and dots and curves on this page are recognized by you as symbols of letters and words and thoughts. This page would not be so recognized by a savage who did not know the symbols of our alphabet.

"And without illusion of reality which the mind makes for itself out of the symbols on the screen, motion pictures would have, these experts believe, much

less interest and emotional appeal

"Now suppose you combine these visual screen symbols with sounds. The sounds are symbols also. They too must create their illusion. Will they reinforce the eye symbols or will they interfere with them? Most likely, say the skeptics, the result will be interference, not reinforcement. It is easy, they think, to create one illusion at a time, either an eye illusion or an ear illusion. It is much less easy to create both at once and to have them fit into each other in the mind. And so, they think, the path of progress for the talking movie is not going to be altogether smooth.

"Perhaps not, but this is little likely to deter inventors from following it. We believe that we have already in the Phonofilm a device of great utility in scientific investigations and in the making of speech records side by side with pictorial ones, for instance in making records of important events. Whether the motion picture experts will adopt it for purposes of public entertainment we are content to leave to them—and to the future."

END OF SECTION XVII