

# ACTUAL TROUBLES IN COMMERCIAL RADIO RECEIVERS

1927 — 1934

By

**BERTRAM M. FREED**

Co-Author of Radio Servicing Course  
Member Society of Radio Technicians



SECOND PRINTING

1934

Published By

**SERVICEMEN'S PUBLISHING CO.**

136 Liberty Street

New York, N. Y.

Printed in U.S.A.

Copyright 1934



# AIREX RADIO CO. Inc.

Since 1921 we have been supplying thousands of servicemen and dealers with the replacement parts needed in their repair work.

Our catalog is free for the asking, if you will send along your business card or letter head with your request.

Possibly you received our latest catalog but have lost or mislaid it—we will be pleased to send another copy.

Be sure to consult our current issue. It is crammed with Bargains. Greater values than ever before.

THE AIREX CO., Inc.

WE DO NOT SELL RETAIL

78CORTLANDT ST. NEW YORK N.Y.



## Let Sprayberry Help You Build a **BETTER SERVICE BUSINESS**

### "READ WHAT OTHERS SAY"

"I like your instructions more than any thing I have seen yet as they are so practical and not crammed full of theoretical stuff that is of no real value."

C. D. Thompson,  
207 E. Walnut St.,  
Troy, Ala.

"I admire your honesty in advertising your Course as a highly practical post-graduate Course for servicemen instead of promising immediate and immense wealth."

Jim Kirk,  
3871 Edenhurst,  
Los Angeles, Calif.

"I think your Course is just the thing I have been looking for, as it condenses all the information wanted without useless theory."

Joseph Pazdernik,  
Mary & Case St.,  
Bessmer, Michigan.

If a recognized authority told you he could save you time, money and help you to a better, more profitable service business, you'd surely spend the price of a stamp to learn the facts. And that is exactly what F. L. Sprayberry is telling you now. His **ADVANCED TRAINING SYSTEM** covers **EVERY TYPE** of servicing. No bunk—a bare minimum of theory—no mathematics—no fancy and costly bindings. Not written for beginners, but for practical servicemen who realize the necessity for learning the easiest way of doing complicated jobs and of keeping abreast of the many new radio developments. A complete course that actually tells you exactly how to do the jobs—and at a low price that will amaze you.

## Only \$15 Will Bring You All Of This . .

From **SET TESTING** with analyzers to the complex point-to-point method, nothing has been overlooked. Lessons cover super-het circuits, AVC, public address, **AUTO RADIO**, practical methods for **TESTING ALL PARTS**, locating and eliminating all types of trouble—AND a special section on **TUBES** and another on **SET ANALYZERS** including information on repairing and modernizing all types. Here in one easily understood, compact course, you have **ALL** the dope. You save hours of reading in scattered sources—you save time and money by being able to do jobs better and quicker. Moreover, for a slight additional charge you can get additional personal instruction, including criticism, answers to questions, etc., from Mr. Sprayberry himself.

**WRITE FOR DETAILS!**

# **F. L. SPRAYBERRY**

132 BRYANT ST., N.W.  
WASHINGTON, D. C.

## WE NEED YOUR COOPERATION IN THE PREPARATION OF OUR SUPPLEMENT

The publishers are keeping in close contact with some of the large servicing groups regarding new material for the SUPPLEMENT. To properly select the "Actual Troubles" found in radio receivers, we must examine the records of thousands of service calls to find "those unusual troubles and symptoms which are not easily disclosed with the aid of a set analyzer." We must ask the cooperation of the more experienced of you servicemen to aid us in making this supplement as large and as complete as possible.

Most of you keep records of your service calls. By re-copying them for us, not only will you be performing a service to your fellow workers, but you may acquire prestige and reputation—with its resultant assurance of financial remuneration—that many of our radio-writers now enjoy.

Even a brief description will do—for example:

Amrad 7100—fading—caused by audio transformer leads shorting to chassis at the holes—remedy, insulate the wires.  
Majestic 90—noisy tuning—caused by worn carbon element of the equalizer—remedy, replacement.  
Peerless Ceurlier 65—noisy and weak reception—caused by open-circuited or leaky .00035 mf. bypass condenser across the split primary of one of the R.F. coils—remedy, replace condenser.

You receive **full credit** for this information—your name and address appearing on all copy accepted by us for publication—and for which **we pay regular authors' rates**. All contributions will be edited by the author of "Actual Troubles"—**Bertram M. Freed**.

No charge is made for the supplement—fill out the card in the back of the book.

THE PUBLISHERS.

## P R E F A C E

This book has been prepared for the express purpose of placing before the service man and those engaged in radio service and repair, those troubles *actually encountered* with a number of the more popular radio receivers, over a period of several years. Only those troubles not easily disclosed with the aid of a set analyzer, and many that cannot, have been discussed.

Knowing beforehand the symptoms and effects of common and unusual receiver failures, makes possible the more rapid and efficient repair of radio receivers. It is the *recognition* of these failures by the *symptoms* displayed during operation that enables correct diagnosis and speedy repair.

In most instances, these failures have been occasioned through natural causes, such as deterioration resulting from operation over long periods of time, etc., and not due to poor design on the part of receiver manufacturers.

Grateful acknowledgment is given to Mr. David Sack of Davega-City Radio Corp. for his permission in giving the author access to the service files for his past service records. The able assistance of Miss Dorothy Kramer has contributed greatly toward the preparation and compilation of this work.

Feb. 2nd, 1934

BERTRAM M. FREED

# ACTUAL TROUBLES In Commercial Radio Receivers

## Amrad 7100

The Amrad "Nocturne", one of the 7100 models, has furnished several causes for fading which, although not unusual, may take some time to locate. A common cause can be traced to the fuse block which is fastened to the side of the cabinet. The fuse clips become corroded with time and lose their tension, resulting in poor contact. Because of the fact that the dial is black, with white figures, the flickering or dimming of the pilot light caused by the poor contact of the fuse clips will not be apparent. To clean and bend up the clips takes only a moment or two, and may prevent a repeat call.

Although fading may be due to loose element tubes or a "poor weld" 27 detector tube, most complaints of this nature have been traced to the audio transformer leads which pass through holes in the chassis to the terminals mounted under the chassis. Strain and vibration cause these leads to short to the chassis, as the openings are just large enough for the leads to pass through. The quickest method of determining this failure, is that of pulling and moving the leads while the set is in operation. At times, the fading is due to the transformer winding or leads, shorting to the shield can internally. This may be repaired quite often by heating the entire unit so that the wax compound may flow and insulate the shorted winding or lead from the shield can.

Hum has many times been found to be caused by an open 227 center-tapped filament resistor or a 227 with poor cathode-heater insulation. This latter condition may not be revealed on a tube-checker and therefore it is advisable to substitute with another tube.

The particular type of hook-up wire employed in these models, due to heat and moisture often is the cause of an inoperative receiver or one that operates intermittently. The insulation cracks and peels, and as most of the leads are cabled, short-circuits occur. The only remedy in this case is rewiring.

### Atwater Kent 37, 38

The most common cause for complaint with the Atwater Kent 37 probably is "shot" filter condensers. As these condensers are connected internally to the chokes in the power pack which consists of two sections, the power transformer block and the filter block, the problem of the best method of repair arises. At the time these sets were considered the "last word" in radio receivers, the cost of a new filter block was high, because only the original could

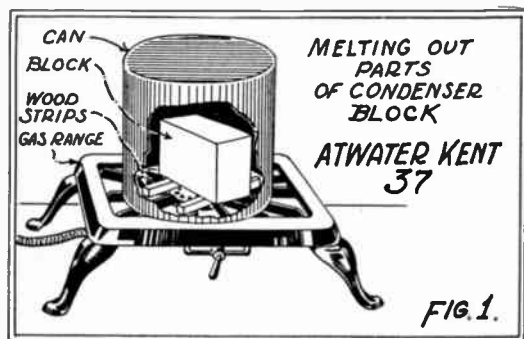

be obtained and that from the manufacturer. However, today, these or replacement blocks can be obtained quite readily and at most reasonable cost. There may be some Service Men, however, who prefer to repair these blocks. This can be done quite easily.

After the defective unit (the block) has been removed

— NOTES —



from the pack, it may be inverted upon two strips of wood in a can as shown in Figure I and heated in an oven or over a gas flame. The heat will soon melt the pitch used as a sealing compound, and if care is taken, the filter choke and output choke and small condensers may be saved as they fall out. After the can has been cleaned, all necessary parts are replaced, together with the salvaged parts, and melted paraffin or other insulating compound may be poured into the assembly to complete the job.

Another frequent and common failure in this receiver is due to a shorted or leaky output speaker condenser. When this condenser is shorted, the receiver will be inoperative. A leaky condenser however, will produce the symptoms of choky or muffled reception similar to that obtained when an output stage is operating without grid bias. Although this condenser may be replaced, a repair may often be affected by disconnecting the leads to the speaker condenser and applying high voltage to the terminals. The high voltage source may be that secured across the plates of the rectifying tube or that obtained from some external power supply. The condenser should be sparked with the voltage several times and then tested. If the condition is the same the sparking should be continued. Should the shorted or leaky condenser fail to heal after a few minutes of this process, it should be discarded.

Another cause for choky, distorted and weak reception is caused by an open detector plate resistor. This resistor is of the grid leak type and fits into clips located beneath the terminal strip of the power pack. Its value is approximately 100,000 ohms. The failure of this resistor is usually due to poor contact of the Wood's metal ends to the resistance element. If a hot soldering iron is applied to the Wood's metal for a brief instant, so as not to melt the solder entirely, it is possible to repair the resistor. This failure will be readily disclosed by the lack of plate voltage on the detector tube, the primary of the audio transformer usually being suspected.

— NOTES —

Intermittent reception on these models is caused by loose nuts holding the receiver cable strip to the power pack terminal strip.

A cause for noisy and intermittent reception lies with the volume control. The resistance element in this volume control is a flat tapered wire-wound affair which is bent to fit within the volume control housing. In cases of noisy reception, if the resistance wire has not been broken or has not shifted too much, it can be repaired with the aid of a piece of fine sand paper. The movable contact arm should also be carefully cleaned and freed from oil and grease. An application of Nujol to the resistance strip will assist matters greatly.

### **Atwater Kent 40, 42, 52**

A leaky speaker output condenser in these models, as in the case of the models 37, 38, is often the cause of choky and distorted reception. In some cases where the condenser is short-circuited, no reception will be obtained.

The volume control in these models is the same as that used in the 37 and 38 models and will cause the same complaint. The treatment described for the latter models also applies to the unit employed in the models under discussion.

### **Atwater Kent 41, 51 (DC)**

The most common complaint with this model is poor selectivity and low sensitivity. Generally this is due to poor alignment of the tuning condensers, which may be aligned by loosening the two set screws holding the shaft to the belt pulleys. Extreme care must be taken in following this procedure for, of course, while this is being done the receiver is operating, and if any of the stator plates are accidentally grounded with the screw-driver, one or more tubes may burn out, and possibly a grid suppressor.



**TO IMPROVE RECEPTION**  
insist on  
**CHAMOIS FREE EDGE CONES**

The Type Used On  
**R.C.A. PHOTO PHONE and**  
**WRIGHT-DECOSTER SPEAKERS**

**LEOTONE RADIO CO.**

63 Dey Street

New York

If after the receiver is placed in perfect alignment, and the sensitivity or selectivity of the receiver still does not meet with expectations, the small resistor in the plate circuit of the 1st R. F. amplifier, which is located near the tube and the antenna coil should be shorted out of the circuit. This resistor is of the grid leak type and fits into clips provided for it. Removal of the resistor from the plate circuit of the R.F. tube increases the plate current bringing the receiver close to the point of oscillation.

Should the condition be encountered, where the tubes, in this model, fail to light up, the first thought is a burnt-out tube because of the series filament circuit. Although this is usually the case, where it is found that the tubes have tested correctly and that the current supply is available at the receiver, the probability is, that one or both of the R. F. chokes in series with either side of the line has open-circuited. These chokes are wound on small composition bobbins and are located beneath the terminal strip in the power pack. They may be easily repaired by rewinding the bobbins with No. 22 cotton or enamelled wire. A diagram showing the connections may be seen in Figure 2.

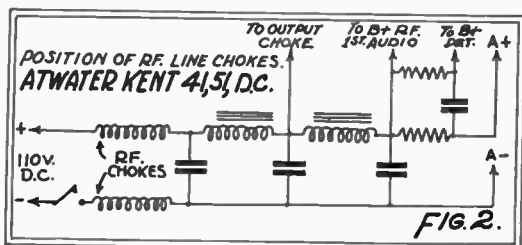

Hum upon resonance in these models is caused by an open circuited detector or R. F. filament bypass condenser. This condition may be checked by shunting each of these units with a .1 mf. or a .25 bypass condenser.

### IMPORTANT

When Replacing Burnt Out Field Coils Make Sure You Purchase A Field Wound On A

**LEOTONE BOBBIN**  
MOUNTED ON BAKELITE  
NOT PAPER

**LEOTONE RADIO CO.**  
63 Dey Street New York



### **Atwater Kent 43, 46, 47, 53**

Intermittent reception is a complaint often received on these models. Trouble of this nature may be caused by any part in the receiver and is therefore, difficult to trace. However, the difficulty has been found to be due most often to an open-circuiting voice coil of the dynamic speaker. The open circuit will be found in most cases, in the leads running from the frame of the speaker to the coil. These leads are soldered to the ends of the voice coil and are glued to the cone, being held more solidly by a strip of transparent adhesive tape which covers the soldered connection. Vibration of the cone causes the soldered joint to break, resulting in an open circuit and producing the effect of intermittent reception. The remedy of course, is obvious.

### **Atwater Kent 36, 37, 38, 40, 41, 42, 44, 45, 46, 47, 50, 52**

A complaint frequently encountered on these models is the inability to set the tuning dial accurately for any station, since the station may be received at various points at different times within one or two divisions on the dial. This condition is due to loose tension of the tuning belts. In order to increase the tension of these belts and take up the slack, it is necessary to loosen the three mounting screws holding the two end tuning condensers to the chassis. These condensers are moved out or away from the "dial" or center condenser to take up the slack in the belts, and the three mounting screws then securely tightened.

### **Atwater Kent 55, 55C, 55F, 55FC**

The symptoms of choky and weak reception on these models is usually caused by an open detector cathode bias resistor. An early model used a 100,000 ohm resistor

as the cathode bias, but later models employed a unit of approximately 50,000 ohms.

Where the condition of oscillation is encountered that is not a result of either bad tubes or open-circuited bypass condensers, poor alignment of the tuning condensers may be the cause. These condensers may be rebalanced by loosening the set screws holding the shafts to the belt pulleys. In cases where even this will not help, try placing a metal howl arrester over the 27 detector tube, connecting the arrester to the stator plates of the detector tuning condenser.

### Atwater Kent 55, 55C

Should the condition of distorted reproduction be observed with the symptoms of unusually high grid bias, usually about twice its normal value, impressed upon the output tubes, the trouble may be traced to one of the

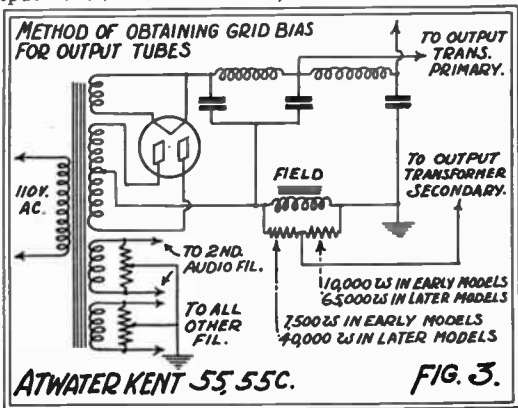

two resistors connected in series across the field coil, dividing the voltage drop across the field to obtain the proper grid bias for the output tubes as shown in Figure 3.

#### — NOTES —

*MODEL 60 :- Sputtering and static showing mostly on local stations, when tubes are OK & chassis is not moving when geared, - Check RF cathode resistor for poorly soldered joint or loose rivets.*

Most often the open resistor will be found to be that connected from the control grid bias tap to ground. In the early models, the value of this resistor was 10,000 ohms, while in the later model a 65,000 ohm unit is employed. This failure may be checked without removing the chassis from the cabinet by means of a point-to-point resistance test, but in order to accomplish this, it is necessary to remove the speaker plug or else an erroneous indication will be obtained.

### Atwater Kent 70 Series

Where one of these models is encountered with the dial about 10 to 30 K.C. off the correct frequency, particularly at the higher frequencies, no amount of aligning will correct the condition. It is necessary that the control grid leads to the 3 screen grid tubes are as far apart as possible and parallel to one another.

### Atwater Kent 82, 85, 86, 90, 92, 94

The complaint of low volume and poor tone and especially little response when the tone control is set at the

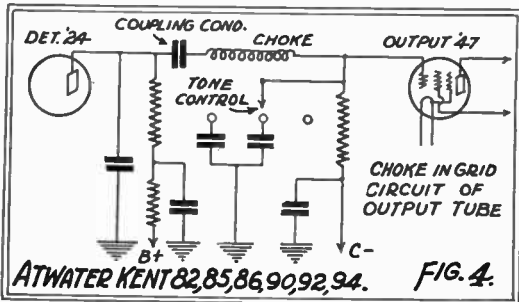

"bass" position, will be found to be caused by an open R.F. choke in the output pentode control grid circuit.

— NOTES —

This failure will not be disclosed by the use of a set analyzer, as all voltages will be intact when this choke open-circuits resulting only in breaking the coupling between the plate of the second detector and the grid of the pentode tube as shown in Figure 4. In some cases, the open circuit in this choke will consist of a break in one of the leads which may easily be repaired as it emerges from the bobbin winding, although shorting out the choke entirely has produced no noticeable ill-effects. Where it is desired however, a new unit may be installed.

Because of the fact that the I.F. alignment condensers are located on top of the coils beneath the coil shields, it is necessary to remove the shields in order to make any adjustments. Replacement of these shields will often have an affect upon the alignment. To eliminate this condition, a duplicate can should be secured with several holes in the top to permit the entrance of the adjusting screw-driver. When it becomes necessary to realign the I.F. transformers this shield may be substituted for the one ordinarily used.

### Atwater Kent 85, 86, 89

Where the condition of poor control of volume is encountered wherein the volume control is effective only over a small portion of its range, the difficulty is probably due to a gassy or high emission 24A tube in the A.V.C. stage. It is sometimes necessary to try several tubes in this stage before one may be found which will provide a gradual control of volume when the volume control is rotated.

### Atwater Kent 96

The complaint of an inoperative receiver with the symptom of nearly 400 volts of the control grid bias on the R.F. 1st detector and I.F. tubes, is caused by a primary-secondary short of the first I.F. transformer. The

<p><b>METAL-WORKING</b> <b>LATHE</b></p>	
<p>New designs and mass production methods make this amazing bargain possible. Complete metal working lathe with compound slide-rest, improved three-jaw chucking device, 6-in. swing, 24-in. overall length, 20 lbs. Send postcard for catalog and 10-day trial offer, or save time and send \$1. balance plus express C.O.D. Wood-turning lathe \$4.50. Extra bed-lengths, 50c per foot. Attachments for milling, grinding, sanding, saw-table, etc., available at low prices.</p>	<p><b>\$7.50</b> <b>COMPLETE</b></p>
<p><b>American Machine &amp; Tool Co., Dept. A.T., 200 Broadway, N. Y.</b></p>	

short is due to a carbon resistor shunted across the secondary winding, which is shorting to the primary coil. This resistor is imbedded in the pitch which is used to impregnate the primary winding. To remedy this defect, it is only necessary to work the resistor out of the pitch, moving it a slight distance from the primary winding after a layer of tape has been wrapped around the unit. A further indication of this defect will be the climbing of the Tonebeam light to the top when the receiver is switched on, then quickly falling out of sight as the tubes heat. The transformer in question is located at the back righthand corner of the chassis in front of the neon light adjustment.

### Atwater Kent 99

When this receiver is found inoperative with exactly the same symptoms as described in the preceding paragraph with the model 96, namely, very high control grid voltages on the R.F. 1st detector and I.F. tubes, and the rapid falling of the neon tube glow as the tubes become heated, the trouble will be found due to the I.F. secondary shunt resistor shorting to the primary winding in the first I.F. transformer. The remedy has been discussed with the model 96. This transformer is located in the front righthand corner of the chassis to the right of the A.V.C. 24.

### Atwater Kent 310, 510

Where the symptom of a "glowing" or red hot screen grid element of one of the 2A5 tubes is observed, check the output transformer located on the dynamic reproducer. The set analyzer will reveal the cause of the symptom by a lack of plate voltage on that tube, which is due to an open-circuited portion of the primary winding of the output transformer.

One of the most frequent complaints on this model is

— NOTES —



the "sizzling" or "frying" noise that is heard in the reproducer for a few seconds after the receiver has been switched on. This condition is caused by the breakdown of the wet electrolytic filter condensers occasioned by the no-load peak voltages, since all the amplifier tubes are of the indirect heater type. Although several remedies may be devised, a simple solution to the problem is that of employing an indirect heater type rectifier tube of the same filament or heater rating. In this case, the output voltage of the rectifier will rise to its normal value as the cathode of the tube becomes heated, thus preventing the output voltage from becoming dangerously high before the amplifier tubes are fully heated, and avoiding condenser failures.

This receiver employs a noise suppressor control in the cathode circuit of the '58 intermediate frequency ampli-

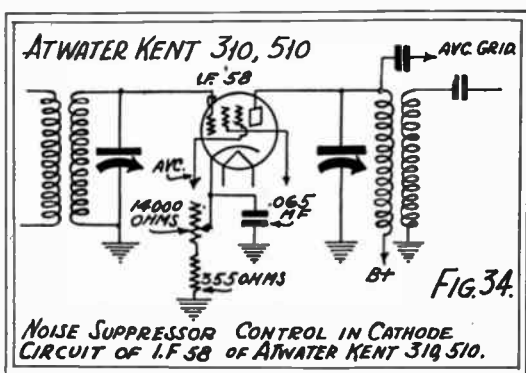

fier as shown in Figure 34. The purpose of this control is that of reducing the sensitivity of the receiver so that a minimum of interference will be present when the dial is rotated from station to station. Where little or no effect is obtained, when this control is adjusted, the trouble

has been found to be caused by the variable resistance. The remedy is replacement.

In this model, the complaint of intermittent reception is often encountered. This condition, in many instances, may be reproduced by tapping the front of the cabinet. At other times, reception can be made to stop and start by merely walking across the room, or upon vibration of the chassis set up by the movement of the loud speaker. In almost every case, the trouble has been traced as being caused by small splashed particles of solder, which have lodged between the contacts or terminals of the wave-band switch. The remedy is fairly obvious.

### Atwater Kent 427, 667, 277

The symptoms of weak, distorted reception and oscillation have been encountered on several of these receivers. A socket analysis test will reveal a high first detector cathode bias. If such is the case, check the cathode bias resistor, a long flexible type resistor, connected from an insulated terminal on the small R.F. choke, located near the oscillator tube socket, to chassis, for an open-circuited condition, and a leaky .1 mf. condenser bypassing this unit. The correct value of the resistor, which is connected in series with the cathode pickup coil of the first detector tube as shown in Figure 39, is 550 ohms. Both the resistor and the condenser must be replaced.

Where an extremely long aerial is employed with these receivers it is necessary that the red antenna lead of the receiver be used, in order to reduce cross-talk or interference between stations. When this is the case, try grounding the blue antenna lead to the chassis. A number of instances have been found where this procedure increased the sensitivity, still retaining the advantages of the smaller antenna coil, when a long antenna was connected to the receiver.

— NOTES —

## Atwater Kent 612, 812

These models have the notorious reputation of "blowing" line fuses. Because of a pair of 83 mercury vapor rectifiers, small buffer condensers are connected across the high voltage windings to filter out noise caused by these rectifiers. These rectifiers break down or become leaky and short that portion of the high voltage winding across which it is connected, thus increasing the load upon the primary and causing the fuse to blow. As there are two power transformers, four buffer condensers are necessary.

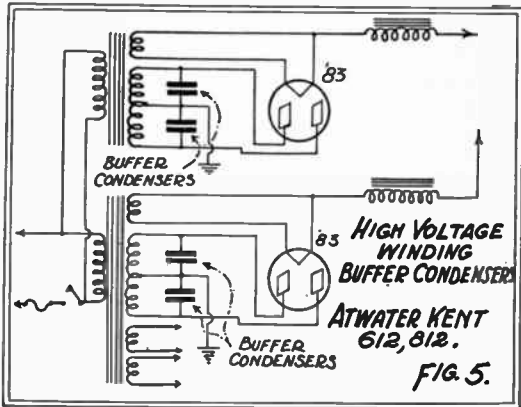

They are connected as shown in Figure 5. All four condensers are contained in a single block located on the side wall of the chassis near the 83 sockets. Although the value specified is .07 mf., the capacity is not critical and .1 mf. condensers may be used to replace the leaky or short circuited section, providing its working voltage is over 400 volts.

Where the condition of hum upon resonance is encountered, which may also be of an intermittent nature,

— NOTES —

look for an open-circuited section of the same bypass block mentioned in the preceding paragraph.

The connection to the 1450 mmf. oscillator tracking condenser has often been traced as the cause of noisy and intermittent reception on these models. This condenser is located within the oscillator coil shield.

Spasmodic and irregular operation of the silent tuning control is due to a loose element 57 tube used in this stage, in most cases. This tube plays an important part in the correct operation of the receiver and it is necessary that the tube used be a perfect one.

### Atwater Kent 627

Where the symptoms of oscillation and erratic operation are encountered on this model, which are not caused by open-circuited condensers or incorrect alignment of the tuned circuits, the difficulty has been overcome by con-

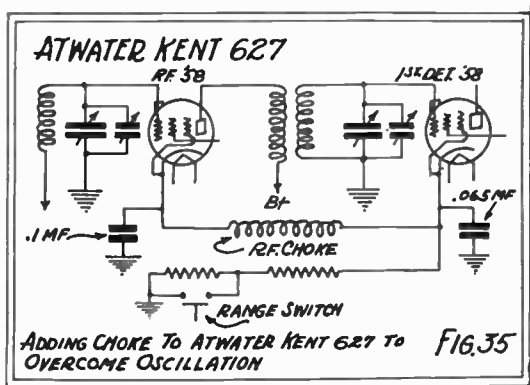

necting a small R.F. 85 millihenry choke in the R.F. stage cathode circuit. In these receivers, a common bias resistor is employed for both the R.F. and I.F. 58 tubes.

— NOTES —

The choke should be connected as shown in Figure 35. Later models incorporated this unit.

## Atwater Kent 812

Frequently, the Tonebeam employed in this model is the cause of many complaints, the operation of the beam being very erratic with the light column slowly falling, disappearing and then suddenly climbing, to be repeated several times. This condition is caused by the shorting of the 40,000 and 6,000 ohm carbon resistors in the Tonebeam voltage divider circuit. The two resistors, together with a third resistor which is in the 2nd detector cathode circuit are mounted in an insulating paper container and separated by small wads of pitch. Vibration causes the two resistors in question, due to the fact that the Wood's metal ends are pointed, to work their way

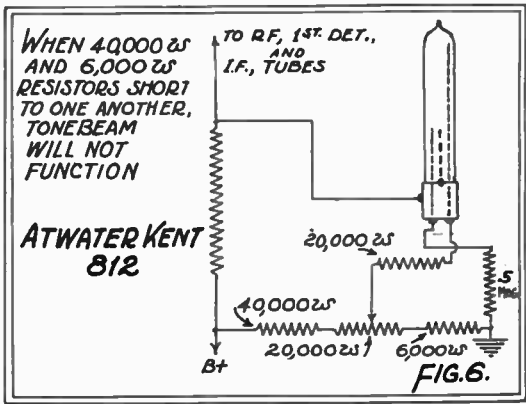

through the pitch and short to one another. The shorting of these two resistors, as shown in Figure 6, shorts the Tonebeam potentiometer out of circuit, disturbing the

— NOTES —

biasing arrangement and the Tonebeam will not function.

At times it may be found that the neon column in the tone-beam has no action when the receiver is tuned from station to station indicating resonance. This may be caused by the fact that the tone-beam potentiometer has been set too high and the initial bias voltage on the long electrode is too great, resulting in the neon column climbing to the top of the long electrode. If satisfactory operation cannot be obtained by reducing the setting of the tone-beam potentiometer adjustment, check the white 40,000 ohm bleeder resistor for an open-circuited condition. This resistor is mounted in an insulating paper container, together with another bleeder resistor in the tone-beam circuit and a resistor in the detector cathode circuit. Each resistor is separated by small wads of pitch. The open-circuit in every case has been due to bad contact of the Wood's metal ends of the resistor which have worked loose. Replacement of the unit is essential. If a resistor of 40,000 ohms cannot be obtained, a 50,000 ohm unit may be substituted, since the tone-beam potentiometer will compensate for this difference.

### Bosch 46, 126, 146, 166, 176

In this model, usually referred to as the "Little Six", a frequent cause for annoyance lies with the compensating condensers. These compensating condensers are aluminum plates located in front of each tuning condenser section. Banging of the condenser gang causes these compensating plates to shift and short that particular section of the gang. The plates are not noticeable and many Servicemen pass them up, not knowing of their existence.

Where symptoms of weak and unbalanced reception are encountered on this model, the most probable cause is due to an open-circuited condition of one or both of the 226 bias resistor bypass condensers.

## Bosch 28, 29, 38

A complaint of poor volume and distorted reproduction on these models will often be found due to an open 50,000 ohm resistor in the detector plate circuit. This resistor serves to supply the voltage required for correct operation of the detector tube. It is of the grid leak type, mounted in clips located directly in front of the first audio socket.

This same resistor is the cause of noisy reception. The original unit employed in this receiver has its resistance element coated upon the inner surface of the glass, and after the receiver has been in use for some length of time, a noisy condition often results.

The condition of motor-boating and oscillation, where all R.F. and bias resistor bypasses have been checked, can often be rectified by connecting an additional 1 mf. condenser from either side of this 50,000 ohm resistor to chassis, the best position being determined by trial. In some cases, this oscillation will be observed only upon certain portions of the broadcast band and may be more or less of the nature of audio oscillation. In late models of these receivers, the detector plate bypass condenser, a .002 mf. unit, was connected after the R.F. choke in the detector plate circuit, to chassis. To overcome this oscillation, the condenser should be moved back to its original position and tied directly to the plate, or an additional condenser may be installed from detector plate to ground without disturbing the condenser connected after the choke.

Cases of resonance hum have often been found to be caused by an open-circuited condenser or condensers connected in series across the A.C. line with their junction point grounded. The remedy, of course, is replacement with another unit with a capacity of .1 mf. However, it is sometimes necessary to employ a higher capacity, usually a .5 mf. condenser to overcome an unusually strong hum upon resonance.

The symptoms of intermittent reception and low vol-

ume are often due to a loose lug fastened at the front of the stator plates of the first section of the condenser gang. Instead of connecting one side of the volume control directly to the antenna connection, in order to save wiring the manufacturer connects this end of the volume control to the aforementioned lug on the front of the first variable condenser stator plates as these are already connected to the antenna connection, from the rear. To properly tighten this loose lug, it is necessary to remove the chassis to tighten the condenser bolt.

If for any reason the chassis is removed or the volume control replaced, care should be taken that the shaft of the volume control which protrudes slightly, does not short to the chassis or become grounded, as this will cause the grid of the 1st R.F. tube to ground, resulting in weak reception, if any at all.

When new tubes or ones with slightly different characteristics are installed in these receivers, it sometimes becomes necessary that the R.F. stages be reneutralized.

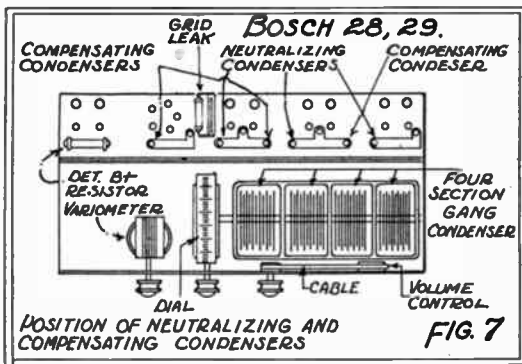

Shifting of the condenser gang compensating condensers after the set has been in service over a period of time, may necessitate readjustment. Both the neutralizing and com-

— NOTES —



compensating condensers, the position of which is often confusing, are located in front of the R.F. and detector sockets. A glance at Figure 7 will clear up this difficulty.

The audio transformers used in these models are frequently a source of noisy reception. This noisy condition which will be apparent even after the R.F. tubes have been removed, may be quickly checked. Unsolder the plate lead of the audio transformer from the plate of the tube and connect a 50,000 ohm resistor from the plate of the tube to the B+ terminal of the audio transformer. A .1 mf. condenser connected from the plate of the tube to the grid of the following stage will complete the arrangement. Should the primary of the push-pull input transformer be suspected, the coupling condenser is connected to either one of the output tube grids.

Intermittent reception has been traced in many instances to the rubber-covered lead connecting the stator of the variometer to the first variable condenser section. This lead passes through a hole in the chassis and vibration causes the chassis to bite through the insulation, producing the complaint stated.

### Bosch 31, 32

Complaints of fading on these models is in most cases due to an intermittently open-circuiting 30,000 ohm screen resistor, a one watt unit. Due to the current passing through the unit as it is part of the voltage divider system and supplies screen voltage to both 1st detector and I.F. tubes, it breaks down, at first, intermittently. Remedy is replacement with a 2 or 5 watt resistor of the same value.

Another cause for fading, with the additional symptom of muffled or mushy reproduction, lies with an open-circuiting 2 megohm resistor in the 2nd detector screen grid circuit. Because of the high resistance of this unit and the actual voltage impressed upon the screen being

about 4 or 5 volts, it is difficult to check for an open-circuit.

Where the condition of hum is encountered on these models, the usual cause is open-circuiting filter condensers. These filter condensers are contained in a metal block together with the line bypass condenser and the condenser which is connected across the speaker field coil. To check the first filter condenser, measurements must be made across the black and green leads, and across the red lead and chassis for the second filter condenser.

On some occasions, the symptoms of very low reception will be observed with the additional circumstance of no voltage drop across the speaker field coil. If the speaker plug is removed and the field coil is measured, its resistance will be found correct, but if the ohmmeter is connected across the field terminals of the speaker plug socket, a direct short will be indicated. This is due to a short-circuited bypass condenser used to "tune" the field coil. Replacement of this condenser presents its

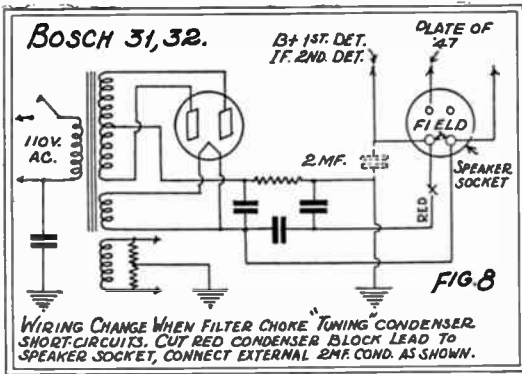

own problem, for it is located within the filter condenser block and connected internally. However, it is not necessary to replace the entire filter block, which is sometimes

done, to effect a repair, if the procedure outlined in Figure 8 is closely followed.

One of the most frequent causes for an inoperative receiver on these models is a shorted second intermediate frequency transformer. In order to obtain maximum coupling, the primary and secondary are wound together, the former with enameled wire and the secondary with cotton covered enameled wire. The insulation breaks down at some point and results in a shorted unit. This shorted condition is best checked by removing three of the leads connected to the transformer.

### Bosch 48, 49, 16, 17, 18

The condition of noisy tuning and oscillation as the station selector is rotated, is invariably caused by a dirty variometer rotor contact. This variometer, enclosed in a metal shield, is attached and geared directly to one end of the condenser gang to obtain equal sensitivity at both high and low frequencies. In order to clean this copper contact, it is necessary to remove the variometer. This may be done by removing the shield and then the nuts and insulated washers holding the variometer in place. After the copper spring contact is thoroughly polished, it should be bent slightly to increase its tension. A frequent cause for weak reception at either the high or low frequency portions of the tuning band is due to the same variometer being out of phase in relation to the position of the tuning gang. The setting of the variometer is correct when the rotor is at right angles to the stator when the condenser gang is set to approximately 50 on the dial.

When the chassis on these models is installed into the cabinet, from which it had been removed for purposes of repair, it is important that the shafts of the volume control, tuning condenser, or "clarifier" should not short to the escutcheon plate. The tuning condenser shaft is at ground potential and if the volume control shaft touches

the escutcheon plate, it will cause the antenna to be grounded, resulting in weak or no reception. Should both the shafts of the tuning gang and the "clarifier" or antenna trimmer touch the escutcheon plate at the same time, a similar condition will be noted, as the rotor of the antenna trimmer is connected to the high side of the antenna volume control.

Some of the later models of these receivers come equipped with small 500 ohm carbon resistors in the grid circuit of the 2nd and 3rd R.F. tubes. Where these receivers are serviced because of weak reception, and a set analyzer reveals excessive plate current drawn by the 2nd and 3rd R.F. tubes, these resistors will be found open and should be replaced.

The complaint of noisy reception that has definitely been determined as caused by some internal condition in the receiver, has often been traced to either one or both .001 mf. bypass condensers in the detector plate circuit which have become noisy. Although these condensers may respond to every test they should be disconnected or replaced to ascertain the origin of the noise.

When replacing tuning drive cables in these receivers it is best that the tuning gang shield and dial scale be removed so that free access may be gained to the drum and pulleys. If the cable is started at the rear pulley the job will be much easier.

Hum is a frequent complaint with these models and the cause may often be determined without removing the chassis from the cabinet. Usually the condensers connected before and after the speaker field, which is used as a choke, are at fault. If the speaker field plug is moved out slightly from its socket, a 2 or 4 mf. filter condenser may be connected first to one side of the field and then the other, to chassis, shunting the original capacities. A diminishing or disappearance of the hum will point to the trouble. Should the condition still exist, a .05 or .1 mf. condenser should be connected across the field. This checks the "tuning" condenser.

— NOTES —

## Bosch 54 DC

In many respects this model is familiar to the Bosch 48, 49. The condition of noisy tuning is caused by a corroded variometer rotor contact, the repair of which has already been described with the model 48. If the variometer is out of phase, weak reception and oscillation will result.

Distorted reproduction is most frequently due to a weak or exhausted C battery, which is used to supply the necessary grid potential for the output tubes. The fact that the output tubes are drawing excessive plate current, readily disclosed by the set analyzer, will be an indication of this failure. When a new C battery is installed, the positive terminal must be connected to the chassis.

Symptoms of weak reception with the additional observation of slightly higher plate current drawn by either the 2nd or 3rd R.F. tubes, will be found caused by an open 500 ohm grid suppressor in that stage. These grid suppressors are located within the condenser gang compartment, mounted upon the compensating condenser brackets.

A word of caution regarding the ground wire will not be amiss. Under no circumstances, should this lead be connected to any part of the receiver chassis, but only to the binding post provided for it. Failure to observe this precaution will result in certain damage. In most cases, one of the tubes will "blow."

Three wire-wound vitreous-enameled Edison-base type resistors are employed in this model as filament resistors. These units are located in the speaker compartment of the cabinet and are subject to the usual jars, and vibrations set up by the speaker. Due to this vibration, they often crack, usually at the middle.

A loud and insistent resonance hum and sometimes weak and distorted reception, has often been traced to an open-circuited detector cathode bypass condenser. The value of this unit is 1 mf. Improved quality of repro-

duction may be obtained, however, if a unit of higher capacity is used at this point.

### Bosch 58

Distorted and weak reception on this model has been frequently traced to an open 1 megohm resistor in the detector screen grid circuit. As the voltage drop across this high resistance is very high, only a screen voltage of approximately 8 volts being indicated upon the voltmeter, this unit is difficult to check. Replacement with a 1 watt resistor instead of the original  $\frac{1}{2}$  watt size used, may prevent a future service call.

Where the condition of station "hiss" is noted, as the station selector is tuned from one station to another, the trouble has almost always been traced and found to be caused by an open-circuited de-coupling resistor bypass condenser, either in the antenna or 3rd R.F. stage. The capacity of these units is approximately .05 mf., although capacities of .07 or .1 mf. will serve the purpose as well.

Resonance hum in this model may sometimes be due to an open-circuited .1 mf. buffer condenser connected from one side of the primary to chassis.

Where it is found that very little response is obtained with the local-distance switch in the local position, the 500 ohm resistor connected in this circuit will be found at fault. Vibration snaps either the short pig-tails of the resistor or the soldered connection. In some cases, the same condition may be caused by the fact that the 3 leads of the local-distance switch assembly are improperly connected to the 3 binding posts on the receiver.

### Bosch 60, 61

The rather unusual condition of two-spot tuning is often encountered on these models, where any given station will be received at 10 K.C. on either side of the proper frequency. In other words, a station which or-

— NOTES —

dinarily is received at 660 K.C. on the dial, will come in equally well, at 650 and 670 K.C., with a dead-spot between these two points. This puzzling situation is caused by an open-circuited  $\frac{1}{2}$  watt detector screen resistor, whose value is 1 megohm. This resistor, *which has never been shown in any published schematic of this receiver*, is a small black and white carbon unit located under the A.V.C. socket. Attendant symptoms when this resistor open-circuits will be weak, distorted and choky reception, with erratic operation of the resonance tuning meter.

Station "hiss" in these models as in the 48, 49 is often caused by an open-circuited 3rd R.F. de-coupling resistor bypass condenser, a .04 mf. unit.

Weak and intermittent reception in many instances, is due to an open-circuited or open-circuiting 1st R.F. coupling condenser or the 2nd R.F. secondary return bypass condenser. Should either of the above units become leaky, the condition of fading will be experienced. The capacity of the 1st R.F. coupling condenser is .04 mf., while the 2nd R.F. secondary return bypass condenser is a .5 mf. unit.

Where it is found that the receiver is operating with little or no A.V.C. action it is probable that the 24 tube in the A.V.C. stage is at fault and a tube with the correct characteristics must be selected. With the receiver in operating condition, but tuned off resonance, several tubes should be tried in the A.V.C. stage. The tube which will *not* swing the tuning meter needle one way or the other, when it is inserted and heats, is satisfactory as the A.V.C.

When very weak reception is obtained with a good deal of background noise, with the local-distance switch in the local position, a broken lead to the 500 ohm carbon resistor in this circuit may be the cause.

### **Brunswick 14, 21, 31, 81, 82**

Noisy reception on these models, a frequent complaint.

is due to bad contacts on the local-distance switch. The contact points should be carefully cleaned and the springs bent slightly to secure more tension. The two screws holding the switch assembly together, should be tightened after this is done.

Another cause for complaint is a slipping tuning drive which may be easily remedied. To take up the slack in the drive cord, the tension of the spring attached to one end of the cord must be increased by moving the screw, to which the spring is attached, forward in the slotted hole provided for the purpose. A drop of oil applied with a tooth-pick to the bearing of the tuning gang shaft, and pulleys, will ease the action of these components and relieve the strain upon the drive cable.

The condition of loud hum or oscillation upon strong signals, is usually caused by a receiver that is out of neutralization. The method used to re-neutralize, is the same for that of any receiver utilizing the neutrodyne circuit, by using a dummy tube in the stage to be neutralized and adjusting the neutralizing condenser for minimum output, with the receiver tuned to a good signal at approximately 1400 K.C.

If it is found that the volume level can not be varied and the receiver operates at full volume, the probability

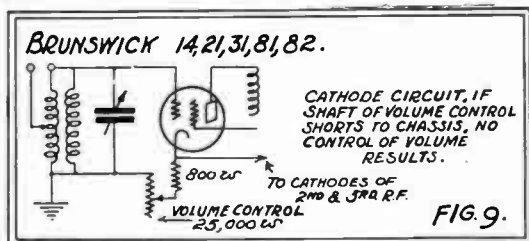

of the volume control shaft being shorted to the chassis is strong. This shaft should be insulated from the

— NOTES —



mounting bracket, or the volume control circuit will be shorted out, as shown in Figure 9.

When the condition of hum is encountered on these models, look for one or more open-circuited condensers in the proper pack. This failure is easily checked by shunting each filter condenser with a 2 mf. unit. Because of the fact that a common terminal is not used, the

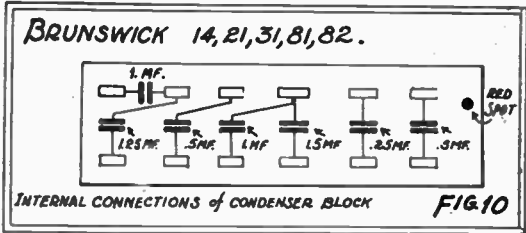

lug arrangement of the filter block is often confusing. Figure 10 shows the internal connections of the block.

### Brunswick S-14, S-21, S-31, S-81, S-82

A frequent complaint with these models is insufficient sensitivity or volume on weak signals. If the circuit diagram of the R.F. portion of this receiver shown at (A) of Figure 36 is scrutinized, it will be noted that the R.F. stages are coupled by means of small 2.5 mmf. fixed condensers. These condensers consist of tiny metal tabs separated by a strip of insulating material. In this instance, where additional sensitivity is desired or required, it may be accomplished by removing these three small coupling condensers and winding a three to five turn coil at the grid end of the secondary coil for obtaining a transference of energy. One end of this coil is connected to the plate of the preceding tube and the other end is left free as shown at (B) of Figure 36. The number of turns to be wound depends upon the desired increase in

We specialize exclusively in **Genuine Brunswick Radio and Phonograph Replacement Parts.** Complete stocks always on hand at 40% off list.

**BRODCO RADIO CORP.**  
142 W. Liberty St.  
New York, N. Y.

sensitivity and will vary in each individual case and each different set.

Noisy reception on these models is a complaint fre-

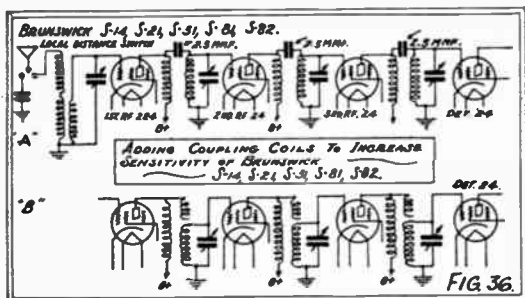

quently due to bad contacts on the local-distance switch. The contact points should be carefully cleaned and the springs bent slightly to secure increased tension. The two screws holding the switch assembly together should be tightened after this is done.

As with the models 14, 21, 31 etc., if it is found that the volume level cannot be varied and the receiver operates at full volume, check the insulation between the volume control shaft and the chassis. Should the shaft be found short-circuited to the chassis, the volume control will be shorted out of the circuit, thus enabling the receiver to operate with a low, fixed control grid bias on the three R.F. tubes.

Another cause for complaint is a slipping tuning drive which is easily remedied. The trouble may be due to a loose drive cord. To take up the slack in the drive cord, the tension of the spring attached to one end of the cord must be increased by moving the screw to which this spring is attached forward in the slotted hole provided for the purpose. The screw should be securely tightened after this is done. A drop of oil applied with a tooth-

— NOTES —

pick to the bearing of the tuning gang shaft, and pulleys, will ease the action of these components and relieve the strain upon the drive cable. The procedure in any case would be that of removing all possible causes for friction or binding which might contribute to the slipping of the tuning drive.

A frequent failure with these models lies in an open-circuited section of the condenser block in the power pack. An open-circuited section will produce the symptoms of hum, and oscillation in some instances. The open-circuited section is most easily checked by shunting each section of the condenser block with a one or two mf. unit, in turn. Similar to the filter block employed with the models 14, 21, 31, 81 and 82, a single common

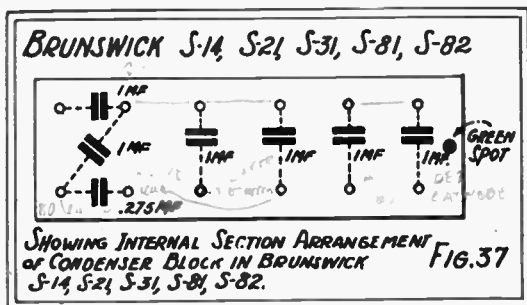

terminal is not employed, thus making the arrangement of the terminal lugs confusing. The internal connections and the various capacities of the sections are shown at Figure 37.

### Brunswick S 31

Intermittent phonograph reproduction is sometimes due to a loose terminal of the .01 or .02 tubular condenser connected from one of the phono-radio transfer switch terminals to the secondary of the phono input transformer.

— NOTES —

**Brunswick 15, 22, 32, 42**

The symptoms of low volume and choky reproduction, with a reading of approximately 100 volts obtained on the plates of the output tubes, are caused almost invariably, by a short-circuited speaker output condenser. This condenser is located within the condenser block and is connected to the output circuit by the two green leads emerging from the block.

After these receivers have been in service for some time, the volume control will be found to have a noisy action. This volume control is different than that used in most sets, for it is of the condenser type and employed as a variable coupling between the 1st and 2nd R.F. stages. A long flat copper strip is used to connect the plunger of the volume control to the stator plates of the 2nd R.F. tuning condenser. The connection of the strip to the plunger will be found loose or corroded beneath the rubber sleeving and should be re-soldered.

The condition of background noise with the local-distance switch in the local position may be reduced, or eliminated in most cases, by removing the .0002 mf. condenser connected from one side of the switch to chassis. After this is done it is best that the 1st R.F. variable condenser compensator be readjusted.

Intermittent operation or "fading" is often caused by poor riveted contacts of the .02 audio coupling condenser, mounted beneath the sub-panel. If a hot soldering iron and good rosin-core solder are applied to these rivets for a minute or so, until the solder is thoroughly sweated into the rivets, the trouble will be eliminated. This symptom may be reproduced by pressing down upon either or both of the 45 tubes while the set is operating. This pressure upon the sub-panel will disturb the riveted connections of the coupling condenser and reception will cease.

Fading or a sharp drop in volume has often been traced to open-circuited screen or cathode bypass condensers in

the R.F. stages. Where this complaint is encountered, these condensers should be bridged, in turn, with a good .25 mf. unit to determine the faulty member.

The R.F. coils employed in these receivers are wound on very light forms and many inoperative receivers may be traced to this fact. The terminal lugs of the secondary windings often short to the metal shield or chassis. When the shields are removed to check the coils, it is necessary that care be exercised so that the coil-forms are not broken or the connecting lugs torn away. It is well to insulate the bottom of coil from the chassis by a strip of cardboard cut to size.

Where it is found that the receiver is inoperative with the additional observation of a high positive potential impressed upon the grids of the 3rd R.F. and detector tubes, as disclosed by the set analyzer, the 100 mmf. coupling condensers used to couple the 3rd R.F. stage to the 2nd R.F. stage and the detector to the 3rd R.F., may be found short-circuited or leaky. These condensers are located on the side of the 3rd R.F. and detector tuning condensers.

Noisy tuning of these models is due to corroded condenser gang rotor contacts. These double copper springs fit snugly over the shaft of the gang and are fastened to the side of the gang section shields by screws which may be removed so that both sides of the contact may be easily cleaned. An off-set screw-driver will be of great assistance in removing these screws.

Weak reception has several times been found due to poor connections to the 4 megohm carbon resistor in the detector secondary return circuit. The usual test, that of removing the control grid cap of the detector tube and placing a finger upon the control grid, producing a loud characteristic hum, is used to advantage at this point to determine an open-circuited condition of this resistor.

### **Brunswick 42**

This model employs an automatic phono mechanism

in conjunction with a model 15 chassis. Data for the radio chassis is the same as that described for models 15, 22, 32. Troubles arising with the automatic mechanism are relatively few and adjustments are simple.

Where it is found that the motor will stop after a few revolutions, the trouble will lie with the cycle switch, whose contacts open slightly as soon as the master gear starts to revolve. Should the off-on switch fail to stop the motor, or the mechanism rejects the record as soon as the pickup head is lowered upon the record, failure of the contacts of the cycle switch to open at the right moment will cause this condition. This cycle switch is located below the mechanism panel so that the trigger actuating the switch contacts fits into a slot in the master gear cam at the proper instant. To adjust the position of the cycle switch, the two screws which are found on the top of the mechanism panel may be loosened and the switch shifted, so that the contacts open at the correct time. This adjustment is best made while the mechanism is going through its cycle of operation.

Should the mechanism slow down or stop down while records are being changed or rejected, the motor brushes and commutator should be carefully cleaned with very fine sand paper.

The condition of records being rejected continuously as soon as a record is deposited upon the turn-table, is usually caused by either a jammed solenoid plunger or the spring on the stop lever attached to the solenoid plunger, having lost its tension. This trouble may be corrected, in the first case, by loosening the two screws which mount the solenoid to the base, and shifting the solenoid position so that the plunger works freely in and out of the solenoid. Either a new stop-lever spring with more tension should be installed in the second instance, or several coils of the spring used, should be removed to supply the necessary tension.

If this spring is too strong, however, the solenoid will not have sufficient power to operate the stop lever, thus

preventing the operation of the mechanism.

If the motor should operate but the record-changing mechanism does not respond, the most usual cause lies with a burn-out or open-circuited solenoid which must be replaced, or with a stop lever spring which is too strong, as discussed above.

The appearance of a strong vibration or mechanical hum during the record changing cycle, has been traced to an improperly centered solenoid, or the rubber damper which is used to smooth out alternating current vibrations may be found to have hardened, thus losing its elasticity. The solenoid should be re-centered by loosening the two mounting screws, or the rubber bumper replaced, to effect a repair.

If the cabinet is not installed in a level position which may be determined with a spirit level or gauge, the needle in the pickup may lower  $\frac{1}{2}$  inch or more from the beginning of the record, or in some cases fail to engage with the record at all. Should the needle jump past several grooves in the record after it has been lowered, instead of falling into the first groove, the tension of the spring attached to the locating lever, must be reduced. In the later models, the tension of the spring may be decreased by adjusting the bracket to which the spring is fastened, while on the earlier models, the spring must be stretched, as no adjustable bracket was provided. If the needle does not move into the first record groove, the tension of this spring should be increased.

Jamming of the mechanism is sometimes due to a warped record which will stick under the record hopper cross-bar, thus preventing the feeder rod from functioning. If standard records are not used the jamming may be caused by an incorrectly adjusted record gate. If the records are thick, the spring clip in the center of the cross bar should be moved up; or if the records are thin, it should be moved down to prevent two records from passing through.

On some occasions, the mechanism will not reject the record after it has been reproduced. Generally, this defect will be found caused by the suspension arm switch, whose floating contact fails to close at the end of a record because the distance between the two contacts is too great. An adjustable stop is provided for adjustment of this clearance. Should the record be rejected before the selection is completed, the contacts of this switch, now, may be too close and the adjustable stop should be adjusted to increase the distance between the floating and stationary contacts.

### Brunswick 11, 12, 16, 18, 33

The most common complaint on these models is fading, or the sharp cutting off, of reception. In some instances this symptom can be produced by a sharp tapping upon the chassis, in which case it would seem the result of a loose connection. This loose connection is not visible, for it is located within the shield can housing of the .5 mf. oscillator plate bypass condenser. The quickest remedy is replacement.

When the symptoms of distorted reproduction, a slight hum and oscillation are observed, the capacity of the 6 mf. wet electrolytic filter condenser should be checked. This unit often loses much of its effective capacity and will result in the above complaint because of insufficient filtering and bypassing of the R.F. circuit.

If it is found that the receiver will not tune above 650 K.C. or below 1300 K.C., and the porcelain insulators on the "turret" type tuning gang are not broken, which fact will cause the stators to shift, then the 24A oscillator should be changed.

On the model 33, a phono-radio combination, when radio reception can be heard while a record is reproduced, one of the wires connecting to the phono-radio transfer switch on the phonograph volume control switch, will



be found torn from the connecting lug. It should be re-soldered.

An inoperative receiver with the attendant circumstance of a high positive voltage upon the grid of the 1st detector tube is due to a short-circuited 100 mmt. mica coupling condenser mounted upon one end of the 1st detector stator.

Intermittent reception on these models is often caused by the lugs on the light coil-forms shorting to the chassis within the coil shields, or the ends of the coils snapped directly at the lug and making contact intermittently.

A slipping condenser friction drive of these receivers is a complaint easily remedied. The dial and dial frame should be removed by loosening and removing the nut holding the dial and frame to the turret condenser shaft. The two screws holding the volume control-tone control assembly in place, should be removed next. Two fiber or metal washers, approximately  $\frac{1}{8}$  to  $\frac{1}{16}$  inch thick, should be inserted on the screws under the assembly, so that the assembly will be raised by that amount when it is re-installed in position by tightening the two screws. This procedure will raise the friction gear so that when the dial and frame are replaced on the turret condenser shaft, the gear will more firmly engage the edge of the dial frame.

### Brunswick 17, 24, 25

No control of volume is the principal and most common complaint on these models. Usually the condition is due to leakage of the fish paper insulating the can of the first wet electrolytic condenser from the chassis. The insulation is placed between the mounting clamp and the condenser. In other cases, the same condition has been traced to a leaky .02 mf. secondary return bypass condenser in the R.F. or 1st detector stages; or to a leaky .1 mf. I.F. secondary return bypass condenser; the latter unit being mounted directly upon the I.F. transformer,

with the .02 mf. condensers contained in the common bypass block fastened to the back side of the chassis. A good high-range ohmmeter, capable of measuring up to 10 megohms, should be used to check these condensers for leakage. Where the condition of the receiver bursting in to full volume and fading gradually to normal volume level, is encountered, the aforementioned fish paper insulation on the first electrolytic condenser will again be found at fault, vibration causing the resistance of the defective insulation to vary. Should the blue or green leads, or the lugs to which they connect on the speaker terminal strip, short to one another, or to the frame or terminal cover, the condition of no control of volume or distortion will result.

Intermittent reception is often caused by an open-circuiting .5 mf. oscillator plate bypass condenser. As in the case with the previous model, this open-circuit is due to loose connections or contacts within the metal housing of the condenser.

The symptoms of distortion at any volume level, accompanied by the condition of poor control of volume and a speaker field that over-heats considerably, is due to a carbonized voltage divider system. The large 14,000 ohm brown carbon resistor, located between the first and second I.F. transformers, serves to reduce the high voltage to the proper screen potential required for correct operation of the screen grid tubes. Because of its position in the circuit, and inadequate ventilation, this unit carbonizes and reduces in value, usually to approximately 3,000 ohms. When this occurs, the two  $\frac{1}{4}$  watt, 5,000 ohm carbon resistors completing the voltage dividing circuit, will also be found charred or carbonized and much lowered in value. All three resistors should be replaced, the 14,000 ohm carbon unit with a 10 or 25 watt wire-wound resistor.

The remedy for the complaint of full volume, for a minute or two after the receiver has been switched on.

— NOTES —

regardless of the setting of the volume control, is replacement of the slow heater A.V.C. 27 tube with one of the quick heating type. With a slow heater type tube in the A.V.C. stage, the required negative potential is not impressed upon the control grids of the R.F., 1st detector and I.F. tubes until long after they have fully heated, and the receiver will perform at full volume until the negative potential supplied by the A.V.C. tube reduces the amplification of the tubes.

An inoperative condition not infrequently encountered on these models, with the attendant circumstance of an abnormally high positive control grid bias on the first detector 24A tube and consequent increased plate current, has been invariably traced to a short-circuited condenser, coupling the plate of the R.F. tube to the grid of the first detector tube. This condenser consists of two tiny metal discs insulated by a mica strip and is fastened to the stator frame of the first detector tuning condenser.

Where the complaint of fading or intermittent reception is received, the trouble has almost always been traced to an open-circuiting .5 mf. oscillator plate bypass condenser. The open-circuit consists of a broken connection within the shield can housing of the condenser. In some instances, the symptoms can be reproduced by striking the chassis smartly. Since the condenser is pitched into the metal housing, replacement is the quickest and most effective remedy. The same symptoms will also be experienced when the porcelain insulators of the "turret" type condenser gang are broken, causing the stators to shift, and in many instances short-circuit to the rotors.

Intermittent reception has often been traced to the lugs on the light coil-forms, short-circuiting to the chassis within the coil shields, or the ends of the coils snapping directly at the lug and making contact intermittently. When correcting the first failure described, a strip of cardboard or other insulating material, cut to size, should be placed under the coils to prevent a possible recurrence.

An insensitive condition on the higher frequencies or

the inability to tune the receiver below 650 K.C., where the porcelain insulators on the turret condenser gang are not broken, may be rectified by replacing the 24A oscillator tube, although this tube may test perfectly on any tube checker.

Noisy reception while tuning from station to station is frequently due to the presence of tiny burrs on the plates of the tuning condensers. This condition may be easily eliminated by disconnecting the leads to the condensers and applying the high voltage of the receiver directly across each section. As the condensers are rotated, the high voltage impressed across the plates will produce an arc at the shorting points and burn away the offending burrs.

Due to the fact that the power transformer on these receivers burn out frequently, due to overheating, overload and other causes, many service men use a high grade transformer for replacement purposes. These transformers usually have center-tapped heater windings. These center-tapped connections should not be used for either winding. In the first case, the filament winding supplying the two type 47 output tubes is center-tapped by means of a center-tapped resistor. Should the center tap of the other heater winding be connected to ground as per usual procedure, almost certain damage will occur to the power transformer. This center-tapped connection should be left open. Although one side of the heater winding of the original transformer is grounded, this connection may be removed without any apparent ill-effects.

A slipping condenser friction drive of these receivers is a complaint easily remedied. The dial and dial frame should be removed by loosening and removing the nut holding the dial and frame to the turret condenser shaft. The two screws holding the volume control-tone control assembly in place should be removed next. Two fiber or metal washers, approximately  $\frac{1}{8}$  to  $\frac{1}{16}$  inch thick, should be inserted on the screws under the assembly, so that the assembly will be raised by that amount when it is re-in-

stalled in position by tightening the two screws. This procedure will raise the friction gear so that when the dial and frame are replaced on the turret condenser shaft, the gear will more firmly engage the edge of the dial frame.

### **Brunswick PR-17-8**

See data on Radiola 17.

### **Brunswick 5-KR, 5-KRO, 2-KR-6**

See data on Radiola 17, 18.

### **Brunswick 5-NO**

See data on Radiola 60.

### **Brunswick 2-NC-8, 5-NC-8**

See data on Radiola 62.

### **Brunswick 3-NW-8**

See data on Radiola 64.

### **Clarion A.C. 51, 53, 55**

The principal failure of these receivers is an open-circuited or leaky R.F. cathode bypass condenser. In some instances, the symptoms are oscillation and intermittent reception; in others a peculiar noisy condition will be experienced that is difficult to locate because of the fact that the receiver will not operate noisily when the aerial and ground wires are disconnected to determine the source of the interference.

### **Clarion A.C. 300**

The most frequent cause for complaint on this model

— NOTES —

is hum. In some cases, the condition has been traced to loose laminations of the filter choke which vibrate and produce a hum of a mechanical nature. In other instances, the filter choke coil winding has been found short-circuited or partially short-circuited, or the position of the air gap in the filter choke laminated core has been disturbed. The remedy in both cases is replacement of the unit or in tightening the laminations of the core securely. In a few cases, the condition has been eliminated by tapping the laminated core with a light hammer in an effort to re-space the gap.

These receivers are frequently serviced for the complaint of oscillation and motor-boating, which condition may be present at either the high or low frequencies, or over the entire band. On some occasions, the trouble is of an intermittent nature which will clear up when the chassis is removed from the cabinet and inverted to permit a point-to-point test. In some instances, the oscillation and motor-boating was traced to open-circuited .01 mf. condensers bypassing the R.F., first detector and first and second I.F. secondary returns to ground. Replacing these defective units will usually rectify the difficulty but some few cases were found where it was necessary to substitute a 1 mf. condenser for the .01 mf. units. For some reason the .01 mf. condenser in the R.F. stage seems to be the most frequent offender and most often must be substituted for a larger capacity.

When replacing the type 58 and 57 tubes in this receiver, the top part of the shield should not be forced down too far, as this will result in grounding the control grid caps of these tubes. Where it is found that a strip of insulating material has not been inserted into the top shield to prevent this occurrence, a short piece of adhesive plaster or ordinary friction tape will do the trick.

If the twin speakers on this model are disconnected at any time for the purposes of repair, it is important that the voice coils be properly phased. Unless this is done,

poor tone quality will result. The color-coded lead should be carefully observed before the wires are disconnected.

### Clarion 480

As with the model 300, the Clarion 480 receiver has been serviced on a number of occasions for a loud hum seriously interfering with reception. In each instance, the condition has been traced to a defective filter choke. This unit has been found totally or partially short-circuited. When checking this unit, it may be well to remember that the normal D.C. resistance of the filter choke is approximately 150 ohms.

Several of these receivers have been found which operate normally on the broadcast band, but weakly, if at all, on the short-wave range. This condition has been traced as being caused by a "flat" type 56 oscillator tube which will not function on the higher frequencies, although it will operate perfectly when employed in any other stage as an amplifier or detector.

### Colonial 31

If the receiver fuse "blows" on this model when the line switch is snapped on, the two .1 mf. condensers connected in series across the line with their junction-point grounded, will be the cause. These condensers become leaky, short-circuited, or grounded to the condenser case.

The condition of weak reception, not attributable to defective tubes or faulty component parts, may often be remedied by readjustment of the variable condensers, tuned by means of pulleys and copper belts. Loosening the nuts holding the condenser shafts to the pulley, and adjusting the condenser with the set tuned at the high frequency end of the scale, will remedy this fault.

The complaint of resonance hum and oscillation is often caused by either or both of the .5 mf. condensers

bypassing the 226 filament.

### Colonial 31 D.C.

The condition may be encountered where the receiver cannot be switched off with the line switch until the ground wire is disconnected from the ground binding post. The cause for this situation lies with a short circuited .5 mf. condenser in the ground circuit. This condenser is one of three contained in a common block and connected as shown in Figure 11. Although it is good procedure to replace the entire block, a good .5 mf. condenser may be connected in series with the ground post lead, in the event a replacement block cannot be secured easily.

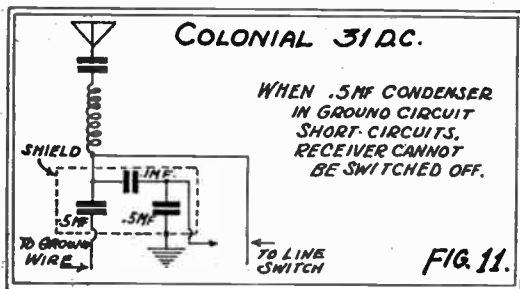

### Colonial 32 A.C.

This model has been and still is serviced more frequently for fading than any other receiver. As a matter of fact, fading and the Colonial 32 have long been synonymous. The causes for this fading complaint are many and varied; and for this reason, only the most common will be herein discussed. This fading may consist of either a gradual decrease or a marked drop in volume, in some cases, reception ceasing completely.

The .1 mf. Sprague condensers mounted upon the



detector plate choke terminal strip on the side wall of the chassis, are the cause of many cases of fading. These units, identified by the code number 4404-P, open-circuit intermittently and produce the fading condition. One of these units is employed as an audio coupling condenser and upon open-circuiting, reception will cease entirely. The other .1 mf. unit is used to bypass the 750,000 ohm red carbon resistor in the detector secondary return circuit. When this unit open-circuits, a sharp decrease in volume will be noted.

Should the condition of fading still exist after these two condensers have been replaced, or checked and found correct, the most probable and usual cause is open-circuited or leaky sections of the bypass condenser blocks in the 1st, 2nd and 3rd R.F., and detector stages. The blocks in the 2nd and 3rd R.F. stages are each composed of four condensers, bypassing the plate circuit, the cathode circuit, one side of the filament to chassis and the fourth condenser bypassing the screen circuit, connecting from screen to cathode, the latter connection made within the block. The condensers of the block in the 1st R.F. also bypass the cathode, filament and screen circuits in like manner, but

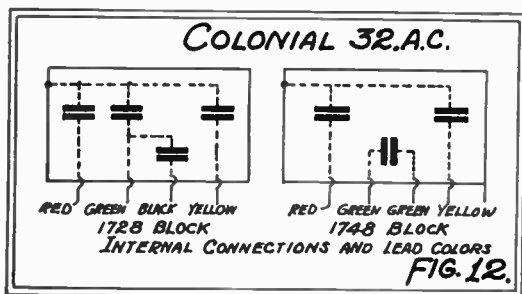

the first condenser bypasses the 750,000 ohm red carbon resistor in the secondary return circuit instead of the plate circuit, as in the case with the blocks in 2nd and 3rd R.F

— NOTES —

stages. These units can be recognized by the code number 1728. The unit in the detector stage, on the other hand, contains only three condensers, bypassing the plate, cathode and screen circuits. It is coded 1748. The lead colors and method of internal connections is shown in Figure 12. The condenser blocks are so situated in the receiver that they are more or less affected by the heat rising from the power transformer, which is mounted in an inverted position. The wax compound used to seal the units, melts out and the rubber-covered leads emerging from the block, become soft and spongy, peeling at the slightest touch. Because of the damage resulting from this heat and other reasons, the condensers open-circuit or become leaky, producing the fading. Although the parts may be replaced with a new superior type, supplied by the manufacturer or with good replacement blocks, it is recommended that individual condensers be installed in each circuit, with a sealing compound whose melting point is much higher than that of the wax in the original blocks.

Another frequent cause for the same condition will be found due to an open-circuited 750,000 ohm red carbon resistor in the 1st R.F. secondary return circuit. Although this failure will be readily disclosed by a set analyzer in the shape of a high plate current reading, the open-circuiting resistor is difficult to check because the defect is of an intermittent nature.

The condenser block connected in the 1st audio circuit and identified by the code number 4407-P, is another common cause for fading in this receiver. The open-circuiting of the .5 mf. condenser, connected from the cathode of the 1st audio tube to one side of the audio transformer primary is the chief offender; although the .2 mf. condenser connected from the cathode of this tube to the high side of the 750,000 ohm carbon resistor in the grid return circuit, is often the cause of a sudden drop in volume when the unit open-circuits.

Due to the heavy mono-type construction of this receiver, it is handled with great difficulty. A sudden jar

when removing or replacing the chassis into the cabinet will often crack the porcelain tuning condenser mounting brackets. Vibration causes these brackets to shift, disturbing the setting of the variable condenser and producing the effect of fading. This condition is easily checked, because removing the condenser coil-shields will disclose the defect in most cases.

Fading and intermittent reception has often been traced to a poor or unsoldered connection to the carbon resistor pigtails. Due to the fact that the pigtails of the resistors are not of sufficient length to reach from one connecting point to the other, extensions are employed, which are or should be soldered to the carbon resistor pigtails, the entire length encased in black spaghetti tubing, which covers the connection. A loose or broken carbon resistance element in either section of the dual volume control will cause the same condition, upon vibration or when the shaft is touched slightly. Where the volume control is found faulty in this respect, the unit should be replaced.

The chief causes for an inoperative receiver on this model are either a broken porcelain condenser mounting bracket, wherein the stator plates will short to the rotor plates, or the lead connecting to the arm of the antenna potentiometer from the antenna binding post shorted to the metal braid with which it is covered for shielding purposes.

Noisy reception is often caused by loose fuse clips which are riveted to the insulated mounting bracket. These rivets corrode and loosen, and upon vibration will cause noise. The volume control is also a frequent cause for this complaint. The carbon resistance element cakes or cracks, making this unit a source of much noise.

Where the condition of weak and distorted reception is encountered, which can be cleared up by throwing the phono-radio switch to the phono position, the detector cathode bias resistor will be found at fault. This resistor is a black 50,000 ohm carbon unit.

— NOTES —

When all tubes, circuits, and voltages have checked perfectly, and the cause for the complaint of poor tone and low volume cannot be traced, look for an open-circuited or burnt-out field coil of the dynamic speaker. Because of the fact that the field coil is not connected in the usual manner (as a series choke in the power supply or part of a series voltage divider system), but is connected across the D.C. voltage supply after the first filter choke, it is often left out of all calculation. Although it is necessary to disconnect one of the leads to properly check the winding, a screw driver or other iron or steel object may be held near the pole piece—if the field coil is intact, a strong magnetic attraction will be present.

When a new volume control is installed in this receiver, it is important that the long screw holding the two controls together should not short to the chassis as this will ground the arm of the antenna portion of the control to the chassis. The screw passes through the connecting link of the arm.

Noisy and unstable operation has been traced often to the orange 65,000 ohm carbon resistor connected from one of the Mershon condenser lugs to the plate of the 1st audio tube. In some instances, this unit will be found carbonized to a much lower value, reducing the gain of the 1st audio amplifier.

The symptoms of choky, distorted, and weak reception has often been found due to an open-circuited 100,000 ohm green carbon resistor in the secondary return circuit of the push-pull input transformer. This failure will manifest itself by an excessive plate current reading and lack of grid bias obtained with a set analyzer when checking the output stage.

Oscillation and general instability, particularly at the higher frequencies, has been traced to an open 35,000 ohm pink carbon resistor connecting from the screen of the 1st R.F. tube to chassis. This failure disturbs the voltage divider system, and slightly increased screen and plate voltages result.

— NOTES —

Should the uncommon situation be encountered where one or two stations will be received almost over the entire dial, look for a tuning condenser shaft that has loosened from its pulley or a broken tuning-belt drive. The variable condenser will remain in a fixed position when the station selector is rotated and broad tuning will result. The remedy in either case is obvious. The complaint of weak reception at the higher frequencies may be often corrected by realignment of the tuning condensers. With the receiver tuned to a weak station at the extreme high frequency portion of the dial, the nuts holding the condenser shafts to the pulleys should be loosened and the condensers adjusted for best reception or maximum output.

In some receivers, adjusting the tuning condensers at or near the point of resonance will result in a highly microphonic condition, which cannot be eliminated unless one of the condensers is thrown slightly out of alignment. This is not considered good practice, however, and should only be attempted as a last resort. If the detector 24 tube is not microphonic (the 24 tubes should be interchanged to secure one that is least affected by the vibration, for the detector), then the condition is due to vibration of the variable condenser plates. This fact can be determined, by holding an insulated object firmly against one of the four tuning condensers, in turn. An ordinary lead pencil with an eraser at one end will do. When the guilty condenser is located, small felt washers may be placed between the stator plates in such manner that they will not interfere with the action of the rotor plates.

### Colonial 32 D.C.

This model, like its A.C. brother is notorious for fading, and almost the same failures producing the condition on the model 32 A.C. will be found the cause of fading for this model. The .1 mf. audio coupling condenser and

— NOTES —

the 1728 condenser blocks in the R.F. stages, and the 1780 block in the detector stage are the chief offenders, as well as the detector screen bypass condenser, a 4404-P unit. Connecting this latter condenser from screen to cathode of the detector tube instead of screen to chassis will show a marked increase in volume.

Where it is desired to increase the selectivity of the receiver, the 750,000 ohm red carbon resistor in the 3rd R.F. secondary return circuit may be shorted out. In some instances, this procedure may result in a slight hum and to overcome this difficulty a 10,000 ohm resistor should be inserted in place of the original unit.

### Colonial 33 A.C.

The condition of weak reception and poor quality on this receiver, is often caused by an open-circuited 100,000 ohm resistor in the secondary return circuits of either the 1st or 2nd R.F. stages. These resistors make up one unit which is mounted upon an insulating strip on the side of the push-pull input transformer. The failure will be made evident only by a slightly higher plate current drawn by the first and second R.F. tubes and not by a lack of control grid voltage which in any case cannot be measured correctly, even with a 1,000 ohms-per-volt meter, because of the high resistance in the secondary circuit.

One of the most frequent causes for an inoperative receiver is an open 60,000 ohm section of the three section voltage divider. This will be known by the lack of screen voltage on the screen grid tubes. In one particular instance, as reception from two near by powerful broadcasters was obtained, this failure was not suspected at first and a good deal of time was lost before finding the section open. Should the 11,000 ohm section of this divider open, no plate voltage will be obtained upon any of the R.F. tubes. Open-circuiting of the 50,000 ohm section will result in oscillation and slightly higher volt-

ages upon the plates and screens of all tubes.

The complaint of oscillation, and intermittent reception, is commonly caused by an open-circuited .5 mf. screen bypass section or .2 mf. plate bypass section of the R.F. condenser block, located near the R.F. tube sockets.

Where oscillation is encountered on either the high or low frequencies, or should the low frequencies be received weakly when the receiver is aligned at the high frequencies, and vice-versa, the trouble will be found due to an open-circuited .02 mf. secondary return bypass condenser in the R.F. circuits. These condensers are located within the coil shields, soldered directly to one of the coil terminals.

Distortion with the absence of grid bias on the output tubes has often been traced to an open 100,000 ohm carbon resistor in the grid return.

An inoperative receiver is often caused by an open 210 ohm section of the 420 ohm wire-wound resistor in the high voltage secondary return circuit. Usually the low side of the section connected to chassis is the one to first go.

The complaint of weak reception with all voltages and tubes correct, has several times been traced to an open

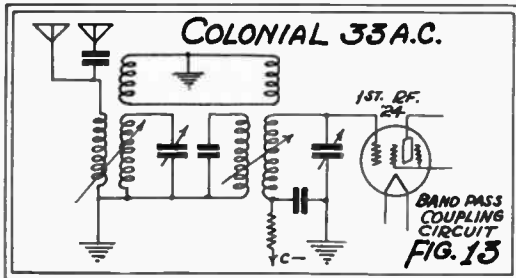

band-selector coupling coil. Two such coils are used to couple the two portions of the band selector, and as these coils are not part of the electrical circuit of the receiver.

— NOTES —

they are often overlooked. They are located within the first and second band-selector coils and connected to one another, one side being grounded. This is clearly shown in Figure 13. The open-circuit often consists of a break in the coil lead, usually at the lug, which can easily be repaired.

The method of controlling volume in this model is rather novel. This is done by varying the distance and consequently the coupling, between the primary and secondary of all R.F. coils. Should it be found that the volume level cannot be changed, it is probably due to a broken cable used to vary these inductances, or a cable that has slipped from its pulley.

### Colonial 47

This receiver is serviced frequently because of a continuous hum during operation, that could not be traced to any defective component part. A great deal of time spent toward eliminating this condition, disclosed the fact that the hum was inherent and probably due to improper design and shielding.

### Crosley 609, 610

The most frequent complaint with this receiver is oscillation at some point in the broadcast band, usually at the high or low frequencies. This oscillation, assuming that the tubes are good and all bypass condensers intact, may be eliminated by readjusting the angles or position of the three R.F. coils in relation to one another, the most critical being the detector coil, which is the first toward the front of the set.

Lack of sensitivity or selectivity can often be remedied by employing the procedure outlined above, as this will tend to bring the circuits closer to the point of oscillation resulting in an amazing improvement. Unlike other Crosley receivers, this model is not equipped with any



compensating or neutralizing condensers, good operation depending upon the adjustment of the coils.

The condition of distorted reproduction, with the lack of grid bias and excessive plate current drawn by the power tube is often caused by an open-circuited 10,000 ohm blue carbon resistor in the secondary return circuit of that stage.

Noisy tuning on this model is due to a corroded flat tension spring at the end of the variable condenser rotor shaft. This contact should be carefully cleaned and its tension increased by moving the collar on the shaft holding it in position still further toward the front of the set. In a short time however, this contact may again prove faulty and to obviate any possibility of a repeat call, it is best to solder or secure a flexible pig-tail, such as a length of phosphor-bronze drive cable, to the condenser shaft, the other end being fastened to the chassis. This pig-tail will make possible a perfect electrical connection between the rotor and chassis, instead of merely a mechanical one.

### Crosley 706

Noisy tuning on this model is also caused by a corroded flat tension spring at the end of the condenser gang rotor shaft and should be remedied, without delay, by cleaning and the installation of a pig-tail as described with the model 609, 610.

Where it is found that the voltage output is shorted to chassis, look for shorting filter choke leads. These leads are brought out through an opening in the chassis through rubber sleeving, which dries and cracks, often exposing the choke leads to the chassis. The defect may be corrected by removing the filter choke and renewing the insulation. Another cause for the same condition lies with the speaker field pin-jacks shorting to the chassis through the insulation. The easiest and quickest remedy for this failure is replacement of the pin-jack assembly.

- **D U C O** -

**ELECTROLYTIC CONDENSERS**  
GUARANTEED 1 YEAR

Manufactured by  
Dumont Electric Co.  
453 Broome Street  
New York, N. Y.

U. S. Patent  
1,704,911

Where the reproducer employed, is of the magnetic type, the two leads soldered to the pin-jacks may be removed and connected together, wrapping the splice with tape.

Noisy operation of the volume control may be remedied by an application of Nujol, after the contact arm and that portion of the resistance over which it passes has been cleaned carefully so as not to cause any breaks, with an emery board, procurable at any 5 & 10.

Oscillation and general instability has been traced on several occasions, to an open-circuited 226 filament bypass condenser. The capacity of this unit is .5 mf., although better results will be obtained if replacement is made with a 1 mf. bypass condenser.

### De Wald 632 D.C.

This receiver will become inoperative, if the ground wire should momentarily touch any part of the receiver chassis, through failure of the 6 volt pilot light, which is connected in series with the filaments of the type 30, 31, 32 two-volt tubes employed in this model. Should the pilot light burn out, the filament circuit is open. Because of the inconsistent quality and the fluctuating nature of German or Japanese-made bulbs, the pilot light should be replaced only with an American Mazda.

### Earl 21, 22 D.C.

When replacing or repairing the variometer tuning the antenna circuit, in these receivers, it is important that the shaft is carefully insulated and cannot short to the chassis. A burnt-out coil and most likely, a "shot" tube will be the result, if this should occur.

The unusual situation is often encountered on these models, where a reversed plate reading on the R.F., detector and first audio tubes will be obtained, although the polarity of the voltage on the output tube plates will be correct. This condition is caused by the short-circuiting

of the 2 mf. filter condenser connected from the negative side of the line supply to the receiver side of the "B" filter choke. This condenser is identified by the blue lead emerging from the condenser block. An explanation for this reversed polarity obtained on the R.F., detector and first audio tubes, lies in the fact that the high voltage impressed on the output tubes is not filtered by the choke, but is obtained directly from the positive side of the line as shown in Figure 14.

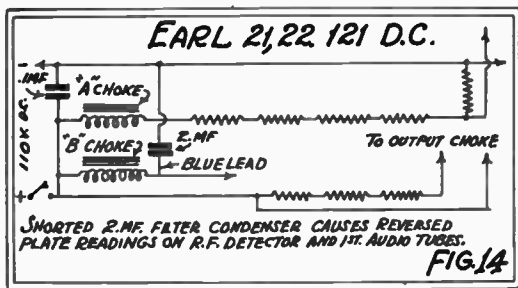

Oscillation of a low whistle on these receivers is often caused by a leaky detector plate .001 mf. bypass condenser. In cases where replacement of this unit does not entirely eliminate the condition, an R.F. choke should be inserted in the detector plate circuit, and another .001 condenser connected between the choke and the negative detector filament.

When re-neutralizing or adjusting the gang compensators, only an insulated neutralizing tool should be employed, as an accidental shorting of the condenser adjusting nut to the chassis by a metallic socket wrench or "Spin-tite", will cause one or more tubes to "go."

### Eveready 1, 2, 3

See Data on Bosch 28, 29.

— NOTES —

**Eveready 52, 53, 54**

See Data on Bosch 48, 49.

**Fada 10, 11, 30, 31**

These sets are frequently serviced because of noisy reception which cannot be cleared by replacement of tubes, and is definitely determined as originating within the receiver itself. Before much time and effort is expended, the first and second audio transformer primaries should be checked. Due to defective insulation, electrolysis, or moisture, which conditions may be remedied by removing the unit and heating, the primary winding becomes noisy. This fact can be readily ascertained by disconnecting the questionable primary winding, and substituting a 50,000 ohm carbon resistor in its place, coupling the two stages by means of a .01 mf. condenser.

An inoperative receiver or one that functions weakly, is often due to shorted or grounded lugs on the R.F. coils. These lugs, to which the coil ends are soldered and connections are made, are riveted to the bottom of the coil forms, and upon vibration will shift and short to one another or to the chassis. To rectify this condition, the lug rivets should be compressed tightly with strong pliers to prevent them from altering their position. When replacing the volume control on this receiver, the red lead should never be soldered to the center terminal of the potentiometer, as this connects to the variable arm and shaft, which is grounded. The error in connecting this lead will result in grounding the grid of the second R.F.

Poor selectivity of this receiver is often due to an open-circuited or "shorted" secondary coil in the wave-trap or rejector circuit. This coil, which is tuned by a midget variable condenser, cannot be checked by a socket analysis, for it is in no way connected in the electrical circuit of the receiver, being inductively coupled to a small primary winding which is in series with the primary of the an-

tenna coil. Hum and distorted reproduction is caused by the pilot light shorting to the chassis. This grounds the second audio bias resistor and disturbs the center-tapping arrangement.

### Fada 16, 17, 20, 32

The condition of weak or no reception encountered in these models is caused by the lugs on the R.F. coils shifting and shorting to one another or to the chassis upon vibration as described with the Model 10.

Noisy reception, not caused by any external source, has often been traced to a faulty first audio transformer primary winding. Applying the full D.C. output of the receiver across the primary with all leads disconnected from it, for a second or two, or heating the unit to remove any possible moisture, has often cleared up the condition. This obviates the necessity of replacing the transformer, although the latter may be preferable.

A sharp drop in volume accompanied by oscillation, has been traced on many occasions to an open-circuiting cathode or plate by-pass condenser. Both these .25 mf.

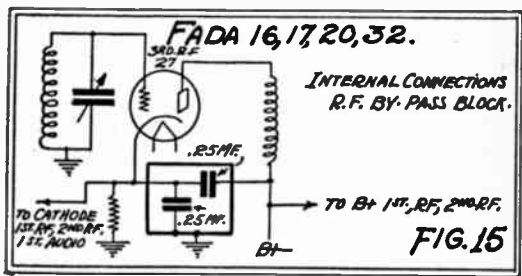

condensers are contained in a single unit, the plate by-pass return being connected to the cathode internally as shown in Figure 15.

The model 20 is in all respects similar to the Models

16 and 17, except for the fact that the first filter choke has been omitted and a receptacle provided to connect the field coil (which is used as the filter choke) of a D.C. dynamic speaker. The output transformer employed in the Models 20 and 32 has a secondary winding, whose impedance properly matches the voice coil impedance of the dynamic speaker; whereas the secondary of the output transformer used in the Models 16 and 17 is of the high impedance type to match a magnetic speaker.

### Fada 25

All symptoms and failures, and their causes and remedies, described with the Model 10, regarding shorting coil lugs, noisy audio transformer primaries, and "shorted" pilot light, apply equally to the Model 25.

Intermittent reception which has been traced to the output stage by a process of elimination, has often been found to be caused by faulty connection of the phone tips to the tinsel cord connecting to the output transformer on the speaker. Although the phone tips may be heated and sweated with a soldering iron, the best repair will be made if the tinsel cord, which is a constant source of trouble, is removed, and well insulated stranded copper leads are installed.

The condition of a loud hum on this model, which may be caused by an open-circuited filter condenser, but more often is not, has been traced to either one of two defects. The condenser block is grounded to the chassis by means of a screw and nut, which loosens under vibration. The faulty contact results in an abnormal hum. Due to the heat generated by the 80 rectifier, the adjacent rubber covered leads emerging from the top of the condenser block, crack and peel or become spongy, and the leads short to one another. The red and yellow leads short to one another, shorting the filter choke out of the circuit and the effect of a shorted filter choke is obtained.

A sharp decrease in volume and circuit oscillation is

often caused by open-circuiting plate or cathode bypass condensers which are contained in the same metal case and connected as has been shown before in Figure 15.

### Fada 35

The symptoms or troubles and their cause as discussed with the Fada 25 will also apply to this model, the same conditions having been encountered and rectified in like manner.

Intermittent or noisy reception has often been traced to the double volume control, caused by corrosion of the movable contact arms, which should be carefully cleaned and bent slightly to increase their tension.

### Fada 41, 43, 44, 46, 47

A common complaint with these receivers is that of hum, which is more or less often caused by the 27 tubes in the detector amplifier and 1st audio stages, with poor cathode-heater insulation. In this respect, the old slow heating type tube is better than the newer quick heating 27 with thinner cathode-heater insulation. Where it is found, however, that replacement or interchanging the 27 tubes will not eliminate the hum, look for an open-circuited .5 mf. condenser bypassing the detector amplifier cathode. This condenser is one of two, in a block mounted at the front of the chassis. Should both tubes and condenser prove perfect, the condition may be overcome almost invariably, by shunting the .5 mf. unit with a small 10 mf. electrolytic condenser whose working voltage need not be more than 25 volts.

The cause of a weak and insensitive receiver has often been traced to an open 50,000 blue carbon resistor in the diode detector plate circuit. This failure will not be disclosed by a set analyzer, for a plate voltage reading cannot be obtained on the two-element detector tube in any event.

The complaint of intermittent reception on these models has been traced to one of either two circuit failures, although the condition may be caused by the failure of any component part. The most common cause and the one found more often, is open-circuited secondary windings of the R.F. coils. Due to vibration or contraction of the wire, the coil leads snap directly at the lug and make contact intermittently. It is advisable when checking these receivers for this complaint, to resolder all coil connections and not be satisfied with a continuity check only. The open-circuiting of the .01 mf. condenser, coupling the detector amplifier and first audio stages, is frequently the cause for the same condition and should be replaced where it is so found. Incidentally, this condenser will be found leaky on some occasions, resulting in distorted reproduction or no reception, depending upon the change in impedance. Where the unit has a high resistance leak, a zero grid bias reading may be obtained on the first audio tube as the positive charge leaking through the condenser will neutralize the negative bias impressed upon the grid.

It is not necessary to remove the chassis when replacing a burnt-out pilot or flashograph light in this receiver. If the escutcheon plate is removed, the celluloid dial may be taken off after removing the screw and washer holding it in position. Because of the small cut-out in the wood panel, the celluloid dial must be bent to remove it. This may be done without fear of breakage because of the flexibility of the celluloid. The pilots are now easily accessible. To prevent these bulbs from loosening under vibration and lighting intermittently, a drop of solder may be placed on the base of the bulbs to assure good contact. When replacing the dial it is important that the small hole in the dial should line up with the pin on the cast-iron dial frame. The escutcheon plate should be reinstalled so that the key used to slot the celluloid dial, may be inserted freely into the opening provided for it.



When replacing any one of the three filter condensers employed in this receiver, the mistake often made is that of disconnecting the "shot" section and installing a 2 or 4 mf. unit from that point to ground. This will result in a loud hum as the second terminal of the condenser should be connected to the high voltage secondary return circuit and not directly to ground.

### Fada 43, 761, 762, 764, 766

Fading or intermittent reception on these models has been traced in most instances to an open-circuiting section of the cathode-plate R.F. bypass condenser block, or an open-circuited .5 mf. screen bypass condenser, the latter unit generally causing the trouble.

The complaint of oscillation and especially distortion, at any volume level, is often due to a faulty carbon resistor connected from detector screen to chassis. Where this condition is encountered, the resistor may be found to have open-circuited, or changed to a higher value from the specified 125,000 ohms. Although the difference in detector screen voltage is negligible with a higher resistance or an open-circuited unit, it is essential that the value be correct or circuit oscillation and distortion will result.

### Fada 45, and 48, 49

Alignment of these receivers is often confusing because of the different location or position of the alignment condensers. The I.F. trimmers in the model 45 are located in the rear right-hand corner of the chassis as shown in Figure 16. Due to the fact that the primary of the second intermediate transformer is not tuned, there are only three condensers to be adjusted at the intermediate frequency the fourth trimmer being the oscillator series condenser, which is aligned at 600 K.C. The model 48 and 49 receivers have four I.F. compensating condensers lo-

cated at the rear of the chassis as shown in Figure 17. The oscillator series condenser, which is adjusted at 600

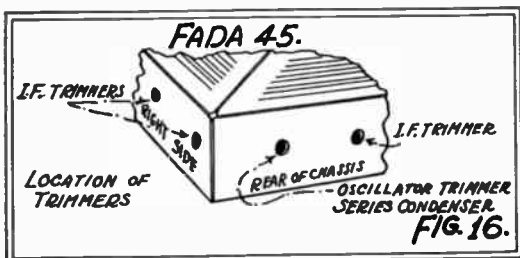

K.C. while "rocking" the tuning gang is accessible from the top of the chassis and is located to the right of the

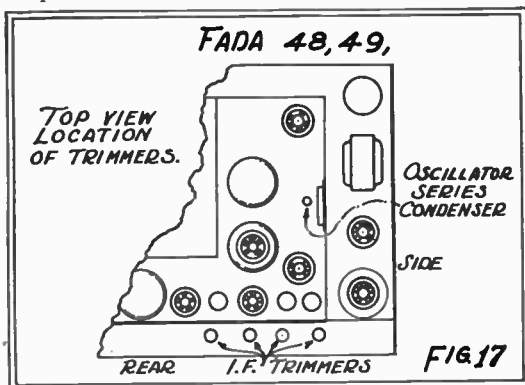

second detector socket. The tuning gang is aligned by adjustment of the compensators on top of each section.

### Freed Eisemann NR 60

Noise is a frequent complaint with this model and has been traced in most instances to either the variometer tap

switch or the volume control. The contacts and contact arm of the variometer corrode and upon a slight vibration will produce noisy reception. After all contact parts have been cleaned, the switch arm should be bent to increase its tension. The volume control, being of the carbon type becomes noisy, due to loose carbon particles and uneven wear after the unit has been in service for some time

### Freed Eisemann NR-80

The volume control used in this receiver is somewhat different than those used in any other and because of its construction is more liable to mechanical difficulties. If the volume drum is forced slightly beyond the limits of the resistance strip, the contact arm will bend and twist out of shape, usually snapping the resistance winding in several places. Should the complaint of "no control of volume" be received, look for a volume control contact arm that is not riding upon the resistor strip.

Hum and distortion on these models can usually be traced to either one of the hum controls shorting to the chassis at some point. This shorts the biasing resistor out of the circuit and disturbs the center-tapping arrangement.

### Freshman Equaphase

The condition of oscillation or broad tuning with this receiver is almost always caused by incorrect adjustment of the equalizing condensers in the R.F. stages, assuming all tubes are in perfect condition. The adjusting screws for these equalizing or stabilizing condensers are located to the right of the first, second and third R.F. tube sockets. To overcome oscillation, one or more of these screws should be turned slightly counter clock-wise until the oscillation ceases. This is done with the receiver tuned to some station at approximately 1200 K.C. In most cases, it has been found that it is only necessary to

— NOTES —

adjust the second or third stabilizer to correct the condition. Broad tuning may also be eliminated, more or less, by adjusting the same condensers. Tighten (clockwise) each of the three adjusting screws. This will cause the receiver to oscillate strongly. Then loosen the screws slowly until the oscillation ceases, leaving the receiver adjusted just beyond the point of oscillation.

An inoperative receiver is often due to the trimmer condenser which is shunted across the first section of the tuning gang. The mounting nut loosens and the condenser shifts enough to permit the stator plates or connecting lug to short to the chassis. The difficulty is easily rectified. In other cases, the inoperative condition is due to the fact that the hum control contact arm is not making contact to the resistance. This opens the R.F. and first audio bias resistor circuit and is recognized by the lack of plate voltages on these tubes when checked with a set analyzer.

The model G-60-S power pack used with this receiver uses the following arrangement of its numbered terminals,

No. 1, No. 2	1½ volts A.C.
No. 3, No. 4	2½ volts A.C.
No. 5, No. 6	5 volts A.C.
No. 7	45 volts D.C.
No. 8	145 volts D.C.
No. 9	225 volts D.C.
No. 10	B—

### Freshman Masterpiece

There were two receivers released under this name, with one using 15 volt tubes. Power packs intended for one model were often inter-changed mistakenly with the other, resulting in burnt-out tubes and other damage. To clear up any possible difficulties, the terminal arrangements of the two power packs are given. The model ERAC power pack terminals are as follows:

No. 1, No. 8	2½ volts A.C.
--------------	---------------

— NOTES —

No. 2, No. 6	5	volts A.C.
No. 3, No. 4	1½	volts A.C.
No. 5	135	volts D.C.
No. 7	50	volts D.C.
No. 9	B—	

For the 15 volt model:

No. 1, No. 2	5	volts A.C.
No. 3, No. 4	15	volts A.C.
No. 5	165	volts D.C.
No. 6	90	volts D.C.
No. 7	30	volts D.C.
No. 8	9	volts D.C. for detector tube
No. 9	B—	

### Freshman Q15, Q16, 3Q15, 3Q16, QD-16-S

Noisy and intermittent reception on these models has invariably been traced to defective flexible pig-tail resistors. The best procedure for ascertaining this fault is that of pulling or moving the resistors while the set is operating.

A bad resonance hum is caused by a poor 222 tube in the R.F. stage or an open-circuited .25 mf. condenser bypassing the filament circuit of this tube. Even though the 222 tube may be perfect, a certain amount of resonance hum is always present with these receivers, which can be eliminated by substituting an indirect heater type screen grid tube such as the 24 or 57 for the 222 tube. This necessitates changing the socket for one that will accommodate the tube selected. The filament supply leads for the 222 should be removed and taped up separately, the heater supply for the new tube being obtained from the same filament winding supplying the 227 detector tube. The only other change necessary, is removing the 222 bias resistor from the center tap of the 3.1 volt winding and connecting it to the cathode of the tube used, bypassing the resistor with both the 222 filament bypass condensers.

— NOTES —

If a type 57 tube is used, the suppressor grid is tied to the cathode.

Broad tuning or oscillation, as the case may be, may be corrected by readjustment of the regeneration condenser connected from the plate of the detector tube to the antenna connection.

### **Freshman N**

Fading or an inoperative condition of this model is frequently caused by loose terminals on the power pack connection strip. Usually the 226 filament leads are found loose under the terminal screws. As these tubes take a second or so to fully heat or cool, a poor terminal connection will result in fading.

The R.F. and first audio tubes are heated separately by two 1½ volt windings, in this model. Where one of these windings is found open-circuited, the other may be used to carry the other tube or tubes. If the first audio winding is at fault, the two filament leads should be shunted across the R.F. winding, and vice-versa. In the latter case, however, the first audio bias resistor is removed and R.F. bias resistor (500 ohms) is installed in its place.

### **General Electric H 31**

See data on Radiola 80.

### **General Electric H 32**

See data on RCA-Victor R 50.

### **General Electric T 41**

See data on Radiola 48.

— NOTES —

**General Electric H 51**

See data on Radiola 82.

**General Electric K 62**

See data on RCA-Victor R-11.

**General Electric K 65**

See data on RCA-Victor R-38.

**General Electric H 71**

See data on Radiola 86

**General Electric H 72**

See data on RCA-Victor RAE-59.

**General Electric J 88**

Intermittent or fading reception on this model is frequently caused by open-circuiting condensers bypassing to ground, the R.F., 1st detector and I.F. secondary returns, which are in the A.V.C. circuit. Where these condensers remain open-circuited, the symptoms of station hiss and oscillation may be encountered.

**General Electric J100, J105, J107**

See data on RCA-Victor 74, 76, 77.

**General Electric J109**

See data on RCA-Victor RAE-81.

**General Electric J125**

See data on RCA-Victor R78.

— NOTES —

**Graybar GB 9**

See data on RCA-Victory R-11.

**Graybar GC 10-69, 10-88, 10-99**

See data on RCA-Victor R-74, R-76, R-77.

**Graybar GB 100**

See data on RCA-Victor R-50, R-55.

**Graybar GB 700**

See data on Radiola 80.

**Graybar GB 770**

See data on Radiola 82.

**Graybar GB 900**

See data on Radiola 86.

**General Motors 120, 130, 140, 150, 160**

The condition of oscillation and noisy tuning is more frequently the cause for complaint on these models than any other symptom. In some cases, tuning is so erratic or difficult, that the station cannot be tuned in. Invariably, the trouble has been found due to corroded or faulty condenser gang rotor ground contacts, to which the secondary return leads of all R.F. coils are brought out and soldered. Not only will this defect occasion noisy tuning and oscillation, but often result in an inoperative receiver. The contacts should be carefully cleaned and bent to secure more tension. To make the job a complete and more satisfactory one, the secondary return leads should be removed from these contacts and soldered or fastened in



some way to make good electrical connection to the chassis. An open-circuiting screen bypass section in any one of the three condenser blocks in the R.F. stages, will and has often produced the same condition.

Where the symptoms of fading or a sharp cutting-off of reception are encountered, which effect can be reproduced by striking the chassis, has often been traced to an open-circuiting .01 mf. audio coupling condenser, or to a defective antenna section of the dual volume control. This unit is of the carbon type and cannot readily be taken apart for the purpose of repair. The remedy in both instances, is replacement of the defective component.

In these receivers, the complaint that the control of volume is not gradual or too sharp, is often received. This fault can be rectified by replacing the 24 in the first R.F. stage, with a type 35 tube in receivers bearing the serial numbers above 29,100, these chassis having a variable cathode bias type of volume control.

Where it is found that stations are not received at the proper frequency on the dial, it will be necessary to realign the receiver or re-allocate the dial scale or both. If the low frequencies are received at the proper setting, then the receiver should be tuned to some station at approximately 1400 K.C., and the condenser gang compensators adjusted so that a 1400 K.C. oscillator signal comes in at 1400 K.C. on the dial scale. If neither the high nor low frequencies are received at the correct dial setting, then the dial scale should be shifted so that a low frequency station or signal is received at the exact dial scale frequency. The receiver is then tuned and aligned by adjusting the compensating condensers in the same manner as described above.

Should the receiver fuse "blow", when the line switch is snapped on check for short-circuited or leaky .1 mf. buffer condensers connected across the line supply with their mid-point grounded.

The condition of an abnormal hum has often been found caused by a short-circuited .1 mf. "tuning" con-

denser connected across the filter choke. This condenser is connected across two lugs on the A.C. terminal strip and located beneath the strip as shown in Figure 18.

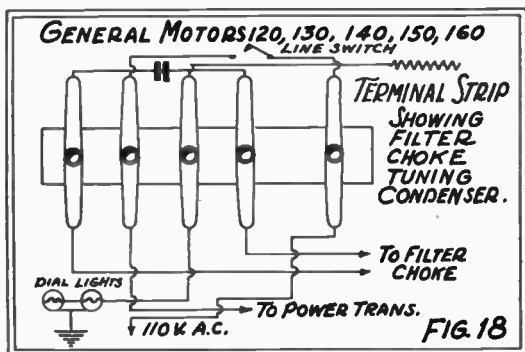

### General Motors 252, 253, 254, 255, 256, 257, 258

When the unusual situation is encountered on this model, where the receiver is inoperative until the A.V.C. 27 tube is withdrawn from its socket, check the 2 megohm carbon resistor in the grid circuit of the A.V.C. tube. Failure of this resistor removes the negative bias upon the grid of the A.V.C. tube thus increasing the negative voltage output of the A.V.C. tube, and consequently the control grid bias upon the R.F. and I.F. tubes, to such a high degree that the amplification of these tubes is greatly reduced, resulting in an inoperative receiver.

The symptoms of distortion and almost twice the grid voltage on the output tubes, as disclosed by a set analyzer, is due to a burnt-out 100,000 ohm section of the voltage divider across the speaker field, which is in the negative return of the high voltage winding. This arrangement is the same as that used in the Atwater Kent 55 and shown in Figure 3.

#### — NOTES —

Also on models 252 a condition of volume cutting low and the IFs not staying in balance is due to two plates of an 1<sup>st</sup> trimmer not being properly soldered together. Sometimes necessary to remove & check all three coils before offender is located. Same condition also occurs in model 251

The annoying condition of a loud buzz, which rides in above broadcast reception at regular or irregular intervals, has been traced to the 24 tube in the first detector stage. Although this tube may test perfectly in several tube checkers, some internal defect (loose elements) will cause this noise complaint. Several type 24 tubes should be tried to secure one that will operate satisfactorily in this stage.

### Kennedy 26, 526

A frequent cause for an inoperative receiver or a noisy one, lies with a shorted or shorting condenser gang compensating condenser. The condition is due to the cracking of the insulation between the compensator plates. In order to repair this difficulty, it is necessary to remove the condenser gang shield. Adjusting the compensating condensers requires the removal of the tube shields or an offset screw-driver may be used.

### Kennedy 30, 32, 632

Fading is the principal cause for complaint on these

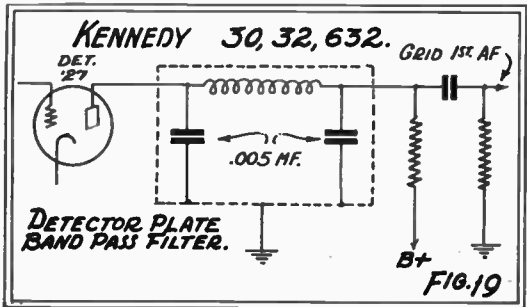

models and is due to various portions of the receiver. Only the most common and frequent failures will be dis-

— NOTES —

cussed herein. The nature of the fading is that of an intermittent character, which may clear up as soon as the chassis or tubes are disturbed to make any test, making repair difficult.

Where this condition is encountered and the symptom of low detector plate voltage is found with a proportionate decrease in all other plate voltages, check the detector plate filter assembly, which consists of an R.F. choke and two .005 mf. bypass condensers, connected as shown in Figure 19. These two condensers break down intermittently and become leaky. If the detector tube is withdrawn or reinserted into its socket, the leaky condition and the fading will disappear. As one side of each of these condensers is connected internally to the metal case of the filter assembly, it is not necessary to replace the entire unit. Insulate the can from the chassis and connect two .005 mf. condensers externally from both sides of the R.F. choke to chassis.

The .06 mf. Sprague audio coupling condenser will produce a similar condition, although in this case, all voltages will be intact. Due to the poor electrical contact of the connecting tabs, which depend almost solely upon pressure for contact, the condenser open-circuits upon vibration of the chassis caused by strong signals.

If the intermittently operating receiver can be made to perform after reception has ceased, by withdrawing and reinserting either of the two 45 power tubes, invariably the trouble will be found to lie with an intermittently open-circuiting voice coil of the dynamic speaker. This voice coil, presumably for the purpose of obtaining a light weight unit, is wound with wire resembling aluminum, to which the connecting leads cannot be soldered, connection being secured by mechanical means. Vibration of the cone causes the contacts to open-circuit, resulting in the fading. Should pinching the connection with strong pliers fail to eliminate the defect, a new cone not employing the same type voice coil, should be installed.

## Kennedy 62, 62A

Intermittent reception on these models has often been traced to the snapping of the stiff green lead connecting to the stator of the first tuning condenser. Rocking the condenser gang upon its rubber mountings will produce the same condition. As the gang assembly has a certain amount of play every time the receiver is tuned because of the rubber mountings, it is advisable to replace the green lead with a more flexible one.

Fading has been found due to corroded contacts or insufficient blade tension of the frequency switch in the two tube short wave converter. This switch, besides its frequency changing functions, when placed in the broadcast position, connects the antenna and ground leads to the broadcast chassis. In any of the short wave positions of the switch, the antenna and ground leads connect to the input of the converter, whose output is fed to the broadcast chassis. Vibration causes the switch blades to shift and because of the poor contacts, fading will result.

## Kolster 6F, 6J, 6K, 6L, 6M, 6R

Fading on these receivers is caused by poor contact of the movable arm of the volume control which controls the filament voltage of all four type 26 tubes. Because of the heavy current passing through this control, the contact arm and resistance strip become corroded. This may be remedied by cleaning the resistance with steel wool or fine sand-paper. After the contact arm has been cleaned, it should be bent to increase its tension.

A howl, that is heard when the receiver is first switched on, is caused by unequal heating of the 26 and 27 tubes. The condition may be rectified in most cases by shunting a 100,000 ohm carbon resistor across the secondary of the first audio transformer. Although this will result in a slight drop in volume, it will also lower the hum level.

An annoying buzz can often be eliminated by shielding

the 227 detector tube and grounding the shield.

Choked and weak reception has been traced on several occasions to a short-circuited 2 mf. speaker output condenser located in the power unit, an integral part of the condenser block.

### **Kolster K20, K21, K22, K23, K24, K25, K27, K28**

The presence of a high pitched whistle on some of these receivers is a complaint frequently received. Where it is not caused by the speaker cord being too near the 27 detector tube, the trouble may be remedied by placing a grounded shield over the 171-A power tube, and not the detector tube, as would seem more logical.

Because of the unequal heating of the 27 and 26 tubes, a loud howl will be heard when the receiver is switched on. The length of time taken for this howl to subside, depends upon how long the detector tube takes to heat. Although replacing the 27 tube with a quick-heating type will sometimes eliminate or reduce the duration of the starting howl, it is possible to rectify the condition in almost every instance, by connecting a 100,000 carbon resistor across the secondary of the first audio transformer. This will not affect volume to any appreciable degree, and will have marked effect upon reduction in the hum level, besides emphasizing low frequency response.

These models are serviced frequently for fading and noise, the latter condition caused by some defect within the receiver. One of the causes of both these symptoms, lies with the carbon type volume control which is connected across the primary of the third R.F. coil. The resistance element becomes worn, and upon the slightest vibration, will cause noise or fading. In some cases, the unit has been repaired by wiping the surface of the carbon strip with a soft cloth that has been dampened with alcohol, and cleaning the dirt and corrosion from the

roller and connecting arm. A majority of the noise complaints have been found due to noisy audio transformer primary windings. As both these audio transformers are contained in one unit, replacement becomes a somewhat expensive proposition. Disconnecting the primary winding from the rest of the circuit, and applying high voltage for a brief instant, has often cleared up the defect. Where this does not help, the unit should be removed and heated in an oven to dry up any moisture that may be present.

A frequent cause for noise in this receiver, characterized by a sputtering and crackling, has been traced to the voltage divider. Imperfections of a metallic nature in the vitreous enamel covering the resistor, and blistering of the enamel, permits moisture to be absorbed. Arcing at these points produces the interference.

A strong microphonic condition, often found when the receiver is tuned to resonance, is due to vibration of the tuning condenser plates. The insertion of small felt washers between the plates of the condensers to dampen the vibration, is impractical because of close spacing. One solution to the problem is that of adjusting the R.F. circuits further from the point of oscillation. Although this may be done by increasing the value of the grid suppressors, it is accomplished more satisfactorily by removing the small fixed condensers which are connected across the three grid suppressors, removing the condenser across the third suppressor, first. This method is preferable to that of increasing the grid suppressor value, for the latter will tend to introduce broad tuning and insensitivity. Under no circumstances is it advisable to correct the condition by throwing off the alignment of the condenser gang, which, incidentally, is aligned by bending the slotted end rotor plates of the tuning condensers.

The cause for an inoperative receiver or intermittent reception has often been traced to a shorted detector tuning condenser compensator, which is located on the side of the

condenser gang housing. The mica insulation falls out, permitting the outside plate to short to the gang housing. As this condenser is usually of little consequence, it may be disconnected from the circuit, or another strip of mica may be installed, if it is so desired.

On many of the later production receivers, an adjustable condenser is connected across the last grid suppressor instead of the usual fixed condenser. Where the condition of oscillation is encountered, which is not caused by open-circuiting condensers or poor tubes, this regeneration control should be adjusted by turning the adjusting screw slightly counter-clockwise. Turning this screw to the right will bring the R.F. circuit closer to the point of oscillation and will improve reception of weak signals.

The adjusting screw is accessible through a hole to the left of the R.F. tube socket.

Noisy and intermittent reception has often been found caused by loose nuts holding the power pack cable terminal strip to the terminal screws on the tuning chassis.

### Kolster K43

The condition of hum is one of the most common causes for complaint on this model. In most instances it has been traced to vibration of the shield enclosing the power transformer, due to loose laminations of the latter unit. This situation may be rectified, after the laminations have been tightened, by stuffing the air space between the shield and the power transformer, which greatly amplifies the hum from the transformer, with non-inflammable material, to dampen the vibration. If it is permissible, the shield may be removed and discarded.

An unbalanced condition of the push-pull input transformer secondary will also cause hum. This may be checked by measuring the D.C. resistance of each section of the tapped winding. The only remedy in this case is replacement of the transformer.

— NOTES —



Fading on this model has almost always been traced to an open-circuiting screen bypass condenser whose capacity is .6 mf. Should the drop in volume be of a gradual nature, check the same condenser for leakage. The antenna portion of the dual volume control employs a carbon resistance element, which, if broken in one or more places, will produce the symptoms of intermittent, noisy or fading reception, upon vibration. Loose R.F. coils within the metal shields are frequently the source of a fading condition. The coils "float" to the side of the shield upon vibration of the chassis, thus changing their inductance.

### Kolster 70, 72, 75, 80, 82, 90, 92

All these models have one complaint in common, that of fading or a gradual decrease of volume, each time the volume control is advanced to off-set the decrease. In almost every instance, the fading has been eliminated by replacement of the A.V.C. 24A tube, although this tube will check perfectly. Several good 24A tubes must be tried in some cases before a satisfactory one is found. Weak reception at the high frequencies is also due in many instances to a poor A.V.C. tube.

### Majestic 20, 21, 22, 23

Where an inoperative receiver is encountered, with no plate voltage on the R.F. first detector and I.F. tubes, and low voltages, if any, on the second detector and output tubes, look for a shorted .1 mf. plate circuit bypass condenser *within* the second I.F. transformer. To effectuate a repair, it is necessary to remove the shorted bypass condenser from the circuit, although a new transformer may be installed. Unsolder all connections to the second I.F. transformer and remove the unit. If heated carefully, the sealing compound will soften and the transformer

may be removed from its shield. The condenser is now accessible and need only be clipped from the B+ side of the primary winding. Although a new condenser may be soldered into position, it is best to assemble the unit without the condenser and to connect the latter externally, after the transformer has been mounted upon the chassis.

An open 10,000 ohm oscillator grid leak has sometimes been found to be the cause of unstable operation and, in some instances, an inoperative receiver.

An audible hum upon resonance has been traced to one or both second detector cathode bypass condensers open-circuiting.

If the receiver becomes inoperative when the tone control is placed in the base position, and no plate voltage is obtained on the second detector tube, look for a short-circuited .022 mf. condenser in this circuit.

## Majestic 50, 52

Because these receivers were small and light as compared with previous larger models, they were not accorded the same treatment during shipment and handling. For this reason, it is often necessary to realign the R.F. circuits, whose adjustments have shifted because of the rough handling. This condition is made apparent by poor sensitivity and the fact that stations are received at an incorrect dial frequency. The I.F. trimmers seldom require adjustment. The oscillator trimmer condenser (1400 K.C.) is accessible from the bottom of the chassis and is the first compensator on the condenser gang on the dial side. The oscillator tracking condenser (600 K.C.) is accessible from the rear of the chassis, below the R.F., 24 tube.

A loud hum is often caused by an open-circuited filter choke "tuning" condenser, which is used to resonate the filter choke. The same condition has resulted when this condenser has been found short-circuited.

— NOTES —

The symptoms of reception fading out or cutting off, after the receiver has been operating a few minutes, have frequently been traced to a leaky .04 mf. oscillator coupling condenser, connected from the 1st detector cathode to the tap on the oscillator coil.

### Majestic 60, 61, 62, 160, 163

Where one of these receivers is encountered in an inoperative condition and no plate voltage is obtained upon any of the tubes, it is probably due to a short-circuited .1 mf. bypass condenser located within the first or second I.F. transformers. It is possible to repair this defect by removing the transformer in question and cutting or chopping out the rivets holding the shield assembly of the transformer together. If the unit is carefully heated, the wax compound will become softened and the defective condenser may be worked loose. As in the case with the model 20, a new condenser may be installed and the transformer re-assembled, or the condenser connected externally. A repair may also be effected by insulating the shield of the first I.F. transformer from the chassis, by means of insulated straps and fish paper. The ground connection of each trimmer condenser is then removed so that this side of the trimmers may be connected to the B+ side of the primary and the grid return of the secondary, respectively. Where it is found that the defective unit is located in the second I.F. transformer, and a repair is being made by insulating the shield of the I.F. transformer, by following the procedure outlined above, it will be necessary to disconnect the secondary return lead from the shield can and bring a lead out to the chassis.

When the situation is found where the receiver is inoperative until the A.V.C. tube is withdrawn from its socket, look for a "floating" connection to the lug on the small terminal strip located alongside the A.V.C. socket, which connects to the control grid lead of the A.V.C.

tube. This open-circuit causes the A.V.C. tube to draw such high plate current that an excessive control grid bias is impressed upon the R.F., and first and second I.F. tubes, rendering the receiver inoperative.

A great many of these receivers have been serviced because of the complaint of fading, erratic meter operation and, weak reception. These symptoms are caused by leakage between the porous cotton-covered leads, and leaky .02 mf. and .06 mf. R.F. and 1st detector secondary return bypass condensers, as well as a porous 5700 ohm blue carbon resistor in the voltage divider system. The circuits affected by the highly absorbent cotton-covered leads are the secondary circuits of the R.F. and 1st detector stages. To correct this condition, it is necessary to substitute good rubber-covered wire for the leads connecting the tuning condenser gang to the coils. Replace also the R.F. and I.F. control grid leads, the orange lead from the plate of the A.V.C. tube to the terminal strip below the 2nd detector socket, the lead from this lug on the terminal strip to the secondary return of the first I.F. transformer and, the leads to the R.F. and 1st detector secondary returns, with rubber-covered wire. New high quality .02 mf. and .06 mf. bypass condensers, mentioned above, must be installed to complete the repair, as well as a wire-wound resistor to replace the 5700 ohm carbon resistor.

### Majestic 71, 72, 181

The most frequent cause for complaint on these models is a broken condenser drive cable. The quickest and easiest method for replacing these cables is that of removing the gang assembly.

Remove the condenser gang shield and unsolder the four leads from the condenser stators and the bare wire soldered to the end of the condenser frame. The leads to the pilot light lugs are then unsoldered and the three

bolts holding the tuning gang to the chassis are removed. The condenser gang assembly may then be lifted out from the chassis. After the cable is re-strung, the gang is assembled in reverse order, as outlined.

Fading or intermittent reception of these models is often due to loose terminal nuts on the power pack terminal strip. They should be tightened with strong automobile pliers.

### Majestic 90, 91, 92, 93, 101, 102, 103

Noisy tuning on these models is usually caused by either one of two failures. In the first instance, the plating will be found to have peeled from the plates of the condenser gang. The secondary coil leads to each stator of the gang should be disconnected, and high voltage applied across each condenser while the rotor plates are turned. Arcing at the shorted points will burn away the plating. The other cause for the same condition lies with the equalizer, a small variable carbon resistor which is in series with the volume control and mounted on the rotor shaft of the tuning condensers. These two units vary the cathode voltage of the 1st, 2nd and 3rd R.F. tubes. The carbon element of the equalizer becomes worn and produces a noisy condition while tuning. It is very important that the connection between the equalizer shaft and the gang condenser shaft be a perfect one, electrically.

A frequent cause for an inoperative receiver or for intermittent reception, lies with a shorted or shorting audio or phono input transformer. The terminal lugs to which the transformer leads are connected, have been found to bite into the core of the transformer. This defect may be remedied by disconnecting the transformer lead from the faulty lug and connecting it directly, or, by straightening the end flanges of the shield so that the terminal board may be lifted and the bottoms of the lugs cut or insulated from the core. On the phono combination models, a cause for inoperation is due to a shorted lug on

the phono input transformer and is remedied as described above.

Intermittent reception has often been traced to loose power pack terminal strip nuts.

Weak reception, if any at all, with the attendant circumstance of low plate voltages on all tubes, is often due to a leaky or short-circuited detector plate voltage supply filter condenser in the condenser block. Although a new condenser or block may be installed, a repair may be easily accomplished without any disturbance in voltage distribution or increase in hum level by disconnecting and taping the lead to the top terminal lug of the condenser block and connecting this lug to the second lug, after removing the jumper between the second and third terminal lugs. If no detector plate voltage is obtained and the detector plate voltage supply filter condenser checks satisfactorily, look for an open-circuited 2000 ohm choke in the condenser block, connected between the second and fifth lugs. The later production power units employed a

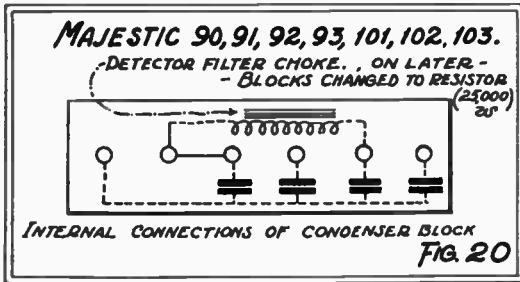

condenser block with a resistor of approximately 25,000 ohms, in place of the choke, connected between the same lugs. The internal connections of this block is shown in Figure 20.

— NOTES —

## Majestic 130, 131, 132, 233

Noisy tuning on this model is caused by a corroded condenser gang copper friction contact, located at the front end of the condenser gang behind the dial. This condition is corrected by removing the dial assembly and loosening the collar on the gang shaft, so that the copper contact may be cleaned and bent to increase its tension. When the contact is replaced, the friction collar should be forced back against the contact and its set screw tightened.

An inoperative receiver, or one that operates intermittently, is frequently caused by the terminal lugs of the push-pull input transformer shorting to the core of the transformer, beneath the terminal strip. The remedy is the same as that described for the Majestic 90, where the same condition was first encountered.

A high cathode voltage of over 300 volts, obtained on the first and second R.F. tubes, will be found due to the tearing away of the blue wire connecting to one of the end terminals of the volume control. Loosening of the volume control mounting nut will cause the volume control to shift and snap this blue lead, because of little or no slack in the lead.

The symptoms of fading and weak reception are commonly caused by open-circuiting or leaky .04 mf. 1st R.F., 2nd R.F. and detector secondary return bypass condensers. Replace these units with moisture-proof impregnated condensers, possessing good internal contact.

## Majestic 307, 344

When the complaint of low and distorted reproduction is received on these models, with the volume control only effective at the very beginning of its range, the .1 mf. condenser coupling the G-57 first audio tube to the output of the diode detector should be checked for a leaky or short-circuited condition. One terminal of this condenser is tied directly to one end of the volume control.

— NOTES —

A weak G-58 tube employed in the phase rotating stage, is often a cause for poor tone and low volume.

### Peerless 20 Series

This model is frequently serviced because of the complaint that the Amperite ballast tube lights up brightly and burns out, when the line switch is snapped on. Since the power transformers of these receivers have an 80 volt primary, the ballast tube cannot be shorted out of the circuit to enable further tests to be made. In most cases, the trouble has been found to lie with a defective 80 rectifier socket. Due to poor socket insulation and the proximity of the socket prongs, the high voltage arcs across the insulation between the plate prongs. The insulation burns and carbonizes, resulting in the short-circuiting of the high voltage winding. To check this condition, disconnect the high voltage leads and measure the insulation resistance between the plate prongs on the socket with a sensitive ohmmeter. The socket must be replaced.

### Peerless Courier 65

The cause for choppy and weak reception, if any at all, frequently lies with an open-circuited .01 mf. condenser, coupling the detector stage to the first audio.

The symptoms of distortion and weak reception are often caused by carbonization of the 5,000 ohm carbon resistors in the voltage divider circuit. These resistors connect respectively from the high voltage to screen of the R.F. tubes, and from the screen to cathode of these tubes. Usually, the screen resistor is the first to lower in value. The further symptom of poor control of volume will also be noted when this failure is encountered.

The Kylectron electrostatic speaker employed in many of these receivers is a source of much annoyance, and often the cause of noise, fading, and an inoperative receiver.

— NOTES —



This condenser type speaker is made up of six paralleled sections, each identical to the other. Connection to the tinfoil plates is made to terminals which are insulated from the perforated metal plate by means of insulated washers. Due to vibration, these terminals loosen and shift, and the unit becomes shorted. A single shorted unit will short the entire speaker. Shifting of the terminal connections, or temporary breakdown of the insulation because of the high polarizing voltage, will result in an arcing which will be picked up by the R.F. circuits. This shorted condition is often intermittent and will result in intermittent reception or fading. Although the speaker will operate satisfactorily with one section cut out of the circuit, it is advisable to remove the Kyletron speaker and install a dynamic type.

The 199 tube which is used to supply voltage and current to polarize the electrostatic speaker frequently burns out. Replacing the tube with a 201A type, will remove this difficulty.

The condition of noisy and weak reception has often been traced to open-circuited or leaky .00035 mf. bypass condensers, connected across one section of the split primary of the R.F. coils. A leaky condenser shorts out part of the primary coil, decreasing its impedance, and consequently, the amplification of the tube. An analyzer will not disclose this condition.

### Peerless 70, 71, 72

A frequent cause for an inoperative receiver lies with the shorting of the lug which is mounted upon the detector tuning condenser, and which connects to the control grid of the detector tube. Vibration causes the lug to shift and short to the detector shield can. The lug may be bent out of the way and covered with tape to prevent a recurrence.

These receivers are frequently serviced because the 80 rectifier tubes constantly "blow." In almost every in

stance, this condition has been found to be caused by a temporary breakdown of the filter condenser, identified by the yellow lead emerging from the condenser block. This section will test satisfactorily, but will break down under load. A quick check for this condition is made by disconnecting all three filter condensers, and after the receiver has been switched on, each section should be re-connected in turn.

Where an open-circuited or shorted .06 mf. condenser, coupling the first audio stage to the output tubes, is found, the unused primary of the audio transformer whose secondary only is employed, may be utilized. The coupling condenser should be removed and the primary, not shown in the schematic of this receiver, connected in place of the 20,000 ohm carbon plate resistor as shown in Figure 21. This procedure will result in greater volume and slightly lower hum level.

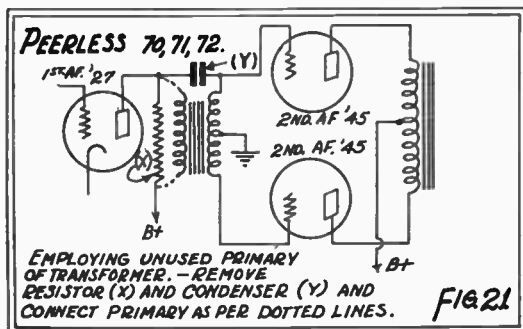

An electrostatic condenser type speaker is employed on some of these models, and subject to the same symptoms as described with the model 65.

Weak and noisy reception has frequently been traced to leaky .00035 bypass condensers connected across one section of the split primary of the R.F. transformers.

— NOTES —

These condensers should be disconnected and the full D.C. voltage output of the receiver placed across their terminals. If the unit withstands this test, connect it back into the circuit. Breaking down of the condenser is indicative of a leaky condition.

### Philco 14, 14X, 14LZX

The peculiar condition may be encountered on this model where reception may only be obtained at either the high or low frequencies, or reception may cut-off while dialing a station. These symptoms are caused by a poor 36 tube used as a 1st detector-oscillator, which goes "flat." Where the same condition persists after the tube has been exchanged, check the value of the detector-oscillator cathode bias resistor. This resistor, if found to have a value of 15,000 ohms, should immediately be changed to a 10,000 ohm unit. Many of the later production receivers incorporate the lower value unit.

Should the complaint of "no control of tone" be received, check the 37 tube in the first audio stage, before removing or testing the tone control.

A frequent cause for an inoperative receiver lies with an open-circuited shadowgraph tuning meter. This condition is evident from the thin line or shadow on the shadowgraph with no signals. Before installing a new shadowgraph, check the .05 mf. condenser, bypassing the R.F. and I.F. plate circuits. The temporary breakdown of this bypass condenser will cause an excessive current to flow through the shadowgraph and burn it out.

The condition of a strong "motor-boating" hum on these receivers, with the volume control advanced, may be eliminated by connecting a 100,000 ohm resistor from the grid of the first audio tube to chassis.

Insufficient or no action of the shadowgraph tuning meter may be due, in some cases, to an insufficient or defective antenna system, and in others, to weak 44 tubes in the R.F. and I.F. stages. If the shadow does not

widen, when the station dial is turned several degrees from resonance, it is probable that the compensating condensers will be found out of adjustment, resulting in broad tuning.

Where an oscillating condition, that is not caused by open-circuited bypass condensers or bad tubes, is encountered upon tuning in any station in the broadcast range, it may be eliminated by moving all leads adjacent to the oscillator coil as far away as possible. This is extremely important as regards the leads connecting to the I.F. trimmer condensers.

### Philco 16, 17

In these models the symptoms of choked, distorted reception are frequently encountered. This complaint may also be of an intermittent nature. The normal action of the shadowgraph correctly determines that the *audio* portion of the receiver is at fault. Locating the trouble, however, is usually difficult because of the fact that the application of meter testing equipment or a condenser to be used in shunting the various capacities, will often clear up the difficulty. The trouble has been traced in all instances to an open-circuited 2 mf. section of the filter condenser block bypassing the large 7,500 ohm wire-wound bleeder resistor and an open-circuiting .5 mf. condenser bypassing the 70,000 ohm resistor in the plate circuit of the first audio 77 stage. These condensers are designated on the filter condenser block as "B" and "C", respectively.

### Philco 18

The same condition of choked, distorted reception described under the Philco 16, 17, has been encountered on this model on several occasions. In this case, however, the filter condenser "B" is a 1 mf. unit and bypasses a 6,500 ohm wire-wound bleeder resistor.

Where no short-wave reception can be obtained with

the range switch in the "short-wave" position, check the contact blades of the switch. These have been found several times to have lost tension and of not making proper contact. The blades may be easily bent to increase their tension.

A number of these receivers were serviced for the complaint of a strong mechanical hum or vibration that was heard above the broadcast level. This condition was traced to loose or vibrating laminations of the power transformer core. Where tightening the transformer frame bolts and nuts does not alleviate matters, the sides or the corners of the laminations should be struck lightly with a small hammer. This procedure will reallocate any portion of the core which may be at the seat of the trouble, thus eliminating any air spaces. The transformer frame screws should be tightened carefully as the threads are easily stripped.

## Philco 19

As described with the Model 14, the cause for inoperation at either the high or low frequencies, or the sudden cutting off of reception, is due to a "flat" 36 first detector-oscillator tube. When replacement of this tube does not remedy the condition, it will be necessary to remove the 15,000 ohm cathode resistor in this circuit and substitute a 10,000 ohm unit.

The 75 tube, used in this receiver as 2nd detector and A.V.C. is frequently the cause for weak and distorted reception, although it may test satisfactorily on a tube checker. If a faint purplish glow is seen within the tube elements, discard the tube.

The shadowgraph tuning meter in this receiver often open-circuits. This condition will be made apparent by a narrow shadow line on the shadowgraph, with no change when the receiver is tuned from station to station. Due to the fact that the shadowgraph is shunted with a resistor in the plate circuit of the R.F. and I.F. tubes, its

### RIDER'S MANUALS!

To have Rider's Manuals in your possession would be of immense value to you. Volume I, II, III and IV now are available. These four volumes total 4000 pages. See them at your dealer or write to us for descriptive literature.

**JOHN F. RIDER**

1440 Broadway

New York City

failure will not make the receiver inoperative, as in the case with the model 14 and 91.

Where the complaint of intermittent reception is received, with the attendant symptom of a widening shadow on the shadowgraph, indicating that the trouble lies with the R.F. portion of the receiver, check the oscillator coil connections. Vibration causes the tightly wound coils to snap directly at the lug, and make contact intermittently. To ascertain this fact, the lug connections on the coil may be lightly prodded with some blunt insulated object, while the set is operating.

The shadow on the tuning meter is seldom narrow in these receivers, even upon strong signals. This condition may be remedied, to some extent, by increasing the length of the antenna, or shunting a 2000 ohm resistor across the shadowgraph. In some cases, removing the shadowgraph from the I.F. plate circuit so that it is in series with only the plate of the R.F. tube, has accomplished the same result, although the shadow will not widen as much as before the change.

### Philco 20, 20A

Common complaints with these receivers are those of oscillation and fading. In most instances, the trouble is due to open-circuited bypass units in the R.F. circuits and an open-circuited first audio coupling condenser. These condensers are enclosed within bakelite housings, connection being made to lugs on the case by stiff leads emerging from the eyelet of the lug. Vibration causes the leads to snap, either internally or at the connecting lug. If the break is found at the lug, it may be re-soldered, but it is advisable to replace the unit as the lead may snap internally at some future time, necessitating another call.

When the condition is encountered, where the receiver oscillates with the volume control turned up high, or where tuning is noisy, it will be necessary to pig-tail the

condenser gang rotor shaft to the chassis to effectuate a repair. At the same time, the condenser gang bath-tub should be bonded to the chassis.

### Philco 60

This model is frequently serviced because of a slipping dial, which is caused by insufficient tension upon the bearings in the ball-race reduction gear. The tension may be increased by removing the two screws holding the cover of the reduction gear to the chassis, and bending the ends of the cover forward, so that when it is re-installed, the screws will force the cover further back in the reduction gear.

### Philco 65

The symptoms of fading, intermittent and weak reception, with the attendant circumstance of low plate voltages on all tubes, are caused by a leaky or short-circuiting .001 mf. detector plate bypass condenser. Where these symptoms are found, and the trouble cannot be localized, the sides of the condenser will often disclose the defect.

Hum on these models is often caused by corroded speaker plug and socket contacts. A scrubbing with steel wool will soon eliminate this condition. A loud hum and distorted reproduction is frequently due to the pilot light socket, whose lugs shift upon vibration, and short to the mounting bracket. A strong resonance hum may be rectified, in most cases, by connecting a .1 mf. or a .5 mf. bypass condenser to one side of the power transformer primary to chassis.

Weak reception of the high frequencies or of distant signals may be caused by misalignment of the condenser gang. Three compensating condensers are employed in this model, whose adjusting screws are located on the back of the bath-tub, on either side of the supporting bracket, and one accessible through a hole at the top of

the bracket. The square lock-nuts should be loosened before making any adjustments.

### Philco 70, 70A, 270, 370, 470, 570

Fading or intermittent reception on these models is caused by open-circuiting audio coupling condensers. This open-circuit usually consists of a snapped pig-tail connection to the condenser, either within the bakelite housing or at the lug. In receivers bearing serial numbers below 22,000, only one such coupling condenser is employed, while two units will be found in chasses with serial numbers above 22,000. Where this complaint is encountered, because of the fact that the actual trouble may not occur for several hours, it is best to replace these condensers without losing any time.

On receivers bearing a serial number below 22,000, a loud howl may be experienced, which is due to an open-circuited detector plate bypass condenser. This condenser is connected after the R.F. choke to chassis.

Generally weak reception over the entire broadcast band, on the models with serial numbers below 22,000, is caused by open-circuited auxiliary condensers connected across the intermediate frequency trimmers. This condition may be determined by the fact that the intermediate frequency transformers will not peak when an alignment is made. Where weak reception is found on the low frequencies and the low frequency padding condenser cannot be peaked, check the small capacity connected in parallel with this trimer for an open-circuit.

Upon the complaint of weak reception at the high frequencies with little or no response above 800 or 700 K.C., on receivers with serial numbers above 22,000, look for a high resistance connection to the pig-tails of the R.F. plate choke. Coupling between this choke and the secondary of the R.F. transformer is obtained by the use of a single turn winding on the secondary coil, connecting to the plate of the R.F. tube. A hot soldering iron



applied to the joints will sweat out the rosin in the connections and clear up the defect.

In receivers where a 27 tube is used as a diode detector, the condition may be encountered where no plate voltages are obtained upon any of the tubes and the diode tube lights up brightly, a continuity check will disclose the high voltage short-circuited to chassis. By a process of elimination, this short will be found within the second intermediate transformer, the secondary winding being shorted to the primary winding. If the transformer is removed from the shield, the leads of the primary winding will be observed shorting to the secondary bobbin. All that must be done to clear the short, is to insulate the secondary winding with a layer of tape so that the primary leads cannot make contact with it.

### Philco 71

As in the case with the Models 14 and 19, no reception at either the high or low frequency ends of the tuning scale, or intermittent reception, is caused by a "flat" 1st detector-oscillator tube. If changing this tube does not remedy the condition, the oscillator cathode bias resistor should be replaced by a unit with the lower value of 10,000 ohms. When the high frequencies are received weakly and very little response is obtained on the low frequencies, check the pig-tail connections of the choke in the R.F. plate circuit. A high resistance connection to these pig-tails, will result in the above complaint and is remedied by the application of a hot soldering iron.

### Philco 76, 76A, 77, 77A

Low and mushy reception has often been traced to an open-circuited .1 mf. condenser coupling the detector tube to the first audio stage.

Where the complaint of distortion at low volume levels

— NOTES —

is received, the most probable cause lies with an improperly centered dynamic speaker voice-coil. Because of the construction of this speaker, it is impossible to adjust the voice-coil by the usual means of inserting feeler gauges or cardboard tabs. If the control grid cap of the 3rd R.F. tube is removed and the aerial wire is connected to the control grid, a loud, low frequency hum will be heard in the reproducer. By loosening the centering screw and using the steady note provided by the hum, the voice-coil may be moved from one side to another, until the best response is obtained and the coil is moving freely, without rubbing against either the inner or outer pole-pieces.

### Philco 87

When the condition of hum is noted on this receiver, which can be cleared up by turning the range control counter-clockwise to the local position, check the friction contact of the range control. This failure will be made evident by the lack of grid bias on the 1st R.F. tube. The range control is a small compensating condenser which is used for fine tuning to resonate the antenna circuit upon weak signals. When the control is turned counter-clockwise, the grid of the 1st R.F. tube is grounded and disconnected from the circuit, impressing the signal input of the antenna upon the grid of the 2nd R.F., resulting in greater selectivity.

Lack of plate voltage on any of the R.F. tubes may be due to an open resistor in the plate circuit of that stage. These resistors are enclosed within the plate bypass cartridges, which are located near the base of each R.F. coil. To check these condensers for short-circuits, the mounting screw which fastens the bracket of the condenser cartridge, to which one terminal of the condenser is connected, may be removed. This will "float" the condenser.

Where the complaint of weak reception is encountered on these receivers, and a socket analysis does not disclose the defect, check for a short-circuited neutralizing conden-

ser, a common condition. The quickest method for localizing the trouble is of employing a low-range ohmmeter.

### Philco 89

Except for the shadowgraph, with which this receiver is not equipped, service data described under the Philco 19 will also apply to this model.

### Philco 90, 90A

Fading and intermittent reception on this model is almost invariably caused by the open-circuiting of any one of the three audio coupling condensers, the open-circuit taking the form of a snapped connecting lead, either within the condenser housing or at the external lug. The surest and most sensible procedure to follow toward eliminating this condition, is replacement of all three condensers at the same time. Should a slight motor-boating exist after these condensers have been changed, the first audio grid resistor should be replaced with a 100,000 ohm unit.

Oscillation and fading is caused by an open-circuiting of the different bypass units in the R.F. circuits. As these bypass condensers are of the same construction as the audio coupling condensers, a similar open-circuited condition results from the snapped, stiff connecting leads. This fact may be determined by employing a pointed insulated prod, which may be used to pry at the leads, where they emerge from the lug eyelet. Bridging each condenser with a good unit will soon disclose the offending member.

If an oscillating condition is encountered, especially upon the high frequencies, check for an open-circuited condenser bypassing the cathode-bias resistor for the 1st detector and oscillator tubes. In some cases, where this unit is found intact, the difficulty may be overcome by shunting another condenser of the same capacity across the original bypass unit.

### — NOTES —

*Also if set motor-boats especially when warming up check for an open cathode or bias section of voltage divider.*

## Philco 91, 91X

See data on model 14.

## Philco 95, 96, 96A, and 296

The symptoms of intermittent, fading, or weak reception have often been traced to open-circuiting or open-circuited .05 mf. condensers bypassing the R.F. secondary returns. These units are subject to the same failure due to the snapping of the connecting leads. By bridging each unit, in turn, with a .05 mf. condenser, it is possible to locate the open-circuited component, which should be replaced with a similar capacity to maintain proper operating conditions.

## Philco 111, 111A, 211, 211A, 112, 112A

The most frequent cause for inoperation on these receivers has been found to be caused by the open-circuiting of the 70 ohm center-tapped resistor in the high voltage secondary winding return circuit. This resistor is located near the 80 rectifier socket. The second section, or the one which is connected to chassis, is the one usually to "go" first. This failure will be made evident by the fact that no D.C. voltage readings can be obtained at the tube sockets.

The symptoms of intermittent fading, and weak reception is caused by open-circuiting or open-circuited .05 mf. condensers bypassing the R.F. and I.F. secondary return circuits.

## Philco 12X

Service data mentioned with the 111, 111A etc., receivers applies equally to the Philco 112X, since the chassis is essentially the same. Where the complaint of distorted reproduction is encountered on this model, in the nature

— NOTES —

of a high pitched whistle, it is necessary that the twisted leads from the speaker plug socket to the plates of the pentode tube be removed and made as short as possible. This will mean connecting the leads in as direct a line as possible, and not in the circuitous path employed. The leads should be kept free from the 3rd R.F. primary compensating condenser or a slight whistle will be heard.

### Radiola 17, 50

The symptoms of hum and weak reception, with lack of grid bias obtainable on the 1st R.F. tube, is frequently caused by poor contact of the volume control arm. As this arm is connected to the grid of the 1st R.F. tube, poor contact at this point will open the grid circuit and disconnect the aerial from the receiver.

The selectivity and the sensitivity of these receivers may be increased by reducing the value of the grid suppressors connected in 2nd and 3rd R.F. stages, so as to bring the circuits closer to the point of oscillation.

Oscillation is often caused by the open-circuiting of either or both of the bypass condensers connected across the  $1\frac{1}{2}$  volt filament supply, with their junction point grounded. This bypass block is located in the tuning chassis.

### Radiola 18, 33, 51

Where the condition of oscillation over the entire dial is encountered, check for an open-circuited bypass condenser connected across one section of the split primary winding of the 2nd and 3rd R.F. stages. Poor contact of these condensers is often the cause of noisy or intermittent reception.

Oscillation at either the high or low frequencies may be corrected by re-adjustment of the R.F. compensating condenser whose adjusting screw is accessible through the hole in the tuning condenser bath-tub, between the first

— NOTES —

and second tuning condensers. This condenser may be adjusted by using the following procedure. Tighten the adjusting screw clockwise and tune in some station between 1400 and 1500 K.C. As the receiver will oscillate strongly, turn the screw slightly counter-clockwise until the oscillation ceases. Poor selectivity on these models may be corrected to some extent by adjusting the R.F. compensating condenser screw slightly clockwise to bring the circuit closer to the oscillating point.

Where the complaint of distorted reproduction is received and a slightly higher detector plate voltage is noted, check the voltage limiting resistor connected from the B+ side of the first audio transformer primary to chassis, for an open-circuited condition.

Connecting a phono pickup to these receivers often presents a number of difficulties. If a high impedance pickup is connected from the grid to cathode of the detector tube, the long leads will cause unstable operation and an audio howl. In order to obtain the added ampli-

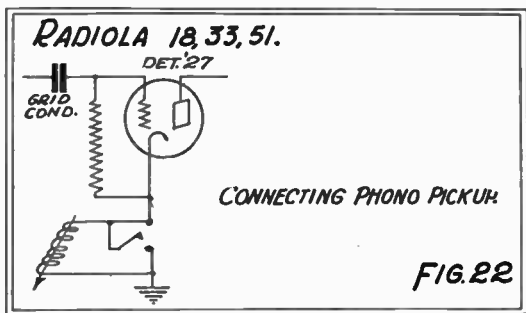

fication of the detector tube and resulting greater volume, the pickup should be inserted in the cathode circuit of the detector tube as shown in Figure 22.

## Radiola 30A

Where an extremely noisy condition is encountered, especially upon the slightest vibration, the trouble has been found to lie with the rheostats. The chassis should be removed from the cabinet so that these components are accessible. The resistance strips should be cleaned with a small wad of steel wool, as well as the sliding contact arms, which should be bent slightly to secure greater tension.

Fading and intermittent reception has almost always been traced to poorly soldered connections to the voltage dividers in the power pack. An indication of this trouble will be made evident by fluctuating voltages readily disclosed by a set analyzer.

Where the receiver is found to be insensitive, and tuning is off scale, check the antenna coupler connections. The black lead of the coupler should be connected to terminal No. 9 (reading from right to left, facing the back of the set) of the catacomb terminal strip. The two black and green tracer leads connect to No. 6 and No. 8 terminals. These latter leads may be interchanged.

Oscillation over the entire scale, which cannot be controlled by either one of the rheostats, may be corrected by re-adjusting the R.F. neutralizing condenser. This condenser is adjusted in the usual manner by removing the R.F. tube and inserting a dummy tube. Provision must be made however, for inserting a suitable resistance of approximately 55 ohms across the filament terminals of this stage to compensate for the removal of the R.F. tube, as the filaments of all the 99 tubes are wired in a series shunt circuit.

## Radiola 41

One of the most common complaints on this receiver is distorted and choked reproduction, which, in almost every instance, is due to a short-circuited .1 mf. conden-

ser bypassing the bias resistor of the output tube.

When the condition is found where the house line fuse "blows", every time the receiver switch is snapped on, check for short-circuited rectifier "stacks" of the dynamic speaker.

A loud hum is often due to a partially shorted section or sections of the rectifier "stacks", which are connected in a bridge circuit, to secure the operating potential for the D.C. field of the dynamic speaker. Loose contact of the volume control arm will also cause the same complaint, as this arm is connected to the grid of the first R.F. tube. Lack of grid voltage in this stage will point to this defect.

The selectivity of the receiver may be greatly improved by reducing the value of the grid suppressors in the 2nd and 3rd R.F. circuits. Should oscillation exist when the smaller suppressors are used, connecting a 1000 ohm resistor across the primary of the 3rd R.F. coil will remedy the condition.

### Radiola 44, 46

Oscillation and noisy tuning on these models is invariably caused by corroded seats of the three shield cans. The bottom edges should be thoroughly cleaned and polished with fine sandpaper or a wad of steel wool, as well as the small contact clips that fit over the rotor shaft. These latter clips should be bent and shaped so that they make better contact to the rotor shaft.

Where an insensitive receiver, or oscillation at the low frequencies, is encountered, check the adjustment of the compensating condensers, whose adjusting screws are located in front of the chassis. They are flat-head screws, flush with the chassis.

The symptoms of low or no detector plate voltage, as well as lowered voltages on all other tubes, are caused by a grounded audio choke in the detector plate circuit. This choke is mounted below the tuning chassis in a brown metal housing. Vibration causes the coil to work through



the thin pitch coating and short to the chassis. A repair may be effected by placing some insulated material between the choke and the chassis.

The cause of intermittent reception has often been traced to an open-circuiting .01 mf. audio coupling condenser. This condenser is located upon the center-tapped resistor terminal strip under the power unit. It is part of the double-unit block which also contains the .006 mf. condenser.

Where no screen voltage is obtained on either of the R.F. tubes, check for a shorted volume control shaft. In some instances, the fibre washers insulating this shaft from the chassis have been found to have shifted.

### Radiola 47

This receiver employs a model 46 chassis and all data pertaining to the latter chassis will apply equally to the

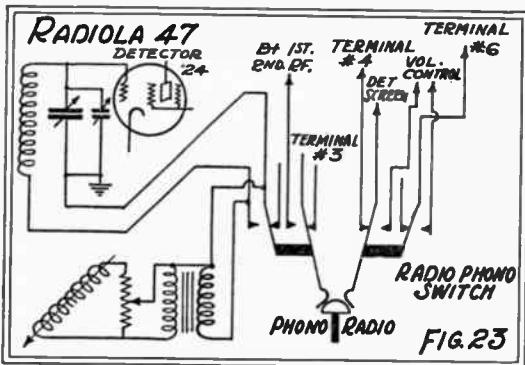

model 47. The condition of intermittent reception on this model, however, with the symptoms of no screen or plate voltages obtained on the R.F. tubes has been traced

to badly corroded contacts of the radio-phonograph transfer switch. These contacts may be easily cleaned by the insertion of a small strip of fine sandpaper or a small magnetite file, after the switch has been removed. The connections to the switch are shown in Figure 23.

## Radiola 48

The symptoms of muffled, distorted reproduction, and hum which will clear up when one of the 45 tubes is removed, has invariably been traced to a shorted .025 mf. condenser coupling the detector tube to the power amplifiers. This condition will be made evident by the high plate current and positive grid bias reading obtained on the 45 in whose grid circuit the shorted condenser is connected. Although these condensers are located in the capacitor and coupling reactor block, it is not necessary to replace the entire unit when one of these condensers short-circuits. A new condenser may be installed in series with

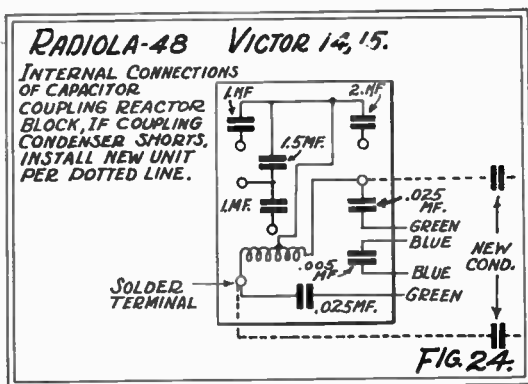

the green lead connecting to the grid of the 45, or the green lead may be disconnected and the new unit installed

— NOTES —

as shown in Figure 24, which also shows the internal connections of the capacitor-reactor block.

Noisy tuning and intermittent reception is often caused by the plating, peeling from the variable condenser plates. This condition may be eliminated by disconnecting the leads to the tuning condensers, and applying high voltage across their terminals while the rotor plates are rotated. Arcing at the shorted points will burn away the plating. Oscillation is frequently caused by corroded tuning condenser rotor shaft clips. They may be cleaned and re-shaped to increase their tension.

Fading, intermittent, and noisy reception has frequently been traced to the dual carbon volume control. This unit is subject to the usual defects associated with carbon controls, but cannot be easily repaired because the two sections are riveted together. The simplest and best procedure is replacement.

Where it is found that no screen voltage is obtained on any of the R.F. tubes, check for an open-circuited R.F. choke in the screen circuit.

Hum in this receiver is often due to the 24 tube in the detector stage. Try interchanging all of the 24 tubes until one is secured that will operate satisfactorily in the detector stage, without hum.

### Radiola 60, 62

The symptoms of distorted tone and low volume, which often may be of an intermittent nature, have frequently been traced to an open-circuited audio transformer primary. This condition will not readily be disclosed by a set analyzer, except for a slightly lower plate voltage reading which is usually disregarded, because of the 40,000 ohm carbon resistor connected across the audio transformer primary. Although the transformer may be replaced, which is advisable, a satisfactory repair may be made by coupling the plate of the second detector tube to the grid of the output tube with a .01 mf. condenser.

— NOTES —

Although these receivers, when operating properly, are extremely sensitive, the sensitivity may be improved to a great extent by shunting the 400 ohm section of the flat wire-wound voltage divider located near the volume control, with a 500 ohm resistor. This reduces the grid bias impressed upon the 1st detector tube, thus increasing its amplification. With strong signals however, the volume control will be found to be ineffective. To avoid this difficulty, a switch should be installed in series with the shunt resistor so that the resistor may be cut in and out, at will.

Weak reception, although all tubes have checked satisfactorily, has almost invariably been traced to the 20,000 ohm carbon bleeder resistor in the power pack which carbonizes to a lower value. The only discrepancy resulting from this defect, is a lower plate voltage reading obtained on the R.F., 1st detector and I.F. tubes. This bleeder resistor is connected across the supply circuit at the 135 volt tap, and is employed to prevent any excessive rise in voltage, that would otherwise occur upon removal of the tubes, or until the tubes have fully heated. Even the loss or decrease of a few thousand ohms in this resistor will cause the trouble.

Poor sensitivity at either the high or low frequencies may be due to the oscillator trimmers being out of adjustment. These trimmers are located to the right of the chassis (facing the rear) as shown in Figure 25. The trimmer on the right should be adjusted for maximum response with the receiver tuned to a 1400 K.C. signal generated by an oscillator. The left trimmer is properly adjusted for maximum response with the receiver tuned to a 600 K.C. signal. An insensitive condition may also be caused by the poor adjustment of the R.F. compensator condenser, located at the extreme left as shown in Figure 25, which should be adjusted in the following manner. Tighten the adjusting screw clockwise until the tuning of any station will produce a whistle or oscillation. With the receiver tuned to some station at approximately 1000

K.C. turn the adjusting screw back beyond the point of oscillation. Now tune the set at different points on the dial to observe the presence of oscillation. If this is found, turn the compensating condenser screw back slightly.

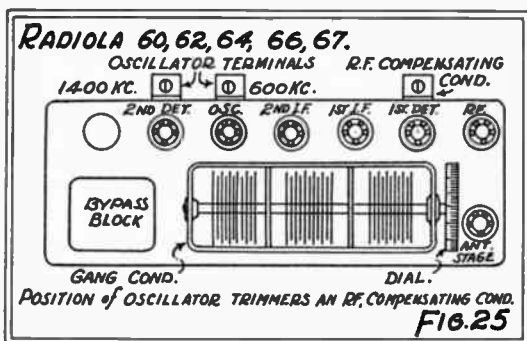

Where stations are received 40 to 50 K.C. from the original dial settings, and stations below 600 K.C. cannot be tuned in, check the oscillator series condenser which is connected across the two oscillator trimmers. This condition is caused by the snapping of one or more of the copper tabs emerging from the condenser, thus lowering its effective capacity. In some instances, repair is possible if the break in the copper tab is not too close to the condenser and may be soldered. Usually, it will be necessary to replace the unit.

Unstable operation and oscillation, in some cases, have been traced to an open oscillator grid leak. The value of this unit is 40,000 ohms, but a 50,000 ohm unit may be substituted as the value is not critical.

Distorted reproduction at low volume and a distinct rattle when the volume control is turned up, on the Model 62, is caused by a broken cone spider of the dynamic speaker. The only remedy, here, is replacement of the cone and the voice coil.

— NOTES —

The complaint of hum on the Model 62 is almost always caused by partially shorted rectifier "stacks" supplying D.C. voltage for the field coil of the dynamic speaker. This condition may be checked by removing the output tube with the set in operating order, and noting the amount of hum. If the hum does not decrease to any marked extent, the rectifier "stacks" are at fault, or else due to high resistance soldered connections to the rectifiers. The rectifiers may be checked by measuring the output voltage delivered to the dynamic speaker field coil. With the field coil disconnected, a reading of approximately 140 volts should be obtained, which should not drop under 100 volts when the field is connected. If the house line fuse should "blow" when the receiver is switched on, check for shorted rectifier "stacks."

### Radiola 64

In a few cases, where fluctuation of the tuning meter needle was encountered, the condition was corrected by shunting a .0001 mf. condenser across the terminals of the meter.

Distorted and weak reception is frequently caused by an open-circuited audio transformer primary. Because of the fact that a 40,000 ohm resistor is connected across this primary, the set analyzer will not disclose the condition. As in the case with the Radiola 60, 62 a repair may be accomplished by coupling the plate terminal of the audio transformer primary to the grid of the 50 tube, with a .01 mf. condenser.

Very weak reception, if any at all, without any control of volume, is caused by an open-circuited 1 megohm carbon resistor in the grid circuit of the A.V.C. tube. This resistor is located on the terminal strip fastened to the right wall of the chassis. The defective resistor removes the negative grid bias from the A.V.C. tube and increases the negative grid bias impressed upon the R.F. and I.F. tubes, thus lowering their amplification. This condition is

made evident by greater or full volume, when the A.V.C. tube is withdrawn from its socket.

Fading and intermittent reception, and the condition where stations are received below their original dial setting, is caused by the snapping of the connecting tabs of the oscillator series condenser, which is connected across the two oscillator trimmers. In some cases, the change in capacity is so great that stations below 600 K.C. cannot be tuned in. If the break can be seen and is not too close to the condenser jacket, it may be soldered, or a new unit should be installed.

If the receiver is insensitive at either the high or low frequencies, the most probable cause lies with the oscillator trimmer condensers. These, as well as the R.F. compensator should be adjusted as described with the Radiola 60, 62.

### Radiola 66

Where the condition of distorted reproduction is encountered, look for an open 250,000 ohm carbon resistor connected in the secondary return circuit of the audio transformer. This condition will be evidenced by the lack of grid voltage and a high plate current reading obtained with a set analyzer.

The symptoms of fading, intermittent reception, shifting of station dial settings, and insensitivity, on this model, are caused by the same defects and failures as described with the Radiola 60, 62 and should be corrected by following the same procedure outlined under these models.

### Radiola 67

The complaint of no control of volume on this model has always been traced to an open 310 ohm end section of the voltage divider located in the tuning chassis. This open-circuit is difficult to check because of the fact that

#### RIDER'S MANUALS!

To have Rider's Manuals in your possession would be of immense value to you. Volumes I, II, III and IV now are available. These four volumes total 4000 pages. See them at your dealer or write to us for descriptive literature.



**JOHN F. RIDER**

1440 Broadway

New York City

when an ohmmeter is placed across the section, a reading will be obtained, as one side of this section is grounded and the other side is only about 4,000 ohms above ground. A 25 watt resistor should be used to replace the open-circuited section.

The most frequent cause for an inoperative receiver is an open-circuited 115 ohm section of the voltage divider located in the power pack.

If it is found that the receiver is inoperative and the tuning meter needle swings off scale, check for an open-circuited 100 ohm section of the voltage divider in the power unit, across which the meter is shunted.

Where fading, or an inoperative condition is encountered, which can be cleared by removing the A.V.C. tube, and the symptom of a high negative grid bias of 90 volts on the R.F. and I.F. tubes instead of the normal 9 volts is observed, check the contacts of the phono-radio transfer switch. The grid return of the A.V.C. tube is connected to one of the terminals of this switch and if positive contact is not maintained the A.V.C. grid circuit will be opened. This removes the bias upon the A.V.C. tube, causing it to pass more current and impress an abnormally high bias upon the grids of the R.F. and I.F. tubes. A similar condition may be due to the open-circuiting of the 1 megohm resistor in the grid circuit of the A.V.C. tube. This resistor is located on the terminal strip mounted upon the wall of the chassis near the A.V.C. tube socket.

### Radiola 80, 82, 86

The complaint of distorted reproduction and hum, on these models, is often caused by an open circuited 60,000 ohm resistor in the push-pull input transformer secondary return. A set analyzer will readily disclose this fault by the high plate current reading and lack of grid bias obtained on the output tubes.

Fading, intermittent reception, and the shifting of sta-



tion dial settings is caused by the snapping of the oscillator series condenser tabs, as described with the Model 60, 62, 64. The value of this condenser is 745 mmf.

Where poor control of volume is found on powerful signals, even when the local-distance switch is in the local position, remove the 6,000 ohm carbon resistor shunted across the volume control. Replacement of the 24 tube in the R.F. stage with a type 35, will often eliminate the same condition.

Distortion and low volume has sometimes been traced to an open audio transformer primary. As described with the model 60, 62, 64, and 67 this open-circuit cannot be checked with a set analyzer because of a 40,000 ohm resistor connected across it.

Service data on the remote tuning employed with some 82 and 86 receivers will be found under RCA-Victor RAE-68.

### RCA-Victor R-4, R-6, R-7, R-7A, R-9

Distorted reproduction at any setting of the volume control is caused by voltage divider resistors which carbonize and reduce greatly in value. This condition will be made evident by the excessive screen voltage obtained on the R.F., 1st detector and I.F. tubes, and lower plate voltages on all other tubes. To more accurately determine this fact, a point-to-point resistance check may be made between plate and screen and from screen to cathode at the I.F. tube socket. Readings of approximately 16,000 ohms and 8,000 ohms respectively should be obtained. The 16,000 ohm unit connected between the high voltage and screen should be replaced, if found defective, with a wire wound resistor capable of dissipating at least 10 watts. The value of the resistor used in the Models R-7 and R-9 is 14,300 ohms. A 15,000 ohm unit may be used as a standard replacement for all models.

Noisy tuning and oscillation at the higher frequencies is caused by corroded and dirty tuning condenser rotor con-

tacts. Although these contacts may be cleaned and reshaped to increase their tension, it is advisable to pig-tail the rotor shaft to the chassis. This pig-tail should be well insulated so that it cannot short to any of the stator plates.

### **RCA-Victor R-8, R-12**

Should the condition be found where the receiver is insensitive and volume is low, and removing the A.V.C. tube brings the volume level up considerably, the two .1 mf. condensers bypassing the A.V.C. grid return to cathode and chassis, respectively, should be checked for high resistance leakage. An ordinary ohmmeter whose scale only reads to 100,000 ohms will not suffice here, as the leakage of these condensers is often over 2 megohms. This defect increases the negative control grid bias impressed upon the R.F. and I.F. tubes.

The complaint of distorted reproduction at any setting of the volume control, is caused by a carbonized voltage divider system as described with the models R-8, R-6, etc. The value of these two carbonized resistors is 16,000 and 8,000 ohms, respectively, and may be checked in the same manner discussed under the model R-4.

Noisy tuning and oscillation at the high frequencies, on these models, is also caused by corroded and dirty tuning condenser rotor contacts. The rotor shaft should be pig-tailed to the chassis for a perfect repair.

### **RCA-Victor R-11, RE-18, R-21, RAE 26**

These models are frequently serviced for the complaint of fading. When the receiver is switched on, reception will fall, gradually, to a whisper and the tone will become distorted. This condition is caused by the failure of the 5 megohm resistor in the A.V.C. grid circuit. In the model R-21, the value of this unit is 2 megohms. A certain indication of this defect is the return to normal

volume when the A.V.C. tube is withdrawn from its socket, although the tone may be slightly muffled. The open-circuiting of this resistor removes the negative bias from the A.V.C. tube which will pass more current and impress a greater control grid voltage upon the R.F. and I.F. tubes, thus reducing their amplification. This portion of the receiver circuit is shown in Figure 26.

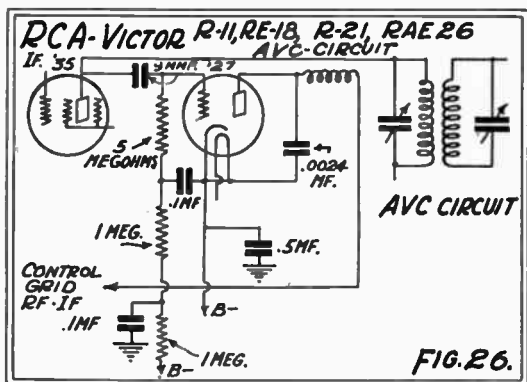

Where the symptoms of low volume and poor sensitivity are encountered, check the two .1 mf. condensers bypassing the grid return of the A.V.C. tube, as shown in Figure 26, for high resistance leakage. A high range ohmmeter will be necessary to test these condensers. If the volume increases when the A.V.C. tube is withdrawn, it is a fairly good sign of faulty condensers.

Very weak and distorted reception is frequently due to an open-circuited coupling winding in the second I.F. transformer. This winding is used to couple the primary and secondary of the I.F. transformer, which are shielded from one another. As an analyzer will not disclose this condition, it will be necessary to check the winding by means of a low range ohmmeter. In order

to obtain a correct indication, however, the volume control which is shunted across this coil, must be disconnected. Usually, the open-circuit will be found to consist of a break in the pig-tails of the coil.

Fading, noisy, and intermittent reception is often caused by a faulty volume control. Connection to the volume control arm is made by a copper contact spring attached to the arm, which rises upon the terminal lug in the center of the fibre cover. By bending back the three tabs, the cover may be removed and the contact spring cleaned of corrosion and grease. However, a better job may be made by pig-tailing the volume control arm to the terminal lug, care being taken that the pig-tail cannot short to the resistance element, by encasing the pig-tail within spaghetti tubing. Pushing in or pulling upon the shaft of the volume control will usually disclose this faulty condition. The trouble may also be due to a loose resistance winding. In this case, the unit should be replaced.

The symptoms of badly distorted reproduction and low volume, which can be cleared by removing one of the 47 tubes, can usually be traced to a short-circuit between the primary and secondary winding of the push-pull input transformer. The condition will be disclosed by the high positive grid bias reading obtained when analyzing this stage. Replacement of the transformer is the only remedy, as the short-circuit is internal.

The problem of insufficient volume may be encountered on one of these models, with stations being tuned in with a "plop", although the receiver and tubes check satisfactorily. This condition has been found due, in most cases, to excessive heater voltage on the A.V.C. tube, which should be reduced by the insertion of a  $\frac{1}{2}$  ohm resistor in the heater circuit. This should be done even though the heater voltage on the A.V.C. tube is found to be 2.5 volts.\*

Distorted reproduction, regardless of the volume control setting, in almost every instance, is caused by car-

— NOTES —

\* At RCA meeting the engineer we consulted advised a .2 ohm resistor in the AVC heater circuit to reduce the voltage from  $2\frac{1}{2}$  to 2 volts.

bonized resistors forming part of the voltage divider system. This situation is revealed by the abnormally high screen voltages obtained on the R.F. 1st detector and I.F. tubes, and lower plate voltages on all tubes. A check made with an ohmmeter from plate to screen, and screen to cathode at the I.F. tube socket should obtain readings of approximately 15,000 and 18,000 ohms, respectively. In the case of the model RE-19, this latter reading should be approximately 8,000 ohms. When these two resistors are found carbonized on the RE-19, the 8,000 ohm resistor connected from terminal No. 3 on the phono terminal strip to chassis should also be checked for a carbonized condition. The two watt carbon screen resistor should be replaced with a wire-wound unit of 10 watts capacity.

A slipping tuning dial on the Model 21 may be repaired by taking another turn or two around the tuning shaft with the drive cable as shown in Figure 27. To accomplish this, the tension spring must be released so that the turn may be made with the loose cable. When the dial is removed to gain access to the tension spring, its position should be carefully noted so that it may be re-installed without disturbing the dial settings.

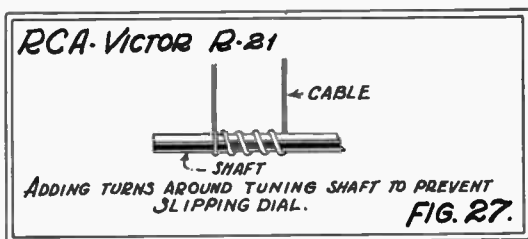

A low insistent hum, accompanied with the symptom of a strong motor-boating when the 47 tube behind the 80 rectifier is withdrawn from its socket, is caused in-

variably by the one megohm resistor connected from terminal No. 3 on the phono terminal strip, to chassis, shorting to terminal No. 4. This condition may be quickly checked by shorting terminals No. 3 and No. 4 with a screw driver. If the hum level does not increase, the shorting resistor is the trouble.

Noisy tuning, motor-boating between stations, and oscillation at the higher frequencies is caused by corroded and dirty tuning condenser rotor contacts. This condition should be corrected by pig-tailing the rotor shaft to the chassis.

Low volume on the phonograph in the RAE-26 model has frequently been traced as caused by the shielded cable connected to the phono input transformer shorting to terminal No. 3. This terminal, although connecting to an unused portion of the input winding of this transformer, if shorted to the grounded cable, will result in weak record reproduction. The trouble may be eliminated by either insulating the shielded cable or taping up the terminal.

Failures and adjustments of the automatic phono mechanism used in the RAE-26 receiver, which is the same as that used in models RAE-59 and RAE-79, will be found discussed under the latter model.

### RCA-Victor R-17-M

This model, a small, compact 4 tube midget, has been frequently serviced because of the complaint of weak and distorted reproduction. This condition has usually been found due to improper spacing of the armature of the magnetic type reproducer employed in this receiver, which is caused by warping or contraction of the paper cone. A simple remedy is that of unsoldering the drive pin from the apex of the cone, thus relieving the "pull" of the cone and readjusting the armature. The drive pin may then be resoldered to the apex of the cone.

A frequent cause for an inoperative receiver, or inter-

mittent reception, lies with the antenna lead short-circuiting to the eyelet of the lug through which it passes. If an outside antenna is employed and the aerial lead wire is rolled or coiled too near the receiver, or within the metal cabinet, excessive regeneration may result.

It may be good policy to replace the detector plate resistor which often open-circuits and results in inoperation of the receiver, with a  $\frac{1}{2}$  or one watt unit to avoid the possibility of recurrences.

### **RCA-Victor R-28, R-37, R-38, RE-40**

A common complaint on all these models, is that of reception suddenly cutting-off and the receiver operating noisily, as it would if it were tuned off resonance with the volume control turned full. This condition has always been traced to a defective 2A7 detector-oscillator tube, which will test perfectly on any tube checker. By snapping the line switch several times, operation can be made to resume.

An inoperative receiver is often caused by a short-circuited section of the double electrolytic condenser filter unit. Almost invariably the 4 mf. second section is at fault, because of its low working voltage. In order to prevent future trouble on this score, a higher rating unit should be installed.

### **RCA-Victor R-50, R-55, RAE-59, RE-20**

These models are serviced more frequently for fading than for any other complaint. Reception will be normal and then gradually decrease. By snapping the switch several times, the volume level can be made to return to the former setting. The trouble has always been found due to a leaky .1 mf. condenser bypassing the one megohm resistor in the A.V.C. grid circuit. This condenser is located in the power pack—a section of the condenser

block—and is identified by the blue lead which connects to the one megohm resistor, fourth on the resistor terminal strip. The condenser should be removed from the circuit by disconnecting the lead and an external bypass condenser installed.

Should the condition be encountered where the receiver is inoperative unless the A.V.C. tube is withdrawn from its socket, check for an open-circuited one megohm resistor in the A.V.C. grid return.\* There are two such resistors employed in this circuit, but the unit in question is located in the power unit, upon the resistor strip. This failure will be made evident by the high negative control grid bias of approximately 45 volts impressed upon the R.F. and I.F. tubes.

A sharp decrease in volume accompanied by oscillation and unstable operation has frequently been traced to an open-circuited  $\frac{1}{2}$  mf. screen bypass condenser. *1. mfd*

The tone quality of these models may be improved, to some extent, by operating the pentode output tubes as triodes. This is done by tying the screen grid to the plate of each tube. The 18,000 ohm carbon resistor and the .005 mf. condenser connected in series across the plates of the tubes should be removed.

The automatic phonograph mechanism employed in the model RAE-59 has necessitated numerous service calls because of numerous failures. It is treated under the RCA-Victor RAE-79, which employs a similar mechanism.

Intermittent operation on either the radio or phonograph, and low record volume, has often been traced to corroded contact segments of the master switch on the models RAE-59 and RE-20. By straightening the two tabs on the frame, the cover of this switch may be removed. A strip of 00 sandpaper (this may be wrapped around the blade of a small screw-driver) should be used to properly clean the corrosion from these segments. Care should be exercised while performing this operation, so that the copper contact arms are not bent or twisted, for it is difficult to reshape these contacts or increase their

— NOTES —

*X a leaky .1 mfd condenser in the power pack bypassing the 1 meg resistor will also cause the same trouble.*



tension, without the possibility of loosening the mounting rivets.

## RCA-Victor RAE-68

This receiver is an automatic phonograph combination which employs a Radiola 82 chassis. Service data on this chassis will be found discussed under Radiola 80, 82, 86.

The automatic phonograph mechanism employed in this model is similar, in most respects, to those used in the models RAE-26, RAE-59, and RAE-79. Many of the mechanism failures described with these models under the RAE-79 will also apply to the RAE-68.

Most of the trouble experienced with this receiver is due to the remote control off-on switching mechanism. The complaint that the receiver cannot be switched "on" and "off", are the most common. Because of the current drawn by this model, especially when the automatic phonograph has been in operation, the strong arc created by the engagement of the relay armature with the two copper contacts, soon corrodes or burns away the ends of the contacts, resulting in the condition where the receiver cannot be switched "on." On most occasions, where depressing the "off" button will not switch the receiver off, the relay armature will be found spot-welded to the contacts. If the copper contacts are not burned away, necessitating replacement, they should be carefully cleaned with fine sandpaper and tinned. As a measure to prevent recurrences, connect a .5 mf. condenser or .1 mf. condenser across the two contacts.

When lengthening the cable of the remote control box, check the extension cable before installation. In many instances the fanned terminals at one end of the cable do not correspond with the fanned terminals at the other. The No. 1 right-side terminal may be found to correspond with the right-side No. 5 terminal at the other end.

Chattering of the tuning control when one of the sta-

tion selector buttons is pressed, may be eliminated by adjustment of the friction screw whose location is shown in Figure 28. It should not be adjusted too loosely.

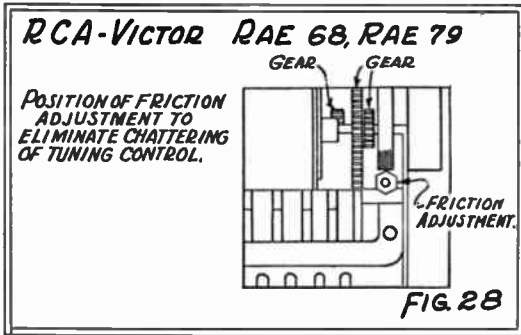

### RCA-Victor R-71, R-72

The complaint of reception cutting off sharply, oscillation, "station hiss", and unstable operation have, in most cases, all been traced to open-circuiting or open-circuited .05 mf. condensers bypassing the R.F. 1st detector and I.F. secondary return circuits. When one of these units open-circuits intermittently, a fading condition will result. An open-circuited condenser will produce the symptoms of weak reception accompanied by "station hiss" and oscillation. Because of the possibility of either or both of the two remaining units causing similar trouble, necessitating a repeat call, it is advisable to replace all three at once.

### RCA-Victor R-73, R-75

The symptoms of fading reception and "station hiss", as described with the models R-71 and R-72, are likewise

attributable to defective .05 mf. condensers bypassing the R.F., 1st detector and I.F. secondary return circuits.

Reception cutting off sharply at low volume control settings is usually due to a break or failure in the antenna system. This defect will not be apparent with the volume control advanced, because of the A.V.C. action of the 55 2nd detector tube.

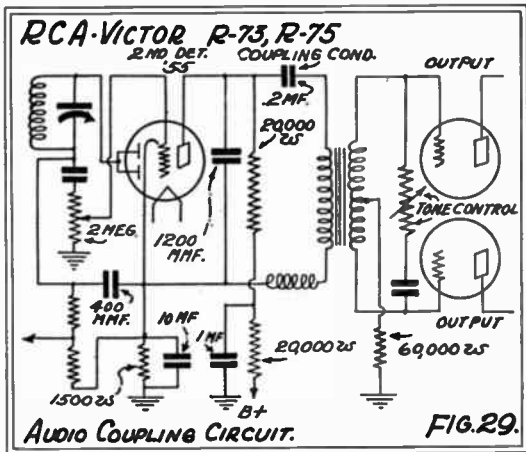

Where the complaint of weak and distorted reception is received, and the usual loud hum cannot be obtained by placing a finger upon the control grid of the 55 tube with the cap connection removed, check for an open-circuited .2 mf. audio coupling condenser. This unit is located beneath the resistor terminal strip and is connected in the circuit as shown in Figure 29.

The .2 mf. condenser employed as an audio coupling unit as shown in Figure 42, and mounted under the resistor terminal strip, frequently open-circuits and produces the complaint of intermittent reception. The open-cir-

cuit usually consists of poor contact of the terminal lugs within the unit itself and the condenser must be replaced.

The symptoms of distorted reproduction with an indi-

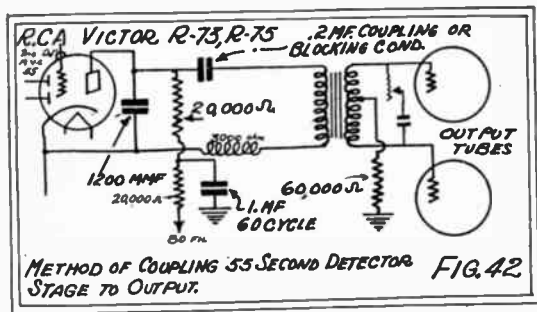

cation of excessive plate current drawn by the power output tubes as disclosed by a set analyzer, have been traced, in several cases, to an open-circuited 60,000 ohm resistor in the push-pull input secondary return circuit. This unit is also located under the resistor terminal strip.

### RCA-Victor R-74, R-76, R-77

Fading or a sharp drop in volume, on these models, is due to open-circuited .05 mf. bypass condensers in the R.F. 1st detector and I.F. secondary return circuits. Weak reception, oscillation, or resonance "hiss" is caused by an open-circuited condition, or a decrease in the impedance or capacity of these same units. Connection to the condenser is made by the metal tabs inserted into the condenser, which rely to a great extent upon pressure for their contact. Vibration, heat, and entrance of the wax sealing compound causes these tabs to make faulty internal contact, soon resulting in a high resistance connection which may materially alter the capacity of the unit.

Motor-boating between stations, oscillation and ex-

tremely noisy tuning, is caused by corroded or dirty condenser gang rotor contacts. Although these springs may be cleaned and reshaped, a more satisfactory repair may be made by pig-tailing the rotor shaft to the chassis.

Intermittent reception, and often an inoperative receiver, is frequently caused by an open-circuited .1 mf. audio coupling condenser, which is mounted upon the metal shield of the 82 rectifier socket.

Where the condition of distorted reproduction at station resonance is encountered on these models, check the .05 mf. bypass condensers in the R.F. first detector and I.F. secondary return circuits. Since these condensers are in the A.V.C. circuit, any leakage in the condensers will remove or "cancel out" the negative bias applied to the control grids of these tubes and produce the complaint stated. On some occasions, these condensers may check satisfactorily with an ohmmeter test, as the leakage occurs when the receiver is in operation. In this case, each condenser should be disconnected in turn and a perfect unit substituted to determine the defective component.

### RCA-Victor R-78, R-78A

Fading, oscillation, weak volume, and "station hiss" as in the Models 74, 76, 77, are caused by open-circuiting R.F., 1st detector and I.F. secondary return bypass condensers. In this case, however, the capacity of the units are .1 mf. A fairly good indication of this open-circuited condition, is an improvement or increase in volume, when a finger is placed upon the control grid cap of the 58 tubes in the R.F., 1st detector and I.F. circuits.

Noisy tuning, motor-boating, and oscillation at the higher frequencies, are due to corroded tuning condenser rotor contacts. The rotor shaft should be pig-tailed to the chassis by means of a length of flexible insulated wire.

Hum of a mechanical nature, on a number of occasions, has been found to be caused by loose, vibrating laminations of the filter choke. As this unit is contained within

a metal housing and sealed with insulating compound, the condition is not easily rectified. Remove the choke and heat carefully in an inverted position so that the pitch does not spill over. If the hum is still present after the unit has been re-connected, strike the metal case smartly, several times, with a light hammer.

Intermittent and noisy reception has frequently been traced to a faulty volume control. In some instances, the trouble may be corrected by bending the movable contact arm to secure more tension, and applying a thin film of chemically pure vaseline upon the resistance strip.

As stated with the models R-74, R-76, etc., the complaint of distortion upon resonance, at any volume level, which may be cleared by slightly shifting the dial setting, has been traced to leaky .05 mf. secondary bypass condensers in the R.F., first detector, and I.F. circuits. As this condition is often not revealed by an ohmmeter test, the condensers must be checked for leakage by some high voltage method, or disconnected while the receiver is operating and a new unit substituted.

This receiver has been serviced on a number of occasions for the complaint of intermittent reception and distortion. In this case, the complaint was associated with the fact that it was possible, when reception ceased or became distorted, to clear up the difficulty by shifting the station selector dial 10 or 20 kilocycles on either side of the station frequency. The condition was traced to the oscillator series condenser. This unit, mounted across two terminals on the side of the first detector-oscillator coil, is composed of a number of plates whose ends are soldered together. One or more of these tabs were found to have snapped between the soldered terminal and the point at which the tab emerges, thus reducing the effective capacity of that condenser. In some instances, a repair has been effected by re-soldering the snapped tabs, where the break has not been too close to the condenser case.

## RCA-Victor RAE-79

The tuning chassis employed in this model is identical to that of the R-50 but for the remote control unit, which is similar in many respects to that used with the model RAE-68. Service data on the tuning chassis will be found under the R-50.

As described with the model RAE-68 failure of the off-on switching mechanism is due to one or both of the copper contacts being burned away. Where pressing the "off" button will not switch off the receiver, the copper contacts of the relay will be found spot-welded to the armature of the relay.

The phono, radio, home and radio recording remote change-over mechanism will not respond, if the small 17 ohm wire-wound resistor, connected across the socket of the pilot indicator, open-circuits. When this does occur, the pilot light will burn out and open the motor circuit.

Intermittent and noisy phonograph operation is due to a corroded friction contact on the movable arm of the phonograph volume control. This contact is a flat copper spring, which is riveted to the movable arm and rides upon an insulated terminal lug in the center of the volume control cover. The cover may be pried off and both the wiping contact and lug carefully cleaned of grease and corrosion. An insulated pig-tail installed between these two points will make a more permanent and satisfactory repair.

Where the remote control fails to respond when the different buttons are pressed unless the control box is held in certain positions, check for a break in one or more wires in the cable. This defect is almost always found at the point where the cable enters the control box. A repair may be effected by cutting away the cable at the break, after the insulation has been removed so that each lead can be marked and re-connected to the proper terminal.

Servicing of the automatic phonograph mechanism has

— NOTES —

been made necessary by several major failures, which will be discussed in turn.

When the bottom record or records are dislodged, as the record magazine returns to position after a record has been deposited upon the turn-table, check the adjustment of the magazine roller. This roller should be placed in such position, that it is at right angles to the record magazine shaft and will just touch the magazine when the latter is empty and passing through its cycle.

If the record is carried back with the magazine and is not deposited upon the turn-table, the position of the record transfer lever will be found at fault. This lever should be adjusted by loosening the two mounting screws, and shifting its position so that when a ten inch record is placed against both pins on the lever, the record hole is above the spindle. A weak spring in the turn-table spindle which holds up the spindle nose, will also cause this trouble. By lifting off the turn-table the spring may be removed and stretched to increase its tension.

If the pick-up lowers upon the record and does not slip into the first groove of the record, or slides across several grooves, incorrect tension of the flat copper spring which presses against the locating lever of the tone-arm will be found at fault. In the first instance, the spring must be bent to increase its tension against the tone-arm locating lever. Where the pick-up slides across several grooves, the tension of the spring must be decreased.

Where the record is rejected, and the record-changing mechanism repeats its cycle as soon as the pick-up lowers upon the record, the four-finger lever will be found at fault. This lever operates on a riveted joint which loosens and disturbs the lever, preventing it from engaging with the clutch pawl. The rivet may be peened (hammered) down, but not so much as to interfere with the action of the lever. Insufficient tension of the small four-finger lever spring, will also cause the same condition. The purpose of this spring is that of holding the long arm of the four-finger lever in position against the clutch



pawl. Part of the spring may be removed to increase its tension. In some cases, the long arm of the four-finger lever may be found bent out of shape, so that it does not engage properly with the clutch pawl. This may be easily corrected by bending the arm either up or down so that it is at an even plane with the clutch pawl.

If the condition is encountered where the mechanism continually trips and cannot be stopped by pressing the "off" button, check the timing of the gears. With the main slide in its extreme forwarding position, the straight side of the cam gear should be parallel with the side of the slide, and the long arm of the four-finger lever should be engaged with the end of the clutch pawl. It is necessary to remove the clutch wheel by loosening its set-screw and lifting the clutch pawl plate, so that adjustments can be made. When the clutch pawl plate is replaced, it is important that the cable lever roller is engaged in the slot on the side of the clutch pawl plate, and the long arm of the four-finger lever is engaged with the end of the clutch pawl. The same condition may also be due to improper adjustment of the secondary switch whose contacts should open after a cycle is completed. The switch may be adjusted by loosening the two mounting screws and shifting the switch into position.

Another frequent cause for intermittent operation of the phonograph lies with corroded contact segments on the master transfer switch. This condition is easily remedied by removing the cover of the switch and cleaning each segment with a strip of fine sandpaper which may be wound around the blade of a small screw-driver.

### RCA-Victor RE-80

The complaints of extremely loud volume with no control, oscillation, no A.V.C. action, and motor-boating on the higher frequencies, are caused by the shorting of the pilot light socket or lugs to the metal shield in front of



an open-circuited speaker field in this circuit. As seen in Figure 30, the dynamic speaker in this receiver employs two field coils.

### **RCA-Victor RAE-84**

Service data for this model will be found discussed under the Model R-78A, the chassis being identical, except for the phonograph terminal strip. Causes for inoperation and adjustments of the automatic phonograph mechanism have been treated under the model RAE-79. An added complaint with this model, however, lies with the manual operation lever. Although an arrangement has been provided so that the manual lever cannot be moved while the mechanism is in cycle, an attempt to do so will bend the lever in such a way that it cannot be pushed into the manual position. With the lever in the manual position the latch-trip is made to ride upon the smooth surface of the manual lever and to clear the latch-plate. The only remedy to correct this condition, lies with the bending of the manual lever so that it will pass under the latch-plate.

### **RCA-Victor R-90**

This receiver has been serviced thus far for one major complaint, namely that of weak and distorted reception. Where this condition is encountered, check the small A.V.C. coupling condenser and grid resistor located within the first I.F. transformer shield.

### **RCA-Victor 140, 141, 240 and AVR-1**

A low insistent hum on these models which increases slightly as the receiver is tuned to resonance has been traced in some instances to the type 2B7 second detector tube, despite the fact no defect could be disclosed when the tube was tested in a tube checker.

— NOTES —

Where the complaint of noisy and intermittent reception is received, check the type 2A7 pentagrid converter tube. Because of many elements, it seems that this tube is particularly affected by the jolts and vibration to which the receiver is subjected to during shipment and installation. In the majority of cases, this defect will not show up when the tube is tested in the tube checker or with a set analyzer. Where leakage or short-circuits develop between the cathode or heater of this tube, the receiver may be found inoperative. A carrier hum is sometimes caused by one or more of the type 58 tubes. In some instances the condition may be eliminated by inter-changing the positions of all the 58 tubes.

It will be noted that tuning on the broadcast band is exceptionally broad for a superheterodyne receiver of this type, stations often being received 20 to 30 kilocycles on either side of the allocated frequency. The same tuning condenser gang is employed for the short wave bands as for the broadcast band and because of the wide band of frequencies covered by the short wave ranges, tuning on the broadcast range is made "broad" to prevent tuning on the short wave ranges to be too critical or sharp. The condition is normal.

Interference from 600 meter code stations on these receivers may be attributed to the fact that the intermediate frequency is 445 K.C. According to the manufacturer, the use of this frequency gives an especially good image frequency ratio and makes easier alignment of the oscillator at the higher frequency bands. One method of eliminating or reducing this type of interference is that of employing a wave trap whose secondary circuit is tuned to 445 K.C. An ordinary I.F. transformer of the frequency specified may be used as the wave trap. The primary of the transformer may be inserted in series with the antenna as close to the receiver as possible. Although the primary of the I.F. coil is of the high impedance type, it will have little or no effect upon broadcast or short-wave signals since these signals are not with-

in the frequency of the wave trap tuned circuit. Another method is shunting the primary of the I.F. transformer serving as the wave trap, across the aerial and ground as closely to the receiver as possible, in series with a fixed condenser. In the case of the highest frequency band of the receiver, an additional R.F. stage is utilized to reduce code interference.

### RCA-Victor 330

The complaint of wavering, vibrating record reproduction, accompanied by a strong hum, on this model, has been traced in several cases to the shipping blocks under the sides of the phono panel which have not been removed. These wood blocks are intended to keep the phono panel from vibrating during shipment and upon installation of the receiver. In order that the phono panel "float" upon the spring suspension, the blocks should be removed to prevent the transmission of any vibration to the record and pickup during record reproduction.

Where the condition of intermittent phono operation is encountered, or where the mechanism is inoperative, check the radio-phono transfer switch. The small tumblers within the switch housing often become disengaged from the shorting contacts of the switch. Because of its construction, it is inadvisable to attempt the repair of this switch and a new unit should be installed. An inoperative condition of the radio portion of the receiver has also been found to be due to failure of this switch. Where a set analyzer discloses the lack of plate voltage on the R.F. 58 tube, and a point-to-point resistance measurement indicates this failure to be due to an open cathode circuit in that stage, the phono transfer switch should be checked at once, since the cathode return of that stage is grounded when the switch is snapped to the "radio" position, and is open-circuited in the "phono" position. When this defect occurs, usually the switch cannot be snapped to

either the "radio" or "phono" position.

A common complaint with this model is poor control of record volume. A sharp drop in volume is usually obtained when the phono volume control is turned to the middle of its range. This trouble may be remedied by disconnecting the lead to the center-tap on the volume control resistance element. This center-tap on the volume control is employed in conjunction with a choke-condenser-resistor combination as shown in Figure 41, to reduce the high frequency response so as to reduce "needle

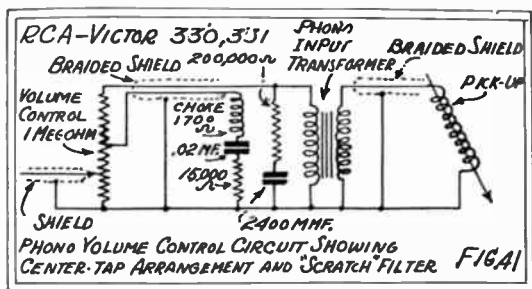

scratch." In all cases, however, where the center-tap has been disconnected, the increase in "needle scratch" has been negligible, not interfering with the quality of record reproduction. In the event such condition results, the tone control of the receiver may be used to lower the high frequency response.

### RCA-Victor 331

The RCA-Victor model 331 is a radio-phono combination employing an automatic phono mechanism. This phono mechanism is comparatively simple but has provided two major causes for complaint. Where the pick-up lowers upon the record and the needle does not slip

into the first groove, or the needle skips several grooves, it is necessary to readjust the switch lever locating screw. A 10 or 12 inch record should be placed upon the turntable and the index lever set to the proper position. It will be noticed that when the index lever is set for automatic operation, the switch lever (whose position is determined by the position of the tone-arm since they both operate together) will strike against a small screw, preventing the pickup to be returned to its rubber rest. If it is found that the needle does not slip into the first groove when the pickup lowers upon the record, the lock nut on the screw in question should be loosened and the screw adjusted counter-clockwise (looking at the slot in the screw). Should the pick-up lower upon the record and the needle skip over several grooves, this screw should be adjusted clockwise and the lock nut securely tightened.

When the mechanism fails to trip at the completion of a selection and reject the record, it will become necessary to readjust the tension of the pawl trip. This adjustment may only be made by removing the mechanism cover on top of the phono panel. A small forked lever will be seen here which engages a pin attached to the pickup arm. The screw directly behind the forked lever varies the tension upon the pawl trip finger. The screw should be adjusted for enough friction so that sufficient force is exerted to cause the pawl trip finger to trip the pawl under the phono panel.

A strong, vibrating hum, that is present during record reproduction has been traced, usually, to the fact that the wood shipping blocks under the sides of the phono panel have not been removed, thus preventing the panel to freely "float" upon the spring suspension provided.

Intermittent phono operation is often due to a defective radio-phono transfer switch. The small tumblers within the switch housing become disengaged from the shorting elements and cause the switch to become inoperative. Since switches of this type cannot easily be disassembled for the purposes of repair, it is best replaced. An in-

operative condition of the radio portion of the receiver has also been found to be due to failure of this switch. Where one of these receivers is encountered in an inoperative condition, and the set analyzer discloses the lack of plate voltage on the R.F. 58 tube, check this switch immediately, since the cathode return to that stage is open-circuited when the switch is in the "phono" position, and is grounded when the switch is snapped to the "radio" position. Usually, however, this failure can be easily noted for the reason that the switch cannot or is difficult to snap into the "radio" or "phono" position.

If the phono (or record) volume control becomes noisy at the center of its range and a sharp cut-off or drop in volume is obtained at this point, the condition may be overcome by disconnecting the lead to the center-tap on the volume control resistance element. The only purpose played by the center tap is to reduce the high frequency response so as to minimize "needle scratch."

### **Sonora A-30, A-32, A-36, A-40, A-44, A-46**

Fading and weak reception on all these models is most often due to leaky .1 mf. Sprague condensers, coupling each R.F. stage. This condition will be indicated by the rising plate current of the tube in the R.F. stage, in whose circuit the defective unit lies. This symptom is caused by the positive bias upon the grid resulting from the leaky condenser. These Sprague condensers, similar to those used on the Colonial 32, are of the waxed paper type whose connecting tabs are inserted into the unit, the electrical connection depending upon pressure. The complaint of intermittent reception has also been traced to these condensers, which open-circuit because of poor internal contact.

Oscillation at any frequency may be caused by insufficient bypassing in the R.F. amplifier. This condition may be remedied by connecting a 1 mf. or 2 mf. condenser across terminals No. 7 and No. 8 (counting from left



to right) on the audio unit terminal strip. In some instances, it will be found that the manufacturer has already added this unit, externally, by strapping it under the shelf of the tuner and audio unit.

Where the R.F. tubes are found to become continually weak, and an analysis discloses an extremely high plate voltage on these tubes, check the 135 volt bleeder resistor in the power unit. This resistor, in most cases, will be found of much higher value than specified, and in others, open-circuited. On the Models A-36, A-44, A-46, the value of the unit should be 14,500 ohms. The replacement resistor must have a rating of at least 25 watts.

Hum and distortion is most frequently due to unmatched power tubes, where one draws much less plate current than the other.

Lack of detector plate voltage is usually caused by an open 50,000 ohm carbon resistor located under the audio amplifier. This resistor may be checked by placing the ohmmeter terminals from the detector plate to the first audio plate.

### Sonora A-40, A-44, A-46

A common complaint on these models is weak and distorted phonograph reproduction. The principal cause of this condition lies with high resistance coupling between the heavy copper single-turn voice coil and the copper output transformer secondary. These copper bands should be dis-assembled by removing the bolts, nuts and insulating strips holding them together. The contact portions of the bands should be cleaned of all corrosion and carefully tinned before re-assembling. If the condition should still persist, the contact blades of the phono-radio transfer switch are probably at fault. The contact points may be cleaned with a small magneto file. In order to gain access to the switch, it is necessary to raise the motor board. While the contact points are cleaned, it is advisable to clean the movable arm of the phonograph volume control.

which may also cause weak phonograph reproduction if a high resistance contact exists at this point.

The unusual phonograph motor stopping arrangement, employed with these models, is frequently the cause for complaint. If the motor does not stop after the completion of the selection, or stops before the selection is completed, it is necessary to re-adjust the position of the motor in respect to the pick-up mounting screw. The distance between the center of the turntable spindle and the center of the screw should be exactly nine inches. The alignment is made by loosening the motor mounting bolts, and shifting the motor in the slotted mounting holes until the correct distance is obtained. The accuracy of this measurement is extremely important, for a discrepancy of even a fraction of an inch will defeat the alignment.

### Sparton 14

The symptoms of hum and distorted reproduction on this model, which may be of an intermittent nature, are caused by a partially shorted dynamic speaker field coil. An indication of this condition is seen in the pentode output tube grids becoming brightly red, because of the lack of grid bias; which reading cannot be obtained directly at the tube socket because of the high resistance in the grid circuit. Where the trouble is encountered the voltage drop across the field coil should be measured. The D.C. resistance of the field coil is 2,500 ohms, tapped at approximately 400 ohms for the output tube grid bias.

Where the condition of unstable and weak reception is encountered, especially at the high frequencies, check the 3,000 ohm carbon resistor in the 1st detector-oscillator cathode circuit. This component is shunted across the coil coupling the cathode to the frequency changing coil in series with the primary of the 1st I.F. transformer. Because of this fact, an open-circuited resistor will not be disclosed with a set analyzer but must be checked by a

point-to-point resistance measurement. An open-circuited .002 mf. 1st detector-oscillator cathode bypass condenser will frequently cause the same condition.

Many cases of fading and intermittent operation on this model have been traced to shorting condensers and resistors mounted upon the terminal strip beneath the output tube socket. The quickest method of locating or determining the cause is that of pressing down upon the terminal strip at several points and pulling upon the connecting wires.

### Sparton 18

The complaint of intermittent reception, where volume will decrease abruptly to a lower level, has invariably been traced to shorting components mounted upon the terminal strip located under the A.V.C. tube socket. In most

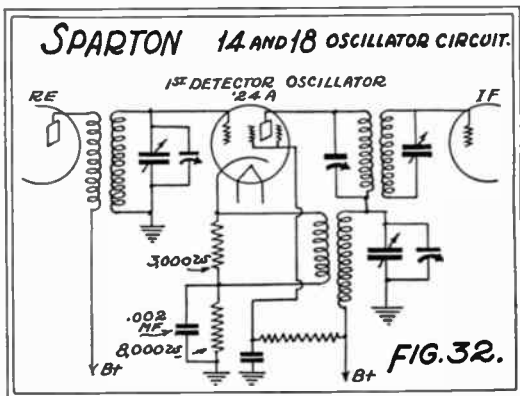

cases however, the trouble will be found to lie with unsoldered or poorly soldered connections to the wire-wound resistors on this strip.

— NOTES —

No control of volume is usually caused by a 56 tube in the A.V.C. stage with cathode-heater leakage. The same condition and distortion may be caused by grounded connecting lugs of the inter-station noise suppressor control.

Weak and unstable operation, particularly noticeable at the higher frequencies, may be attributable to an open-circuited 3,000 ohm resistor in the cathode circuit of the 1st detector-oscillator tube. As with the Model 14, this resistor is connected in shunt with the coil which couples the cathode of the 1st detector-oscillator, to the frequency-changing coil in series with the primary of the first I.F. transformer. The same symptoms may be due to an open-circuited .002 mf. cathode bypass condenser. The schematic of this portion of the receiver is shown in Figure 32.

### Sparton 25, 26, 30

An inoperative receiver with lack of plate voltage on the second I.F. and oscillator tubes, and low plate voltage on all others, is frequently caused by a short-circuited 1 mf. metal-clad cartridge condenser located behind the push-pull input transformer. The same condition may be due to the fact that the condenser has shifted, and its center terminal which is insulated from the chassis as it passes through the opening provided for it, is shorting to the chassis. The terminal mounting screw may be loosened and the condenser re-allocated to clear the short. When this same unit open-circuits, the symptoms of oscillation, motor-boating and weak reception will be encountered.

A high emission or gassy 27 tube in the A.V.C. stage will often be the cause of weak reception, and the situation where reception will fade out gradually after a few minutes of operation. During this time, it will be noted that the volume control will have little or no effect.

Fading and poor control of volume on these receivers is frequently due to leaky .2 mf. condensers bypassing the

1st R.F., first detector and I.F. secondary return circuits to ground. These units are of the paper cartridge type, more or less affected by vibration and heat.

A mechanical hum which may be heard even after all tubes have been withdrawn from their sockets, is caused by one or more bent laminations of the power transformer. Tightening the lamination bolts and nuts has not alleviated the condition. In some cases, a repair has been effected by removing the power transformer and placing the laminated core between the jaws of a strong vise. The transformer must be removed from the shield in order to

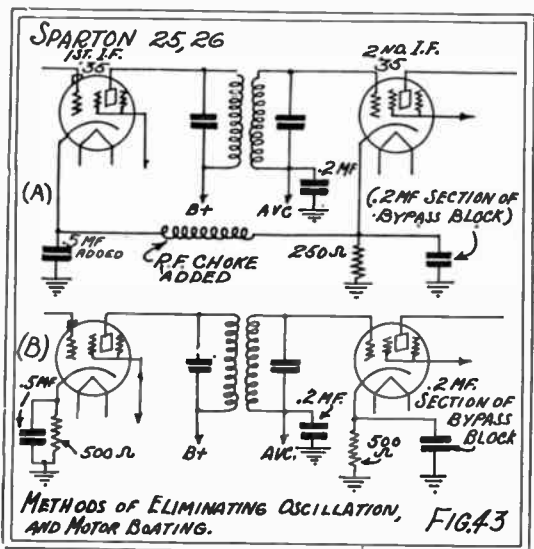

perform this operation. Tightening the vise will flatten any bent laminations and remove any air gaps that may be the cause of the vibration. Where this procedure does not

— NOTES —

remedy matters, a new power transformer must be installed.

The complaint of oscillation and motor-boating may be received on these models after the set has been in operation for some time. If these symptoms are not caused by open-circuited bypass condensers, poor tubes, or incorrect alignment, it may be necessary to employ an R.F. choke in the first I.F. cathode circuit with a .5 mf. condenser connected from the cathode side of the choke to chassis as shown at (A) of Figure 43, to overcome the condition. In the event this change does not remedy the trouble, a separate cathode bias resistor and bypass condenser must be provided for the first I.F. stage, as shown at (B), to overcome the coupling effects of the common biasing resistor. Since the value of this latter resistor is 250 ohms, altering the circuit so that the first I.F. tube is separately biased, would require the removal of this resistor and the addition of two 500 ohm cathode bias resistors, each bypassed separately.

### Sparton 30

This model employs an automatic phonograph mechanism which requires service because of several minor complaints. One of the most common troubles is the failure of the indicating mechanism to adjust itself for 10 or 12 inch operation, so that the pick-up is placed in the proper position for the playing of these records. Usually the fault may be traced to the switch within the kick-off arm compartment not making contact. This switch, whose contacts should close when their rollers pass over the surface of a 12 inch record, energizes the solenoid, whose plunger actuates the change-over mechanism. In some instances, the same condition may be due to the shifting of the solenoid so that the plunger arm binds. The mounting screws of the solenoid may be loosened and the solenoid adjusted so that the plunger works freely. Insuf-

ficient tension of the plunger arm spring is another cause for the same complaint. The purpose of this spring is that of returning the cam which is actuated by the plunger arm, back to its former position. The condition may be corrected by removing part of the spring to increase its tension.

If the receiver fuse should "blow" every time a record is rejected, check the indicating switch within the kick-off arm compartment. This may be done by removing the kick-off arm. It is possible that the switch shorts to the kick-off arm shaft as it lowers, or to the side of the kick-off arm compartment enclosing the switch. In either case, operation should be observed, and the proper insulating precautions taken.

**Sparton 99, 101, 103, 109, 110, 111, 235, 301, 564,  
570, 574, 578, 589, 591, 593, 600, 610, 620,  
737, 740, 750, 871, 930, 931**

The models listed above employ the same or similar R.F. amplifier and band-pass tuning units. Because of this fact, and to avoid repetition of the same symptoms and failures common to these units for each model, they will be discussed under one heading. Troubles peculiar to each receiver will be treated and listed under that model number.

The complaint of weak and distorted reception is often due to a leaky tubular .25 mf. plate bypass condenser in the R.F. amplifier unit. This fact may be determined by removing the screw connecting the outside terminal of the condenser to chassis or ground. It is not necessary to dis-assemble the entire R.F. amplifier to remove this leaky or short-circuited unit. With the end-terminal screw removed, raise the terminal and turn the condenser in a counter-clockwise direction until it may be lifted out. On most of these models, the replacement condenser may be installed externally as close to the R.F. amplifier as

possible, without any noticeable ill effects. It may be connected in most cases, from the 6th terminal on the R.F. terminal strip to chassis.

An inoperative receiver with the symptoms of no plate voltage on any of the R.F. tubes and lower plate voltage on the output tubes is frequently caused by a short-circuited 5th R.F. transformer. To secure a higher degree of coupling, the primary and secondary windings are wound together. The short-circuit consists of a breakdown of the insulation at some point in the winding. The easiest and quickest remedy is replacement, although the coil may be repaired by unwinding the entire bobbin, and locating the shorted point. This is too tedious and not worth the trouble.

Where the complaint of weak reception is received and an analysis discloses lack of grid voltage on the detector tube, look for an open-circuited detector grid choke. This unit, located under the amplifier near the detector tube socket and identified by a red dot on the bobbin, is almost certain to open-circuit when the 5th R.F. transformer is found with the primary winding short-circuited to the secondary.

Noisy tuning is invariably due to the plating on the tuning condenser plates, peeling. This condition is rectified by disconnecting all coil leads from the tuning condensers, and applying high voltage across the terminals of the condensers while rotating the tuning selector. Arcing at the shorted points will burn away the plating and effect a repair.

Intermittent reception and fading is caused by the snapping of the R.F. coil leads at their terminals because of vibration. This condition is of an intermittent nature and sometimes difficult to locate. The open connection may not be seen because of the wax compound with which the coils are treated. Extreme care must be exercised when re-soldering these leads to the terminals, for the wire is very fine and the heat of the soldering iron may melt away the wire. The same complaint may be



due to poor connection between the band-pass and R.F. amplifier units, which is made through a bayonet pin attached to the band-pass unit that is engaged by a spring clip on the R.F. amplifier. This clip must be tight and the bayonet pin free from corrosion.

When the condition is encountered, where the volume level increases until the volume control has no effect, and then reception gradually returns to normal, look for a leaky 1 mf. cathode bypass condenser in the R.F. assembly. This fact may be determined by disconnecting the volume control leads at the terminal strip. If the condensers are satisfactory, the receiver should be inoperative. Any reception obtained with the volume control disconnected, will point to leaky condensers, providing of course, that none of the 484 or 485 tubes in the amplifier are found with leaky-cathode heaters. The 485 is more liable to this fault as it is a quick heater and the cathode-heater insulation is thinner.

After removing either the band-pass or R.F. amplifier units for the purposes of repair, it is extremely important that the mounting nuts holding these units to the chassis board be securely tightened, or the receiver will become inoperative.

### Sparton 99

Where an inoperative receiver is encountered, and the plates of the 81 rectifier tubes become red, resulting in the "blowing" of one of the fuses, check the rubber covered leads passing in and out of openings in the bottom of the power unit, which have become soft and spongy and "short" to the chassis. New substantial heavily-insulated leads should be installed.

### Sparton 101

The symptoms of blasting, oscillation and poor tone quality, are caused by an open-circuited 7,000 ohm bleed-

er resistor in the power unit. An analysis will disclose an extremely high plate voltage on the R.F. tubes, which should be approximately 125 volts. This resistor, which sometimes increases in value and causes the same trouble, is connected across the plate supply for the R.F. tubes.

Hum on these models may often be traced to a short-circuited .1 mf. condenser connected across the first filter choke in the power unit.

### Sparton 301

The symptoms of low volume and distorted reproduction are sometimes due to reversed connections to the dynamic speaker field coil. This condition will be disclosed with a set analyzer by low plate voltages obtained on the output tubes. Since the center-tap of the output transformer primary is tied to one side of the field coil, as shown in Figure 33, reversal will cause this trouble.

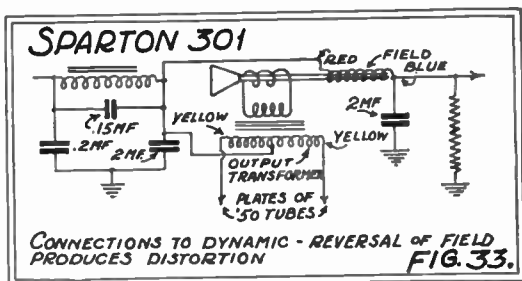

Oscillation, poor tone quality, and blasting, may be traced to an open-circuited 7,000 ohm bleeder resistor in the power unit. This defect is made evident by the unusually high plate voltages obtained on the R.F. tubes. An increase in the value of the resistor will result in the same condition.

— NOTES —

## Sparton 410, 420

An inoperative receiver with an R.F. plate-chassis short-circuit, is due to several defects. Vibration may cause the common B+ terminal, which is insulated from the chassis by means of insulating washers, to shift and "short" to chassis. Another cause for the same condition lies with the shorting of the shielding leads connecting the plates of the R.F. 24 tubes to the R.F. coils. The rubber insulation of the leads becomes spongy and shorts to the ground shielding.

Noisy tuning and noisy reception will be found caused by the peeling of the plating on the plates of the tuning condensers. This condition may be rectified by disconnecting the leads to the tuning condensers and applying high voltage across the condenser terminals while rotating the station selector. The peeled plating will burn away at the shorted points. Small foreign particles and dust between the plates will produce the same condition.

## Sparton 591

Noisy reception, which is definitely determined to originate within the receiver itself, may be traced by withdrawing each of the R.F. tubes, thus eliminating stage by stage until the cause or offending circuit is located. Almost invariably the audio transformer in the intermediate audio amplifier stage, mounted in an inverted position under the chassis baseboard will be found at fault.

## Sparton 600, 612, 620, 737

A frequent complaint on these models is that of reception cutting off and a noisy condition remaining. In most cases, the trouble has been traced to the audio transformer, whose primary intermittently short-circuits to the core. Tapping the unit with a light hammer or the handle of a screw driver will usually disclose the defect.

by producing the same effect. The transformer must be replaced.

The symptom of weak reception on all but some of the more powerful broadcasters has often been found due to an open-circuited coil in the band-pass unit. These coils may be quickly checked with some continuity device connected from the stator of each tuning condenser to chassis. Almost always, the open-circuit is caused by the snapping of the coil lead at the connecting lug.

Where the receiver suddenly bursts into full volume, look for a leaky .2 mf. bypass cathode condenser in the pre-selector stage. Frequently the same condition will result when this unit, upon vibration, intermittently shorts to the shield of the band-pass unit. The remedy in either case is obvious.

A strong resonance hum may be eliminated in some instances, by substituting the .006 mf. condenser, connected from one side of the power transformer primary to chassis, with a .5 or 1 mf. condenser. It is important, however, that this condenser be of the non-inductive type.

The symptoms of oscillation and distorted reproduction, which is not caused by open-circuited bypass condensers, are often attributable to a defective 15,000 ohm bleeder resistor in the power unit. Often, this resistor may increase in value and the same effect is obtained.

A common cause for loud hum and distorted, muffled reproduction, has been traced to a partially shorted dynamic speaker field coil whose D.C. resistance should measure 5,000 ohms. The annoying circumstance attached to this complaint is the fact that the partially shorted condition may clear up as soon as the receiver is switched off for the purposes of test. For this reason, the field coil can be checked only by measuring the voltage drop across it.

The complaint of hum and distortion is sometimes due to a weak 183 tube. Where both these tubes check satisfactorily, the trouble may be due to an unbalanced condition of the push-pull input transformer secondary. Re-

sistance measurements taken from the grids of the 183 tubes to chassis, will disclose this defect. Remedy is replacement.

When the symptom of the sudden cutting off of reception is encountered, and where reception can be brought back by quickly withdrawing one of the output tubes and re-inserting it into its socket, check for an open voice coil pig-tail connection.

### Sparton 737 (Above Serial No. 6502)

An inoperative receiver is often caused by an open 1300 ohm wire-wound resistor located alongside the 80 rectifier socket. This unit serves to reduce the voltage output of the larger power transformer which was originally in-

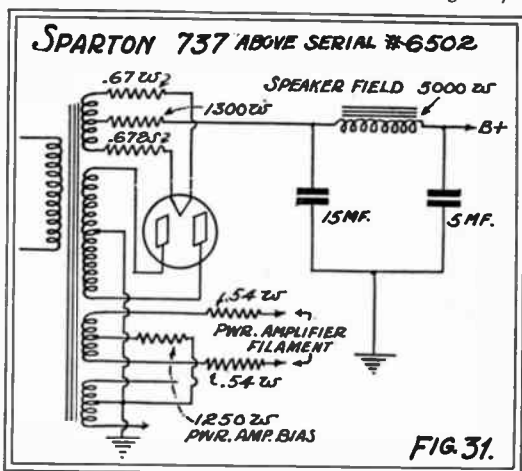

tended and designed for use in the Model 301 receiver. It is connected as shown in Figure 31.

Where no filament voltage can be obtained at either the

— NOTES —

80 or 183 tube sockets, look for burnt out filament resistors. These resistors are employed to cut down the  $7\frac{1}{2}$  volts supplied by the secondary filament windings to the necessary 5 volts.

The complaint of the receiver constantly "blowing" fuses is often due to the power transformer breaking down. For some reason, this transformer which was designed for heavier use, does not stand up.

### Sparton 740, 750

The symptoms of loud hum, oscillation and distorted reception, have often been traced to a loose, common terminal connection of the three-section condenser block. To rectify this fault the condenser block must be removed. This is done by removing the two mounting nuts and re-soldering the loose terminal at the base of the block.

Blasting and oscillation accompanied by the symptom of unusually high plate voltages on the R.F. tubes, have been found due to an open-circuited 7,000 ohm bleeder resistor. This unit is located in the power unit and should be replaced with a resistor of a higher wattage rating.

A fading condition may be caused by a leaky or short-circuited cathode bypass condenser in the pre-selector stage. The quickest method of determining this failure is that of disconnecting the volume control leads from the terminal strip. If the receiver operates with these leads removed, the condenser must be replaced.

### Sparton 870

Where noisy reception of an arcing nature is encountered on this model, examine the outlet at the side of the power unit provided for the connection of the external filter choke. The insulation between the contacts of the outlet breaks down, and arcing takes place across the terminals. If the contacts of the outlet are checked, one or

both may be found blackened and charred because of the arcing. Replacement is the only remedy.

### Sparton 930

Hum and noisy reception have been traced as caused by poor contact between the "can" of the electrolytic condenser and chassis. Corrosion of the copper can, and paint on the flanges of the opening in which the electrolytic condenser is inserted, will set up the poor contact and cause the complaint.

### Stewart Warner 102A

The complaint of distorted reproduction, regardless of the volume control setting, may be eliminated as well as materially increasing the volume, by connecting a 500,000 ohm resistor from detector screen to chassis. This data applies to chassis bearing a serial number above 34,000. Where the same complaint is encountered on receivers be-

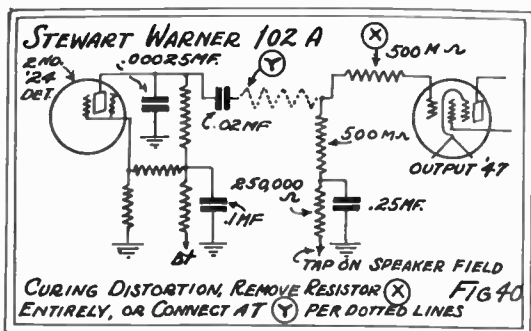

low this serial number, check for an open-circuited 2 megohm resistor in the screen circuit. Lack of screen voltage on the detector tube will evidence this defect.

— NOTES —

The symptoms of slight motor-boating and distortion on the models bearing the serial number below 34,000, are caused by too high a resistance in the grid circuit of the pentode output tube. The 500,000 ohm resistor connected as shown in Figure 40, should be removed entirely from the circuit, or connected directly after blocking condenser as shown by dotted portion of diagram.

### Stewart Warner 105 Series

One of the most common complaints on this model is that of interference on all of the short wave bands from some broadcasting at 1400, 1450 or 1500 K.C. generally the last. This condition may be rectified, by slightly detuning the middle short wave I.F. trimmer (counter-clockwise) located to the right of the condenser gang.

Weak reception with the local-distance switch in the local position, may be cleared up by re-aligning the broadcast R.F. circuits for maximum response at 1400 K.C. This may be done by re-adjusting the last three trimmers on the condenser gang. In some instances, it will be necessary to change the 57 tube in the A.V.C. stage, for one drawing less plate current.

These models are not infrequently serviced for the complaint of fading when the receiver is switched on. Reception will disappear gradually until total inoperation results. On some occasions, it is possible to restore reception by removing the A.V.C. tube. This condition is due to the failure of the two megohm carbon resistor in the A.V.C. grid circuit. This unit is located together with the A.V.C. grid coupling condenser within the second intermediate frequency coil. Removal of the negative bias impressed upon the grid of the A.V.C. tube will cause the tube to draw more current and produce a greater voltage drop across the resistor in the plate circuit which is also in the control grid circuits of the R.F., first detector and I.F. stages, resulting in an abnormally high



control grid bias impressed upon the tubes of these stages. This high bias reduces the plate current drawn by these tubes thereby decreasing the sensitivity of the receiver.

Very noisy and intermittent reception which is heard when the chassis is disturbed, by moving the cabinet or from vibration of the loud speaker, or from vibration caused by passing vehicles has in almost every instance been traced to loose or corroded contacts and contact arms of the wave band transfer switch. One or two of the sections of this ganged switch are easily accessible, but because of the crowded quarters and metal shields, the inside sections of the switch are difficult to clean. A very thin flexible file or an emery board, such as commonly used by manicurists and which may be purchased at any Five and Ten, are better suited for the task of cleaning the corrosion from the switch contacts than any other tool, unless the switch gang is disassembled.

In these receivers, unless the chassis mounting bolts are loosened so that the chassis floats on the soft rubber cushions provided for the purpose, a strong microphonic condition will develop when tuning in short-wave signals. At the same time, the chassis should be moved back slightly to prevent the flat portion of the dial pointer arm from binding against the cabinet. Unless this is done, it may be necessary to replace the rubber friction tuning gears, which will become excessively worn within a short time because of the increased friction resulting from the binding of the dial pointer arm.

### Stromberg-Carlson 10, 11

An inoperative receiver has often been found to be caused by the screws connected to the stators of the first and third tuning condensers grounding. They pass through the condenser section shields and are insulated from the shield by beeswax compound. They may be disconnected from the circuit without any ill-effects, whatever.

No control of volume may be due to an open-circuited 100,000 ohm black carbon resistor connected from the second R.F. secondary return to the arm of the volume control potentiometer. The same condition may be obtained with one of the .3 mf. secondary return bypass condensers in the second and third R.F. stages becoming leaky or short-circuited.

Fading and intermittent reception has been traced in many instances to open-circuiting .04 mf. bi-resonator condensers, located within the tuning condenser gang shield.

The symptoms of weak and distorted reception, which can be cleared to some extent by the removal of one of the 45 output tubes, have invariably been found to be caused by a shorted push-pull input transformer, wherein the primary short-circuits to the secondary winding at some point. The transformer must be replaced.

Where the complaint of noisy reception is received, which has been definitely determined as originating within the receiver itself, check the primary of the push-pull input transformer by disconnecting the primary from the circuit and using the 250,000 ohm shunt resistor, and a .1 mf. condenser to couple the detector plate to one of the output grids.

### **Stromberg-Carlson 12, 14**

Poor swing of the tuning meter may be due to insufficient antenna or a poor 24 tube in the second R.F. stage. In some instances replacing the A.V.C. 27 tube will clear up the difficulty.

Fading and intermittent reception, as in the Models 10 and 11, have been frequently traced to open-circuited .04 mf. bi-resonator condensers, in the first and third R.F. amplifier circuits.

### **Stromberg-Carlson 19, 20**

The complaint of hum has been traced to an open-

circuited 3 ohm center-tapped filament resistor, located near the first I.F. tube socket.

Intermittent reception on these models is often caused by open-circuiting oscillator coil connections. Because of a tightly wound coil, the contraction of the wire or, vibration causes the coil leads to snap directly at the lug and make contact intermittently, producing the complaint. The same condition has been traced to an open-circuiting .04 mf. bi-resonator condenser in the R.F. stage.

### **Stromberg-Carlson 22, 22A**

An inoperative receiver, with an analysis revealing a lack of plate voltage on the second I.F. tube, has been traced to a short-circuited .0001 mf. mica condenser, coupling the plate of the second I.F. tube to the cathode of the diode detector. This unit is located at the base of the I.F. transformer within the shield.

If the tuning meter of this model has insufficient swing a 30 ohm resistor may be shunted across the meter terminals, providing the antenna is of sufficient length.

Intermittent reception or an inoperative condition has been traced, on several occasions, to an intermittently shorting trimmer condenser in the I.F. transformer. A socket analysis will not reveal this condition.

### **Stromberg-Carlson 25, 26**

A common complaint on these receivers is intermittent reception, where operation can be made to return by snapping the line switch several times. When an analysis is made, no plate voltage will be obtained upon the second detector. Further tests will disclose the fact that the primary of the push-pull input transformer breaks down and shorts either to the core of the transformer or to some portion of the secondary winding. In the latter instance it is possible to obtain distorted weak reception, which

may be cleared by withdrawing one of the 45 output tubes. An indication of this failure can seldom be obtained, with the receiver turned off, by means of resistance measurements between the second detector plate and chassis, as the transformer breaks down under load.

The condition of noisy reception which will evidence itself even with the second detector tube removed from its socket, has been found due to a noisy primary winding of the push-pull input transformer. This may be checked by disconnecting the primary winding and substituting a form of impedance coupling by means of the 250,000 ohm shunt resistor and a .1 mf. coupling condenser. A similar complaint has frequently been traced to a leaky .0001 mf. detector plate bypass condenser which is located within the shield of the second detector plate choke. Although a new unit may be installed, a satisfactory repair can be made by insulating the shield of the choke-condenser combination from the chassis and connecting a .0001 mf. condenser externally.

Intermittent reception has been traced to open-circuiting .04 mf. bi-resonator condensers, due to a poor internal connection, in the R.F. and 1st detector stages. Usually this symptom may be made to appear by rapping against the right side of the condenser gang shield, inside of which the bi-resonators are mounted. The same complaint has been found caused by the shield cans cutting into the connecting leads of the coils where they pass through openings at the base of the shields.

The symptom of no control of volume may be caused by several failures. Leaky bi-resonators or .3 mf. grid circuit bypass condensers in the R.F., 1st detector and I.F. stages, are the main causes of this trouble, although leakage in any part of the secondary return circuits of these tubes will produce the same complaint. The quickest method of determining this fact is that of measuring the resistance between the control grids of the R.F., 1st detector and I.F. stages to chassis with a good ohmmeter. A reading of approximately 100,000 ohms should be

obtained from the R.F. control grid, and approximately 200,000 ohms from the 1st detector and I.F. control grids to chassis. In the 25 cycle models, these readings are about 60,000 ohms less. Shorting of the 100,000 ohm black carbon resistor in the control grids secondary return circuit, to chassis, will produce the same condition of no control of volume. This resistor, connecting to the movable arm of the volume control, is mounted in a bakelite bracket near the volume control. The bracket loosens upon vibration and permits the resistor to short to the front wall of the chassis.

Distortion at any volume level is usually due to a leaky section of the second detector cathode bypass condenser unit, which is composed of two .3 mf. sections. Where this condition is encountered only at low volume control settings, the 24A tube in the second detector stage should be replaced or interchanged with the other 24A tubes.

The symptoms of "two-spot" tuning, fading, and poor control of volume have been traced to an intermittently shorting screw passing through the third tuning condenser shield. This screw is connected to the stator of the third tuning condenser and is insulated from the shield by means of a wax compound. When the screw short-circuits to the shield, volume will suddenly lower, reproduction will become distorted, and it will be necessary to re-tune the receiver about 20 to 30 K.C. from the usual setting of the dial, powerful stations being received at two points on the dial about 20 K.C. apart. The screw should be disconnected from the circuit.

### Stromberg-Carlson 27

Poor swing of the tuning meter may be due to an open 30 ohm shunt across the meter or to the fact that an antenna of insufficient length is employed.

If it is found that the volume level cannot be turned down low, or the receiver momentarily bursts forth with

full volume at a low setting of the volume control, change the volume control. Sometimes, the first condition may be caused by leakage of the insulation of the phono pick-up switch.

Fading, intermittent, and weak reception is frequently caused by an intermittently open-circuiting .04 mf. bi-resonator condenser.

Weak response and poor swing on the tuning meter, accompanied by the symptom of "station hiss", which can be cleared by placing the fingers lightly upon the control grid of the R.F. tube and chassis, has been traced to an open-circuited primary winding of the pre-selector coil or an open-circuited bi-resonator in the R.F. stage.

An inoperative receiver has sometimes been found caused by the breaking down of the .0001 mf. mica condenser coupling the primary to the secondary of the second I.F. transformer. This unit is located within the shield of the transformer.

## Stromberg-Carlson 29

The line switch in this model, incorporated with the tone control unit, is a frequent offender. Failure of the switch spring will prevent the receiver from being turned on or off. As the phonograph switch in the volume control is seldom used, the two controls may be interchanged, as the units are identical.

Where the condition of weak and distorted reception is encountered, which clears up when a finger is placed upon the control grid of the R.F. tube or when the receiver is slightly detuned, check for coil leads shorting to the shield can in the R.F. stage, an open-circuited primary winding of the pre-selector coil, or an open-circuited .04 mf. bi-resonator, all of which have been found at different times to cause this complaint.

An inoperative receiver is often caused by the burning out of the tuning meter. When this occurs, the .3 mf.

section of the condenser block bypassing the R.F. and 1st detector plate circuits, should be replaced.

Noisy and intermittent operation is often due to poor contact of the volume control slider arm. The arm should be cleaned and bent to increase its tension upon the resistance strip. The latter may be coated with a thin film of vaseline.

### **Stromberg-Carlson 38, 39, 40**

These receivers are frequently serviced because of the complaint of very faint and distorted reception, with the tuning meter found to operate normally as the dial is turned from station to station. Reception may be obtained by removing the first audio 56 tube. This condition has been traced to the lead connected to the grid terminal of the first audio socket, shorting to the sharp edge of the plate prong. The further indication of this defect lies in the series of very loud clicks that are heard when the volume control is rotated, because of the high voltage impressed upon this unit.

Noisy action of the volume controls used in these models may sometimes be cleared up by replacing the 56 tube in the first audio stage, which is gassy and draws too much plate current.

Cathode-heater leakage of the type 58 tubes may result in strong hum upon resonance.

Where the receiver is inoperative and the tuning meter needle does not swing, check either for an open-circuited or burnt out meter, or a shorted .3 mf. meter and R.F. 1st detector plate bypass condenser. If the meter is found at fault, install a new .3 mf. bypass unit and clip the original condenser out of the circuit, as temporary breakdown or leakage of this section will cause the meter to "go."

Weak reception with the added symptom of "station hiss", which may be cleared somewhat by placing a finger

upon the control grid of the R.F. 58 tube, has been found caused by an open-circuited pre-selector coil primary, or the primary of this coil grounded to the metal braid of the antenna binding post lead.

Distortion upon resonance, which may also be cleared by placing a finger upon the control grid of either the R.F. or first detector tubes, has been traced as caused by the shield can biting into and grounding the secondary return lead of that stage.

### **Stromberg-Carlson 38, 39, 40, 41 (second type)**

A noisy volume control condition may sometimes be eliminated by interchanging or replacing the 55 tubes which are gassy and draw too much plate current.

The symptoms of distortion upon resonance, weak reception, accompanied by "station hiss", conditions which can be cleared by placing a finger upon the control grid of the R.F. or first detector tubes, as described with the first production of these models, have been traced to an open or grounded pre-selector primary coil, or a grounded secondary return lead.

Intermittent and fading reception have frequently been found caused by rattling of one of the leads to the oscillator tracking condensers in the eyelet of the terminal lug, which connection has never been soldered. In some instances, the same complaint has been traced to the loose connection of the lead to the terminal lug on the second I.F. primary trimmer condenser.

As with the first type 38 Model, where the receiver is found inoperative and the tuning meter needle does not swing, check for an open-circuited meter or short-circuited .3 mf. bypass condenser. This condenser should be replaced in any event.

Where the tuning meter is found to operate normally and the receiver performs very weakly, check the voltage on the plate of the demodulator tube. If a much lower



reading than approximately 100 volts is obtained, replace the 1 mf. bypass condenser connected from chassis to the junction point of the 10,000 and 4,000 ohm carbon resistors in the demodulator plate circuit.

### **Stromberg-Carlson 48, 49, 50, 51**

The symptoms, failures, and remedies described with the second type 38 model above, have substantially been found the same on these models, with the exception of the volume control data. When a loud crackling noise or series of crackles is heard when the receiver is first switched on, check one or both of the 2A3 output tubes for loose or shorting elements.

A slipping tuning dial has been traced to the fact that the U-washer on the friction drive is binding to the opening in the cabinet. This condition may be rectified by loosening the mounting bolts so that the front of the chassis may be raised slightly, enough to free the action of the friction drive, to permit insertion of small rubber strips between the chassis and mounting board.

These receivers are frequently serviced for a continuous hum that is sometimes heard above low volume levels. In most cases, this condition may be remedied by replacing the type 55 tube. Where this does not assist matters, the small audio choke, located on the front side wall of the chassis between the volume control and voltage divider, may be short-circuited. This choke is employed in conjunction with the rear section of the volume control in a tone-compensation circuit to provide better low frequency response as the volume level is reduced. Shorting the choke out of the circuit does not seem to impair the quality of reproduction but has, in many instances, corrected the hum condition.

The symptoms of distorted reproduction at low volume levels when the receiver is tuned to resonance has each time been traced to the volume control. Since the unit employed in these models is a double volume con-

### **RIDER'S MANUALS!**

To have Rider's Manuals in your possession would be of immense value to you. Volumes I, II, III and IV now are available. These four volumes total 4000 pages.

See them at your dealer or write to us for descriptive literature.



**JOHN F. RIDER**

1440 Broadway

New York City

trol whose sections are riveted, the quickest and best remedy is that of immediate replacement.

A microphonic condition is due in large measure to the type 55 tube, because of vibrating elements when the volume control is advanced beyond a certain level. Loosening the chassis mounting bolts so that the chassis may float on the soft rubber washers does not always clear up the difficulty. It is sometimes necessary to insert several strips of soft rubber under the front and rear of the chassis so that additional "floating power" is provided.

When removal of the chassis is necessary and the bottom shield plate has been removed, care should be exercised in setting the phono-radio transfer switch in the center or base position before replacing the bottom shield plate. If the front center screw is replaced with the transfer switch in either the "phono" or "radio" position, it may be found that the switch cannot be rotated from that position. Some servicemen have adopted the practice of omitting this screw when the bottom plate is replaced. Since the screw serves as a stop, and the switch may be over-turned (thus causing considerable damage), it is best that the screw be used.

Where an inoperative receiver is encountered with the symptoms of excessive plate current drawn by the 2A3 power output tubes, check the two small 600 ohm carbon resistors connected to the hum control potentiometer in the secondary return circuits of the push-pull input transformer. A number of cases have been found where these resistors have been badly burned and carbonized.

Some of these models are equipped with an automatic phonograph mechanism which has provided several causes for complaint. During the operation cycle where the record is released by the record carrying arm transfer-finger about  $\frac{1}{2}$  inch or so from the turn-table spindle, it is usually due to an incorrectly adjusted pickup shoe and pickup tongue, or to the fact that the pickup head is too high or too low. In the first instance, the pickup shoe and tongue should be adjusted so that a record will pass

below the pickup and on to the pickup tongue and be held in position by the shoe attached to the front of the pickup. If the pickup shoe is too high the record will not be held in a horizontal position and will fall away from the record transfer-finger before the record reaches the turn-table spindle. If the pickup shoe is too low the record will not pass underneath the shoe, resulting in the same complaint. If the pickup head is too high or too low, the record will not slide into position under the shoe and over the pickup tongue. The height of the pickup is controlled by the small screw and lock-nut at the end of the tone-arm height adjusting lever under the tone-arm. This screw is easily accessible by raising the pickup arm.

Should the record be released by the carrying arm transfer-lever while carrying the record to the turn-table, the trouble may most often be remedied by adjusting the height of the rail upon which the record carrying arm roller rides. The height of the turn table spindle may also be at fault. If either too high or too low it may cause the record to fall away from the record carrying arm transfer-finger. The height of the turn-table spindle is varied by means of the large screw under the spindle shaft. If the spindle is too low the lock nut should be loosened and the screw turned in, or if the spindle is too high the screw should be turned out, until the top of the turn-table spindle is approximately  $\frac{1}{2}$  inch below the top of the record slides.

Another complaint received on the phono mechanism is the failure of the needle to slip into the first groove when the pickup head lowers on to the record. In some cases, the needle may lower on to the record but does not slip into the first groove, and in others, the needle lowers outside of the record or skips over several grooves on the record. If the needle lowers outside of the record or falls into the first or second grooves, a simple adjustment may be made by loosening the large screw holding the pickup head to the tone-arm and shifting the position

of the pickup either in or out, as the case may be, so that the needle will lower properly on to the edge of the record. If the needle lowers on to the edge of the record but does not slip into the first groove or skips over several grooves, the tension of the groove springs must be varied. There are two such springs provided (coil type), one for 10 inch and the other for 12 inch record operation, located under the pickup positioning cam-wheel. The tension of these springs are varied by means of small screws to which one end of the springs are fastened. Failure of the needle to slip into the first groove is caused by insufficient tension of these springs and is corrected by turning the adjusting screws clockwise (looking at the slot in the screw). Too much tension will result in the needle skipping past several grooves as the pickup lowers and is remedied by turning the adjusting screws in a counter clockwise direction.

In order to make some adjustments described and to observe the operation of the mechanism to determine causes for other failures, it is often necessary to remove the phono mechanism from the cabinet. Since the mechanism must be level to function properly and raised from the object upon which it is placed to permit the free action of all moving parts, some means must be provided to accomplish this. Four bolts about 12 inches long, and nuts, may be secured to serve as legs for the phono panel and are fastened to the corner mounting holes of the panel. If these bolts, or testing legs supplied by the manufacturer, are not available, when the phono mechanism must be removed in the field, two straight-backed chairs may be placed back to back and the panel suspended between the tops of the chairs. Of course, this is an emergency measure and unless the panel is handled carefully, considerable damage will result.

### **Stromberg Carlson 55, 56**

In these models, the complaint of distorted reproduc-

— NOTES —

tion has been traced to leakage of and *between* sections of the filter condenser block. This block, whose internal connections are shown in Figure 44, is fastened to the chassis by four screws and is equipped with an 8 prong plug which fits into an 8 hole socket on the chassis. At

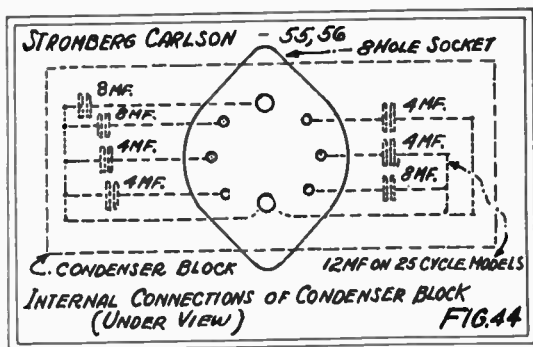

times, the leakage will show up only during operation of the receiver, and for this reason is difficult to check with an ordinary ohmmeter of limited range. If a voltmeter is employed in conjunction with a source of high voltage, locating the leaky section is made easier. Another method commonly employed by most service men is that of disconnecting each condenser, in turn, and substituting a unit of similar characteristics. Replacement of the entire block is unnecessary once the path of leakage is found. Those sections causing the trouble may be disconnected from the circuit and new condensers installed beneath the chassis.

When making tests on the model 55, it should be remembered that a resistance reading will be obtained across the line supply plug although the receiver is turned off. This indication is that of the primary of the step-down transformer which operates the off-on relay switch. The

— NOTES —

transformer is connected across the line supply at all times.

The increased brilliance and frequent burn-outs of the dial light when either the type 78 or 6A7 tube in the remote control unit is removed with the receiver "on," may be traced to the series heater arrangement of these tubes. The dial light is connected across the heater supply in series with a 47 ohm resistor.

### **Stromberg-Carlson 635, 636**

The symptoms of mushy and choked reception have frequently been traced to the pilot light socket shorting to the chassis, or to a short-circuited 2 mf. speaker output condenser.

Where the house fuse "blows" when the receiver is turned on, check the .01 mf. buffer condensers connected across the primary of the power transformer with their junction point grounded.

### **Stromberg-Carlson 641, 642, 652, 654**

A common complaint on these models is that of noisy, intermittent and fading reception. In the majority of cases, these symptoms are caused by a defective volume control in the antenna circuit. This unit is located in the rear of the receiver and is of the carbon type. Although the unit may be repaired, it is advisable to install a new volume control, preferably of the wire-wound type. The same condition is often caused by leaky .0005 mf. detector plate bypass condensers located within the housing of the detector plate choke. If the fault lies in these condensers, the noise will remain even after the detector tube is withdrawn.

Noisy reception, that has been determined as originating within the receiver and is characterized by a sputtering usually attributable to arcing, has been found to be due to

blistering portions on the voltage dividers. Replacement is the only remedy.

Provision has been made on the Model 641 for the use of a dynamic speaker with a high resistance field coil which is connected across the output of the rectifier tube. To accomplish this change, it is necessary to increase the AC potential upon the rectifier plates. This is done by removing the present connections to the 80 socket plate prongs and taping the leads up separately. The two taped brown leads emerging from the same cable are soldered to the plate prongs of the 80 socket. The AC leads of the outlet on the back of the chassis are removed and taped up singly. Two leads, one from a filament prong of the 80 rectifier and the other from the chassis, are now brought out and soldered to the outlet. To complete the re-wiring, the blue leads connected to one of the speaker tip-jacks should be removed and soldered to terminal No. 7 on the output transformer assembly, after the leads to terminal No. 7 and No. 3 have been removed from their respective terminals and soldered to terminal No. 5. The final move is that of connecting a lead to the empty tip-jack terminal from terminal No. 4 on the output transformer block.

The complaint of "wow" on the Model 654, or variation in the speed of record reproduction, which is usually apparent upon sustained notes, may be eliminated by changing the felt washers on the spindle upon which the turn-table rests, to one made of rubber. In many instances, it is necessary to overhaul the entire motor to correct the condition.

### Stromberg-Carlson 846

If the condition is encountered where reception is obtained only upon the removal of one of the 45 output tubes and an analysis reveals a negative grid bias of 25 volts upon one of the 45 tubes, and a positive bias of 160

— NOTES —

volts on the other, look for a shorted primary secondary of the push-pull input transformer.

The symptoms of motor-boating between stations and strong oscillation have invariably been traced to corroded variable condenser rotor contacts. Although the spring contacts may be cleaned the rotor shaft should be pig-tailed to the chassis for a permanent repair.

### **Victor 7-25**

See data on Radiola 17.

### **Victor 9-18, 9-54**

See data on Radiola 64.

### **Victor 14, 15**

See data on R-48.

### **Victor R-32, RE-45, R-52, RE-75**

Noisy and intermittent reception is a common complaint on these models and is usually due to a defective volume control unit, wherein the wire wound resistance strips become loose and unanchored. When replacing the volume control, care should be taken in connecting the leads to the proper section of the dual unit. The contact arm of one section, which is shunted across an absorption circuit of the second R.F. coil, is connected to the metal frame of the volume control and therefore grounded. If the lead from the grid of the first R.F. tube is connected to the movable arm of this section instead of to the insulated arm, an inoperative receiver will result.

A frequent and common cause for intermittent reception lies with an open-circuiting voice coil on this dynamic speaker, usually due to a broken connection to one of the voice coil pigtailed.

— NOTES —



Some of the earlier production models did not employ a "tuning" condenser across the first filter choke in the power unit. Where this .1 mf. unit is lacking a noticeable hum will be present.

An inoperative receiver, with the symptoms of no plate voltage on the detector tube, has been traced to corroded or faulty contacts on the radio-phono transfer switch. A slight hum and, at times, intermittent reception, have been found caused by a loose transfer switch assembly.

Distorted and unstable operation is sometimes due to the detector grid leak working loose from its wire terminals.

### Victor R-35, R-39, R-57

Where these receivers are encountered with the complaint of weak and distorted reception, which momentarily clears up when a finger is placed upon the control grid of the detector tube, or reception fades out after a few seconds, replace the 1.5 megohm white and red carbon resistor located under the resistor strip in the tuning chassis. This resistor, in the detector screen voltage supply circuit, because of its high resistance and the fact that a reading of only approximately two volts can be obtained when a socket analysis is made, is difficult to check.

Common causes for an inoperative condition have been traced to open-circuited detector or audio plate resistors with values of .5 megohms and 70,000 ohms respectively. The detector plate resistor located on the resistor strip in the tuner chassis, while the 70,000 ohm red and green first audio plate resistor is found in the power unit. Open-circuiting R.F. screen cathode and plate chokes are other common causes for an inoperative receiver. These chokes when found open-circuited, should not be removed from the circuit to obtain reception as oscillation and general instability will result.

Intermittent radio or phono operation on the Model RE-57 has been traced to corroded contact segments of

the master transfer switch. These segments should be cleaned with a strip of fine sandpaper.

### **Westinghouse WR5**

See data on Radiola 80.

### **Westinghouse WR6**

See data on Radiola 82.

### **Westinghouse WR7**

See data on Radiola 86.

### **Westinghouse WR10**

See data on RCA-Victor R-7.

### **Westinghouse WR12**

See data on RCA-Victor R-9.

### **Westinghouse WR14**

See data on RCA-Victor R-5.

### **Westinghouse WR15**

See data on RCA-Victor R-11.

## **Zenith 10, 11, 12, 102, 112, 132**

The voice coil of the Symington dynamic speaker used in these models cannot be adjusted in the manner usually employed with other type reproducers. In order to adjust the voice coil, it is first necessary to dismantle the field coil and speaker stand. This is done by removing the large bolt on the back of the "pot" and the speaker

stand screws. The center pole-piece is then turned and removed. Here, three screws will be noticed which should be loosened, so that the voice coil may be centered by inserting cardboard spacers between the frame and voice coil. Reverse the procedure for assembly.

The cause for intermittent and noisy reception lies with the three-point antenna switch employed in the first production models which should be replaced with the new type.

Intermittent reception is frequently due to a shorting .03 mf. audio coupling condenser, which is riveted to the chassis. The lack of insulating pitch over part of the foil causes the condenser to short to the chassis upon vibration. A new unit may be installed or the original component may be insulated and remounted.

The symptoms of oscillation and fading have been traced to open-circuiting .1 mf. screen and cathode bypass condensers.

Where a microphonic condition and hum is encountered, interchange the 24A tubes until one is found that will operate satisfactorily in the detector stage.

## Zenith 11E, 14E

Intermittent reception and frequently an inoperative condition, is usually caused by short-circuiting compensating condensers on the condenser gang. These compensating condensers, two plate units, are located in front of the second, third and fourth tuning condensers. As no insulating material is employed between the plates, small gummed papers should be pasted over the rear plate to prevent a recurrence.

A great number of these models employed a filament type volume control, which varied the voltage on the R.F. filaments. Because of the thermal inertia of the type 26 tubes, this type of volume control is often objectionable. If the rheostat is removed and the two leads con-

nected to it soldered together and taped, two different methods of controlling volume may be tried. A 50,000 ohm potentiometer may be installed in place of the rheostat with its shaft carefully insulated from the chassis. It is then shunted across the second or third R.F. primary, the best position to be determined by trial. The second form of control is composed of a 10,000 or 50,000 ohm potentiometer connected in series with a condenser whose capacity is best determined by trial, from the plate of the second R.F. tube to chassis.

### **Zenith 15-E, 15-EP, 16-E, 16-EP**

Weak and distorted reception on these models is often caused by an open-circuited 100,000 ohm "glastor" detector plate resistor, which condition will be evidenced by the lack of detector plate voltage. This resistor, of the grid leak type, is located in the receiver chassis and not in the power unit.

### **Zenith 41, 42, 422**

The complaints of oscillation, intermittent and noisy reception have often been found to be caused by a loose or broken terminal lug of the R.F. plate circuit bypass condenser located near the volume control.

Poor internal contact of the local-distance toggle switch mounted on the panel, which connects a .00025 mf. condenser in and out of the antenna circuit frequently causes the symptoms of noisy and fading operation.

### **Zenith 52, 53, 54, 55, 522, 532, 542**

A low hum that is not attributable to faulty electrolytic condensers may be eliminated by connecting a 250,000 or 100,000 ohm carbon resistor across the grids of the push-pull 27 tubes.

The complaint of fading and intermittent reception has

often been traced to cold-solder connections to the variable condensers which are disturbed by vibration of the chassis. A similar condition has been found to lie with open-circuiting R.F. coils, whose connecting leads snap at the lug and make intermittent contact. The volume control will also produce the same symptoms when the carbon element becomes worn.

When operation of the vernier stator of the first R.F. tuning condenser produces a noisy condition, look for a break in the pig-tail to the stator or corroded terminal connections.

The cause of 80 rectifier tubes burning out in those models utilizing automatic tuning, lies with the pilot light socket in the automatic tuner shorting to the metal frame or shield. As the pilot light is connected across the 45 filament supply, a short-circuit will place such load upon the power transformer that the 80 tube will "go."

A sharp rise and fall in volume is often caused by snapping of the fine wire leads of the R.F. chokes fastened to the eyelets. These units are located under the chassis. As the condition is intermittent, a set analyzer is of little assistance in localizing this trouble.

Where reception cannot be obtained above 650 K.C., look for end rotor plates on the tuning condensers shorting to the stator plates.

Noisy tuning on these models is caused by a corroded copper contact and washer at the end of the condenser gang rotor shaft. The contact spring and the washer should be cleaned and the tension of the spring increased by tightening the screw holding this contact against the collar on the rotor shaft.

## Zenith 70 Series

These models have much in common with the 50 series receivers. Service data described under these latter receivers will apply equally to the 70 series.

— NOTES —



check the 4.5 megohm carbon resistor which is shunted from plate to cathode of the A.V.C. tube.

A great many of the troubles associated with these receivers originate in some portion of the A.V.C. circuit and are due to the failure of some component therein. The fact that these models appeared with three different versions of the A.V.C. circuit makes trouble-shooting more difficult and involves procedure. In the first, the volume control was placed in the voltage divider system of the A.V.C. 24 tube which varied the cathode bias on this tube, as shown in Figure 45. A local-distance switch was also employed which shunted a resistor from the plate to the cathode of the A.V.C. tube when the switch was in the local position, thus impressing a constant bias on the R.F. first detector and I.F. stages. This serves to retard the A.V.C. action and reduce inter-station noise. A second revised circuit soon appeared as shown in Figure 46, with the manual volume control in

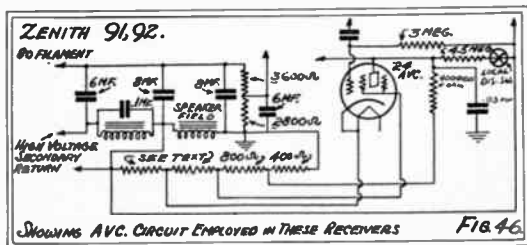

the grid circuit of the first A.F. stage. A tapped resistor was substituted in place of the volume control in the A.V.C. circuit shown in Fig. 45. This revision permitted the reading of the tuning meter to remain constant regardless of the position of the volume control because the A.V.C. tube operated at full efficiency. A further change was made, wherein the local-distance switch and the 4½ megohm resistor in series with it,

### IMPORTANT

When Replacing Burnt Out Field  
Coils Make Sure You Purchase A  
Field Wound On A

**LEOTONE BOBBIN**  
MOUNTED ON BAKELITE  
NOT PAPER

**LEOTONE RADIO CO.**

63 Day Street

New York



was eliminated in favor of a variable sensitivity control connected in the cathode circuit of the 51 I.F. stage. The A.V.C. voltage divider system remained without change. In this manner, the inter-station noise, usually associated with automatic volume control receivers, could be reduced by the setting of the sensitivity control, which increased the cathode bias on the 51 I.F. tube, thereby lowering its sensitivity. The cathode of this stage in the original circuit and first revised circuit was tied directly to the chassis.

The small wire-wound screen-cathode voltage divider of the A.V.C. tube, as already mentioned, has been the cause of a number of unusual complaints. When one of the two sections open-circuits or changes in value, replacement requires a certain amount of "juggling" to obtain the correct resistance values to operate with the tube employed in the A.V.C. stage. It will be noted that although the manufacturer specifies most of the resistor values in these receivers, the value of the screen-cathode voltage divider is not given. The quickest method of determining the correct relationship between the two sections of the A.V.C. screen-cathode voltage divider is to use a 20,000 ohm or a 15,000 ohm wire-wound resistor of the slider type, so that these sliders or taps may be adjusted to the necessary resistance value while the receiver is operating to obtain the most satisfactory combination. Although the values specified in a preceding paragraph are given as 15,000 and 3,000 ohms for the screen and cathode sections respectively, as well as 10,000 and 2,500 ohms; upon several occasions the only combination which would operate was 8000 and 2000 ohms. It may be well to mention at this point that the value of this voltage divider is exceedingly critical and unless the proper values are employed, unsatisfactory receiver operation will result.

### Zenith 230, 240, 244, 245

The condition of distortion at a low volume level is

— NOTES —



usually caused by an improperly centered voice coil on either dynamic speaker. In most instances, it is the larger speaker.

When this chassis is installed into custom-built cabinets and the mounting board is not as thick as that used in the manufacturers cabinets, do not tighten the back left mounting bolt for it will pass up too far and short to some component, often producing the symptoms of strong hum and distorted reception.

Hum on these models is almost invariably caused by electrolytic filter condensers which have lost their effective capacity. When the third filter condenser becomes bad, oscillation, weak and distorted reception will result.

### **Zenith, 410, 411, 420, 430, 440**

Hum on these models is also caused by faulty electrolytic filter condensers which have lost their effective capacity.

One of the causes for an inoperative receiver is an open shadowgraph tuning meter.

Where it is found that reception fades out a few minutes after the receiver has been switched on and can be brought back by removing the A.V.C. 57 tube, replace this tube.

### **Zenith 705, 706, 707, 711, 750**

The symptoms of an inoperative receiver with the grids of the I.F. 58 tube glowing red, can be traced to a shorted primary-secondary I.F. transformer. The shorted condition may easily be rectified by dis-assembling the unit and clearing the leads of one winding from the other.

Interference from 600 meter code stations on these receivers is particularly strong over the entire tuning range and is attributable to the fact that the intermediate frequency employed is 485 K.C., and no R.F. or pre-selector stage is provided to suppress or reduce this source

of interference. One solution to the problem is that of employing a wave trap whose circuits are tuned to 485 K.C. This wave trap may consist of an ordinary I.F. transformer of the frequency specified. The primary of the transformer is connected in series with the antenna as closely to the receiver as possible, and the secondary winding is "tuned" by means of the usual semi-fixed condenser shunted across the winding, to 485 K.C. Another method is to shunt the primary of the I.F. transformer, serving as the wave trap, across the aerial and ground as closely to the receiver as possible, in series with a fixed condenser. In some cases it may be necessary to readjust the secondary tuning condenser if the code interference is not satisfactorily reduced.

Where the condition of intermittent oscillation and motor-boating is encountered with the attendant widening of the shadow of the tuning meter, correctly designating the trouble to lie within the R.F. portion of the receiver, check the .1 mf. condenser bypassing the I.F. 58 secondary return circuit. This condenser is one section of a double unit also housing a .1 mf. condenser bypassing the grid return of the type 59 power tube. The difficulty attached to this complaint is the fact that the condition may clear up immediately upon the insertion of a set analyzer plug, or when a condenser is used to shunt a suspected unit in an attempt to locate the trouble.

### Zenith 715, 755, 756, 474

If the complaint of a "frying" noise at low volume levels is received, and this condition exists after the aerial and ground have been disconnected and the antenna lead of the receiver is grounded to the chassis, replace the type 55 second detector A.V.C. tube. In some instances, the same tube is the cause of a peculiar, irregular "popping" sound heard in the loud speaker, which is often attributed to local disturbances or atmospheric conditions.

Where poor control or no control of volume is en-

countered, accompanied by slightly distorted reproduction, check the R.F. and first detector secondary return bypass condensers. Since these units are connected in the A.V.C. circuit, leakage will "neutralize" or "balance out" the control grid bias impressed upon these tubes. The R.F. stage bypass unit has usually been found at fault.

These receivers are often serviced because of an annoying hum that cannot be traced to the failure of any component part or faulty tubes. If the circuit diagram is studied, it will be noted that a single filter choke is employed in these receivers, which role is enacted by the speaker field. Shunting additional electrolytic condensers across the sections of the dual 6 mf. filter condenser sometimes reduces the hum condition to some extent. In the majority of instances, however, it has been found necessary to connect an additional external choke and condenser into the filter circuit between the speaker field and the 80 rectifier filament. This circuit change is easily made by removing the black speaker lead from its clip on the speaker terminal strip and connecting one side of the choke to this clip. The black lead is connected to the other end of the choke. If the hum has not been materially reduced by this operation, the filter condenser may be connected into the circuit from the clip on the speaker terminal strip to which one side of the additional choke has been connected, and to the chassis.

### Zenith 760, 765, 767, 475

In these models, as mentioned with the Zenith 715, 755 etc., poor control of volume or no control of volume and a certain amount of distortion has been traced to leaky or short-circuited secondary return bypass condensers. These condensers are in the A.V.C. circuit and if leakage or a short-circuit occurs the negative control grid bias impressed on the R.F. and I.F. tubes will be removed. Intermittent reception, fading motor-boating

and oscillation will also be occasioned by the open-circuiting of either of these units.

The complaint of hum may be eliminated in most instances by the addition of an 8 mf. electrolytic filter condenser connected after the first speaker field (both speaker fields used as chokes) to chassis, as shown in Figure 38. If this procedure proves ineffectual, then another

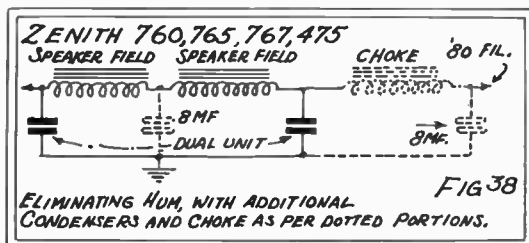

filter choke must be provided, as described with the models 715, 755 etc., between the 80 filament and the first speaker field. Further reduction in the hum level may be accomplished by connecting an 8 mf. filter condenser from the filament to chassis.

## The Most Complete Line of Quality



### Dial Bands, Belts, Cords and Cables

*(Exact Duplicates of the Originals)*

Featured by all leading mail-order houses and Jobbers throughout the United States and Canada.

We use only the Finest 42 Strand Phosphor-Bronze Cable and Linen Cord. This cable and cord is also available by the spool.

**Ask your local Jobber for**

**J. F. D. Products**

Write us immediately for our Free complete replacement guide and catalogue of Drum Drive Bands, Belts and Cords. Mention your local Jobber's name.

**J. F. D. DISTRIBUTING CO.**

**5024 Fort Hamilton Parkway**

**Brooklyn, N. Y.**

# VELVETONE

## TUBE-CHECKER

Have you ever been in the predicament after having checked up some tubes for a replacement job, of finding that they would not function properly under operating conditions

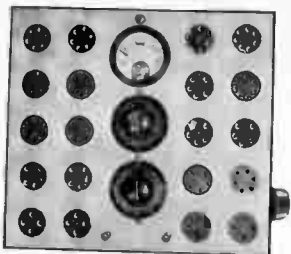

You will never have that experience if your tube-checker is a Velvetone.

Checks all tubes—from 1 to 30 volts—adjustable AC input—tests all new and old tubes for gas—ample supply of sockets eliminates danger of accidental burn-outs while testing—tests all dual type tubes—proper operating voltages for grid, plate, screen and cathode automatically applied. In addition the design of the Velvetone tube-checker is such that it can test any future type tubes. No adapters—no charts—no complicated adjustments—a direct-reading tube-checker.

Write for descriptive literature on all our products.

**JOBBERS**—Write for our attractive propositions and discounts.

**VELVETONE APPARATUS CO.**

1305 West Jefferson Street

Los Angeles, Calif.

# PURADYNE

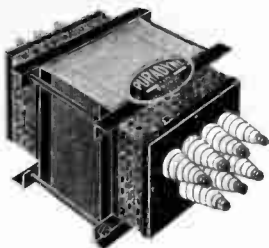

## POWER TRANSFORMERS

**TRANSMITTING** — Heavy duty power transformer, shielded perforated cases (for cool operation), heavily bolted to eliminate lamination hum, screw-lug terminals with porcelain stand-off insulators, black crackle finish for fine appearance. All types available.

Puradyne transmitting material has built into every unit over ten years of proven experience and knowledge. Stock sizes in the hands of our Jobbers and Dealers—or at the factory—assure prompt deliveries.

## PURADYNE CHOKES

All sizes, from small 50 mil jobs to ten amp. capacities and from 15 to 500 Henries. As illustrated (also unshielded).



## HIGH VOLTAGE CONDENSERS

Made to the most rigid of specifications—from 1000 volts up to 6000 volts D.C. working; Standard sizes carried in stock. Made in any capacities desired.

We can also supply at short notice **SPECIAL TRANSFORMERS** for **INDUSTRIAL WORK**, as—

- Standard Distribution Transformers, 2300 Volts, for Standard Insulating or Lighting Transformers for Conduit Wiring.
- Phase-Changing Transformers.
- Three-wire Auto Transformers for Lighting or General Service.
- Neon Sign Lighting Transformers.
- High Voltage Testing Transformers (up to 100,000 Volts).

For further particulars regarding our products send for full descriptive literature.

**PURADYNE ELECTRICAL PRODUCTS CO.**

38 EAST 21ST STREET

NEW YORK, N. Y.

# Allied All Purpose Amplifiers

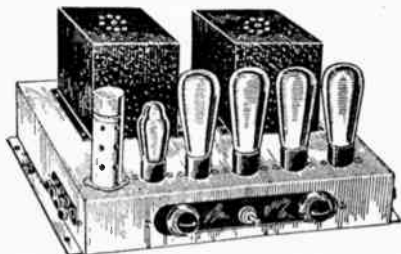

## New Field for Profit

A complete engineering and merchandising service to help you develop new sales.

Offering for the first time our complete line of amplifiers and accessories direct to the dealer and service man at wholesale prices.

The complete set-up from 3½ watt units to 125 watt amplifiers.

## Free Engineering Service

Specifications furnished upon request for special amplifiers to meet any requirements.

## Short Wave

We design and build to order and to specifications any type of short wave receivers or transmitters.

Exclusive representations are still available to dealers and jobbers. Write for full details.

Visit our laboratories for demonstration, or, write for descriptive literature.

## ALLIED RADIO LABORATORIES

Manufacturers for the Trade

25 WARREN ST.

Dept. 43

New York City



**THESE BOOKS SHOULD BE IN THE  
POSSESSION OF EVERY RADIO  
SERVICEMAN AND DEALER**

**RADIO PHYSICS COURSE**

by Alfred A. Ghirardi

Every page packed full of valuable descriptive and instructive information. Includes a modern study of electricity and sound. Covers everything from Magnetism through to Aircraft and Auto Radio and latest developments in Television. 992 pages, over 500 illustrations. Price, Postpaid ..... **\$4.00**

**RADIO SERVICING COURSE**

by Ghirardi and Freed

Up-to-date. Complete. A book that will enable you to make money by doing scientific radio servicing in a logical, rapid way. Complete directions for building test equipment. 192 pages profusely illustrated. Price, Postpaid ..... **\$1.75**

**SHORT WAVE RADIO HANDBOOK**

by Clifford E. Denton

Construction data on coil winding, R.F. circuits, band spreading, band pass, "supers", single-signal circuits, electron coupled oscillators. Complete constructional data given for building short wave receivers of all types. 128 pages, over 150 illustrations. Price, Postpaid ..... **\$1.00**

**RADIO CONSTRUCTION AND REPAIRING  
INCLUDING THE TELEVISION RECEIVER**

by James A. Moyer and John F. Wostrel

Fourth Edition: A real radio book of concise practical information, for the man who wants to know all about testing. Special attention is given to super-heterodyne and short wave receivers. New sections have been added in this edition on radio noise meters, midget AC-DC sets, short wave sets, all wave receivers, auto radio, and special testing sets for modern type tubes and receivers. 386 pages 5½"x8", 179 illustrations. Price Postpaid ..... **\$2.50**

**RADIO ENGINEERING**

by Frederick Emmons Terman

A new book covering all phases of radio communication. The book has been planned so that the first part is devoted to the theory of tuned circuits and fundamental properties of vacuum tubes and vacuum tube applications. The latter part is devoted to specialized radio topics, such as radio receivers and transmitters, wave propagation antennas, direction finding, etc. 688 pages 6"x9", 418 illustrations. Price Postpaid ..... **\$5.00**

**RADIO AMATEUR'S HANDBOOK**

Latest Edition. So many changes have taken place in 1933 that almost all the technical had to be re-written and re-illustrated to meet 1934 needs. Fills every need of the Radio Amateur and Short Wave Fan. Truly known as the "Hams Bible." 260 pages, 6½"x9½", 223 illustrations. Price Postpaid ..... **\$1.00**

**SERVICEMEN'S PUBLISHING CO.**

136 LIBERTY STREET

NEW YORK CITY

## RADIO FREQUENCY ELECTRICAL MEASUREMENTS

by Hugh A. Brown

A combined text book, manual and guide for making radio measurements. The fundamental principles involved in each method are explained, the necessary apparatus and steps in manipulation are described and discussions of precision obtainable, precautions and comparisons of methods are given. Covers all possible measurements and methods from Capacitance Measurement by Resonance to Piezo-electric Measurements. 386 pages 6"x9" fully illustrated.

Price Postpaid .....

**\$4.00**

## RADIO OPERATING QUESTIONS AND ANSWERS

by Arthur R. Nilson and J. L. Hornung

Prepare to pass radio operation license examinations this direct easy way. Here is a book that answers every conceivable question that is apt to be asked in Government examinations for any of the regulation radio operating licenses. Over 600 typical questions based on actual examinations, with full illustrated answers makes you confidently familiar with the essentials of all license tests both commercial and amateur. The fourth edition now covers broadcast, marine, aeronautical, police, and amateur radio-operating. 350 pages 3½"x8", 96 illustrations. Price Postpaid .....

**\$2.50**

## PHOTO ELECTRIC PHENOMENA

by Arthur L. Hughes and Lee A. Du Bridge

This book gives a critical survey of the whole field of photoelectric phenomena. The fundamental laws and principles in each branch of the field are fully summarized, together with a discussion of their experimental bases, their theoretical significance, and their practical applications. 531 pages, 6"x9" illustrated. Price Postpaid .....

**\$5.00**

## RADIO ENGINEERING HANDBOOK

Edited by Keith Henney

Prepared by a staff of 22 specialists—Just Published

A comprehensive, up-to-date, and authoritative handbook of engineering principles, standards and practice. Every section has been written by a specialist. The newest tubes and newest circuits are covered. Television, sound motion pictures, aircraft radio, short wave, photo-cells have been covered. All in all, the Radio Engineering Handbook in scope and treatment meets fully the need of radio for a comprehensive engineering reference manual. 583 pages 4½"x7", 482 illustrations

Price Postpaid .....

**\$5.00**

## THEORY OF THERMIONIC VACUUM TUBES

by E. Leon Chaffee

The book presents a comprehensive theoretical treatment of the fundamentals of thermionic emission and of the vacuum tube. In addition to the treatment of the general properties of the vacuum tube, its use as an amplifier and detector is treated in detail. The purpose of the book is to lay the foundation of the subject and to prepare the reader for pursuing any branch of vacuum-tube technique. 652 pages, 6"x9", 357 illustrations. Price Postpaid .....

**\$6.00**

SERVICEMEN'S PUBLISHING CO.

136 LIBERTY STREET

NEW YORK CITY