

A B C
of
TELEVISION
YATES

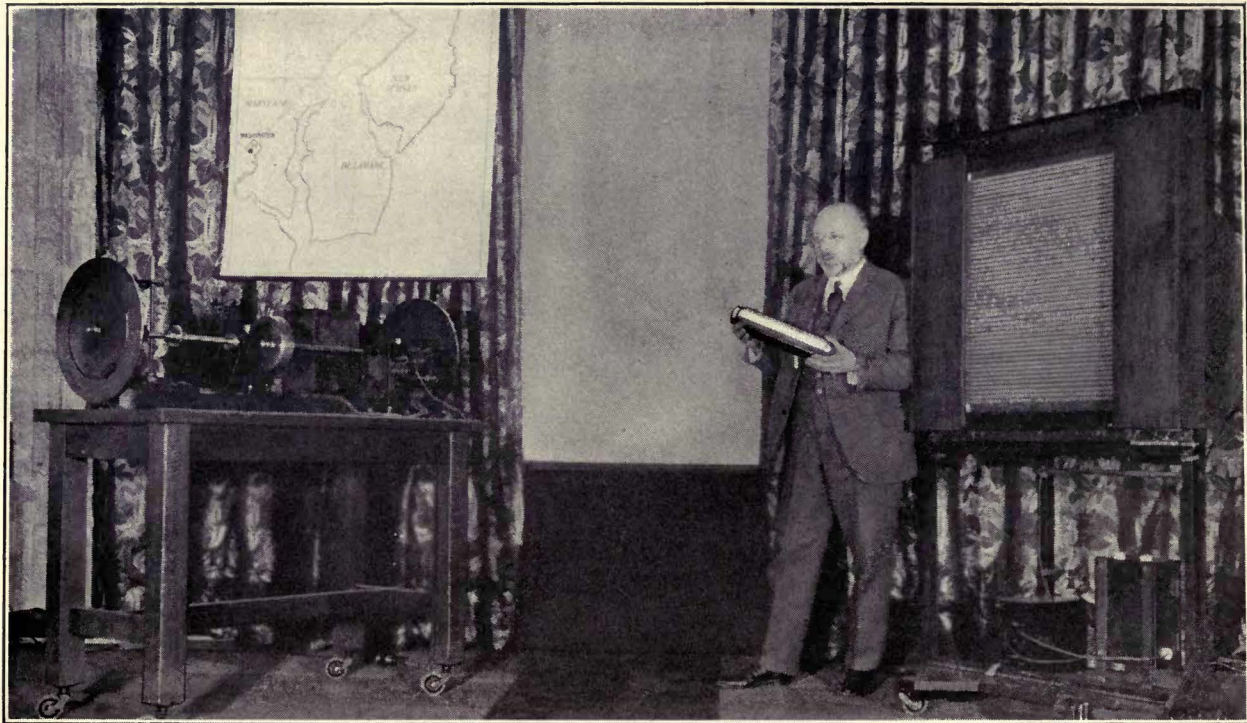

Dr. Herbert Ives of the Bell Telephone Laboratories beside the great neon lamp with its 2500 electrodes. The received picture appears upon this glass screen in the form of 2500 spots of light of varying intensity. Dr. Ives is holding one of the large photoelectric cells used at the transmitter. (Photo Courtesy Bell Telephone Laboratories, Inc.)

ABC OF TELEVISION

OR

SEEING BY RADIO

A COMPLETE AND COMPREHENSIVE TREATISE DEALING WITH THE THEORY, CONSTRUCTION AND OPERATION OF TELEPHOTOGRAPHIC AND TELEVISION TRANSMITTERS AND RECEIVERS

WRITTEN ESPECIALLY FOR HOME EXPERIMENTERS
RADIO FANS AND STUDENTS

Includes a brief history of television, a glimpse into its future, as well as its immediate possibilities. Explains in easily-understood language the theory of photo-electric cells, scanning discs, neon tubes, Kerr cells, selenium cells, and the underlying factors involved in the successful transmission of still and living scenes. Outlines the various television and telephotographic systems in use today and tells how to build and use simple home-made equipment

BY

RAYMOND FRANCIS YATES

Formerly Editor of *Popular Radio*, Member Institute of Radio Engineers and the American Physical Society



FULLY ILLUSTRATED WITH LINE DRAWINGS AND PHOTOGRAPHS

NEW YORK
THE NORMAN W. HENLEY PUBLISHING CO.
2 WEST 45TH STREET
1929

REEDSBURG, WIS.
PUBLIC LIBRARY

Copyright, 1929, by
THE NORMAN W. HENLEY PUBLISHING COMPANY

PRINTED IN THE UNITED STATES OF AMERICA

621
yal

PREFACE

Television, the new magic of communication, has whetted the interest of thousands of amateur experimenters, who, having mastered the less spectacular art of sound communication by radio, now feel the urge to push forward into new fields of scientific adventure. Television, quite contrary to what might be anticipated, requires only modest equipment and even those with a more or less superficial knowledge of electrical phenomena may set to work building their own television and phototelegraphic machines with every assurance of enjoying something more satisfying than mediocre success.

In the preparation of this little volume, the author sought to gather and present only data that would answer the questions and solve the problems of those practical-minded experimentalists who desire to assemble their own television and telephotographic machines for what pleasure they may derive by so doing. What is needed more than anything else at the present time is a handbook of useful information: applied television.

The author wishes particularly to mention the courtesy of the Bell Telephone Laboratories, Inc., for the use of many pictures and diagrams to say nothing of a liberal portion of text taken from the publications of this organization. The practical achievements in the art of television of the Bell Telephone Laboratories are the fruit of scholarly analysis of the many delicate problems involved in transmission and reception. Owing to the limited circulation of the technical journals issued by the Bell organization, it was thought advisable to make some of this extremely valuable data available to a larger number of experimentalists. 7969

RAYMOND FRANCIS YATES.

June, 1929.

7949

17 Oct. 29 P. 2 Ho Ritter

CONTENTS

CHAPTER I

TELEVISION—THE NEW CONQUEST OF SPACE

	PAGES
How the Principles of Television were Invented in 1884 and what the Future Holds for this Promising New Child of Science—A Description, in Narrative Form, of the Television of the Future.	1-15

CHAPTER II

TELEVISION SYSTEMS

Complete and Elementary Explanation of the Fundamental Principles of Television As They Are Applied Today in Both Transmitting and Receiving—Methods of Synchronization, Scanning and the Function of Photoelectric Cells.	16-36
--	-------

CHAPTER III

TELEGRAPHING PICTURES

An Outline of the Various Successful Methods Employed Today in the Transmission of Facsimiles and Photographs by Wire and Wireless Systems—Practical Description of Telephotographic Receivers for Home Use With Practical Instruction Concerning Their Operation	37-57
---	-------

CHAPTER IV

PHOTOELECTRIC CELLS—EYES OF TELEVISION

How Photoelectric Cells Serve as "Light Microphones" in Modulating Radio Waves With Light Impulses—Elementary Outline of the Theory of Photoelectric Phenomena	58-84
--	-------

CHAPTER V

AMPLIFYING PICTURES

Theory and Practice of the Amplification of Picture Signals Together With Data for the Construction of Television Amplifiers That Will Function With a Minimum of Picture Distortion	85-133
--	--------

CHAPTER VI

THE AGILE NEON LAMP

PAGES

- Theory, Operation and Practical Application of Neon Tubes in Television Reception—How the Neon Tube Functions as a “Light Loud Speaker” in Television Reception 134-141

CHAPTER VII

SELENIUM CELLS

- Theory of Selenium Cells Together With a Description of the Popular Types of Cells and Practical Data Concerning Their Construction by Home Experimenters 142-153

CHAPTER VIII

THE PROBLEM OF SCANNING

- The Function of the Scanning Disc With Complete Instructions for the Design and Construction of Different Types of Scanning Devices Including Drums and Moving Belts 154-174

CHAPTER IX

SYNCHRONIZING TELEVISION

- An A B C Outline of the Synchronizing Methods Now Employed by the Television Broadcasters of Today—Problems of Synchronizing Television Scanning Discs Treated in a Popular Way . . . 175-190

CHAPTER X

TRANSMITTING TELEVISION AT HOME

- How the Experimenter Can Construct and Operate Both a Television Transmitter and Receiver for Home Use—This Equipment Makes Possible the Transmission of the Outline of Simple Objects From One Room to Another 191-194

CHAPTER XI

HOW TO MAKE A TELEVISION RECEIVER

- Practical Application of the Principals of Television in the Construction of a Television Receiver Involving a Special, Highly Efficient Short-Wave Receiver 195-205
- Index 207-210

ILLUSTRATIONS

Dr. Herbert Ives of the Bell Telephone Laboratories beside the great neon lamp with its 2500 electrodes	<i>Frontispiece</i>
Photograph of a special resistance-coupled amplifier designed for the amplification of television signals	<i>Facing Page</i> 6
Part of the 2500 separate wires running from the contacting device to the 2500 tinfoil electrode on the large neon tube of the Bell Telephone Television System	<i>Facing Page</i> 22
Layout of the Cooley Rayfoto Apparatus	<i>Facing Page</i> 22
Complete high-speed distributor with its 2500 contacts and connecting wires leading to the tinfoil electrodes of the special neon tube	<i>Facing Page</i> 38
Transmitter of the Ranger System	<i>Facing Page</i> 38
Showing the construction of the Giant neon tubes employed in the television system of the Bell Telephone Laboratories	<i>Facing Page</i> 54
An observer sitting before a television receiver	<i>Facing Page</i> 54
Inside of the Alexander Television Receiver	<i>Facing Page</i> 86
Arrangement of a scanning apparatus used at the General Electric Company, Schenectady, N. Y.	<i>Facing Page</i> 86
Scanning apparatus of the television transmitter designed by the engineers of the Bell Telephone Laboratories	<i>Facing Page</i> 102
Baird Scanning Mechanism	<i>Facing Page</i> 102
Television transmitter developed by the Bell Telephone Laboratories	<i>Facing Page</i> 118

Electrical apparatus involved in the Belin-Holweck Television Transmitter	<i>Facing Page</i>	134
Printing drum of the Rayfoto Picture Receiver	<i>Facing Page</i>	134
Short wave tuner and oscillating detector unit arranged with demountable coils	<i>Facing Page</i>	150
An ordinary resistance-coupled amplifier that may be employed for the amplification of picture signals	<i>Facing Page</i>	150
Scanning disc set up for laboratory experimenting with television	<i>Facing Page</i>	166
Showing the arrangement of the instruments within a short wave tuner	<i>Facing Page</i>	166
How the Cooley Rayfoto Picture Receiver is connected to an ordinary radio set for the reception of "still" pictures, either photographs or drawings . . .	<i>Facing Page</i>	182
Diagram of connections showing how the short wave tuner, the resistance-coupled amplifier and the neon tube are connected for the reception of television signals	<i>Facing Page</i>	198

A. B. C. OF TELEVISION

A. B. C. OF TELEVISION

CHAPTER I

TELEVISION—THE NEW CONQUEST OF SPACE

How the Principles of Television were Invented in 1884 and what the Future Holds for this Promising New Child of Science—A Description, in Narrative Form, of the Television of the Future.

IN 1884, many years before Henry Ford succeeded in clogging our national highways with hemorrhages of tin and while the odiferous kerosene lamp still illumined the great American home, Paul Nipkow, a more or less obscure German experimenter, applied for a patent on what he very aptly called an "electric telescope." Nipkow was no idle dreamer, for his patent specification No. 30105, which is still available at the German patent office, did something more than merely anticipate an approximation of contemporary television equipment, he prescribed it with precision. Minus a few modern conveniences and scientific refinements that were quite unknown in Nipkow's day, the present television receiver and transmitter is built, bolt for bolt and gadjet for gadjet, as this sanguine, hard-headed Jules Verne would have built it during a time when cigar store Indians were still a curious innovation of American merchandizing. Any treatise on the subject written

without an acknowledgment of Nipkow's fundamental contributions would amount almost to a blasphemy for it was in his penetrating mind that the daring conception was born.

It is true that many of our greatest inventions are mere adjuncts to our senses; mechanisms that provide sensory projection or extension into realms beyond natural limitations. The telephone and radio permit us to hear over appalling distances. A man in New York conceivably may listen to the drone of a bee in Shanghai. Röntgen's X-Ray and the microscope permit a marvelously intimate examination of matter; we are able to equip our eyes with the Seven League Boots of vision, so to speak. Television is but another accessory for our most important sense, providing, as it does, a practical realization of that age-old yearning to see over distances that defy our optical powers. How long the race has yearned to see loved ones from afar, to steal even a transitory glance that would satisfy the heart and set the mind at ease! Indeed television is the realization of what must have been a primitive urge.

Although the fundamentals of seeing electrically were not wholly unknown to the writer at the time of seeing his first practical demonstration, there was a fascination to it that almost bordered on awe. Here was the laughing face of a man whose actual physical being was located in the obscure corner of a great factory several miles distant. Not a single movement eluded the keen, watchful eye of the mechanism before which he sat while the electrical equivalents of his likeness were flung into the great amphitheater of space. His voice, perfectly synchronized with the movement of his lips, added a touch of realism—and there was the smoke from his cigarette!

The picture, measuring about 4 by 5 inches, was in tones

of pinkish-red, a color which represented the spectrum of the gas neon contained in a special electrical lamp capable of extinguishing and relighting itself as many as 100,000 times per second. The picture was divided up into 48 thin strips, each strip being separated by a very thin line of black. Much like the movies of old, the reproduction at times stubbornly drifted from the field of vision only to be coaxed back into position by the operator. Judged by the high standards of present-day photography, this illusion was unmistakably crude but the fact that television had reached even such an immature state of perfection was in itself a significant happening. At least the man could be easily recognized and even such a slightly tangible thing as the smoke from his cigarette was sufficient to cause registration. Surely one could not help but be sanguine over the staggering possibilities of this new art.

Due to the highly imaginative and at times flagrantly speculative musings of the Sunday newspaper writers, television is at the moment, however, too enthusiastically appraised by the lay public. Already the public is talking of the imminence of home television perfected to a degree where it will be possible to enjoy a football game or a presidential inauguration from the vantage point of a luxurious living-room chair. While the patriarchs of engineering admit the possibilities, they seriously question the imminence unless some unforeseen development completely revolutionizes present practice. It must be conceded that appalling technical difficulties at present stand between football games and living-room walls. In the same breath it must be maintained that, even with the modest development that has taken place, television is practically ready for domestic application. Although the scope of the scenes scanned cannot include anything more pretentious or sizeably than intimate

likenesses of broadcasting performers, the lure, the novelty and captivating fascination of the feat brings it within the possibilities of immediate commercial exploitation. Television is in its earphone stage of development. Perhaps before this volume reaches the hands of the public, a large number of homes in the Republic will be equipped with the new marvel of the age.

The least that may be said is that television is ready to court the attention of that vast army of radio experimenters who so enthusiastically mastered the mystery of communication without wires. To the legions of amateur pioneers, television falls as a rightful heritage; it needs their patient hands and ingenious minds. Broadcasting received its original impetus from the inquisitive dabblers of 1920, who through their activity in the fabrication of home-made receivers, brought the manufacturers rushing to the public with merchandise to satisfy a theretofore undreamed-of demand.

Contrary to what appears to be the public notion, television is neither involved nor complicated. Some are inclined to measure the intricacy of a machine by the marvel of its product. This analysis does not always hold. It certainly does not hold in television. Living pictures, signals or impulses are available to an ordinary radio receiver, the only accessory apparatus at present needed taking the form of a metal disc, a washing machine electric motor and a neon lamp which may be purchased from a dozen different radio manufacturers. The only remaining requisite is the zeal and love for adventures in science-land possessed by millions of scientifically and mechanically inclined Americans.

Television gives man still another advantage in his fight to annihilate space and mitigate the importance of time as a factor in the life of the world. Phototelegraphy, the art of sending "still" pictures by wire and wireless has already facili-

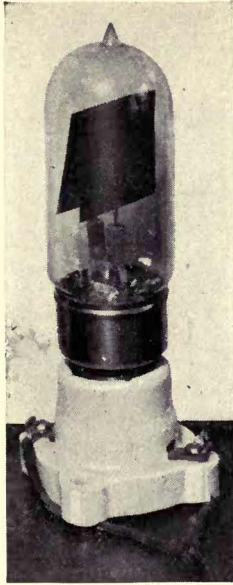

A special neon lamp with electrodes measuring $1\frac{1}{2} \times 1\frac{1}{2}$. Such lamps are connected in the output circuits of television receivers.

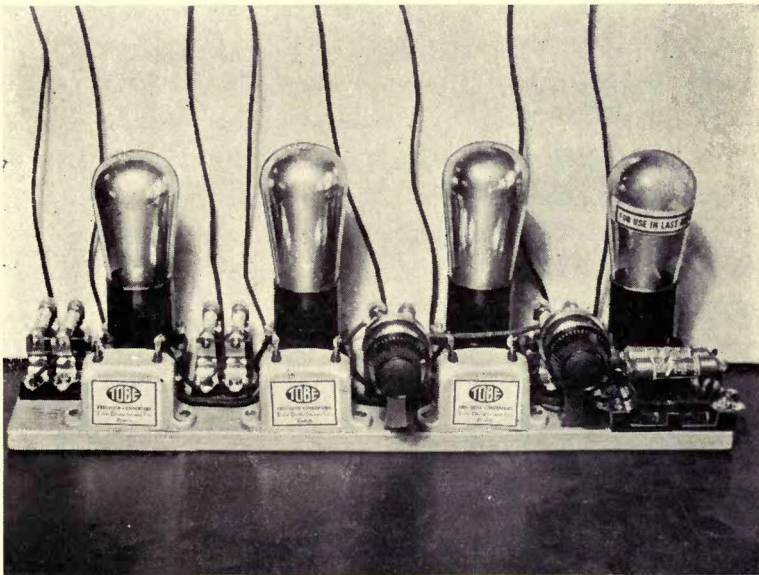

A photograph of a special resistance-coupled amplifier designed for the amplification of television signals.

tated the intercourse of many corporations and individuals. The facsimile of a legal document filed in a telegraph office in London, is wafted across the Atlantic in a matter of minutes and delivered to its destination before three hours have elapsed. There is a ten million dollar bond issue to float. The public announcement from San Francisco must be released on a given day simultaneously in New York, San Francisco, Chicago and Boston. Copy is late, due to last minute changes and revisions. Facing this emergency, the agent representing the Corporation borrowing the money, turned to the phototelegraph. The announcement was published in the four corners of the United States as per schedule. This speed, by comparison, makes a snail out of the fastest airplane.

The Standard Oil Company of California now sends its annual statement to the press of the country by the phototelegraph. Rogues gallery photographs and fingerprints are exchanged between the police departments of all our large cities. Banks send signature cards and signature verifications. A doctor in Cleveland sends an X-Ray photograph to a specialist in New York for diagnosis and saves a man's life. Such are the services rendered by the picture transmitter.

Every invention changes to some extent the habits of life. Some even effect profound economic readjustments. How television will effect our mode of living or the intercourse of the world only time will tell. Today, the order of things calls for centralization. New York is a Colossus born of the need for the centralization of finance. Centralization is in itself a potent weapon against time. It cuts down the need for transportation. Today working Manhattan gets on the subway at 5 p.m. and rides to upper Manhattan. Tomorrow it may fly to Adirondack villages in aerial argosies or on a five-hundred-mile-an-hour mono-rail. There are two things that

tend to defeat the need for this centralization; one is high speed transportation at low cost and the other is the now-infant television. Most of our business, to say nothing of our social intercourse, is done by sight and speech. The extension of both of these senses over vast distances should obviate the need for transportation of human beings at least. We may, without much stretch of the imagination, look forward to a time when a board of directors may meet electrically, see and talk with each other and discuss quite privately the affairs of their enterprise. As a matter of fact, that is something that could be accomplished today in a limited way, so we are not taking flight to imaginative regions when we list it with the possibilities. Much of our business intercourse that today requires the physical presence of the parties concerned might well be done by television. We might extend our speculation to include a meeting of the League of Nations or a session of the United States Senate.

Soon the phantom images of television will be as large, as real and as perfectly delineated as those that amuse us with their tragic and humorous antics on the motion picture screen. Indeed those who read this book may live to see them in color and with a third dimensional effect. These scanty, jumpy and ragged forms of the present art will doubtless grow to live in an illusion so highly perfected that we can only dimly appreciate its realism at the present time. It is wholly conceivable that we shall be able to feel by radio—touch transmitting. If we can produce an illusion that satisfies one sense, there is really no reason why we cannot trick the remaining senses.

Just as we now employ a scanning device at a television transmitter so might we devise some sort of an exploring "feeler" that would, for instance, electrically register or impress equivalent impulses upon an electromagnetic wave. At

the receiver we simply need a membrane sensitive and pliable enough to be "modulated" with the received impulses of varying intensity. This may be a highly imaginative speculation, but after all imagination is the very essence of creative effort and invention.

The educational potentialities of television are so obvious that little need be said concerning this phase of the subject. The old Chinese adage "A picture is worth ten thousand words" is still a gem of wisdom. This one expression alone probably foretells as much about the educational future of television as can be written in pages.

Some years back, when the writer was preparing a daily critique on broadcasting for the New York *Herald-Tribune*, he published a short skit which outlined, as part of the narrative, the television receiver of the future:

"The luxurious living room in the apartment of Adam Gleek was quite dark save for the kindly, comforting glow that the fire in the broad hearth shed on the surroundings.

"Adam, a nervous, gray-whiskered little old fellow, still dressed in the style of 1930, slapped on the knee his crony H. Budington Lyman, M.D. 'Bud,' he said, 'You came in just in time to see a good evening's entertainment. I had the Television Times on the wall directly after dinner. The radio program tonight will include a trip to Yosemite Valley by the camera reporter of the Station BAI4. BAI4, you know, Bud, is the station that reported the last Kentucky Derby so beautifully. Doesn't sound bad, eh?'

"H. Budington Lyman, M.D., although gray-haired and slightly wrinkled, had managed to preserve some of the athletic poise of earlier days. He was large in frame and had a deep, gruff voice that matched perfectly his physical greatness. He remained thoughtfully silent for several moments.

"Adam looked at him, questioningly. 'The program, Bud; do you think you will like it?'

"H. Budington Lyman stirred himself. 'Yes, Adam,' he said, 'I believe that we shall both enjoy the program, but I was just thinking of some of my earlier experiences with the radio when I was an enthusiastic youth. You remember the old days, Adam, when we could receive nothing but wheezy voices and music thick with the mold of distortion. That was the time when I was practicing on Fifth Street and you lived around the corner. I shall never forget that three-circuit tuning device that I had set up in the back of the office. Let me see, you had some kind of a dingbat—what was it? Oh, yes! an Armstrong set. You thought it was about the finest thing ever and we were constantly getting into arguments as to who could pull in the most distance. Remember, Adam?'

"Adam Gleek gave a nervous little cough, slipped down further into the softness of the divan and gazed ceilingward. 'Gad, Bud,' he said, tapping his nose with his spectacles, 'I should say I do remember those days, but you were wrong about the set I had. It was a neutrodyne if I remember correctly, and what a lot of sleepless nights that old thing brought to me and the whole family. But if you did not go to the office in the morning with a long list of stations that you had copied the night before, you got the "razzberries," to use an expression of those days. What a sorry mess the radio sets were then? Remember the danged B batteries, the storage batteries and all the other contraptions that one had to use?'

"'What provoked me most of all,' H. Budington growled, savagely biting the end of a new cigar, 'was the interference that stations caused. My old three-circuit tuner used to be pretty selective, but even at that I had a great deal of trouble compared to the service that we get today. I lost a good

patient at that time too; a fellow who used to be a radio-frequency fiend. I had treated him ever since the time I started to practice, but we got into a heated debate one day over the relative merits of radio-frequency and the three-circuit tuner set, and do you know, he got so boiled up about it that he paid his bill before he left and I haven't seen hide nor hair of him since,' Lyman chuckled.

"Adam spoke. 'I think the most disagreeable features of the old-fashioned radio,' he said, continuing to tap his nose with his silver-rimmed spectacles, 'was the terribly annoying screeches and howls that one would innocently pick up from the neighbors who had radios. If my memory serves me correctly, it was not until the year 1928 that this nuisance disappeared. I remember too—'

"The mellow sounding gong of the radio-controlled clock on the mantel struck eight. Mr. Gleek arose and walked briskly to the television receiver on the opposite side of the room. 'Gracious,' he said pressing the button that controlled the filamentless vacuum tubes, 'I had had no idea of the time, BA14 begins at 8:05.' He set the tuning control to a point which bore the mark of the station that was to be received from and returned to the divan.

"There suddenly appeared on the wall at the side of the mantle a square of soft green light. It was an odd green that contrasted strangely with the red tinge of the fire already present.

" 'Ah ha,' said Mr. Gleek, 'they are transmitting in green tonight. It fits the subject beautifully. Leave it to BA14 for good judgment in choice colors. I shall never forgive WZ27 for transmitting the funeral of President Fisher in orange.

" 'Television BA14,' said a soft voice coming from the

direction of the radio on the opposite side of the room. It was deceivingly human in tone and quality. 'Connections have just been established with our camera reporter in Yosemite Valley and we are now ready to present to our audience beautiful views of what are probably some of nature's grandest spectacles. Our reporter has succeeded in setting up sixteen cameras and consequently we shall see sixteen of what are considered the best scenes of the locality.'

"Before the last word of the announcer had melted into the stillness of the room, there appeared on the wall the picture of a beautiful waterfall. It was the Bridal Veil in all of its splendor. Simultaneously with the picture the room was filled with the sound of water dashing against rock.

"The sound of the waterfall suddenly grew dim and the same clear voice returned. It was of such volume that it could just be heard above the sound of the falling water.

"'You have before you,' it said, 'a picture of the Bridal Veil Falls, Yosemite Valley.' The sound of the gushing water and the voice of the announcer melted away and the charming strains of the Bridal March from Lohengrin filled the room.

"The voice returned. 'Our next scene,' it said, 'will be presented from another camera located in one of the smaller streams of the Valley. Although this scene is not so well known it is one of the picture gems of America.'

"The picture of the Bridal Veil passed away and there appeared in its stead the picture of a bounding brook dashing down a mountain side amidst pines and huge, moss-covered outcroppings of rock. Its rapidly moving waters chattered gayly in the background of Mendelssohn's Spring Song.

"For a solid hour Dr. Lyman and his friend Adam Gleek sat and feasted their eyes upon the stupendous scenery of the Yosemite. When it was over Adam jumped to his feet and

in his usual quick way walked over to the television receiver. 'And now,' he said, 'let us see what the Century Gardens have to offer. What do you say, Old Top?' This, looking at his crony.

" 'I refuse to be disappointed,' chuckled H. Budington Lyman.

"Mr. Gleek carefully turned the tuner knob to LV29, the television transmitter of the Radio Amusement Corporation of America. The shrieks of the jazz orchestra poured into the room and simultaneously there appeared on the wall a black-faced comedian who was the son of the old-time Eddie Cantor. A dozen pretty young ladies with veil-like gowns danced into the background.

"Adam adjusted his spectacles to his nose. 'Not bad,' he said.

" 'Like the morning sunshine,' came back H. Budington.

"After the picture of the dancing girls had disappeared, the screen was occupied by a gentleman in evening dress, evidently the manager.

" 'Ladies and gentlemen of the television audience,' he began, 'I have a very important announcement to make to you this evening. I regret to say that it is an announcement that will cause you no pleasure. One of your favorite entertainers is terminating her contract with this company tomorrow for an age-old reason. She is going to be married.'

"Before the gentleman had finished speaking a captivating brunette appeared. She was a subject for the poets, with roguish eyes and divine figure. She smiled demurely. Adam leaned forward quickly at the sight of her, adjusting his spectacles as he did so. H. Budington followed. There was a moment of silence.

" 'Irene,' moaned Adam as though speaking to himself.

"H. Budington Lyman turned quickly and shot a questioning glance at his friend. There was a moment of silence.

" 'Did she hook you, too, Adam?' growled H. Budington settling back into his seat. 'Well, I was going to marry her in June myself so I guess we are both old fools.'

So much for the future of television.

Today the devices and instruments of science are so multitudinous and far-reaching in their scope of application, that dreams rapidly harden into realities and the imaginative vaporings of yesterday are the actualities of the moment. Material equipment is at last bidding fair to match the needs of our mental equipment. Ideas, no matter how startling they may be, do not wither and die in the minds of their creators for the want of practical components and accessories.

Five years ago science completed its task of supplying the necessary wherewithal for television. The co-ordinating genius of a score of independent experimenters triumphed in bringing the accessories to function as a composite whole and today television is an accomplished fact. "Electric eyes" that catch the fleeting impressions of a moving image with a speed and accuracy that matches the human optical organs is but one of the wonders that had to be perfected before seeing over a distance came within the realm of the possible. Perhaps even a more prodigious task was that of developing an electric light that would be completely extinguished and relighted to full brilliancy no less than 100,000 times a second. Radio, too, made its contributions to the success of the new marvel, for whether we see over the air or by wire, that useful tool of science, the vacuum tube must be used.

The dispatching of a picture by wire or the ether is divided into three distinct departments and before delving further into the intricacies of the art, we shall do well to establish our

nomenclature. Telephotography has to do only with the transmission of photographic facsimiles. Photographic prints are translated into equivalent electric impulses at the transmitter and the effects of these are automatically co-ordinated and recorded at the receiver in such a way as to recreate the varying tones of the prototype which may be thousands of miles distant. Television, on the other hand, is the art of seeing living scenes. Technical immaturity at present limits these scenes to a rather narrow scope but, even with the present encumbrances, we may witness a performer strumming a guitar. We might even count the freckles on his nose or number the rings in the smoke from his cigarette.

In telemovies or telecinematography, reproductions from standard moving picture film flowing through a standard projector are used to modulate the wave or current at the rate of sixteen pictures per second.

Considering the appalling technical difficulties that confronted the pioneers of television, the progress of the last five years has been sufficient to gratify the hopeful observers. From an unruly splash of light that bore not the slightest resemblance to the object at the transmitter, we are now able to view scenes sharply focused and steady.

CHAPTER II

TELEVISION SYSTEMS

Complete and Elementary Explanation of the Fundamental Principals of Television As They Are Applied Today in Both Transmitting and Receiving—Methods of Synchronization, Scanning and the Function of Photo-Electric Cells.

To say that a television image is an illusion may seem somewhat paradoxical. However, it is just that. Nothing more, nothing less. It is obvious that we cannot transmit physical realities or even pictures of physical realities. What we can do, however, is to transmit impulses of varying amplitudes and so arrange these impulses at the receiver that they will appear as likenesses of the object or objects at the transmitter. This is exactly what television does, the weaknesses of the human eye being the key to the solution of the problem. If the human eye was instantaneous in its response to light impulses, television would today be nothing but the misty dream of attic inventors.

What happens when sound strikes the diaphragm of the microphone at the broadcasting station? That is a question that must be fully answered before we can hope to fathom the mysteries of "seeing by radio." When sound strikes the diaphragm, several interesting things happen. First and foremost, the diaphragm of the microphone responds to the impinging vibrations by itself vibrating. If it is a good diaphragm, it will faithfully keep in step with the vibrations that

strike it. The diaphragm then communicates these vibrations to a small container filled with highly polished carbon granules through which an electrical current is permitted to pass. When no sound is striking the diaphragm of the microphone, these little carbon granules are all at rest, and the current proceeds through them, smoothly and uniformly. When the diaphragm is thrown into vibration, this vibration is communicated to the carbon granules and they rub against each other, this rubbing and jostling causing a variation in the electrical current passing through the microphone. In other words, the resistance that the carbon granules offer to the passage of current is varied in exact accordance with the sound being impressed upon the microphone. This is called modulating. The microphone *modulates* the currents passing through it. These currents, in turn, are picked up, amplified with vacuum tubes, and then again modulate the radio wave passing out from the broadcasting station.

In the broadcasting of television, we must have a microphone that will be modulated with the less tangible medium of light. Inasmuch as light exerts no measurable pressure upon striking an object, it is plain that an ordinary microphone cannot be used to impress the light impulses upon the broadcast wave. There is, however, a "microphone" that will perform this function. It is the photoelectric cell. We might look upon the photoelectric cell as a "light microphone," one in which the degree of current passing through will be varied in accordance with the intensity of the light striking it. The photoelectric cell does not depend for its action upon carbon granules, for, compared to the minute pressure exerted by light in falling upon an object, the granules contained in a sound microphone would be the equivalent of thousands and thousands of tons of carbon.

Hallwack observed, way back in 1888, that when certain metals are exposed to light, they shoot off electrons; actual particles of electrical current. Later experimenters found that this effect could be greatly inconvenienced by enclosing these light-sensitive metals in a glass tube devoid of air. By inserting two electric terminals in this cell and bringing the wires to the outside, the electrical effects could be observed more readily. When photoelectric cells are exposed to light, they actually generate a minute current; a current, however, that is so small that it must be measured in millionths of an ampere. Furthermore, the degree of this current is regulated in exact proportion to the intensity of the light striking the cell. If the cell is in the dark, no current will pass. If it is placed in close proximity to a powerful arc light, the current will reach maximum amplitude, providing all other conditions are suitable.

Assuming that we could impress light waves or rather the effects of light waves upon a broadcast wave, through the medium of the photoelectric cell, how would these radio waves be received on an ordinary receiving set? If the photoelectric microphone was intermittently exposed to light, we might hear the effect of this in an ordinary loudspeaker. If the light at the broadcasting station was interrupted, say, sixty times a second, there would be produced in the loudspeaker a humming sound which would have a frequency of sixty. Thus we see that every picture might have its equivalent in sound and that a picture is actually received as a series of sound impulses. However, we cannot *see* sound waves.

Our next problem, then, is that of finding a loudspeaker that will convert these picture impulses into light waves of various intensity. A neon lamp will perform this function. When the gas, neon, is enclosed in a glass container and subjected to an electrical current of sufficient intensity, the gas will glow,

giving forth a pinkish light. The degree of brilliancy will depend entirely upon the amount of current passing through the lamp. The uninformed reader might well ask: "Why cannot an ordinary lamp be used for this purpose?" Ordinary electric lamps give forth light due to a current passing through and heating a metallic filament. This filament reaches a point of incandescence and a measurable period of time elapses between the instant the current is turned on and the time the lamp reaches full brilliancy. The neon lamp is far more agile in its performance. It has no filament, its illumination being caused entirely by the movement of gas atoms. Consequently, such a lamp may be turned on and off as many as 100,000 times a second; so fast, indeed, that the human eye is led to believe that there has been no interruptions. Yet the lamp will go from total darkness to full brilliancy this prodigious number of times every second.

Now that we have provided ourselves with the "light microphone" and the "light loudspeaker," we are equipped with the necessary components for television, and we shall proceed to learn how these two instruments may be applied so that living objects in a broadcasting studio may be "seen" through the medium of an ordinary radio receiver located at a distant point. Our understanding of this new magic of broadcasting will be greatly assisted by constant reference to Figure 1. Here we have laid out before us the vital parts of a television transmitting and receiving equipment. On the transmitting side, which happens to be to the left of the page, we see a human face poised before a "light microphone." To increase the sensitivity and the scope of the transmitter, three photoelectric cells are used. These are indicated at P. Directly to the rear of the photoelectric cells there is what is known as a

scanning disc, and back of the scanning disc there is arranged a powerful source of light.

It will be evident that the object could not be illuminated in its entirety but must be explored progressively with a powerful beam of light. If the arc lamp back of the photoelectric cells were permitted to illuminate the object in its entirety and at one instant, the photoelectric cells would simply receive a jumble of impressions. The object must be scanned; that is, it must be explored in a progressive fashion with light, and it is the object of the scanning disc to control this light source so that a fine, but powerful, beam will start in at the top of the object and sweep across it, first at one level, then at a slightly lower level and so on until every portion of the object has been illuminated. The scanning disc performs this function through the agency of holes, spirally arranged. The first hole in the spiral sweeps across the top of the man's head and, when it gets out of the field of illumination, the second sweeps another beam of light across the object at a slightly lower level, due to this hole being arranged at a different point in the spiral. This process is continued until the whole object has been carefully explored, a process that is brought about at every complete revolution made by the scanning disc.

When the object or person to be broadcast intercepts these dancing beams of light, the beams are reflected from the object to the photoelectric cells, or light microphones. Let us assume, for a moment, that the scanning disc is motionless and that a beam of light has rested on the hair of the performer. Let us assume further that the hair is black. It is well known that black objects do not reflect much light, hence the photoelectric cells will not pass a great deal of current under these conditions, inasmuch as they will not receive a great deal of light. However, if the scanning disc was moved forward to a point where

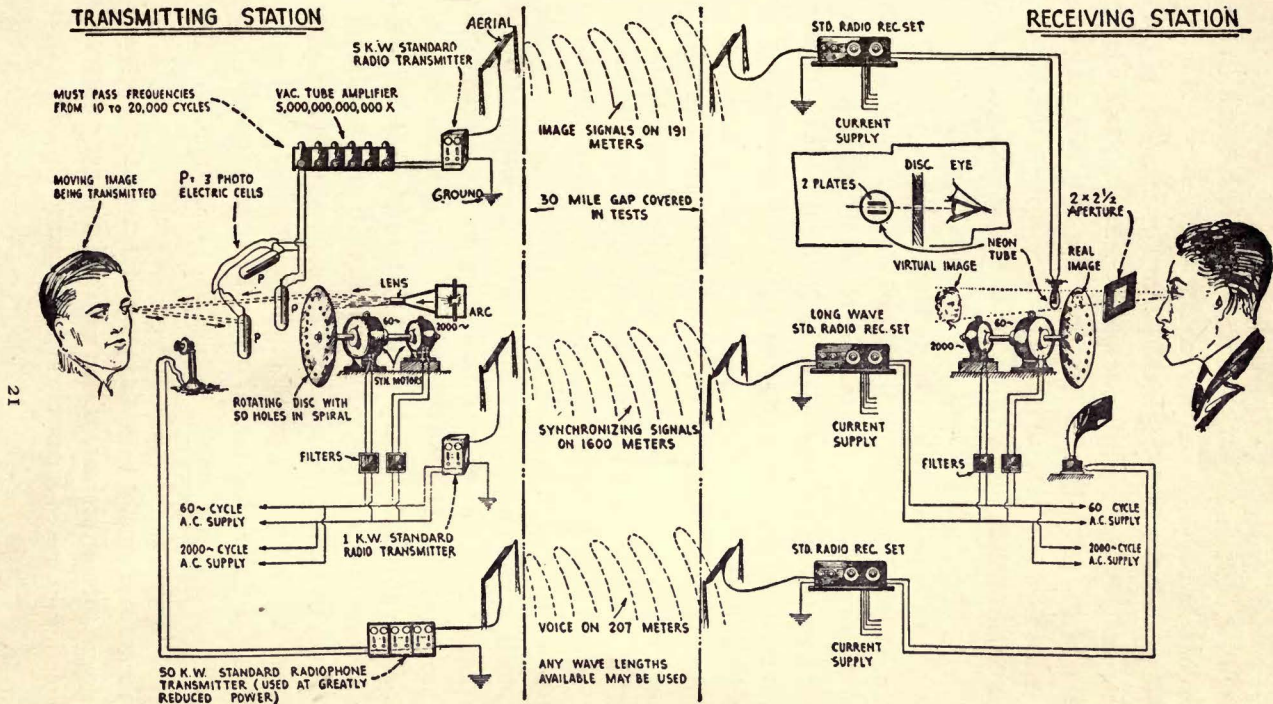

FIG. 1.—Simplified diagram of a complete television and telephonic broadcasting system. Three different wave-lengths are employed, one for the transmission of the picture of the living image, one for the voice or music, and one for the synchronism of the television scanning discs. (Courtesy Experimenter Publishing Company.)

the beam of light rested on the man's forehead, considerable light would be reflected and a proportionately larger amount of current would pass through the photoelectric cells. If one of the exploring beams struck a spot that had a shade somewhere between the brightest spot on the man's face and the darkest spot of his hair, the current produced in the photoelectric cell would be in exact proportion to the difference.

Before proceeding with our description, let us make sure that we have a clear understanding of the way in which the scanning disc performs. It is the object of this device to search out every portion of the object's face, and to bathe it in streams of light that run progressively from top to bottom, drinking in every detail as they go.

In the diagram referred to, which illustrates a television system developed by the Bell Telephone Laboratories, there are really three independent radio transmitters. The photoelectric cells, or light microphones, are connected to one transmitter through a series of powerful vacuum tube amplifiers whose function it is to amplify the minute currents generated in the photoelectric cells as a result of the fleeting impressions to which they are exposed. The second radio transmitter, working on a still different wavelength, is used to send out what is known as the synchronizing signal. This synchronizing signal is used to keep the transmitting and receiving apparatus operating at harmonious speed. Still another transmitter is used to carry the sound of the performer, who may be singing or playing a violin.

We are now ready to pack up our mental belongings and move over to the receiver, where we shall attempt to see how these picture-impulses are received and presented in such a fash-



Here is a part of the 2500 separate wires running from the contacting device to the 2500 tinfoil electrodes on the large neon tube of the Bell Telephone television system. The revolving contactor connects each one of the electrodes once during each revolution. Naturally, this revolving arm runs in synchronism with the scanning device at the transmitter. (Photo Courtesy Bell Telephone Laboratories, Inc.)

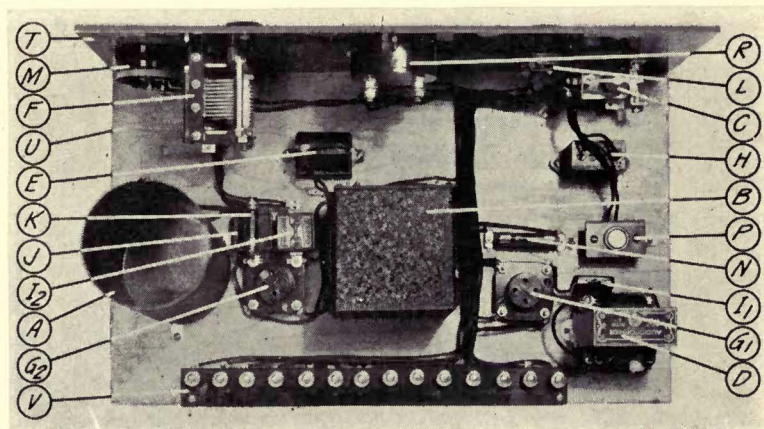

The layout of the Cooley Rayfoto apparatus. T is the panel, M a rheostat, F a variable condenser, U the baseboard, E a choke, K a grid leak, J the grid condenser, I₂ a fixed mica condenser, A the cornoa coil, G₂ the oscillator tube socket, V the binding post strip, R 0-25 milliammeter, L a rheostat, C a relay, H a fixed mica condenser, B a special modulator transformer, P a push button, N an automatic filament rheostat, I₁ a fixed mica condenser, G₁ a vacuum tube socket, and D an audio transformer.

ion as to cause the picture illusion. Due to the synchronizing wave, the scanning disc at the transmitter is caused to keep perfect step with the disc at the receiver. When hole No. 1, at the transmitter, is in a certain position, hole No. 1 at the receiving disc will be in a corresponding position. The picture signals which, in this case, were transmitted at 191 meters, are picked up on a standard radio tuner, amplified, and carried to the neon lamp which is connected to the receiver in place of an ordinary loudspeaker. This neon lamp is mounted directly back of the scanning disc at the receiver. In front of this scanning disc there is arranged a small aperture, which in this case happens to be 2 by $2\frac{1}{2}$ inches, and it is through this aperture that the observer at the receiver "sees" the picture—or imagines that he sees a picture. When the beam at the transmitter strikes a black portion of the object, very little current will flow into the photoelectric cells and very little current will be received and amplified by the receiver. Consequently, very little current will flow through the neon lamp and, as a result, its glow will be reduced in exact proportion. Indeed, if the spot on the object at the transmitter is absolutely black, the neon lamp at the receiver may give forth no light at all. If, on the other hand, the scanning beam of the transmitter struck a scintillating diamond tie pin, the little neon lamp at the receiver would instantly flash to full brilliancy.

From the insert in our drawing, it will be noticed that the observer, in looking through the aperture at the receiver, is so arranged that his line of vision will strike a plate which is arranged in the interior of the neon lamp. It is on this metal plate that the actual light changes take place.

At this point it is important that we should understand the meaning of visual persistency. When a flash of lightning reels down the sky, our eyes insist upon seeing it for a period much

longer than the flash actually lasts. As a matter of fact, the eye insists upon seeing it at least $1/16$ th of a second after it has actually disappeared. This is called visual persistency, and it is upon this shortcoming of human sight that the illusion of motion pictures is based. As a motion picture film streams through the projector, the eye insists upon retaining each impression until the succeeding picture is brought into place, the first dissolving into the second. In each case the eye is caught unawares and while each illusion persists until another picture is brought into place, for a moment we are blind to the second one while the first one remains. Motion pictures are projected at the rate of sixteen per second, which is the speed found necessary for the most perfect illusion.

If motion pictures are projected at the rate of sixteen per second, it is obvious that the scanning disc at the broadcasting station must make sixteen revolutions if the illusion of motion is to be preserved. That means that sixteen times a second the object at the transmitter has been completely illuminated and that sixteen separate pictures are recreated at the receiver. But how are these pictures recreated? How can these light flashes of a neon lamp be assembled into a human likeness?

From what has preceded, we know that when the observer at the receiver sees such a flash, that each flash persists, and that during the course of one revolution of the scanning wheel at the receiver, the observer sees, in one instant, the equivalent of all the light variations that are picked up by the photo-electric cells at the transmitter. We also know that these light flashes are in exact step with the scanning bam at the distant broadcaster. In this way, the eyes of the observer at the receiver drinks in all the impressions at practically the same instant—they all come together, properly arranged and positioned, so that the image of the distant face appears as an

illusion at the point indicated in the diagram. If the scanning disc was traveling too slowly, and one picture was permitted to melt out in the vision before the next one came into place, we would have the same effect that is produced on a motion picture screen when the projector slows down. The picture would become "jumpy" and the moving object would skip from one point to another at high speed.

Inasmuch as sound-laden and light-laden radio waves travel at exactly the same speed, words uttered by the performer at the transmitter will arrive at the receiver perfectly synchronized with any lip movement that may be made. When we refer to light-laden waves, we do so advisedly, for these light impulses are really converted to sound impulses in the transmission, and any ordinary loudspeaker could be used to "hear" the picture signal.

Although three independent transmitters, one for light, one for synchronization, and one for sound are shown in the diagram that we have just been discussing, it is possible to have television using only one transmitter; a transmitter for light. The synchronization could be brought about by manually-operated controls, and *in the future it will be possible to impress both sound and light upon a single broadcast wave. What we shall probably need in the future is a duplex receiver, incorporated in one box, and responsive to both light and sound impulses.*

In an attempt to enlarge television reproductions to a point where they could be viewed by a large audience, the engineers of the Bell Telephone Laboratories have evolved a most ingenious mechanism for use at the receiver. In this device there is employed a large neon tube having attached to it 2500 independent electrodes. These electrodes take the form of small pieces of tinfoil attached to the outside of the tube, the

discharge being due to capacity effects. Inside this tube there is placed one electrode taking the form of wire, arranged spirally. The tube itself is arranged in the manner shown in the drawing on page 27.

Each tin foil segment in this gigantic neon tube has attached to it a wire. This wire runs to a contact on the commutator device, the arm of the commutator running in synchronization with the scanning disc at the distant transmitter. In all, 2500 wires are attached to the commutator. When the contact arm of the commutator device makes a connection with any individual wire, there will appear in the corresponding section of the neon tube a glow, the intensity of this glow being regulated by the particular portion of the object being scanned at the transmitter. This commutator device revolves with a speed sufficient to create the picture illusion as it sweeps over the 2500 contacts during the course of a single revolution. While the grain of the picture so reproduced is not especially fine, being made up of only 2500 units, marvelous results have been obtained and faces have been reproduced that are easily recognizable. Eighteen times each second the commutator arm energizes 50 segments across each row of the neon tube electrodes. Inasmuch as there are 2500 segments energized eighteen times each second, it is obvious that this device produces 45,000 light images each second. Naturally, this equipment does not lend itself for home experimentation, owing to the great expense involved in its construction. (See Fig. 2.)

Prof. Max Diekmann, a German experimenter residing in Munich, has developed a most ingenious method of producing the picture illusion at the receiver. Prof. Diekmann's transmitter apparatus, while novel in many respects, is more or less conventional in its pattern and consequently we shall not go into the details of this particular portion of his equipment.

In place of using a neon tube at the receiver, this experimenter employs a specially constructed cathode ray tube. It will be recalled that a cathode ray is a pure electronic discharge taking place in a highly evacuated tube. We shall gain a better under-

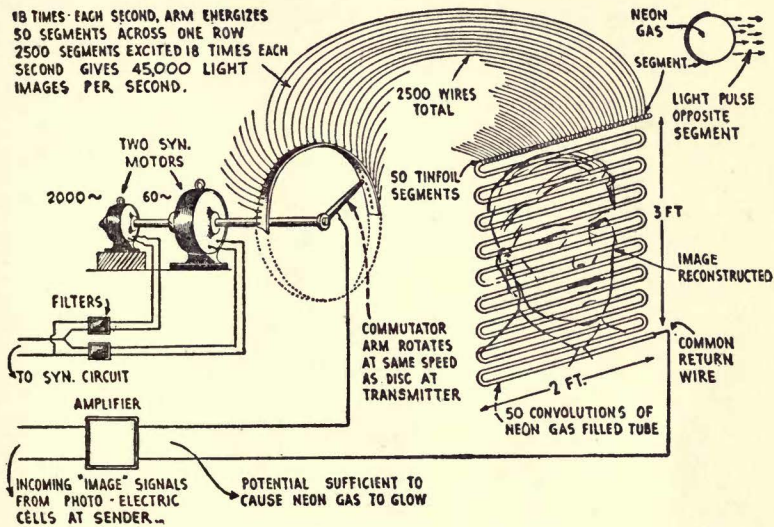

FIG. 2.—Showing the method used in impressing impulses upon a great neon tube provided with 2500 electrodes and a revolving contactor which properly distributes the light changes to the electrodes in such a way as to create the picture illusion. (Courtesy "Radio News.")

standing of the cathode ray by reference to Fig. 3. Here there is shown the physical arrangements involved in the creation of this pure electronic discharge. The diagram, however, shows only the details of the circuit, the glass container not being indicated. "F" represents the filament. This is heated to incandescence by a 6-volt battery. Between the filament and the metal tube "A" there is placed a high-potential battery of 300 volts. Those of us who recall the operation of the radio vacuum tube, understand that it depends for its operation upon

the release of electrons from the filament, these electrons being boiled out so to speak. Precisely the same thing happens in any heated filament, vacuum tube filaments differing from ordinary incandescent bulbs only in that they are coated with compounds that increase the release of electrons.

When the filament "F" in the cathode ray tube becomes incandescent, it gives rise to a source of electrons which, due

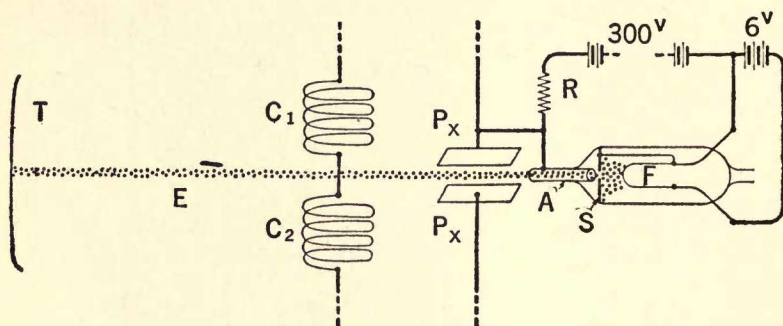

FIG. 3.—Schematic layout of the necessary components of a cathode ray tube used to make visible oscillating currents. The electron stream created by the hot filament F is forced out of its normal path by charges on the plates P_x and by currents in the coils C_1 and C_2 . The electron stream produces a visible effect on the screen T. This principle has been applied to the reproduction of television pictures.

to the positive charge on the metal tube "A", are projected forward in a thin stream or pencil, the electrons moving at a high rate of speed. Upon striking the target "T" a bright spot is produced. This phosphorescence is caused by coating the surface "T" with a chemical compound that glows under the action of the impinging electrons.

Soon after cathode rays were discovered it was found that they could be influenced by electrostatic or electromagnetic fields. P_x , P_x are metallic plates sealed in the cathode ray tube so as to form a small condenser between which the elec-

tronic stream passes. When these plates are charged, the stream is deflected from its normal course, the amount of deflection being proportional to the intensity of the charge. C1 and C2 are small coils placed on the outside of the tube. Current passing through these coils produces a magnetic field which is also able to exert influence upon the electronic stream bending it out of its normal position to a degree depending upon the strength of the current passing through the coils.

Inasmuch as the stream of electrons has practically no inertia when considered from the standpoint of a material body, it is obvious that it can be moved at a high rate of speed by changing the electrostatic and electromagnetic controlling forces. So rapidly can this beam be moved that the eye is unable to follow it. From what has been said it is clear that if we could change the intensity of this beam as well as its motion that it would be possible to cause television picture illusions by its use. This is precisely what Prof. Dieckmann has accomplished.

If we will refer to Fig. 4 we will obtain a very clear notion as to the way in which the cathode ray television receiver functions. The Brauns, or cathode ray, tube is shown at the lower left of the diagram. The control signals picked up by the aerial are carried to two sets of condenser plates, C1 and C2 and C3 and C4. These plates are placed at right angles across the cathode ray stream in tube "B". These signals are derived from the shunt circuit placed across the output of the first amplifier "V" through the second amplifier "V1" and the transformer "T".

The picture impulse signals are made to pass through amplifiers V2 and V3 to the grid "G" of the Brauns tube and here serve to control the intensity of the moving spot on the fluorescent screen or tangent at the end of the tube.

In the cathode ray television apparatus developed by Prof.

Campbell Swinton the rays at the transmitting end are used in conjunction with the so-called Hallwachs photoelectric effect which accounts for the loss of electrons from bodies exposed to radiations. These bodies become positively charged under the influence of a light ray. A number of small rubidium cubes

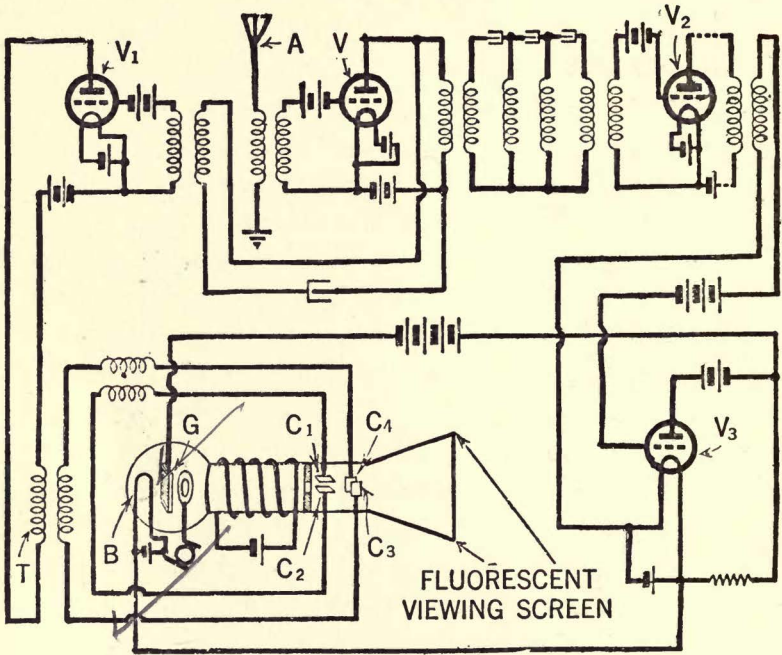

FIG. 4.—Diagram of a television receiver employing the cathode ray tube. The picture, which is formed by the controlling of a pure electron stream, appears on the fluorescent screen at the end of the cathode ray tube. A standard vacuum tube radio receiver is used to tune in the picture-laden waves.

are used to make up a screen onto the face of which light from the image to be transmitted is thrown. The cathode ray under the control of two pairs of condenser plates fed with properly regulated current is caused to slip regularly over the back of

the screen. These rubidium cubes under the combined influence of the light rays from the image and the rapidly moving stream of cathode rays create picture impulses corresponding to the various light and shade effects. These impulses are carried to a special vacuum tube amplifier from which they are either transmitted to a line or caused to modulate a carrier wave.

The receiving end of the Swinton system employs the cathode ray from a second Brauns tube, the electron stream of which is controlled by alternating current of precisely the same frequency as that used at the transmitter. Thus the ray at the receiver is caused to traverse the fluorescent viewing screen in exact step with the scanning beam at the transmitter. The receiving screen is therefore rendered luminous to the same degree of intensity and at frequencies corresponding to the tone effects of the transmitted object or picture.

Belin, the French experimenter, working in collaboration with M. Holweck, has devised a television transmitter and receiver which involves several admirable features. In place of using the conventional scanning disc at the transmitter, the scanning beam of light, after passing through a tiny aperture in a metal plate, falls upon two tiny mirrors oscillated mechanically by cranks and rods. One mirror is oscillated at two hundred times a second, the other at ten. Point by point the object is illuminated and reflected from a large concave mirror mounted at the end of a metal cylinder. At the focal point of this concave mirror there is arranged a sensitive photoelectric cell which, naturally, takes a central position in the drum. This cell is arranged at the end of a rod, a conventional vacuum tube amplifier magnifies the current generated by the cell.

Holweck, who has concentrated his efforts on the receiving components of the Belin system, employed a cathode ray to produce the necessary illumination at the receiving end. The

motion of this cathode ray is controlled by varying magnetic fields created by the received picture impulses.

Unlike the cathode ray tube of Professor Dieckmann, which is enclosed in glass, Holweck produces his cathode ray in a metal tube kept at a fraction of a thousandth of an atmosphere by a specially designed vacuum pump. So tightly is the tube sealed that when the pump establishes a high vacuum, it can be stopped and the vacuum will remain for several hours without seriously decreasing the flow of electrons which is maintained by a potential of 1,000 volts.

When the image first appears on the fluorescent screen of the receiver, there is evident a difference in phase between the mirrors and the cathode ray. This is corrected by adjusting the corresponding alternating currents energizing the magnets.

One of the outstanding features of this system, and a development due to the ingenuity of Holweck, is that increasing luminosity on the screen is brought about by a negative difference in potential of only 5 volts between the grid and the filament. As a matter of fact, a negative difference of potential of 5 volts is sufficient to arrest entirely the flow of electrons. This is perhaps one of the most sensitive controls that has as yet been devised. Any system operating with neon tubes requires a potential difference of 100 volts.

The imaginative, and at times speculative, John L. Baird, whose experiments in television have caused quite a stir in England, proposes a television system operating by the aid of infra red rays or "black light." Infra red rays are the rays of light between red and the heat-ray portion of the spectrum. These rays do not affect the optic nerve, but are readily detected by several well-known means. Specially constructed photoelectric cells that will give a response when struck with such rays are proposed. If the photoelectric cell can "see" by

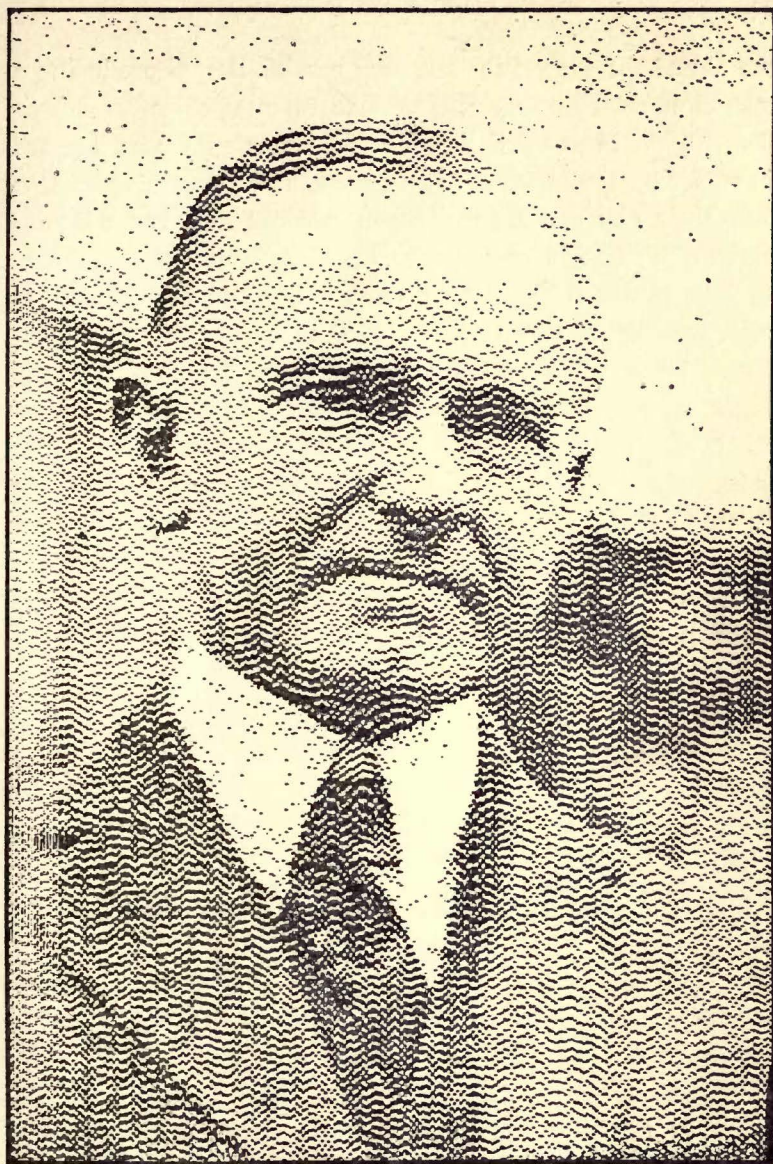

FIG. 4A.—Photograph of President Coolidge transmitted by the Ranger telephotographic apparatus. Although lacking in detail, the general effect is quite pleasing.

the aid of these rays, the startling possibilities of producing a television receiver that will operate in total darkness is evident. Thus in place of the powerful scanning beams that are now used in television instruments, the performers might take their place before a photoelectric cell in a room illuminated only with infra red rays.

The power of light to penetrate fog has been found to vary, roughly, as the 4th power of the wavelength; the shorter waves being more readily absorbed than the longer waves. Light such as that given by a neon tube is found to have a penetrating power sixteen times greater than that of blue light. Infra red rays, which are still longer, have a penetrating power 20 times that of blue light. It is due to the high penetrating power of red light that European airdromes are now using neon tube beacons to assist aviators during fog. The importance of these rays for marine purposes has also been recognized.

Mr. Baird believes that his Noctovisor, as he calls it, will some day have important use in warfare. He visualizes a powerful searchlight with an especially penetrating beam so constructed that only the infra red rays will be allowed to pass. The rays from this powerful light could be used to illuminate the enemy's position with the enemy being completely unaware of the fact. The light reflected would be picked up behind the lines, carried to a photoelectric cell, and amplified, the resulting images being visible at a neon tube operating behind a conventional scanning disc. In such an apparatus the transmitter and receiver would be combined, the transmitting and receiving scanning discs operating in perfect synchronization by being mounted on the same shaft.

There is still another amusing possibility that has been suggested by Mr. Baird. From what has gone on before, we know

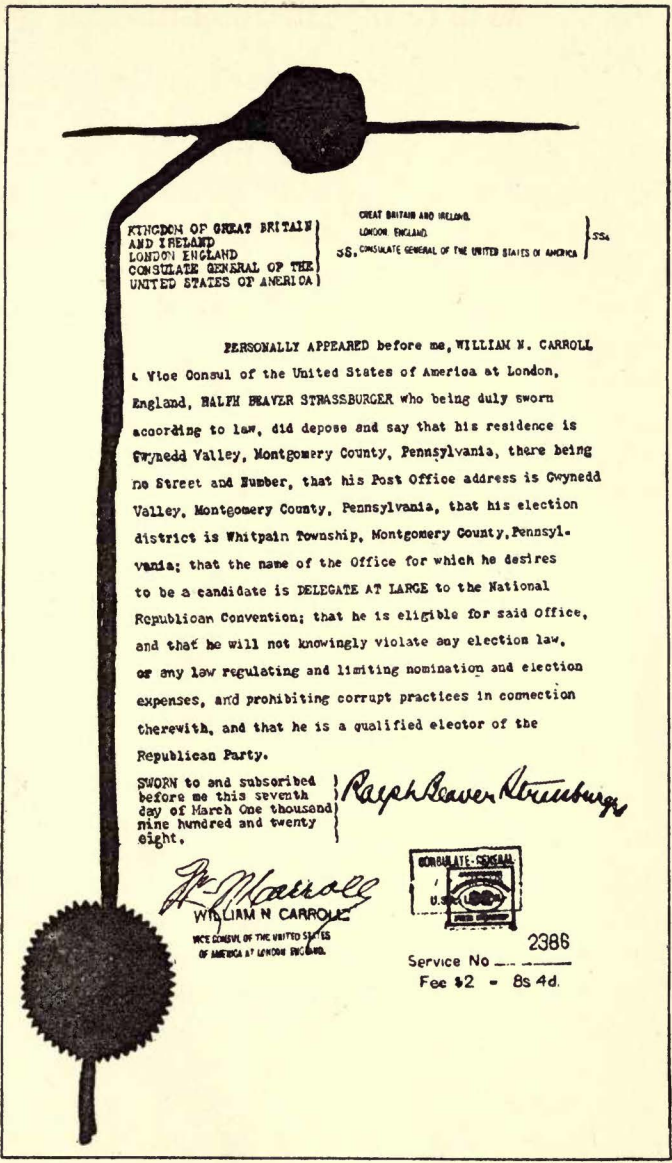

KINGDOM OF GREAT BRITAIN
AND IRELAND
LONDON ENGLAND
CONSULATE GENERAL OF THE
UNITED STATES OF AMERICA

GREAT BRITAIN AND IRELAND
LONDON ENGLAND
U.S. CONSULATE GENERAL OF THE UNITED STATES OF AMERICA

135A

PERSONALLY APPEARED before me, WILLIAM N. CARROLL
& Vice Consul of the United States of America at London,
England, RALPH BEAVER STRASSBURGER who being duly sworn
according to law, did depose and say that his residence is
Wynedd Valley, Montgomery County, Pennsylvania, there being
no Street and Number, that his Post Office address is Gwynedd
Valley, Montgomery County, Pennsylvania, that his election
district is Whitpain Township, Montgomery County, Pennsylv-
vania; that the name of the Office for which he desires
to be a candidate is DELEGATE AT LARGE to the National
Republican Convention; that he is eligible for said Office,
and that he will not knowingly violate any election law,
or any law regulating and limiting nomination and election
expenses, and prohibiting corrupt practices in connection
therewith, and that he is a qualified elector of the
Republican Party.

SWORN to and subscribed
before me this seventh
day of March One thousand
nine hundred and twenty
eight.

Ralph Beaver Strassburger

W. N. Carroll
WILLIAM N. CARROLL
VICE CONSUL OF THE UNITED STATES
OF AMERICA AT LONDON ENGLAND



2386

Service No. _____
Fee \$2 - 8s 4d.

FIG. 4B.—Legal document executed in London and filed in America several hours later. In keeping with the times, many of the courts of the world have recognized the validity of documents so transported.

that television picture impulses are amplified in exactly the same way as ordinary radio signals. Consequently, these picture signals, as audible sounds, could be permitted to pass through an ordinary loudspeaker. If, instead of permitting these signals to pass through the neon tube or loudspeaker, we should carry them to an electrical phonograph recording device, a record of the signals would be produced. The picture would be "canned," to use a colloquial term.

By employing what is known as an electrical pick-up similar to those used on modern electric phonographs, these picture signals could be reproduced from the record and changed back into electrical current. If the proper means for reception were arranged, the picture on the phonograph record could be reproduced. Baird believes that at some future date we shall have a phonograph that will not only reproduce music and voice but pictures as well, the picture coming from the record in place of motion picture film. As a matter of fact, pictures have already been recorded on phonographic discs. Austin Cooley, the phototelegraphic expert, has succeeded in recording and reproducing pictures that have been impressed on wax records. From the foregoing we can see that the work that has been done on television so far suggests many new applications that are not entirely outside the realm of the possible. While they may appear to be a bit speculative, to trained technical minds, they at least have more than a vestige of promise in them.

CHAPTER III

TELEGRAPHING PICTURES

An Outline of the Various Successful Methods Employed Today in the Transmission of Facsimiles and Photographs by Wire and Wireless Systems—Practical Description of Telephotographic Receivers for Home Use With Practical Instruction Concerning Their Operation.

PHOTOTELEGRAPHY is really not a new art. It was practiced, in a limited way, as early as 1842. The experiments made by Bain in that year had to do with the transmission of simple facsimiles. Although Bain used two synchronized pendulums, they operated in much the same manner as the apparatus shown in Figure 5. At the transmitter there is arranged a cylinder. The cylinder is coated with tin foil and the picture to be transmitted is drawn on the tin foil with insulating ink. A small metal finger plays over the cylinder, which is moved in a direction parallel to its axis through the medium of a threaded rod.

At the receiver there is a second cylinder covered with a paper saturated with a chemical preparation such as potassium iodide (KI). When the electric current passes through this chemical, the potassium iodide is decomposed and the iodine is freed, thus leaving a brownish stain on the paper. The two cylinders rotate in synchronism.

When the finger at the transmitter reaches the insulating ink, no stain will be produced at the receiving cylinder and, consequently, when the transmission is finished there will be

created on the paper at the receiver a white spot corresponding to the spot covered by the insulating ink at the transmitter.

This very crude system of transmitting facsimiles involves all the basic features of modern phototelegraphic transmission of pictures. Naturally, the system has been greatly improved and today it is possible to transmit photographs that bear extremely close resemblances to the original pictures.

So rapid have the advances been in phototelegraphy that this system threatens to eventually abolish the necessity of "dot

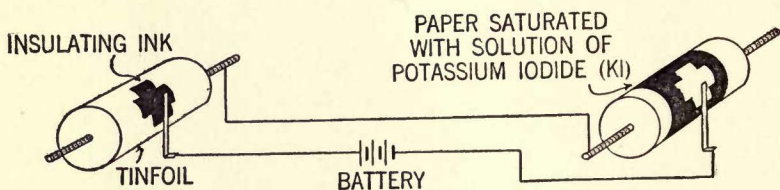
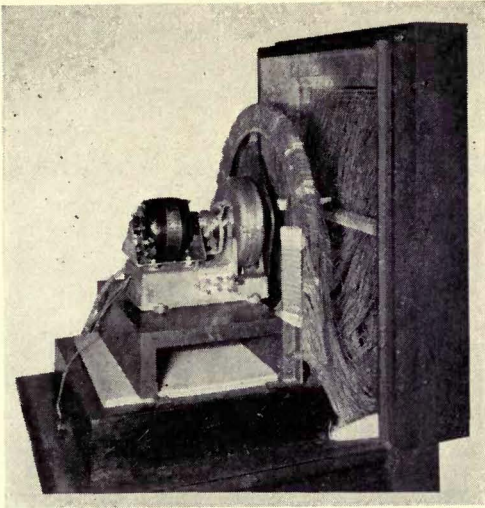
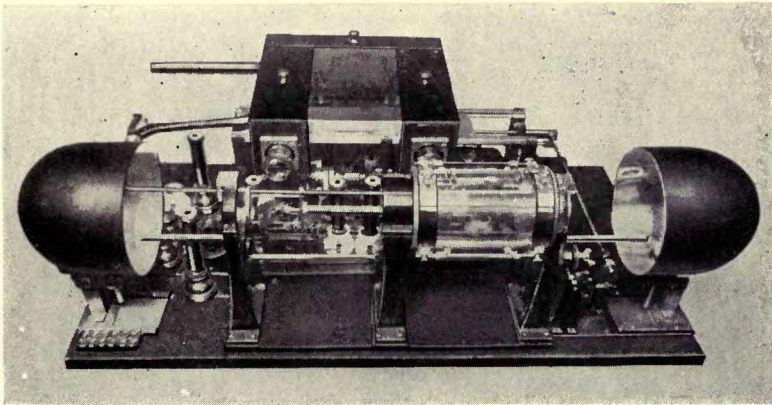

FIG. 5.—Diagram of a very simple picture transmitter similar to the first one employed by Bain in 1842. The picture to be transmitted is first drawn with insulating ink upon a metal cylinder. A contact riding over this cylinder causes the circuit to open every time the contact reaches this ink. This is recorded at the receiver by the action of a chemical when electrolyzed.

and dash" telegraphy. The large commercial possibilities in this system will become immediately evident when we understand that a full page of a New York newspaper, containing several thousand words, may now be sent across the Atlantic Ocean in a comparatively short space of time. To send the same number of words by "dot and dash" telegraphy would require a much longer interval; for even with high speed automatic transmission, 150 words per minute represents the maximum speed obtainable. Today there is operating between Berlin and Vienna a phototelegraphic system which is able to transmit photographically 500 words in less than one minute. This does not argue well for the future of hand-manipulated telegraphy, nor does it seem to increase the security for the



The complete high-speed distributor with its 2500 contacts and connecting wires leading to the tiny tinfoil electrodes of the special neon tube. The revolving contact arm is also driven by two motors to insure accurate synchronism. (Photo Courtesy Bell Telephone Laboratories, Inc.)



The transmitter of the Ranger system. As in all other photo-telegraphic systems, the picture is progressively explored with a fine pencil of light.

world-wide cable systems that have been built up during the past fifty years.

As stated before, practically all of our phototelegraphic systems are based on the simple principles laid down by Bain.

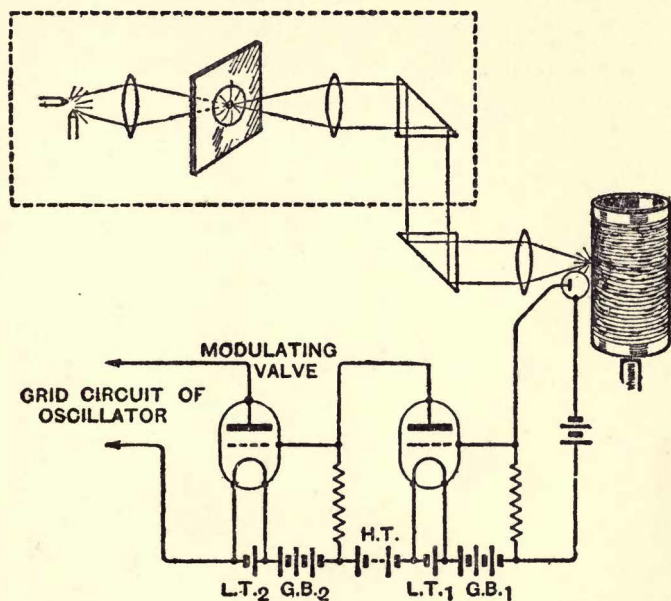

FIG. 6.—Showing the arrangement of the essential parts of the Karolus picture transmitter. The photoelectric cell is shown mounted adjacent to the picture on the revolving cylinder.

Improvements have come through the use of the photoelectric cell and through the employment of sensitive light-controlling means at the receiver. Perhaps one of the most highly perfected phototelegraphic systems is that developed by the Telefunken Company of Germany, known as the Siemens-Karolus Telefunken system. Unlike many other phototelegraphic devices, the photograph being transmitted requires no special preparation, such for instance, as that used by Belin in pre-

paring swelled gelatin prints of the photograph to be used. In the Siemens-Karolus apparatus, the photograph is simply wound around a transmitting cylinder which moves in the manner of the cylinder shown in Figure 5. In Figures 6 and 7, the simplified details of the Siemens-Karolus system are shown. A powerful source of light passes through a series of lenses and prisms, striking the cylinder as an extremely small point. This beam of light, through the progressive motion of the cylinder, is caused to explore or scan every detail. When light strikes an object, reflection takes place which is proportional to the condition of the surface and the color of the object. A photograph is made up of shades running all the way from very bright whiteness to dull black. When the beam of light strikes a white portion of the photograph, a great deal of light will be reflected. On the other hand, when it strikes a dark or shaded portion of the photograph, a relatively small amount of light will be reflected.

In the Siemens-Karolus system there is mounted adjacent to this beam of light a photoelectric cell, so positioned that the light reflected from the photograph strikes the cell. From what has been said previously concerning the action of photoelectric cells, it will be clear that the cell will respond to these varying light streams with current variations. These current variations are picked up and amplified by two vacuum tubes, the output of which is carried to a wire or radio transmitter.

The transmitter of the Siemens-Karolus system is very similar to transmitters employed by other investigators. It is in the receiver of this system (Fig. 7), that admirable ingenuity has been displayed. As a matter of fact, a large proportion of the merit of the whole system lies in the controlling of the light beam that strikes the receiving cylinder. The receiving cylinder is first wrapped with a piece of photographic

TELEGRAPHING PICTURES

41

paper. Picture impulses received, either by wire or wireless, are picked up and amplified through a series of vacuum tubes. The output of these tubes pass through what is known as a Kerr cell, and it is through this device that the local source of light, having its origin in the small arc, is controlled in accordance with the varying impulses created at the transmit-

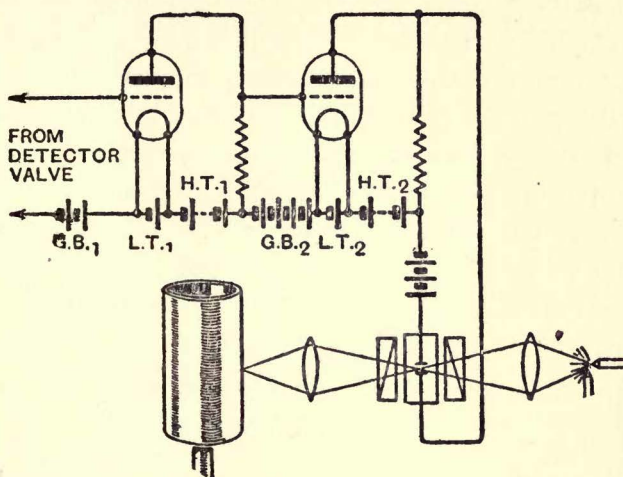

FIG. 7.—The essentials of the Karolus picture receiving system. The Kerr cell, which automatically regulates the intensity of the light beam to correspond with the fluctuations at the transmitter, is shown connected to the output of the vacuum tube amplifier. The cylinder carries the photo-sensitive paper upon which the picture is to be placed.

7949

ter. The Kerr cell is made up by arranging two small electrodes in a glass vessel containing carbon disulphide. The refraction index of carbon disulphide is changed when the current passes the liquid. In the Kerr cell, an extremely small condenser is formed by the two plates with carbon disulphide or nitrobenzine used as the dielectric substance.

The two condenser plates are set in such a manner that light from the arc light passes between. The pencil of light

is linearly polarized by nicol prisms, and the effect of applying a varying potential across the cell is to rotate the plane of polarization. To carry this explanation further, let us assume that a source of light may be turned through the nicol prisms, properly arranged at either end of a small brass tube. Light can succeed in getting through these prisms only when one prism is rotated at a particular angular relationship with regard to the other. If the Kerr cell is interposed between the two prisms and the potential applied across its plates, light will pass through the prism-cell to the prism after one of the prisms is rotated to take up a certain angular position with relation to the other. If the potential is removed from the cell, the prisms appear to become opaque to light, unless one is slightly readjusted by rotating. Thus in this way the Kerr cell, which is interposed in a polarizing position, performs the function of an electrically operated shutter and, depending upon the adjustment of the nicol prisms, can be made to pass from obscurity to light when the potential is applied across the plates. The strength of the beam passing through the Kerr cell can not only be turned "on" and "off" through applying potential, but its intensity can be regulated perfectly all the way between total brightness and utter darkness. Inasmuch as this potential applied to the plates is constantly changing due to the varying currents created by the photoelectric cell at the transmitter, the beam striking the sensitized paper at the receiver is caused to recreate any photograph that may be revolving on the distant drum.

Many inventors of phototelegraphic systems have relied for light changes at the receiver upon rapidly vibrating mirrors. Naturally, vibrating mirrors are troubled with inertia, and any system requiring for its operation a vibrating body, is limited in speed. The Kerr cell, on the other hand, has no

measurable inertia and its response to the varying potential is practically instantaneous.

As in systems of television, the matter of synchronized phototelegraphy is a problem that has persistently tried the ingenuity of workers in this field. In the Siemens-Karolus system almost perfect synchronization is obtained solely by the aid of tuning forks fitted to the transmitter and receiver. Tuning forks are maintained in vibration through the medium of oscillating vacuum tubes, the action being that the potential set up by the prong of a vibrating tuning fork, moving in a magnetic field near a coil of wire, is applied to the grid of the vacuum tube, while another coil is energized by the fluctuating plate current. This, perforce, is maintained in constant motion. Through the medium of a variable condenser connected across either of these coils, the frequency of the circuit may be modified.

In any picture transmission system, means must be provided to avoid the joint formed when the photographic print and the sensitized paper are placed on the receiving and transmitting cylinders. Otherwise, the picture may be recreated on the sensitized paper with a joint running through the center. In the system being discussed, the correct position is indicated by sending automatically from the transmitter what is called a "phasing signal." This is transmitted prior to the scanning of the picture. A tiny neon lamp rotates on the cylinder at the receiver and flashes with each "phasing signal." Consequently it is only necessary to momentarily arrest the motion of the cylinder so that the flashes cause a fixed mark. As a matter of fact, this neon lamp, in addition to accommodating the "phasing signal" also checks synchronization, for should the glow move a little from one side to the other, the tuning fork will need slight adjustment by means of the variable con-

denser. So perfectly does this system function, that in actual operation it is found necessary to make adjustments on the variable condenser on an average of once a day. In use, the Siemens-Karolus system can handle pictures measuring 10 by 10 centimeters in one-quarter of a minute. Naturally, larger pictures require greater time, an 18 by 26 centimeter picture requiring from two to four minutes.

The Cooley Rayfoto system, developed by Austin G. Cooley, lends itself well to amateur experimentation, owing to the simplicity and inexpensiveness of the apparatus used.

The Cooley transmitter, which may be employed on any broadcaster of standard wavelength, is also a comparatively simple device, which may be successfully manipulated by station operators. Figure 8 depicts a rough approximation of the apparatus involved. Light from a source (L) is interrupted by a perforated disc driven at a critical speed by a small motor. The light is bent by a prism and converted into a tiny spot on the picture by a small lens. From the picture the light is reflected to a photoelectric cell connected to a special amplifier, the output of which is fitted to the modulating tubes of the broadcast transmitter. The positive print of the picture to be transmitted is wrapped around a cylinder which, through the medium of a threaded rod, advances one $\frac{1}{80}$ th of an inch every revolution. Each line of the picture is broken up into 480 sections. 48,000 electrical impulses are transmitted for every 100 revolutions of the drum which revolves approximately 100 revolutions per minute, covering $1\frac{1}{4}$ inch of the picture per minute at this speed. The drum measures 2 inches in diameter and is 5 inches long, accommodating a 5 by 6 inch picture.

The Cooley system employs what is known as the "start-stop" method of producing synchronization between the re-

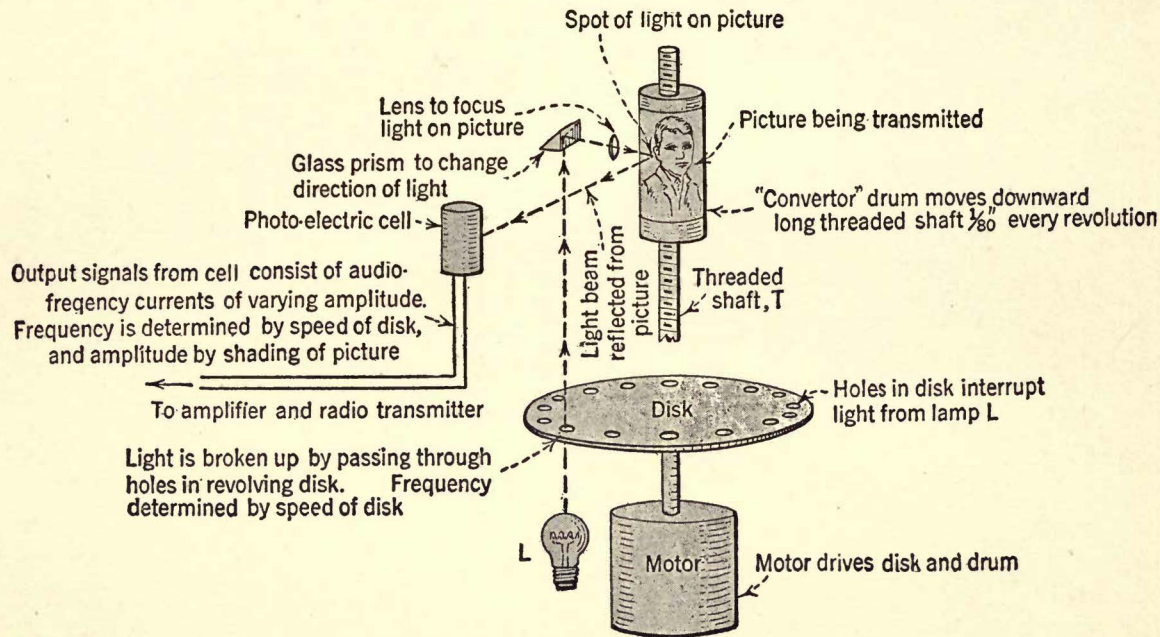

FIG. 8.—Principal parts of the Cooley Rayfoto transmitting system. The operation of this is more or less conventional, the picture which is wound upon a drum being explored by a beam of light which is reflected to a photo-electric cell. (Courtesy "Radio Broadcast.")

ceiving and transmitting drums which are identical in physical dimensions. The beginning of each revolution of the transmitting drum or cylinder is marked by an impulse of twenty strong 800 cycle signals. This synchronizing impulse is employed at the receiver to start the recording drum off at exactly the same time as the transmitting drum. The signal is duplicated at the beginning of every revolution and thus corrects any difference in speed that may have developed during any particular revolution of the receiving drum. In this system it is necessary to have the recorder drum at the receiver run slightly faster than the transmitting cylinder. A trip magnet, operated by the synchronizing signal, releases the receiving cylinder at the proper moment.

This trip magnet which controls the motion of the receiving signal and which is pointed out in the photograph of the apparatus is operated through a relay which is connected to the recording system only after the revolution of the recording cylinder has been completed. By pasting a strip of white paper at the end of the picture being transmitted, the signals will be weak at this point while the recorder drum is stopped. In the event of a crash of static being received during this waiting period, the recorder drum will be released in advance of the synchronizing signal. In making this recorder lap very small, the danger of a static slip would be reduced proportionately. This is to take care of the emergency that might be created during reception at a time when static was very strong.

Figure 9 illustrates the apparatus used in the receiver and the method employed in hooking it up. In his receiver, Cooley employs a corona discharge which is a high-voltage discharge produced by an oscillating vacuum tube through the medium of a Tesla coil. The incoming drum impulses are used to

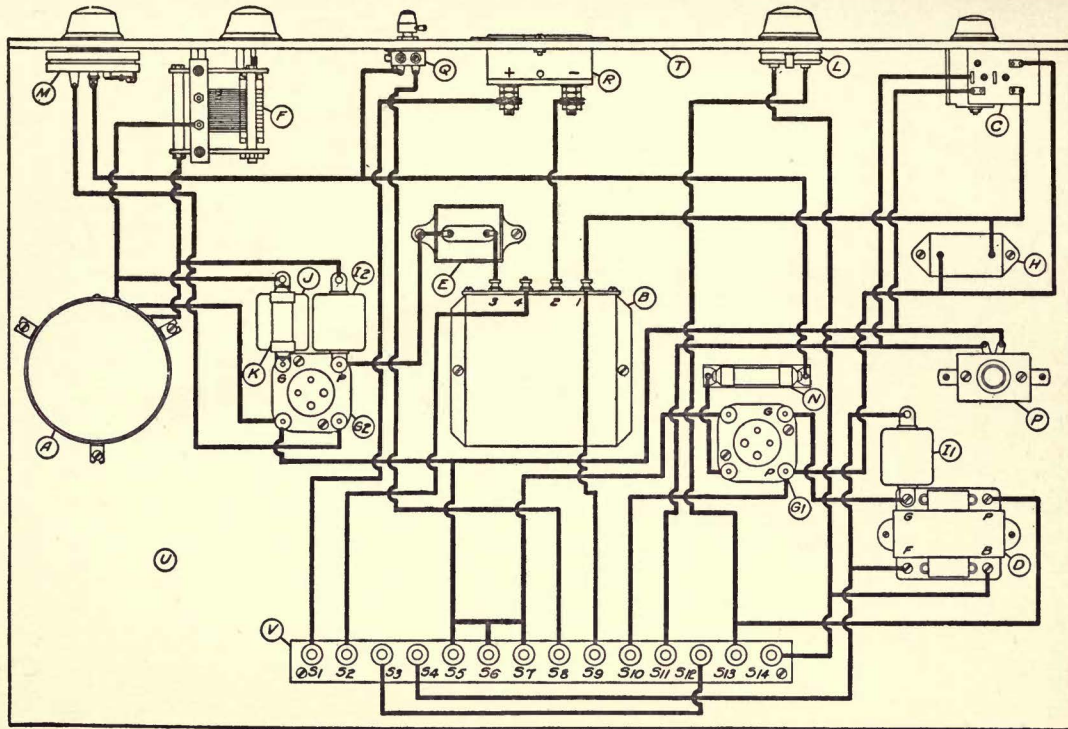

FIG. 9.—Layout and connection necessary for a receiver of the Cooley type. At A there is shown the "corona coil" which generates the high-voltage used in exposing the photo-sensitive paper wound upon the receiving cylinder.

modulate this oscillating circuit so that the intensity of the corona discharge will be regulated according to the strength of the picture signals. The high-voltage discharge occurs at the point of a needle which operates over the sensitized paper on the receiving drum. The actinic value of the light produced by the corona discharge at the needle point is quite high, which permits rapid movement of the drum at the same time giving intense exposures. In the diagram Figs. 9 and 10, (C) is an actuating relay, controlled by the picture impulses; (L) is a variable resistance; (R) is a milli-ammeter reading up to 25 milliamperes; (Z) a battery switch; (F) a variable condenser; (M) a filament rheostat; (I-1 and I-2) small fixed condensers; (N) an automatic filament rheostat; (G1 and G2) vacuum tube sockets; (K) a grid resistance; (J) a fixed grid condenser; (E) a radio-frequency choke; (P) a push button, and (H) a fixed condenser.

All of the apparatus employed in this picture signal converter is standard with the exception of the modulation transformer (B) and the corona discharge coil (A). The diagram, Figure 10, shows the connections to the Cooley Rayfoto transmitter in the more conventional fashion. A study of the apparatus involved and its electrical relationship will reveal that the oscillating circuit is of the Hartley type, the incoming picture signals which are first amplified by an ordinary broadcast receiver being used to modulate the Hartley circuit.

Just as in the case of ordinary radio reception, good pictures are received with the Rayfoto system only when good audio apparatus is employed. Picture distortion may result from poor amplification when transformers are used with unsuited characteristics. A badly designed audio amplifier system will blur the details and will cut off many of the details in the lighter shades. Even when good audio apparatus

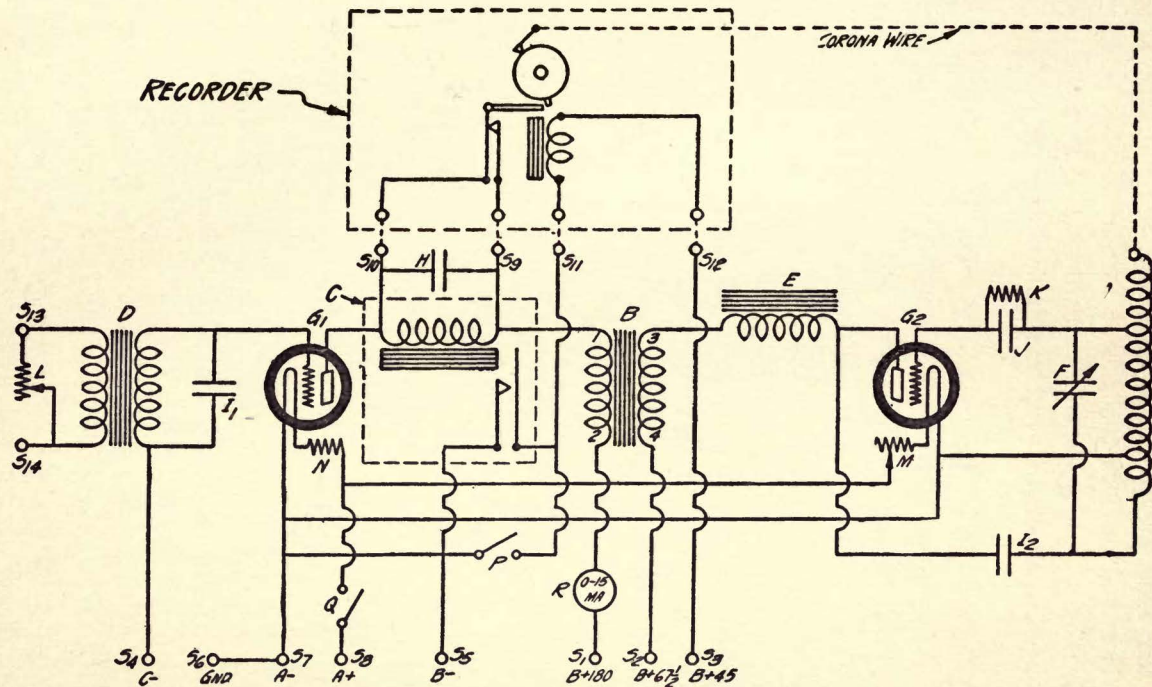

FIG. 10.—More conventional diagram of the connections used in the Cooley Rayfoto receiver. This apparatus is connected to the output of a standard broadcast receiver. This is really the printing apparatus which is controlled by the signal received from a broadcast outfit. The high-voltage discharges appears at the point of the needle which is shown resting upon the cylinder.

is used, the experimenter must take care to see that the amplifier is not allowed to oscillate or to operate at a point near oscillation. A large fixed condenser placed across the "B" Batteries will tend to overcome audio-frequency oscillation.

In actual operation, the Cooley Rayfoto picture printer draws a total of 45 milliamperes from the "B" battery, with a total voltage of approximately 200 for efficient operation.

The corona discharge produced at the needle on the receiver cylinder is something in the nature of the discharge produced by an ultra-violet machine, and while its voltage is extremely high, there is no danger resulting from accidental contact with it. The discharge occurs at a potential difference which approximates 45 volts per centimeter. The primary of the corona coil is a part of the vacuum tube oscillating circuit which operates at a frequency of 333 kilocycles. As a boosting voltage, and to insure efficiency in shading, about 100 volts of direct current is applied in series with the modulation transformer, care being taken that this boosting voltage is not high enough to produce a corona which will print above weak signals that may be coming through.

The mechanical system of the Cooley Rayfoto Receiver is extremely simple. The receiving drum is mounted in a cast metal frame and is driven through a system of two bevel gears from the turn-table of an ordinary household phonograph, the speed of which may be regulated to a nicety. The "stop-start" synchronizing mechanism consists of a slip clutch between the motor drive of the drum and the trip magnet that stops the drum at the end of each revolution until the synchronizing impulse is received. The corona discharge needle is held in an insulated arm at the top of the cylinder. This

needle obtains its movement from a threaded rod at the rear of the mechanism.

The recorder drum is actually the same size as the drum at the transmitter. This drum, however, runs slightly faster than the drum at the transmitter and, consequently, the received picture will be stretched out a small amount, depending entirely upon the amount of lead. To afford compensation for

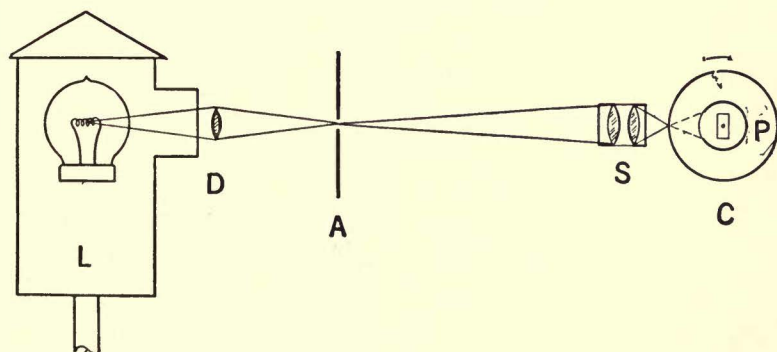

FIG. 11.—Simple elements of the Bell Telephone phototelegraphic system. L is the light house, D a condensing lens, A an aperture, S a projection lens, C the transparent cylinder, and P the photoelectric cell. (Courtesy Bell Telephone Laboratories, Inc.)

this, the gears between the drum and the screw feed shaft are of such a ratio that the needle will feed along a little faster than the transmitting drum so that the proper proportions are restored. It is this feature of the Cooley system that makes the pictures received appear slightly elongated. However, this slight distortion is not sufficient to destroy the pictorial value.

A phototelegraphic system now regularly employed by the Bell system possesses many interesting features to those experimenters who have believed that picture transmission was very intricate. In Figure 11 the simplified details of the trans-

mitter are illustrated. At "L" we have a source of light which passes through a condensing lens "D," a diaphragm "A," a projector lens "S" and through a photographic picture film wound upon a cylinder represented by "C." Inside this cylinder there is arranged a specially constructed photoelectric cell which gathers in the light impulses and causes them to be registered upon the electric current. This cell is of the alkaline metal type and has been developed in a form well suited to this particular service. The receiving system of the Bell phototelegraphic apparatus is especially ingenious involving as it does a light valve which controls the flow of light so that it will respond in accordance with the fluctuations brought by the photoelectric cell at the transmitter. This light valve, is made up of a narrow ribbon-like conductor mounted in a magnetic field, in such a position as to cover entirely a small aperture. The incoming current from the transmitter passes through this ribbon, which is, as a result, deflected or pulled to one side to a degree depending upon the strength of the current; the motion being due to the inter-action of the current with the magnetic field. Thus, this light valve causes the intensity of the light at the receiver to be varied in accordance with the impulses reaching the photoelectric cell at the transmitter.

The light passing through this electro-dynamically controlled light valve falls upon the photo-sensitive film bent into a cylindrical form. In the diagram Fig. 12 we see an exaggerated drawing of the light valve details. "R" is the ribbon through which the picture current from the transmitter is caused to flow. "P" is a pole piece of the powerful electromagnet which supplies the magnetic field that interacts with the field set up by the ribbon. At "J" will be seen the jaws of the aperture directly beyond the ribbon. It will be

noted that adjusting screws are provided to regulate the size of this aperture.

In Fig. 13 there is given an elementary layout of the picture receiver. "L" represents the lighthouse, "D" a condensing lens, "V" the light valve, "S" the projection lens and "C" a photo-sensitive film wound about a cylinder.

In this simple scheme of picture projection over a distance,

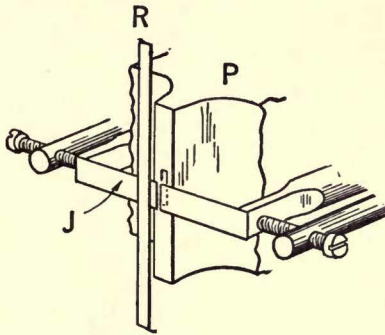

FIG. 12.—Details of the light valve used in the Bell phototelegraphic system. The ribbon R, which is arranged in the magnetic field of the magnet P, is moved slightly upon the passage of the picture current. This slight movement permits light to pass. (Courtesy Bell Telephone Laboratories, Inc.)

the photoelectric cell at the transmitter gives rise to a direct current of varying amplitude having a range of frequency components in current that varies between zero and a few hundred cycles. Due to the fact that this system has been developed primarily for use over standard telephone wires, and due to the fact that long-distance telephone circuits are not adaptable to the transmission of low-frequency currents, the output of the transmitter is not fed directly into the telephone lines. It is obvious that this output current from the photoelectric cell is extremely weak when compared with ordinary telephonic currents. The output current is therefore first

amplified with vacuum tubes and is then impressed upon a vacuum tube modulator jointly with a carrier current with a frequency of about 1300 cycles per second. What is transmitted over the telephone line amounts to a carrier wave form produced by the photoelectric cell. In this way the frequency in both range and amplitude is similar to the currents used in ordinary telephone speech.

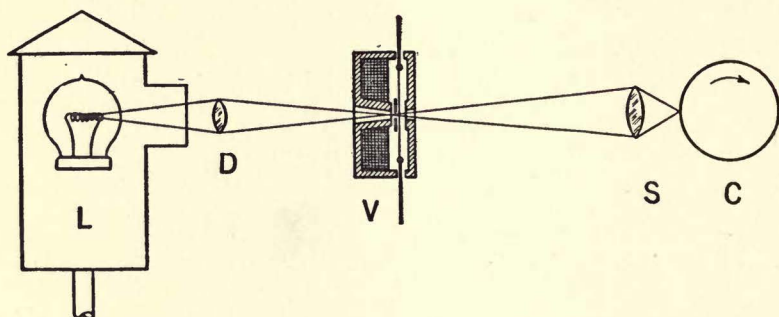
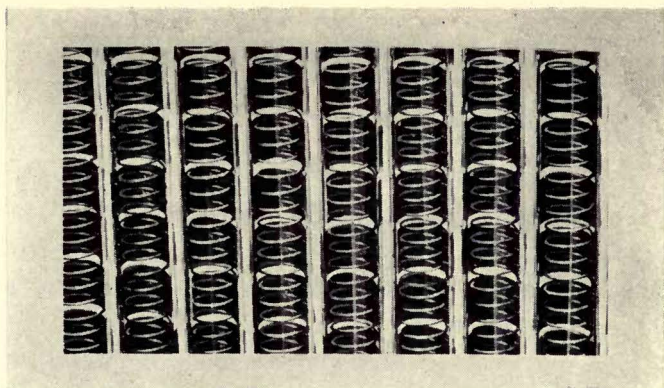
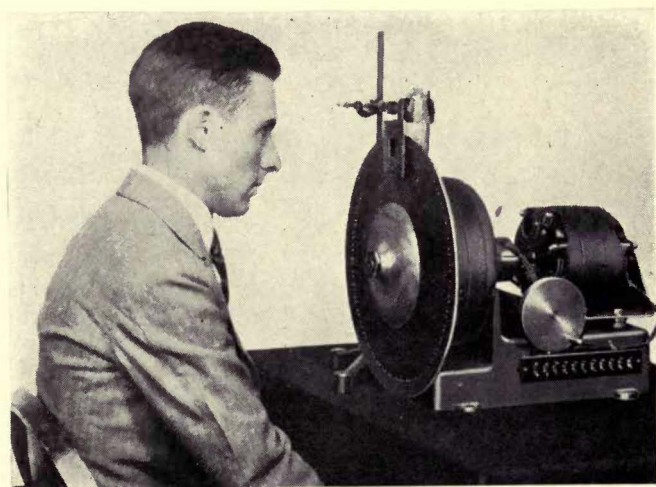

FIG. 13.—Principal parts of the Bell picture receiver. L is the light house, D a condensing lens, V the light valve, S a condensing lens and C the cylinder carrying the photo-sensitive paper. (Courtesy Bell Telephone Laboratories, Inc.)

At Fig. 14 there is illustrated a diagrammatic representation of the picture and the synchronizing currents. "P" represents the photoelectric cell, "AM" the amplifier and modulator, and "V" the light valve. All of these being associated with the picture channel. The synchronizing channel has associated with it phonic wheel motors, "M," tuning forks, "T," and an amplifying rectifier, "AR." This synchronizing system is made up of phonic wheels or impulse motors controlled by the electrically operated tuning forks. While some systems of phototelegraphy have been devised using two tuning forks at-tuned to the same period, one being located at the transmitter and one as the receiver, experience has shown that this system



Showing the construction of the giant neon tube employed in the television system developed by the engineers of the Bell Telephone Laboratories. The spiral mounted within the glass tube is made of wire while the tiny electrodes mounted on the outside of the tube are of tinfoil cemented to the glass. The discharge in the neon gas is caused by a capacity effect taking place between the large spiral electrode and the tinfoil electrodes mounted on the outside of the glass tubes. (Photo Courtesy Bell Telephone Laboratories, Inc.)



An observer sitting before a television receiver. The picture appears in the small square aperture, the neon tube being mounted directly in line with this member. Two driving motors are used in this system, one a 60-cycle synchronous motor and one a 2000-cycle synchronous motor. (Courtesy Bell Telephone Laboratories, Inc.)

is not wholly reliable. In actual practice, improper temperature correction and other causes prevent two forks from operating at precisely the same period of vibration. This discrepancy causes the reception of a skewed picture.

Due to the work of Mr. M. D. Long of the Bell Telephone Laboratories this problem has been overcome by controlling both the phonic wheel motor at the transmitter and at the receiver by the same fork. Thus there is a synchronized signal

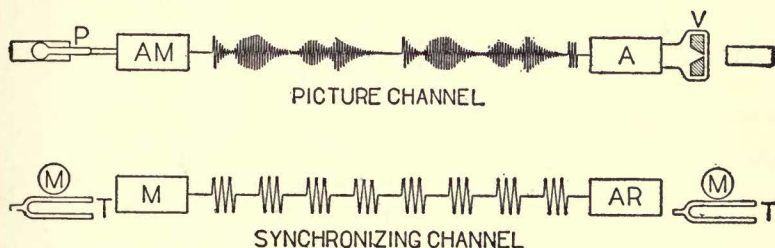

FIG. 14.—Diagrammatic representation of the picture and synchronizing currents used in the Bell phototelegraphic system. (Courtesy Bell Telephone Laboratories, Inc.)

created by the tuning fork and transmitted simultaneously with the picture. Fig. 15 gives a schematic layout. While two forks are used in this system, the control is exercised by one. In the old systems where two forks were independently used, synchronization depended wholly upon the accuracy of the independent units.

It is obvious that it would not be economical to use two separate circuits in the transmission of photographs. Consequently the two currents, that is the picture signal and the synchronizing signal, are sent upon the same circuit, the picture being sent on the higher frequency carrier (about 1300 cycles per second) and the synchronizing impulse sent at approximately 400 cycles per second. By the employment of these

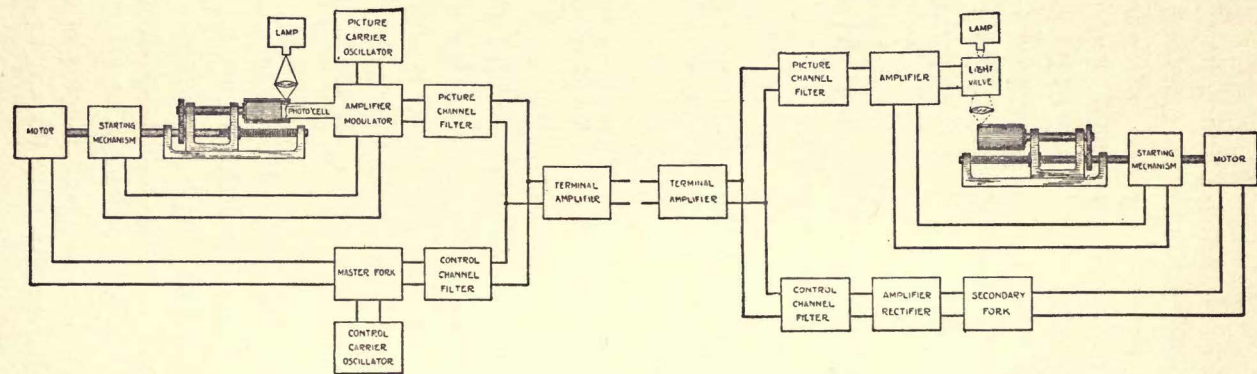

FIG. 15.—Complete layout of all accessory devices used in the Bell system of phototelegraphy. (Courtesy Bell Telephone Laboratories, Inc.)

frequencies ordinary telephone circuits are made available for use in picture transmission.

The Radio Corporation of America has, during the past five years, developed a unique system of picture transmission, the received picture being simply made up of a series of rapid-fire dots and dashes. As in all of the phototelegraphic systems, the transmitter consists of a glass cylinder carrying the photographic film and harboring an intense source of light. This light, after passing through the film strikes a photoelectric cell connected to a vacuum tube amplifier. As in all other systems, the film at the transmitter and receiver is carried forward by a threaded rod which permits the light beam to explore the film and the photo-sensitive paper at the receiver.

The Radio Corporation system does not reproduce a true photographic effect at the receiver. Instead a picture is produced made up of light and dark spots, shading being accomplished by a series of tiny dots as the photograph of President Coolidge will show. To accomplish this effect, the transmitter is not modulated in the usual sense of the word. A dot or dash operates a relay which turns on and off the currents flowing from the high frequency generators to the antenna system. Here we have actual impulses similar to the dots and dashes of the telegraphic code. The receiver is operated in much the same manner through the action of relays.

CHAPTER IV

PHOTOELECTRIC CELLS—EYES OF TELEVISION

How Photoelectric Cells Serve as "Light Microphones" in Modulating Radio Waves With Light Impulses—Elementary Outline of the Theory of Photoelectric Phenomena.

THE photoelectric cell is the all-seeing eye of television. In reality, it is what we might call a "light microphone." The sound microphone at a broadcasting station or on a telephone, is sensitive to sound vibrations which are impressed upon an electric current through this medium. We say the electric current is modulated by the sound. The photoelectric cell performs precisely the same function, but instead of being sensitive to sound it is sensitive to light, and light variations falling upon a photoelectric cell cause it to affect the current in exact proportion to the intensity of the light. A weak light will cause but a small change in current and a stronger light a greater change.

Scores of physicists have made invaluable contributions to the photoelectric cell since the time Hallwachs laid the foundation for this instrument in 1888. The modern photoelectric cell takes on the appearance of a glass bulb which may vary in size and shape. The cell is provided with two electrodes which are brought to two external connections to provide contacts that the cell may be incorporated in various kinds of vacuum tube amplifying circuits. One of the electrodes inside the cell

takes the form of a grid anode which may be made up of either a single loop of fine wire or a thin metal gauze suitably suspended and supported. The other terminal of the cell, (cathode) with which the other external connector comes in contact, takes the form of a deposit of a photo-sensitive metal or compound involving sodium or potassium, lithium, rubidium or caesium. Although all metals to some degree emit electrons when struck with ultra-violet light, those mentioned above will release electrons freely under the action of visible light. Potassium hydride is one of the extremely photo-sensitive combinations which may also be deposited upon the inside of photoelectric cells. A flash of light so weak and so quick as to be imperceptible to human vision will cause electrons to be emitted by potassium hydride.

There are really two types of photoelectric cells; one the gaseous type and the other the high-vacuum type. In the gaseous type, there is admitted to the cell during its construction and after a high vacuum has been created, a very small amount of one of the rare gases such as argon, neon or helium. Such gases, when subjected to the bombardment of electrons that are released when the cell is struck with light, becomes conductive to a degree depending upon the intensity of the light. The vacuum type, however, becomes conductive by what is known as a pure electron discharge. In the gaseous cell, the gas present is ionized (more about ionization later) due to the molecules being struck with racing electrons. Although the gas type of cell permits more current to flow, it is not as sensitive or as quick in its action as the vacuum type. Indeed, vacuum type cells have been made to respond so rapidly to impinging light waves that lag or "inertia" could not be detected.

We may regard photoelectric cells as perfect insulators in the dark and partial conductors when exposed to light. The

photoelectric cell, however, does not conduct a great amount of current even when it is subjected to powerful beams of light. At best, only a current of a few microamperes will pass through them, but owing to the perfection of the vacuum tube amplifier these minute currents can be used to produce visible and mechanical effects.

Einstein has given us a better understanding of the operation of photoelectric cells with his equation :

$$h\nu - h\nu_0 = \frac{1}{2}mv^2$$

This is now recognized as the fundamental equation of photoelectricity and it gave support to the corpuscular theory of light now known as the quantum theory or the theory of quanta. The basis of computation used is in absolute CGS units where C stands for centimeter; G for gram and S for second. The small h in the equation represents Planck's "radiation constant"; 6.54×10^{-27} erg. sec. ν_0 is the frequency of the long wave limit for a given surface. Lower frequency light than ν_0 will not release electrons from this surface regardless of how intense the light may be.

It is rather important for experimenters with television, and for those who would understand the action of the photoelectric cell, to remember that short waves, that is, waves near the violet end of the spectrum, are more powerful photoelectrically than are the longer waves. Also that there is a wavelength that will just release electrons, and that any longer wave will not produce the photoelectric effect.

This particular function, which is so important in understanding photoelectric action, is quite different for each different photoelectric material. For zinc, the long wavelength limit is in the near ultra-violet, while for platinum it is in the far ultra-violet. When a pure sodium surface is used, the long

wavelength limit will be found somewhere in the green portion of the spectrum which is equivalent to saying that the pure sodium surface will demonstrate the photoelectric effect for green, blue, violet and ultra-violet, but that it will not demonstrate the photoelectric effect for wavelengths longer than the green. Thus, it will be obvious that it will not respond to yellow and red.

Inasmuch as glass will not transmit the shorter wavelengths in the ultra-violet portion of the spectrum, below 3300\AA° (3300\AA° refers to Angstrom units which is a measure of wavelength equivalent to 10^{-8} cm.) ordinary photoelectric cells in glass containers, regardless of the nature of the photoelectric material encased, will not respond to waves beyond the figure mentioned. A number of experimenters, however, have pushed forward into this zone of the ultra-short waves by employing fused quartz bulbs. By the use of the proper photoelectric materials, cells have been made that will reach down to 1800\AA° , which is well down into the ultra-violet spectrum.

From what has been said previously, it must be evident that we have to deal with four variable factors in operating photoelectric cells. These factors are light intensity, light wavelength or color, voltage applied to the cell and current. There is a distinct relationship between wavelength and current.

In Fig. No. 16 there is shown a simple photoelectric cell circuit involving a voltage source, which may range from 10 to 500, and a micro-ammeter. When light is permitted to fall upon the photoelectric surface from the light source, the micro-ammeter will indicate the current flowing. As the light source is moved toward the photoelectric cell, this current will increase. Naturally, the amount of current flowing will not only depend upon the proximity of the source of illumination, and its intensity, but also upon the voltage of the battery. As in the case

of the ordinary vacuum tube used in radio, the current flowing will increase with increased voltage. Thus, it will be seen that the photoelectric cell, as in the case of the ordinary three-element vacuum tube, demonstrates a relationship between the applied voltage and the resultant current. As a matter of fact, vacuum type photoelectric cells show a voltage current curve very similar to that which may be produced by a vacuum tube, the current increasing rapidly as the higher voltage is

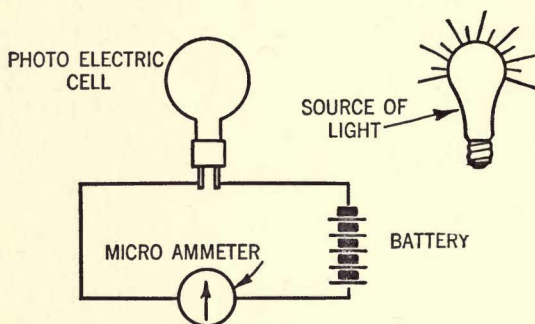

FIG. 16.—Fundamental action of a photoelectric cell may be determined by such a set up as this. The amount of current registered by the milli-ammeter varies inversely as the square of the distance from the cell to the light source, showing that the current increases or decreases directly with the amount of light falling upon it.

approached. The ultimate or limiting value of the current is called the saturation current, which naturally is the saturation point of the cell. In photoelectric cells of ordinary type, this saturation point is reached somewhere between 1 to 250 volts. It is not uncommon, however, to find among the more modern cells of the vacuum type, specimens which will give saturation current at extremely low voltages. Due to the good control in manufacture and design it is also possible to produce cells in which saturation will not be reached until as much as 500 volts has been applied to the grid or anode.

The relationship existing between applied voltage and current output will be seen by reference to the figures below. The readings of the current and voltages indicated were taken under constant illumination in connection with a cell that was made to perform at extremely low potentials.

Volts.	Microamperes.
0	0
.04	.1
.1	.3
.4	.95
.8	2.0
1	2.0
2	2.2
20	2.4
80	3.1
200	3.3
500	3.3

From these figures it is evident that the cell under test was practically saturated at .8 volts.

Photoelectric cells of the gaseous type produce different saturation curves. In this type of cell, electrons released from the photoelectric surface are accelerated by the applied voltage until they have attained such a velocity that upon collision with a molecule of the gas within the cell they ionize the molecule, breaking the binding force between it and one of its electrons. When this action takes place, the strong electric field existing between the anode and the photoelectric surface, pulls the ionized molecule back to the surface from which the speeding electron came. The newly released electron, which was torn away from the gas molecule, proceeds in the same direction as the colliding electron. This process is duplicated many times and naturally the larger the number of times the greater the

amount of current the cell will pass. When the positive ion, so formed, reaches a sufficiently high velocity to cause ionization, an arc is formed and the cell ceases to be sensitive to light effects. Accidental arcs, which may be avoided by a limiting

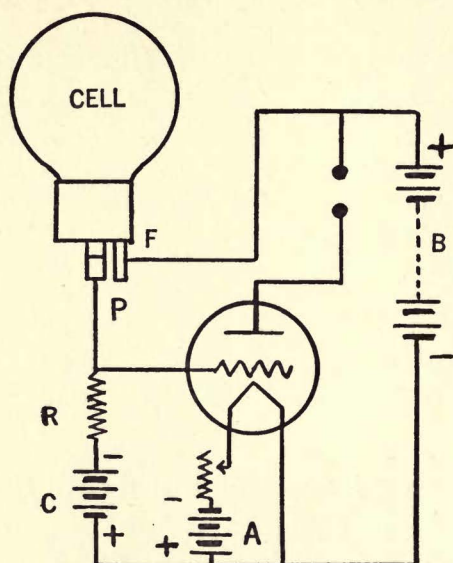

FIG. 17.—Connections for a single tube photoelectric cell amplifier. The resistance R will be found to vary, $\frac{1}{2}$ megohm being about correct for Burt sodium cells. Other type cells will probably require higher resistances. The output of this amplifier may be fed to another amplifying system.

resistance, should be guarded against. Otherwise the cell will be permanently damaged.

In the manufacture of cells great caution has to be used to avoid occluded gases, for the ionized molecules of all but a very few rare gases are very active chemically. In making gas type cells, it is necessary to introduce into the cell an extremely pure and inactive gas, such as argon. The introduction of other chemically active gases would result in a cell showing poor char-

acteristics for television work. Sodium and other metals showing desirable photoelectric properties are among the most active chemicals, hence the need to guard against contamination.

In Fig. 17 there is shown a diagram of a single stage vacuum tube amplifier for use in connection with either a gas or vacuum type photoelectric cell. In the case of a gas type cell

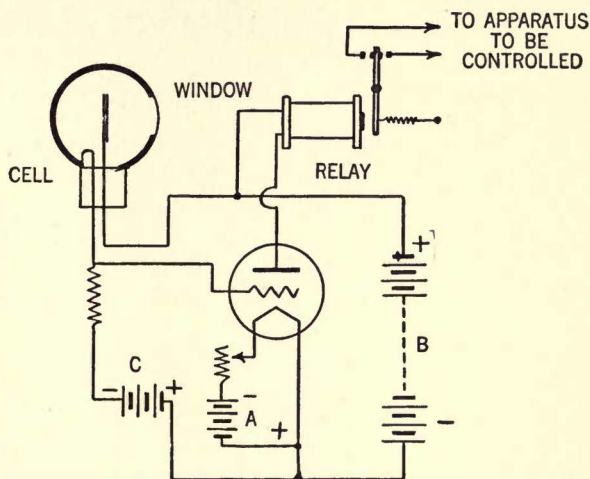

FIG. 18.—How a photoelectric cell is used to control a relay. When used in this manner, a cell will cause a beam of light to operate large machines like electric motors, horns or bells. If more stages of amplification are used, a less sensitive relay may be employed.

of ordinary design, the resistance "R" should be about $\frac{1}{2}$ megohm. A "C" battery of about $4\frac{1}{2}$ volts will be found sufficient for general use. The vacuum tube may be an ordinary 201A type and the applied voltage may run anywhere from 10 to 250.

The output of this amplifier may be connected through resistance coupling to the input of a second amplifier comprising up to 3 or even 4 tubes.

In Fig. 18 there is shown another diagram which illustrates the method employed in causing a photoelectric cell to trip a sensitive relay when the cell is struck with light. The diagram is included for those workers who may desire to experiment with telephotographic systems employing "make and break" methods by which silhouettes may be effectively transmitted.

Although there should be nothing in the foregoing description of the operation of photoelectric cells that would be beyond the comprehension of those of us who are even superficially acquainted with the electron theory, it is possible that the explanation does elude those not so fortunate as to have had some understanding of modern physics.

While operating upon delicate principles, the photoelectric cell, is, after all, a comparatively simple device. It does its work quietly and efficiently although our eyes are not powerful enough to see what happens inside.

The forerunner of the photoelectric cell was the selenium cell. It may be recalled that selenium was discovered by the Swedish chemist Berzilius in 1817, who found it deposited in the chimneys of the sulphur plants. Selenium remained little more than a discovery until Willoughby Smith, an Englishman, attempted to use selenium in making his resistance units for trans-Atlantic cable work. In the course of his researches, Smith found that the resistance of his units varied within rather wide limits, and he was, for a long time, unable to account for the erratic and changeable nature of this element. Research finally pointed out the fact that light was the mischief maker. By closing his resistance units in light tight boxes, Smith overcame his difficulty.

Later research workers investigated the photoelectric properties of selenium and there was developed as a result of this research selenium cells which had the property of having

their resistance lowered upon being exposed to light. While modern selenium cells are rather sensitive to light changes, they are comparatively sluggish in their action and usually unsuited to meet the dizzy speeds that are necessary in television work.

In discussing further the action of the photoelectric cell, it may interest some of us to know something of the discoveries that led up to its perfection. As previously mentioned, it was

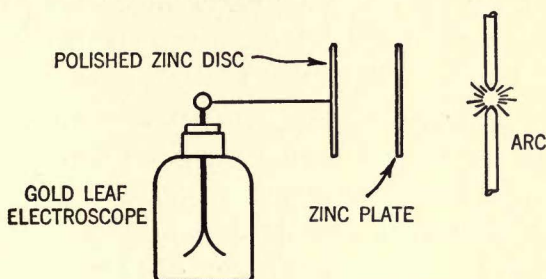

FIG. 19.—Hallwachs' first experiment. Light from an arc fell through a window in the zinc plate striking a second polished zinc plate connected to a charged electroscope. When the electroscope was positively charged, the light produced no effect. However, when the electroscope was negatively charged, the light caused the leaves in the electroscope to fall proving that the plate was losing its charge. It was these experiments that led up to the development of the photoelectric cell.

Hallwachs who first experimented with the photoelectric effect. He found that if he charged a zinc plate by connecting it to a negative potential (that is by connecting it to the negative terminal of a battery) and then exposed it to ultra-violet light, that it gradually lost its charge. When following the same process he permitted the plate to take on a positive charge. He then found that it did not lose this positive charge upon being exposed to short radiations.

In Fig. 19 we see the details of the experimental arrangements used by Hallwachs. The polished disc of zinc measured

8 cm. in diameter. In the front of this there was a second shielding plate of zinc measuring 60x70 cm. This shielding plate was provided with a window so that light from the arc light could reach the charged plate, which, incidentally was connected to a goldleaf electroscope. It was this goldleaf electroscope connected to the zinc plate that told Hallwachs what was happening. When a goldleaf electroscope is charged with electricity, the leaves repel each other and they stand out as illustrated in the diagram. When this charge leaks away, the leaves gradually assume the normal position and come together. Hallwachs found that when the plate was negatively charged, the tiny electroscope leaves repelled each other until light from the arc fell upon the plate. This caused them gradually to come together and when the experimenter observed the loss of these charges he was sure that light was bringing them about. No change was observed when the plate was positively charged.

The physics of the changes that Hallwachs noted were not easily explainable at that time. Modern physics, however, offers a ready and simple explanation to the phenomena observed and in explaining this Hallwachs effect we at the same time lay bare the secret of the modern photoelectric cell. The light, which is absorbed by photo-sensitive materials such as caesium or sodium causes the emission of electrons. The electron, it will be recalled, is a tiny particle of negative electricity. If the plate used in Hallwachs' experiments was negatively charged to begin with, these electrons were able to escape and so the plate lost its charge. When the plate was positively charged, the electrons were unable to escape because of the positive potential of the plate. It will be recalled that like charges of electricity repel each other while unlike charges attract each other. Consequently the action of the light was

not sufficient to overcome the powerful grip that the positively charged plate had upon its negative visitors.

We no longer look upon the atom as the smallest unit of matter that can exist alone. Through the researches of Thomson, Bohr, Rutherford, Millikan and Mosely we have come to look upon matter as being made up of electrical charges. The solid and eternal atoms of the earliest chemists are now be-

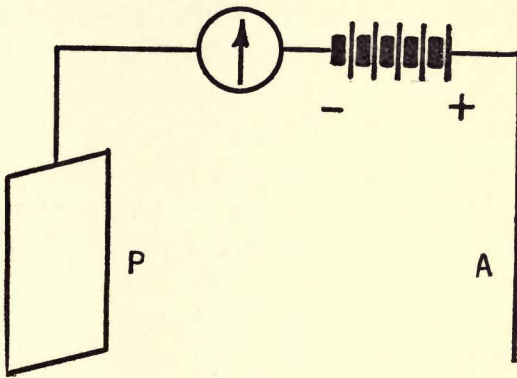

FIG. 20.—Diagrammatic representation of a photoelectric cell. The surface of P is covered with photo-active material. When light falls upon this surface, electrons are emitted and pass from P to A.

lieved to be made up of small planetary systems. In the center of these systems there is a nucleus, and rotating about it there is a number of electrons of negative "planets." The nucleus, which carries the positive charge, and which is always referred to as the proton, is made up of atoms of hydrogen packed closely together. Thus we have a bi-electrical system made up of positive and negative units, and since unlike charges of electricity attract each other we can understand the forces that hold the system together. The difference between the various kinds of matter is simply due to the different arrangements of

the electrons and protons, the atom of each element having its own particular structure.

Electric current, according to the electron theory, is looked upon as a movement of free electrons, that is wandering units of matter negatively charged and for the moment unassociated.

In Fig. 20 we have a simple representation of a photoelectric cell. Light falling upon the metal plate causes electrons to be emitted by the plate. From the diagram we shall see that the plate, which may be covered with a photo-sensitive material, is connected to the negative pole of the battery while the wire "A" is made positive. Under these conditions, an electrical field will exist between "A" and "P" and the positive charge on "A" will draw the electrons that are emitted from "P" as a result of the light across the space "A".

If "A" and "P" were enclosed in a glass cell carefully protected from the intrusion of air or foreign gases, we should have a photoelectric cell. The inside of the glass bulb of photoelectric cells is usually silvered, and contact is made with the silvered surface through the medium of a platinum flush seal. It is over the silvered surface that the cell maker lays his thin layer of lithium, sodium, potassium, rubidium or caesium. Naturally in silvering the interior of the cell, a portion is left uncoated so that light may be admitted.

Pure metals are not always used in the manufacture of photoelectric cells. Oftentimes a metallic compound is employed. Potassium hydride is one compound that has been found to be exceptionally active. This potassium hydride is formed during manufacture by admitting a low pressure of hydrogen into the cell after the potassium has been deposited and just before the cell is sealed over. The cell is then connected to a source of current and a glow discharge is permitted to pass between its anode and cathode for a period of about

fifteen minutes. This converts some of the potassium to potassium hydride.

The metal caesium is introduced in still another way. Caesium chloride and calcium filings are mixed and placed in a little metal capsule or pellet. The pellet is in turn mounted inside the cell. After the bulb has been relieved of its air content, this metallic pellet containing the mixture of calcium and caesium chloride is heated through the medium of a high-frequency induction furnace. The two chemicals in the pellet then react and pure caesium distills out into the bulb.

All photoelectric materials exhibit the same laws; that is, the current passing through the cell of which they form a part is directly proportional to the quantity of light to which the cell may be exposed, doubling the intensity of the light doubles the current, and if the distance between the light and cell is measured at the time the meter is read, it will be found that the current varies inversely as the square of the distance.

A simple calculation immediately shows that when light from a one-candlepower source at a distance of one meter falls upon one square centimeter of the photoelectric surface, each atom of that surface receives an amount of energy equivalent to 10^{-22} watt a second. The energy necessary to free a single electron is 4×10^{-19} watt per second. The fact that in order to accumulate sufficient energy at this rate light would have to fall upon the surface for a period of one hour before a single electron would be released, would seem to be a hitch in our theory. We know, however, that the photoelectric effect is instantaneous and that the electrical changes that are brought about by the action of light begin the instant that light is allowed to fall upon the photoelectric surface. This apparent discrepancy is explained away by assuming that light does not fall uniformly over the surface as would be the case if we still

persisted in accepting the validity of the old wave theory. Light is now looked upon as being concentrated in Quantum units, each one of which is able to effect the ejection of an electron.

The gas type photoelectric cells, while not as fast in their action as vacuum types, are capable of affording more current

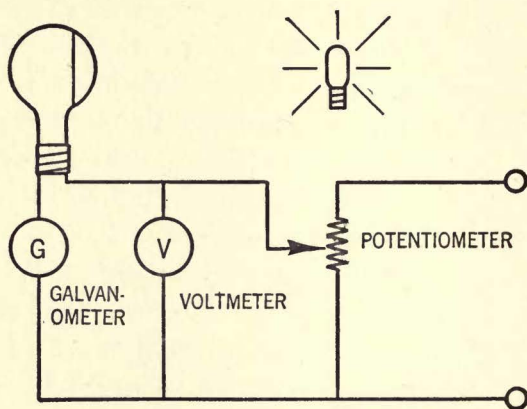

FIG. 21.—The simple circuit used to determine the volt-ampere characteristics of a cell. Such characteristics are plotted in the curves illustrated in Figs. 22 and 23. The potentiometer is naturally connected across a source of voltage, which as one of the curves shows, may go as high as 220.

output, exhibiting sort of a self-amplifying effect. Let us see if we can picture even in a crude way the happenings that take place in a cell of this type when it is submitted to the action of light. We know first that electrons are emitted from the photoelectric cell surfaces. These electrons are drawn toward the anode due to its positive potential which is maintained by a battery. In their mad dash between anode and cathode these electrons naturally collide with some of the gas molecules, for the gas, even though it may be at a pressure of only .02 millimeters, there would still be left 7×10^{14} gas molecules in each cubic centimeter of space. An electron attempting to pass

through this space would on the average make two collisions in each cm. of this path.

When an electron hits a gas molecule under these conditions, disaster overtakes the molecule. The photo electron actually knocks one of the electrons in the outermost orbit completely out of the gas molecule. The result of this is rather

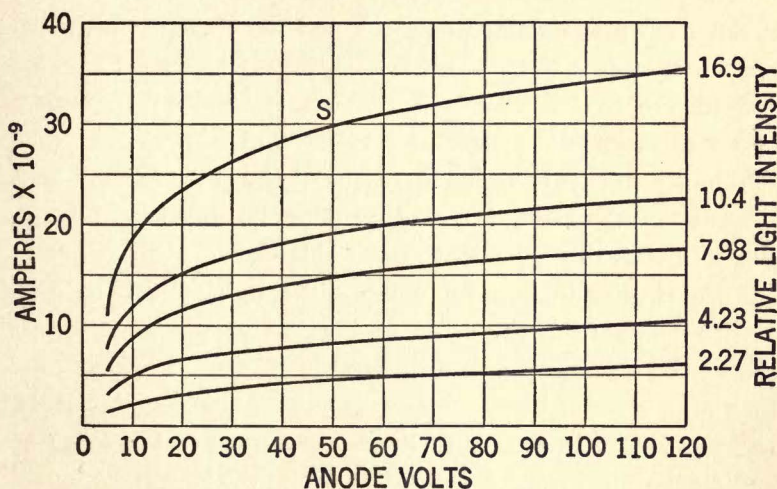

FIG. 22.—Here is a group of curves for a vacuum type photoelectric cell. This curve shows the output in current with different voltages and a uniform source of light. The anode voltage reached a maximum of 120.

interesting for we now have, instead of one electron, two free electrons and a neutral molecule.

It is the number of these free electrons driving on toward the positive terminal of a cell that determines the amount of current that the cell will permit to pass. During the remainder of the trip, the possibility of these two electrons making still more collisions is great. Thus, we have an action in the gas type cell which we do not have in the vacuum type, and, contrary to what might be supposed by the amateur physicist, no

violation of the law of the conservation of energy is brought about. The energy required is all drawn from the battery which is connected across the cell terminals. With this arrangement each original electron emitted from the photoelectric surface may be responsible for a large number of electrons arriving at the anode of the cell.

As previously stated, there is a distinct relationship between the voltage applied to a cell and the current which the cell will permit to pass. This relationship is referred to as the volt-ampere characteristic. Such data is obtained by means of the experimental apparatus illustrated at Fig. 21. In this set-up, the voltage is varied by means of the potentiometer and current through the cell is read on the galvanometer. Curves prepared with this apparatus can be obtained for different conditions of illumination by moving the light closer to and farther away from the cell. In Fig. 22 we see a group of curves for a vacuum type cell. The lower curves being those that were charted by the use of very weak illuminations. It will be obvious to those who study the curves that at low potentials the current increases rapidly with the voltage.

In Fig. 23 there is a series of curves taken by the use of a gas type cell. As the voltage is increased on these cells, the supply of ions becomes more profuse so that instead of being flat, as in the case of the vacuum cell, the curve of the current against voltage continues to rise rapidly beyond a critical point. If the voltage is increased beyond a certain point, the cell will break into a glow.

Dr. Robert C. Burt, who is, in part, responsible for the construction of photoelectric cells through electro-deposition of sodium through glass, has published the full details of the process in the *Journal* of the Optical Society of America. The apparatus that he employs, and the modest skill that is required

to control the process, brings the possibility of cell construction easily within the range of the ingenious amateur.

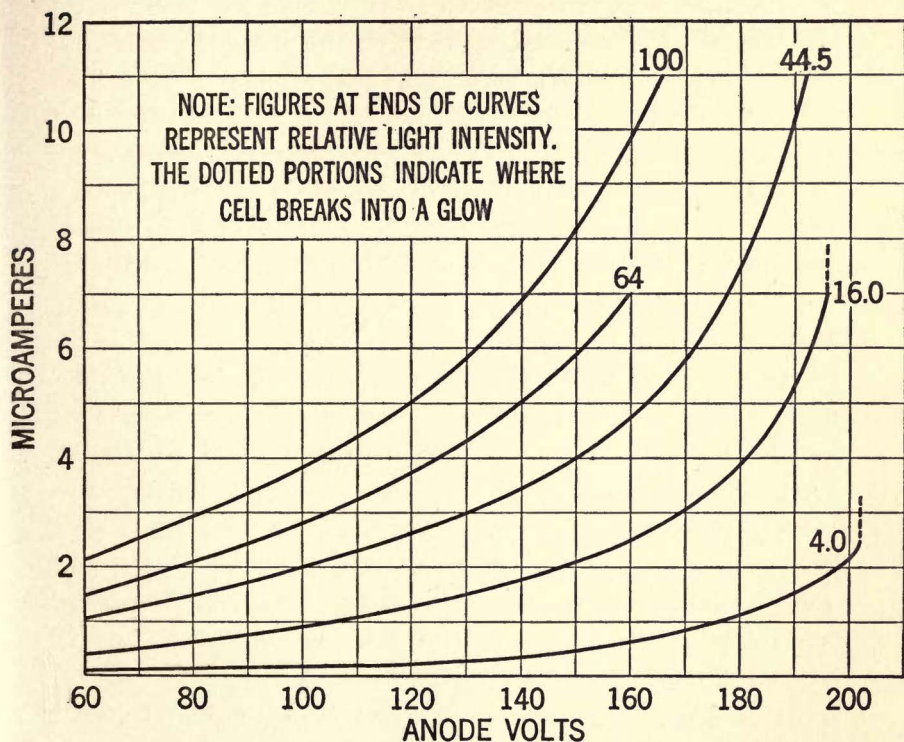

FIG. 23.—Gas-filled photoelectric cell performs differently than a vacuum type of cell. These volt-ampere curves will emphasize this fact. These curves were plotted by the aid of the apparatus illustrated in Fig. 21.

While this is true in connection with the sodium cell, the potassium hydride cell can by no means be constructed with the facilities available in the average experimenter's laboratory. Such cells require for their evacuation highly efficient mercury pumps operating through liquid air traps. This, together with the fact that the potassium, to prevent contamination, is pre-

pared by multiple distillation, makes the barriers for the amateur almost insurmountable.

With the Burt process, even glass blowing has been made unnecessary, for an ordinary 40- or 60-watt tungsten filament lamp of the 110-V type is used as the cell container, the sodium being deposited through the solid walls. Inasmuch as many of the bulbs today are made of pyrex rather than soda glass, the experimenter may have difficulty in getting a bulb of the old type. The pyrex glass does not lend itself to the treatment indicated forthwith and those desiring to construct cells are cautioned against its use. Only failure and disappointment will result.

In the Burt cell, the sodium covers the entire inside of the glass container save for a small space which is preserved as a window or light entrance. When the cell is constructed, it is obvious that some sort of a connection must be established with the sodium surface, for the ordinary electric lamp is not provided with a third wire leading out of the bulb. Consequently, unless the experimenter is equipped to evacuate a bulb after sealing in a third wire, he must enlist the services of a radio tube manufacturer or a special laboratory where such work is done. Laboratories equipped for such special work will make these connections for a small charge. This sealing in of the third wire and re-evacuation should be done before the sodium is deposited inside the tube. If the interior of the tube is reduced to atmospheric pressure after the sodium has been deposited, the cell will be hopelessly ruined owing to the contamination of the metal. Sodium in its metallic state is extremely susceptible to moisture and the first inrush of air will result in a heavy coating of sodium oxide.

The work of depositing the sodium may be proceeded with. For this it will be necessary to use a small iron crucible or pot

in which the sodium nitrate (NaNO_3) is melted. Some caution will have to be observed in reducing the sodium nitrate to a molten state. This chemical has a large thermal expansion and if the Bunsen flame is turned full on and applied directly to the bottom of the crucible, the nitrate will sputter and hot particles will be projected, which, if they land on the flesh, will cause painful burns. This trouble may be avoided if the crucible is carefully pre-heated by holding the flame at the side. After the pot becomes hot, the flame may be applied underneath. Here it might also be wise to caution the experimenter against dropping water into the molten salt.

Contrary to what might be expected by those unfamiliar with the technique of cell construction, the sodium nitrate used for this purpose does not need to be chemically pure. The high purity of the sodium deposited inside the bulb results from the electrolysis and ordinary commercial sodium nitrate is suitable for the purpose.

In Fig. 24 we see the experimental set up necessary for deposition of the sodium from the hot bath of sodium nitrate. It will be noted that the filament leads of the bulb are unsoldered from the base and that the base has been removed by heating. The bulb is arranged concentrically within the iron pot and the temperature of the molten sodium nitrate is maintained at approximately 312 deg. C. A rheostat capable of passing several amperes is connected in series with the filament of the tube and the 110-V source of the current. An ammeter is then connected between the positive side of the DC source and the molten bath.

If we examine this circuit closely and analyze its function, we shall eventually arrive at the conclusion that we have here an experimental equivalent of a vacuum tube, the molten bath or sodium nitrate performing the function of a plate.

When the filament of the lamp is brought to incandescence through the medium of the rheostat, a point will be reached where a flow of current will be registered by the milli-ammeter. This will indicate that the incandescent filament is emitting electrons. Inasmuch as the molten sodium nitrate performs the function of a plate, these emitted electrons will

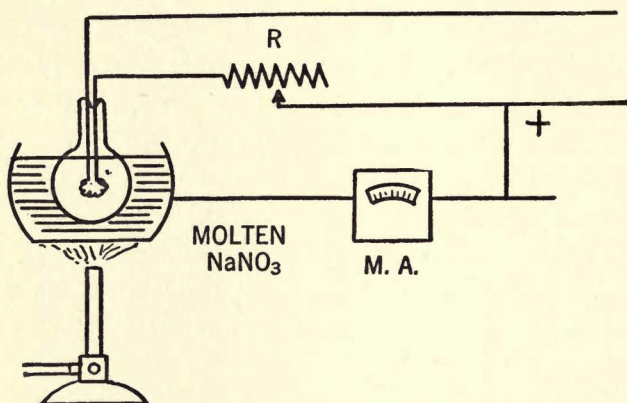

FIG. 24.—Electrolyzing sodium nitrate to deposit pure sodium upon the inside of a glass tube. It is this process that is employed in the manufacture of the Burt photoelectric cell. Such a process produces an extremely pure surface of the metal inside the cell. The milli-ammeter is included in the circuit to indicate the progress of the deposition.

be attracted to it, passing through the glass bulb, the electrons at the same time neutralizing the sodium ions in the glass. These combine to form sodium atoms which are deposited on the cooler walls of the bulb. In this way, the nitrate constantly supplies sodium ions on the inner surface of the glass where the combination takes place.

Some little time will be required for a sufficient amount of the sodium to be distilled through the glass in this fashion. It will be obvious, however, that the sodium so deposited has

a high chemical purity which is essential if it is to demonstrate the photoelectric phenomena.

The process should be continued until the entire inner surface is covered with a thin deposit.

After a sufficiently large amount of the sodium is electrolyzed in this fashion, it may be re-distilled to any part of the bulb by the application of gentle heat. If the cell is held in proximity to a flame, the sodium at this point will boil over and will redeposit itself on the cooler walls of the tube. It is in this way that the window for the entrance of the light is produced. However, it is necessary to keep the filament of the cell lighted while this is being done. Otherwise the sodium would deposit itself upon the filament which could result in the cell showing a reverse photoelectric effect.

In the experimental set just described there are several possibilities of error which are entirely avoidable by the improved circuit illustrated in Fig. 25. There is one possible source of error if one side of the filament becomes overheated by carrying excessive current. On the other hand the whole bulb may become excessively hot, causing the ionization of the sodium vapor which will take place between the ends of the filament, thereby burning it out and rendering the whole process abortive.

In the circuit shown in Fig. 25 these difficulties are overcome by arranging the incandescent lamps as series resistances; the object of this being to limit ionization currents, the electrolytic field being applied between the center of the filament and the sodium nitrate. The lamps indicated at L₁ and L₂ have a tendency to suppress the ionization currents, and the other lamps which are similar to L₁ and L₂ are connected in series with L₁ and L₆ in an attempt to find the mid-point of the filament.

By the use of this improved circuit, deposition may proceed at a much faster rate, it being possible to use currents as great as .3 of an ampere. Such a current will deposit about 300 milligrams of sodium vapor per hour when a 60-W 110-V light is used.

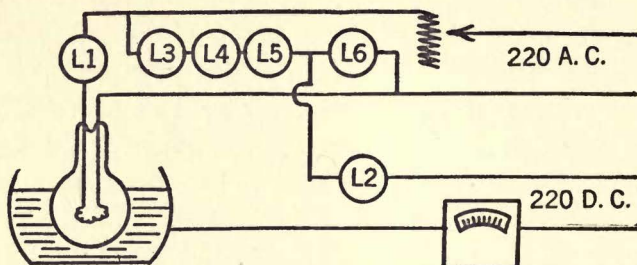

FIG. 25.—Another method of depositing sodium in the construction of photoelectric cells. The drawback of this system, as far as the amateur is concerned at least, is the necessity of having two sources of 220-volt current.

Those who may desire to construct cells in this fashion may wonder why it is not possible to apply the salts of other alkaline metals in precisely the same way. This is not possible, however, the potassium ions, for instance, being less mobile in soda glass. It is also impossible to apply lithium in this fashion.

Following is a list of the standard photoelectric cells together with data concerning their operation and general construction.

Cell: Case-Barium. Designed by T. W. Case.
Made by Case Research Laboratory,
Auburn, N. Y.

List Price: \$150.00

Size: Over-all length. $5\frac{1}{2}$ in.

Glass used: Pyrex. Base: Metal.

Light window: 1 x 1 in.

Electrode arrangement: conventional.

Cathode: Barium oxide is deposited on the inside of the glass tube, and this is "bombarded," converting the oxide to metallic barium.

Insulation: None required.

Gas atmosphere: Very high vacuum.

Design: Intended for general purposes.

Remarks: This cell is particularly adaptable for measuring light variations, i.e. daylight.

Cell: Phototron. Designed by S. Wein.
Makes: Photon Inst.
Corp. 574 S. Blvd.
New York City.

List Price: \$15.00

Size: Over-all length $6\frac{1}{8}$ in. Bulb diam. $1\frac{1}{2}$ in.

Glass used: Lime. Base: Bakelite, Radio tube type, UX prongs.

Light window: 1 in. by 2 in. approx.

Insulation: Glass skirts.

Electrode arrangement: Both centrally located, about $\frac{1}{4}$ in. separation.

Anode: Molybdenum grid of about 4 crossed wires, 1 in. by $1\frac{1}{4}$ in.

Cathode: Either sodium or potassium deposited on a nickel plate by distillation.

Gas atmosphere: Neon at 3 mm. pressure.

Remarks: Special cells made to specifications in pyrex and uvioil glass.

Cell: Visitron, No. 5. Designed by J. Kunz.
 Made by the G-M.
 Scient. Inst. Co.,
 Urbana, Ill.

List Price: \$18.00

Size: Over-all length 6 in. Bulb diam. $1\frac{3}{4}$ in.

Glass used: Pyrex. Base: Bakelite, Radio tube type, UX prongs.

Light window: 1 in.

Electrode arrangement: $\frac{7}{8}$ (distance of central anode from cathode).

Anode: Elongated hexagon of nickel, $\frac{3}{8}$ by 1 in.

Cathode: Mirror (silver) is deposited on the inside of the glass bulb and potassium hydride is crystallized thereon.

Gas atmosphere: Argon at optimum pressure for highest sensitivity and moderate glow voltage.

Remarks: Special cells made to specifications.

Cell: Burt cell. Designed by Dr. R. C. Burt.
 Made by Dr. R. C.
 Burt, 327 So.
 Michigan Ave.,
 Pasadena, Calif.

List Price: \$20.00

Glass used: "Soft glass." Base: Bakelite, Radio tube type UV prongs.

Size: Over-all $3\frac{3}{4}$ in. diam. by 6 in.

Insulation: Glass tube with guard ring.

Anode: Central anode of nickel and tungsten.

Cathode: Sodium deposited on the inside of glass bulb by osmosis (electrolysis).

Gas atmosphere: Very high vacuum.

Remarks: Special cells made to specifications.

Cell: Electric Eye. Designed by W. A. Ruggles.
Made by General Electric Co.,
Schenectady,
N. Y.

List Price: \$25.00

Size: Over-all length $5\frac{1}{2}$ in. Bulb diam. $2\frac{1}{2}$ in.

Glass used: Pyrex. Base: Standard Edison screw base.

Light window: Circular, $1\frac{3}{4}$ in. diam.

Insulation: None required.

Electrode arrangement: Central anode, $\frac{1}{8}$ in. nickel plate.

Cathode: Potassium hydride deposited on the inside of glass bulb.

Gas atmosphere: Neon at 3 mm. pressure, and high vacuum.

Remarks: Intended for general uses.

Cell: "KH" tube. Designed by M. Alexander.
Sold by Radio
Elect. Works,
150 W. 22 St.,
New York City.

List Price: \$15.00

Size: Over-all length 5 in. Bulb diam. 2 in.

Glass used: Lime. Base: Standard Edison screw base.

Light window: Circular, 1 in. diam.

Insulation: Glass sleeve over anode lead-in., nickel baffle disc.

Electrode arrangement: Central anode, 1 in. loop of .005 molybdenum wire.

Cathode: Magnesium exploded on inside of glass bulb, and potassium hydride coated thereon.

Gas atmosphere: Neon at 3 mm. pressure.

Design: For general use.

Remarks: Special cells made to specifications in pyrex and uviole glass.

Cell: Cambridge Cell. Designed by staff of experts

Made by Cambridge Inst. Co.,
3512 Grand
Cent. Term.
Bldg., New
York City.

List Price: \$50.00

Size: Over-all length 70 mm. Bulb diam. 40 mm.

Glass used: Special. Base: Metal cap.

Light window: 1 in. diam.

Electrode arrangement: Central ring-shape anode.

Cathode: Mirror (silver) is deposited on the inside of the glass bulb and potassium hydride is crystallized thereon.

Gas atmosphere: Helium at appropriate pressure.

Remarks: Cell developed and made in Clarendon Laboratory, Oxford, England.

CHAPTER V

AMPLIFYING PICTURES

Theory and Practice of the Amplification of Picture Signals Together With Data for the Construction of Television Amplifiers That Will Function With a Minimum of Picture Distortion.

AUDIO-FREQUENCY amplification is of supreme importance in television work, both at the transmitter and at the receiver. It must be evident to even the most empirical experimentalists that picture distortion may result through poor amplification just as, in the case of sound transmission, we may have sound distortion resulting from poor co-ordination and design. As a matter of fact, television picture impulses are amplified as sound, and it is only in the neon lamp where a small percentage of this energy is converted to light energy. In the amplification of these picture impulses, however, we have to deal with a problem that requires a design of audio-amplifying equipment having slightly different characteristics than those employed in ordinary radio work.

In general it might be said that an ordinary audio system with transformer-coupled stages is unsuited for television transmission at high speeds such as would be involved in the re-creation of a photographic picture illusion with fine shading effects. However, in cases where ordinary black and white effects are desired, such as the transmission of silhouettes, the frequencies of change are small enough to be accommodated

with transformer-coupled amplifiers. Consequently, for the benefit of those who are not so well versed in the principles of radio, we shall outline the details for an amplifier of this type.

Speaking in a general way, it may be said that the human ear responds to a frequency band between the limits of 25 and 18,000 vibrations per second. This frequency range, naturally, varies with individuals. Audio-frequency amplifiers of the transformer type are easily capable of passing frequencies between 40 and 10,000 cycles, providing they are well designed. Of course vacuum tubes will respond to changes far above and below these limits; it is only the transformer that stands in the way of greater range. The inability of transformers to go beyond these limits, even when well-designed, lies in a "choking effect"; an effect presenting great difficulties to engineers.

There is still another effect in audio-amplification that must be considered, both in the design of transformer-coupled amplifiers and resistance-coupled amplifiers. Reference is made to the noises that develop when too many stages of amplification are employed. These noises are an inherent property of the circuits, parasitical in nature and susceptible to amplification along with the signals which we wish to preserve in the form in which they were originally created. Due to these noises, it is impractical to carry audio-amplification beyond a certain number of stages. In the case of sound reproduction, two audio stages at the receiver is the practical limit, if disagreeable distortion is to be avoided. In general it may be said that the same principles apply to the amplification of television picture impulses. For audio-amplification involving transformers, it will be found that three stages will be sufficient, although this is even one stage more than that required for sound work. The use of three stages in television apparatus seems to be



The inside of the Alexanderson television receiver. J points out the neon tube, K the synchronous motor and L the scanning disc. A powerful audio-frequency amplifier of special design is placed in the bottom of the cabinet.

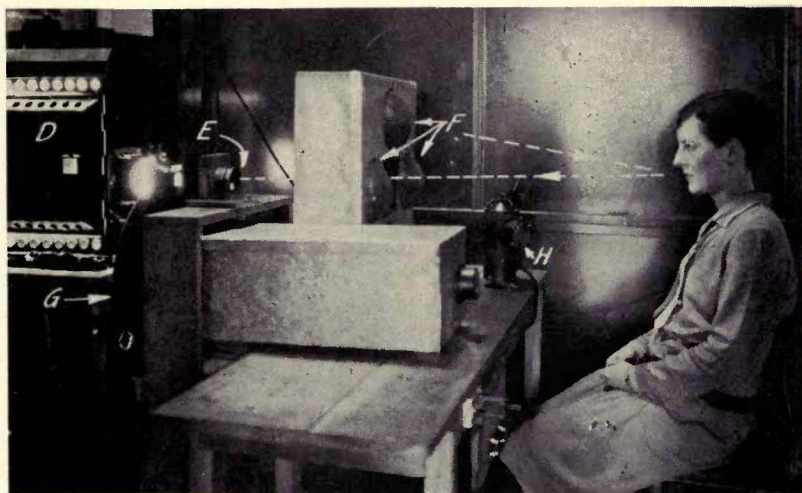

The arrangement of the scanning apparatus used at the General Electric Co., Schenectady. This is similar to the system sketched in Fig. 63. D is the light house of the arc lamp, G, the scanning disc, E the lens, F the photoelectric cell, and H the microphone. The dotted lines show the path of the scanning beam which is reflected from the face of the performer to the three sensitive photoelectric cells.

dictated by necessity, greater amplification being desirable. This seems unfortunate, for in dealing with the human organ of sight, we have to contend with a sense that is far more keen than the human ear. The eye is the principal organ of contact with the outside world, and although it may be easily victimized into illusions, it is at the same time keenly susceptible to defects, and distortion in a picture would far more easily be detected by the eye than is sound distortion in music by the ear.

The transformer selected for the low-frequency television amplifier should have a flat performance curve; which means, generally, that it should give practically uniform response in current output over a wide band of frequency range. The ideal transformer should not favor any particular sound frequency. If it did, this particular frequency would give more response than other frequencies, and if a special frequency band was involved in a certain portion of the picture, this portion of the picture would be more clearly reproduced than the other more unfortunate portions. Consequently, we would have distortion.

There is still another condition that must exercise a restraining influence on the design of proper amplifiers. We refer to audio-frequency feed-back or regeneration. When this feed-back or regeneration is present in amplifiers intended for sound reproduction, there is intermingled with any music that the amplifier may produce a persistent howl or whistle which, naturally, is a disturbing influence and destroys any real acoustical value that may be had. Practically the same is true of picture re-creation, and owing to the large number of stages of audio amplification used, the problem becomes still more aggravating; for the larger the number of stages used, the greater the tendency for audio regeneration. However, by carefully selecting our components, and arranging them in the

proper order, this audio-frequency regeneration may be entirely avoided.

If precise results are being sought, the purely mechanical problem of vibrations must also be given some attention. By this we refer to the extreme susceptibility of highly efficient audio amplifiers to vibration which may be picked up through floors and walls. As inconceivable as it might be to the layman, there is an eminent possibility of the television picture being destroyed or distorted through a person's walking across a floor. The vacuum tube is sensitive to these vibrations, due to the movements of the elements contained therein. When the elements of a vacuum tube are caused to vibrate, even slightly, current changes take place which are magnified in the subsequent stages of amplification.

This problem, however, is mechanical in its nature, and these annoying effects may be easily avoided by simple and inexpensive appurtenances. The amplifier may be mounted by suspending it with elastic bands or springs which are poor conductors of vibrations. In this way the amplifier may be isolated from its surroundings.

Even with this precaution, we are always faced with the possibility of vacuum tubes picking up vibrations from the air about them. Here again simple mechanical means may be used to avoid these effects. In this case we simply employ heavy lead caps which are placed over the tubes. These caps, owing to their weight, do not respond readily to impinging vibrations and a very beneficial damping effect is had by their use.

There is still another effect that must be guarded against, and that is the intrusion of amplified currents that may be generated by electrostatic and electromagnetic effects; we must isolate our amplifiers not only mechanically, but electrically as

well. Electrical isolation is brought about through the use of metal shields which are used to enclose the amplifying equipment. These shields may be made with either copper, aluminum, or brass, and in the average case it will be found that the shields available upon the open market will be suitable for this purpose. The more complete the shielding the greater the assurance of perfect results. The best possible procedure is that of completely shielding everything, including the "B" battery. This, however, would require the construction of an especially large shielding can. When small cans are used, leads from the battery may be brought through a hole drilled in the shield.

Those who understand the peculiarities of audio amplifiers will readily appreciate the fact that interstage shielding is advisable. By interstage shielding we refer to the isolation of each stage. Thus the first stage is separated from the second by a metal wall, and the second from the third, the connecting wires necessary between the various stages being passed through the intervening walls. This interstage shielding is further insurance against audio-frequency regeneration with its attendant troubles. If we allow audio-frequency regeneration to persist, it will be impossible to manipulate the television receiver, for the neon lamp will be forced into operation, and will remain lit as long as the regeneration lasts. Naturally, while the tube is lit under these conditions, it is impossible to modulate it with picture signals.

It will be found in general practice that when audio transformers are mounted together too closely that there will be a tendency for regeneration to develop. Consequently, whether or not the various stages of the audio-amplifier are shielded, this fact should be kept in mind.

In event that simple transmission by wire is desired say,

from one room to another, the experimenter may use a very simple audio-amplifier such as that depicted in Figure 26. This is a transformer-coupled amplifier using standard tubes. Four tubes are used, the last two being connected in parallel. The first and second tubes may be the ordinary 201-a type, while the last two in parallel of the power type similar to the 171. A selenium or photoelectric cell is used to pick up the image and is connected to the first tube or input side of the amplifier through the medium of an input transformer. This same amplifier may be used for radio as well as for wire transmission. Of course, in the case of radio, it is connected to the output of the detector and tuner, which may also involve one or more stages of radio-frequency amplification.

The resistors shown are of heavy-duty type. Ordinary grid-leak resistors made with carbon coated paper will not be able to pass the amount of current needed without becoming seriously overheated.

Resistance-coupled amplification, owing to its more or less aperiodic response, is ideally suited to the requirements of television amplification. Here again there is the necessity for maximum amplification and a minimum number of stages. There is a distinct limitation in all amplifying systems which results from the extraneous currents which are practically always present in the metallic contents of amplifying tubes. In amplification with vacuum tubes we must consider that fact that we have at our disposal a system which is keenly sensitive to extremely small effects and that any disturbing influence will be greatly magnified. The thermo agitation of the electrons in any input resistance generates such currents, and rapid variations of the number of electrons emitted from the heated filament of the amplifier tube also has a tendency to generate disturbing voltages. This is a problem, of course, that

logically brings us back to the photoelectric cell itself. If the photoelectric cell is extremely sensitive and produces a fairly large amount of current when struck with light, there is less necessity for extreme amplification. This problem also leads us back further to the source of light used to illuminate the object. The more powerful the light, the less amplification will be needed.

It is essential, in the making of an amplifier of this type, or in fact any type, to prevent such interference as may be magnified through the succeeding stages. There are four elemental sources which may cause trouble. Mechanical vibration, acoustic vibration, electrostatic induction, and the electromagnetic induction. Mechanical vibration is that disturbance or vibration which is transmitted through the building itself or through adjacent machinery. Acoustical vibration is that disturbance which is transmitted through the air and causes a vibration of the elements in the vacuum tubes which changes or modifies the tube characteristics. Electrostatic disturbances are best avoided by as complete shielding as possible, and electromagnetic induction may best be avoided by keeping the leads as short as possible, which will eliminate the loops which may form small coupling devices.

Because of the extremely small voltage received by the antenna system and the necessity of preserving the wave form as closely as possible, it has been deemed advisable to use a method of amplification which has practically a zero coefficient of coupling. The use of the CX-340 tubes in a resistance-coupled system more than compensated for the absence of the transformers. To procure the necessary amplification, experimentation proved it to be advantageous that grid resistances of as high a value as possible be used in order to avoid any material drop in voltage.

The success of a picture depends largely upon one factor, and that is the amount of picture detail that is received. This, in turn, is dependent upon the amplifier system. An amplifier of this type enables us to receive frequencies from 0 to 20,000 with an almost flat top curve characteristic which means, in effect, an almost uniform amplification covering the above frequencies.

It is a significant fact that the most successful broadcasting of television has been accomplished with the higher frequencies on low wavelengths. Baird of England originally experimented on 200 meters but now conducts his activities on 45 meters and work in our country seems to trend toward the lower wavelengths. The success of television requires an enormously large number of impulses per second. It therefore follows that the amplifier system be such as to faithfully reproduce and amplify these impulses.

A great deal of invaluable research work on the properties and characteristics of audio-frequency amplifiers, as related to the amplification of television signals both during transmission and reception, has been done by Frank Gray, J. W. Horton and R. C. Mathes engineers of the Bell Telephone Laboratories. In a paper presented at the 1927 summer convention of the American Institute of Electrical Engineers, these experimenters reported as follows:

“In the early experimental work it was soon found that in attempting to amplify the lower frequencies by the use of direct current amplifiers, unstable conditions of operation were reached before sufficient amplification was obtained to operate the receiving apparatus. Experiments were then made with resistance-condenser coupled amplifiers which showed that, if the efficiency of such an amplifier at the frequency equal to the number of pictures sent per second was not more than about

two TU * below its average efficiency for the transmitted range, acceptable reproduction of the picture was secured together with stable operation of the amplifiers. When the low

*Modern technical radio literature reveals the increasing use of the term "transmission unit." Although this term is used a great deal, as yet there has been very little written describing its meaning and the mathematical justification for its existence.

Power is the rate of doing work. For instance, work must be done to light the ordinary electric light. We say the power consumed by the light is 25 watts or 100 watts, as the case may be.

Similarly in the radio set a small amount of low-frequency power is used in the primary circuit of the first low-frequency transformer, and a much larger amount of power with the same frequency or characteristics is used in actuating the loudspeaker.

The ratio of the output power of the amplifier to the input power may be expressed as

$$\frac{P_1}{P_2}$$

There has been a decided gain in power in this amplifier. In some other system there might be a decided loss.

A method of expressing gains and losses is desirable. The transmission unit (abbreviated TU in either singular or plural) was adopted by the Bell Telephone Laboratories in 1924 for the purpose of comparing powers at two points along a system, e.g., the above amplifier. The transmission unit was so chosen that when two powers have the ratio the number of transmission units gain or attenuation (loss) equals

$$NTU = 10 \log \frac{P_2}{P_1}$$

One transmission unit represents about the least difference in the loudness which can be detected by the ear without special training.

The TU replaced the older unit called the "mile of standard cable," an arbitrary unit for measuring attenuation.

Some of the advantages of the transmission unit may be enumerated as follows:

1. It is logarithmic, and the ear also hears in proportion to the logarithm of the sound power ratio.
2. It is distortionless, whereas the "mile of standard cable" had a different effect at various frequencies.
3. It is based on a power ratio, which has an advantage in that powers may be compared, even though they are being expended in different im-

frequency cut-off of the amplifier was set much above this, spurious shadows were introduced into the picture. There will be a critical lower frequency for the transmission of an un-

pedances. Also different types of power, such as sound powers and electrical powers, can be compared.

4. It is based on a simple relation.

5. It is approximately equal, in the effect on volume, to the "mile of standard cable."

6. It is convenient for computation.

Powers are commonly measured in telephony by measuring the current (or voltage), in an impedance which is known or can be measured, so that the current and voltage relations at various points are usually known. In cases where the currents associated with the powers are proportional to the square root of the powers

$$NTU = 20 \log \frac{I_1}{I_2}$$

where

$$\frac{I_1}{I_2}$$

is the current ratio.

A table of some common ratios and the number of transmission units corresponding is appended:

TRANSMISSION UNITS	APPROXIMATE POWER RATIOS	
	<i>TU</i>	<i>For Loss</i> <i>For Gain</i>
1	.8	1.25
2	.63	1.6
3	.5	2.
4	.4	2.5
5	.32	3.2
6	.25	4.
7	.2	5.
8	.16	6.
9	.125	8.
10	.1	10.
20	.01	100.
30	.001	1000.
40	.0001	10000.
50	.00001	100000.
60	.000001	1000000.

changing scene is obvious since the Fourier series into which the signal may be analyzed starts with a constant term and the sine wave terms begin with the picture frequency and include a vast number of its harmonies. If the constant component (d-c) is removed, the lowest frequency which remains to be transmitted is therefore the picture frequency.

“The effect of removing the d-c component of the signal can be qualitatively traced in a simpler manner. Imagine three types of still pictures or scenes to be transmitted by the system. Let the first be quite dark in general effect and require fluctuations in the signal current of a certain average amount for its transmission. Such a picture would have a low direct current component. Let the second picture consist largely of medium grays and require about the same fluctuations in signal intensity for its delineation. Such a picture will have a medium direct-current component. Let the third picture be very light in general effect with such difference in light and shadow as would require the same fluctuations in signal intensity as the other two pictures. Such a picture would have a relatively high direct-current component. In passing through a resistance-condenser coupled amplifier, the signals for all three types of pictures would be changed from fluctuations superimposed upon direct current to alternating currents, all of about the same average value.

“At the receiving end of the circuit, the direct-current component may be reinserted by superimposing the alternating current fluctuations upon a fixed value of direct current such as the steady current in the last amplifier tube. This direct-current component would give the best average results if it corresponded to that suitable for the gray picture, which would, of course, then be most nearly correctly reproduced. However, most of the detail of the dark and light scenes would be re-

produced though the tone values would be distributed about in a medium gray. Fortunately a change in character of this kind has proven for the most part unimportant. Where it is important it can be taken care of very simply by providing, at the receiving end, means, either manual or automatic, for changing, in accordance with the type of scene being transmitted, the magnitude of the unidirectional current upon which the received alternating current is superposed, which amounts simply to the restoration of the direct current.

“In the case of scenes which are changing, however, frequencies lower than picture frequency will in general be generated and their suppression may be expected to affect to some degree the perfection of the picture. In effect, these frequencies are analogous to changes in tone values in the case of still pictures and their elimination results in fluctuations in the apparent brightness of the image. This effect is not disturbing with many types of subjects, as for example in the reproduction of the face.

“One remarkable result of not transmitting the direct-current component of the signal in the case of the reflected beam method of scanning is that the television transmitting apparatus can be located and operated in a well-lighted room, for if this general illumination is constant it simply increases the direct-current component of the signal. Similarly if the scene itself contains a source of steady light, this will be visible only in so far as it reflects the scanning beam.

“Turning now to the upper part of the frequency range, experimental data on the highest necessary components were obtained by the use of circuits with low-pass instead of high-pass characteristics. With the television terminal apparatus operating at 17.7 pictures per second, it was found that a filter whose phase distortion had been correct over practically all of

its pass band of 15,000 cycles produced a degradation in image quality which was just detectable when the human countenance was being transmitted. Since the electrical terminal apparatus without the filters would efficiently transmit frequencies higher than this, the experiment showed that frequencies higher than this were not present in the generated signal, that they were not effectively reproduced, or that they contribute little to the appearance of the image. This upper limit to the useful frequency range for this apparatus is rather lower than was anticipated from the initial survey, but because of psychological factors (decreased discrimination of tone values for fine details, apparent improved resolution when the subject is moving, etc.) it proves satisfactory for television purposes.

“It is of importance, however, to know where the limitation in frequency range occurs in the apparatus and how it might be modified. Considerable information on this point is obtained by studying the nature of the distortion introduced by the aperture in the optical system and that introduced by frequency limitation in the electrical part of the system. It is convenient to consider them together as the type of distortion turns out to be similar for the two cases. This distortion may be considered most simply in relation to the type of signal corresponding to a sudden unit change in tone value at some point in the subject. With an ideal television system in which the instantaneous values of signal current are at all times proportional to the tone values of the points being scanned, the resulting signal would be represented by the graph of Fig. 27. Such a consideration involves no real loss in generality as any signal shape may be considered as the result of infinitesimal abrupt changes in intensity.

“It is readily seen that if a square aperture passes with uniform velocity over a part of the picture having an abrupt

change from dark to light, the result is that we get a signal from the photoelectric cell which, instead of building up instan-

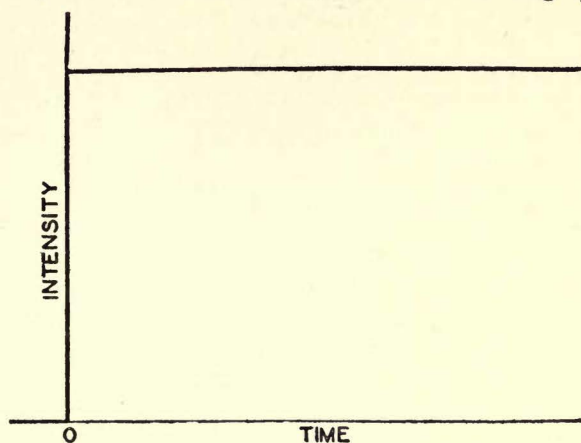

FIG. 27.—Graphic representation of an elementary signal change.

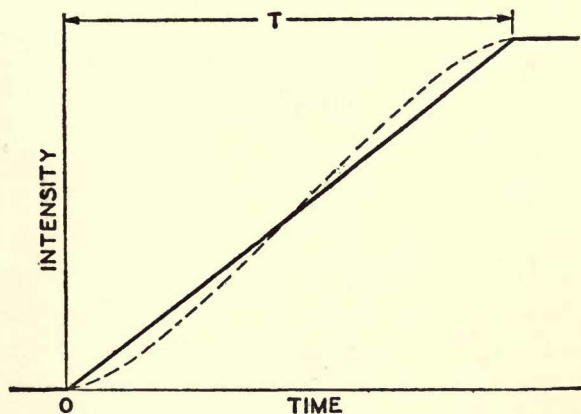

FIG. 28.—Possible distortion of an elementary signal change that might be brought about by a square aperture. (Courtesy of Bell Telephone Laboratories, Inc.)

taneously, builds up linearly during a time, T , Fig. 28, which is the time required for the aperture to pass a given point. The net effect is an apparent sluggishness in the response of

the system. The dotted curve of Figure 28 shows the integrated illumination passing through a circular aperture of a diameter corresponding to the same time, T , for the condition of Fig. 27. Due to the simpler analysis, the discussion will be carried out in terms of the square aperture though the sluggishness due to the round one is seen to be slightly less.

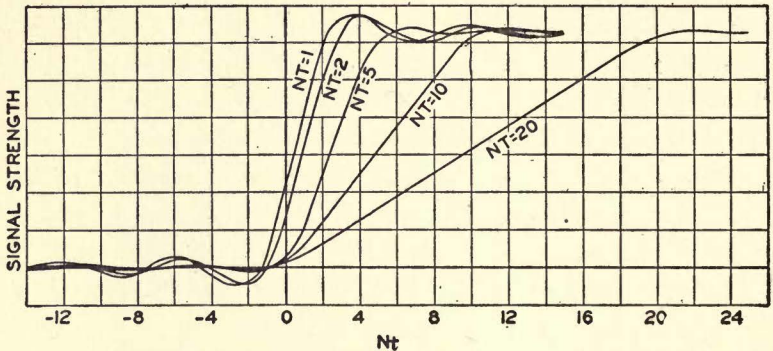

FIG. 29.—Distortion in an elementary frequency change as caused by a square aperture and ideal frequency restriction. (Courtesy Bell Telephone Laboratories, Inc.)

“Now this kind of sluggishness in response is quite similar to that introduced in the electrical part of the system when the upper frequencies are cut out or not transmitted as efficiently as the lower ones. The effect of frequency limitation can be investigated theoretically in a fairly simple fashion if we make the ideal assumption that all frequencies are transmitted without distortion up to a cut-off frequency, f_c , and extinguished beyond it. In appendix I, it is shown how the signal of Fig. 28 is affected by a frequency limitation of this type. We can then plot a set of curves as shown on Fig. 29 from which we can measure the total time of rise due to both the aperture and the frequency limitation. The abscissa is the product of

$n = 2\pi fc$ and the time, t . Any one curve serves of a wide range of values of N and T as long as their product is the same. Call the new time of rise r . Then we can plot a relation as

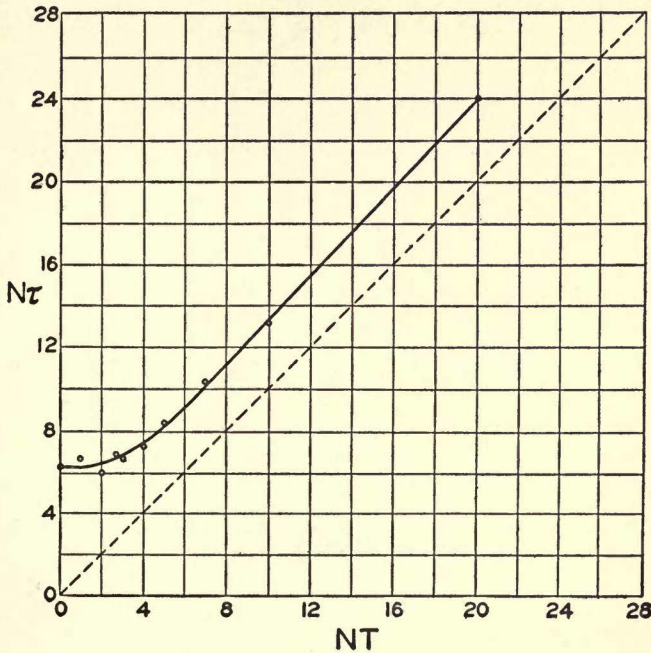

FIG. 30.—How sluggishness may be caused by distortion as a function of the aperture width and frequency restriction. (Courtesy Bell Telephone Laboratories, Inc.)

on Fig. 30 between Nt and NT from which we can draw conclusions as to the relative effects of aperture and frequency distortion.

“Below the knee of this curve we have approximately

$$N\tau = 2\pi$$

$$\tau = \frac{1}{f_c}$$

and the frequency cut-off determines the whole distortion. Similarly above the knee

$$N\tau = NT + \pi$$

$$\tau = T + \frac{1}{2f_c}$$

and the controlling influences is that of the aperture.

“Unless one effect is much more easily remedied than the other, the knee of the curve appears a reasonable point to select for operation. At the knee $NT_k = 2\pi f_c T_k = \pi$ and $T_k = \frac{1}{2}f_c$. At this point the total lag is not much greater than that due to the frequency restriction alone and is $1f_c$ or twice T_k . That is, at this point, the additional lag in the time of rise in signal due to the restricted frequency range is equal to that due originally to the aperture, though the additional lag due to the aperture is not much greater than that due to the frequency restriction alone. For a square aperture in a square picture of 2500 elements sent 16 times a second $T = 1/40,000$ of a second, and $f_c = 20,000$ cycles at the knee of the curve. The point on the curve where the effect of frequency restriction introduces a sluggishness in following light changes comparable to that introduced by a square aperture is the same frequency as that arrived as the upper limit to useful frequencies by considerations from still picture transmission. Its value is equal to one half the number of picture elements.

“It has furthermore been found possible to determine ideal electrical transmission characteristics or equivalent transfer admittances of circuits which produce exactly the same distortions as various types of apertures. While it appears impossible at present to construct a physical circuit which will produce such characteristics over the whole frequency range, the problem is not difficult if we limit ourselves to the most important fre-

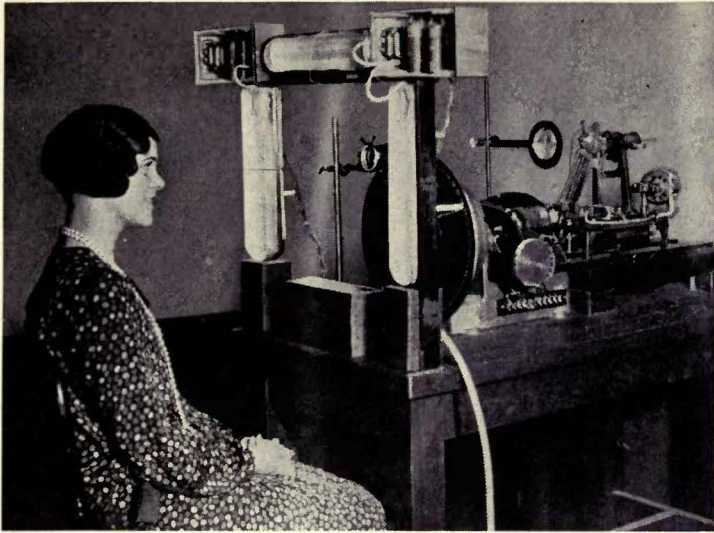

The scanning apparatus of the television transmitter designed by the engineers of the Bell Telephone Laboratories. Here a single beam is used, which after striking the face of the object or performer, as the case may be, is reflected to the three large and sensitive photoelectric cells shown mounted in the form of an arch. (Photo Courtesy Bell Telephone Laboratories, Inc.)

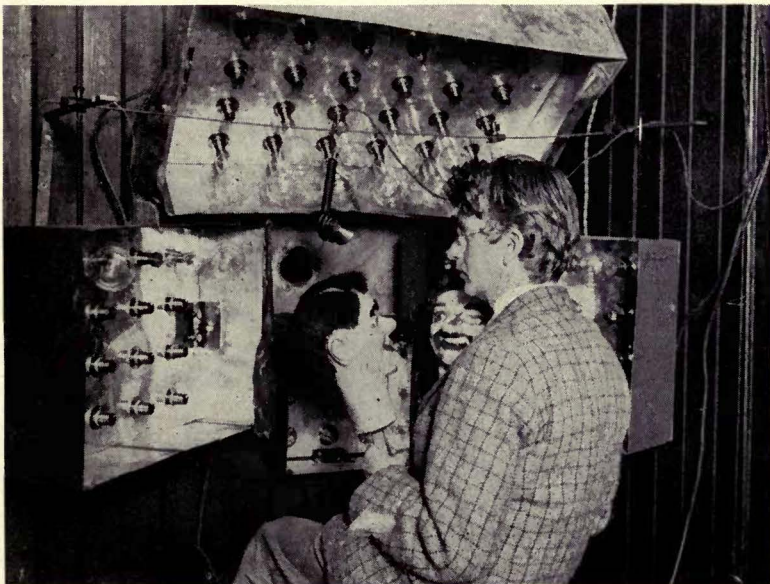

The Baird scanning mechanism. This system is similar to that illustrated in the diagram, Fig. 62. The disadvantage of this system lies in the fact that the subject has to remain exposed to a powerful source of illumination.

quency band. This is of interest as it points out the possibility of compensating for the effect of the aperture by putting in an electrical network with frequency characteristics the inverse of those so determined. Within the range of important frequencies it turns out that the effect of the aperture is the same

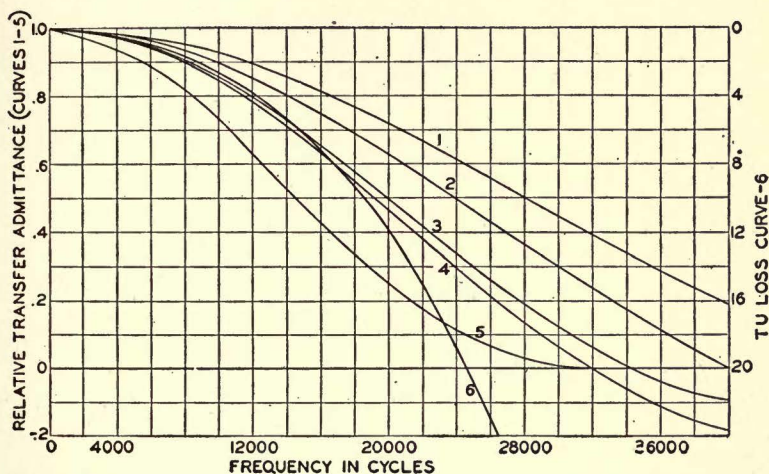

FIG. 31.—These curves illustrate in a graphic way the equivalent transfer admittance of various apertures. (Courtesy Bell Telephone Laboratories, Inc.)

as that of a network which changes merely the relative amplitudes of the frequencies into which the picture signal may be analyzed. Neglecting constant multiplying factors, the relative variation over the frequency range for a square aperture is

given by the factor $\frac{\sin T\omega/2}{\omega}$ and for a round aperture by

$\frac{J_1(T\omega/2)}{\omega}$ where, as before, T is the maximum time for the

aperture as pass a given point and J, is the Bessel's function of the first order. The derivation of these factors is given in Appendix 2. On Figure 31, Curve 1 gives the relative values of

the equivalent transfer admittance for the square aperture and Curve 2 for an inscribed circular aperture, both in case of a 50-line scanned picture which is square and sent 16 times per second. T then is equal to $1/40,000$ sec.

"In the system as set up for demonstration, the image is rectangular with the vertical and horizontal dimensions in about the ratio 5 to 4. The circular aperture is about $1\frac{1}{4}$ times $1/50$ of the vertical height and the scanning is done 17.7 times per second. T is then 3.53×10^{-5} seconds and Curve 3 gives the corresponding frequency characteristics. Curve 4 shows that a square aperture of the area as the circular aperture for Curve 3 gives a fairly good approximation to Curve 3. Curve 5 gives the combined effect of the two circular apertures, sending and receiving, corresponding to Curve 3. Curve 6 is Curve 5 plotted in terms of TU on the right hand scale.

"An inspection of this last curve indicates that this frequency attenuation characteristic of the aperture introduces a considerable loss at 15,000 cycles and leaves little of the signal components above 20,000 cycles. To see if an electrical circuit of the characteristics inverse to those of the aperture would materially improve the resolution of the image, the circuit, which, together with its frequency characteristics, is shown in Figure 32, was inserted between the sending and receiving amplifiers. To was designed to compensate for most of the aperture distortion and its phase distortion was made small below 20,000 cycles. On the fan-shaped test pattern of Figure 33, a noticeable improvement was observed the black and white angles being resolved closer to the tips of the pattern. In the case of faces the improvement appeared to be very little but could be detected in the slightly better definition of sharp narrow lines such as the frames of horn-rimmed spectacles. When a system of considerable attenuation is em-

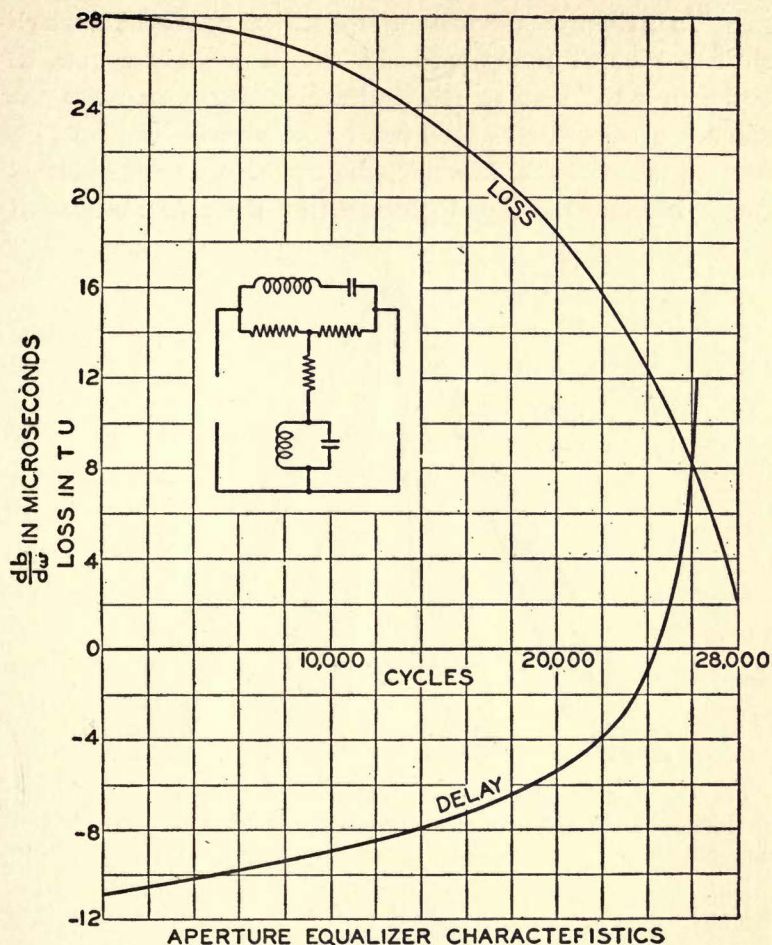

FIG. 32.—Special circuit developed for equalizing the aperture effect, its amplitude and phase characteristics. (Courtesy Bell Telephone Laboratories, Inc.)

ployed between the sending and receiving terminals, it would in general be preferable to split the equalizing between the sending and receiving ends to make the best use of the sending end power in riding over interference.

“In arriving at the amount of electrical equalization which shall be adopted in any particular case it must, of course, be borne in mind that as the aperture is made narrower the amount of distortion introduced by it becomes less. As we narrow the aperture, however, the available illumination becomes less and the signal generated by the photoelectric cell

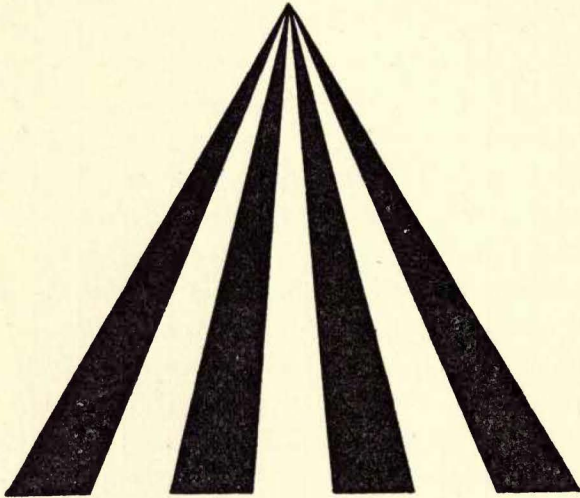

FIG. 33.—Fan-shaped test pattern used in the Bell television experimenter as a check on the quality of amplification. (Courtesy Bell Telephone Laboratories, Inc.)

becomes smaller. A limit is therefore soon reached at which the difficulties of amplification become greater than the difficulties of equalization and a minimum practical aperture width is thereby determined. If the distortion is corrected by narrowing the aperture, it is apparent that the apparatus will generate, at but little lower than the correct relative efficiency, frequencies much higher than those thought necessary. Decision as to the desirable frequency transmission band for the connect-

ing communication channel would be no different for either method of reducing the distortion due to the aperture.

“In summary, then, we may say that experiment and theory show that the lowest frequency essential to satisfactory results is the picture frequency, and the highest frequency required is approximately one half the number of picture elements scanned per second.

(b) Requirements upon the Signal Wave Set by the Characteristics of Available Transmission Channels. The limitations upon the signal wave set by present available communication channels are:

1. The magnitude of the signal necessary to override the interference to which such channels are subject.

2. The frequency range which such channels can transmit.

“In considering the frequency range of lines, it was apparent in the beginning that the wire channel might include sections of cable. With existing loading systems for such cables a frequency range of not over 40,000 cycles appeared available. The terminal apparatus was therefore designed to deliver a generated signal whose essential components lay well within the limit, and the laboratory tests mentioned in the preceding section showed that this requirement was met.

“A lower frequency limit was imposed by the necessity of a transformer for joining the transmission line to the terminal equipment. Fortunately it proved possible to design transformers as described in the final part of this paper to which this limit was at or below the essential low frequency limit found in the preceding discussion of the signal wave.

(c) Requirements which Transmission Channels Must Meet in Order to Carry Television Signals. We have shown that a certain band width of frequency components is essential to the adequate reproduction of the image. This sets the fre-

quency limits of the transmission channel which must be provided. It is essential, however, that within these transmission limits the channel should present a reasonably uniform attenuation, and that the phase relations should be fairly accurately maintained. The problem as presented to the transmission engineers of wire, radio and terminal equipment for the recent demonstration was to meet the following requirements.

“First, transmission must be provided for frequencies between about 10 cycles and 20,000 cycles.

“Second, the amplitude frequency characteristics within this range should be uniform to about ± 2 TU.

“Third, the phase shift through the range should be maintained so that the slope of its characteristic as a function of frequency is constant to ± 10 or 20 micro = seconds over all but the lowest part of the frequency range. There, about 50 times this limit was considered the maximum permissible.

“These requirements were arrived at by considerations based on theory and experiments on television and analogy to similar requirements in telephotography. The first requirement follows directly from the discussion of the essential frequencies in the signal. The following paragraphs are intended to illustrate the significance of the remaining requirements.

“As we have as yet no quantitative measure of the goodness of reproduction of the image, the matter of the second and third transmission requirements on received amplitude and phase characteristics over the frequency scale is one which had to be decided largely on the basis of the experimental results and judgment based on general considerations. We have already seen that the removal of the very lowest frequencies simply changes the tone value of the whole picture. It may be similarly reasoned that departures from the average efficiency

of transmission in the lower part of the frequency range would result in the appearance of diffuse shadows or high lights. Likewise, it may be concluded that broad deviations from the average efficiency of transmission in the uppermost part of the signal frequency range would result in the attenuation or the fading out of the finer detail of the scene. Steep slopes in the amplitude-frequency curve would result in the superposition of oscillations upon signals representing sudden changes in intensity. To reduce these effects every reasonable effort was made to keep the variations in the amplitude characteristic with frequency as slight as possible, aiming to hold these characteristics for the separate parts of the demonstration system to within ± 2 TU or better.

“In addition to transmitting the component frequencies with the same relative efficiency as regards amplitude, it is particularly essential in television to send them through the system with small relative phase shifts; that is, with constant velocity or what is equivalent, a phase shift proportional to frequency. It has long been known in optical theory that the envelope of a group of waves of nearly the same wavelength and nearly the same frequency may travel along with a “group velocity” somewhat different from the phase velocities of the component elements. If the system has but small departures from a flat amplitude-frequency characteristic and from a linear phase shift frequency characteristic, it can be shown that the time of group transmission or “envelope” delay is given by $db/d\omega^2$, the slope the curve obtained by plotting the phase shift b , for the system against the angular velocity, $\omega=2\pi f$. The time of transmission of a crest for any sine wave component was frequency $\omega/2\pi$ is, of course, given by b/ω . If $b=c\omega$, $b/\omega=c$ and $db/d\omega=c$. Then the phase and envelope times of transmission are equal and all frequencies, as well as their

group envelopes, get over in the same time. If b is given in radians, $db/d\omega$ is given in seconds. In general a knowledge of b as a function of ω is necessary and sufficient to determine the phase distortion. A knowledge of $db/d\omega$ as a function of ω is not sufficient to determine all factors in signal distortion. It is, however, often easier to measure with the needed accuracy and in transmission systems such as have been used for still pictures and television has proven a useful index of phase characteristics.

“After a preliminary estimate from experience with still

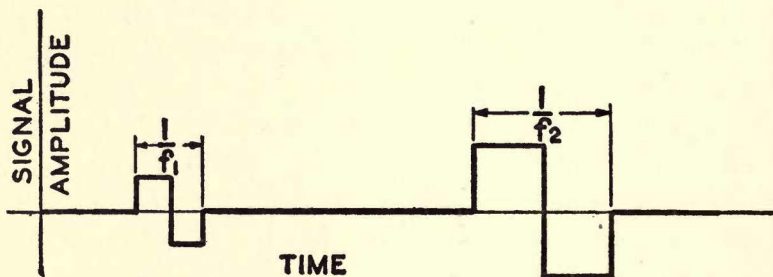

FIG. 34.—Signal detail of concentrated frequency spectrum for illustrating the effect of envelope delay. (Courtesy Bell Telephone Laboratories, Inc.)

pictures that the limit on $db/d\omega$ should be ± 10 microseconds, an electrical network consisting of five sections of a simple lattice structure was used for testing the effect of phase distortion with television apparatus. This network introduced negligible amplitude distortion and a drift in the value of $db/d\omega$ of 50 microseconds over the frequency range of 0 to 20,000 cycles. Its effect was perceptible in blurring the image of a face and it decidedly affected a sharp pattern of two parallel lines of such width and spacing as to be just within the resolving power of the apparatus. This variation of $db/d\omega$ was about $2\frac{1}{2}$ times greater than that postulated. Hence ± 10 microseconds was agreed on as a desirable limit for $db/d\omega$,

though it was felt that this limit might be exceeded by a factor of two in restricted parts of the frequency band.

“When this network was combined with a filter the slope of whose envelope delay curve was in the opposite direction so that over the greater part of the frequency range the combined delay of the two circuits was constant and equal to 140 microseconds, this time delay effect was very graphically brought out. Every time the combined circuit was cut in, the undistorted received image jumped to a new position a little over 10 per cent of the width of the picture to one side in the direction of the scanning.

“To see why $db/d\omega$ should be maintained at a constant value, consider two sharply defined details near together in the picture which would produce a variation in signal intensity with time as indicated in Figure 34. Imagine each to be cyclically continued so that the small detail defines a frequency f_1 , and the other defines a frequency f_2 . It is then known from Fourier analysis that the frequency spectra of the two details are chiefly concentrated around the frequencies f_1 and f_2 . If $db/d\omega$ is appreciably different at the frequencies f_1 and f_2 , for any part of the system, the two details will be displaced relatively to each other along the line of scanning and, in most cases, if this shift is appreciable, some change in the shape of the signal wave defining each detail results with further increase in the distortion. The same relative shift would occur if the narrow detail were located upon the broader one, in which case such a shift would be more apparent. It would seem reasonable to expect then that differences in the envelope time of transmission comparable to a whole picture element (28 microseconds on the demonstration apparatus) would be noticeable.

“In most images very few details will have signal shapes,

as in this special case, in which the frequency components are concentrated in narrow frequency bands. An abrupt change in signal strength, for instance, is represented by components distributed over the whole frequency range. We can image these frequencies divided into any arbitrary number of groups, each of which determines a wave form. When these wave forms are added together, they will reproduce the original abrupt change in signal strength. If, however, they are sent through a system in which the envelope delays for the different groups are unequal, the individual wave forms will be relatively displaced and will no longer combine correctly. As a result the image is blurred. For some types of phase distortion the effect appears as an oscillatory transient following sudden changes in intensity.

“It was furthermore found by experiment that the limit of ± 10 microseconds was not necessary for the lower frequencies. Reference to the delay characteristics of the transformers described in the latter part of this paper shows that in the lower part of the frequency scale deviations from the nearly uniform value of delay at the upper frequencies appear of magnitude greater than 100 microseconds. When the signal was sent through these transformers, however, there was no observable distortion of the image. The requirements are therefore much more lenient at the low frequencies.

“In the terminal apparatus the problem of meeting the above outlined phase transmission requirements was not a very serious one. The circuits involved are such that when a flat amplitude frequency characteristic had been secured the phase distortion was also negligible.

“The preceding sections have discussed the methods by which an object, the image of which is to be transmitted, is made to control the light variations in a light, thus giving a

luminous signal wave, and the means by which the image may be reconstructed with the aid of an electric signal wave corresponding to this initial luminous wave in its relative instantaneous amplitudes. Certain important relations between the characteristics of the signal wave and the resulting image have been pointed out. There remains the question of obtaining an electric signal wave suitable for long distance transmission and of providing for the control of the illumination at the receiving terminal by the electric signal waves as delivered by the transmission medium.

“In the use of wire lines for television it is fortunately true that a suitably prepared open-wire circuit possesses a frequency range sufficient for the transmission of all the essential components of the signal wave. Details regarding the characteristics of the wire circuits are given in a companion paper by Messrs. Gannett and Green, from whose work are obtained data essential to the design of the terminal equipment. These data fix the power level at which the signal should be delivered to the line and the power level which will be available at the receiving end. When the transmission is by radio, it is, of course, necessary to effect a frequency translation in order to secure a wave suitable for radiation and transmission through the ether. In this case, however, the radio system, which is described in a paper by Mr. E. L. Nelson, when considered as a whole may be conveniently taken as a system capable of the transmission of a signal wave occupying the same frequency as that applied to the wire circuits. In fact the design of the radio system is such that it may be used interchangeably with the wire line in as far as the remaining electrical terminal equipment is concerned.

“The terminal circuits, then, fall into two groups: first those used at the transmitting terminal for building up the wave

controlled by the time variations in light to the power level required by the line; and second, those used at the receiving terminal to bring the wave delivered by the line to the proper form for controlling the luminous sources from which the received picture is built up.

“Starting with the photoelectric cell in which the initial luminous signal wave is converted to an electric signal wave, we are interested in the magnitude of various pertinent constants. The cell may be considered for our purpose as an impedance, the value of which is determined by the quality of light reaching it. With no illumination at all this impedance is almost entirely a capacitance of the order of 10 m.m.f. When the cell is illuminated, this capacitance becomes effectively shunted by a very small conductance which is roughly proportional to the square of the voltage between electrodes. For a fixed potential, the magnitude of this conductance is nearly a linear function of the illumination. With a suitable potential in series with the cell, then, there is obtained a current the amplitude of which is proportional to the quantity of light reaching the cell.

“In order to connect the photoelectric cell to the amplifier, there is introduced in series with the cell and its polarizing battery a pure resistance the voltage drop across which is used to control the grid potential of the first tube. It is desirable, of course, to make this resistance high in order to have available as much voltage as possible. Its value is, however, limited by two considerations. The added series conductance must not be so low that it appreciably disturbs the linear relation between the illumination and total conductance of the circuit. The voltage drop must also be so small, in comparison with the total potential in the circuit, that the photoelectric cell operates at an approximately constant polarizing potential.

“In view of the extremely small voltage of the electric

signal wave as delivered by the photoelectric cell circuit, it is essential, that great care be taken to prevent such interference as may enter the initial amplifier stages from approaching a

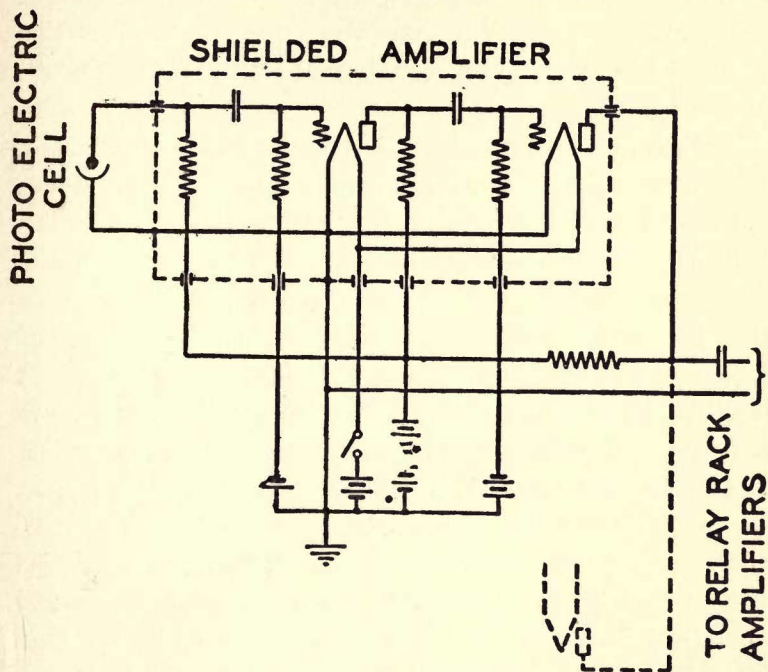

FIG. 35.—Ideal circuit of the resistance coupled type for amplification from a photoelectric cell. The dotted lines represent the copper shield about the amplifier. (Courtesy Bell Telephone Laboratories, Inc.)

comparable magnitude. The most troublesome source of interference are electrostatic induction, electromagnetic induction, mechanical vibration, and acoustic vibration. By mechanical vibration is meant the disturbances transmitted through the supports as a result of building vibrations and similar phenomena. By acoustic vibrations are meant impulses transmitted through the air which strike the several elements of the

amplifier and cause motion which results in variations in their electrical constants. Electrical disturbances are reduced to a minimum by placing the amplifier as close as possible to the photoelectric cell, thereby keeping the leads short, which avoids electrostatic pick-up and also prevents the formation of closed loops of any appreciable size, thus avoiding electromagnetic induction.

"A schematic diagram of the amplifier tubes directly associated with the photoelectric cell is given in Figure 35. Attention has already been called to the fact that the initial signal, that is, the time variation of the light reflected from the scanned object, contains a direct current component. The amplification of this direct current component is, as has been stated, out of the question in any amplifier intended for continued operation over long periods of time. The requirements as to the range of frequencies to be transmitted, as discussed in the preceding section, make it necessary to provide a circuit having practically uniform efficiency from 10 cycles to above 20 kilocycles. The relative phase shift of the several components must also be kept very small. In view of the large amplification and consequent large number of stages necessary, it has been thought impracticable to use transformer coupling between all stages as the aggregate frequency and phase distortion might well be greater than could be tolerated. The so-called resistance capacitance coupling has therefore been used.

"The arrangement of several photoelectric cells in their cabinet, is such that one amplifier can be connected directly to two of the cells leaving the third to operate a second amplifier. The outputs of these two amplifiers are then connected in parallel to the common battery supply equipment shown at the bottom of the two vertical cells.

"By the use of two stages of amplification in the photo-

electric cell amplifier, the signal is brought to such a level that it may be carried by suitably shielded leads to other amplifiers outside the photoelectric cell cabinet. This permits of using the convenient relay rack form of mounting. The signal level is, however, still low and may be adequately handled in amplifier units which differ but little from those used in the photoelectric cell.

“The remaining requirements placed on the amplifiers at the transmitting terminal are those set by the telephone line. One of primary importance is that which determines the amount of energy needed. In order that the signal wave shall be of such magnitude that any interference present in the line may be negligible in comparison, it is desired that the alternating current delivered by the final amplifier stage shall be at least 4 milliamperes into an impedance of 600 ohms. The energy to be supplied, is therefore, approximately 0.01 watt, which determines the choice of the last amplifier stage. To build up the signal to a value sufficient to operate this output tube and one stage it has been found that eight stages of the small-sized tubes and one stage of greater load-carrying capacity must be served. The total amplification given by these ten stages is approximately 130 TU. It is through this known gain of the amplifiers that we get our only accurate quantitative data as to the magnitude of the initial signal wave. This comes out to be about 10^{-15} watts or, with a 100,000-ohm resistance in series with photoelectric cell, the potential available at the first tube is roughly 10 microvolts.

“The characteristics of the line also determine the means by which it shall be coupled to the final amplifier stage. In order to secure the proper impedance matching and to prevent the line from being unbalanced with respect to ground, it was felt desirable to use transformers if possible rather than

to attempt the design of a tube circuit capable of meeting the requirements directly. The problem included both input and output transformers, and specified an amplitude frequency characteristic constant to within ± 0.5 T U from 10 cycles to 25,000 cycles. The input coils intended for use at the receiving terminal had the additional requirement that a minimum of interference current should be induced in the secondary due to potentials between the line and ground. The success with which this problem has been solved is shown by the curves in Figure 36. Curve 1 is the transmission characteristic of the output transformer which is designed to work between impedance of 2000 ohms and 600 ohms when connected between generator and load circuits having these values. Curves 2 and 3 show the effective transmission gain of transformers having voltage step-ups of 6.5 and 2.5 respectively, when used to connect the first stage of the vacuum tube amplifier to a 600-ohm generator impedance. The envelope delay curves for the output transformer and for the high ratio input transformer are given in Figure 37. A large factor in being able to get coils of this type lay in the availability of permalloy for the core material. The output transformer is connected to the amplifier through a blocking condenser in order to avoid possible saturation in the core due to the passage of direct current.

“Measurements made on the several elements of the amplifier system have shown that its over-all frequency characteristic is constant to within ± 2 T U from 10 to 20,000 cycles.

“In an amplifier having as much gain as that just described it is apparent that a slight change in the potential of the power supply will cause a considerable change in the over-all efficiency. Moreover, variations in the intensity of the light source used with the scanning system will cause corresponding changes in the intensity of the initial luminous signal

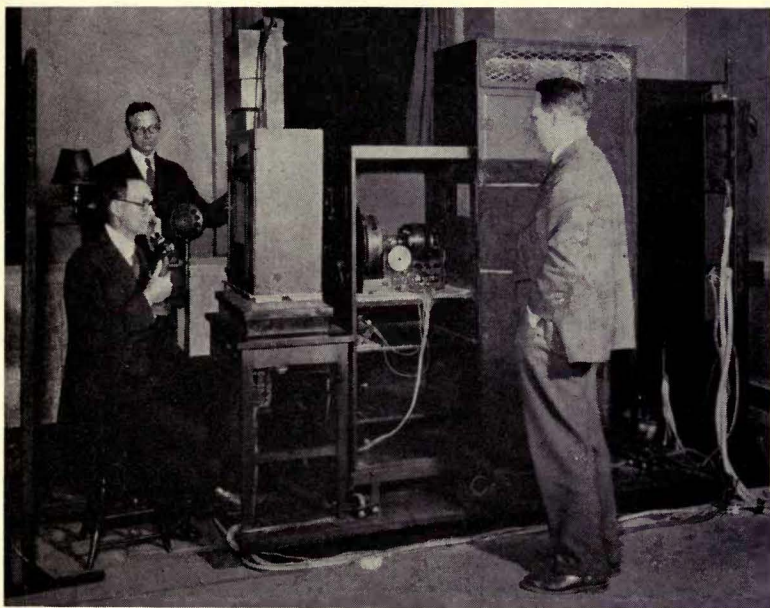

The television transmitter developed by the Bell Telephone Laboratories, Inc. This is perhaps the most perfect device of its kind in the world today. The man with the telephone sits before the scanning apparatus. Three ultra-sensitive photoelectric cells are mounted within the cabinet before him. The motor driving the scanning disc may be seen mounted in the second cabinet to the right. (Photo Courtesy Bell Telephone Laboratories, Inc.)

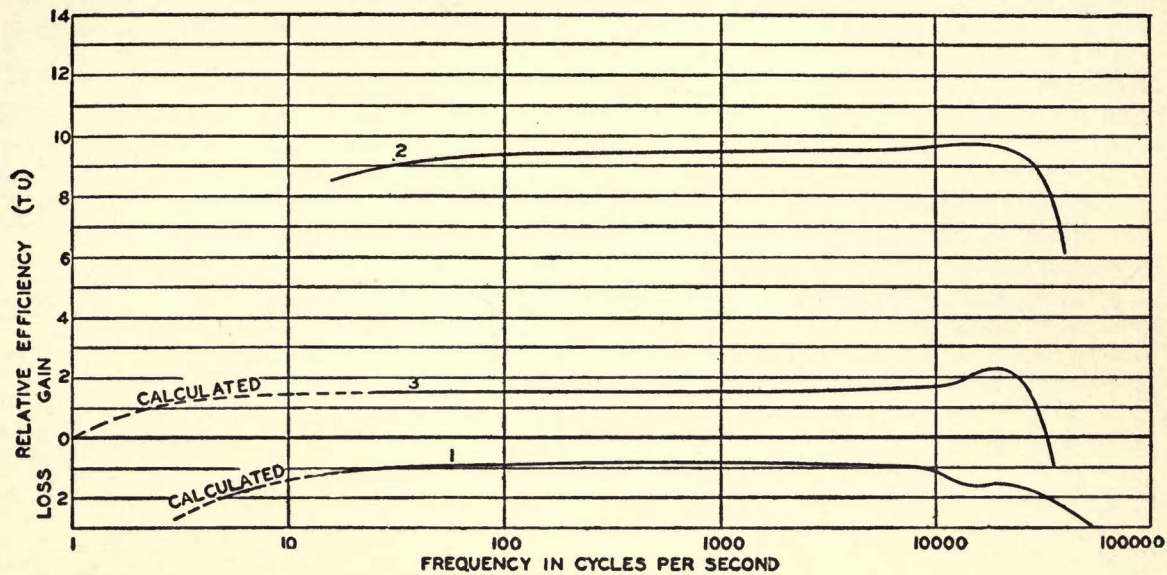

FIG. 36.—Curves showing transmitting characteristics of iron core audio-frequency transformers.

wave. To insure that the energy level supplied to the line is at all times of the proper magnitude, a level indicator has been provided to permit continuous observations of the output of the amplifier. This consists of an amplifier-rectifier circuit so arranged that the space current of the last tube is a function of the alternating current voltage impressed on the first, being

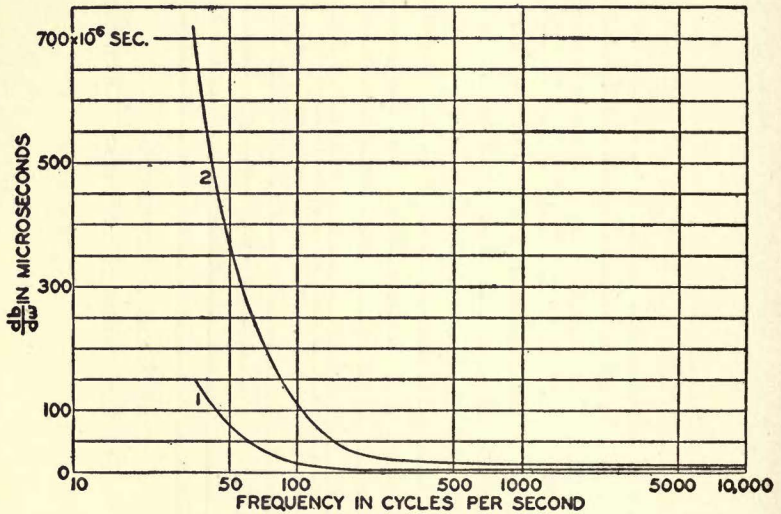

FIG. 37.—Envelope delay characteristics of (1) an output transformer and (2) a high-ratio input transformer. (Courtesy Bell Telephone Laboratories, Inc.)

roughly proportional to the square of its amplitude. By means of a direct current milli-ammeter, therefore, it is possible to keep a very accurate check on the amplitude of the signal delivered to the line.

“Coming now to the receiving terminal equipment we find that the signal wave which was delivered to the line at a power level of 10 milliwatts may, under some conditions, be reduced to a level 50 T U below this, or to 0.1 microwatt. It is, therefore necessary, first of all, to provide amplification to bring

the signal to a level where it may operate the circuits controlling the illumination from which the image is to be reconstructed. In view of the fact that several types of receiving equipment are to be operated and also because the signal may be derived from any of several sources, either wire line, radio or local transmitting station, it is desirable to fix some one energy level as a reference point and to bring all signals to this value so that they may be supplied interchangeably to the several receiving systems. A convenient reference level is that already set as the proper input to a telephone line, namely, 10 milliwatts. At the receiving terminal, therefore, amplifiers are provided that are similar to the final stages used at the transmitting terminal. These include units containing the small-sized tubes and terminate in units identical with that supplying current to the line except that the output transformer is omitted. The first stage is, as mentioned in the preceding section, connected to the line through an input transformer. The amplifiers associated with the incoming signals are each provided with a level indicator of the type already described. These terminal amplifiers and the several receiving circuits are all terminated in jacks, exactly like telephone circuits, and it is possible, therefore, to connect any receiving machine to any desired transmitting station simply by patching the proper jacks together, exactly as telephone circuits are connected at the central office.

“Before describing the final stages of the amplifier circuits it is necessary first to examine the properties of the light source which is to be controlled. In the case of the disc receiving machines described in the first section of this paper it is recalled that a single neon lamp is used having a rectangular electrode the entire area of which glows at each instant with an intensity proportional to the intensity of the initial luminous

signal. The current voltage characteristic of a typical neon lamp is given in Figure 38. It will be seen that no current flows until the voltage across the lamp reaches the breakdown potential which, in the example shown, is about 210 volts.

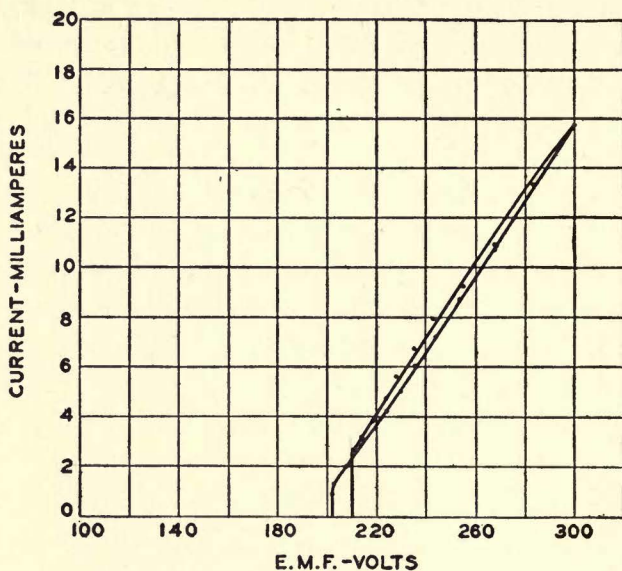

FIG. 38.—Current-voltage characteristic curve of an ordinary neon lamp similar to the types now used for television illumination. (Courtesy Bell Telephone Laboratories, Inc.)

From this point on the current increases linearly with respect to voltages in excess of a value somewhat below the breakdown point. It will also be seen from the curve that the value of current depends somewhat upon the direction in which the voltage is changing. In most cases, however, the function comes sufficiently close to being single value for our present purposes. In view of the well-established linear correspondence between the intensity of the illumination resulting from the glow discharge and the current, it is required to so arrange

the circuits that the current through the lamp is at all times proportional to the illumination at the transmitting terminal.

“It will be recalled that the electric signal wave as transmitted through the various amplifier circuits differs fundamentally from the initial luminous wave in that the direct

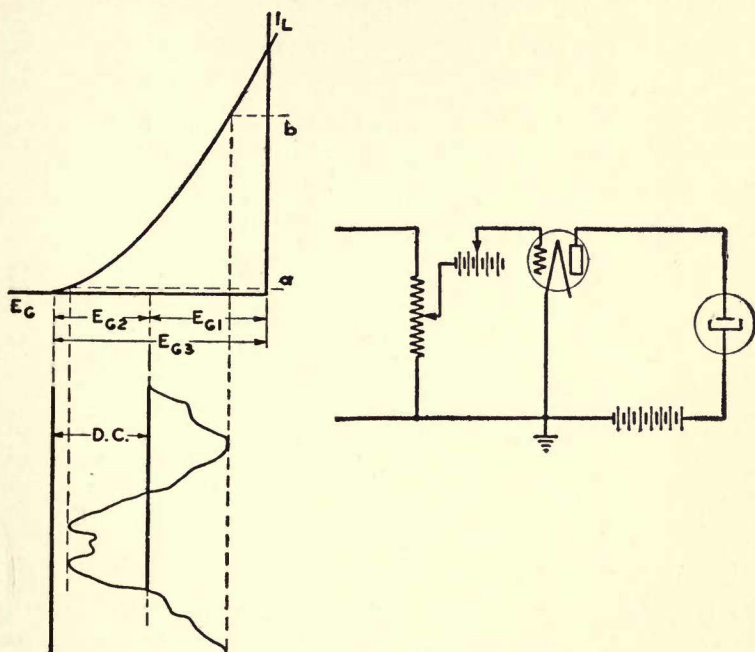

FIG. 39.—Circuit diagram and operating characteristic of a neon lamp amplifier. (Courtesy Bell Telephone Laboratories, Inc.)

current component has been eliminated. It is necessary, therefore, to restore this component before the changes in light intensity at the receiving terminal will follow those at the transmitting terminal. Several factors entering at this point may perhaps best be examined in terms of an elementary circuit such as given in Figure 39. In this case the neon lamp is connected in series with the plate circuit of a vacuum tube

and its polarizing battery. The circuit may be considered for the present as equivalent to one in which the neon tube is replaced by an ohmic resistance and in which the potential of the polarizing battery is reduced by an amount corresponding to the back e.m.f. of the lamp. Under these conditions, the relation between current—and therefore illumination—and the voltage on the grid of the vacuum tube is as shown by the curve given with the figure. This curve takes into account the change in potential between the plate and filament of the vacuum tube due to the voltage drop in the lamp resistance. If the reactances in the circuit are negligible, this curve may be taken as the dynamic characteristic of this portion of the system.

“Let us assume that to properly build up the desired image at the receiving terminal the light is to be varied between the limits set by the two horizontal lines a and b. It is apparent that two adjustments are necessary in the grid circuit. The amplitude of the impressed alternating current must be such that the difference between its positive and negative maxima is equal to the difference between the grid voltages corresponding to these currents. This is taken care of by suitable adjustments of the amplification. It is further necessary that the bias introduced by the grid polarizing battery be such that the positive and negative peaks coincide with these same values of grid voltage. Under these conditions, the grid battery must be looked upon as supplying two absolutely distinct biases, one the bias for the tube and the other the bias for the signal. For example, if the signal wave as delivered to the grid current contained the original d-c component properly amplified, it would be necessary to adjust the system so that zero current would be obtained with no impressed signal. To accomplish this the tube would require the negative grid bias E_{g3} . Variations in signal voltage would then be considered

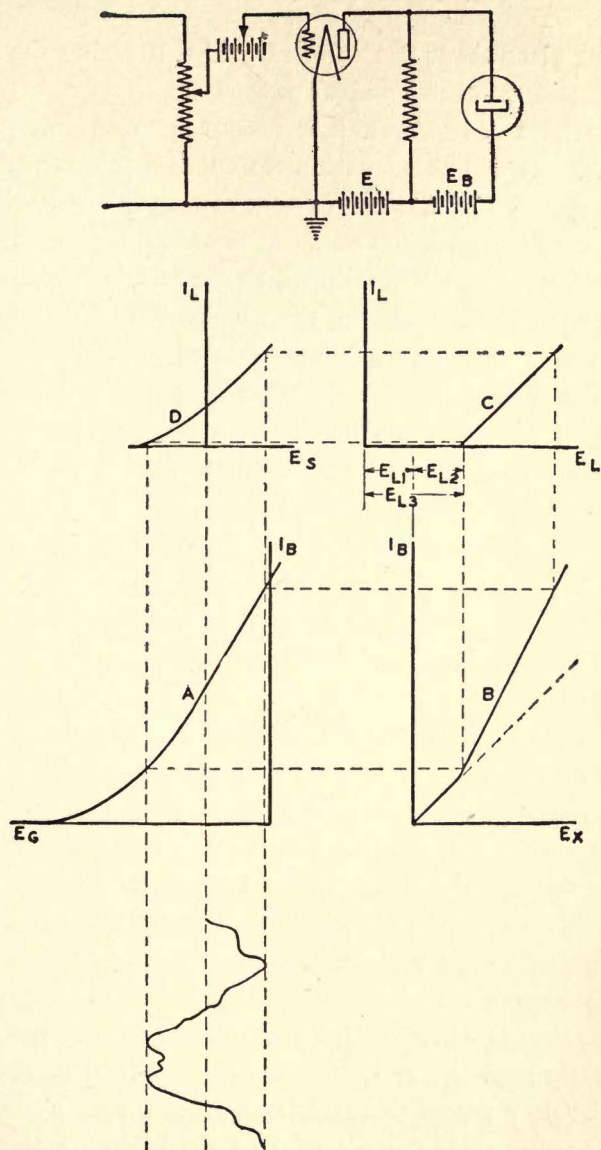

FIG. 40.—Another neon lamp circuit with curves showing operating characteristics of circuit arranged for linear operation of the lamp. (Courtesy Bell Telephone Laboratories, Inc.)

as taking place about this value of grid potential as the origin. Thus E_{g3} is the operating bias of the tube. To properly locate the signal wave, however, it is necessary to add the positive bias E_{g2} . It will be seen from the curve that this bias corresponds exactly to the direct current component which is to be restored to the signal. The sum of these two biases, obviously, give the actual bias E_{g1} , with which the tube is operated.

"In the circuit as shown, the well-known curvature of the vacuum tube prevents us from obtaining a linear relation between the current through the neon lamp and the signal voltage. This condition may be overcome by a number of circuit modifications of which that shown in Figure 40 is typical. Instead of connecting the neon lamp and the vacuum tube directly in series, a resistance is provided across which is set up a potential, E_x , proportional to the current through it. Across this resistance is shunted the neon lamp and a biasing battery, E_b . The adjustment of this circuit is indicated by the curves shown.

"Curve A expresses the relation between the grid potential of the vacuum tube and its plate current. Curve B shows the relation between this same plate current and the voltage across the external resistance. When no current is flowing through the vacuum tube, the potential of the biasing battery is insufficient to break down the neon lamp and no current flows through the circuit containing the neon lamp and the plate circuit resistance. As the current through the vacuum tube is increased from zero, the total current flowing is that through the resistance branch. When, however, the potential drop across this resistance reaches such a magnitude that, together with the potential of the biasing battery, it is sufficient to break down the neon lamp, the latter will begin to draw current which thereafter increases linearly with further

increases in the voltage, E_x , across the external resistance. The voltage across the neon lamp itself differs from that across the resistance by the amount of the battery E_b . The relation between the neon lamp current and the voltage across it, as given by Curve C, may therefore be plotted directly above the characteristic just discussed by displacing the vertical axis an amount corresponding to E_b . This amount is shown as E_{L1} . Here again we have two separate biases controlled by a single adjustment. The potential E_{L2} is fixed by the minimum plate current which can be taken from the tube without departing too seriously from the linear portion of the tube characteristic. It is, therefore, an operating bias of the circuit which is unaffected by any characteristic of the neon lamp. The latter, however, must be operated with a bias E_{L3} corresponding to its effective back e.m.f. As in the case of the grid circuit bias just considered, the bias E_{L1} actually introduced into the circuit is the difference between these two independently determined biases.

“By projecting values of lamp current horizontally and plotting their intersections with vertical projections through the corresponding grid potentials on the vacuum tube characteristic we obtain Curve D, which expresses the relation between the instantaneous value of the signal and of the current in the neon lamp as derived from the characteristics of the several elements of the circuit. Inasmuch as the intensity of the illumination is proportional to the lamp current it will be seen that we have approached the desired linear correspondence between the instantaneous values of the signal and of the light.

“It will be noted that care has to be exercised to insure that the alternating current as impressed on the last vacuum tube is of the proper polarity. If it is not, the received image will be a negative instead of a positive. This may be controlled

either by the connections to any one of the transformers or by the number of vacuum tube stages. With an even number of stages, the polarity will be reversed from that given by an odd number. This is because an increase in negative potential on the grid of a vacuum tube causes a decrease in the space current and hence a decrease of the negative potential applied to the grid of the next tube.

“In the case of the grid type of lamp with the individual external electrodes, the impedance to which the energy must be supplied differs materially from that presented by the rectangular electrode lamp already described. For low voltages, the impedance between any electrode and the central helix is effectively a capacitance of the order of 6 m.m.f. When, however, the voltage gradient in the interior of the tube becomes sufficient to break down the gas and cause a discharge to take place, the capacitance is increased to about 15 m.m.f. In fact, the tube may be looked upon as consisting of two capacitances connected in series. When the applied potential is sufficient to break down the gas and cause a glow discharge, that capacitance corresponding to the portion of the path inside the tube is effectively shunted by an ohmic resistance. The minimum discharge potential has been found to be independent of frequency over a range, but the current between electrodes is inversely proportional to the frequency because of the presence of the capacitance between the electrode and the glowing gas. Now, the brightness of the discharge is a function of the current sustaining it so that it becomes desirable to use high frequencies in order to get sufficient light without going to prohibitively high potentials. It is also desirable to operate at such a portion of the frequency scale that the percentage difference between the limits of the range shall be small, thus avoiding signal distortion due to the effect referred to above. There is,

however, a definite upper limit to the frequency beyond which it would be impossible to operate because of the stray capacitances in the cable connecting the grid to the distributor. It

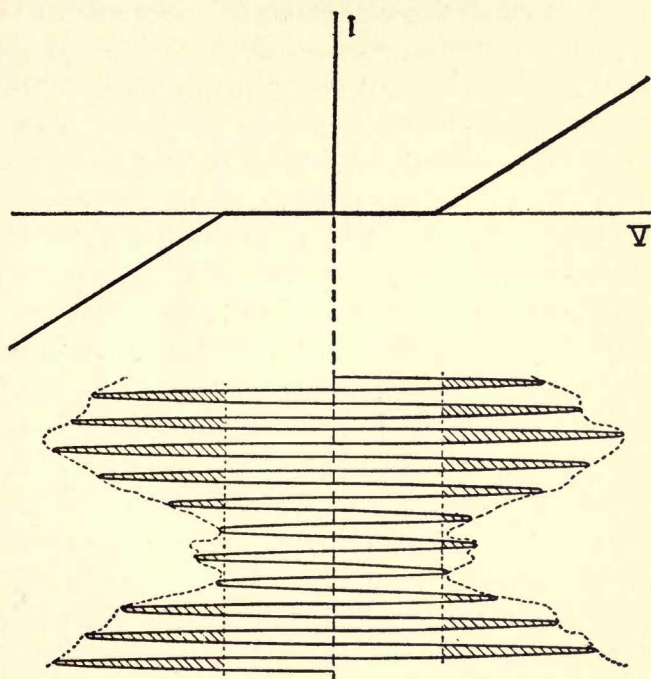

FIG. 41.—Diagrammatic representation of the relation between modulated high frequency wave impressed on grid type neon lamp and lamp characteristics. The intensity of the glow is proportional to the shaded area. (Courtesy Bell Telephone Laboratories, Inc.)

has been found feasible to operate at a frequency of the order of a half million cycles.

“The circuit problem, therefore, involves the production of a high frequency wave which varies in amplitude in accordance with the amplitude of the received picture signal. The solution has been conveniently obtained by using a radio broadcast transmitter the voice frequency circuits of which have been so

modified that the extended range of frequencies required might be handled with minimum distortion.

"The envelope of the 500-kilocycle wave modulated by the picture signal, as shown in Figure 41, is proportional to the signal amplitude plus a direct current biasing component of such magnitude that when the envelope reaches 160 volts the tube fails to light. This corresponds to a black area in the picture. When no picture signal is being received, the amplitude of the unmodulated carrier wave causes the tube to light at average brightness, corresponding to the locally introduced d-c component of the signal. It follows, then, that the amplitude of the unmodulated carrier is fixed, as in a previous example, by the joint requirement of two biases, that of the lamp and that of the signal bias.

"There is a slight distortion inherent in this method due to the fact that the light, which is proportional to the shaded area of the curve of Figure 36, is not strictly proportional to the amplitude of the envelope with respect to the 160 volt limit. This is, of course, because these peaks are portions of a sine wave and hence the time variation of the glow resulting from any given carrier cycle is a function of its amplitude. The effect is small, however, being most noticeable at low values of illumination.

"In the case of the grid-lamp receiver the signal amplitude is adjusted, as for the disk receiver, by a potentiometer in the low frequency portion of the circuit. The carrier amplitude, however, is adjusted by varying the plate potential applied to the oscillating tube. The coupling to the lamp is made by connecting the central helix and the distributor brush across a portion of the condenser of the oscillating circuit.

"The frequency amplitude relation of the envelope has been made practically constant by employing resistance capacitance

coupling in the signal input amplifiers, by providing extremely high inductance retard coils for the modulator—which is of the Heising type—and by inserting resistance in the oscillating circuit to provide sufficient damping. The relation between the original picture signal and the envelope of the high frequency wave, with respect to both amplitude and phase shift, were observed over the signal frequency range by means of a Braun tube and found to be satisfactory. The impedance of the connecting leads to the commutator was also measured and found to have a negligible effect on the frequency and damping of the oscillating circuit.

“It has been found that there may be a lag between the time when the potential is applied to an electrode and the time when the gas breaks down. This is especially true following an interval during which there has been no discharge within the tube. Because of this, those electrodes which are the first to be connected in any one of the parallel portions of the tube may fail to light. To overcome this effect a small pilot electrode is kept glowing at the left-hand end of each tube, thus irradiating the branch in such a way that the illumination of all electrodes follows immediately upon the application of potential. These pilot electrodes, which are obscured from view of the audience by the frame of the grid, are supplied by means of an auxiliary connection to the oscillator with a potential somewhat lower than that ordinarily impressed upon the picture segments.”

The diagram of an audio-frequency amplifier especially adapted for television purposes is given in Fig. 42. This involves four stages of amplification, the first three tubes being of the 240c high mu type which are best suited for resistance amplification. The last tube is a 171 power type. The following bill of materials is involved:

- 4 sockets
- 4 .1 meg. resistors
- 4 .5 “ “
- 4 .006 mica condensers
- 5 1 mfd.—400 V. by-pass condensers.
- 2 variable resistors (range from 1000 to 100,000 ohms)
- 1 automatic filament control.
- 1 baseboard.

The mechanical layout of this apparatus may follow conventional lines. As a matter of fact the apparatus involved may take the approximate positions shown in the diagram of connections.

In this particular amplifier, the current flowing through the neon tube may be regulated by means of the variable resistors which are shown in the lower right hand corner of the diagram. This should be adjusted until the flow through the neon tube is in the neighborhood of 20 milliamperes. It should be understood that the neon tube should be operated at the lowest possible current consistent with good reproduction. Overloading the tube adds little to pictorial delineation and greatly shortens the life of the tube.

CHAPTER VI

THE AGILE NEON LAMP

Theory, Operation and Practical Application of Neon Tubes in Television Reception—How the Neon Tube Functions as a "Light Loud Speaker" in Television Reception.

THE neon lamp is a device that permits us to see the picture impulses that are impressed upon the photoelectric cell at a distant television transmitter. It is called a neon lamp since it depends for its luminosity upon a comparatively minute quantity of this gas which is enclosed in a glass container. Neon is one of the rare gases that was discovered by Ramsay, along with Krypton, Xenon, Argon, and Helium. It has an atomic weight of 20.2, and is a distinguished member of the family of elements, partly because of its inert nature. By "inert" we mean that it persistently refuses to associate with other elements in establishing compound partnerships.

In the latter part of the 19th century, Geissler, a German physicist, found that certain gases became luminous when subjected to high voltages applied to the glass bulbs that contained them. Naturally, the currents had to be led into the bulbs through the agency of electrodes which were hermetically sealed in the vessel. Geissler found that the nature of the discharge, or the glow, was dependent upon a number of factors, each one of them variable and each one highly important. When a gas is exposed to this sort of electrical treatment, it

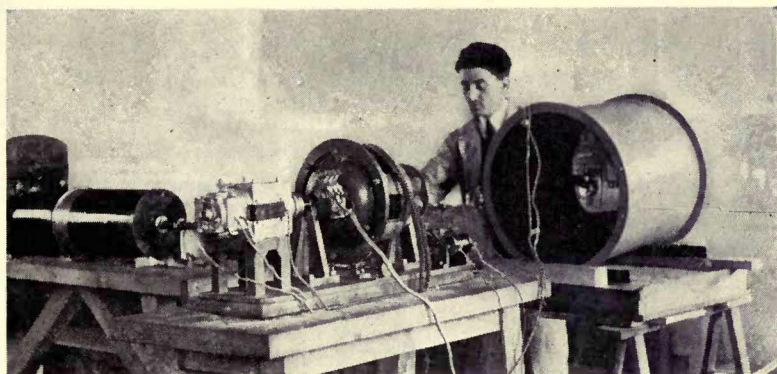

The electrical apparatus involved in the Belin-Holweck television transmitter. The photoelectric cell is mounted at the focal point of a large concave mirror which in turn is mounted at the end of the large cylinder shown. A cathode ray receiver is used in this system.

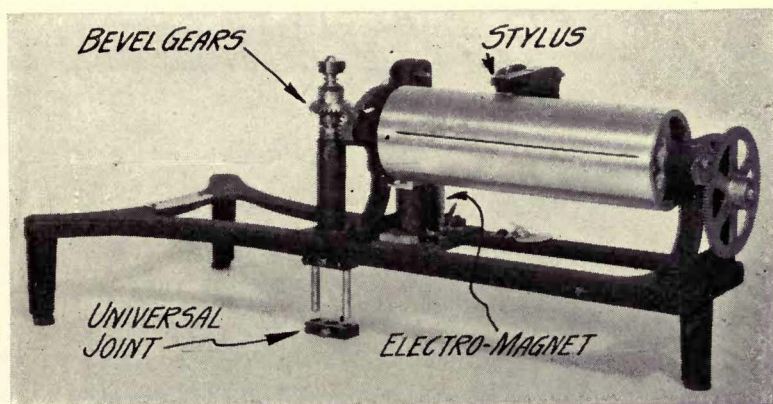

The printing drum of the Rayfoto picture receiver. The ends of the photo-sensitive paper used are pushed into the slot. The electro-magnet mounted beneath the drum is used to control the motion of the drum and to bring about synchronism between the transmitter and receiver. The high-voltage discharges take place at the point of the needle or stylus.

emits waves that corresponds with its atomic nature, producing light that occupies a certain definite portion of the spectrum. The point at which this luminosity occurs depends, firstly, upon the nature of the gas; secondly, upon its pressure and, thirdly, upon the degree of voltage applied to the electrodes; some gases requiring comparatively high voltages before they give a luminous response, and other gases requiring extremely low voltages.

Inasmuch as great difficulty is had in using a gas that requires a high voltage, it was necessary, in finding a lamp suitable for television, that the gas employed be responsive to comparatively low voltages. It was for this reason that neon was decided upon, although the nature of the light that it gives is not entirely suitable, being of a pinkish color. As a matter of fact, one of the present problems in television is that of finding a gas that will respond to low voltages and which will give a blueish-white light, having a spectrum corresponding with that of daylight.

Although neon lamps take on various forms and shapes and may be provided with electrodes of various designs, the lamp now employed in television takes on the shape of an ordinary straight tube which has sealed in it two sheet nickel electrodes, approximately $1\frac{1}{4}$ inches square. Naturally, the size and proximity of these electrodes influence what is known as the striking voltage; that is, the voltage necessary to produce a luminous discharge.

The average neon lamp will respond readily to a voltage of 160, although lamps have been produced that will give visible effects as low as 50 volts. In other words, lamps can be produced that will require 300 to 400 volts to produce the same effects. In the case of a lamp with a striking voltage of about 160 volts, it will be found that after the voltage has become

sufficient to produce the glow, the voltage may be dropped quickly to 140 before the glow will cease altogether. It will be obvious to the experimenter that where we use a neon lamp which will strike at 160 volts, that the lamp has been designed to perform at this voltage.

When employed in television, the neon lamp takes a position in the output or plate lead of the last tube of the amplifier. Briefly, it interprets or translates in terms of light the current variation in the plate circuit, responding faithfully to the impulses or light variations that are affecting the photoelectric cell at the transmitter. The electrical impulses in the plate circuit of the last tube are really applied directly across the electrodes of the neon lamp.

As the voltage of the neon lamp is raised above the striking value, the pink discharge becomes more brilliant. On the other hand, as the voltage falls, the pink discharge becomes weaker and weaker until the critical point is reached when it ceases altogether. Thus it is obvious that we can modulate the light being given forth by such a device.

Although the neon lamp is extremely alert in its response to voltage variation, it will not respond to an infinitesimally large number of fluctuations although a well designed lamp will go from full brilliancy to total darkness as many as 100,000 times a second, which is quite sufficient for experimental television purposes. When a cell is being rapidly modulated at high frequencies, the illusion produced is that of a steady uniform glow.

Those who would understand the delicate electrical laws that govern the operation of neon lamps should have some understanding of the electronic theory of matter, and especially of electronic emission as it pertains to the ordinary vacuum tube, where, when the filament temperature is raised to a cer-

tain figure by passing current through it, electrons are thrown off. These electrons are really charges of negative electricity, and when they go to form atoms, they take their position in regular orbits around the positive nucleus, or proton. This nucleus or proton gives a much greater positive charge than the independent charge of any single one of the electrons surrounding it. However, the negative electrons are proportionately more numerous; producing the interesting result that the negative charges exactly balance or neutralize the positive charges. Thus we have the system of the positive proton mothering its attendant negative electrons, the number of which varies according to the electrodes with which they are associated. In the case of the gas, neon, there are ten negative electrons revolving in regular orbits around one positive nucleus or proton.

If we could by some method detach one of these electrons from the atom of neon, or any other gas, for that matter, that is, tear the electron away from its orbit, we would produce a result that is called ionization. An ionized atom is one which has lost one of its electrons. Consequently, it is an atom that has a predominating positive charge.

Ionization may be produced in different ways. Let us picture an electron flying through space at a prodigious speed and coming in contact with another external electron attached to an atom. When these two negative particles meet, the intrusion of the free electron is repulsed by the electron in an organized gaseous atom that it happens to hit. This will be readily understood, for we are dealing with two negatively charged particles, and negative charges of electricity repel each other. This repulsion, due to the high speed of the intruding electron, may be so great as to succeed in ejecting the electron with which the intruder collides.

Inasmuch as the atom suffering this collision will lose an electron, it will become positive in its nature. But what becomes of the detached electron which was forcibly ejected by the wayward visitor? Let us, for a moment, picture it occupying a position a short distance away from its former atomic home. If it has not been jostled too far out of its original position, it will immediately be attracted back to the atom from which it came, restoring this atom to its neutral electrical

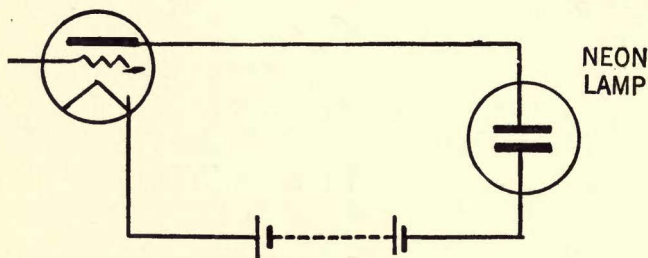

FIG. 43.—One way of connecting a neon lamp of a television receiver to the last or output tube of an amplifier. The plate voltage of the last tube should be larger than the striking voltage of the neon lamp.

condition, a process referred to as ionization followed by recombination. When this process is brought about, the atom concerned emits light. This is precisely what happens when neon is made glow within the confines of a glass container.

Every experimenter with electricity knows that when two electrodes are separated by air at atmospheric pressure, and connected to a source of high voltage, a spark will appear as the voltage is raised beyond a certain critical point. We see this phenomenon when a spark coil, such as that used for ignition purposes, is connected to a spark-cap. The discharge in the neon lamp is equivalent to a spark occurring in the gas at low pressure.

In any gas there is always a certain number of free or

homeless electrons, and when these electrons are brought into an electric field existing between two positively charged plates or electrodes, the speed of the electrons is greatly increased, and they move, en masse, toward the positive terminal. This is plain, for we know that we are dealing with negative particles and that these negative particles would naturally be attracted by the positive charge of electricity. In their mad rush toward the positive plate, many of these free electrons strike atoms with a speed sufficient to ionize them. Many of

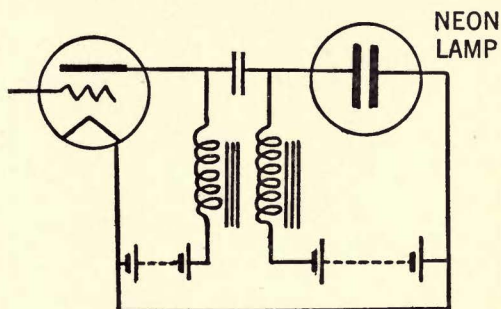

FIG. 44.—Neon lamp connected to the output circuit of vacuum tube amplifier using two impedances and two sets of B batteries.

these ejected electrons also begin to move toward the positive terminal, gathering speed and ionizing atoms in their path. From what has been said previously, we shall more readily understand the importance of the pressure of the gas as it effects the operation of the tube. When the gas pressure is higher, it means that more gas atoms will be present, together with more electrons.

The discharge will occur in the neon lamp only when the strength of the electrical field and the distance between atoms are so adjusted and regulated, that the electrons in the interval between the two encounters has time to reach speeds sufficient to ionize. Here the luminosity is governed precisely by the

distance between the electrons of the gas pressure within the lamp. The electrical field for a given voltage is greater the less the distance the electrodes. And, naturally enough, the distance between the atoms is greater the less the gas pressure. The voltage at which the discharge will begin is reduced by bringing the electrodes close together and by using a fairly low gas pressure.

When the neon lamp is viewed during discharge, the electrodes will be found to be bathed in a pinkish glow of high

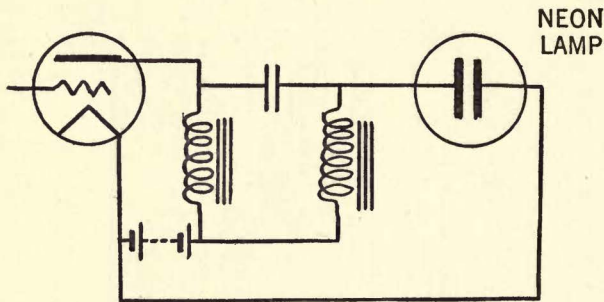

FIG. 45.—Use of two chokes and one set of B batteries in connecting a neon lamp to the output circuit of a television amplifier.

intensity, since the ionizing process is confined to the space in their immediate proximity. This is true regardless of the type of electrodes used. Some neon lamps, especially those manufactured in Great Britain, have their electrodes made of wire arranged spirally, either around a plate or with two spirals interlocked. As a matter of fact, electrodes of any shape may be employed; but, to date, two square plates are found to be most suited to television purposes.

While there are a number of manufacturers making neon tubes varying slightly in characteristics it will be found that the average has a striking voltage somewhere between 180 and 220 and that it is not advisable to pass more than 20 milli-

amperes of D.C. through them. In a tube having a dynamic resistance of about 1200 ohms, 20 milliamperes represents roughly a voltage of 200. For this reason voltages should never be placed across tubes without limiting resistances especially if the exact voltage is not known. If the voltage is too high there is danger of an arc which would permanently destroy the tube.

The neon tube will show a polarity effect and the glow may be caused to appear on either plate by reversing the terminals. For instance, if the neon tube is so mounted that the glow appears on the wrong side, the opposite plate may be made to glow by simply reversing the polarity.

Neon tubes may be connected to the output of amplifiers in various ways through the use of resistances or through the use of chokes or impedances. Several different methods are given in Figs. 43, 44, and 45.

CHAPTER VII

SELENIUM CELLS

Theory of Selenium Cells Together With a Description of the Popular Types of Cells and Practical Data Concerning Their Construction by Home Experimenters.

No discussion of the subject of television or phototelegraphy would be complete without including data on the peculiar electrical properties of selenium. As mentioned in Chapter IV, selenium was discovered by the Swedish chemist John Jacob Berzelius when working in collaboration with Gottlieb Gohn who was the first to investigate the chemical properties of this element. Nothing was known of the marvelous electrical properties of selenium until 1873 when Willoughby Smith discovered its peculiar photoelectrical properties. Smith found that selenium changed its electrical resistance to a marked degree when exposed to light. Ordinarily fused or vitreous selenium is such a bad conductor of electricity that it may be classed among the poorer insulators. In its raw, untreated state it shows a resistance of 3.8×10^{10} as great as that of copper. When properly annealed by keeping it at a temperature just below its melting point for a long period of time and permitting it to cool slightly, it assumes a crystalline condition and in this condition its electrical resistance is considerably reduced and it at the same time becomes susceptible to changes induced by light. Adams, another experimenter, found that

the change of electrical resistance varied directly as the square of the illumination. Cells using this substance have been made showing a dark resistance as low as 300 ohms and a resistance when exposed to sunlight of but 150 ohms, a reduction of 50%.

We must not make the mistake of confusing selenium cells with photoelectric cells inasmuch as we are dealing with two different effects, although it may be said, broadly speaking, that both types of cells operate on a photoelectric principle if we take photoelectric to mean the control of current by light. In the photoelectric cell we are dealing with pure electronic emission from photo-sensitive surfaces. In the selenium cell, on the other hand, we are dealing with changes in ohmic resistance brought about by light. The mechanics of this change which takes place in selenium is still more or less of a mystery although many capable experimenters have added much illuminating data to our knowledge.

The experimenter in phototelegraphy or television will do well to understand the limitations of selenium before he attempts to use it in his work, and it is the object of this Chapter to point out the difficulties and the peculiar properties of this substance. Although a carefully designed selenium cell may be employed for amateur television transmission it is not as suitable for this service as substitute for a photoelectric cell. On the other hand, there are certain phototelegraphic systems where selenium performs much more satisfactorily than pure photoelectric devices. Of course, there is the advantage of the low cost of selenium cells as compared with photoelectric cells of the more sensitive type.

Selenium cells may vary considerably in their quality and it is now possible to construct cells having approximately the same physical dimensions between 10 and 1,000,000 ohms. In every type of selenium cell there is always the variable factor

of life. Even cells made under identical conditions may show life spans of wide variations, some lasting for weeks, others for months or even years.

Every selenium cell has what is known as a lag or inertia. This lag is the time that expires between the instant that the

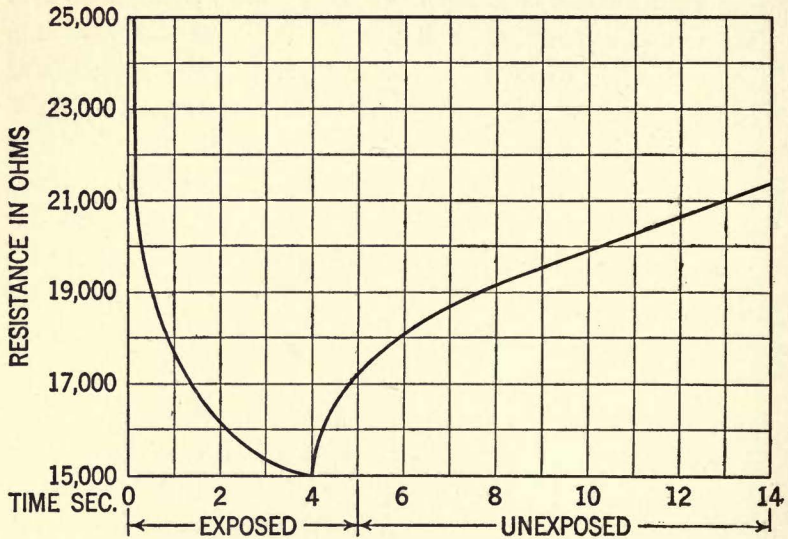

FIG. 46.—This curve was taken to show the lag of selenium in returning to its point of normal or "dark resistance" after being exposed to a source of light.

light falls upon the cell and the instant that the resistance of the cell drops in response to the light. This lag is controllable to a certain degree by the design of the cell itself and the method used in preparing the selenium. As a general rule we might say that the higher the resistance of a cell the less its inertia. It may further be claimed that the higher its resistance the greater the ratio of sensitivity. This inertia not only opposes the drop in resistance when the cell is illuminated, but it also opposes to a much greater degree the return to normal resist-

ance. An exceptionally clear analysis of this effect is shown graphically in Fig. 46. Here it will be seen that the current increases rapidly when the cell is illuminated, but that the current value, instead of returning at once to normal, only partially rises owing to the interference of the inertia effect. This time factor or variable may extend anywhere from a small fraction of a second to several minutes depending upon the particular characteristics of the cell and the intensity of the light to which it may be exposed. Naturally, in phototele-

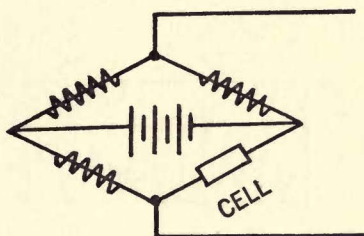

FIG. 47.—Korn method of connecting a selenium cell in one arm of a wheatstone bridge to overcome the lag of the cell.

graphic work this lag is not as important as it is in television where extremely rapid current changes are necessary to produce illusions. However, it is possible to design selenium cells so that they will act with sufficient rapidity for the instantaneous transmission of crude pictures.

Prof. Korn has devised a most ingenious way of mitigating this lag effect by making the cell form the resistance of one arm of a Wheatstone bridge, the other arms being adjusted to a resistance value somewhere in the neighborhood of the resistance of the cell. The diagram of connections for this arrangement is illustrated in Fig. 47.

The inertia effect can be reduced still further by enclosing the cell in exhausted glass tubes. This not only reduces the lag

or inertia, but also adds considerable to the life of the cell through prolonging any chemical action that may take place.

The sensitiveness of a cell is measured as the ratio between its resistance in the dark and its resistance when exposed to a source of illumination. An average cell may have a ratio between 2:1 and 3:1. However, well designed cells may have a ratio of sensitiveness as high as between 4:1 and 5:1. A cell having a resistance of 250,000 ohms can be reduced to 60,000 ohms when exposed to the light of even a low-power lamp.

At this point it might be well to mention that it is necessary

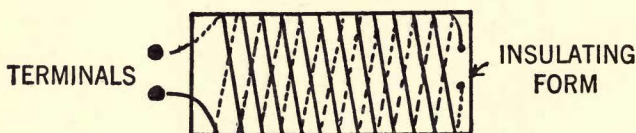

FIG. 48.—Bidwell selenium cell is constructed by winding two wires upon an insulated form. Selenium is placed between the wires.

to use some care in exposing selenium cells to continuous illumination. Under such conditions cells are permanently affected and their subsequent action becomes sluggish, the ratio between light and dark resistance falling as much as 30%. A cell responding to such conditions is said to be fatigued, and once fatigued it becomes practically valueless for either television or phototelegraphic purposes.

In the design of selenium cells that are to meet certain requirements of operation we must first consider the degree of sensitivity required and the factor of lag. We have noted heretofore that the specific electrical resistance of selenium is very high in the untreated state. Bidwell, an authority on selenium cells and their phenomena, estimated that the resistance of selenium might be placed as high as 2500 megohms per

cubic centimeter. This is a factor which must be reckoned with in the design of cells and it is obvious that the selenium must be applied in such a way and upon such a structure that only a very short path with a comparatively large cross-section be traversed by the current. It is obvious, too, that we should design the cell in such a way that the selenium be spread out

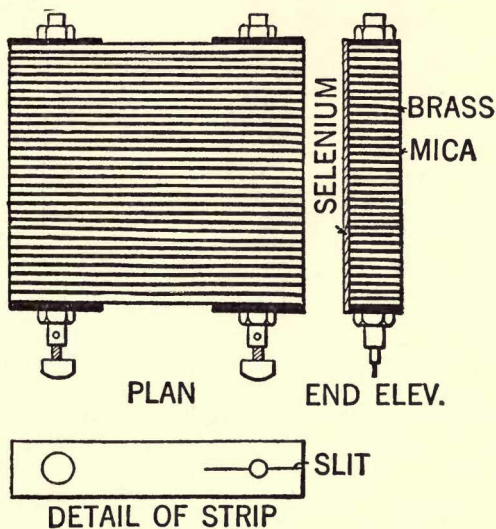

FIG. 49.—Townsend selenium shown here is made up of two separate sets of brass plates properly insulated from each other. The spaces between the plates are filled with molten selenium.

in a very thin layer so that the *ratio of surface to volume may be great*. We must keep in mind the fact that we are desirous of having light act upon as large a surface of the selenium as is practical. It is also to be noted that the thinner the film of the selenium the less the inertia of the cell.

There are at least twenty-five different types of selenium cells which have been due to the research work of as many different experimenters. Perhaps one of the simplest forms is

that due to Bidwell. Bidwell produced his cell by winding two wires upon a piece of mica in the manner shown in Fig. 48. The two wires were separated and naturally insulated from each other, the pitch of the spiral being $1/16$ inch. Selenium was spread over these wires in a manner which will be described in a subsequent part of this chapter.

A Townsend type cell is shown in Fig. 49. Here sheets of brass are separated by mica and selenium placed over the resulting surface. On examining these various types of cells

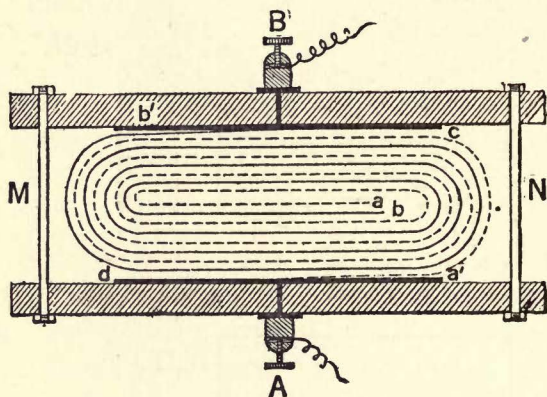

FIG. 50.—Mercadier selenium cell is made by winding together two strips of brass, the stripes being separated by a third strip of insulating material.

we will readily see that a selenium cell simply consists of two metal conductors separated and with the intervening space covered with selenium. As before stated, the space should be small.

In Fig. 50 there is a cell structure due to Mercadier. This takes the form of two brass ribbons between which there is sandwiched a ribbon of insulating material. These elements are wound up in the form shown and placed between two insulating clamps. Selenium is spread over the resulting surface.

Experimenters may use their own ingenuity in devising other means for mounting selenium.

Selenium is found among the rare minerals and is related to both sulphur and tellurium in the periodic table. The source of the metal in this country is in the anode muds of our electrolytic copper refineries. Only a few tons of it are produced each year and its retail price in large amounts ranges from \$1.60 to \$1.80 per pound. Experimenters may obtain it from any large chemical supply house and when chemically pure its price ranges as high as \$1.50 an ounce. One ounce, however, is sufficient for the construction of a number of cells.

The selenium marketed is an amorphous substance taking on the appearance of pitch. It is usually sold in sticks about $\frac{1}{2}$ inch thick and 4 inches long. Pure selenium has a boiling point of 690 degrees C. and an atomic weight of 79.2.

Assuming that a proper form has been constructed, we shall proceed with the details of the annealing process to which selenium must be subjected before it will exhibit the light-sensitive properties previously mentioned. At this point the author takes the liberty of quoting the well-known authority Samuel Wein. (See Fig. 51 for set-up of equipment.)

"After the selenium has been applied to the surface and a satisfactory coating has been obtained, it is placed in either an oven previously heated to 120 degrees C; or a plain laboratory retort stand about 16 inches high may be used. If the oven is used, the temperature will be much easier to control than with an open flame.

"In a few minutes the lustrous black surface will change to a dull gray. It is most important that the temperature be controlled at this point with great care; since the selenium will crystallize if the temperature is not high enough; if the temperature is too high, the selenium will collect in drops, being

apparently repelled from the surface of the cell. The correct temperature to anneal is slightly above its fusing point, it would be well to test this at frequent intervals with a thermometer. When a smooth surface is obtained, quickly remove the cell with a plier and let it cool. Its surface will now be smooth and lustrous.

“The brass plate being cool, the cell is again placed on this

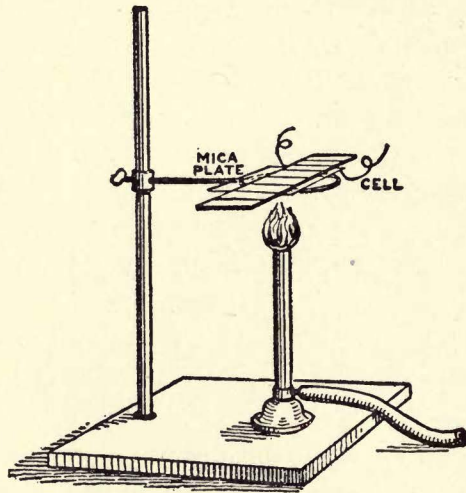
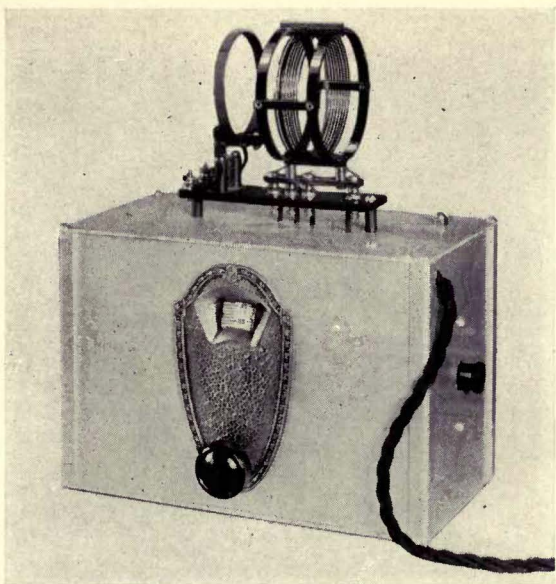
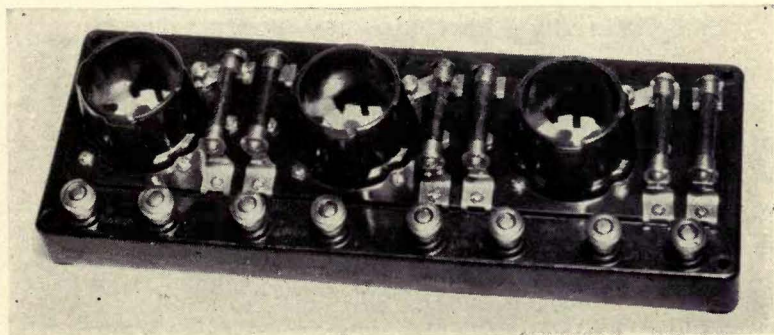

FIG. 51.—Method employed in annealing selenium used in the construction of selenium cells.

and the temperature adjusted to its lowest point. The selenium will soon begin to crystallize as evidenced by its surface assuming a dull, leaden appearance. (If crystallization has not begun in five minutes, raise the temperature a little). In from five to ten minutes the whole of the selenium should be crystallized. Then gradually raise the temperature again until signs of fusion begin to appear. This will probably take place when the flame is within three inches of the brass plate. Instantly remove the burner, and in about ten seconds re-crystallization



A short-wave tuner and oscillating detector unit arranged with demountable coils. The wave length of this tuner may be changed within wide limits by simply changing the coils. Inasmuch as television experiments have been carried on with both short and long wave lengths, such a unit will be of great service to the experimenter.



An ordinary resistance-coupled amplifier that may be employed for the amplification of picture signals. Such amplifiers are better adapted to this use than are amplifiers employing transformers as inter-stage couplers.

will occur. Now fix the Bunsen burner one-half inch below the point at which it was when fusion commenced, and allow it to remain for about four hours, merely looking at it from time to time to ascertain that, owing to increase of gas pressure or other causes, the heat has not become too great. After four hours, begin cooling by lowering the burner an inch or two, and repeat this operation every ten or fifteen minutes,

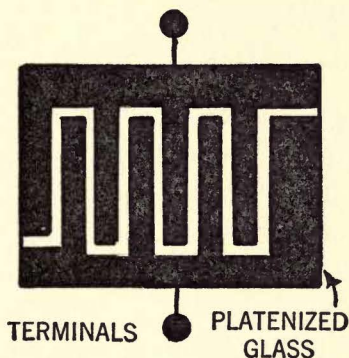

FIG. 52.—Wein selenium is constructed from a platinized piece of glass, the electrodes being formed by separation of the platinum surface into two parts. A thin film of selenium occupies the space between the two surfaces.

until the burner is at its lowest point. Then extinguish the gas, and when the cell is cool it may be used immediately.”

A very modern and highly efficient type of cell due to Wein takes the form shown in Fig. 52. In the construction of this cell a piece of glass is first covered with platinum by a chemical process. The platinum is deposited on the glass in an extremely thin layer and when this is accomplished the platinum is scratched off with a sharp pointed instrument in such a way that the platinum is divided into two sections separated by a very fine line. Selenium is then deposited chemically upon the intervening glass by the following process which is also due to the ingenious researches of Wein.

First Wein makes an enlarged drawing in the form of a zigzag such as shown in Fig. 52. This drawing is made about ten times larger than the size of the cell which is to be constructed. Considerable care must be used in making this drawing, all lines ruled perfectly and of exactly the same width. The drawing is then taken to a photo-engraver and a negative is made of the lines, the engraver being instructed to reduce it to 1/10th the size.

Next a piece of glass or porcelain is covered with a film of metal such as silver, nickel, gold or platinum, gold and platinum being preferred for the reason that they are chemically inert. The metal is deposited on the glass or porcelain by fusing one of its salts with a soft volatile solvent which is made to take the form and consistency of thin paint. This paint is applied to the glass or porcelain surface, the prepared material being then placed in a furnace. Here the temperature is gradually increased until it is high enough to make the glass plastic. At this point, the metallic salt of the metal is converted and free metal is left adhering to the soft glass. Naturally the temperature is allowed to fall gradually to avoid strains. When the glass is cold, it is sensitized on the side retaining the metal film with a coating of bichromated glue. After this preparation has dried, the glass plate is brought into contact with the photo-negative so that the ruling on the negative will take a central position on the sensitized surface. The plate is then exposed to a powerful source of actinic light. After removal, the glass plate is developed, the image being later inked in in a conventional manner. This produces a positive print on the metallic surface.

The process is continued by placing the glass plate in an etching bath made up with the proper solvent which naturally depends upon the metal employed. After the metal has been

etched out, the exposed glass is further etched with hydrofluoric acid.

The selenium is applied chemically. First a solution of 10% selenious acid is made in water and sulphur dioxide is permitted to bubble through the solution precipitating out amorphous selenium in the form of a very fine powder. The resulting powder is washed in running water and allowed to dry on filter paper. (The builder must take care to see that this powder is not exposed to any strong sources of light.) The amorphous selenium is now placed in a bottle containing a 1% solution of carbon disulphide. The resulting mixture is carefully poured over the etched surface of the metal-bearing glass, the highly volatile carbon disulphide evaporating and leaving a highly homogeneous film of selenium. After this is completed, the cell is annealed at a temperature of 180 degrees C. for a period of 12 hours. Upon the elapse of this time, the temperature is gradually permitted to decrease and when completely cool the cell is placed away for a week or ten days to age.

CHAPTER VIII

THE PROBLEM OF SCANNING

The Function of the Scanning Disc With Complete Instructions for the Design and Construction of Different Types of Scanning Devices Including Drums and Moving Belts.

A SCANNING device is one of the key components of a television transmitter and receiver. Although usually simple and inexpensive to construct, it calls for a fair degree of accuracy if picture distortion is to be minimized. It is the scanning disc that causes the beam of light to explore the picture or object to be transmitted. This is done by a succession of holes which pass before the light source, the holes being so arranged as to cause the exploring beam to sweep across the object, each time at a lower level.

Although various types of scanning devices have been developed, the most simple one is that invented by Nipkow in 1884. Nipkow used a revolving metal disc with holes arranged in a spiral. Inasmuch as this spiral must be accurately traced, if the exploring beam is to catch every detail of the object being transmitted, it behooves the experimenter to find some simple way of laying out the disc for the drilling operation. It is obvious that the average workshop is not equipped to trace spirals with a machine method.

In Figure 53 there is shown a simple and very effective way of developing the spiral which will be sufficiently accurate for all amateur work. Having determined the diameter of the

scanning disc to be used, the workman makes sure that the sheet metal that he is using is not perceptibly warped and that the exact center of the circle is found. Having done this, one line is drawn through the exact center of the disc. Next, a pro-

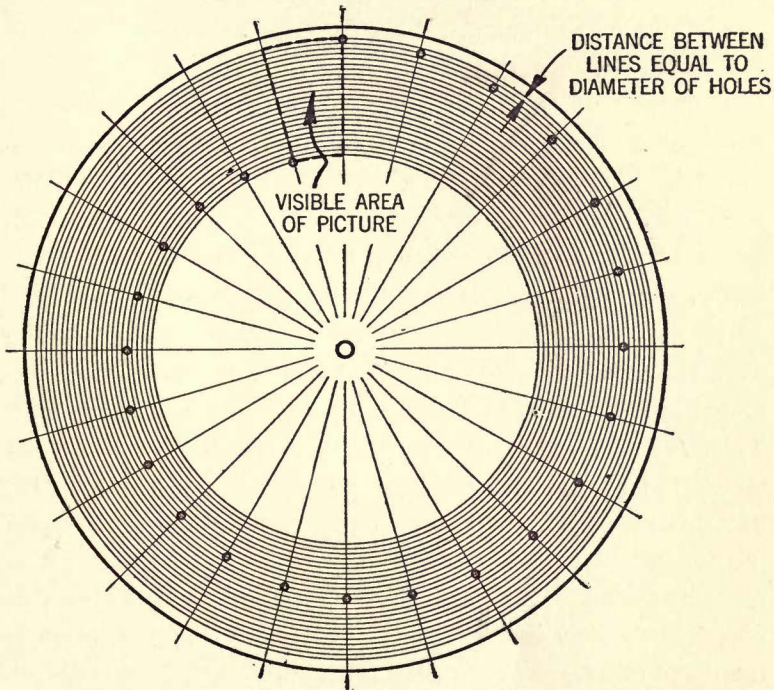

FIG. 53.—Simple way of laying out a television scanning disc for drilling. By this method the spiral automatically develops, its formation requiring no elaborate measuring instrument or involved formula.

tractor is set so that its central point rests on the center of the disc. For purposes of illustration, we shall assume that the scanning disc under discussion is to be provided with 36 holes—inasmuch as 36 is a divisor of 360, which is the number of degrees in a circle. This permits the holes to be laid out 10 degrees apart. In marking off the disc, care should be taken

that the protractor will not move and, having assured himself of this, the experimenter may proceed by the aid of a sharp prick punch to mark the disc off. In doing this it will be found advisable to lay the disc on a solid metal surface, perfectly flat, so that there will be no danger of springing the metal under the impact of the hammer blows which, although light, may cause damage.

The next chore is that of drawing 36 concentric circles with a special compass sufficiently large to accommodate the work in hand. If this compass is not available in the workshop kit, a splendid substitute can be made readily with two wooden strips screwed together at one end so that they will move freely, the opposite ends each being provided with a phonograph needle. The outermost circle is drawn first, and the distance between this circle and subsequent circles will be determined by the size of the holes to be used in the scanning disc. This, as we shall see later, depends somewhat upon the demands to be made upon the transmitter, or receiver, the degree of quality desired, the speed of the disc and the size of the picture to be handled. In this case, let us assume that a hole made by a No. 48 drill is chosen. A No. 48 drill has an actual diameter of .076 inch. It is this dimension that determines the distance between the concentric circles.

From the drawing in Figure 53 it is now obvious that the matter of laying out the holes so that they will conform to a spiral is comparatively easy. The first hole is placed at any one of the indicated lines that were drawn. The next hole is placed on the intersection where the line of the second circle passes through the line indicating the next 10 degrees. The next hole is placed on the third line down, and so on, until the mark for the last hole is completed. Each hole should be carefully marked at the intersection line with a prick punch before the

drilling is begun. As in the previous case, the metal disc should be laid on a perfectly flat surface while these markings for the drillings are being made.

The drilling will have to be done with some care, for it is essential that the holes shall not overlap to any perceptible degree, although a trifle is beneficial. When the drilling has been completed, the holes are then lightly countersunk so as to effectively remove all burrs that may have been developed dur-

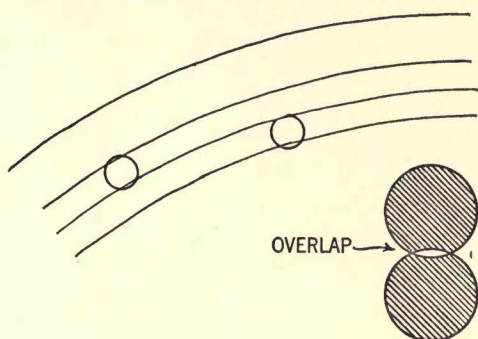

FIG. 54.—Holes in a television scanning disc should overlap slightly as illustrated in a somewhat exaggerated fashion in this diagram.

ing the drilling. If the burrs are not removed, the definition of the scanning beam will be partially destroyed and will lack that sharpness necessary for good reproduction.

Perhaps it might be advisable at this point to consider the various metals that are available for use in scanning discs. It is obvious that the metal must be thick enough to hold its shape, and that it should exhibit no tendency to warp. Aluminum, due to its light weight and its desirable physical properties, is perhaps the most acceptable of all the metals that could be used. It is easy to drill and machine and, owing to its light weight, it is least affected by the high peripheral speeds necessary in scanning work. Thin sheets of metal with a slight

warp in them will have a tendency to flatten out when revolving at the speed necessary for television work. Of course it is much better to use a thicker piece of metal that will be perfectly flat. For rough experimental work, however, it is entirely feasible to employ a good, stiff piece of cardboard, providing care is exercised in arranging the holes accurately.

Having acquainted ourselves with the mechanical operations necessary for the production of the scanning disc, we are now ready to review the factors determining the physical dimensions of the disc and the laying out of the holes. It is evident that the larger the number of holes on the disc, the greater the tendency toward better reproduction.

The number of holes in the disc determine the number of sections or lines into which the picture is divided. Thirty-six holes would simply mean that the picture was divided into 36 sections or lines, and it must be clear that the larger the number of holes the more detail will be produced. Ten holes would produce a very crude picture.

What actually determines the size of the picture that can be transmitted is the distance between the holes, as well as the size and number of the holes. This becomes clear upon reference to Figure 53. From this drawing it will also be plain that the size of the picture must be adjusted so that only one hole is sweeping across it at one time. Simple arithmetic will show that the scanning disc is more or less limited in its application, and that home experimenters cannot hope to transmit very large pictures with any great detail. A photograph measuring 4 by 5 inches, for instance, would require a scanning disc in the neighborhood of 10 feet in diameter. From this it is obvious that beginners with modest equipment should be satisfied with the transmission of small objects.

Although discs provide what is perhaps the best known

method of illuminating objects to be transmitted, there are several other methods that have been applied successfully and which lend themselves to experimental research. Figure 55 shows how a moving belt, which may be of very thin metal, can be applied to the problem of scanning. Here the holes are

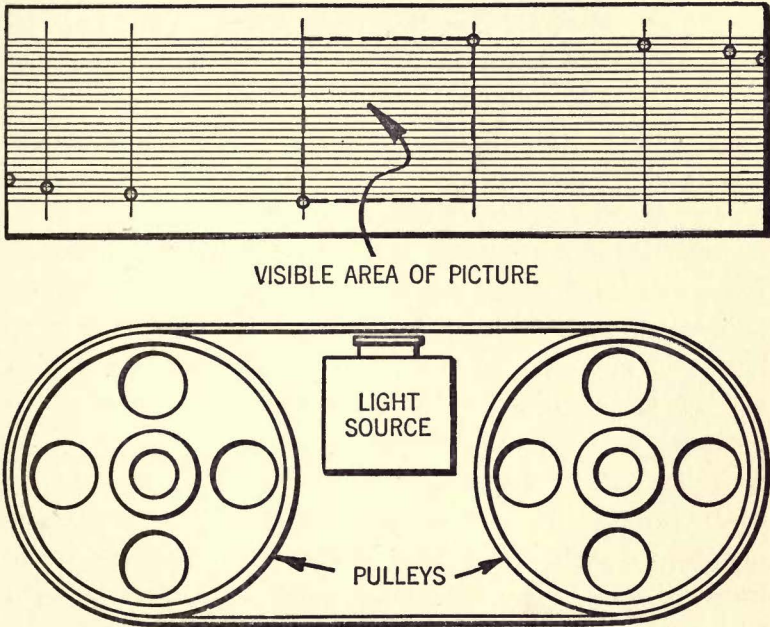

FIG. 55.—How scanning may be provided with a belt. The holes, in place of being drilled in spiral fashion, are simply drilled along the line of an angle.

arranged diagonally, producing the equivalent of a spiral. In this instance, the size of the picture is determined by the distance between two successive holes and the width of the belt.

A still further application of the belt, and perhaps a more suitable arrangement, takes the form of a drum. C. Francis Jenkins, who has been one of the pioneers in television development, was perhaps the first to turn to the use of the simple

drum as a scanning device, and is perhaps easier to construct and less difficult to operate. Indeed, the ingenious experimenter can easily adapt such homely devices as tin cans and aluminum pots to this use.

In applying the drum to scanning, great care must be exercised to see that the drum revolves accurately. When thin metals are employed for this purpose the drum must be mounted especially accurately, since they will be pulled out of shape, due to the rather high speed of the motor.

The all-important thing that must be considered in the design of television scanning discs is the number of separate units into which we desire to divide our picture. If a photographic reproduction in a newspaper is observed very closely it will be found that it has, in the process of plate making, been divided up into a large number of tiny dots. It will be clear that the larger the number of dots the more perfect the reproduction will be. On the other hand, in the case of television, the larger the number of picture units or dots that the picture is divided into, the greater the frequency of the impulses impressed upon the transmitter and receiver. In the case of still picture transmission, the American Telephone and Telegraph Company in transmitting a 5 by 7 photograph divides it into the equivalent of 10,000 units per square inch, or 350,000 units in the entire picture. About seven minutes is required to transmit such a picture. The time limit here is large compared with the prodigious speed that must be reached to transmit moving objects. If a moving picture having the same fineness of grain were to be transmitted, a complete picture instead of occupying seven minutes would have to be scanned in the 16th of a second. This, in turn, would mean that the transmission frequency range would be nearly 7000 times as great requiring an almost inconceivable band 3,000,000 cycles wide. The at-

tainment of this is obviously impossible, to say nothing of the mechanical difficulties involved in the perfection of a scanning disc would meet these requirements.

There is still a further requirement that would also have to be brought into the calculation. A complete television signal will consist of all frequencies up to the highest discussed and down to zero, the zero portion being equivalent to a total light or dark spot occupying the width of the object to be transmitted. Such spots would form direct current components with an extremely low frequency of change. When a complicated portion of a picture containing a variety of shades was in the process of being scanned, we can readily understand that the changes in light value, and consequently the changes in frequency, would be at maximum. Of course, every picture or every object would have an equivalent in frequency changes depending upon its complication.

We shall obtain a much clearer insight into this problem of scanning by analyzing a comparatively simple case. Let us assume that we have a scanning disc with only 16 holes arranged in a spiral and that the scanning disc is revolving at the rate of 16 times a second. Such a disc could by no means provide clear reproduction at the receiving end except in the case of transmitting extremely crude objects, having only a single shade. If the disc has but 16 holes and revolves only 16 times a second the result can be illustrated graphically as shown in Fig. 56. The picture would be made up, as a result, of only 256 units, which is equivalent to 16^2 . If the disc had 50 holes instead of 16 we should, it is clear, obtain a much better reproduction, for in such a case we would multiply 16, which is the number of revolutions per second being made by the scanning disc, by 50, giving a product of 800. In such a case our picture would be broken up into 800 units in place of 256.

This analysis can be carried further and can be made more instructive from the standpoint of the layman by assuming that we desire to transmit a simple black cross. If this cross were laid out graphically as illustrated in the upper portion of Fig. 56, so as to occupy 16 lines, a very quick and simple calculation would show us precisely the number of current changes that would occur in the amplifying apparatus of the transmitter and receiver. The first line would be unoccupied by the picture and hence the first hole of the scanning disc would intercept nothing but uniform light. The second hole of the scanning disc, however, would intercept light up to the blank line and then it would cut into the dark portion. Upon doing this the current passing through the photoelectric cell would be cut down to almost zero and if the voltage across the neon tube was properly adjusted at the receiver, the neon tube would go entirely out during the interval that the hole of the scanning disc was passing across the dark spot. Upon leaving the dark spot, light again strikes the photoelectric cell and the neon tube comes back to full brilliancy. In the case of transmitting a purely black object, such as the cross we have been considering, the neon tube would simply go "on" and "off." When the wider portion of the cross was being scanned, the neon tube would remain "off" longer than it remained "on," and in this way the practically black shadow would be reproduced at the receiver.

The line between the two drawings in Fig. 56 shows the action of the current passing through the resistance-coupled amplifier to which the neon tube would be attached. During the scanning of the top portion of the cross, the current would drop when the black portion was reached and rise again when light was again intercepted on the opposite side. The cut-off should be very sharp, that is, the current should make a precip-

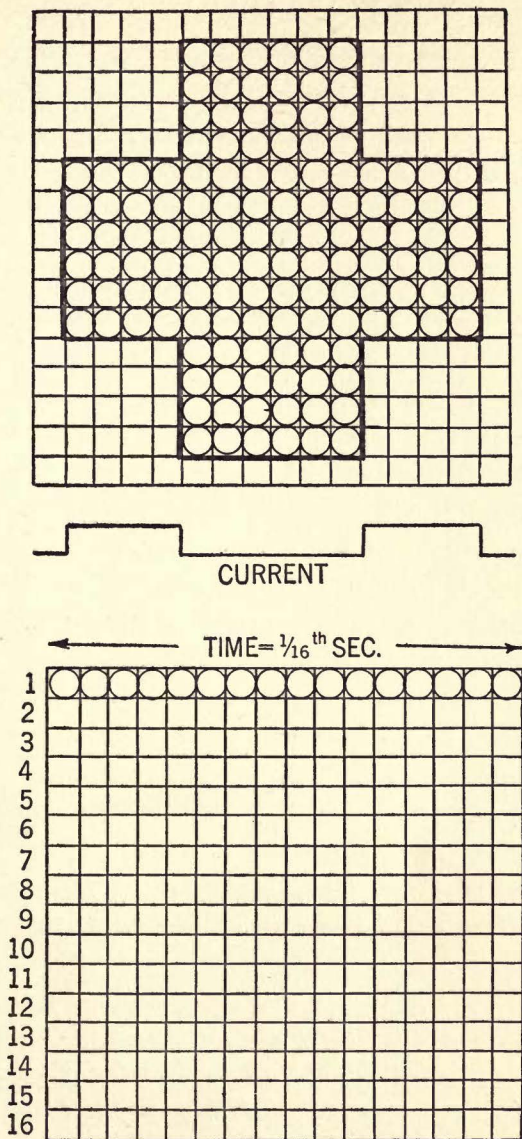

FIG. 56.—Graphic and simplified analysis of the scanning problem. This shows the number of picture units involved in the transmission of a black cross using a scanning disc with only 16 holes.

itous drop if the image is to be clearly defined at the receiver.

By a further analysis of our problem, however, we can see where the image could be so changed as to come within the limitations of a good audio-frequency transformer. If we were to draw seven black lines from the top to the bottom of the space in Figure 57, separating each line by the diameter in the hole of the scanning disc we could, it is obvious, have more interruptions per second than would be obtainable with a heavy black cross. In such a case instead of 14 interruptions a second as we had previously in transmitting the cross we would have 98 interruptions per second, which would come within the scope and range of a well designed audio-frequency system. This is not mentioned as an endorsement for the use of transformer-coupled reproducers for television purposes, it is mentioned simply to clarify our problem.

When a picture is broken up through the scanning process, the first hole in the scanning disc sweeps across the very top of the picture, the second hole at a lower level, the third at a still lower, etc., until the last hole has swept across the image. This light, after passing through each aperture, as it travels across the image, falls on the light sensitive cell and generates a picture current which should be in exact proportion to the brightness of the image from point to point, from long strips taken one after the other across the image. A little reflection will show that this is equivalent to cutting the picture or image up into a series of strips and placing these strips in the proper order end to end. If, for instance, we wish to transmit a photograph we could cut the photograph up into a certain number of strips each of the same width and paste these strips together in their proper order so that they can be placed upon the reel in the form of a single strip. If a strip was then passed under a single aperture in front of the light beam, the

picture impulse could be communicated to the transmitting amplifying system in the same order in which they are transmitted when the scanning disc is employed.

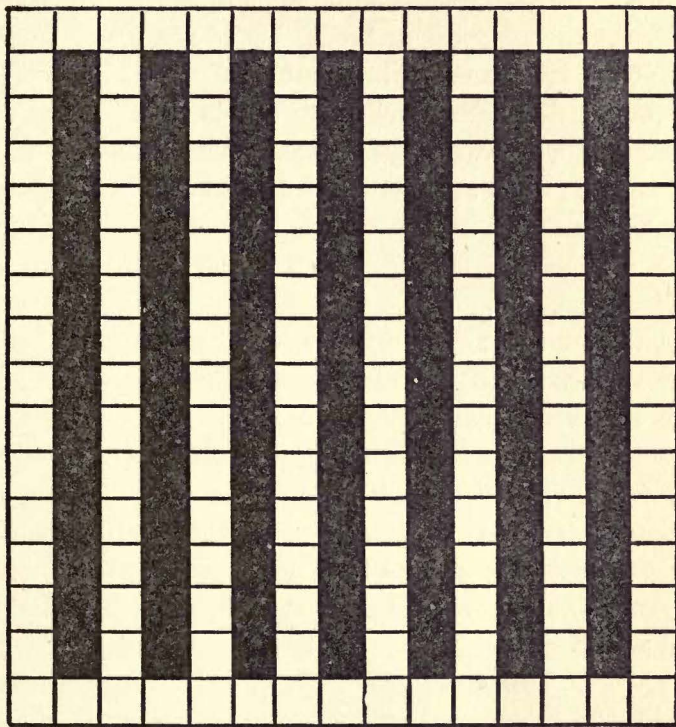

FIG. 57.—Further analysis of the scanning problem. The transmission of lines of this character would involve much higher frequencies than would the transmission of the simple black cross illustrated in Fig. 56.

In designing a scanning disc, or scanning drum for that matter, it behooves the experimenter to arrange the holes with extreme accuracy. If there is an intervening space between each successive hole there will be reproduced at the receiver dark lines which will represent portions of the image that have not been scanned by the light beam. These dark lines will

have a width proportional to the distance between the scanning holes. On the other hand, if the holes are permitted to seriously overlap each other distortion will be produced. The practice of television workers to date has been that of permitting a slight overlapping of holes. While this divides the picture image at the receiver into segments separated by fine lines, this practice has been found more favorable in the results it produces than by separating the holes by small distance. It is just a case of being satisfied with a lesser evil. It is inconceivable that we should be able to design scanning discs with holes laid out so accurately that there would be no line of demarcation between them.

An examination of the patents issued on the television art, reveals many ingenious and interesting methods of scanning, some of them involving intricate optical apparatus taking the form of special prisms, lenses and revolving and oscillating mirrors. To give the details of these various systems is, however, quite beside the object of this Chapter. Rather it is our object to describe only the most simple systems that come within the range of the average experimenter's pocketbook and technical ability.

There is, however, one other scanning method sufficiently simple and workable to merit our attention. Reference is made to the scanning method employed by Baird, the English television inventor. A clear idea of this system may be had by reference to Fig. 58. Although this system is not employed at present by Baird it may appeal to many beginners because of its simplicity and workability. Baird used two discs, one with a continuous slotted spiral, and one with slots arranged in radial fashion. These two discs are driven by the same motor and their edges are permitted to overlap to the extent shown. Interposed between the light source and the discs there was

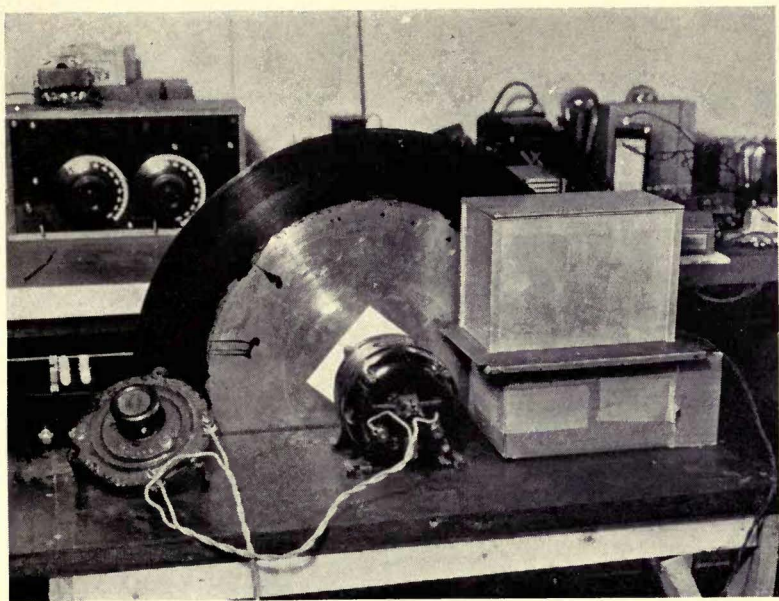

A scanning disc set up for laboratory experimenting with television. The photoelectric cell is mounted in the metal box seen at the right hand side of the photograph. The edge of the disc is coated with lamp black to prevent conflicting reflections.

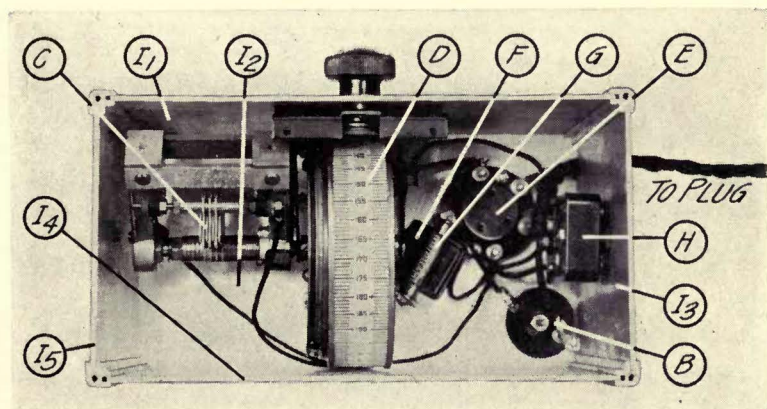

Showing the arrangement of the instruments within the short wave tuner. C is a short wave condenser, D a drum dial, G a grid leak, F a grid condenser, E a cushion socket, B a choke, and H a small variable condenser used to control the oscillations of the detector.

arranged a cellular structure built up of a bank of metal tubes soldered together.

The number of tubes used determined the number of units

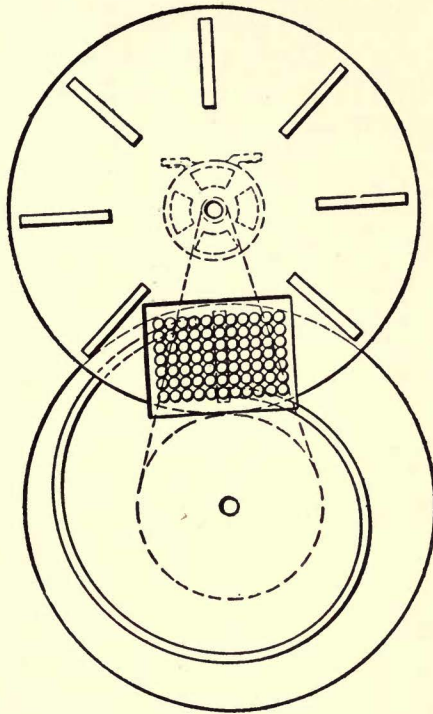

FIG. 58.—Scanning system first employed by the English television experimenter, Baird. As will be seen, Baird used a continuous spiral, the light being moulded into round beams by means of a cellular structure made up of round metal tubes.

into which the picture was to be broken. Naturally with the small number of tubes shown in the diagram nothing but very crude outlines could be transmitted. Each one of the tubes conveys a small elemental area of illumination so that when in use it splits the image up into tiny round dots. The light com-

ing through the holes and reflected from the image strikes a photo-sensitive cell, as in the case of other scanning methods. If the Fig. 58 is scrutinized closely we will observe that light is permitted to pass through only one tube at a time. The diagram shows one of the radial slots of the top disc stationary at a point where it brings it into its range the middle series or bank of tubes. While in this position, the spiral below makes one complete revolution and in so doing exposes each tube in that

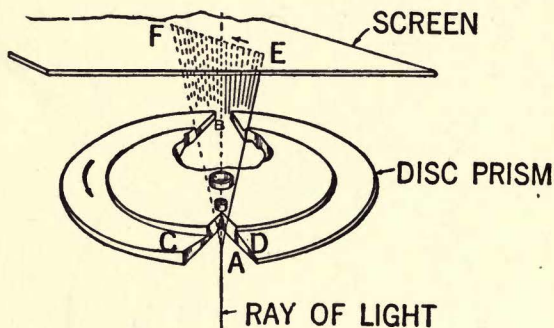

FIG. 59.—Revolving glass prism used for scanning in the Jenkins system of picture transmission. (Courtesy Q S T.)

bank to the light. This process is repeated until each vertical row of tubes has undergone the same treatment.

C. Francis Jenkins, the well-known American television expert is responsible for the perfection of a number of most ingenious scanning methods both for television, telemovies and phototelegraphic purposes. In the case of transmission of pictures, the picture is first projected through a conventional stereoptican machine. From this point the image is carried through four over-lapping prismatic rings, two of which in rotation sweep the picture vertically across the light sensitive cell at the same time the image is moved laterally by the other prismatic rings. The prismatic ring was developed by Jenkins

in his effort to exercise perfect control over the motion of a beam of light. The prism is ground on the periphery of a glass disc. (See Fig. 59).

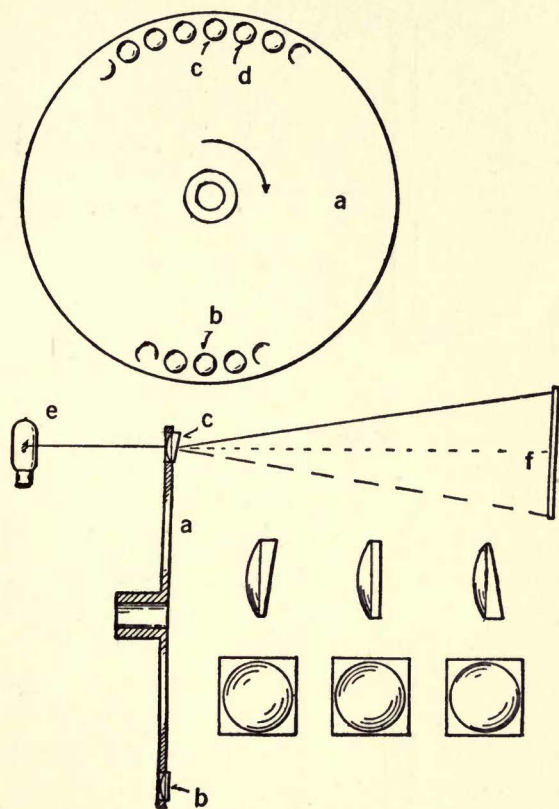

FIG. 60.—Jenkins' scanning discs using lenses ground in forms between the extremes shown in the lower right hand corner of the diagram.

Still another system due to the ingenuity and tireless efforts of Jenkins is shown in Fig. 60. The disc "A" carries a series of lenses, B, C, D, etc. These lenses sweep the beam of the light source E directly across the screen F in a horizontal

direction. Vertical line displacement is effected by reason of the changing angle of the successive lens elements. The two extremes of the lenses are shown together with the neutral

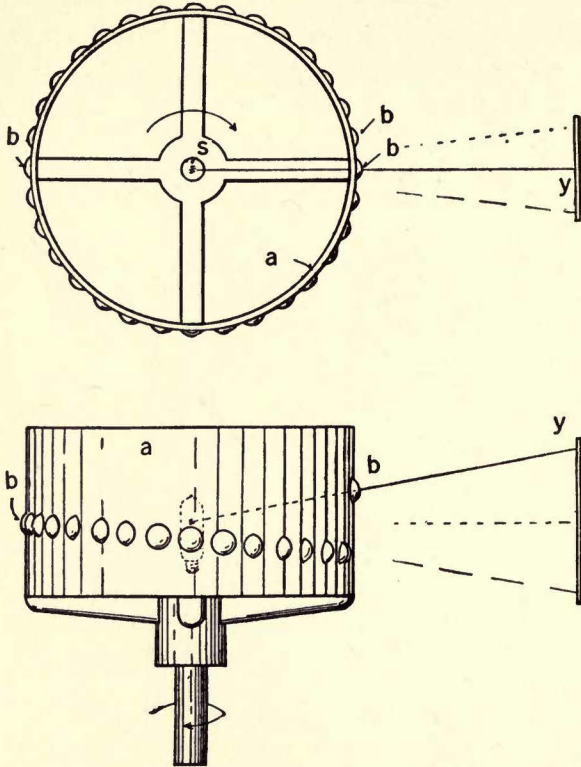

FIG. 61.—Jenkin's method of employing a drum for scanning. The lenses are mounted in spiral fashion.

lens. Uniform graduation from the one extreme to the other is carried out through the precise grinding of the lens elements.

Another modification of this system of scanning is shown in Fig. 61. Here lenses are employed being mounted in a revolving drum rather than in a disc.

In any scanning system similar to those previously outlined, the efficiency would be limited for any given size image that can be scanned by the ratio of aperture to focal length of the lens. Exhaustive experiments show that with the best lens available of the type necessary to form an image one inch square, it would be necessary to bathe the object in light inten-

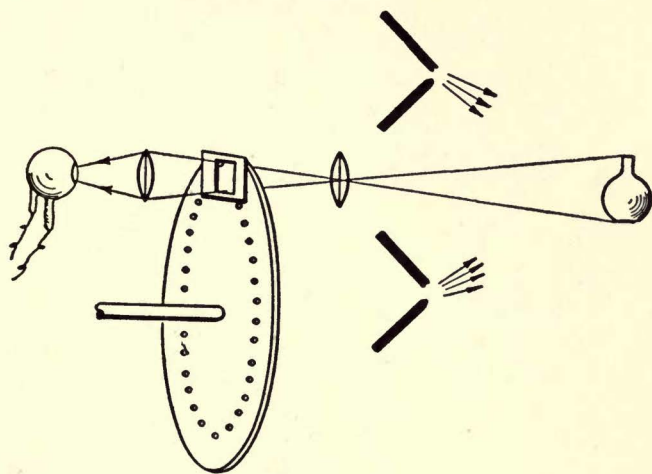

FIG. 62.—In this scanning system, the object to be transmitted is illuminated with several powerful sources of light. (Courtesy Bell Telephone Laboratories, Inc.)

sity equivalent to 1600 candlepower at a distance of four feet, if sufficient current were to be produced for the photoelectric cell to give an output current above the noise level of an amplifier system. We can readily imagine the difficulties involved in such a system, especially from the standpoint of the object if it happened to be a living one. As a matter of fact, a human being in close proximity to such a powerful source of light would suffer great inconvenience and would not be able to withstand the severe punishment for a great period of time.

The above paragraph refers to a scanning system similar

to that shown in Figure 62. Here we see the arc lights so arranged that the object is fully illuminated by the light they give. The light is then reflected from the object through the lens, through the scanning disc, through a second lens, and thence to the photoelectric cell. Naturally, the rotation of the scanning disc explores the surface of the object.

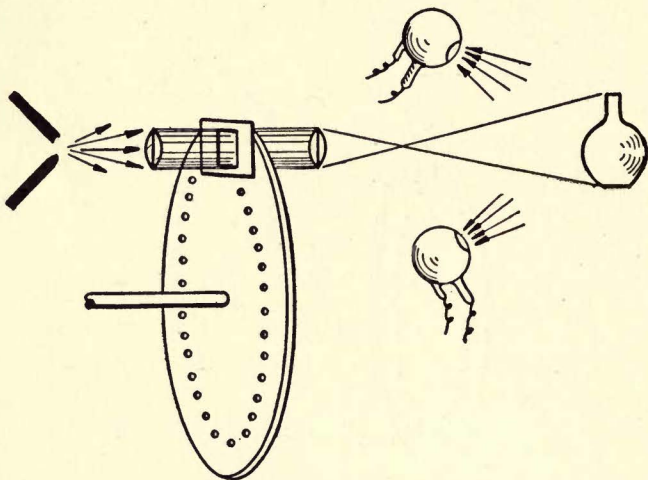

FIG. 63.—To overcome the necessity of using several powerful sources of light, this scanning system uses only one source which is reduced to a single beam. With this method, however, it is necessary to make the photoelectric pick-up more sensitive. Consequently, three photoelectric cells are used in place of one. (Courtesy Bell Telephone Laboratories, Inc.)

A more practical system, and one making less demand upon any audio-frequency system used for amplification, is shown in Figure 63. Here the light from the arc is concentrated by a special lens and carried to the object in the form of a powerful beam which is, in turn, reflected to the photoelectric cell. Thus it will be seen that the object is not entirely covered with light but explored progressively with an intense beam which moves at high speed as the disc revolves. This system is found to be

much more efficient and is recommended for use in place of the one previously described.

Inasmuch as extreme accuracy is required in drilling the holes in a scanning disc the experimenter not equipped with elaborate mechanical measuring instruments will possibly have some difficulty in laying out the disc as previously mentioned. To assist in this work, a small drilling jig may be made which will greatly facilitate accuracy in drilling a disc. In the construction and use of this jig advantage is taken of the fact that a 10-32 or 8-32 screw will advance $1/64$ inch a half revolution. $1/64$ th of an inch is approximately the equivalent of .015 of an inch, the diameter of a No. 78 drill.

To make the jig, a piece of rod threaded either with a 10-32 or an 8-32 thread is necessary. The length of this rod will depend entirely upon the diameter of the disc to be drilled. At one end the rod is split with a hacksaw and there is inserted into this end a flat piece of brass which is soldered in place. Somewhere near the end of this brass rod a hole is drilled with a No. 78 drill. The opposite end of the rod is threaded into two nuts which are in turn soldered on to a small brass plate having a hole drilled through it the same size as the hole in the center of the scanning disc. The whole arrangement is pivoted with a center pin.

To use this jig (See Fig. 64) it is, of course, necessary to lay the disc out dividing it up into segments, the number of which will depend upon the number of scanning holes. For a 48 hole disc the diagonal lines are drawn $7\frac{1}{2}$ degrees apart. $7\frac{1}{2}$ degrees is divided into 360 exactly 48 times. The holes do not need to be laid out or marked with a punch for the jig will automatically drill them with extreme accuracy.

The No. 78 drill, owing to its small size, cannot be used with an ordinary hand drill owing to the extreme weight of

such a tool compared with the fineness of the drill. To use a drill like this properly it will be necessary to purchase a Starrett pin vise, which is a small chuck provided with a knurled handle to facilitate rolling between the fingers. After the drill is inserted in the chuck it is placed through the hole in the brass strip at the end of the jig.

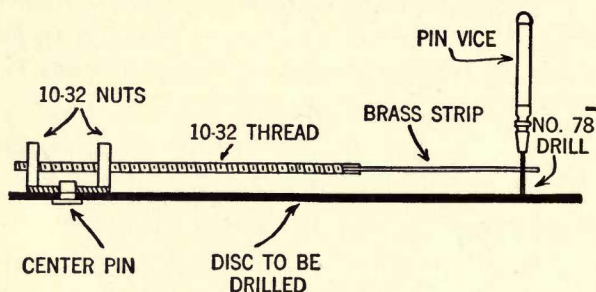

FIG. 64.—Drilling jig used in accurately locating and drilling the holes in scanning discs. This jig takes advantage of the fact that a 10-32 screw thread causes a rod to advance .015 of an inch for every half revolution.

After the first hole is drilled the jig is moved on to the next line in the disc. At this point the threaded brass rod is given $\frac{1}{2}$ turn inward. Care should be taken to see that it is only $\frac{1}{2}$ a turn and not a full turn. A half turn simply takes the bottom side of the brass strip and turns it up. It must be remembered that a full turn which would advance the rod $\frac{1}{32}$ of an inch would require bringing the same face of the brass strip back to the same position. The use of a small drill of this kind with this jig gives a very nicely balanced picture of fine grain.

CHAPTER IX

SYNCHRONIZING TELEVISION

An A B C Outline of the Synchronizing Methods Now Employed by the Television Broadcasters of Today—Problems of Synchronizing Television Scanning Discs Treated in a Popular Way.

ONE of the most aggravating problems of television is that of producing synchronism between the scanning device at the transmitter and the one at the receiver. A lack of synchronism, if great enough, will totally destroy the picture or cause it to be distorted and to drift across the field of vision.

In producing synchronism between the receiver and transmitter Dr. Alexanderson of the General Electric Co., simply employs two synchronous motors, one to drive the scanning disc at the transmitter and another of identical type to drive the scanning disc at the receiver. If two such motors are used operating from the same service lines only very small differences in speed will result. These differences in speed can to some extent be regulated by placing a resistance controlled by a push button as shown in Fig. 65. The introduction of a resistance in a circuit will at once tend to break the synchronous speed and cause the motor to slow down. Naturally the resistance will have to be of a value sufficiently high so that it may be introduced in the circuit without drawing too much current. In operating this system only momentary manipulation is necessary and as time goes on the user will develop considerable skill in keeping the picture framed.

Contrary to the general impression, it is possible to use D.C. motors to drive scanning discs even though A.C. synchronous motors are used at the broadcasting station. The D.C. motor must naturally have a speed that will match that of the synchronous motor which is 1750 R.P.M. for the type ordinarily employed. By means of a controlling resistance

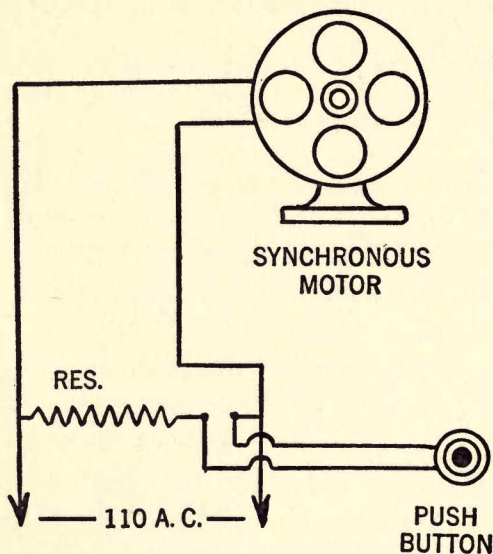

FIG. 65.—Showing the method of reducing momentarily the speed of a 60-cycle synchronous motor by inserting a resistance with a push button.

connected up as shown in Fig. 66 it becomes a comparatively easy matter, to keep the D.C. motor within synchronous speed by manipulating the push button. It will be noticed that the resistance is variable so that the speed of the motor may be adjusted somewhere near the speed of the synchronous motor. Some little care will perhaps have to be exercised in getting it just right, but once it is properly set, manipulation of the controlling button will bring about necessary synchronism.

The size of the resistance used and its current carrying capacity depends somewhat upon the size of the motor, its speed and its load, the load being determined in turn by the size of the scanning disc and its weight. A two-foot scanning disc of $3/16$ -in. metal revolving at a speed of 1100 R.P.M. places ap-

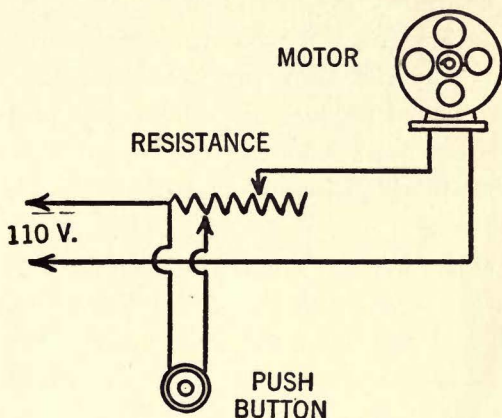

FIG. 66.—One method used to control the speed of a fractional horsepower motor with a small resistance and a push button which is constantly held in the hand of the operator. Two contacts are arranged on the resistance to enable the operator to obtain close adjustment.

proximately a 100-watt load on the motor. The resistance used should be about 20 ohms and should have a current carrying capacity of approximately $3\frac{1}{2}$ amperes. If high speed motors are used the value of this resistance will naturally have to be increased.

While a number of very ingenious methods have been devised to bring about synchronism perhaps the most practical one is that which has been developed by the engineers of the Bell Telephone Laboratories. In the television system that was first developed by the Bell Telephone Laboratories, synchronism was brought about by the use of two driving motors,

their armatures mounted on the same shaft. One was an ordinary 60-cycle motor and the other was a special high-frequency synchronous motor, operating at 2000 cycles. This brought about a constancy of revolution in the disc, since a slight slippage or variation in the speed of the high-frequency motor was not nearly as great as corresponding variations in the case of the low-frequency motor. Between the two motors a very accurate synchronism was maintained. In elaborating upon this method of producing synchronism, the engineers of the Bell Telephone Laboratories struck upon the brilliant idea of controlling the high-frequency A.C. motor with a quartz crystal oscillator.

Quartz crystals, when ground to accurate size, are found to respond to a frequency corresponding with that size. This is called the "Piezo electric effect." When a difference of potential or voltage is applied across a crystal, there is caused a disturbance of the arrangement of the crystal particles. When the voltage applied alternates rapidly this internal distortion is most effective only at a certain frequency, this frequency depending upon the size of the crystal. In other words the crystal, like a tuning fork, becomes resonant only at a certain frequency.

By properly incorporating these crystals into a circuit similar to that shown in Fig. 67 and 68 an oscillating current of great accuracy may be generated. This current output of the quartz crystal oscillator is used to control the high-frequency A.C. motor.

So delicate is this action of crystals that the accuracy of oscillation may be interfered with by slight variations in temperature. Consequently the apparatus just referred to is carefully guarded from temperature changes in a container which is kept at constant temperature by thermostatic control.

In this system of synchronism, the two crystals are identical; one being used at the transmitter and the other at the receiver. These crystals might be compared to two perfectly synchronized pendulums swinging in perfect step. So perfectly does this system work out in practice that synchronism is brought to the rate of one part in a million. This means that

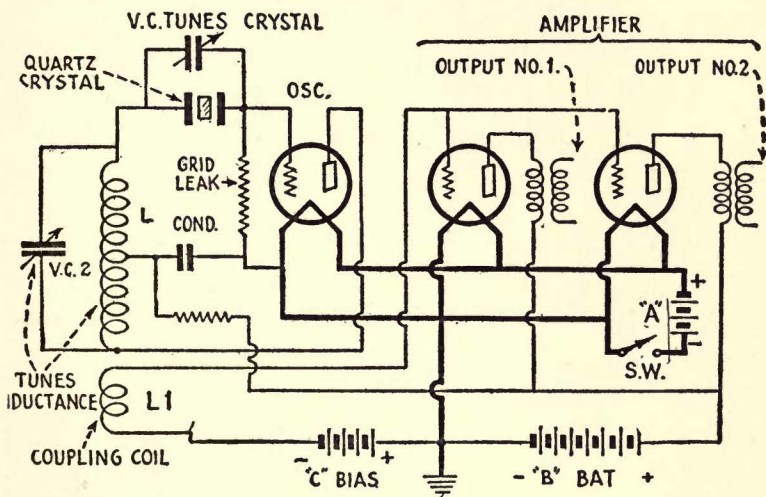

FIG. 67.—Method used in incorporating a quartz crystal in an oscillating circuit. When so placed, a crystal will actually control the frequency of oscillation. Due to this, such crystals have been successfully employed in bringing about synchronism between television receivers and transmitters. (Courtesy "Radio News.")

the receiving and transmitting discs may rotate a million times without getting out of step more than one revolution. Even this small discrepancy in speed may be instantly corrected by pressing a button which will bring the picture back into the frame and hold it there for periods as long as one hour.

Just as the oscillating crystals may be controlled by vacuum tubes arranged in regenerative circuits so may tuning forks be controlled by electromagnets fed with currents from oscillating

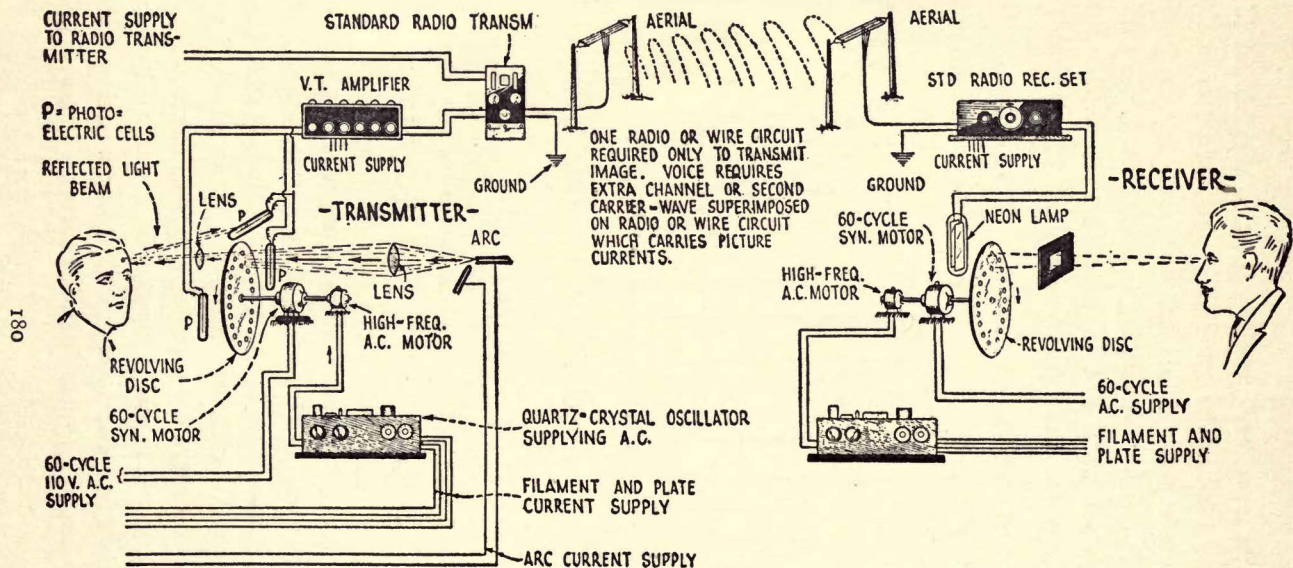

Fig. 68.—Showing how a quartz crystal oscillator is connected to a special high-frequency synchronous motor. Two oscillators tuned to the same frequency are used, one at the transmitter and one at the receiver. (Courtesy Experimenter Publishing Co.)

vacuum tube circuits. A number of systems operating on this principal have been used with specially constructed synchronous motors of small power. This system, however, does not work out as favorably as the quartz crystal method although it does lend itself more readily to amateur experimentation.

A very ingenious and yet simple indicator may be assembled in the manner shown in Fig. 69. Such a system could be applied to either television or phototelegraphy taking place over wires. The transmitting disc of the transmitter shaft is provided with a projecting member which makes contact with a

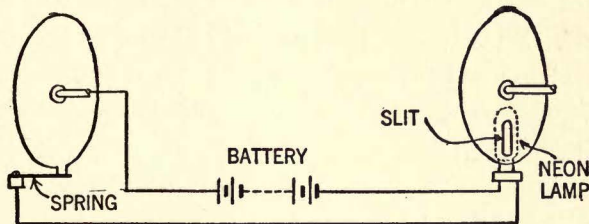

FIG. 69.—Simple indicator of synchronism. When the glow of the neon lamp is seen, this indicates that the wheel at the transmitter is running in perfect step with the wheel at the receiver.

brush once for every revolution. At the receiver a slot is cut in the disc or drum at a corresponding position so that every time the brush at the transmitter makes contact the neon lamp at the receiver will glow. This glow will not be seen, however, unless it occurs at precisely the same instant the brush makes contact at the transmitter. This serves as an accurate check on synchronism and the speed of one disc is regulated until it matches the speed of the other disc at which time the glow of the neon lamp will be clearly seen through the slit at the receiving end.

Mr. Paul L. Clark an ingenious experimenter with television has devised a system of synchronism which is automatic

in operation and which has as its controlling feature light beams.

Sending pictures by television may be likened to a military drill or maneuver having many lines of soldiers in regimental order, supervised by a single individual, the troops advancing as a single unit or as related units of the command, marching in step to rhythmic music. But what happens on the long turns, platoon formation? The line bulges a little in the center, recedes, advances, surges slightly and straightens out. It is largely a matter of alignment. Each man determines his position and speed by watching the rest of his outfit, and must be ever alert. So it is with the sending and receiving of pictures by apparatuses which are miles apart and yet which must keep in orderly arrangement the many parallel lines of shaded dots that make up the picture.

Experimenters on television term this aligning process "synchronizing," which means keeping the receiving set in step with the transmitter, so that the pictures will not bounce around the screen. You tune your radio set by *listening* to your loudspeaker; but only by *watching* the pictures on the small television screen is the experimenter given a clew to tuning his motor speed and framing the incoming pictures, the light flashes of which follow each other so fast that the eye fails to note a break in illumination. Once the picture is manually framed, no more attention to motor speed should be required, enabling the operator to control merely the brightness of the picture, letting synchronism take care of itself.

The experimental art has now arrived at the stage of sending 16 small pictures each second, each consisting of 50 lines having 50 shaded dots in each line, forming a picture which consists of 2,500 tiny areas, each of these areas being of a light or shade corresponding to one of the successive areas which

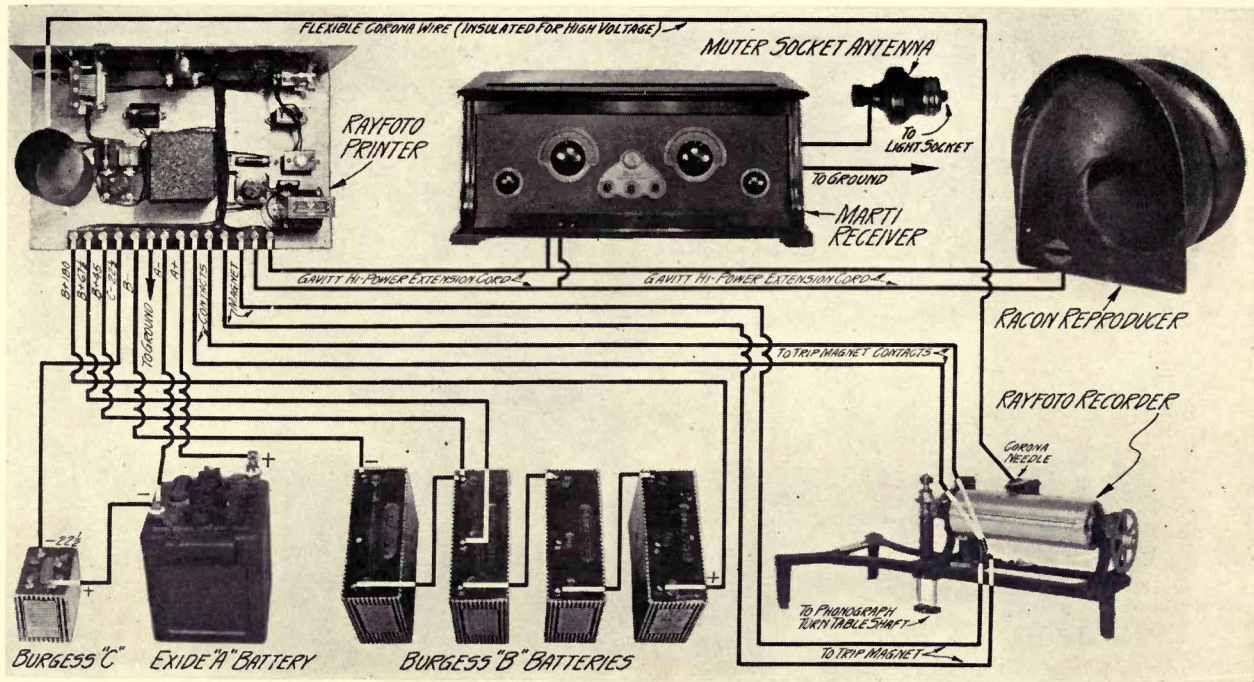

How the Cooley Rayfoto picture receiver is connected to an ordinary radio set for the reception of "still" pictures, either photographs or drawings.

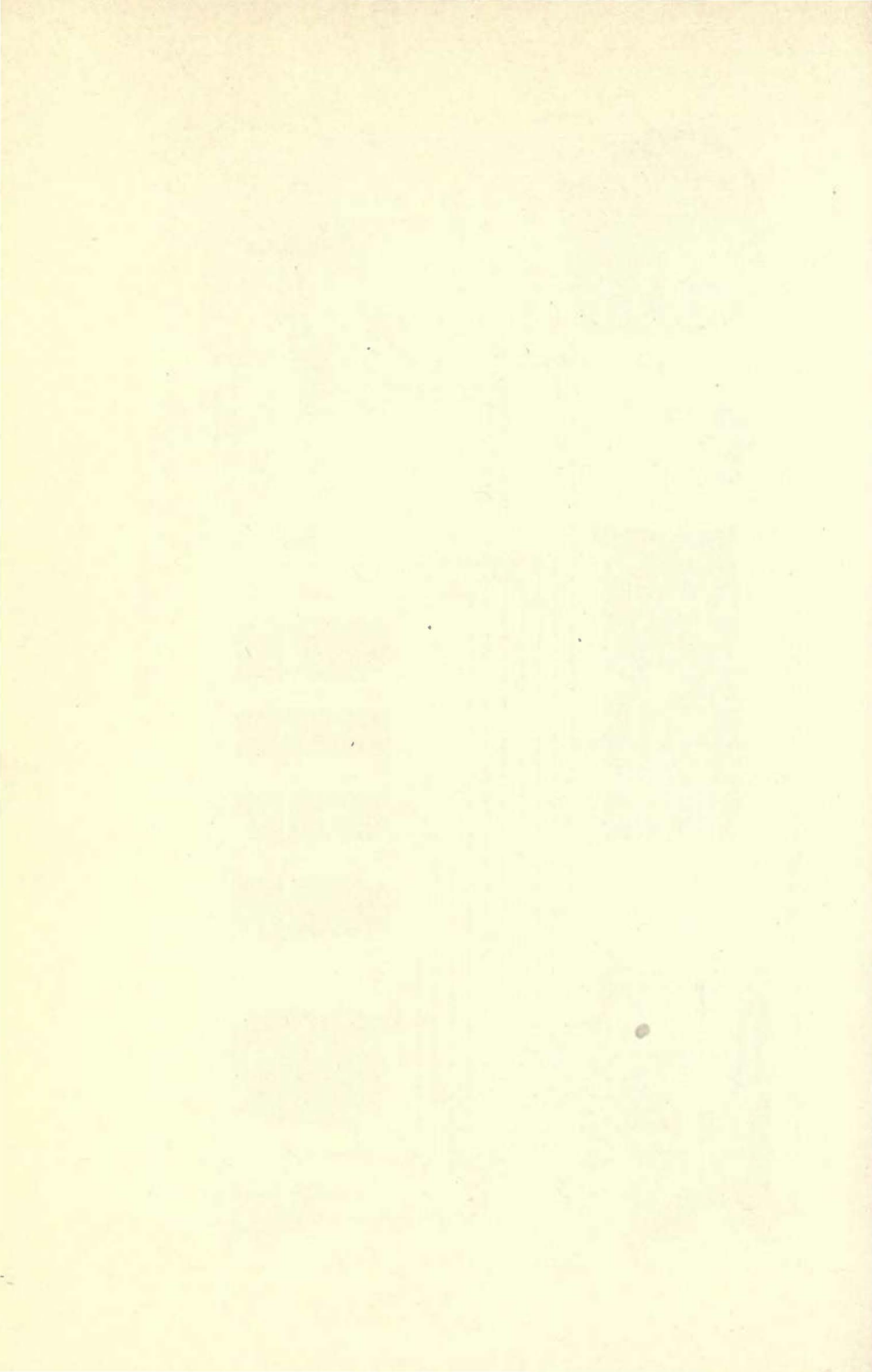

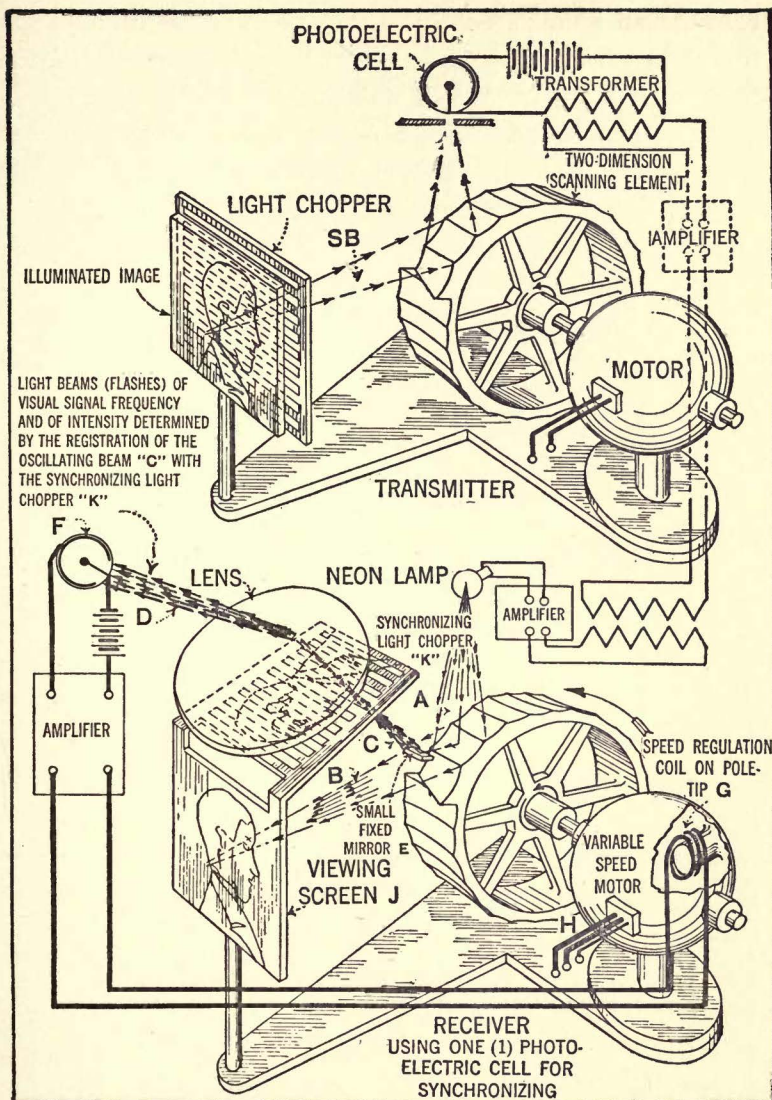

FIG. 70.—Transmitter and Receiver. The automatic synchronizing system is shown in heavy lines.

compose an illuminated object such as the bust of a person seated in front of the transmitter, certain elements of the transmitter being driven by a motor at constant speed.

The receiver must have a motor which runs at the same speed as that in the transmitter. Motor speed is regulated by varying the electric current in the field coils of the motor, a strongly excited field slowing down the motor. The motor of the receiver of Fig. 70, in addition to the regular shunt winding, is provided also with an extra coil, G, which is wound so as to weaken the field and speed up the motor when current is passed through the coil. This is the coil which automatically regulates the motor speed, being energized by current which is set up in the local photoelectric cell, F, by virtue of light rays falling upon the cell, as described below. The motor should be manually started and brought up to run at a speed about one per cent below the speed of the transmitter motor, it being assumed for the time being that there is no current in the reverse field coil so that the received picture tends to travel slowly backwards across the screen, thereby indicating motor under-speed.

The speed-correcting system herein described is designed to speed up the motor automatically at least two per cent, so that the speed with the reverse coil full strength will be about one per cent too high. The effect of the underspeed and overspeed field control is such, when applied successively at intervals a fraction of a second apart, as to hold the picture quite steady, the automatic feature of this device being merely a simple form of photoelectric light valve governed by different degrees of stoppage of successive flashes of the received picture light, these flashes being swept in the form of a swinging beam rapidly across a stationary grid or "light-chopper," made up of bars and slits, as shown in Figs. 70 and 71.

The action of this valve is such as to vary the quantity of light which falls upon the photoelectric cell, the light used for

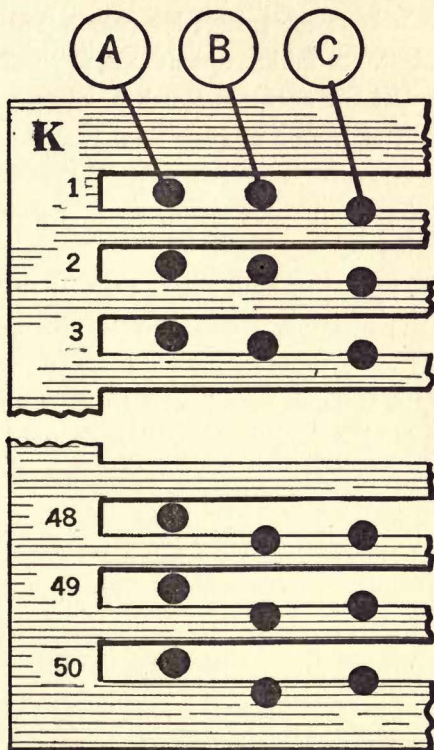

FIG. 71.—A. Successive flashes in beam from neon tube registering with successive slits in the light chopper, showing that the motor speed is too high. B. Flashes progressively overlap the chopper bars, showing speed drop from high to low. C. The flashes are partly intercepted by the bars, and half of the light passes through the slits so as to fall upon the photoelectric cell shown in Fig. 1. This condition is the ideal interception of the flashes to produce the least oscillation relative to synchronism.

this purpose being about 10 per cent of the light in each signal flash emitted by the neon lamp, these flashes being produced by signals received from the transmitter at the dizzy rate of

many thousands during each second. The cell is connected through an amplifier so as to supply energy to the pole-tip coil of the motor, so that bright light on the cell speeds the motor up; dim light slackens the speed; intermediate light flashes, as shown at C in Fig. 70, falling upon the cell produce a neutralizing effect essential for accurate synchronizing.

The transmitter motor in Fig. 70 drives the scanning disc consisting of 50 concave mirrors arranged at gradually increasing angles in the form of a spiral, so that as the scanner is rotated successive vertical lines of the illuminated image are traversed, point by point, by a single turn of the scanner; and all points of the image are successively changed into corresponding electrical currents by the photoelectric cell and sent to the receiver by a suitable broadcasting set or wire line. The chopper which is placed against the illuminated image is made of a glass plate, 3 inches square, on which are photographed 50 blackened bars each about as wide as a darning needle, alternating with transparent slits of equal width; so that as the scanning beam, SB, rapidly sweeps across the image, due to the rotation of the scanner, a series of lighted picture dots alternating with uniformly dark spots which are formed by the black chopper bars, is focused by the concave mirrors on the scanner, so that the light or shade of each illuminated picture area, alternating with the black chopper areas, falls upon the cell, producing therein a series of electrical currents derived from the bright picture areas, alternating with the electrical currents of extremely low and uniform energy, the latter impulses being derived from the low intensity of the light reflected by the dull surface of the black bars. The advantage of using a chopper in the transmitter is seen to lie in its ability to break up the picture into a large number of disconnected, equispaced areas or lines which, when swept by a pointed beam,

give rise to a corresponding number of instantaneous successive current impulses in the photoelectric cell and in the circuit which supplies current to the cell. The number of these impulses which are produced and transmitted in a single second of time, is technically called the "picture point frequency," which we will assume to be 40,000 per second. Changing the series of instantaneous currents into an alternating current by means

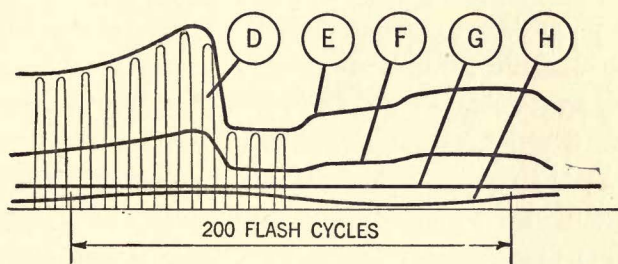

FIG. 72.—D. Neon lamp flashes, 40,000 per second. E. Flash energy applied to delineate picture on screen. F. Energy reflected by the small fixed mirror, Fig. 1, to fall upon the chopper. G. Maximum illumination required on the photoelectric cell to compensate for one per cent slow speed. H. Approximate synchronizing cycle made up of 200 flashes.

of a suitable transformer, we find that in each 1-40,000th second we have a complete electrical action or wave which is made up of two parts, one being the positive picture signal which may be either strong or weak, depending on the shade of the picture dot, the time during which this half-wave is formed being 1-80,000th of a second; the other half of the wave being the negative or low intensity chopper bar signal of constant value.

Now, it is evident that if we have a receiving scanning system similar to that of the transmitter and run them both at the same speed, and if similar choppers are used, we will find that during each successive 1-80,000th second the focused

scanning beams will simultaneously register : first, upon corresponding bars; second, through corresponding slits, in both apparatuses; so that when the beam is sweeping bar number 1 in the transmitter, the receiver beam is sweeping bar number 1 of the receiver; and 1-80,000th of a second later, the two beams will simultaneously sweep across slits number 2 of both pieces of apparatus. The above condition is that prevailing during exact synchronization, showing that the picture receiving set is perfectly timed.

This idealistic assumption is, however, a little more than we can hope to obtain for periods of more than a few seconds. But we can attain a close registration by limiting the deviation to less than the width of a single slit *i.e.*, a maximum error of cross-travel of less than one per cent, by providing a reasonable margin of excess energy in the motor-speed compensating circuit of the receiver. Too much cross-travel necessitates manual rephasing.

In order to obtain zero illumination on the cell, F, and consequently no current in the polarity reverse coil, G, throughout both halves of a given picture flash cycle during which cycle are transmitted a complete picture point luminous signal followed by a complete low energy black bar signal, it is evident that the luminous signal must have struck the chopper in such a way that it is entirely stopped by one of the chopper bars as shown at the lower part of the vertical series, B, in Fig. 70, due to faulty synchronism resulting from overspeed; for it can be seen that for accurate synchronism the local scanning element should instantaneously be in such an angular position as to reflect the pointed conical beam emanating from the simultaneously produced neon lamp flash, so that the point of the beam shoots squarely against the edge of a corresponding slit of the chopper, as shown at C in Fig. 70, at the exact middle

of the 1-80,000th second during which the flash occurs. Darkness or bright light on the cell can persist only on account of continued overspeed or underspeed which produce respectively a slightly advanced or retarded scanning element.

As we have assumed the motor to be normally, say, one per cent underspeeded, it will start to slow down from true synchronous speed until it reaches a speed which is one per cent too low, *provided there is no energy supplied to the speed-up coil*, and will backwardly deflect the signal flash beams so that some of them instantaneously pass squarely through the slits as shown at A in Fig. 70. This illuminates the cell with full light and excites the speed-up coil with maximum energy, causing the motor and scanner to advance the reflected signal beams a slight degree *ahead* of registration, until light is again shut off from the cell so that the cell circuit ceases to supply excitation to the coil, G, and another drop in speed occurs. This alternate speed-up and slow-down period may be called a "synchronizing cycle." The receiver motor is of about 1-30th H.P., 960 R.P.M., with regulation shunt-wound field coils for normal speed control.

In starting up the apparatus it is essential that the motor speed be regulated by the operator until his picture is steady, which condition implies exact timing with the incoming picture signals. Considering that the picture is steady, the successive flashes, C, reflected by the small mirror shown in the middle of the rapidly vibrating flash beam, B, in Fig. 71, will register upon the chopper, K (shown also at C, in Fig. 70), so that about one-half of each flash is stopped by the chopper bar and the other half falls upon the lens next to the chopper and is focused to fall upon the photoelectric cell, F. Now, suppose that the motor speeds up a little bit, causing the flashes C, Fig. 70 and 71, to overlap the bars *more* than half-way, let us

see what takes place: (1) The quantity of flash light which passes through the slits is lessened; (2) Dimmed lights fall upon the cell; (3) The current in the cell is decreased; (4) The current in the reversed-field coil is decreased; (5) The tendency to *reversing* the field is lessened; (6) The field itself resumes its normal full strength by virtue of its fixed shunt-winding excitation; (7) The motor slows down a little bit due to the stronger field; (8) The signal flashes are backwardly deflected by the scanning element due to the lagging action so that more light falls in the slits, passes through the lens and falls upon the cell; (9) The current in the cell and in the reversing field coil is increased, thereby weakening or de-polarizing the field; and (10) The motor again starts to speed up. This swinging, automatic, speed control cycle repeats again and again, as long as there is enough average light during each synchronizing cycle to stir up sufficient speed-up current. By providing an amplifier which has an output of about 1 watt, enough reserve energy is available for control.

Each synchronizing cycle embraces, say, an interval of 1-200th second, and consists of 200 valved flashes passing from dim illumination on the cell, to medium illumination, to bright illumination; and repeating the cycle. The frequency of the synchronizing cycle is determined by considering that 99 bar traversals occur in the time interval during which, for exact synchronism, 100 traversals should occur. Fig. 72 shows such a synchronizing cycle consisting of 200 successive picture flashes progressively intercepted by virtue of underspeed and overspeed; the line G indicates the comparative value of the reverse energy required to maintain synchronization or "critical speed."

CHAPTER X

TRANSMITTING TELEVISION AT HOME

How the Experimenter Can Construct and Operate Both a Television Transmitter and Receiver for Home Use—This Equipment Makes Possible the Transmission of the Outline of Simple Objects From One Room to Another.

So enthusiastic have many radio experimenters become over television that they are anxious to try their ingenuity at transmitting as well as receiving. Contrary to what might be the prevalent notion, the transmission of television can be accomplished with modest apparatus on a scale that will delight those experimentally inclined. All that is needed in the way of apparatus is a small motor, two scanning discs, a resistance-coupled amplifier, a photoelectric cell and a neon tube. The purely mechanical portion of the transmitter may easily be assembled from junk found about the experimenter's shop.

Owing to the difficulty of obtaining an extremely brilliant source of illumination such as that made possible by an arc lamp, the experimenter is not advised to attempt to transmit moving objects. The picture impulses of the transmitter about to be described are controlled by a piece of ordinary Kodak film. The size of the picture to be transmitted will depend upon the size of the scanning discs and the grain of the picture as well as the number of holes and their diameter.

Perhaps one of the first problems to be solved in this

arrangement is that of making the neon lamp sufficiently sensitive to respond to current variations at the input of the amplifier which are brought about through the action of light on the photoelectric cell. It will be found that the grid biases of the amplifier will have to be adjusted carefully before this result is brought about. First the neon lamp is connected up to the output of the amplifier and the photoelectric cell connected to the input with the shunt resistance as described in Chapter IV. The biases of the tubes should be adjusted until the neon lamp will go out when the photoelectric cell is covered by the hand so as to cut off all light. Further progress in modulating the light of the neon lamp may be had by mounting a scanning disc on the shaft of the motor and placing the neon lamp on one side of the disc and the photoelectric cell on the other side. The photoelectric cell should be carefully encased in a light-tight box painted black inside and provided with an aperture which will correspond to the picture size that can be accommodated by the scanning disc. By using a source of light and a photographic film it will be found that proper adjustment can be brought about by a little experimentation.

The set-up of the television transmitter is indicated at Fig. 73. It will be seen that the problem of synchronizing is easily solved by placing the scanning discs on the same shaft. The spirals should be lined up perfectly so that hole No. 1 on the receiving disc is properly lined up with hole No. 1 on the transmitting disc.

Some care should be taken to see that the scanning discs are carefully fastened to the drive shaft to prevent what might develop into a serious accident should one of the discs break its moorings. It must be remembered that a scanning disc several feet in diameter revolving at a rate of 1700 R.P.M. has a peripheral speed of several miles a minute and that should

it break loose it might cause considerable damage and might even kill a person standing in line with it.

The diameter of the drive shaft used will depend upon the distance separating the transmitter and receiver discs and upon the number of bearings used. If only two bearings are employed with a $\frac{1}{2}$ inch shaft, the distance separating the discs cannot be great, otherwise the belt pulling on the shaft will produce a whip action resulting in extreme vibration. The

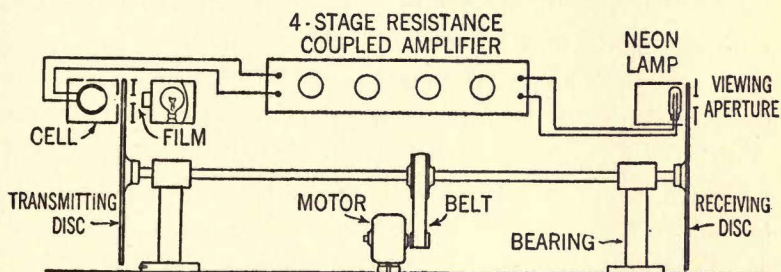

FIG. 73.—Diagram showing the simple arrangement of apparatus for a television transmitter and receiver which any experimenter may set up at home. Perfect synchronism is brought about by the simple expedient of mounting the transmitting and receiving scanning discs on the same shaft.

distance used must be judged correctly by the experimenter. In setting up this apparatus care must be taken to see that the bearings are tight and that the discs revolve smoothly without excessive vibration. Bad vibration will cause distortion in the picture.

The driving motor should be sufficiently powerful to whirl the discs at a speed somewhere in the neighborhood of 1500 R.P.M. At least a $\frac{1}{4}$ H.P. motor will be needed if the discs are two feet in diameter.

At the transmitter the light sensitive cell, which should have a window in it larger than the picture to be transmitted, is encased in a light tight box having an aperture the exact size of

the picture to be transmitted. This aperture must be lined up in such a way as to be entirely scanned during one revolution of the scanning disc. On one side of the scanning disc is placed a small wooden or metal frame also having an aperture the size of the picture to be transmitted. It is best to paint this frame black as well as the scanning disc to prevent any conflicting reflection that might be developed. The light source used for this television transmitter may be a 150 W. incandescent lamp mounted in a small reflector in a metal box having an aperture large enough to pass a light beam the size of the picture to be used. Some accommodation will have to be made to permit the escape of heat at the back of the light house. This may be done by cutting several holes in the back of the metal container and covering them with some sort of a baffle mounted on the inside.

At the receiver, the neon lamp is mounted in a metal box so that its plates will be lined up with the scanning disc in such a way as to expose the illuminated plate to the scanning operation. An aperture is cut in a piece of sheet metal and placed in front of the scanning disc and it is through this aperture that the received picture is seen.

Only sharp negatives should be used at the transmitter. While the delineation of the picture may at first be poor at the receiver, this can gradually be improved upon by experimentation.

CHAPTER XI

HOW TO MAKE A TELEVISION RECEIVER

Practical Application of the Principals of Television in the Construction of a Television Receiver Involving a Special, Highly Efficient Short-Wave Receiver.

IN Chapter V there was described a resistance coupled amplifier which possessed the desirable characteristics for television amplification. In Chapter VIII there was also described methods of laying out television discs. This information together with the data concerning the neon lamp in Chapter VII gives the experimenter sufficient data for the construction of a television receiver, with the possible exception of a tuning and detecting unit which will be described in the following paragraphs.

The television receiver should have a rather wide range of response inasmuch as television transmission experiments are being carried on with a variety of wavelengths, some extending as low as 39 meters and others going as high as 400 meters. To meet these conditions there has been designed a special tuner with an oscillating detector which, through a system of plug-in coils, may be quickly adapted to a variety of wavelengths extending as low as 15 meters and going as high as 600 meters. This receiver is neatly mounted in an aluminum case with the coils arranged on top so that the various types may be easily and quickly removed and replaced.

As will be seen from the photograph all of the tuning is

done with a single knob located on the front of the receiver, to which is attached a drum dial of a new type that insures smooth operation at all points. Regeneration is controlled by a small knob on the right-hand side of the unit and hand capacity has been entirely eliminated. This is an important consideration for short wave work.

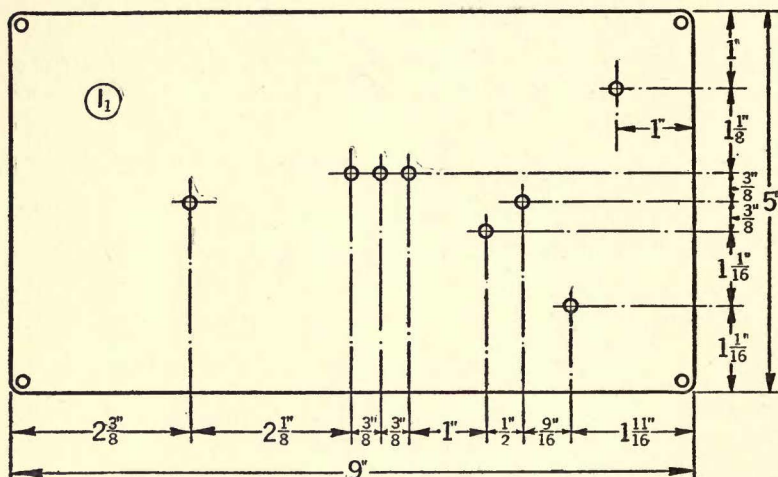

FIG. 74.—How the front panel of the short wave tuner is laid out to be drilled. The large hole is used to accommodate the drum dial.

The circuits used in this receiver contain no "tricks" but employ a modified form of short-wave circuit that has been thoroughly tested by pioneers in short-wave work.

In constructing the short-wave receiver, the first job will be to drill the necessary holes in the aluminum box shield. For mounting the instruments. It will probably be best to start by preparing the front panel of the aluminum shield for mounting the drum dial, as shown in Fig. 74. The direction sheet and template packed in the carton with this dial should be followed out in mounting this tuning dial.

Next we drill the top panel as shown in Fig. 75, for mounting the coil frame, the socket E and the choke coil. We also drill the four holes for passing through the necessary connections from the coil frame to the instruments mounted within the box shield. The coil frame is fastened to this panel by

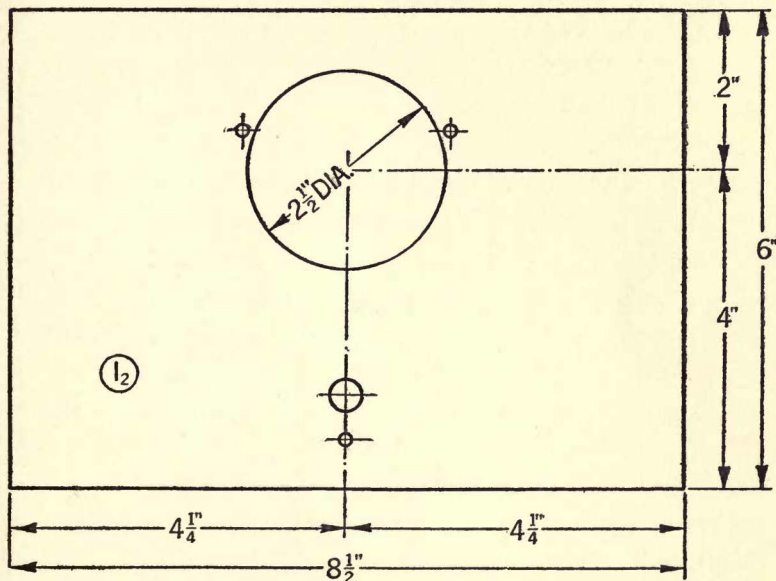

FIG. 75.—Drilling plan for the top plate of metal box for the short wave tuner.

means of two machine screws and nuts. Looking at the front of the top panel, the machine screw on the right hand end of this coil frame should be passed through to the socket E. This one screw is used for fastening both instruments. The other side of the socket E, is attached to the top panel by means of a machine screw and nut.

Next we fasten the choke coil, B, to the top panel with the mounting bolt and nuts provided with this instrument.

Now the side shield I₃ is drilled for mounting the neutral-

izing condenser, H. A hole about $\frac{3}{8}$ in. in diameter should be drilled in the upper left-hand corner of this panel for passing through the twisted leads of the output wires. The neutralizing condenser H, is fastened to this side panel by means of two machine screws and corresponding nuts. Two spacing washers approximately $\frac{1}{4}$ in. thick should be inserted between this instrument and the panel. Next we fasten the grid condenser F, which is equipped with grid leak clips to the grid terminal of the socket E.

The tuning condenser C, is attached to the drum dial, D, by means of the special bracket furnished with the dial.

The picture wiring diagram in Fig. 76 shows the instruments in their correct positions. The instruments mounted within the box shielding are outlined in solid black lines, while the coil assembly A, which is mounted on top of the box shield, is shown in dotted lines.

The same holds true of the wiring. The heavy wires are the connections to the instruments within the box shield and the phantom lines are the connections to the assembly.

When the wiring has been completed, the grid-leak G, should be inserted in the grid leak clips and the sides of the box shields should be inserted into the aluminum shield for mounting fastened with the aluminum screws.

When used, the primary of the coil assembly A should be loosely coupled to the grid coil. All tuning is done with the variable condenser C. Regeneration is controlled by the neutralizing condenser H. This regeneration control should be adjusted for most satisfactory reception at each particular wavelength received.

The various short-wave ranges may be covered by interchanging the coils. It is recommended that a log be kept of the dial setting and coil used on each station received.

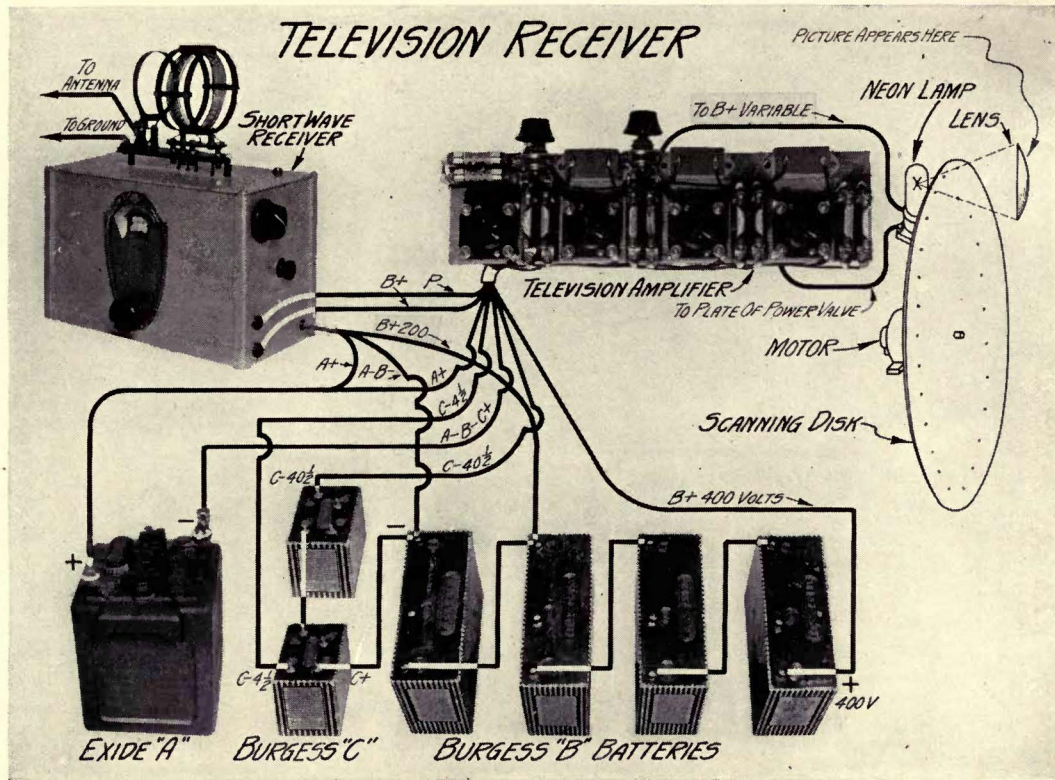

The diagram of connections showing how the short wave tuner, the resistance-coupled amplifier, and the neon tube are connected for the reception of television signals. The amplifier is the same as that described in the last of Chapter V.

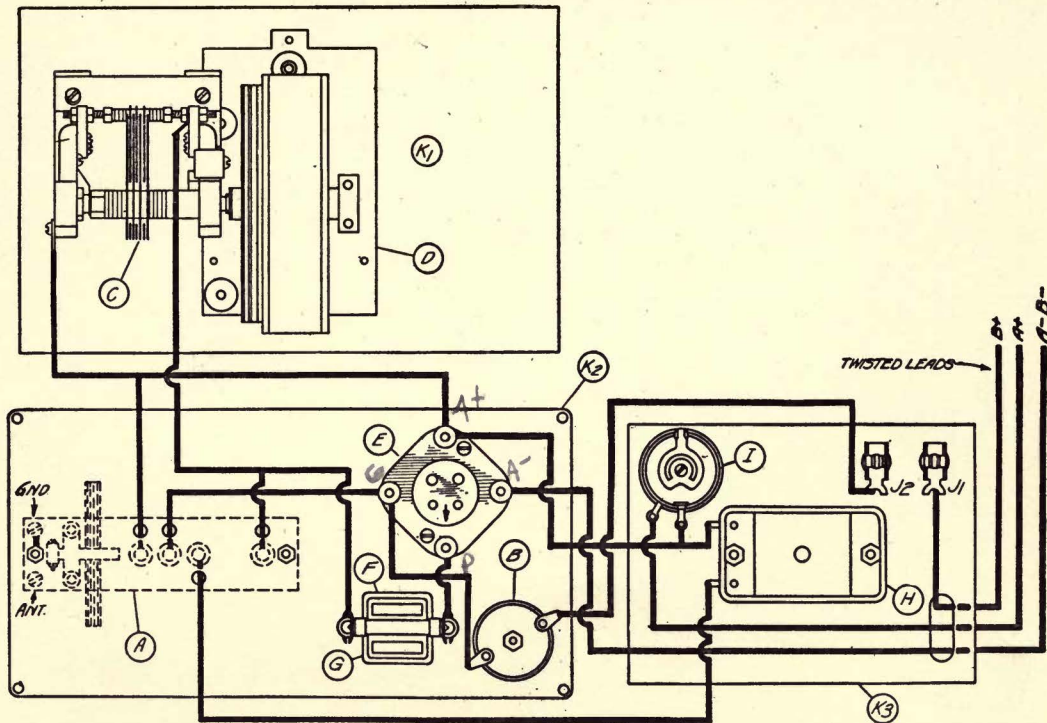

FIG. 76.—Picture wiring diagram of the short wave tuner and oscillating detector. The dotted lines in the upper right corner represent the holder of the demounted or inter-changeable coils used.

The general schematic layout and method of connecting the regenerative tuning unit, the resistance-coupled amplifier, neon tube and batteries is well illustrated in the combination photodiagram. While B batteries are shown for the source of potential there is really no objection to using well-designed B eliminators providing they are supplied with voltage regulators and a well-designed filter system. A common A battery supplies both the detector and other short wave receiver and the four tubes and the resistance-coupled amplifier.

There are several variable factors, any one of which will determine the size of the picture that may be received by this combination of apparatus. One is the size of the plate of the neon tube, another the offset in the spiral of the scanning disc and still another the power of the lens used to magnify the picture. Right here it might be said that received pictures should not be magnified beyond a certain point. It is well known that if a motion picture is magnified to too great an extent the picture will lose its delineation. Precisely the same thing holds true with television.

Lenses used for this purpose may be of the ordinary reading glass variety or one of the large condensing lenses taken from a motion picture projector. The size of the lens and the distance it is mounted from the aperture in front of the scanning disc depends entirely upon experiments. Every builder of a television receiver will have to determine this for himself, mounting the lens at a point where the reproduced picture appears most clear.

To avoid the necessity of always using a television receiver in a darkened room, a large box is made of soft pine $\frac{3}{4}$ inch stock being used. The size of this box will depend largely upon the size of the scanning disc used. In designing the box it will be found desirable to make it high enough so that there will be

room left at the bottom where the B and C batteries and resistance-coupled amplifier may be placed. If 12 inch planks

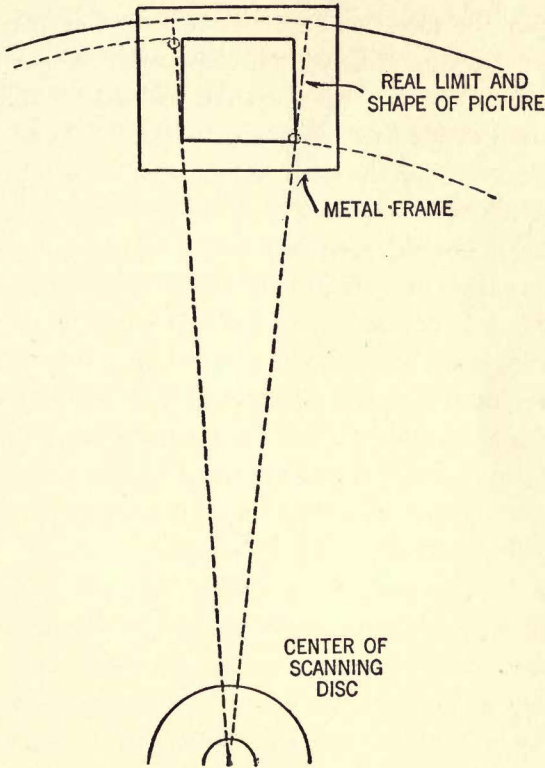

FIG. 77.—This diagram shows how the picture frame is cut to accommodate the size of the scanning disc used for reception.

are used so that the box will have a depth of 12 inches there will be plenty of room to place everything with the exception of the tuner.

Two shelves are placed in the box, one to hold the motor and one for the neon tube. The placement of the shelf for the neon tube will have to be rather accurately determined for the

plates of the neon tube must be so positioned that they are scanned by the holes in the scanning disc. It is also necessary to mount the plates parallel with the disc. If the wrong plate glows after the tube has been put in place this may be taken care of by simply reversing the connections which will cause the opposite plate to glow when the tube is excited. Battens may be used to hold the shelves in position. While this may not be necessary for the shelf holding the neon tube it will be necessary for the motor owing to the greater weight.

While on the subject of motors it might be said that several types are available for use. With the proper resistance control (this subject is covered more fully in Chapter IX) either a D.C. synchronous or Universal type of motor may be employed. The power of the motor will depend somewhat upon the size of the scanning disc. If an exceptionally large disc is used made of heavy gauge metal a $\frac{1}{4}$ H.P. synchronous motor is advisable. Smaller discs may be used with motors as low as $\frac{1}{8}$ or possibly $\frac{1}{16}$ th H.P.

Owing to the powerful magnetic field which is set up by motors it is usually advisable to place a copper shield box around the motor. This will tend to cut down magnetic interference which may be picked up by the resistance-coupled amplifier. Any vibrational effect that may be produced by the motor can be minimized by extreme care being taken in mounting the scanning disc. If the hole is not in the exact center of the scanning disc trouble might be encountered from that source. It is also advisable to buy a well-made motor. Cheap motors with poor bearings will vibrate considerably under any condition. At any rate it will be found advisable to mount the resistance-coupled amplifier on soft rubber pads which will absorb part of the vibrational effects that may be produced.

On the outside of the cabinet there is mounted a fuse block

and a controlling switch in the motor circuit. The size of the fuses used will naturally depend upon the power of the motor. If a $\frac{1}{4}$ H.P. synchronized motor is employed 25 ampere fuses will be none too large owing to the heavy starting current that is required by this type of power unit.

The inside of the television receiver is painted with a dull black enamel. The scanning disc is also covered with this material to prevent conflicting reflections that might be produced. If the scanning disc is painted after the holes have been drilled it will be necessary to ream out each hole with the drill that was used in drilling them so as to remove any of the enamel that finds its way into the apertures.

The lens used is mounted in a small hood attached to the front of the receiver in such a manner that the center of the lens will line up perfectly with the center of the plate of the neon tube. It will also be necessary to cut an aperture in a metal plate, mounting this plate at the front of the scanning disc. This is used to frame the picture. The size of this frame will depend upon the offset in the spiral of the scanning disc and the distance between the holes. Although the actual picture produced takes the shape of a segment of a circle the framing aperture is made square. The details are treated more fully in the chapter on scanning discs. Reference to Fig. 77 will also help us in this work.

Owing to the high peripheral speed of the scanning disc it is advisable to see to it that it is securely fastened to the shaft of the motor. If a heavy disc managed to work itself loose from the shaft of the motor serious damage might result to the apparatus and anyone standing in proximity to the receiver might be endangered.

After the cabinet is completed (See Fig. 78 for details) and all apparatus is mounted inside, a hinged door should be placed

on the back so that all extraneous light may be prevented from entering. It will also be found advisable to place an 0 to 25 milli-ammeter in series with the neon lamp so that the user will know at all times just what current the lamp is drawing. As mentioned in the chapter on lamps no more than 20 milliamperes should be allowed to pass through the tube.

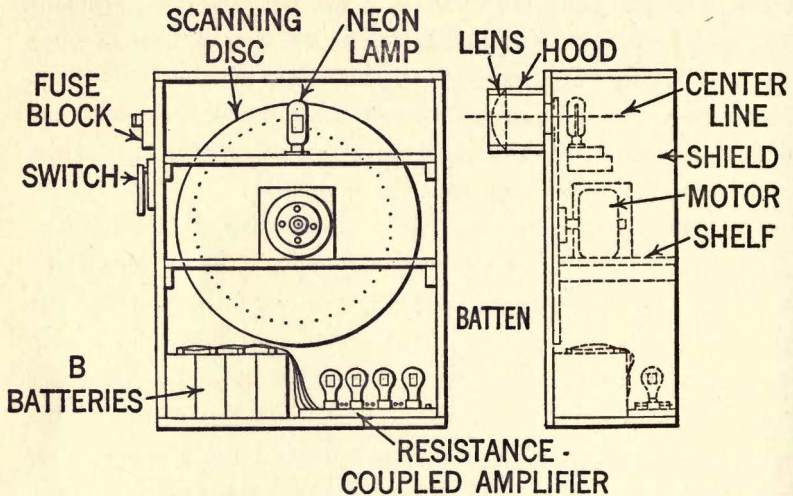

FIG. 78.—General arrangement of the parts making up a television receiver. The box is made of three-quarter-inch white pine painted black inside to prevent reflection and to sharpen the outline of the received picture.

In operating the television receiver it might perhaps be advisable to arrange a pair of 'phones on the output of the resistance coupled amplifier, using a double-pole double-throw switch so that a quick change can be made from the 'phones back to the neon tube. The use of these 'phones in tuning in signals will be found very valuable. After the signals have been tuned to a point of maximum amplitude, the motor is switched on and brought to speed. Upon looking through the lens the signals will be quite noticeable producing an unor-

ganized series of flashes. It remains for the operator to bring the receiving disc in step with the disc at the transmitter before the pictures will take organized definite form. The beginner may perhaps have a little difficulty in learning to manipulate the controlling resistance. The picture may be framed momentarily and at the next instant jump out of place. With the exercise of a little patience, however, the operator will soon learn to keep his picture in frame by constantly manipulating the controlling resistance.

INDEX

A

- Alexanderson system of synchronization, 175
- Amplification, audio for pictures, 85
- Amplifiers, audio, 115
 - audio, construction of, 89
 - audio, microphone effects in, 88
 - audio, resistors for, 90
 - for photo-cells, 64
 - induction in, 92
 - resistance-condenser, 93
 - resistance type, 86
 - resistance type, construction of, 131
 - shielding of, 88
- Analysis of scanning problem, 162
- Angstrom units, 61
- Aperture, circular, 100
 - square, 98
- Argon in photo-cells, 64
- Audio amplification, 85
 - amplifier, 115
 - construction of, 89
 - D. C. component in, 96
 - electrostatic interference, 92
 - induction in, 92
 - microphone effects in, 88
 - microphonic noises, 92
 - regeneration in, 87
 - resistance condenser, 93
 - resistance type, 86
 - resistance type, construction of, 131
 - resistors, for, 90
 - shielding of, 88
 - transformer, 86
 - vibration in, 92
 - circuits, ideal, 102
 - transformers, curves for, 87

B

- Bain, 37
- Baird noctovisor, 34
- scanning disc, 166

- Belin, 31
- Bell system of synchronizing, 178
 - photo telegraphy, 51
- Berzilius, 66
- Bidwell selenium cell, 146
- Braun's tube, 29
- Burt, Robert C., 74
 - photo-cell, 82
 - photo-cells, manufacture of, 74

C

- Caesium, use of, 71
- Cambridge photo-cell, 84
- Campbell, Swinton, Prof., 30
- Case-barium photo cell, 81
- Cathode ray, control of, 32
 - television, 26
 - tube, 27
- Cells, Kerr, 41
 - selenium, 66, 142
 - lag in, 143
 - resistance of, 142
 - with Wheatstone bridge, 145
- Characteristics of neon lamp, 122
 - photo-cells, 61, 73
- Circuits, ideal audio, 102
- Circular aperture, 100
- Clark system of synchronizing, 181
- Commercial telephotography, 6
- Commutator, special for neon lamp, 26
- Component, D.C. in audio amplifiers, 96
- Construction of audio amplifier, resistance, 90
- Control of cathode, 32
- Cooley, Austin, 36
 - Rayfoto, 44
- Corona discharge, 46
- Current from photo-cells, 62

D

- D.C. component in audio amplifiers, 96

Delay, envelope in transmission, 110

Diekmann, Max, 26

Discharge, corona, 46

through gases, 134

Distortion, optical, 98

picture, 48

Drum, scanning, 160

E

Einstein's equation for photo-cells, 60

Electrodes in neon lamps, 135

Electron theory, 68

Envelope delay, 110

F

Fluorescent, 31

Forks, tuning, 43

Fourier series, 95

Function of microphone, 17

neon lamp, 18

photo-electric cell, 17

Future of television, 9

G

Gases, discharge through, 134

luminosity of, 134

Gas-type, photo-cells, 63, 72

Geissler, work of, 134

General Electric photo-cell, 83

Gray, Frank, work of, 93

H

Hallwachs, 59

Holweck, M., 31

Horton, J. W., work of, 93

I

Illumination for scanning, 171

Ionization, photo-cells, 59

J

Jenkins scanning systems, 168

Jig for drilling scanning discs, 173

K

Kerr cell, 41

KH Photo-cell, 83

L

Lag in selenium cells, 143

Lamp, neon, 134

neon, characteristics of, 122

neon, connections to, 136

neon, theory of, 135

neon, voltage across, 127

Light valve, 52

Long, M. D., work of, 55

M

Manufacture of Burt photo-cells, 74

Mercadier selenium cell, 148

Microphone, function of, 17

Microphonic effects in audio amplifiers, 88

Mirrors, use of, 42

Motion picture, speed of projection, 24

Motors for synchronization, 175

N

Neon lamp, 134

characteristics of, 122

commutator, 26

connections to, 136

electrodes, 135

electrodes in, 141

function of, 18

lighting speed of, 19

polarity effect in, 141

producing synchronization with, 181

special, 25

striking voltage of, 135

theory of, 135

voltage across, 127

with capacity lighting, 26

Nicol prisms, 42

Nipkow, Paul, 4

Noctovisor, 34

O

Optical distortion, 98

P

Pattern, test for transmission, 102

Phasing signal, 43

- Photo-cells, 59
 amplifiers for, 64
 arcs, in, 64
 argon in, 64
 Burt, 82
 Cambridge, 84
 Case-Barium, 81
 characteristics of, 61, 73
 current from, 62
 discovery of, 67
 effect of wavelength on, 61
 Einstein's equation for, 60
 gas type, 63, 72
 General Electric, 83
 ionization in, 59
 KH, 83
 phototron, 81
 rare gases in, 64
 theory underlying operation, 68
 use of caesium in, 71
 use of relay with, 66
 Visitron, 82
 voltage-current relation, 63
 electric cell, function of, 17
 sensitive metals, 59
 telegraphic systems, early, 37
 telegraphy, Bell system, 51
 commercial use, 6
 Siemens-Karolus, 39
 simple systems, 37
 Phototron, 81
 Picture amplification, 85
 distortion of, 48
 size of television, 23
 Potassium iodide, use of, 37
 Potassium hydride, use in photo-cells, 70
 Prisms, Nicol, use of, 42
- Q
- Quantum theory, 72
- R
- Radio Corporation, telephotographic system, 57
 Rare gases in photo-cells, 64
 Rayfoto, 44
 Receiver, television, duplex, 25
 how to build, 195
 Recording television signals, 36
 Regeneration in amplifiers, 87
 Relay, use with photo-cell, 66
 Resistance-condenser audio amplifiers, 93

- Resistors for audio amplifiers, 90
 Rubidium, use of, 31

S

- Scanning, description of, 20
 discs, 154
 Baird, 166
 factors in designing, 160
 generating spiral for, 154
 holes, overlapping of, 165
 jig for drilling, 174
 metal for, 157
 number of holes in, 158
 size of, 158
 spiral holes, 154
 drum, 160
 illumination for, 171
 illumination with arc lights, 172
 problem, analysis of, 165
 systems, Jenkins, 168
 Screen fluorescent, 32
 Selenium, annealing, 149
 cells, 66, 142
 Bidwell, 146
 lag in, 143
 Mercadier, 148
 Townsend, 148
 Wein, 151
 with Wheatstone bridge, 145
 resistance of, 66, 142, 143
 Shielding audio amplifiers, 88
 Siemens-Karolus, phototelegraph, 39
 Signal, phasing, 43
 television, nature of, 25
 Smith, Willoughby, 66
 Speed of neon lamp, 19
 Square aperture, 98
 Striking voltage of neon lamps, 135
 Swinton, Prof. Campbell, 30
 Synchronization, 175
 Synchronizing, 43
 Bell system, 178
 Clark system, 181
 signals, 45, 46
 with crystals, 178
 with D.C. motors, 176
 with neon lamps, 181

T

- Table, cathode ray, 27
 Telephotography, Radio Corporation, 57
 Telescope, electric, 4

- Television of future, narrative, 9
 pictures, enlargement of, 25
 size of, 23
 speed of, 97
 speed of, scanning, 24
 receiver, duplex, 25
 receiver, how to make, 25, 195
 reception, simple description, 23
 signals, nature of, 25
 signals, recording, 36
 simple description of, 19
 system, Swinton, 30
 transmitter, how to build, 190
 transmitter, Max Diekmann, 26
 transmission, triple, 22
 with cathode rays, 26
 Test pattern, 105
 Theory, electron, 68
 Quantum, 72
 of photo-cells, 68
 Townsend selenium cell, 148
 Transformers, audio, curves for, 87
 Transmission, envelope delay, 110
 units, 94
 Transmitting television, 190
 Triple television transmission, 22
 TU, 94
 Tube, Braun's, 29
 vacuum, 92, 340
 Tuning forks, 43, 54
 Type, 131
- U
- Units, Angstrom, 61
 transmission, 94
- V
- Vacuum tube, 92, 340
 Valve, light, 52
 Visatron, photo-cell, 82
 Visual persistency, 23
- W
- Wavelength, effect on photo-cells, 61
 Wein selenium cell, 151

CATALOGUE

No. 29

Of the Latest and Best

Practical and Mechanical Books

**Including Aviation and
Automobile Books**



PRACTICAL BOOKS FOR PRACTICAL MEN

*Each Book in this Catalogue is written by an Expert
and is written so you can understand it, and
it will be sent prepaid to any address
on receipt of the price*

PUBLISHED BY

THE NORMAN W. HENLEY PUBLISHING CO.

2 WEST 45th STREET

NEW YORK, U. S. A.

Established 1890

INDEX

	PAGE		PAGE
Abrasives and Abrasive Wheels	25	Kerosene Carburetors	5
Accidents	24	Knots	22
Air Brakes	23, 24	Lathe Work	22
Alloys and Aluminum	3	Link Motions	25
Aluminum and Alloys	3	Liquid Air	23
Arithmetic	15, 27, 37	Locomotive Boilers	23
Automobile Books	3, 4, 5, 6	Locomotive Breakdowns	23, 24
Automobile Charts	6, 7	Locomotive Engineering	23, 24, 25
Automobile Ignition Systems	7	Machinist Books	25, 26, 27
Automobile Lighting	4	Manual Training	28
Automobile Repairing	4	Marine Gasoline Engines	20
Automobile Starting Systems	7	Mechanical Drawing	14
Automobile Trouble Charts	6, 7	Mechanical Movements	26
Automobile Welding	3	Metallurgy	3
Aviation	7, 8, 9	Metal Work	13
Bells, Electric	15	Mining	28
Boats	9, 27	Model Making	27
Boiler Room Chart	9	Motor Boats	29
Brazing	9	Motorcycles	7, 28
Cams	20	Motor Truck	5
Carburetion Trouble Chart	6	Patents	21
Carburetors	5	Pattern Making	29
Car Charts	10	Perfumery	29
Cement	13	Perspective	14
Change Gear	20	Plumbing	30, 31
Charts	6, 7, 9, 10	Questions on Heating	38
Chemistry	10	Radio	31, 32, 33
Clock and Watch Making	10	Railroad Accidents	24
Coal	23	Railroad Charts	10
Combustion	23	Recipe Book	35
Concrete	11, 12, 13	Refrigeration	21
Concrete for Farm Use	12	Repairing Automobiles	4
Concrete for Shop Use	12	Rope Work	22
Cosmetics	29	Rubber	36
Dictionary	13, 17	Rubber Stamps	36
Diesel Engines	13	Saw Filing	36
Dies	13	Saws, Management of	36
Drawing	14, 30	Screw Cutting	36
Drawing for Plumbers	30	Ship Models	27, 28
Dry Cleaning	14	Shop Practice	25, 26
Dynamo Building	15	Shop Tools	25
Electric Bells	15	Sketching Paper	14
Electric Dictionary	13, 17	Slide Valve	25
Electric Switchboards	16	Soap Making	35
Electric Toy Making	16	Soldering	9
Electric Wiring	15, 16, 18	Splices and Rope Work	22
Electricity	15, 16, 17, 18	Steam Engineering	36, 37, 38
Electroplating	18, 19	Steam Heating	38
Engine, Aviation	8	Steel	39
E-T Air Brake	24	Storage Batteries	18
Ford Automobile	4	Submarine Chart	10
Ford Tractor	4	Switchboards	16
Ford Trouble Chart	6	Tanning	39
Formulas and Recipes	34	Tapers	22
Fuel	23	Telegaphy, Wireless	31, 32
Gas Engines	19, 20	Thread-Cutting	26
Gas Tractor	40	Tinsmithing	39
Gearing and Cams	20	Tool Making	25
Glossary Aviation Terms	9	Toy Making	16
Heating	38	Tractive Power Chart	10
High Frequency Apparatus	17	Tractor, Gas	40
Horology	11	Vacuum Heating	38
Horse-Power Chart	10	Valve Setting	25
Hot Water Heating	38	Ventilation	38
House Wiring	15, 18	Watch Making	10
Hydraulics	21	Walschaert Valve Gear	24
Ice	21	Welding	3, 40
Ignition Systems	7	Wireless Telegraphy	31, 32
Ignition Trouble Chart	7	Wiring	15, 16, 18
India Rubber	36	Wiring Diagrams	16
Inventions	21		

Any of these books promptly sent prepaid to any address in the world on receipt of price.
HOW TO REMIT.—By Postal Money Order, Express Money Order, Bank Draft, or Registered Letter.

CATALOGUE OF GOOD, PRACTICAL BOOKS

ALLOYS AND ALUMINUM

METALS AND THEIR ALLOYS. By CHARLES VICKERS.

This work is especially practical, and is indispensable to everyone interested in metals and their alloys. The owner, manager, metallurgist, chemist or the worker in the shop will find here information that heretofore has been so difficult to obtain. It deals with metals from their origin to their useful application, both individually and as parts of alloys, used where strength, ductility, toughness, durability, lightness, color, hardness, cheapness, conductivity or bearing properties are demanded. The chapters on the casting of copper, the making of manganese bronze, aluminum bronze, aluminum alloys, red brass, yellow brass, steam metals, bearing metals, babbitts, white metals, phosphor bronze, gun metals and nickel alloys are crowded with formulas, tested and tried, together with the physical properties of the alloys and their casting peculiarities. It is a treasure-house of information for the metal worker, a convenient reference for the trained technical man, and a source of inspiration for the engineer who must select alloys most suitable for his work. 800 (6x9) pages. 110 illustrations. Price \$7.50

METALLURGY OF ALUMINUM AND ALUMINUM ALLOYS. By ROBERT J. ANDERSON.

This volume is a modern, authoritative treatise on the metallurgy of aluminum and its light alloys, and covers the subject fully from the mining of the ores to the fabrication and applications of the metal. While it has been written especially with a view to being practical, the more theoretical aspects of the subject have not been neglected. The origin, occurrence and distribution of aluminum ores and methods of mining are taken up in an early chapter, while the production of aluminum itself by modern electrolytic methods is also discussed. The uses and applications of the metal and its alloys are treated in detail. Considerable attention is given to the preparation of alloys for casting and working, and the most approved methods for preparing the principal alloys are taken up. The best methods of melting, together with descriptions of the principal types of furnaces, are given detailed treatment. The founding of aluminum alloys, including casting losses and defects, is discussed quite fully, and the information will be of great value to foundrymen in the successful production of castings. 900 pages (6x9). 295 illustrations. Price . . \$10.00

AUTOMOBILES

THE AUTOMOBILIST'S POCKET COMPANION AND EXPENSE RECORD. By VICTOR W. PAGÉ.

This book is not only valuable as a convenient cost record, but contains much information of value to motorists. Includes a condensed digest of auto laws of all States, a lubrication schedule, hints for care of storage battery, and care of tires, location of road troubles, anti-freezing solutions, horse-power table, driving hints and many useful tables and recipes of interest to all motorists. Pocket size. Price \$1.00

AUTOMOBILE WELDING WITH THE OXY-ACETYLENE FLAME. By M. KEITH DUNHAM.

Explains in a simple manner apparatus to be used, its care, and how to construct necessary shop equipment. Proceeds then to the actual welding of all automobile parts, in a manner understandable by everyone. Gives principles never to be forgotten. This book is of utmost value, since the perplexing problems arising when metal is heated to a melting point are fully explained and the proper methods to overcome them shown. 167 pages. Fully illustrated. Price \$1.50

HINTS AND TIPS FOR AUTOMOBILISTS. By VICTOR W. PAGÉ.

The book is ideal for the busy man or woman who wants to know about car operation and upkeep because of the economies possible when an automobile is intelligently operated. It contains many money-saving hints and a brief simple exposition of location and remedy of roadside troubles apt to occur under ordinary operating conditions. Price 75 cents

CATALOGUE OF GOOD, PRACTICAL BOOKS

AUTOMOBILE REPAIRING MADE EASY. By VICTOR W. PAGÉ, M.E.

A comprehensive, practical exposition of every phase of modern automobile repairing practice. Outlines every process incidental to motor car restoration. Gives plans for workshop construction, suggestions for equipment, power needed, machinery and tools necessary to carry on the business successfully. Tells how to overhaul and repair all parts of all automobiles. Everything is explained so simply that motorists and students can acquire a full working knowledge of automobile repairing. This work starts with the engine, then considers carburetion, ignition, cooling and lubrication systems. The clutch, change-speed gearing and transmission system are considered in detail. Contains instructions for repairing all types of axles, steering gears and other chassis parts. Many tables, short cuts in figuring and rules of practice are given for the mechanic. Explains fully valve and magneto timing, "tuning" engines, systematic location of trouble, repair of ball and roller bearings, shop kinks, first aid to injured and a multitude of subjects of interest to all in the garage and repair business. *This book contains special instructions on electric starting, lighting and ignition systems, tire repairing and rebuilding, autogenous welding, brazing and soldering, heat treatment of steel, latest timing practice, eight and twelve-cylinder motors, etc.* 5¼x8. Cloth. 1060 pages, 1,000 illustrations, 11 folding plates. Price \$3.00

WHAT IS SAID OF THIS BOOK:

"'Automobile Repairing Made Easy' is the best book on the subject I have ever seen and the only book I ever saw that is of any value in a garage."—Fred Jeffrey, Martinsburg, Neb.
"I thank you for 'Automobile Repairing Made Easy.' I do not think it could be excelled."—S. W. Gisriel, Director of Instruction, Y. M. C. A., Philadelphia, Pa.

AUTOMOBILE STARTING, LIGHTING AND IGNITION SYSTEMS. By VICTOR W. PAGÉ, M.E.

This practical volume has been written with special reference to the requirements of the non-technical reader desiring easily understood, explanatory matter, relating to all types of automobile ignition, starting and lighting systems. It can be understood by anyone, even without electrical knowledge, because elementary electrical principles are considered before any attempt is made to discuss features of the various systems. These basic principles are clearly stated and illustrated with simple diagrams. *All the leading systems of starting, lighting and ignition have been described and illustrated with the co-operation of the experts employed by the manufacturers.* Wiring diagrams are shown in both technical and non-technical forms. All symbols are fully explained. It is a comprehensive review of modern starting and ignition system practice, and includes a complete exposition of storage battery construction, care and repair. All types of starting motors, generators, magnetos, and all ignition or lighting system units are fully explained. The systems of cars already in use as well as those that are to come are considered. *Every person in the automobile business needs this volume.* 5¼x7¼. Cloth. 892 pages, 563 illustrations, over 325 Wiring Diagrams. Price . \$3.00

HOW TO RUN AN AUTOMOBILE. By VICTOR W. PAGÉ.

This treatise gives concise instructions for starting and running all makes of gasoline automobiles, how to care for them, and gives distinctive features of control. Describes every step for shifting gears, controlling engine, etc. Among the chapters contained are: I. Automobile Parts and Their Functions. II. General Starting and Driving Instructions. III. Control Systems—Care of Automobiles. Thoroughly illustrated. 178 pages. 72 illustrations. Price \$1.00

THE MODEL T FORD CAR, ITS CONSTRUCTION, OPERATION AND REPAIR, INCLUDING THE FORDSON FARM TRACTOR, F. A. LIGHTING AND STARTING SYSTEM, FORD MOTOR TRUCK. By VICTOR W. PAGÉ.

This is the most complete and practical instruction book ever published on the Ford car and Fordson tractor. All parts of the Ford Model T car and Fordson tractor are described and illustrated in a comprehensive manner. The construction is fully treated and operating principle made clear to everyone. Complete instructions for driving and repairing are given. To the New Revised Edition matter has been added on the Ford Truck and Tractor Conversion Sets and Genuine Fordson Tractor. All parts are described. All repair processes illustrated and fully explained. Written so all can understand—no theory, no guesswork. New revised and enlarged Edition just published. 187 illustrations, 455 pages, 2 large folding plates. Price . \$2.00

CATALOGUE OF GOOD, PRACTICAL BOOKS

THE MODERN GASOLINE AUTOMOBILE—ITS DESIGN, CONSTRUCTION, OPERATION AND MAINTENANCE. By VICTOR W. PAGÉ, M.E.

Just off the press—New 1928 EDITION. This is the most complete automobile book ever issued. Covers every recent improvement in relation to the automobile. A complete illustrated description of the new Ford Model A Car is included. This is the most complete, practical and up-to-date treatise on automobiles and their component parts ever published. All phases of automobile construction, operation and maintenance are fully and completely described and in language anyone can understand. Every part of all types of automobiles from light cars to heavy motor trucks and road tractors is described in a thorough manner; not only the automobile but every item of its equipment, accessories, tools needed, supplies and spare parts necessary for its upkeep, are fully discussed. It fully considers the power plant and its auxiliaries, also chassis and body construction in minute detail. All latest developments, such as high speed motors, sleeve valve engines, straight eight engines, air cleaners, fuel filters, oil separators and rectifiers and numerous other developments are considered in detail. The latest ignition, carburetor and lubrication practice is outlined. New forms of change speed gears, and final power transmission systems, and all latest chassis improvements are shown and described, such as four-wheel brakes, air brake systems, balloon tires, hypoid gear drive, four-wheel drive, front-wheel drive, etc.

The large demand for the previous editions of this book, this being the sixth time the book has been completely revised and entirely reset, makes it possible to treat in detail all the latest improvements, including the new Model A Ford car.

This book has been the standard for many years, and is used in practically every automobile school, college and university as a textbook—and by the United States Army and Navy. 1000 new illustrations. 1150 (6x9) pages. Price \$5.00

WHAT IS SAID OF THIS BOOK:

"It is the best book on the Automobile seen up to date."—J. H. Pile, Associate Editor *Automobile Trade Journal*.

"Every Automobile Owner has use for a book of this character."—*The Tradesman*.

"This book is superior to any treatise heretofore published on the subject."—*The Inventive Age*.

THE MODERN MOTOR TRUCK, ITS DESIGN, CONSTRUCTION, OPERATION AND REPAIR. By VICTOR W. PAGÉ.

Treats on all types of motor trucks and industrial tractors and trailers. It considers all types of trucks, gasoline and electric, and all varieties of truck bodies. This book is written in language everyone can understand and is not in any sense of the word a technical treatise. It is a practical volume that will make special appeal to the truck driver who seeks to better his position and to the mechanic charged with the repair and upkeep of trucks. The factory or business executive who wants to obtain a complete working knowledge of truck operation problems will find this book a reference work of great value. The truck salesman or automobile dealer will find that this work contains information that means money to them. All garage and service station men should have a copy of this book for reference because truck construction differs from passenger car design in many important respects. Anyone who reads this book is in touch with all the practical features that have been tested out in real service. Cloth (6x9) 962 pages, 750 illustrations. Price \$4.00

GASOLINE AND KEROSENE CARBURETORS, CONSTRUCTION, INSTALLATION AND ADJUSTMENT. By VICTOR W. PAGÉ.

This is a simple, comprehensive, and authoritative treatise for practical men explaining all basic principles pertaining to carburetion, showing how liquid fuels are vaporized and turned into gas for operating all types of internal combustion engines intended to operate on vapors of gasoline, kerosene, benzol, and alcohol. All leading types of carburetors are described in detail, special attention being given to the forms devised to use the cheaper fuels such as kerosene. Carburetion troubles, fuel system troubles, carburetor repairs and installation, electric primers and economizers, hot spot manifolds and all modern carburetor developments are considered in a thorough manner. Methods of adjusting all types of carburetors are fully discussed as well as suggestions for securing maximum fuel economy and obtaining highest engine power. This book is invaluable to repairmen, students, and motorists, as it includes the most complete exposition on kerosene carburetors ever published. The drawings showing carburetor construction are made from accurate engineering designs and show all parts of late types of carburetors. 213 pages. 89 illustrations. . . \$2.00

CATALOGUE OF GOOD, PRACTICAL BOOKS

AUTOMOBILE, AVIATION AND MOTORCYCLE CHARTS

AVIATION CHART—LOCATION OF AIRPLANE POWER PLANT TROUBLES MADE EASY. By MAJOR VICTOR W. PAGÉ, A.S., S.C.U.S.R.

A large chart outlining all parts of a typical airplane power plant, showing the points where trouble is apt to occur and suggesting remedies for the common defects. Intended especially for aviators and aviation mechanics on school and field duty. This chart was published during the year 1917. Price 30 cents

AUTOMOBILE CHARTS

GASOLINE ENGINE TROUBLES MADE EASY—A CHART SHOWING SECTIONAL VIEW OF GASOLINE ENGINE. Compiled by VICTOR W. PAGÉ, M.E.

It shows clearly all parts of a typical six-cylinder gasoline engine of the four-cycle type. It outlines distinctly all parts liable to give trouble and also details the derangements apt to interfere with smooth engine operation.

Valuable to students, motorists, mechanics, repairmen, garagemen, automobile salesmen, chauffeurs, motorboat owners, motor-truck and tractor drivers, aviators, motorcyclists, and all others who have to do with gasoline power plants.

It simplifies location of all engine troubles, and while it will prove invaluable to the novice, it can be used to advantage by the more expert. It should be on the walls of every public and private garage, automobile repair shop, club house or school. It can be carried in the automobile or pocket with ease, and will insure against loss of time when engine trouble manifests itself.

This sectional view of engine is a complete review of all motor troubles. It is prepared by a practical motorist for all who motor. More information for the money than ever before offered. No details omitted. Size 25x38 inches. Price 35 cents

LOCATION OF CARBURETION TROUBLES MADE EASY. Compiled by VICTOR W. PAGÉ, M.E.

This chart shows all parts of a typical pressure feed fuel supply system and gives causes of trouble, how to locate defects and means of remedying them. Size 24x38 inches. Price 35 cents

LOCATION OF FORD ENGINE TROUBLES MADE EASY. Compiled by VICTOR W. PAGÉ, M.E.

This shows clear sectional views depicting all portions of the Ford power plant and auxiliary groups. It outlines clearly all parts of the engine, fuel supply system, ignition group and cooling system, that are apt to give trouble, detailing all derangements that are liable to make an engine lose power, start hard or work irregularly. This chart is valuable to students, owners, and drivers, as it simplifies location of all engine faults. Of great advantage as an instructor for the novice, it can be used equally well by the more expert as a work of reference and review. It can be carried in the toolbox or pocket with ease and will save its cost in labor eliminated the first time engine trouble manifests itself. Prepared with special reference to the average man's needs and is a practical review of all motor troubles because it is based on the actual experience of an automobile engineer-mechanic with the mechanism the chart describes. It enables the non-technical owner or operator of a Ford car to locate engine derangements by systematic search, guided by easily recognized symptoms instead of by guesswork. It makes the average owner independent of the roadside repair shop when touring. Must be seen to be appreciated. Size 25x38 inches. Printed on heavy bond paper. Price 35 cents

LUBRICATION OF THE MOTOR CAR CHASSIS. Compiled by VICTOR W. PAGÉ, M.E.

This chart presents the plan view of a typical six-cylinder chassis of standard design and all parts are clearly indicated that demand oil, also the frequency with which they must be lubricated and the kind of oil to use. A practical chart for all interested in motor-car maintenance. Size 24x38 inches. Price 35 cents

CATALOGUE OF GOOD, PRACTICAL BOOKS

LOCATION OF IGNITION SYSTEM TROUBLES MADE EASY. Compiled by VICTOR W. PAGÉ, M.E.

In this diagram all parts of a typical double ignition system using battery and magneto current are shown, and suggestions are given for readily finding ignition troubles and eliminating them when found. Size 24x38 inches. Price **35 cents**

LOCATION OF STARTING AND LIGHTING SYSTEM FAULTS. Compiled by VICTOR W. PAGÉ, M.E.

The most complete chart yet devised, showing all parts of the modern automobile starting, lighting and ignition systems, giving instructions for systematic location of all faults in wiring, lamps, motor or generator, switches and all other units. Invaluable to motorists, chauffeurs and repairmen. Size 24x38 inches. Price . **35 cents**

MOTORCYCLE TROUBLES MADE EASY. Compiled by VICTOR W. PAGÉ, M.E.

A chart showing sectional view of a single-cylinder gasoline engine. This chart simplifies location of all power-plant troubles. A single-cylinder motor is shown for simplicity. It outlines distinctly all parts liable to give trouble and also details the derangements apt to interfere with smooth engine operation. This chart will prove of value to all who have to do with the operation, repair or sale of motorcycles. No details omitted. Size 30x20 inches. Price **35 cents**

AVIATION

TWO NEW AVIATION BOOKS

Just off the press. Give complete information on every phase of aeronautics. Learn to Fly by flying, but prepare yourself in the ground work by Home Study, for experience in the air. Valuable books for reference. They will start you right.

MODERN AIRCRAFT, DESIGN-CONSTRUCTION-OPERATION AND REPAIR. By MAJOR VICTOR PAGÉ.

A book for all students of Aircraft. Just off the press. This book of 855 pages is the most complete work ever issued on Aviation. It is written in simple language for the Practical Man. It shows just how any airplane flies and is controlled, outlines and describes all important parts of the plane and just what they do and how they are used. Covers the commercial possibilities of aircraft types, outlines their spheres of usefulness and considers the cost of flying. The equipment of airports, airways and landing fields is touched upon and a complete and easily understood explanation of all branches of aerodynamics as well as a complete glossary of terms used in aeronautics are included. This booklet includes a description of the Ryan NYP monoplane flown from New York to Paris by Colonel Charles Lindbergh and the Wright-Bellanca monoplane flown by Clarence Chamberlain from New York to Berlin. It also describes fully the Fokker tri-motored monoplane used by Commander Byrd in his Polar and trans-oceanic flights. The Wright air-cooled motor and the navigating instruments that made these Epochal Flights possible are fully described.

Adopted as an Instruction Book in fifty aviation schools and colleges. 855 pages. Over 400 engravings. Price **\$5.00**

WHAT IS SAID OF THIS BOOK

"Your new book, 'Modern Aircraft' is a wonder. Very complete and up-to-the-minute. Highly interesting and a valuable contribution to the field of aviation. I feel that the author and publisher both have done fully 100 per cent. justice to this splendid book which really should be in the hands of every person interested in the progress of Modern Aircraft."
(Signed) FRED W. DOBE,

1951 Lawrence Ave., Chicago, Ill.

CATALOGUE OF GOOD, PRACTICAL BOOKS

EVERYBODY'S AVIATION GUIDE. By VICTOR W. PAGÉ.

A Popular Book at a Popular Price. This book, written in the form of a series of lessons or instructions, starts the reader at the beginning of the subject, outlines the elementary aerodynamical rules for the various forms of flying machines, describes typical conventional and unconventional forms of heavier-than-air and lighter-than-air craft, the functions of the various parts of an airplane, and covers briefly the various types of airplane power plants in both air and water-cooled forms. It outlines fully all types of land and sea flying machines, their control systems and the methods of flying. These are all fully illustrated.

While piloting an airplane can be learned only by actual practice, this book will give the reader the various steps in airplane control and will serve as a very valuable introduction to the entire subject of flying for the non-technical person who wishes to be able to fly an airplane just as he now operates an automobile for business or pleasure. 247 pages, 140 illustrations, 600 questions and answers on aviation. Price. \$2.00

AVIATION BOOKS AT SPECIAL PRICES

As very large editions of books below were printed when published, and in order to reduce our stock we are offering these books at reduced prices.

Although these books were published a few years ago, they contain much information of value at the present time, and in order that those interested in aviation may avail themselves of these volumes we are now offering them at reduced prices to clear out the editions.

The principles of operation described in these books apply just as well to the latest types of airplanes and airships and their engines which have changed only in minor details from the forms illustrated, and they are just as valuable to the reader today. The beginner or student will get much information at low cost from the following books.

A B C OF AVIATION. By MAJOR VICTOR W. PAGÉ.

This book describes the basic principles of aviation, tells how a balloon or dirigible is made and why it floats in the air. Describes how an airplane flies. It shows in detail the different parts of an airplane, what they are and what they do. Describes all types of airplanes and how they differ in construction; as well as detailing the advantages and disadvantages of different types of aircraft. It includes a complete dictionary of aviation terms and clear drawings of leading airplanes. The reader will find simple instructions for unpacking, setting up, and rigging airplanes. A full description of airplane control principles is given and methods of flying are discussed at length.

This book answers every question one can ask about modern aircraft, their construction and operation. A self-educator on aviation without an equal. 274 pages-130 specially made illustrations with 7 plates. Price \$1.25

AVIATION ENGINES—DESIGN; CONSTRUCTION; REPAIR. By MAJOR VICTOR W. PAGÉ, A.S., S.C.U.S.R.

This treatise, written by a recognized authority on all of the practical aspects or internal combustion engine construction, maintenance, and repair, fills the need as no other book does. The matter is logically arranged; all descriptive matter is simply expressed and copiously illustrated, so that anyone can understand airplane engine operation and repair even if without previous mechanical training. This work is invaluable for anyone desiring to become an aviator or aviation mechanic. Rotary types, such as the Gnome Monosoupape, and LeRhone, are fully explained, as well as the Vee and radial types. The subjects of carburetion, ignition, cooling, and lubrication also are covered in a thorough manner. The chapters on repair and maintenance are distinctive and found in no other book on this subject. Not a technical book, but a practical, easily understood work of reference for all interested in aeronautical science. 589 pages. 253 illustrations. Price, net . . . \$1.25

CATALOGUE OF GOOD, PRACTICAL BOOKS

APPLIED AERODYNAMICS. By G. P. THOMPSON.

This is a scientific and mathematical treatise that has a special appeal to the student and engineer who are seeking exact information on the aerodynamics of heavier-than-air craft and data on airplane design testing. In addition to a very full discussion of the qualities which determine the speed and rate of climb of an aeroplane and the method by which they can be calculated, special attention is paid to stability—a problem now fairly well understood, and to controllability—our knowledge of which is at present in a much more elementary state. Attention is directed to the numerous directions in which further information is required, especially in the form of full-scale experiments. 312 pages (7 x 10). Illustrated with over 142 Diagrams and Graphic Charts. Price \$5.00

GLOSSARY OF AVIATION TERMS—ENGLISH-FRENCH; FRENCH-ENGLISH. By MAJOR VICTOR W. PAGÉ, A.S., S.C.U.S.R., and LIEUT. PAUL MONTARIOL, of the French Flying Corps.

A complete glossary of practically all terms used in aviation, having lists in both French and English with equivalents in either language. Price, . . . 50 cents

BOAT BUILDING

MINIATURE BOAT BUILDING. By ALBERT C. LEITCH.

Covering the construction of working models of racing sail and power boats by amateurs. A concise and complete treatise written in understandable language covering marine model making in general and the specific design and construction of numerous famous miniature racing sail and power boats. The boats illustrated and described have been developed from an engineering point of view rather than from a toy angle. In this book the authors have illustrated and described step by step, the best model making practice, from the selection of the raw material to the completed boats. Complete designs for steam power plants, including tubular boilers and blow torch for firing them. One, two and four cylinder engines are also fully described. 500 specially prepared engravings. 242 pages. Price \$3.00

BRAZING AND SOLDERING

BRAZING AND SOLDERING. By JAMES F. HOBART.

The only book that shows you just how to handle any job of brazing or soldering that comes along; it tells you what mixture to use, how to make a furnace if you need one. Full of valuable kinks. The fifth edition of this book has just been published, and to it much new matter and a large number of tested formulae for all kinds of solders and fluxes have been added. Illustrated. 35 cents

SOLDERING AND BRAZING. By RAYMOND FRANCIS YATES.

This treatise gives all the necessary "kinks" that will enable one to accomplish successful soldering. If a mechanic has not succeeded in his soldering, this book may tell him just what he needs to produce good work—something that he may heretofore have forgotten. Price 75 cents

CHARTS

BOILER ROOM CHART. By GEO. L. FOWLER.

A chart—size 14x28 inches—showing in isometric perspective the mechanisms belonging in a modern boiler room. The various parts are shown broken or removed, so that the internal construction is fully illustrated. Each part is given a reference number, and these, with the corresponding name, are given in a glossary printed at the sides. 35 cents

CATALOGUE OF GOOD, PRACTICAL BOOKS

GONDOLA CAR CHART.

A chart showing the anatomy of a gondola car, having every part of the car numbered and its proper reference name given in a reference list. 35 cents

PASSENGER CAR CHART.

A chart showing the anatomy of a passenger-car, having every part of the car numbered and its proper name given in a reference list. 35 cents

STEEL HOPPER BOTTOM COAL CAR.

A chart showing the anatomy of a steel Hopper Bottom Coal Car, having every part of the car numbered and its proper name given in a reference list. 35 cents

TRACTIVE POWER CHART.

A chart whereby you can find the tractive power or drawbar pull of any locomotive without making a figure. Shows what cylinders are equal, how driving wheels and steam pressure affect the power. What sized engine you need to exert a given drawbar pull or anything you desire in this line. 50 cents

HORSE-POWER CHART

Shows the horse-power of any stationary engine without calculation. No matter what the cylinder diameter of stroke, the steam pressure of cut-off, the revolutions, or whether condensing or non-condensing, it's all there. Easy to use, accurate, and saves time and calculations. Especially useful to engineers and designers. 50 cents

SUBMARINE CHART.

A cross-section view, showing clearly and distinctly all the interior of a Submarine of the latest type. You get more information from this chart, about the construction and operation of a Submarine, than in any other way. No details omitted—everything is accurate and to scale. All the machinery and devices fitted in a Submarine Boat are shown. 35 cents

CHEMISTRY

HOW TO MAKE AND USE A SMALL CHEMICAL LABORATORY. By RAYMOND FRANCIS YATES.

The treatise covers all of the essentials of elementary chemistry. The law of definite proportions, solutions, crystalloids, colloids, electrolysis, etc., are explained. The second part of the book is devoted to chemical and electro-chemical experiments. Only those experiments that will tend to broaden the reader's knowledge of chemistry in general have been chosen. Price 75 cents

CLOCK AND WATCHMAKING

CLOCKMAKING: PAST AND PRESENT. By C. F. C. GORDON.

With which is incorporated the more important portion of "Clocks, Watches, and Bells," by the late Lord Grimthorpe, relating to Turret Clocks and Gravity Escapements. By G. F. C. Gordon, M.A., A.M.I.C.E., Superintendent of Workshops of the Engineering Department of Cambridge University. A practical book of special interest to the Clockmaker, Repairer, Dealer and Collector, in which the author endeavors to cover topics which either have not been covered before, or which from his own experience require more attention than they have hitherto received. 240 pages. Fully illustrated by Diagrams and plates of Long Case, Bracket and other Clocks, Dials, Hands, etc. Price \$5.00

CLOCK REPAIRING AND MAKING. By F. J. GARRARD.

Practical Watchmaker. Author of "Watch Repairing, Cleaning and Adjusting." A practical handbook dealing with Tools, Materials, and Methods used in cleaning and repairing all kinds of English and Foreign Timepieces, Striking and Chimney Clocks, and the making of English Clocks. 168 pages. Fourth edition. Illustrated by 120 engravings. Price \$3.00

CATALOGUE OF GOOD, PRACTICAL BOOKS

ELECTRICAL HOROLOGY. By H. R. LANGMAN and A. BALL.

180 pages profusely illustrated. A practical manual on the application of the principles and practices of electricity to horological instruments and machines for the measurement and transmission of time with an account of the earliest electrically-driven clock mechanism. 180 pages. Illustrated. Price \$3.00

THE WATCHMAKER'S HANDBOOK. By CLAUDIUS SAUNIER.

Translated from the French by Cladius Saunier, and enlarged by Julien Triplin, F.R.A.S., and Edward Rigg, M.A. A workshop companion for those engaged in watchmaking and the allied mechanical arts. As an encyclopedia for the practical watchmaker and repairer this work stands paramount. The chapter on practical receipts alone is a mine of information. Over 500 pages. New and revised edition. 14 folding plates. Price \$5.00

WATCH REPAIRING AND MAKING. By F. J. GARRARD.

Practical Watchmaker. Author of "Watch Repairing, Cleaning and Adjusting." Covers the Cleaning and Repairing of Watches. Treats on the materials and tools used. Shows how to alter and adjust all kinds of English and Foreign Watches, Repeaters, Chronographs and Marine Chronometers. 214 pages. Seventh edition. Illustrated by over 200 engravings. Price \$3.00

CONCRETE

CONCRETE WORKERS' REFERENCE BOOKS. A SERIES OF POPULAR HANDBOOKS FOR CONCRETE USERS. Prepared by A. A. HOUGHTON.

The author, in preparing this Series, has not only treated on the usual types of construction, but explains and illustrates molds and systems that are not patented, but which are equal in value and often superior to those restricted by patents. These molds are very easily and cheaply constructed and embody simplicity, rapidity of operation, and the most successful results in the molded concrete. Each of these books is fully illustrated, and the subjects are exhaustively treated in plain English.

CONCRETE WALL FORMS. By A. A. HOUGHTON.

A new automatic wall clamp is illustrated with working drawings. Other types of wall forms, clamps, separators, etc., are also illustrated and explained. (No. 1 of Series) 75 cents

CONCRETE FLOORS AND SIDEWALKS. By A. A. HOUGHTON.

The molds for molding squares, hexagonal and many other styles of mosaic floor and sidewalk blocks are fully illustrated and explained. (No. 2 of Series) . . . 75 cents

PRACTICAL CONCRETE SILO CONSTRUCTION. By A. A. HOUGHTON.

Complete working drawings and specifications are given for several styles of concrete silos, with illustrations of molds for monolithic and block silos. The tables, data, and information presented in this book are of the utmost value in planning and constructing all forms of concrete silos. (No. 3 of Series) 75 cents

MOLDING CONCRETE CHIMNEYS, SLATE AND ROOF TILES. By A. A. HOUGHTON.

The manufacture of all types of concrete slate and roof tile is fully treated. Valuable data on all forms of reinforced concrete roofs are contained within its pages. The construction of concrete chimneys by block and monolithic systems is fully illustrated and described. A number of ornamental designs of chimney construction with molds are shown in this valuable treatise. (No. 4 of Series.) 75 cents

MOLDING AND CURING ORNAMENTAL CONCRETE. By A. A. HOUGHTON.

The proper proportions of cement and aggregates for various finishes, also the method of thoroughly mixing and placing in the molds, are fully treated. An exhaustive treatise on this subject that every concrete worker will find of daily use and value (No. 5 of Series.) 75 cents

CATALOGUE OF GOOD, PRACTICAL BOOKS

CONCRETE MONUMENTS, MAUSOLEUMS AND BURIAL VAULTS. By A. A. HOUGHTON.

The molding of concrete monuments to imitate the most expensive cut stone is explained in this treatise, with working drawings of easily built molds. Cutting inscriptions and designs are also fully treated. (No. 6 of Series.) . . . 75 cents

MOLDING CONCRETE BATHTUBS, AQUARIUMS AND NATATORIUMS. By A. A. HOUGHTON.

Simple molds and instruction are given for molding many styles of concrete bathtubs, swimming-pools, etc. These molds are easily built and permit rapid and successful work. (No. 7 of Series.) . . . 75 cents

CONCRETE BRIDGES, CULVERTS AND SEWERS. By A. A. HOUGHTON.

A number of ornamental concrete bridges with illustrations of molds are given. A collapsible center or core for bridges, culverts and sewers is fully illustrated with detailed instructions for building. (No. 8 of Series.) . . . 75 cents

CONSTRUCTING CONCRETE PORCHES. By A. A. HOUGHTON.

A number of designs with working drawings of molds are fully explained so anyone can easily construct different styles of ornamental concrete porches without the purchase of expensive molds. (No. 9 of Series.) . . . 75 cents

MOLDING CONCRETE FOUNTAINS AND LAWN ORNAMENTS. By A. A. HOUGHTON.

The molding of a number of designs of lawn seats, curbing, hitching posts, pergolas, sun dials and other forms of ornamental concrete for the ornamentation of lawns and gardens, is fully illustrated and described. (No. 11 of Series.) . . . 75 cents

CONCRETE FOR THE FARM AND IN THE SHOP. By H. COLIN CAMPBELL, C.E., E.M.

A new book illustrating and describing in plain, simple language many of the numerous applications of concrete within the range of the home worker. Among the subjects treated are:

Principles of reinforcing; methods of protecting concrete so as to insure proper hardening; home-made mixers; mixing by hand and machine; form construction, described and illustrated by drawings and photographs; construction of concrete walls and fences; concrete fence posts; concrete gate posts; corner posts; clothes line posts; grape arbor posts; tanks; troughs; cisterns; hog wallows; feeding floors and barnyard pavements; foundations; well curbs and platforms; indoor floors; sidewalks; steps; concrete hotbeds and cold frames; concrete slab roofs; walls for buildings; repairing leaks in tanks and cisterns, etc., etc. A number of convenient and practical tables for estimating quantities, and some practical examples, are also given. (5 x 7). 149 pages, 51 illustrations. Price . . . \$1.00

CONCRETE FROM SAND MOLDS. By A. A. HOUGHTON.

A Practical Work treating on a process which has heretofore been held as a trade secret by the few who possessed it, and which will successfully mold every and any class of ornamental concrete work. The process of molding concrete with sand molds is of the utmost practical value, possessing the manifold advantages of a low cost of molds, the ease and rapidity of operation, perfect details to all ornamental designs, density and increased strength of the concrete, perfect curing of the work without attention and the easy removal of the molds regardless of any undercutting the design may have. 192 pages. Fully illustrated. Price . . . \$2.00

ORNAMENTAL CONCRETE WITHOUT MOLDS. By A. A. HOUGHTON.

The process for making ornamental concrete without molds has long been held as a secret, and now, for the first time, this process is given to the public. The book reveals the secret and is the only book published which explains a simple, practical method whereby the concrete worker is enabled, by employing wood and metal templates of different designs, to mold or model in concrete any Cornice, Archivolt, Column, Pedestal, Base Cap, Urn or Pler in a monolithic form—right upon the job. These may be molded in units or blocks, and then built up to suit the specifications demanded. This work is fully illustrated, with detailed engravings. Price . \$2.00

CATALOGUE OF GOOD, PRACTICAL BOOKS

POPULAR HANDBOOK FOR CEMENT AND CONCRETE USERS. By MYRON H. LEWIS.

The author has brought together in this work all the salient matter of interest to the user of concrete and its many diversified products. The matter is presented in logical and systematic order, clearly written, fully illustrated and free from involved mathematics. Everything of value to the concrete user is given, including kinds of cement employed in construction, concrete architecture, inspection and testing, waterproofing, coloring and painting, rules, tables, working and cost data. The book comprises thirty-three chapters 430 pages, 126 illustrations. Price \$3.00

DICTIONARIES

STANDARD ELECTRICAL DICTIONARY. By T. O'CONNOR SLOANE.

An indispensable work to all interested in electrical science. Suitable alike for the student and professional. A practical handbook of reference containing definitions of about 5000 distinct words, terms and phrases. The definitions are terse and concise and include every term used in electrical science. Recently issued. An entirely new edition. Should be in the possession of all who desire to keep abreast with the progress of this branch of science. Complete, concise and convenient. 790 pages. 497 illustrations. New Revised and Enlarged Edition. Price \$5.00

DIESEL ENGINE

DIESEL ENGINES: THEIR APPLICATION AND OPERATION—MARINE—LOCOMOTIVE—STATIONARY. By DAVID L. JONES.

This is the latest book on the subject of Diesel Engines written purely from a practical standpoint, in simple language, to enable the operator and the student to grasp the principles of this type of machine and to bring out the advantages of this form of prime mover in its various fields of operation.

It should be found upon the desk of every power station operating engineer and every student of mechanical engineering, as it contains data that is invaluable, and is the only American book containing an illustrated chapter on the application of the Diesel Engine to Railway Service. The importance of the Diesel Engine cannot be over-estimated and the progressive engineer will find it his duty to extend his knowledge into the Diesel Engine field. Among the chapters are: The Diesel Engine—Elementary Thermodynamics—Elementary Principles—Comparative Efficiencies—Details of Construction—Spray Valves—Fuel Pumps, Governors, Fuel Systems—Valve Gears—Starting and Reversing Gears—Lubricating and Circulating Water Systems—Indicator Cards and Engine Testing—Operation of Diesel Engines—Representative Types of Engines—Representative Types of Engines continued—A 1000 Horse Power Submarine Diesel Engine—Diesel Engines for Railroad Service—Diesel Electric Drive for Ships—Properties of Lubricating and Fuel Oils—Marine Rules for Vessels Propelled by Diesel Oil Engines. 565 pages. 341 illustrations. Price \$5.00

DIES—METAL WORK

DIES: THEIR CONSTRUCTION AND USE FOR THE MODERN WORKING OF SHEET METALS. By J. V. WOODWORTH.

A most useful book, and one which should be in the hands of all engaged in the press-working of metals; treating on the Designing, Constructing, and Use of Tools, Fixtures and Devices, together with the manner in which they should be used in the Power Press, for the cheap and rapid production of the great variety of sheet-metal articles now in use. It is designed as a guide to the production of sheet-metal parts at the minimum of cost with the maximum of output. The hardening and tempering of Press tools and the classes of work which may be produced to the best advantage by the use of dies in the power press are fully treated. Its 546 illustrations show dies, press fixtures and sheet-metal working devices, the descriptions of which are so clear and practical that all metal-working mechanics will be able to understand how to design, construct and use them. 7th Edition. 426 pages, 546 illustrations. Price. . . \$4.00

CATALOGUE OF GOOD, PRACTICAL BOOKS

DRY CLEANING

PRACTICAL DRY CLEANER, SCOURER AND GARMENT DYER. By WILLIAM T. BRANNT.

The sixth corrected edition of this work is just off the press. It is the most comprehensive and complete reference and text book for cleaners and dyers published and treats fully on cleaning plant design and construction; purification of benzine dry cleaning; spot and stain removal; wet cleaning, including the cleaning of Palm Beach suits and other summer fabrics; finishing cleaned fabrics; cleaning and dyeing furs, skins, rugs and mats; cleaning and dyeing feathers; cleaning, dyeing and blocking straw, felt and Panama hats; cleaning and dyeing rugs and carpets; bleaching and stripping garments; bleaching and dyeing straw and straw hats; cleaning and dyeing gloves; garment dyeing; analysis of textile fabrics; practical chemistry for the dry cleaner and garment dyer. 578 pages, 41 illustrations. Price \$3.00

DRAWING—SKETCHING PAPER

LINEAR PERSPECTIVE SELF-TAUGHT. By HERMAN T. C. KRAUS.

This work gives the theory and practice of linear perspective, as used in architectural, engineering and mechanical drawings. Persons taking up the study of the subject by themselves will be able, by the use of the instruction given, to readily grasp the subject, and by reasonable practice become good perspective draftsmen. The arrangement of the book is good; the plate is on the left-hand, while the descriptive text follows on the opposite page, so as to be readily referred to. The drawings are on sufficiently large scale to show the work clearly and are plainly figured. There is included a self-explanatory chart which gives all information necessary for the thorough understanding of perspective. This chart alone is worth many times over the price of the book. 2d Revised and enlarged Edition. \$3.00

PRACTICAL PERSPECTIVE. By RICHARDS and COLVIN.

Shows just how to make all kinds of mechanical drawings in the only practical perspective isometric. Makes everything plain so that any mechanic can understand a sketch or drawing in this way. Saves time in the drawing room, and mistakes in the shops. Contains practical examples of various classes of work. 5th Edition. \$1.00

SELF-TAUGHT MECHANICAL DRAWING AND ELEMENTARY MACHINE

DESIGN. By F. L. SYLVESTER, M.E., Draftsman, with additions by ERIC OBERG, associate editor of "Machinery."

This is a practical treatise on Mechanical Drawing and Machine Design, comprising the first principles of geometric and mechanical drawing, workshop mathematics, mechanics, strength of materials and the calculations and design of machine details. The author's aim has been to adapt this treatise to the requirements of the practical mechanic and young draftsman and to present the matter in as clear and concise a manner as possible. To meet the demands of this class of students, practically all the important elements of machine design have been dealt with, and in addition algebraic formulas have been explained, and the elements of trigonometry treated in the manner best suited to the needs of the practical man. The book is divided into 22 chapters, and in arranging the material, mechanical drawing, pure and simple, has been taken up first, as a thorough understanding of the principles of representing objects facilitates the further study of mechanical subjects. This is followed by the mathematics necessary for the solution of the problems in machine design which are presented later, and a practical introduction to theoretical mechanics and the strength of materials. The various elements entering into machine design, such as cams, gears, sprocket-wheels, cone pulleys, bolts, screws, couplings, clutches, shafting and fly-wheels, have been treated in such a way as to make possible the use of the work as a text-book for a continuous course of study. 345 pages, 237 engravings. Price \$2.50

A NEW SKETCHING PAPER.

A new specially ruled paper to enable you to make sketches or drawings in isometric perspective without any figuring or fussing. It is being used for shop details as well as for assembly drawings, as it makes one sketch do the work of three, and no workman can help seeing just what is wanted. Pads of 40 sheets, 6x9 inches, 40 cents. Pads of 40 sheets, 9x12 inches, 75 cents; 40 sheets, 12x18, Price \$1.50

CATALOGUE OF GOOD, PRACTICAL BOOKS

ELECTRICITY

ARITHMETIC OF ELECTRICITY. By Prof. T. O'CONNOR SLOANE.

A practical treatise on electrical calculations of all kinds reduced to a series of rules, all of the simplest forms, and involving only ordinary arithmetic; each rule illustrated by one or more practical problems, with detailed solution of each one. This book is classed among the most useful works published on the science of electricity, covering as it does the mathematics of electricity in a manner that will attract the attention of those who are not familiar with algebraical formulas. 22nd Edition. 196 pages. Price \$1.50

COMMUTATOR CONSTRUCTION. By WM. BAXTER, JR.

The business end of any dynamo or motor of the direct current type is the commutator. This book goes into the designing, building, and maintenance of commutators, shows how to locate troubles and how to remedy them; everyone who fusses with dynamos needs this. 5th Edition 35 cents

DYNAMO BUILDING FOR AMATEURS, OR HOW TO CONSTRUCT A FIFTY-WATT DYNAMO. By ARTHUR J. WEED, Member of N. Y. Electrical Society.

A practical treatise showing in detail the construction of a small dynamo or motor, the entire machine work of which can be done on a small foot lathe. Dimensioned working drawings are given for each piece of machine work, and each operation is clearly described. This machine, when used as a dynamo, has an output of fifty watts; when used as a motor it will drive a small drill press or lathe. It can be used to drive a sewing machine on any and all ordinary work. The book is illustrated with more than sixty original engravings showing the actual construction of the different parts. Among the contents are chapters on: 1. Fifty-Watt Dynamo. 2. Side Bearing Rods. 3. Field Punching. 4. Bearings. 5. Commutator. 6. Pulley. 7. Brush Holders. 8. Connection Board. 9. Armature Shaft. 10. Armature. 11. Armature Winding. 12. Field Winding. 13. Connecting and Starting. Price, cloth, \$1.00

ELECTRIC BELLS. By M. B. SLEEPER.

A complete treatise for the practical worker in installing, operating, and testing bell circuits, burglar alarms, thermostats, and other apparatus used with electric bells. Both the electrician and the experimenter will find in this book new material which is essential in their work. Tools, bells, batteries, unusual circuits, burglar alarms, annunciators, systems, thermostats, circuit breakers, time alarms, and other apparatus used in bell circuits are described from the standpoints of their application, construction, and repair. The detailed instructions for building the apparatus will appeal to the experimenter particularly. The practical worker will find the chapters on Wiring Calculation of Wire Sizes and Magnet Windings, Upkeep of Systems and the Location of Faults of the greatest value in their work. 124 pages. Fully illustrated. Price 75 cents

HOUSE WIRING. By THOMAS W. POPPE.

This work describes and illustrates the actual installation of Electric Light Wiring, the manner in which the work should be done, and the method of doing it. The book can be conveniently carried in the pocket. It is intended for the Electrician, Helps, and Apprentice. It solves all Wiring Problems and contains nothing that conflicts with the rulings of the National Board of Fire Underwriters. It gives just the information essential to the Successful Wiring of a Building. Among the subjects treated are Locating the Meter. Panel Boards. Switches. Plug Receptacles. Brackets. Ceiling Fixtures. The Meter Connections. The Feed Wires. The Steel Armored Cable System. The Flexible Steel Conduit System. The Ridig Conduit System. A digest of the National Board of Fire Underwriters' rules relating to metallic wiring systems. Various switching arrangements explained and diagrammed. The easiest method or testing the Three- and Four-way circuits explained. The grounding of all metallic wiring systems and the reason for doing so shown and explained. The insulation of the metal parts of lamp fixtures and the reason for the same described and illustrated. 208 pages. 5th Edition, revised and enlarged. 160 illustrations. Flexible cloth. Price \$1.00

CATALOGUE OF GOOD, PRACTICAL BOOKS

ELECTRICIANS' HANDY BOOK. By Prof. T. O'CONNOR SLOANE.

This work is intended for the practical electrician who has to make things go. The entire field of electricity is covered within its pages. Among some of the subjects treated are: The Theory of the Electric Current and Circuit, Electro-Chemistry, Primary Batteries, Storage Batteries, Generation and Utilization of Electric Powers, Alternating Current, Armature Winding, Dynamos and Motors, Motor Generators, Operation of the Central Station Switchboards, Safety Appliances, Distribution of Electric Light and Power, Street Mains, Transformers, Arc and Incandescent Lighting, Electric Measurements, Photometry, Electric Railways, Telephony, Bell-Wiring, Electric-Plating, Electric Heating, Wireless Telegraphy, etc. It contains no useless theory; everything is to the point. It teaches you just what you want to know about electricity. It is the standard work published on the subject. Forty-six chapters, 600 engravings. New 5th Edition, Revised and Enlarged. Price \$4.00

ELECTRIC TOY MAKING, DYNAMO BUILDING, AND ELECTRIC MOTOR CONSTRUCTION. By Prof. T. O'CONNOR SLOANE.

This work treats of the making at home of electrical toys, electrical apparatus, motors, dynamos and instruments in general, and is designed to bring within the reach of young and old the manufacture of genuine and useful electrical appliances. The work is especially designed for amateurs and young folks. Thousands of our young people are daily experimenting, and busily engaged in making electrical toys and apparatus of various kinds. The present work is just what is wanted to give the much needed information in a plain, practical manner, with illustrations to make easy the carrying out of the work. 21st Edition. 254 pages, 118 illustrations. Price \$1.50

ELECTRIC WIRING, DIAGRAMS AND SWITCHBOARDS. By NEWTON HARRISON.

A thoroughly practical treatise covering the subject of Electric Wiring in all its branches, including explanations and diagrams which are thoroughly explicit and greatly simplify the subject. Practical, every-day problems in wiring are presented and the method of obtaining intelligent results clearly shown. Only arithmetic is used. Ohm's law is given a simple explanation with reference to wiring for direct and alternating currents. The fundamental principle of drop of potential in circuits is shown with its various applications. The simple circuit is developed with the position of mains, feeders and branches; their treatment as a part of a wiring plan and their employment in house wiring clearly illustrated. Some simple facts about testing are included in connection with the wiring. Molding and conduit work are given careful consideration; and switchboards are systematically treated, built up and illustrated, showing the purpose they serve, for connection with the circuits, and to shunt and compound wound machines. The simple principles of switchboard construction, the development of the switchboard, the connections of the various instruments, including the lightning arrester, are also plainly set forth.

Alternating current wiring is treated, with explanations of the power factor, conditions calling for various sizes of wire, and a simple way of obtaining the sizes for single-phase, two-phase and three-phase circuits. This is the only complete work issued showing and telling you what you should know about direct and alternating current wiring. It is a ready reference. The work is free from advanced technicalities and mathematics, arithmetic being used throughout. It is in every respect a handy, well-written, instructive, comprehensive volume on wiring for the wireman, foreman, contractor, or electrician. 3rd edition, revised and enlarged. 315 pages; 137 illustrations. Price \$2.50

EXPERIMENTAL HIGH FREQUENCY APPARATUS — HOW TO MAKE AND USE IT. By THOMAS STANLEY CURTIS.

This book tells you how to build simple high frequency coils for experimental purpose in the home, school laboratory, or on the small lecture platform. The book is really a supplement to the same author's "High Frequency Apparatus." The experimental side only is covered in this volume, which is intended for those who want to build small coils giving up to an eighteen-inch spark. The book contains valuable information for the physics or the manual training teacher who is on the lookout for interesting projects for his boys to build or experiment with. The apparatus is simple, cheap and perfectly safe, and with it some truly startling experiments may be performed. Among the contents are: Induction Coil Outfits Operated on Battery Current. Kicking Coil Apparatus. One-Half Kilowatt Transformer Outfit. Parts and Materials, etc., etc. 69 pages. Illustrated. Price 50 cents

CATALOGUE OF GOOD, PRACTICAL BOOKS

ELECTRICITY SIMPLIFIED. By Prof. T. O'CONNOR SLOANE.

The object of "Electricity Simplified" is to make the subject as plain as possible and to show what the modern conception of electricity is; to show how two plates of different metal, immersed in acid, can send a message around the globe; to explain how a bundle of copper wire rotated by a steam engine can be the agent in lighting our streets, to tell what the volt, ohm and ampere are, and what high and low tension mean; and to answer the questions that perpetually arise in the mind in this age of electricity. 15th Revised Edition. 218 pages. Illustrated. Price . . . \$1.50

EVERYBODY'S ELECTRICAL HANDBOOK. By EDWARD J. VOLK, Practical Electrician.

Anyone with the aid of this book can do almost any of the small electrical jobs about the home. Everything is written in plain language. It tells how to start, what to use, and every move until this work is completed. In repairing electrical devices it tells where to locate the trouble and how to repair it. You will find this book different from any other book you have ever read. Should be in every home. Second edition. Pocket size. 135 pages. 78 Illustrations. Price . . . \$1.00

HIGH FREQUENCY APPARATUS, ITS CONSTRUCTION AND PRACTICAL APPLICATION. By THOMAS STANLEY CURTIS.

The most comprehensive and thorough work on this interesting subject ever produced. The book is essentially practical in its treatment and it constitutes an accurate record of the researches of its author over a period of several years, during which time dozens of coils were built and experimented with. The work has been divided into six basic parts. The first two chapters tell the uninitiated reader what the high frequency current is, what it is used for, and how it is produced. The second section, comprising four chapters, describes in detail the principles of the transformer, condenser, spark gap, and oscillation transformer, and covers the main points in the design and construction of these devices as applied to the work in hand. The third section covers the construction of small high frequency outfits designed for experimental work in the home laboratory or in the classroom. The fourth section is devoted to electro-therapeutic and X-Ray apparatus. The fifth describes apparatus for the cultivation of plants and vegetables. The sixth section is devoted to a comprehensive discussion of apparatus of large size for use upon the stage in spectacular productions. The closing chapter, giving the current prices of the parts and materials required for the construction of the apparatus described, is included with a view to expediting the purchase of the necessary goods. The Second Edition includes much new matter along the line of home-made therapeutic outfits for physicians' use. The matter on electro plant culture has also been elaborated upon. Second Revised and Enlarged Edition. 266 pages. New second edition. Fully illustrated. Price . . . \$3.00

STANDARD ELECTRICAL DICTIONARY. By T. O'CONNOR SLOANE.

An indispensable work to all interested in electrical science. Suitable alike for the student and professional. A practical handbook of reference containing definitions of about 5,000 distinct words, terms and phrases. The definitions are terse and concise and include every term used in electrical science. Recently issued. An entirely new edition. Should be in the possession of all who desire to keep abreast with the progress of this branch of science. In its arrangement and typography the book is very convenient. The word or term defined is printed in black-faced type which readily catches the eye, while the body of the page is in a smaller but distinct type. The definitions are well worded, and so as to be understood by the non-technical reader. The general plan seems to be to give an exact, concise definition, and then amplify and explain in a more popular way. Synonyms are also given, and references to other words and phrases are made. A very complete and accurate index of fifty pages is at the end of the volume; and as this index contains all synonyms, and as all phrases are indexed in every reasonable combination of words, reference to the proper place in the body of the book is readily made. It is difficult to decide how far a book of this character is to keep the dictionary form, and to what extent it may assume the encyclopedia form. For some purposes, concise, exactly worded definitions are needed; for other purposes, more extended descriptions are required. This book seeks to satisfy both demands, and does it with considerable success. Complete, concise and convenient. 790 pages. 497 illustrations. New Revised and Enlarged Edition. Price \$5.00

CATALOGUE OF GOOD, PRACTICAL BOOKS

HOW TO BECOME A SUCCESSFUL ELECTRICIAN. By Prof. T. O'CONNOR SLOANE.

Every young man who wishes to become a successful electrician should read this book. It tells in simple language the surest and easiest way to become a successful electrician. The studies to be followed, methods of work, field of operation and the requirement, of the successful electrician are pointed out and fully explained. Every young engineer will find this an excellent stepping stone to more advanced works on electricity which he must master before success can be attained. Many young men become discouraged at the very outset by attempting to read and study books that are far beyond their comprehension. This book serves as the connecting link between the rudiments taught in the public schools and the real study of electricity. It is interesting from cover to cover. 19th Revised Edition, just issued. 205 pages. Illustrated. Price \$1.50

STORAGE BATTERIES SIMPLIFIED. By VICTOR W. PAGÉ, M.S.A.E.

A complete treatise on storage battery operating principles, repairs and applications. The greatly increasing application of storage batteries in modern engineering and mechanical work has created a demand for a book that will consider this subject completely and exclusively. This is the most thorough and authoritative treatise ever published on this subject. It is written in easily understandable, non-technical language so that anyone may grasp the basic principles of storage battery action as well as their practical industrial applications. All electric and gasoline automobiles use storage batteries. Every automobile repairman, dealer or salesman should have a good knowledge of maintenance and repair of these important elements of the motor car mechanism. This book not only tells how to charge, care for and rebuild storage batteries but also outlines all the industrial uses. Learn how they run street cars, locomotives and factory trucks. Get an understanding of the important functions they perform in submarine boats, isolated lighting plants, railway switch and signal systems, marine applications, etc. This book tells how they are used in central station standby service, for starting automobile motors and in ignition systems. Every practical use of the modern storage battery is outlined in this treatise. 258 pages. Fully illustrated. Price \$2.00

WIRING A HOUSE. By HERBERT PRATT.

Shows a house already built; tells how to start about wiring it; where to begin; what wire to use; how to run it according to insurance rules; in fact, just the information you need. Directions apply equally to a shop. We have just issued an enlarged edition of this popular work, which has been brought up to date. The same treatment of the subject which is distinguished by simplicity, combined with a correct presentation of the subject, from the standpoint of compliance with the Underwriter's Code, and which characterized the earlier editions of the book is adhered to. The wiring as given is based on the twenty-five watt tungsten filament lamp, now as much the standard as was the old sixteen candle carbon filament lamp of former days. The modern tungsten filament gas-filled lamp of today has changed the whole phase of electric wiring of the home and factory, and this book not only tells of the wiring for an installation, but also gives some very up-to-date suggestions on the subjects of selection of electroliers and fittings, location of lamps and base sockets with many practical hints for the location of lamps and plug sockets to get the best results. Seventh edition which has been entirely revised, and very much enlarged. Price . . . 50 cents

ELECTROPLATING

THE MODERN ELECTROPLATER. By KENNETH M. COGGESHALL.

This is one of the most complete and practical books on electroplating and allied processes that has been published as a text for the student or professional plater. It is written in simple language and explains all details of electroplating in a concise yet complete manner. It starts at the beginning and gives an elementary outline of electricity and chemistry as relates to plating, then considers shop layout and equipment and gives all the necessary information to do reliable and profitable electroplating in a modern commercial manner. Full instructions are given for the preparation and finishing of the work and formulae and complete directions are included for making all kinds of plating solutions, many of these having been trade secrets until published in this instruction manual. Anyone interested in practical plating and metal finishing will find this book a valuable guide and complete manual of the art. Cloth. 142 illustrations. 276 pages. Price \$3.00

CATALOGUE OF GOOD, PRACTICAL BOOKS

ELECTRO-DEPOSITION OF METALS. By DR. GEORGE LANGBEIN and WILLIAM T. BRANNT.

The ninth corrected edition of this work contains everything anyone wants to know about the plating and finishing of metals, and is practically an encyclopedia of the industry. It is written in plain language with special reference to the needs of the practical plater and metal finisher, and gives hundreds of tested formulas for solutions, many of which have heretofore been considered trade secrets. It is the master treatise on electro-plating, galvanizing, metal coloring, lacquering and electrotyping, and covers every detail of the present advanced state of the art in its everyday applications. The interest of most readers will doubtless center in the main division of the volume—the practical part, which presents the industry in all its aspects from the arrangement of electro-plating establishments to actual methods used in the deposition of various metals. It is here that the plater finds a treasury of practice that he may turn to direct account in his business. As a work of reference it is unapproached by any similar work in our language. The formulas alone are worth many times the cost of the book to anyone interested in plating and other metal finishing methods. 863 pages. 185 illustrations. Price \$7.50

FUEL

COMBUSTION OF COAL AND THE PREVENTION OF SMOKE. By Wm. M. BARR.

This book has been prepared with special reference to the generation of heat by the combustion of the common fuels found in the United States, and deals particularly with the conditions necessary to the economic and smokeless combustion of bituminous coals in Stationary and Locomotive Steam Boilers. The presentation of this important subject is systematic and progressive. The arrangement of the book is in a series of practical questions to which are appended accurate answers, which describe in language, free from technicalities, the several processes involved in the furnace combustion of American fuels; it clearly states the essential requisites for perfect combustion, and points out the best methods for furnace construction for obtaining the greatest quantity of heat from any given quality of coal. 5th Edition. Nearly 350 pages, fully illustrated. Price. . . . \$1.50

GAS AND OIL ENGINES

THE GASOLINE ENGINE ON THE FARM: ITS OPERATION, REPAIR AND USES. By XENO W. PUTNAM.

This is a practical treatise on the Gasoline and Kerosene Engine intended for the man who wants to know just how to manage his engine and how to apply it to all kinds of farm work to the best advantage. This book abounds with hints and helps for the farm and suggestions for the home and housewife. There is so much of value in this book that it is impossible to adequately describe it in such small space. Suffice to say that it is the kind of a book every farmer will appreciate and every farm home ought to have. Includes selecting the most suitable engine for farm work, its most convenient and efficient installation, with chapters on troubles, their remedies, and how to avoid them. The care and management of the farm tractor in plowing, harrowing, harvesting and road grading are fully covered; also plain directions are given for handling the tractor on the road. Special attention is given to relieving farm life of its drudgery by applying power to the disagreeable small tasks which must otherwise be done by hand. Many home-made contrivances for cutting wood, supplying kitchen, garden, and barn with water, loading, hauling and unloading hay, delivering grain to the bins or the feed trough are included; also full directions for making the engine milk the cows, churn, wash, sweep the house and clean the windows, etc. Very fully illustrated with drawings of working parts and cuts showing Stationary, Portable and Tractor Engines doing all kinds of farm work. All money-making farms utilize power. Learn how to utilize power by reading the pages of this book. It is an aid to the result getter, invaluable to the up-to-date farmer, student, blacksmith, implement dealer and, in fact, all who can apply practical knowledge of stationary gasoline engines or gas tractors to advantage. 530 pages. Nearly 180 engravings. Price. \$3.00

CATALOGUE OF GOOD, PRACTICAL BOOKS

GASOLINE ENGINES: THEIR OPERATION, USE AND CARE. By A. HYATT VERRILL.

The simplest, latest and most comprehensive popular work published on Gasoline Engines, describing what the Gasoline Engine is; its construction and operation; how to install it; how to select it; how to use it and how to remedy troubles encountered. Intended for Owners, Operators and Users of Gasoline Motors of all kinds. This work fully describes and illustrates the various types of Gasoline Engines used in Motor Boats, Motor Vehicles and Stationary Work. The parts, accessories and appliances are described, with chapters on ignition, fuel, lubrication, operation and engine troubles. Special attention is given to the care, operation and repair of motors, with useful hints and suggestions on emergency repairs and makeshifts. A complete glossary of technical terms and an alphabetically arranged table of troubles and their symptoms form most valuable and unique features of this manual. Nearly every illustration in the book is original, having been made by the author. Every page is full of interest and value. A book which you cannot afford to be without. 275 pages. 152 specially made engravings. Price \$2.00

GAS ENGINE CONSTRUCTION, OR HOW TO BUILD A HALF-HORSE-POWER GAS ENGINE. By PARSELL and WEED.

A practical treatise of 300 pages describing the theory and principles of the action of Gas Engines of various types and the design and construction of a half-horse-power Gas Engine, with illustrations of the work in actual progress, together with the dimensioned working drawings, giving clearly the sizes of the various details; for the student, the scientific investigator, and the amateur mechanic. This book treats of the subject more from the standpoint of practice than that of theory. The principles of operation of Gas Engines are clearly and simply described, and then the actual construction of a half-horse-power engine is taken up, step by step, showing in detail the making of the Gas Engine. 3d Edition. 300 pages. Price \$3.00

HOW TO RUN AND INSTALL GASOLINE ENGINES. By C. VON CULIN.

Revised and enlarged edition just issued. The object of this little book is to furnish a pocket instructor for the beginner, the busy man who uses an engine for pleasure or profit, but who does not have the time or inclination for a technical book, but simply to thoroughly understand how to properly operate, install and care for his own engine. The index refers to each trouble, remedy, and subject alphabetically. Being a quick reference to find the cause, remedy and prevention for troubles, and to become an expert with his own engine. Pocket size. Paper binding. Price 25 cents

GEARING AND CAMS

CHANGE GEAR DEVICES. By OSCAR E. PERRIGO.

A practical book for every designer, draftsman, and mechanic interested in the invention and development of the devices for feed changes on the different machines requiring such mechanism. All the necessary information on this subject is taken up, analyzed, classified, sifted, and concentrated for the use of busy men who have not the time to go through the masses of irrelevant matter with which such a subject is usually encumbered and select such information as will be useful to them. It shows just what has been done, how it has been done, when it was done, and who did it. It saves time in hunting up patent records and re-inventing old ideas. 3rd Edition. 101 pages \$1.50

CAMS, LAYOUT AND DRAFTING. By LOUIS ROULLON.

A practical work on various forms of cams and their design including useful suggestions for laying out and drafting typical forms. Contents: 1. Laying Out Cams. 2. Drafting Cam Curve. 3. Heart Shape Cam. 4. Positive Motion Cam. 5. Irregular Motion Cam. 6. Toe and Lift Cam. 7. Double Contact Cam. 8. Cylindrical Cam. 9. Cam Belt Shifter. 10. Gas Engine Cams. 11. Cam for Mushroom Follower. 12. Non-reversible Cams. 13. Reversible Cam. 14. Variable Motion. 15. Harmonic Motion. 16. Motion Diagram. 17. Flat Reciprocating Cam. 18. Sleeve Cam. 19. Face and Drum Cams. 20. Device for Cam Drafting. Revised and Enlarged Edition. Paper cover. Price 75 cents

CATALOGUE OF GOOD, PRACTICAL BOOKS

HYDRAULICS

HYDRAULIC ENGINEERING. By GARDNER D. HISCOX.

A treatise on the properties, power, and resources of water for all purposes. Including the measurement of streams, the flow of water in pipes or conduits; the horse-power of falling water, turbine and impact water-wheels, wave motors, centrifugal, reciprocating and air-lift pumps. With 300 figures and diagrams and 36 practical tables. All who are interested in water-works development will find this book a useful one, because it is an entirely practical treatise upon a subject of present importance, and cannot fail in having a far-reaching influence, and for this reason should have a place in the working library of every engineer. Among the subjects treated are: Historical Hydraulics, Properties of Water, Measurement of the Flow of Streams; Flowing Water Surface Orifices and Nozzles; Flow of Water in Pipes; Siphons of Various Kinds; Dams and Great Storage Reservoirs; City and Town Water Supply; Wells and Their Reinforcement; Air Lift Methods of Raising Water; Artesian Wells, Irrigation of Arid Districts; Water Power; Water-Wheels; Pumps and Pumping Machinery; Reciprocating Pumps; Hydraulic Power Transmission; Hydraulic Mining; Canals; Dredges; Conduits and Pipe Lines; Marine Hydraulics; Tidal and Sea Wave Power, etc. 320 pages. Price \$4.50

ICE AND REFRIGERATION

POCKETBOOK OF REFRIGERATION AND ICE MAKING. By A. J. WALLIS-TAYLOR.

This is one of the latest and most comprehensive reference books published on the subject of refrigeration and cold storage. It explains the properties and refrigerating effect of the different fluids in use, the management of refrigerating machinery and the construction and insulation of cold rooms with their required pipe surface for different degrees of cold; freezing mixtures and non-freezing brines, temperatures of cold rooms for all kinds of provisions, cold storage charges for all classes of goods, ice making and storage of ice, data and memoranda for constant reference by refrigerating engineers, with nearly one hundred tables containing valuable references to every fact and condition required in the installment and operation of a refrigerating plant. New edition just published. 216 pages, 44 illustrations, Price \$2.00

INVENTIONS—PATENTS

INVENTORS' MANUAL, HOW TO MAKE A PATENT PAY.

This is a book designed as a guide to inventors in perfecting their inventions, taking out their patents and disposing of them. It is not in any sense a Patent Solicitor's Circular nor a Patent Broker's Advertisement. No advertisements of any description appear in the work. It is a book containing a quarter of a century's experience of a successful inventor, together with notes based upon the experience of many other inventors.

Among the subjects treated in this work are: How to Invent. How to Secure a Good Patent. Value of Good Invention. How to Exhibit an Invention. How to Interest Capital. How to Estimate the Value of a Patent. Value of Design Patents. Value of Foreign Patents. Value of Small Inventions. Advice on Selling Patents. Advice on the Formation of Stock Companies. Advice on the Formation of Limited Liability Companies. Advice on Disposing of Old Patents. Advice as to Patent Attorneys. Advice as to Selling Agents. Forms of Assignments, License and Contracts. State Laws Concerning Patent Rights. 1920 Census of the United States by Counts of Over 10,000 Population. Third revised edition. 138 pages. Illustrated. Price \$1.50

CATALOGUE OF GOOD, PRACTICAL BOOKS

KNOTS

KNOTS, SPLICES AND ROPE WORK. By A. HYATT VERRILL.

This is a practical book giving complete and simple directions for making all the most useful and ornamental knots in common use, with chapters on Splicing, Pointing, Seizing, Servicing, etc. This book is fully illustrated with one hundred and fifty original engravings, which show how each knot, tie or splice is formed, and its appearance when finished. The book will be found of the greatest value to Campers, Yachtsmen, Travelers, Boy Scouts, in fact, to anyone having occasion to use or handle rope or knots for any purpose. The book is thoroughly reliable and practical, and is not only a guide, but a teacher. It is the standard work on the subject. Among the contents are: 1. Cordage, Kinds of Rope. Construction of Rope, Parts of Rope Cable and Bolt Rope. Strength of Rope, Weight of Rope. 2. Simple Knots and Bends. Terms Used in Handling Rope. Seizing Rope. 3. Ties and Hitches. 4. Noose, Loops and Mooring Knots. 5. Shortenings, Grommets and Salvages. 6. Lashings, Seizings and Splices. 7. Fancy Knots and Rope Work. Third revised edition. 104 pages. 154 original engravings. Price \$1.00

LATHE WORK

LATHE DESIGN, CONSTRUCTION, AND OPERATION, WITH PRACTICAL EXAMPLES OF LATHE WORK. By OSCAR E. FERRIGO.

A new revised edition, and the only complete American work on the subject, written by a man who knows not only how work ought to be done, but who also knows how to do it, and how to convey this knowledge to others. It is strictly up-to-date in its descriptions and illustrations. Lathe history and the relations of the lathe to manufacturing are given; also a description of the various devices for feeds and thread cutting mechanisms from early efforts in this direction to the present time. Lathe design is thoroughly discussed, including back gearing, driving cones, thread-cutting gears, and all the essential elements of the modern lathe. The classification of lathes is taken up, giving the essential differences of the several types of lathes including, as is usually understood, engine lathes, bench lathes, speed lathes, forge lathes, gap lathes, pulley lathes, forming lathes, multiple-spindle lathes, rapid-reduction lathes, precision lathes, turret lathes, special lathes, electrically-driven lathes, etc. In addition to the complete exposition on construction and design, much practical matter on lathe installation, care and operation has been incorporated in the enlarged 1915 edition. All kinds of lathe attachments for drilling, milling, etc., are described and complete instructions are given to enable the novice machinist to grasp the art of lathe operation as well as the principles involved in design. A number of difficult machining operations are described at length and illustrated. The new edition has nearly 500 pages and 350 illustrations. Price \$3.00

LATHE WORK FOR BEGINNERS. By RAYMOND FRANCIS YATES.

A simple, straightforward text-book for those desiring to learn the operation of a wood-turning or metal-turning lathe. The first chapter tells how to choose a lathe and all of the standard types on the market are described. Simple and more advanced lathe work is thoroughly covered and the operation of all lathe attachments such as millers, grinders, polishers, etc., is described. The treatment starts from the very bottom and leads the reader through to a point where he will be able to handle the larger commercial machines with very little instruction. The last chapter of the book is devoted to things to make on the lathe and includes a model rapid-fire naval gun. This is the only book published in this country that treats lathe work from the standpoint of the amateur mechanic. 162 illustrations. About 250 pages. Price \$2.00

TURNING AND BORING TAPERS. By FRED H. COLVIN.

There are two ways to turn tapers; the right way and one other. This treatise has to do with the right way; it tells you how to start the work properly, how to set the lathe, what tools to use and how to use them, and forty and one other little things that you should know. Fifth edition. Price 35 cents

CATALOGUE OF GOOD, PRACTICAL BOOKS

LIQUID AIR

LIQUID AIR AND THE LIQUEFACTION OF GASES. By T. O'CONNOR SLOANE.

This book gives the history of the theory, discovery, and manufacture of Liquid Air, and contains an illustrated description of all the experiments that have excited the wonder of audiences all over the country. It shows how liquid air, like water, is carried hundreds of miles and is handled in open buckets. It tells what may be expected from it in the near future.

A book that renders simple one of the most perplexing chemical problems of the century. Startling developments illustrated by actual experiments.

It is not only a work of scientific interest and authority, but is intended for the general reader, being written in a popular style—easily understood by everyone. Third edition. Revised and Enlarged. 394 pages. New Edition. Price . . . \$3.00

LOCOMOTIVE ENGINEERING

AIR-BRAKE CATECHISM. By ROBERT H. BLACKALL.

This book is a standard text-book. It covers the Westinghouse Air-Brake Equipment, including the No. 5 and the No. 6 E. T. Locomotive Brake Equipment; the K (Quick Service) Triple Valve for Freight Service; and the Cross-Compound Pump. The operation of all parts of the apparatus is explained in detail, and a practical way of finding their peculiarities and defects, with a proper remedy, is given. It contains 2,000 questions with their answers, which will enable any railroad man to pass any examination on the subject of Air Brakes. Endorsed and used by air-brake instructors and examiners on nearly every railroad in the United States. New edition. 710 pages, fully illustrated with colored plates and diagrams. Price . . . \$4.00

COMBUSTION OF COAL AND THE PREVENTION OF SMOKE. By Wm. M. BARR.

This book has been prepared with special reference to the generation of heat by the combustion of the common fuels found in the United States and deals particularly with the conditions necessary to the economic and smokeless combustion of bituminous coal in Stationary and Locomotive Steam Boilers.

Presentation of this important subject is systematic and progressive. The arrangement of the book is in a series of practical questions to which are appended accurate answers, which describe in language free from technicalities the several processes involved in the furnace combustion of American fuels; it clearly states the essential requisites for perfect combustion, and points out the best methods of furnace construction for obtaining the greatest quantity of heat from any given quality of coal. Nearly 350 pages, fully illustrated. Price . . . \$1.50

DIARY OF A ROUND-HOUSE FOREMAN. By T. S. REILLY.

This is the greatest book of railroad experiences ever published. Containing a fund of information and suggestions along the line of handling men, organizing, etc., that one cannot afford to miss. 158 pages. Price . . . \$1.25

LOCOMOTIVE BOILER CONSTRUCTION. By FRANK A. KLEINHANS.

The construction of boilers in general is treated, and, following this, the locomotive boiler is taken up in the order in which its various parts go through the shop. Shows all types of boilers used; gives details of construction; practical facts, such as life of riveting, punches and dies; work done per day, allowance for bending and flanging sheets, and other data. Including the recent Locomotive Boiler Inspection Laws and Examination Questions with their answers for Government Inspectors. Contains chapters on Laying Out Work; Flanging and Forging; Punching; Shearing; Plate Planing; General Tables; Finishing Parts; Bending; Machinery Parts; Riveting; Boiler Details; Smoke Box Details; Assembling and Calking; Boiler Shop Machinery, etc., etc.

There isn't a man who has anything to do with boiler work, either new or repair work, who doesn't need this book. The manufacturer, superintendent, foreman, and boiler worker—all need it. No matter what the type of boiler, you'll find a mint of information that you wouldn't be without. 451 pages, 334 illustrations, five large folding plates. Price . . . \$3.50

CATALOGUE OF GOOD, PRACTICAL BOOKS

LOCOMOTIVE BREAKDOWNS AND THEIR REMEDIES. By GEO. L. FOWLER. Revised by WM. W. WOOD, Air-Brake Instructor. Just issued. Revised pocket edition.

It is out of the question to try and tell you about every subject that is covered in this pocket edition of Locomotive Breakdowns. Just imagine all the common troubles that an engineer may expect to happen some time, and then add all of the unexpected ones, troubles that could occur, but that you have never thought about, and you will find that they are all treated with the very best methods of repair. Walschaert Locomotive Valve Gear Troubles, Electric Headlight Troubles, as well as Questions and Answers on the Air Brake are all included. 293 pages. 8th Revised Edition. Fully illustrated. \$1.50

PREVENTION OF RAILROAD ACCIDENTS, OR SAFETY IN RAILROADING
By GEORGE BRADSHAW.

This book is a heart-to-heart talk with Railroad Employees, dealing with facts, not theories, and showing the men in the ranks, from every-day experience, how accidents occur and how they may be avoided. The book is illustrated with seventy original photographs and drawings showing the safe and unsafe methods of work. No visionary schemes, no ideal pictures. Just plain facts and Practical Suggestions are given. Every railroad employee who reads the book is a better and safer man to have in railroad service. It gives just the information which will be the means of preventing many injuries and deaths. All railroad employees should procure a copy; read it, and do your part in preventing accidents. 169 pages. Pocket size. Fully illustrated. Price 50 cents

THE WALSCHAERT AND OTHER MODERN RADIAL VALVE GEARS FOR LOCOMOTIVES. By WM. W. WOOD.

If you would thoroughly understand the Walschaert Valve Gear you should possess a copy of this book, as the author takes the plainest form of a steam engine—a stationary engine in the rough, that will only turn its crank in one direction—and from it builds up—with the reader's help—a modern locomotive equipped with the Walschaert Valve Gear, complete. The points discussed are clearly illustrated; two large folding plates that show the positions of the valves of both inside or outside admission type, as well as the links and other parts of the gear when the crank is at nine different points in its revolution, are especially valuable in making the movement clear. These employ sliding cardboard models which are contained in a pocket in the cover.

The book is divided into five general divisions, as follows: 1. Analysis of the gear. 2. Designing and erecting the gear. 3. Advantages of the gear. 4. Questions and answers relating to the Walschaert Valve Gear. 5. Setting valves with the Walschaert Valve Gear; the three primary types of locomotive valve motion; modern radial valve gears other than the Walschaert; the Hobart All-free Valve and Valve Gear, with questions and answers on breakdowns; the Baker-Pilliod Valve Gear; the Improved Baker-Pilliod Valve Gear, with questions and answers on breakdowns.

The questions with full answers given will be especially valuable to firemen and engineers in preparing for an examination for promotion. 245 pages. Fully illustrated. Third Revised New Edition. Price \$2.50

WESTINGHOUSE E-T AIR-BRAKE INSTRUCTION POCKET BOOK. By WM. W. WOOD, Air-Brake Instructor.

Here is a book for the railroad man, and the man who aims to be one. It is without doubt the only complete work published on the Westinghouse E-T Locomotive Brake Equipment. Written by an Air-Brake Instructor who knows just what is needed. It covers the subject thoroughly. Everything about the New Westinghouse Engine and Tender Brake Equipment, including the standard No. 5 and the Perfected No. 6 style of brake, is treated in detail. Written in plain English and profusely illustrated with Colored Plates, which enable one to trace the flow of pressures throughout the entire equipment. The best book ever published on the Air Brake. Equally good for the beginner and the advanced engineer. Will pass anyone through any examination. It informs and enlightens you on every point. Indispensable to every engineman and trainman.

Contains examination questions and answers on the E-T equipment. Covering what the E-T Brake is. How it should be operated. What to do when defective. Not a question can be asked of the engineman up for promotion, on either the No. 5 or the No. 6 E-T equipment, that is not asked and answered in the book. If you want to thoroughly understand the E-T equipment get a copy of this book. It covers every detail. Makes Air-Brake troubles and examinations easy. Second Revised and Enlarged Edition. Price \$2.50

CATALOGUE OF GOOD, PRACTICAL BOOKS

LINK MOTIONS, VALVES AND VALVE SETTING. By FRED H. COLVIN, Associate Editor of *American Machinist*.

A handy book for the engineer or machinist that clears up the mysteries of valve setting. Shows the different valve gears in use, how they work, and why. Piston and slide valves of different types are illustrated and explained. A book that every railroad man in the motive power department ought to have. Contains chapters on Locomotive Link Motion, Valve Movements, Setting Slide Valves, Analysis by Diagrams, Modern Practice, Slip of Block, Slice Valves, Piston Valves, Setting Piston Valves, Joy-Allen Valve Gear, Walschaert Valve Gear, Gooch Valve Gear, Alfree-Hubbell Valve Gear, etc., etc. 3rd Edition, 101 pages. Fully illustrated. Price
75 cents

MACHINE-SHOP PRACTICE

ABRASIVES AND ABRASIVE WHEELS. By FRED B. JACOBS.

A new book for everyone interested in abrasives or grinding. A careful reading of the book will not only make mechanics better able to use abrasives intelligently, but it will also tell the shop superintendent of many short cuts and efficiency-increasing kinks. The economic advantages in using large grinding wheels are fully explained, together with many other things that will tend to give the superintendent or workman a keen insight into abrasive engineering. 340 pages. 174 illustrations. This is an indispensable book for every machinist. Price \$3.00

COMPLETE PRACTICAL MACHINIST. By JOSHUA ROSE.

The new, twentieth revised and enlarged edition is now ready. This is one of the best-known books on machine-shop work, and written for the practical workman in the language of the workshop. It gives full, practical instructions on the use of all kinds of metal-working tools, both hand and machine, and tells how the work should be properly done. It covers lathe work, vise work, drills and drilling, taps and dies, hardening and tempering, the making and use of tools, tool grinding, marking out work, machine tools, etc. No machinist's library is complete without this volume. 20th Edition. 547 pages. 432 illustrations. Price \$3.00

HOME MECHANIC'S WORKSHOP COMPANION. By ANDREW JACKSON, JR.

This treatise includes a compilation of useful suggestions that cannot fail to interest the handy man, and while it is not intended for mechanical experts or scientists, it will prove to be a veritable store of information for anyone who desires to rig up a small shop where odd jobs can be carried on. 159 pages. 61 illustrations. Price 75 cents

MACHINE-SHOP TOOLS AND SHOP PRACTICE. By W. H. VANDERVOORT.

A work of 552 pages and 672 illustrations, describing in every detail the construction, operation, and manipulation of both hand and machine tools. Includes chapters on filing, fitting, and scraping surfaces; on drills, reamers, taps, and dies; the lathe and its tools; planers, shapers, and their tools; milling machines and cutters; gear cutters and gear cutting; drilling machines and drill work; grinding machines and their work; hardening and tempering; gearing, belting, and transmission machinery; useful data and tables. 7th Edition. 552 pages. 672 illustrations. Price \$3.00

SHOP PRACTICE FOR HOME MECHANICS. By RAYMOND FRANCIS YATES.

A thoroughly practical and helpful treatment prepared especially for those who have had little or no experience in shop work. The introduction is given over to an elementary explanation of the fundamentals of mechanical science. This is followed by several chapters on the use of small tools and mechanical measuring instruments. Elementary and more advanced lathe work is treated in detail and directions given for the construction of a number of useful shop appliances. Drilling and reaming, heat treatment of tool steel, special lathe operations, pattern making, grinding, and grinding operations, home foundry work, etc., make up the rest of the volume. The book omits nothing that will be of use to those who use tools or to those who wish to learn the use of tools. The great number of clear engravings (over 300) add tremendously to the text matter and to the value of the volume as a visual instructor. Octavo, 320 pages. 309 engravings. Price \$3.00

CATALOGUE OF GOOD, PRACTICAL BOOKS

THE WHOLE FIELD OF MECHANICAL MOVEMENTS COVERED BY MR. HISCOX'S TWO BOOKS

We publish two books by Gardner D. Hiscox that will keep you from "inventing" things that have been done before, and suggest ways of doing things that you have not thought of before. Many a man spends time and money, pondering over some mechanical problem, only to learn, after he has solved the problem, that the same thing has been accomplished and put in practice by others long before. Time and money spent in an effort to accomplish what has already been accomplished are time and money LOST. The whole field of mechanics, every known mechanical movement, and practically every device is covered by these two books. If the thing you want has been invented, it is illustrated in them. If it hasn't been invented, then you'll find in them the nearest things to what you want, some movements or devices that will apply in your case, perhaps; or which will give you a key from which to work. No book or set of books ever published is of more real value to the Inventor, Draftsman, or practical Mechanic than the two volumes described below.

MECHANICAL MOVEMENTS, POWERS, AND DEVICES. By GARDNER D. HISCOX.

This is a collection of 1,890 engravings of different mechanical motions and appliances, accompanied by appropriate text, making it a book of great value to the inventor, the draftsman, and to all readers with mechanical tastes. The book is divided into eighteen sections or chapters, in which the subject-matter is classified under the following heads: Mechanical Powers; Transmission of Power; Measurement of Power; Steam Power; Air Power Appliances; Electric Power and Construction; Navigation and Roads; Gearing; Motion and Devices; Controlling Motion; Horological; Mining; Mill and Factory Appliances; Construction and Devices; Drafting Devices; Miscellaneous Devices, etc. 17th edition enlarged. 409 octavo pages. Price . \$4.00

MECHANICAL APPLIANCES, MECHANICAL MOVEMENTS AND NOVELTIES OF CONSTRUCTION. By GARDNER D. HISCOX.

This is a supplementary volume to the one upon Mechanical Movements. Unlike the first volume, which is more elementary in character, this volume contains illustrations and descriptions of many combinations of motions and of mechanical devices and appliances found in different lines of machinery, each device being shown by a line drawing with a description showing its working parts and the method of operation. From the multitude of devices described and illustrated might be mentioned, in passing, such items as conveyors and elevators, Prony brakes, thermometers, various types of boilers, solar engines, oil-fuel burners, condensers, evaporators, Corliss and other valve gears, governors, gas engines, water motors of various descriptions, airships, motors and dynamos, automobile and motor bicycles, railway lock signals, car couplers, link and gear motions, ball bearings, breech block mechanism for heavy guns, and a large accumulation of others of equal importance. 1,000 specially made engravings 412 octavo pages. 5th Edition enlarged. Price \$4.00

SHOP KINKS. By ROBERT GRIMSHAW.

A book of 417 pages and 261 illustrations, being entirely different from any other book on machine-shop practice. Departing from conventional style, the author avoids universal or common shop usage and limits his work to showing special ways of doing things better, more cheaply and more rapidly than usual. As a result the advanced methods of representative establishments of the world are placed at the disposal of the reader. This book shows the proprietor where large savings are possible, and how products may be improved. To the employee it holds out suggestions that, properly applied, will hasten his advancement. No shop can afford to be without it. It bristles with valuable wrinkles and helpful suggestions. It will benefit all, from apprentice to proprietor. 6th edition. Price \$3.00

THREADS AND THREAD-CUTTING. By COLVIN and STABEL.

This clears up many of the mysteries of thread-cutting, such as double and triple threads, internal threads, catching threads, use of hobs, etc. Contains a lot of useful hints and several tables. 4th edition. Price 35 cents

CATALOGUE OF GOOD, PRACTICAL BOOKS

MACHINE-SHOP ARITHMETIC. By COLVIN-CHENEY.

This is an arithmetic of the things you have to do with dally. It tells you plainly about: how to find areas in figures; how to find surface or volume of balls or spheres; handy ways for calculating; about compound gearing; cutting screw threads on any lathe; drilling for taps; speeds of drills; taps, emery wheels, grindstones, milling cutters, etc.; all about the Metric system with conversion tables; properties of metals; strength of bolts and nuts; decimal equivalent of an inch. All sorts of machine-shop figuring and 1,001 other things, any one of which ought to be worth more than the price of this book to you, and it saves you the trouble of bothering the boss. 8th edition. 144 pages. Price 75 cents

MODEL MAKING

MODEL MAKING Including Workshop Practice, Design and Construction of Models. Edited by RAYMOND F. YATES. Editor of "Everyday Engineering Magazine."

This book will help you to become a better mechanic. It is full of suggestions for those who like to make things, amateur and professional alike. It has been prepared especially for men with mechanical hobbies. Some may be engineers, machinists, jewelers, pattern makers, office clerks or bank presidents. Men from various walks of life have a peculiar interest in model engineering. MODEL MAKING will be a help and an inspiration to such men. It tells them "how-to-do" and "how-to-make" things in simple, understandable terms. Not only this, it is full of good, clear working drawings and photographs of the models and apparatus described. Each model has been constructed and actually works if it is made according to directions. Second revised and enlarged edition. 428 pages. 337 illustrations. Price . . . \$3.00

SHIP MODEL MAKING

The only published books that meet the large demand for precise instruction on making ship models. They are a new departure in this class of books—being so artistically published they are a pleasure to have, to read and to work with.

HOW TO MAKE WORTH-WHILE MODELS OF DECORATIVE SHIPS.

By CAPTAIN E. ARMITAGE McCANN.

A practical and timely book which tells how any handy person can make models of a picturesque Barbary Pirate Felucca and a Beautiful Spanish Treasure Galleon, with a few simple tools and almost without expense. The author, known as "one of the world's leading authorities on ship models," in SHIP MODEL MAKING gives full-sized drawings of every part required. This book describes how to make them, what material to use, how to fasten together and color them, how to make the spars and rig the ships. One does not need to know ships to make these models—the book describes everything in detail, yet one may use one's own ingenuity and artistic sense and make them larger or smaller than the scale given. Profusely illustrated, scale drawings, colored frontispiece. Price \$2.50

HOW TO MAKE A MODEL OF THE U. S. FRIGATE "CONSTITUTION."

By CAPTAIN E. ARMITAGE McCANN.

Every true American has an affectionate interest in "Old Ironsides"—the ship for more than 100 years has carried the flag to victory and is now being reconditioned by public subscription, because she represents the indomitable spirit of the Navy. This volume, by "one of the world's leading authorities on Ship Models," tells how, without previous training, anyone can make a simplified or exhaustively particular, scale model of this ship.

The ample description of everything required, from tools and material to the finished model, aided by full sized plans and more than 100 specially made illustrations from original contemporary sources and the latest reconstruction plans, makes the building of the model sure and simple. Technically correct and complete in itself from start to finish. Fully illustrated. Colored frontispiece. Price \$2.50

CATALOGUE OF GOOD, PRACTICAL BOOKS

HOW TO MAKE A CLIPPER SHIP. By CAPTAIN E. ARMITAGE McCANN.

This practical and timely book tells how any handy person can make a model of the American Clipper Ship "*Sovereign of the Seas*"—Donald McKay's most beautiful vessel. The author, with ample descriptions, illustrations and full-sized plans of every part, tells how, with a few tools, anyone can make a simplified model, which, while retaining the general appearance, eliminates much work; he also gives all the details for those who desire them. The entire building and rigging are given to *scale from start to finish*. Either simplified or with complete details. Profusely illustrated, scale drawings, colored frontispiece. Price \$2.50

MANUAL TRAINING

ECONOMICS OF MANUAL TRAINING. By LOUIS ROUILLON.

The only book published that gives just the information needed by all interested in Manual Training, regarding Buildings, Equipment, and Supplies. Shows exactly what is needed for all grades of the work from the Kindergarten to the High and Normal School. Gives itemized lists of everything used in Manual Training Work and tells just what it ought to cost. Also shows where to buy supplies, etc. Contains 174 pages, and is fully illustrated. 2d edition. Price \$2.00

MINING

PROSPECTOR'S FIELD-BOOK AND GUIDE. By H. S. OSBORN.

Ninth edition, revised and enlarged by M. W. von Bernewitz. The last edition of this volume was published in 1910. It and the previous seven editions were suitable for those times. The new ninth edition will be found suitable for the present time. While the old-time prospector will always be an important factor, the knowledge of and search for the common and rarer minerals is bringing out men who are trained to some degree. In the field they need a handy and suggestive pocket-book containing hints on prospecting—where to search and how to test—couched in simple terms. 364 pages, 57 illustrations. Price \$3.00

MOTORCYCLES

MOTORCYCLES AND SIDE CARS, THEIR CONSTRUCTION, MANAGEMENT AND REPAIR. By VICTOR W. PAGÉ, M.E.

This treatise outlines fully the operation of two- and four-cycle power plants and all ignition, carburetion and lubrication systems in detail. Describes all representative types of free engine clutches, variable speed gears and power transmission systems. Gives complete instructions for operating and repairing all types. Considers fully electric self-starting and lighting systems, all types of spring frames and spring forks and shows leading control methods. For those desiring technical information a complete series of tables and many formulae to assist in designing are included. The work tells how to figure power needed to climb grades, overcome air resistance and attain high speeds. It shows how to select gear ratios for various weights and powers, how to figure braking efficiency required, gives sizes of belts and chains to transmit power safely, and shows how to design sprockets, belt pulleys, etc. This work also includes complete formulae for figuring horse-power, shows how dynamometer tests are made, defines relative efficiency of air- and water-cooled engines, plain and anti-friction bearings and many other data of a practical, helpful, engineering nature. 2nd Edition. 693 pages. 371 specially made illustrations. Cloth. Price \$2.50

WHAT IS SAID OF THIS BOOK:

"Here is a book that should be in the cycle repairer's kit."—*American Blacksmith*.
"The best way for any rider to thoroughly understand his machine, is to get a copy of this book; it is worth many times its price."—*Pacific Motorcyclist*.

CATALOGUE OF GOOD, PRACTICAL BOOKS

MOTOR BOATS

MOTOR BOATS AND BOAT MOTORS. By VICTOR W. PAGÉ AND A. C. LEITCH.

All who are interested in motor boats, either as owners, builders or repairmen, will find this latest work a most comprehensive treatise on the design, construction, operation and repair of motor boats and their power plants. It is really two complete books in one cover as it consists of two parts, each complete in itself. Part One deals with THE HULL AND ITS FITTINGS, Part Two considers THE POWER PLANT AND ITS AUXILIARIES. A valuable feature of this book is the complete set of dimensioned working drawings detailing the construction of five different types of boats ranging from a 16-foot shallow draft, tunnel stern general utility craft to a 25-foot cabin cruiser. These plans are by A. C. Leitch, a practical boat builder and expert naval architect, and are complete in every particular. Full instructions are given for the selection of a power plant and its installation in the hull. Valuable advice is included on boat and engine operation and latest designs of motors are described and illustrated. The instructions for overhauling boat and engine are worth many times the small cost of the book. It is a comprehensive work of reference for all interested in motor boating in any of its phases. Octavo. Cloth. 372 illustrations. 524 pages. Price \$4.00

PATTERN MAKING

PRACTICAL PATTERN MAKING. By F. W. BARROWS.

This book, now in its third edition, is a comprehensive and entirely practical treatise on the subject of pattern making, illustrating pattern work in both wood and metal, and with definite instructions on the use of plaster of Paris in the trade. It gives specific and detailed descriptions of the materials used by pattern makers and describes the tools, both those for the bench and the more interesting machine tools; having complete chapters on the Lathe, the Circular Saw, and the Band Saw. It gives many examples of pattern work, each one fully illustrated and explained with much detail. These examples, in their great variety, offer much that will be found of interest to all pattern makers, and especially to the younger ones, who are seeking information on the more advanced branches of their trade.

In this second edition of the work will be found much that is new, even to those who have long practiced this exacting trade. In the description of patterns as adapted to the Moulding Machine many difficulties which have long prevented the rapid and economical production of castings are overcome; and this great, new branch of the trade is given much space. Stripping plate and stool plate work and the less expensive vibrator, or rapping plate work, are all explained in detail.

Plain, everyday rules for lessening the cost of patterns, with a complete system of cost keeping, a detailed method of marking, applicable to all branches of the trade, with complete information showing what the pattern is, its specific title, its cost, date of production, material of which it is made, the number of pieces and core-boxes, and its location in the pattern safe, all condensed into a most complete card record, with cross index.

The book closes with an original and practical method for the inventory and valuation of patterns. Third Edition. Containing nearly 355 pages and 169 illustrations. Price \$2.50

PERFUMERY

PERFUMES AND COSMETICS, THEIR PREPARATION AND MANUFACTURE. By G. W. ASKINSON, Perfumer.

A comprehensive treatise, in which there has been nothing omitted that could be of value to the perfumer or manufacturer of toilet preparations. Complete directions for making handkerchief perfumes, smelling-salts, sachets, fumigating pastilles; preparations for the care of the skin, the mouth, the hair, cosmetics, hair dyes and other toilet articles are given, also a detailed description of aromatic substances; their nature, tests of purity, and wholesale manufacture, including a chapter on synthetic products, with formulas for their use. A book of general, as well as professional interest, meeting the wants not only of the druggist and perfume manufacturer, but also of the general public. Fifth Edition. 392 pages, illustrated. Price \$6.00

CATALOGUE OF GOOD, PRACTICAL BOOKS

PLUMBING

MECHANICAL DRAWING FOR PLUMBERS. By R. M. STARBUCK.

A concise, comprehensive and practical treatise on the subject of mechanical drawing in its various modern applications to the work of all who are in any way connected with the plumbing trade. Nothing will so help the plumber in estimating and in explaining work to customers and workmen as a knowledge of drawing, and to the workman it is of inestimable value if he is to rise above his position to positions of greater responsibility. Among the chapters contained are: 1. Value to plumber of knowledge of drawing; tools required and their use; common views needed in mechanical drawing. 2. Perspective versus mechanical drawing in showing plumbing construction. 3. Correct and incorrect methods in plumbing drawing; plan and elevation explained. 4. Floor and cellar plans and elevation; scale drawings; use of triangles. 5. Use of triangles; drawing of fittings, traps, etc. 6. Drawing plumbing elevations and fittings. 7. Instructions in drawing plumbing elevations. 8. The drawing of plumbing fixtures; scale drawings. 9. Drawings of fixtures and fittings. 10. Inking of drawings. 11. Shading of drawings. 12. Shading of drawings. 13. Sectional drawings; drawing of threads. 14. Plumbing elevations from architect's plan. 15. Elevations of separate parts of the plumbing system. 16. Elevations from the architect's plans. 17. Drawings of detail plumbing connections. 18. Architect's plans and plumbing elevations of residence. 19. Plumbing elevations of residence (continued); plumbing plans for cottage. 20. Plumbing elevations; roof connections. 21. Plans and plumbing elevations for six-flat building. 22. Drawing of various parts of the plumbing system; use of scales. 23. Use of architect's scales. 24. Special features in the illustrations of country plumbing. 25. Drawing of wrought-iron piping, valves, radiators, coils, etc. 26. Drawing of piping to illustrate heating systems. 27. Drawings for Plumbers' Examinations. 123 pages. 160 illustrations. Price . \$2.00

MODERN PLUMBING ILLUSTRATED. By R. M. STARBUCK.

This book represents the highest standard of plumbing work. It has been adopted and used as a reference book by the United States Government, in its sanitary work in Cuba, Porto Rico, and the Philippines, and by the principal Boards of Health of the United States and Canada.

It gives connections, sizes and working data for all fixtures and groups of fixtures. It is helpful to the master plumber in demonstrating to his customers and in figuring work. It gives the mechanic and student quick and easy access to the best modern plumbing practice. Suggestions for estimating plumbing construction are contained in its pages. This book represents, in a word, the latest and best up-to-date practice and should be in the hands of every architect, sanitary engineer and plumber who wishes to keep himself up to the minute on this important feature of construction. Contains following chapters, each illustrated with a full-page plate: Kitchen sink, laundry tubs, vegetable wash sink; lavatories, pantry sinks, contents of marble slabs; bath tub, foot and sitz bath, shower bath; water closets, venting of water closets; low-down water closets, water closets operated by flush valves, water closet range; slop sink, urinals, the bidet; hotel and restaurant sink, grease trap; refrigerators, safe wastes, laundry waste, lines of refrigerators, bar sinks, soda fountain sinks; horse stall, frost-proof water closets; connections for S traps, venting; connections for drum traps; soil pipe connections; supporting of soil pipe; main trap and fresh air inlet; floor drains and cellar drains, subsoil drainage; water closets and floor connections; local venting; connections for bath rooms; connections for bath rooms, continued; connections for bath rooms, continued; connections for bath rooms, continued; examples of poor practice; roughing work ready for test; testing of plumbing system; method of continuous venting; continuous venting for two-floor work; continuous venting for two lines of fixtures on three or more floors; continuous venting of water closets; plumbing for cottage house; construction for cellar piping; plumbing for residence, use of special fittings; plumbing for two-flat house; plumbing for apartment building, plumbing for double apartment building; plumbing for office building; plumbing for public toilet rooms; plumbing for public toilet rooms, continued; plumbing for bath establishment; plumbing for engine house, factory plumbing; automatic flushing for schools, factories, etc.; use of flushing valves; urinals for public toilet rooms; the Durham system, the destruction of pipes by electrolysis; construction of work without use of lead; automatic sewage lift; automatic sump tank; country plumbing; construction of cesspools; septic tank and automatic sewage siphon; country plumbing; water supply for country house; thawing of water mains and service by electricity; double boilers; hot water supply of large buildings; automatic control of hot water tank; suggestion for estimating plumbing construction. 407 octavo pages, fully illustrated by 70 full-page engravings. Fifth, revised and enlarged edition. Price . . . \$5.00

CATALOGUE OF GOOD, PRACTICAL BOOKS

STANDARD PRACTICAL PLUMBING. By R. M. STARBUCK.

A complete practical treatise of 450 pages covering the subject of Modern Plumbing in all its branches, a large amount of space being devoted to a very complete and practical treatment of the subject of Hot Water Supply and Circulation and Range Boiler Work. Its thirty chapters include about every phase of the subject one can think of, making it an indispensable work to the master plumber, the journeyman plumber, and the apprentice plumber, containing chapters on: the plumber's tools; wiping solder; composition and use; joint wiping; lead work; traps; siphonage of traps; venting; continuous venting; house sewer and sewer connections; house drain; soil piping, roughing; main trap and fresh air inlet; floor, yard, collar drains, rain leaders, etc.; fixture wastes; water closets; ventilation; improved plumbing connections; residence plumbing; plumbing for hotels, schools, factories, stables, etc.; modern country plumbing; filtration of sewage and water supply; hot and cold supply; range boilers; circulation; circulating pipes; range boiler problems; hot water for large buildings; water lift and its use; multiple connections for hot water boilers; heating of radiation by supply system; theory for the plumber; drawing for the plumber. Eighth revised and enlarged edition. 444 pages. Fully illustrated by 364 engravings. Price \$4.00

RADIO BOOKS

THE A B C OF VACUUM TUBES USED IN RADIO RECEPTION. By E. H. LEWIS.

This is the book for the person who wishes to know what goes on in the inside of a vacuum tube when it is used in a radio receiving circuit. It is especially valuable to the person who knows nothing about radio and very little if anything about electricity. No previous technical knowledge is necessary to understand it. The book is also of great value to the experimenter who is just taking up the fascinating study of vacuum tube operation.

Starting with an explanation of elementary electrical terms and list of symbols the functioning of various vacuum tubes as detectors and amplifiers is explained step by step in an easily understandable manner. The subject of speech distortion, one of the difficulties frequently encountered in radiophone reception today, is discussed and its elimination pointed out. Various practical circuits are shown and discussed. No technical terms are used without their meaning being first explained. 132 pages. 48 illustrations. Price 75 cents

CONSTRUCTION OF A MODERN SUPER-HETERODYNE TYPE RECEIVER INCLUDING TESTING AND OPERATION. By a Staff of Radio Engineers —JOHN E. ANDERSON, ARTHUR C. C. MILLS and ELMER H. LEWIS.

This booklet with the drawings accompanying same give the most detailed information on the complete construction of a modern type of Super-Heterodyne which is extremely sensitive, selective and non-radiating and at the same time insures excellent quality of reproduction when used with a high quality loud speaker. Very complete information on the testing of all parts of the circuit as well as the complete receiver are given. The directions for operating the set are also very complete. Directions are included for slightly altering the wiring of the receiver to accommodate dry cell tubes, instead of the standard types which require storage batteries. The design may be altered for the use of a loop instead of an open antenna in accordance with the instructions given. Price \$1.00

WIRELESS TELEGRAPHY AND TELEPHONY SIMPLY EXPLAINED. By ALFRED P. MORGAN.

This is a complete and comprehensive treatise, and a close study of its pages will enable one to master all the details of the wireless transmission of messages. The author filled a long-felt want and has succeeded in furnishing a lucid, comprehensively explanation in simple language of the theory and practice of wireless telegraphy and telephony. 154 pages. 156 engravings. Price \$1.00

CATALOGUE OF GOOD, PRACTICAL BOOKS

EXPERIMENTAL WIRELESS STATIONS. By P. E. EDELMAN.

The theory, design, construction and operation is fully treated including Wireless Telephony, Vacuum Tube, and quenched spark systems. The new enlarged edition is just issued and is strictly up to date, correct and complete. This book tells how to make apparatus to not only hear all telephoned and telegraphed radio messages, but also how to make simple equipment that works for transmission over reasonably long distances. Then there is a host of new information included. The first and only book to give you all the recent important radio improvements, some of which have never before been published. This volume anticipates every need of the reader who wants the gist of the art, its principles, simplified calculations, apparatus dimensions, and understandable directions for efficient operation.

Vacuum tube circuits; amplifiers; long-distance sets; loop, coil, and underground receivers; tables of wave-lengths, capacity, inductance; such are a few of the subjects presented in detail that satisfies. It is independent and one of the few that describe all modern systems.

Endorsed by foremost instructors for its clear accuracy, preferred by leading amateurs for its dependable designs. The new experimental Wireless Stations is sure to be most satisfactory for your purposes. 27 chapters, 392 pages. 167 illustrations. Price \$2.00

HENLEY'S 222 RADIO-CIRCUIT DESIGNS. By JOHN E. ANDERSON, ARTHUR C. C. MILLS and ELMER H. LEWIS.

An entirely new and thoroughly practical book on radio circuit designs which will meet the needs of every radio enthusiast, whether novice or expert, amateur or professional. It is replete with correct and trustworthy radio information from which any one can successfully build and operate any of the circuits given. Contains the largest collection of radio circuits and hook ups ever published and includes all the standard types and latest developments.

This new book treats the subject in an entirely different and novel way, as it is the only book that illustrates the complete electrical design of the circuits, showing the electrical values of inductances, capacities and resistances, with the name of each element on the diagram of the circuit.

The book explains in simple words the principles of operation of every circuit described and the functions of all of the component pieces of apparatus—but carefully avoids needless theory. It is so simple that the novice will understand it; so thorough that he can build successfully any circuit it contains without any other assistance; so suggestive of new circuit arrangements that the most insatiable experimenter will find it an inexhaustible source of circuits; so comprehensive that the most advanced amateur will find inspiration in its pages; so complete and conveniently arranged that the expert radio engineer will find it an invaluable and handy reference volume; so thoroughly indexed that the reader can find at once just the circuit information he is seeking. It is a veritable fountain of authoritative radio information. It brings to the side of every experimenter the results of research in the largest industrial, university, and government radio laboratories, and the expert knowledge of the greatest radio engineers. It is the radio experimenter's indispensable assistant—his inseparable laboratory companion.

In addition it contains a list of all symbols and a glossary of all technical terms used in the book; a revised and up-to-date list of all the important broadcasting stations in the United States and Canada, together with their operating wave lengths or frequencies. 271 pages. 284 diagrams. Price \$1.00

HENLEY'S WORKABLE RADIO RECEIVERS. By a Staff of Radio Engineers—JOHN E. ANDERSON, ARTHUR C. C. MILLS and ELMER H. LEWIS.

An authoritative book on practical receiving sets of modern design with complete explicit directions for building them. This new book contains complete descriptions of many types of receivers, which, by long experience have proved to be the most satisfactory from the viewpoints of selectivity, sensitivity, convenience and economy of operation, dependability, and quality of reproduction. It gives in greatest detail circuit and wiring diagrams, panel and baseboard layouts and drilling templates, so that any amateur may build a successful receiver from the directions given. It also includes a discussion on the principles underlying each circuit, and shows clearly how to test and calibrate the receivers. 196 pages with 116 specially made engravings. Price \$1.00

CATALOGUE OF GOOD, PRACTICAL BOOKS

SPECIAL TWENTY-FIVE CENTS RADIO BOOKS

These inexpensive books contain a wealth of essential Radio information. They answer thousands of questions about the art and science of Radio Telegraphy and Telephony, in language so simple that the most inexperienced novice and amateur can easily understand.

Every branch of the art is thoroughly and systematically covered, detailed information being given. Experimenters will find in them a storehouse of ideas and helpful hints.

DESIGN DATA FOR RADIO TRANSMITTERS AND RECEIVERS. By MILTON B. SLEEPER.

Far from being a collection of formulas, Design Data takes up in proper sequence the problems encountered in planning all types of receiving sets for short, medium and long wave work, and spark coil, transformer and vacuum tube transmitters operating on 200 meters. Tables have been worked out so that values can be found without the use of mathematics. Radio experimenters will find here information which will enable them to have the most modern and efficient equipment. Price . 25 cents

HOW TO MAKE COMMERCIAL TYPE RADIO APPARATUS. By M. B. SLEEPER.

This book describes in detail many commercial types of spark and vacuum tube telephone transmitting and telegraph and phone receiving equipment of all kinds. The experimenter will be able to get a world of ideas for the construction of his next piece of radio equipment from the very clear descriptions and the 96 clearly illustrated figures. 159 pages. Price 25 cents

IDEAS FOR THE RADIO EXPERIMENTER'S LABORATORY. By M. B. SLEEPER.

This book is indispensable to the radio experimenter who desires to get maximum information and enjoyment out of his experiments. It fully describes such laboratory essentials as oscillators, wave-meters, vacuum tube characteristics, measuring circuits, and many others. It describes the construction and explains the advantages of various coils, and shows how their inductions may be calculated. 134 pages. 60 illustrations. Price 25 cents

RADIO EXPERIMENTER'S HAND BOOK. By M. B. SLEEPER.

In these days when the Radio Set is almost as necessary in the home as the Phonograph, there has been a great need of a book which tells in concise way the "Why" of Radio—What makes it work. How to build simple transmitters and receivers. Answers the practical questions of the novice, the beginner and the advanced student. Gives detailed descriptions of many types of receiving circuits including the crystal, audion, regenerative, also amplifiers and oscillators. It is a handy reference book and no up-to-date radio library is complete without a copy. 143 pages. 16 chapters. 82 engravings. Price 25 cents

RADIO HOOK-UPS. By MILTON B. SLEEPER.

In this book the best circuits for different instruments and various purposes have been carefully selected and grouped together. All the best circuits for damped and undamped wave receiving sets, buzzer, spark coil and transformer sending equipment, as well as vacuum tube telegraph and telephone transmitters, wavemeters, vacuum tube measuring instruments, audibility meters, etc., are shown in this book. . 25 cents

CATALOGUE OF GOOD, PRACTICAL BOOKS

RECIPE BOOK

HENLEY'S TWENTIETH CENTURY BOOK OF RECIPES, FORMULAS AND PROCESSES. Edited by GARDNER D. HISCOX.

The most valuable Techno-chemical Formula Book published, including over 10,000 selected scientific, chemical, technological, and practical recipes and processes. This is the most complete Book of Formulas ever published, giving thousands of recipes for the manufacture of valuable articles for everyday use. Hints, Helps, Practical Ideas, and Secret Processes are revealed within its pages. It covers every branch of the useful arts and tells thousands of ways of making money, and is just the book everyone should have at his command.

Modern in its treatment of every subject that properly falls within its scope, the book may truthfully be said to present the very latest formulas to be found in the arts and industries, and to retain those processes which long experience has proven worthy of a permanent record. To present here even a limited number of the subjects which find a place in this valuable work would be difficult. Suffice to say that in its pages will be found matter of intense interest and immeasurably practical value to the scientific amateur and to him who wishes to obtain a knowledge of the many processes used in the arts, trades and manufacture, a knowledge which will render his pursuits more instructive and remunerative. Serving as a reference book to the small and large manufacturer and supplying intelligent seekers with the information necessary to conduct a process, the work will be found of inestimable worth to the Metallurgist, the Photographer, the Perfumer, the Painter, the Manufacturer of Glues, Pastes, Cements, and Mucilages, the Compounder of Alloys, the Cook, the Physician, the Druggist, the Electrician, the Brewer, the Engineer, the Foundryman, the Machinist, the Potter, the Tanner, the Confectioner, the Chiropodist, the Manicure, the Manufacturer of Chemical Novelties and Toilet Preparations, the Dyer, the Electroplater, the Enameler, the Engraver, the Provisioner, the Glass Worker, the Goldbeater, the Watchmaker, the Jeweler, the Hat Maker, the Ink Manufacturer, the Optician, the Farmer, the Dairyman, the Paper Maker, the Wood and Metal Worker, the Chandler and Soap Maker, the Veterinary Surgeon, and the Technologist in general.

A mine of information, and up-to-date in every respect. A book which will prove of value to EVERYONE, as it covers every branch of the Useful Arts. Every home needs this book; every office, every factory, every store, every public and private enterprise—EVERYWHERE—should have a copy. New edition recently published to which has been added an illustrated chapter on Useful Workshop and Laboratory Methods. 807 pages. Cloth Bound. Price \$4.00
Red Fabrakoid Binding. Price 5.00

WHAT IS SAID OF THIS BOOK:

"Your Twentieth Century Book of Recipes, Formulas, and Processes duly received. I am glad to have a copy of it, and if I could not replace it, money couldn't buy it. It is the best thing of the sort I ever saw." (Signed) M. E. TRUX, Sparta, Wis.

"There are few persons who would not be able to find in the book some single formula that would repay several times the cost of the book."—*Merchants' Record and Show Window*.

"I purchased your book 'Henley's Twentieth Century Book of Recipes, Formulas and Processes' about a year ago and it is worth its weight in gold."—WM. H. MURRAY, Bennington, Vt.

"THE BOOK WORTH THREE HUNDRED DOLLARS"

"On close examination of your 'Twentieth Century Receipt Book,' I find it to be a very valuable and useful book with the very best of practical information obtainable. The price of the book, \$4.00, is very small in comparison to the benefits which one can obtain from it. I consider the book worth fully three hundred dollars to anyone."—DR. A. C. SPETTS, New York.

"ONE OF THE WORLD'S MOST USEFUL BOOKS"

"Some time ago, I got one of your 'Twentieth Century Books of Formulas' and have made my living from it ever since. I am alone since my husband's death with two small children to care for and am trying so hard to support them. I have customers who take from me Toilet Articles I put up, following directions given in the book, and I have found every one of them to be fine."—MRS. J. H. MCMAKEN, West Toledo, Ohio.

CATALOGUE OF GOOD, PRACTICAL BOOKS

METAL WORKER'S HANDY-BOOK OF RECEIPTS AND PROCESSES.

By WILLIAM T. BRANNT.

This book is a collection of chemical formulas and practical manipulations for the working of all the metals and alloys; including the decoration and beautifying of articles manufactured therefrom, as well as their preservation. Edited from various sources. New enlarged edition containing new chapters on flame welding and cutting; thermit welding; electric welding; galvanizing, Schoop's spray process. Sphaerizing and die casting. Cloth, 582 pages, 82 illustrations. Price \$3.00

TECHNO-CHEMICAL RECEIPT BOOK. By WILLIAM T. BRANNT and

WILLIAM H. WAHL.

This well-known Receipt Book is a mine of accurate information that everyone may work to great advantage. It is encyclopedic in range, yet gives only the best formulas for each preparation or operation, and thorough tests by competent men guarantee their intrinsic merit. There is something here for all—for the manufacturer interested in alloys, explosives, earthenware or leather—for the confectioner looking for attractive specialties—for the engineer annoyed by boiler encrustations—for the painter and decorator wishing to improve his processes and methods—for the woman who would restore a feather or clean a pair of gloves.

The arts, the industries and the household may each profit by the world-wide experience that has been condensed between two covers of this volume. Formulas the most shrewd and persistent investigators have sometimes discovered and perfected only after years of experimentation are here exactly set down. The library or the laboratory, the factory or the home is not complete without this handy and useful reference volume. 516 pages. 78 illustrations. Price \$2.50

SOAP MAKING

AMERICAN SOAP MAKERS' GUIDE. By P. B. MEERBOTT.

Soap and Chemical Manufacturer and Chemist; Former Instructor of Industrial Chemistry and I. V. STANLEY STANISLAUS, Chemical Engineer; Associate Professor, Brooklyn College of Pharmacy; Author of Stanislaus' and Kimberley's Short Pharmaceutical Chemistry; Former President Philadelphia Branch American Pharmaceutical Association; Member Scientific Societies, etc.

An up-to-the-minute treatise on the art and science of the manufacture of soap, candles and allied toilet preparations. This is the most complete and exhaustive book in the English language. The previous editions by William T. Brannt, on which this volume is partly based, were widely in demand by the trade, which testifies that they offered information of distinct practical value. The present, third, edition has been thoroughly revised, enlarged, entirely reset and brought to date by the addition of many new chapters, all of which are of paramount importance to the soap industry of this country which has steadily grown in the past five decades—which is the history of this book—to a position of dignity due its steady and progressive development. America having risen to the all-important and enviable position of being the largest soap-exporting nation in the world, the progress made in the soap industry has been phenomenal. The new edition contains every modern practice in the development of the industry. The physical and chemical constants of oil and fats have changed, and the new edition contains a complete list with modern calculations for yield, etc. The recovery of glycerin, uses are in great demand. All these exacting purposes, especially fitted for textile industry, are in great demand. All these subjects are fully treated in the new edition. An entirely new chapter on the manufacture of candles has been added, while the use of synthetics in the perfuming of soaps is fully treated. This is the most important and thoroughly up-to-date book ever published on this important subject. 800 pages. 6 x 9 inches. Cloth binding. 105 illustrations. Price \$10.00

CATALOGUE OF GOOD, PRACTICAL BOOKS

RUBBER

RUBBER HAND STAMPS—MANIPULATION OF INDIA RUBBER AND THE PREPARATION OF RUBBERIZED FABRICS. By T. O'CONNOR SLOANE.

This book gives full details on all points, treating in a concise and simple manner the elements of nearly everything it is necessary to understand for a commencement in any branch of the India Rubber Manufacture. The making of all kinds of Rubber Hand Stamps, Small Articles of India Rubber, U. S. Government Composition, Dating Hand Stamps, the Manipulation of Sheet Rubber, Toy Balloons, India Rubber Solutions, Cements, Blackings, Renovating Varnish, and Treatment for India Rubber Shoes, etc.; the Hecktograph Stamp Inks, Rubberized Fabrics, Rain Coats, Rubber Glove Making, Fire and Garden Hose Manufacture, Miscellaneous Notes, with a Short Account of the Discovery, Collection and Manufacture of India Rubber, are set forth in a manner designed to be readily understood, the explanations being plain and simple. Including a chapter on Rubber Tire Making and Vulcanizing; also a chapter on the uses of rubber in Surgery and Dentistry. Fourth revised and enlarged edition. 222 pages. Illustrated. Price \$2.00

SAWS

SAW FILING AND MANAGEMENT OF SAWS. By ROBERT GRIMSHAW.

A practical hand-book on filing, gumming, swaging, hammering, and the brazing of band saws, the speed, work, and power to run circular saws, etc. A handy book for those who have charge of saws, or for those mechanics who do their own filing, as it deals with the proper shape and pitches of saw teeth of all kinds and gives many useful hints and rules for gumming, setting, and filing, and is a practical aid to those who use saws for any purpose. Complete tables of proper shape, pitch, and saw teeth as well as sizes and number of teeth of various saws are included. Fourth edition, revised and enlarged. Illustrated. Price \$1.50

SCREW CUTTING

THREADS AND THREAD-CUTTING. By COLVIN and STABLE.

This clears up many of the mysteries of thread-cutting, such as double and triple threads, internal threads, catching threads, use of hobs, etc. Contains a lot of useful hints and several tables. Fourth Edition. Price 35 cents

STEAM ENGINEERING

ENGINE RUNNER'S CATECHISM. By ROBERT GRIMSHAW.

A practical treatise for the stationary engineer, telling how to erect, adjust, and run the principal steam engines in use in the United States. Describing the principal features of various special and well-known makes of engines: Temper Cut-off, Shipping and Receiving Foundations, Erecting and Starting, Valve Setting, Care and Use, Emergencies, Erecting and Adjusting Special Engines. The questions asked throughout the catechism are plain and to the point, and the answers are given in such simple language as to be readily understood by anyone. All the instructions given are complete and up-to-date; and they are written in a popular style, without any technicalities or mathematical formulæ. The work is of a handy size for the pocket, clearly and well printed, nicely bound, and profusely illustrated. To young engineers this catechism will be of great value, especially to those who may be preparing to go forward to be examined for certificates of competency; and to engineers generally it will be of no little service, as they will find in this volume more really practical and useful information than is to be found anywhere else within a like compass. 387 pages. Seventh edition. Price \$2.00

