

YOU PAY ONLY 4^c PER ELECTRONIC EXPERIMENT WHEN YOU BUY THIS BOOK



FIFTY LAB-PROVEN projects for hobbyists, experimenters, students and teachers . . . in two sections ("easy" and "more complicated"), both included in this 96 page book! At the back of the book you'll find a keyed master parts list and prices! All regularly stocked parts, too.

Radio Shack's **MICRONTA** Test Equipment ... Precision Quality ... Big Savings

1,000 Ohms/Volt Pocket AC/DC VOM Multitester



- 5 Ranges!
- 1 3/4" Meter Scale
- So Compact!

GOOD

5⁹⁵
Factory
Wired

Only
3 1/2 x 2 1/8 x 1"

Small as a cigarette pack yet so useful! Reads AC or DC volts: 0-5, 150, 1,000 volts. DC current 0-150 ma. Resistance 0-100,000Ω, ±3% accuracy of full scale on DC ranges, ±4% on AC ranges. Pin jacks for all 5 ranges. 2 color meter face. Test leads and battery supplied.
22-4027, Ship. wt. 1 lb. Net 5.95

Popular 20,000 Ohms-per-Volt Multitester



- Uses Precision 1% Resistors!
- Big Easy-to-Read 3 1/2" Meter Scale!

BETTER

8⁹⁵
Factory
Wired

Extra-sensitive full-range compact! Reads DC volts 0 to 5/25/100/500/1,000 @ 20,000 ohms volt with ±2% accuracy. AC volts 0 to 5/25/100/500/1,000 @ 10,000 ohms volt with ±4% accuracy. Current: 50 μa, 250 ma. Resistance: R x 10, R x 1,000; db -20 to +16. With batteries, test prods, instructions. 3x4 1/2 x 1 1/4".
22-044, Ship. wt. 2 lbs. Net 8.95



Super-Deluxe 30,000 Ohms/Volt 26 Range Multitester

BEST

16⁹⁵
Factory
Wired

- Large 3 3/8" Meter!
- Precision 1% Resistors!
- 15,000 Ohms per Volt AC!
- 30,000 Ohms per Volt DC!
- Ideal for Engineers, Technicians, Servicemen!

Versatile professional instrument handles the biggest jobs easily. Reads DC volts 0 to 0.6/3/15/60/300/600/1,200/3,000. AC volts 0 to 6/30/120/600/1,200. Resistance R x 1/100/1,000/10,000. Current (MA) 0 to 0.03/6/60/600. db -20 to +63 in 5 ranges. Complete with test leads, batteries and instruments.
22-049, Ship. wt. 1 1/2 lbs. Net 16.95

MICRONTA PRODUCTS SOLD ONLY AT RADIO SHACK

ANDY INDEX

TITLE	PAGE
Crystal Diode Receiver	12
One Transistor Radio	14
Three Transistor Radio	15
Loudspeaker Cabinet	17
Sun-Powered Radio	18
Portable Electronic	
Megaphone	20
Safety-Light Flasher	21
Continuity Tester	23
Electric Maze	24
Code Instructor	25
Advanced Code Instructor	27
Electronic Timer	29
Photo Exposure Meter	31
Electronic Metronome	32
Electronic Organ	33
Hi-Fi Power Meter	35
Audio Generator	36
Transistorized Power	
Amplifier	37
Transistor Tester	39
Burglar Alarm	40
Photo Exposure Meter	42
Slave Flash	43
All-Transistor Amplifier	44
Home Broadcast Station	47
Field Strength Meter	48
Wireless Code Transmitter	57
Loudspeaker-Microphone	59
Mike Preamplifier	61
All-Transistor Intercom	62
Rain Alarm	63
Color Comparator	65
Clearance Light Flasher	66
Short Wave Converter	68
Citizens Band Transmitter	70
Transistorized VTVM	72
Simple Tachometer	73
Telephone Pickup	74
Directional Microphone	75
Stereo Balancer	77
Stereo Phasor	78
Appliance Tester	79
Electronic Stethoscope	80
Audio Mixer	81
Applause Meter	82
S-Meter	84
BFO	85
Big-Voice Megaphone	87
Short-the-Circuit	89
Battery-Eliminator	92
Acoustic Receiver	93

50 EASY TO BUILD

SOLID STATE



PROJECTS

*Including Instructions
and
Master Parts List!*

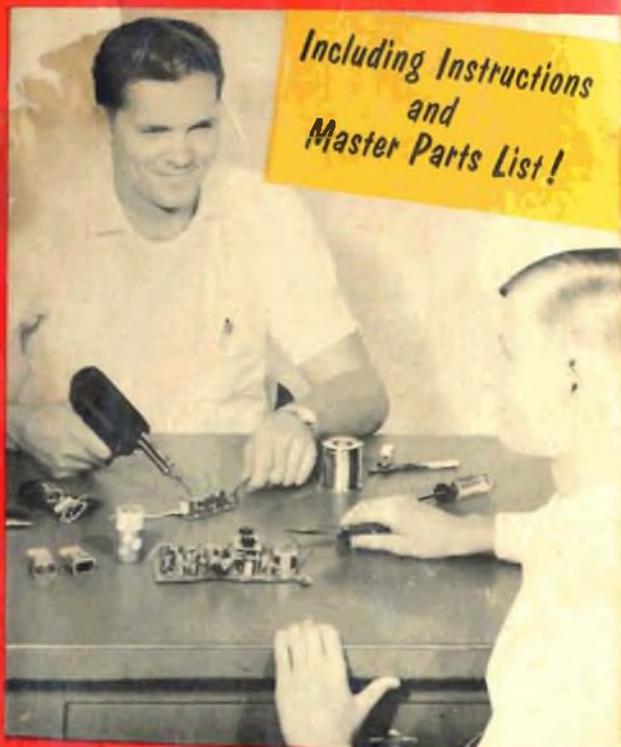

TOOLS and SOLDER

... for Electronic Project Hobbyists



Top Quality Electronic Solder

Recommended by
Radio Engineers!

- Superactive Rosin Core!

39^c up

Best buy yet! 60% tin, 40% lead. 16 gauge.

Made in USA.
64-0001, Handy Pack Net .39
64-0002, Bench Pack Spool Net .69
64-0003, 1 lb. Spool Net 2.49

Handy 8" Crimping Tool

- Cuts and Strips Wires!
- Crimps Solderless Terminals!

Great! Will cut and clean wires in all gauges 10-22. Comes complete with assorted terminals.

64-405, Wt. 1 1/2 lbs. Net 1.29
64-407, Pack of 50 extra solderless terminals Net .49

1²⁹

35 Watt Soldering Iron

- Indispensable in Home or Shop!

1¹⁹

Value packed, budget priced iron with replaceable tip. Fast heat. Cool handle. UL cord, plug. 110 VAC/DC.
64-2175, Wt. 1 lb., Net 1.19
64-2176, Copper Tip, Net .39



Weller Soldering "Pencil"

25 Watt Rating

3⁹⁵

Custom-made for miniature work. Comes with 1/8" tip and cord set. Other tips available listed below. 117 VAC. Size: 7 7/8".

64-2195, 1 lb. Net 3.95
64-2196, 1/16" Tip Net .75
64-2197, 3/32" Tip Net .75
64-2198, 1/8" Tip Net .75



Weller Expert Soldering Gun

- 100/140 Watt
- High Efficiency Tip!

Ideal for soldering, kit building, etc. Instant dual-heat feature meets changing needs. Special soldering tip gives fast heat transfer.

64-2190, 2 lbs. Net 4.95

4⁹⁵



Build Your Own Printed Circuits

Unclad Perf-Board (Punched)

- For Miniature Components!
- Simplifies Circuits!
- Easy In/Out Mounting!
- Economical Low Price!

27-1582, 3.65x6.87x1/16" Net .49
27-1583, 6.87x9.8x1/16" Net .99



Copper-Clad Perf-Board (Punched)

- For Printed Circuit Design and Circuit Checkout!
- Cuts to Any Desired Size!

27-1584, 3.65x6.87x1/16" Net .69
27-1585, 6.87x9.8x1/16" Net 1.49



Copper-Clad Solid Board (Unpunched)

- For Making Your Own Circuits!
- Bonded with Copper!

27-1586, 3.65x6.87x1/16" Net .59
27-1587, 6.87x9.8x1/16" Net 1.39



500 Ft. Hook-Up Wire

1⁹⁹

- Cotton & Vinyl Insulation! Solid or Stranded!

Great bargain! Sizes #18 through #22 suitable for most wiring jobs. Each 100' coil comes in a popular color.
27-1484, Sh. wt. 2 lbs. Net 1.99



Make Your Own Circuits!

1²⁵

Etchant. Pre-measured, ready to use. 2 bags ammonium persulphate, 1 vial activator. Just add hot water.
27-1626, 2 lbs. Net 1.25

2⁰⁰

Rub-on transfer sheet with variety of circles, lines, etc. lipses. Use with copper clad board. Rub on. Etch!
27-1627, Per Sheet Net ea. 2.00



50

**Easy-to-Build
Solid-State**

PROJECTS

A RADIO SHACK® PUBLICATION

Cat. No. 62-1050

**An educational science program
designed to provide an introduction
to space-age electronics**

Published by

RADIO SHACK CORPORATION

730 Commonwealth Avenue, Boston Mass., 02117

A Note To Teachers, Clubs, Institutions



This Book Available at Group Discount Prices!

"50 PROJECTS" is education plus fun at its best. In addition, electronics is as modern as tomorrow's news. These factors make the book extremely desirable as a group activity medium. We now make it available at quantity discount prices and, at the same time, invite you to request discount prices on parts for these projects if bought in quantities.

EACH	2.00 Postpaid
10 copies	10.00 Postpaid
20 copies	15.00 Postpaid
50 copies	25.00 Postpaid
100 copies	35.00 Postpaid

Mail order to the Radio Shack nearest you.

FOREWORD

Electronics literally makes science fiction come to life. It is amazing how many wonderful things can be done with a handful of electronic parts. There is virtually no end to the interesting and useful projects that can be built. Of course, some electronic devices are highly complicated and it takes years of training to develop the knowledge required to understand them. However, the basic principles of electronic circuit operation are relatively easy to learn. The purpose of this project series is to help you prove to yourself that learning by doing is interesting, practical, and lots of fun.

This volume is divided into two parts. Each part describes 25 different projects—50 in all! They range in complexity from a simple radio you can build in less than an hour to “walkie-talkies” and a two-station intercom. All except the final two projects are battery-powered, and thus require no special precautions against electrical shock. If you intend to work with more advanced electronic equipment, however, you will eventually have to gain experience with higher voltages. For this reason, the last two projects in this volume are designed to be powered from a standard 110-volt AC source. Before you begin these projects, be sure to read the Introduction to Part 2, so you will know how to work properly with higher voltages.

All the projects are educational, and most of them are useful as well. Extensive use of transistors make them easy and inexpensive to build. Moreover, one of the major stumbling blocks for hobbyists and beginners—being able to obtain needed parts at reasonable prices—has been eliminated. You'll find all the parts you need to build any of the devices in this 96-page book (as well as those described in magazines and books) in any Radio Shack store or similar “parts house.” See page 95-96 for the Master Parts List and prices. All items available by mail.

All our parts are standard components designed for universal use, so you are by no means limited to building only the projects in this Series. In fact, we encourage you to broaden your knowledge of electronics by building projects described in leading magazines such as Popular Electronics, Radio-Electronics, Electronics World, and Electronics Illustrated, all available from newsstand dealers. Also, several books containing plans for interesting and valuable electronic projects have been made available by such leading publishers as Rider, Gernsback, and Howard W. Sams. For your convenience, Radio Shack catalog numbers have been assigned to each component in the projects and cross-referenced to the Master Parts List at the back of the book.

RADIO SHACK CORPORATION
Boston, Mass. 02117, U.S.A.

TABLE OF CONTENTS

Introduction to Part 1—tools of the trade, electronic components and symbols	7
No. 1 Crystal-Diode Receiver—easy to build, hours of enjoyment	12
No. 2 One-Transistor Radio—add a transistor and get more volume	14
No. 3 Three-Transistor Radio—powerful enough to drive a 2½" speaker	15
No. 4 Loudspeaker Cabinet—build your own for better sound	17
No. 5 Sun-Powered Radio—now you're working with photocells	18
No. 6 Portable Electronic Megaphone—an inexpensive "loud-hailer"	20
No. 7 Safety-Light Flasher—use it on the road or on the water	21
No. 8 Continuity Tester—locates "shorts" and "opens"	23
No. 9 Electric Maze—test your steady hand with this	24
No. 10 Code Instructor—has "private listener," built-in key	25
No. 11 Advanced Code Instructor—operates a loudspeaker for group use	27
No. 12 Electronic Timer—adjustable for periods up to 10 seconds, or more	29
No. 13 Photo Exposure Meter—a "snap" to make	31
No. 14 Electronic Metronome—something for the musician	32
No. 15 Electronic Organ—for music makers of all ages	33
No. 16 Hi-Fi Power Meter—measure the output of your amplifier	35
No. 17 Audio Generator—a handy signal source	36
No. 18 Transistorized Power Amplifier—pep up the sound of your portables	37
No. 19 Transistor Tester—check leakage and gain with this project	39
No. 20 Burglar Alarm—photocell is dependable watchdog	40
No. 21 Photo Exposure Meter—transistorized for ultrasensitivity	42
No. 22 Slave Flash—for the "wireless" photographer	43
No. 23 All-Transistor Amplifier—just right for your record player	44
No. 24 Home Broadcast Station—no license needed	47
No. 25 Field Strength Meter—for Hams and CB'ers	48
Introduction to Part 2—more about components; working with 110-volt "house power"	51
No. 26 Wireless Code Transmitter—needs no license, operates on broadcast band	57

No. 27	Loudspeaker-Microphone—making a speaker work as a microphone	59
No. 28	Mike Preamplifier—for use with high-impedance microphones	60
No. 29	All-Transistor Intercom—instant push-to-talk inter-room communicator	61
No. 30	Rain Alarm—when it rains, it buzzes	63
No. 31	Color Comparator—match the swatch	65
No. 32	Clearance-Light Flasher—powerful highway and marine safety beacon	66
No. 33	Short-Wave Converter—simple and sensitive	68
No. 34	Citizens Band Transmitter—crystal-controlled, no license needed	70
No. 35	Transistorized VTVM—measures up to 10 volts DC	72
No. 36	Simple Tachometer—indicates rpm of small motors	73
No. 37	Telephone-Pickup—amplifies for group listening	74
No. 38	Directional Microphone—uses radar principles for point-to-point communications	75
No. 39	Stereo Balancer—use to equalize stereo-channel outputs	77
No. 40	Stereo Phasor—checks loudspeaker polarities for sound reinforcement	78
No. 41	Appliance Tester—simple resistance and AC voltage meter	79
No. 42	Electronic Stethoscope—pinpoints noise and vibration	80
No. 43	Audio Mixer—combines two mike signals for simultaneous recording	81
No. 44	Applause Meter—electronics is the “judge”	82
No. 45	S-Meter—add this to your CB and short-wave receivers	84
No. 46	BFO—lets you hear code transmissions on short-wave receiver	85
No. 47	Big-Voice Megaphone—power transistors provide lots of output	87
No. 48	Short-the-Circuit—an electric game of skill	89
No. 49	Battery-Eliminator—converts 110 volts AC to 9 volts DC	92
No. 50	Acoustic Receiver—auto horn turns on garage light	93
	Electronic Parts Cross-Reference Guide	95

INTRODUCTION TO PART 1

Before you begin working on the first project, you should become familiar with transistors, and some of the more important electronic components, schematic diagram symbols, and the tools you will use.

TOOLS

Small tools for use in constructing electronic projects are inexpensive, and can be used over and over again.



For soldering, an iron with a pencil tip is the most appropriate. It should be rated at $37\frac{1}{2}$ watts.



A coil of rosin-core solder (never use acid-core solder in electronics), and a roll of plastic-covered hookup wire.



5" long-nose pliers for handling components and for twisting wires together; 5" diagonal cutters for trimming.

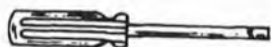

A large screwdriver for general work; a small "set" screwdriver for attaching knobs.

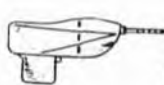

A small hand drill, a set of drill bits, and a key-hole saw are very useful.

BOARDS AND CHASSIS

The base on which electronic parts are mounted is called a "chassis." Many everyday things can be used; a piece of plywood or pine, (waxed or shellacked for protection against moisture), pegboard, plastic boxes, cigar boxes, small paper cartons, aluminum boxes, and cake pans are just a few of the more common chassis bases that have been used successfully by hobbyists and experimenters. A thin nonconductive

board with tiny perforations called "vector board" has become popular in recent years. Our projects will use a widely varied assortment of boards, some you may find around the house, and other specifically intended for use in electronics.

HOW TO RECOGNIZE ELECTRONIC PARTS

Your projects use electronic parts best suited to and most popular for transistor work. Here are some of those which are most often used:

Resistors — control voltage levels, limit currents in circuits, and separate circuit elements from each other.

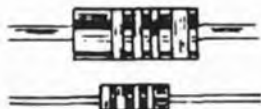

Capacitors — store energy, or isolate certain circuit elements from each other. Larger value units are usually "electrolytic" types. There are also tubular (long and round), ceramic (flat discs), and variable capacitors for tuning antenna coils.

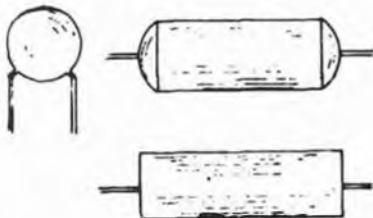

Antenna coils — when used with a variable capacitor, select and separate signals picked up by an antenna.



Earphones — small, low-power speakers which convert electrical energy to sound.



Loudspeakers — like earphones, but generally larger and more powerful.



IF (intermediate-frequency) transformers — interconnect sections in certain types of radios.





AF (audio-frequency) transformers — used to connect the output of one stage to the input of another. Power output types connect a stage to a loudspeaker.



Volume controls—a “potentiometer” or variable resistor used to electrically vary the size of a signal and the loudness of sound.



Diodes and rectifiers — convert alternating currents to direct currents. In many radio applications diodes are used as signal “detectors.”

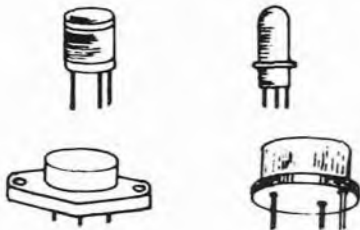

Transistors

A small-signal transistor amplifies relatively “small” electrical signals into much bigger ones.

Power transistors amplify considerably larger signals, do heavy work.



Solder lugs — easily soldered terminals for securing the leads from wires and parts; small holes for wires, larger holes for screw mounts.

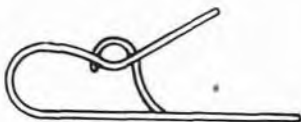

Fahnestock clips — spring-like grippers for the ends of wires; used when temporary connections are needed, such as to batteries, earphones, loudspeakers, and so on.

ELECTRONIC SIGN LANGUAGE . . . symbols

All wiring diagrams use symbols to designate electronic parts and interconnections. A wiring diagram, using these symbols, will be given for each project:



Resistor



Potentiometer

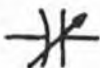

Variable capacitor



Tubular or ceramic

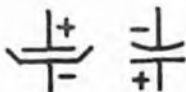

Electrolytic capacitor



IF transformer



AF transformer



Antenna coil



Earphone



Loudspeaker



Terminal or clip



Antenna



Ground



Diode



PNP transistor



NPN transistor



Solar Cell



Battery



Solder this junction



Do not join or solder

HOW TO SOLDER

A solder joint that "looks good" is usually electrically good. The soldering iron must be given time to get as hot as it can. If the tip of the iron melts solder instantly, it is hot enough for use. The joint to be soldered must be cleaned of any insulation, and the enamel wire coating scraped off. For best results, the joint must be heated by the iron so that the joint, not the iron, actually melts the solder.

Transistors, capacitors, and other small parts must be protected when the hot soldering iron is touched to their wire leads. With the tip of the long-nose pliers, grasp the wire lead close to the point where it enters the body of the component. This conducts the heat away from the delicate "insides" of the part, yet does not interfere with soldering.

Press the tip of the iron to the point you want to solder. Hold the end of the solder against the junction, not against the iron. If the junction is hot enough, the solder will flow like syrup onto the junction. Hold the pliers absolutely still while you lift the iron quickly away from the junction. The solder will cool and harden in a few seconds.

A good solder joint looks smooth and glossy. If too little heat is used or the wires are moved before the solder has hardened, the appearance is crystalline, dull. You can fix it by touching the iron to the joint again to liquefy the solder.

AN ANTENNA "PICKS UP" RADIO SIGNALS

The better the antenna, the stronger are the signals it provides. A good antenna is high up and clear of surrounding objects such as telephone and electric power lines, trees, and buildings.

A convenient and effective antenna for receiving commercial AM broadcast stations is a 50' length of flexible copper wire running from the edge of a house roof, for example, to a clothes pole, or to the top of another high structure.

Insulators at the ends of the wire electrically insulate it from its supports. Insulated lead-in wire connects the antenna to the radio set. The lead-in wire itself must be insulated.

A cold water pipe (not a hot one) makes a good "ground." Use a metal hose clamp, tightened to the pipe with the bare end of the ground wire from the radio set placed between the clamp and the pipe. Radios often work without a "ground," but usually work better with one.

NOW YOU ARE READY

You now have enough basic knowledge of the mechanics of electronics to begin building some projects. You will learn more about electronics from the experience and practice you get from building electronic circuits and using your completed projects. The more of them you build, the easier they become. And, just in an hour or so from now, you can be listening to radio stations on a set you built yourself as Project No. 1!

No. 1 CRYSTAL-DIODE RECEIVER

Here's one of the simplest radios known. It requires no power, and therefore costs nothing to operate. It provides endless hours of enjoyment, yet takes less than an hour to build. Only four parts, some terminal clips and short wires and you have a radio that really works. It's the original, rugged, sensitive "crystal" radio-receiver invented during grandfather's time. Today, it works better than ever, thanks to modern diodes and high efficiency coils and earphones. Engineers still assemble this circuit just to marvel that so simple a circuit can pull in stations loud and clear.

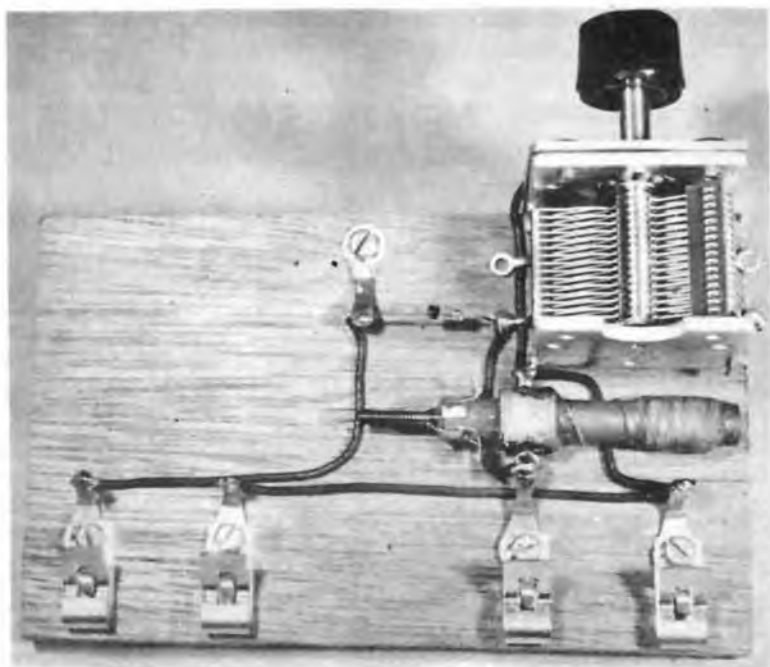

Radio signals are picked up by the antenna, tuned in by a variable capacitor and antenna coil, rectified and detected by the diode, and made audible by the earphone. The circuit provides no signal amplification, so the antenna is very important. A good "ground" is invaluable.

A waxed pine board, 3" x 5" x 3/4" makes a fine chassis for the radio. Use a strip of aluminum or other convenient material that can be drilled by hand to form a mounting bracket for the variable capacitor. The antenna coil can be held down by tape or household cement. Be sure to solder the wiring connections neatly. Protect the diode with long-nose pliers while soldering it in place. Fahnestock clips and solder lugs placed together and screwed into the board serve as connectors for the antenna, ground, and earphone wires.

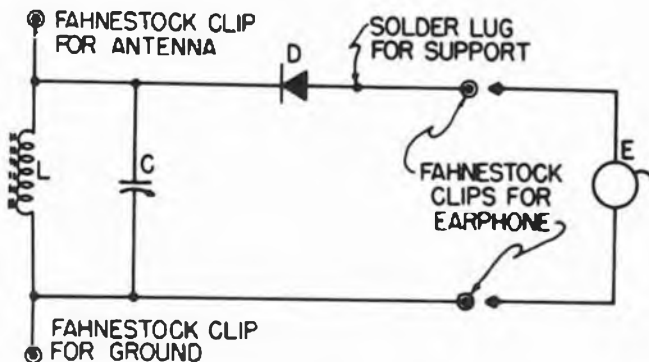

PARTS LIST

SYMBOL	DESCRIPTION	RADIO SHACK NO.
L	antenna coil	27-1430
C	capacitor, variable, 365 pf	27-1343
D	diode, 1N34A	27-1709
E	earphone, 2,000 ohms	33-180
	3" x 5" x 3/4" wood board	
	Fahnestock clips, solder lugs,	
	wood screws, wire, knob	

The diode should be wired with the black band on its body toward the variable capacitor. The frame of the variable capacitor is part of the electrical circuit and connects to the "ground" wiring.

No. 2 ONE-TRANSISTOR RADIO

Grandfather didn't have a way to amplify any of the sounds from his "crystal" radio until many years had passed. Of course, he didn't have transistors to make amplification easy and inexpensive. Fortunately, you do have them. Here is the basic transistor amplifier and diode radio combination. Virtually everything beyond this point becomes an extension of the principles used in this project.

In a short time you can modify Project No. 1 to add a transistor amplifier that can boost the signals from your basic crystal radio by as much as 70 times! You can convert your finished Project No. 1, or start a new board, saving the first to compare with the second.

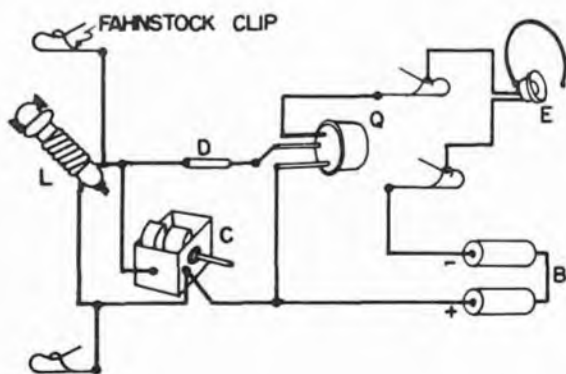

The pictorial view shows that you add 2 more Fahnestock clips and solder lugs between the antenna and the earphone clip positions on the board. These are for the battery connections.

The radio operates nicely with a single D-cell which gives approximately 1.5 volts. Two or more, up to six batteries in series, provide more amplification or loudness. It is important to observe correct battery polarity as shown in the diagram. If the battery polarity is connected wrong, the transistor will not do its job.

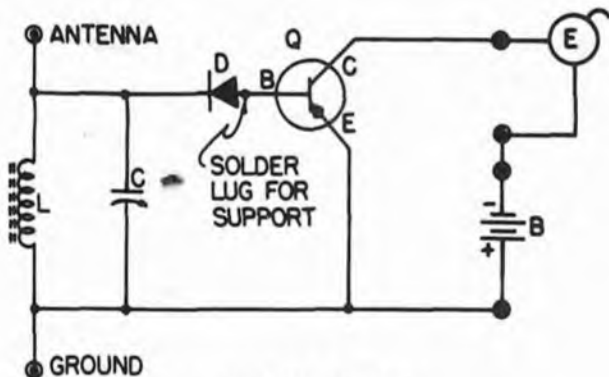

PARTS LIST

SYMBOL	DESCRIPTION	RADIO SHACK NO.
L	antenna coil	27-1430
C	capacitor, variable, 365 pf	27-1343
D	diode, 1N34A	27-1709
Q	transistor, 2N107	27-1701
B	battery, 1 or 2 D-cells in series	23-466
E	earphone, 2,000 ohms	33-180
	3" x 5" x 3/4" wood board	
	Fahnestock clips, solder lugs,	
	wood screws, wire, knob	

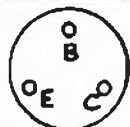

The transistor is a PNP-type. Looking at it from the bottom, its wire leads pointing up, the connections are this way.

The transistor draws so little current that the batteries should last a very long time. Turn the radio on or off by attaching one of the battery wires to its respective clip or, of course, by removing the battery.

No. 3 THREE-TRANSISTOR RADIO

Now it's time for you to make an amplifier so powerful it operates a loudspeaker which will fill a room with sound. In fact, it needs a volume control to keep the sound down!

The 3" x 5" board of the previous projects becomes a bit crowded when you use it for Project No. 3, but it certainly makes a compact radio. With great care to make sure that parts do not touch each other, the 3" x 5" board can be used.

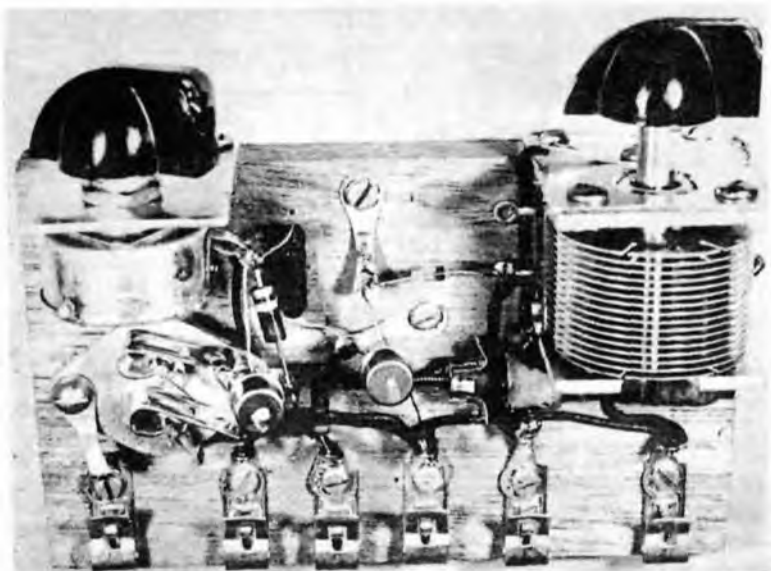

Use of a 4" x 6" board, however, will make it a lot easier to build. Note that 3 different transistors are used.

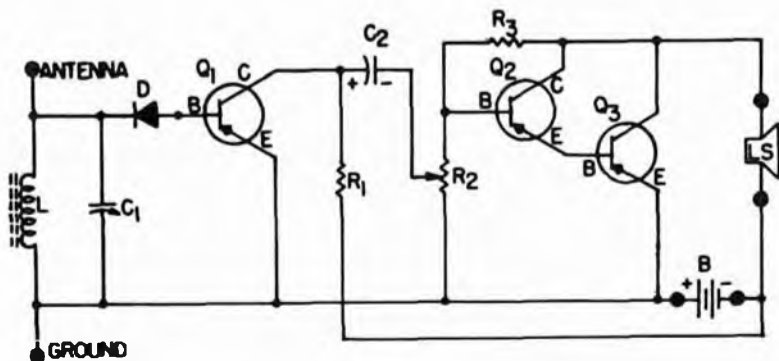

Two of the transistors look like the one in Project No. 2 and have the same connections. The third transistor is a power type shaped like a diamond. Its metal case is actually part of its circuit. You have to connect directly to it and make certain it is not touching any other metal parts or wires. Screw this transistor to the board with its two short, rigid wires sticking straight up. Use solder lugs between the screw heads and the transistor for electrical connections. Small Fahnestock clips serve as connectors for the two wire leads.

PARTS LIST

SYMBOL	DESCRIPTION	RADIO SHACK NO.
L	antenna coil	27-1430
C1	capacitor, variable, 365 pf	27-1343
C2	capacitor, 5 mfd, 6 volt electrolytic	27-952
D	diode, 1N34A	27-1709
R1	resistor, 10,000 ohms	70-0195
R2	potentiometer, 10,000 ohms, volume control	27-1715
R3	resistor, 100,000 ohms	70-0195
Q1	transistor, 2N107	27-1701
Q2	transistor, 2N408	27-1702
Q3	transistor, 2N307	27-1706
LS	loudspeaker, 2½"	40-247
B	battery, 2 D-cells (3 volts) 3" x 5" x ¾" wood board Fahnestock clips, solder lugs, wood screws, wire, 2 knobs	23-466

Resistor R1 substitutes for the earphone in Project No. 2. C2 lets the sound signals, but not the battery voltage, get from the first transistor to the second. Mount R2 on a strip of metal, as you did with C1, the variable capacitor. Use flashlight batteries.

No. **4** LOUDSPEAKER CABINET

Many of your projects will use a loudspeaker. An excellent size for living room listening is a 2½" loudspeaker. And, it will sound better when it is installed in a cabinet, sometimes called an "enclosure" or a "baffle." Because the sound is more directional when the loudspeaker is enclosed, it sounds louder. The dimensions are not critical. Almost any convenient box will do and it can be of cardboard, wood, or plastic.

A cardboard box sprayed with paint for appearance makes a desirable cabinet because the circular 2" cutout can be made easily with a razor blade or knife. (Plywood makes a sturdier cabinet, and although its construction requires more time and effort, is worth considering for permanent use.) A 3" x 3" piece of window screening placed between the loudspeaker and the inside of the cabinet cutout protects the fragile paper diaphragm of the loudspeaker. Use hookup

wire to connect to the two terminals of the loudspeaker. Punch a small hole in back of the box for the wire.

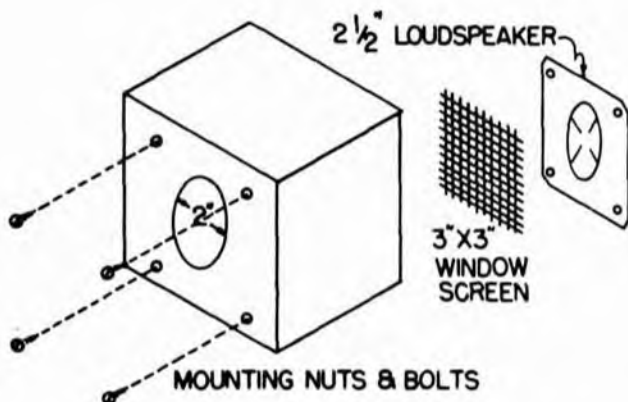

PARTS LIST

SYMBOL	DESCRIPTION	RADIO SHACK NO.
	loudspeaker, 10 ohm 2½"	40-247
	window screen, 3" x 3"	
	box, at least 6" x 6" x 6"	77-0640
	mounting bolts and nuts	
	2 lengths of wire	

No. 5

SUN-POWERED RADIO

Sunlight can be converted to many forms of energy, one of them electricity which we can put to work in this project. A device called a "solar cell" is the converter. And because it generates electricity when exposed to direct sunlight, it is popularly called a sun battery. The cell's two wire leads are polarized + and -. The red wire is + and the black is -. The cell generates enough electricity to power a small transistor radio such as shown in the diagram.

A variation on Project No. 2, this radio uses a solar cell instead of a D-cell battery. Follow Project No. 2 for parts layout on the wood board. No need to disconnect the solar cell when the radio is not used. It doesn't wear out with use. Try exposing the solar cell to a strong lamp if the sun is behind some clouds.

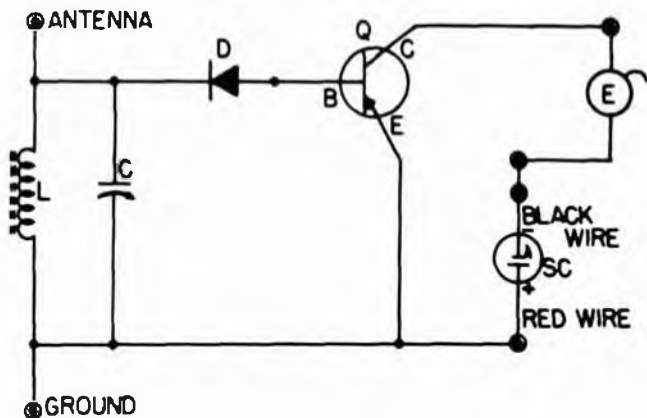
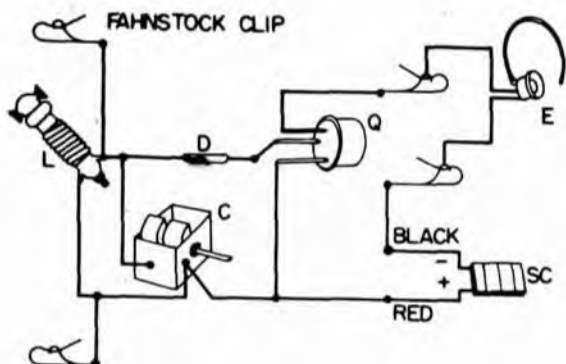

PARTS LIST

SYMBOL	DESCRIPTION	RADIO SHACK NO.
L	antenna coil	27-1430
C	capacitor, variable, 365 pf	27-1343
D	diode, 1N34A	27-1709
Q	transistor, 2N107	27-1701
SC	solar cell	27-1710
E	earphone, 2,000 ohms	33-180
	3" x 5" x 3/4" wood board	
	Fahnestock clips, solder lugs,	
	wood screws, wire, knob	

No. 6 PORTABLE ELECTRONIC MEGAPHONE

Portable self-contained megaphones or "bull-horns" are used by mariners to call across the water, by policemen to talk to crowds, etc. Just a few parts and one power transistor installed in a tin can or a plastic container are all you need, to make one of your own.

The container must be at least 3" inside diameter to hold the loudspeaker. Perforate the cover of the container to allow the sound to come through and install the loudspeaker behind the holes. Do the same at the other end of the container for the microphone. Epoxy cement can be used to hold the microphone in place. Drill a 1/4" hole in the side of the container for the on-off "push-to-talk" switch.

The diagram shows the simplicity of the circuit. The carbon microphone is actually a resistor that changes value as you talk into it. The microphone is connected to the battery

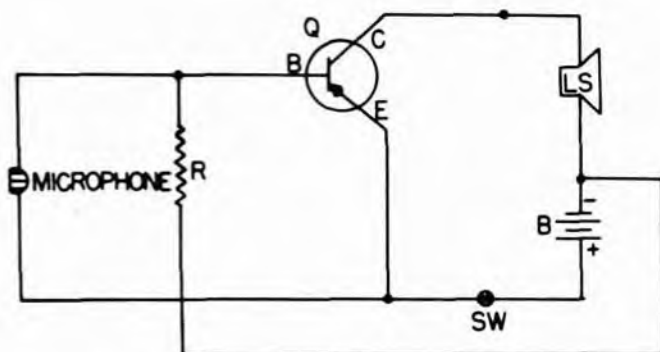

PARTS LIST

SYMBOL	DESCRIPTION	RADIO SHACK NO.
R	microphone, carbon	27-1425
Q	resistor, 3,300 ohms	70-0195
LS	transistor, 2N301	27-1705
SW	loudspeaker, 2 1/2"	40-247
B	switch, s.p.s.t. spring-return	27-1385
	battery (2 or 4 D-cells)	23-466
	Fahnestock clips, solder lugs, wire, container, cotton wadding, epoxy cement	

and the transistor input or "base." So, talking into the microphone varies the current at the transistor base. This change is amplified in the transistor output circuit (the "collector"), and operates the loudspeaker. A 3-volt supply (2 D-cells) works fine; 6 volts (4 D-cells) will give you more volume.

A perforated "vector" board, thin masonite, or a sheet of plastic, any nonconducting material 1½" x 2" makes a fine chassis for the electronic circuit.

Use Fahnestock clips to connect the two power transistor leads, and bolt a solder lug to the transistor case, which is the "collector" element. A solder lug bolted to the "vector" board terminates the resistor and the common loudspeaker and battery wires.

You can eliminate problems of mounting the electronic parts and the batteries inside the container (especially troublesome if the container is metal) by wrapping them in cotton wadding, after making all connections. Fill the container with cotton to reduce the possibility of feedback between loudspeaker and microphone. Hold the microphone end of the megaphone close to your mouth, press the switch button and start talking!

No.



SAFETY-LIGHT FLASHER

If you've ever stalled on a dark road with fast traffic whizzing by while you were trying to get the car started again, you will especially appreciate the value of this circuit. If you've ever been boating at night, you know the problem of locating your pier when you return. This electronic flasher can be set on top of a stalled car, or on the edge of your pier to act as a homing signal.

The circuit is an electronic switch operating at about 2 cycles per second. Each time the electronic switch turns itself on the transistors draw power from the batteries. The current flows through the lamp for an instant, making it give off a brilliant flash. The lamp can be colored red or blue for highway use, or a distinctive green or yellow for the boat pier. Use a transparent lacquer, tinted cellophane or a felt marker pen as a coloring.

The batteries should last a long time, even if left on con-

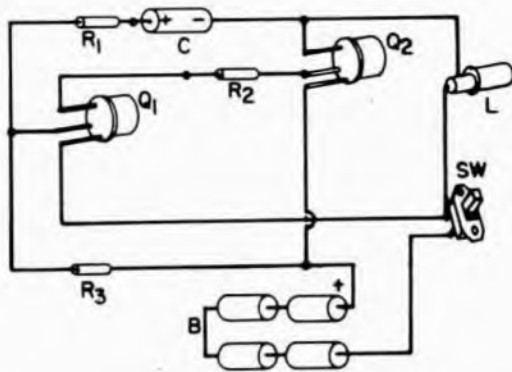

stantly. The flash rate can be increased by connecting two 5-mfd electrolytic capacitors in series at "C." Connecting them in parallel will slow the flashing rate.

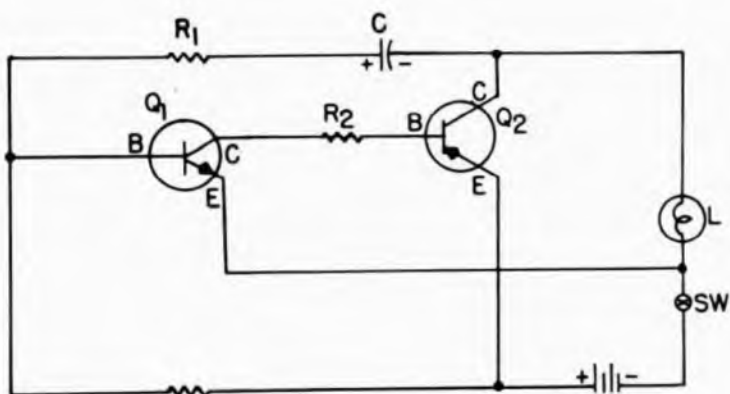

PARTS LIST

SYMBOL	DESCRIPTION	RADIO SHACK NO.
R1	resistor, 100 ohms	70-0195
R2	resistor, 1,000 ohms	70-0195
R3	resistor, 820,000 ohms	70-0195
C	capacitor, 5 mfd, 15 volt electrolytic	27-952
L	lamp, #49 bayonet	77-3392
Q1	transistor, 2N507	27-1703
Q2	transistor, 2N508	27-1702
B	battery, 4 D-cells (6 volts)	23-466
SW	switch, s.p.s.t.	27-602

No. 8

CONTINUITY TESTER

At some time you will want to check wiring for completed or open circuits. Here is an easy-to-build circuit tester you can use. It uses only two parts, some flexible wire, and a plastic box.

An on-off switch is not needed. The circuit draws no current unless the two test leads are touching. The lamp draws so little current an ordinary pen cell will last almost as long as it would on the shelf.

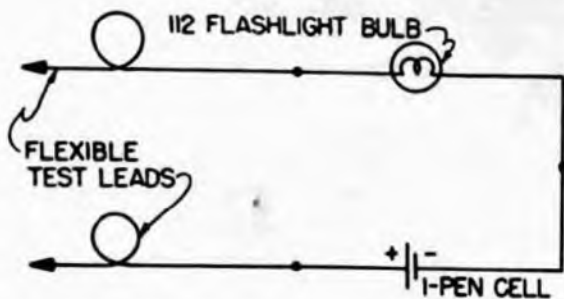

Cotton, cloth, or polyurethane can be used as a filler to keep the parts from rattling inside the box. Carefully drill two small holes in the box (slowly, so as not to crack the plastic). These holes are for the test leads, which are 18" lengths of flexible wire with the ends bared and soldered to make them stiff. To test, touch the ends of the test leads to a circuit. The lamp lights if there is continuity and very little resistance, indicating a complete circuit, or a short circuit, as the case may be. If the lamp doesn't light, either the circuit resistance is too high or it is open.

No. 9 ELECTRIC MAZE

Here's a game that can be put together in a matter of minutes. It provides a test of "steady fingers." Children are fascinated by it as a party game or a rainy day activity. The game can be made almost any size. However, a 6" x 10" x $\frac{3}{4}$ " board is most convenient for handling and storing.

Mark the outline of the maze as shown in the diagram. The lines should be no more than $\frac{1}{2}$ " apart, reducing to $\frac{1}{4}$ " at the center. Insert $\frac{3}{4}$ " brads at each of the corners, allowing the top $\frac{1}{4}$ " of the brads to protrude. Wrap the end of a long length of wire (use #22 bare, tinned wire) around the top of the brad at the center, point "A."

Hold the wire taut and wind it successively around the top of each brad, moving clockwise outward to point "B." Solder the wire at each brad to hold it taut. Connect two C-cells to any convenient point in the wire of the maze and then to the buzzer. A 6" piece cut from a wire coat hanger

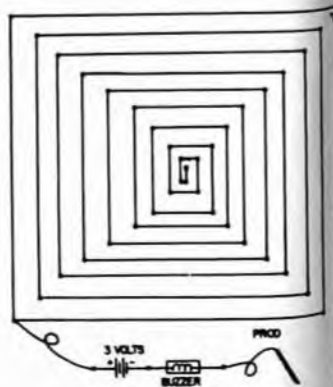
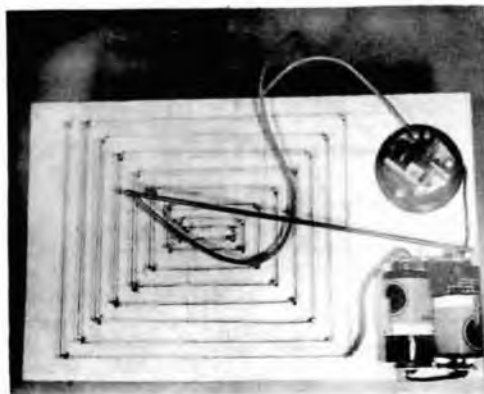

is the "prod." Scrape the ends clean of paint. Solder a 15" length of insulated flexible wire from the prod to the unconnected terminal of the buzzer.

Rules of the game require that the player hold the prod in one hand, with the other hand behind his back. Start by touching the prod to point "B" to make the buzzer sound. Then the player takes the prod from "B" and follows the trail to the center. The prod must stay in contact with the wood board. Each time the prod touches the wire that outlines the trail, the buzzer sounds and a point is scored against the player. The play ends when the prod reaches point "A." The player with the least number of points scored against him is the winner.

No. 10 CODE INSTRUCTOR

Code sent by actuating a key is a means of communication using a single musical tone to form dots and dashes. The combination of dots and dashes identifies different letters and numerals. Words are spelled out.

This tone generator or code signaller can be used to learn and practice the code. All parts except the battery and the earphone can be mounted on any convenient board. Fahnestock clips and solder lugs provide the terminals for battery, earphone and parts connections.

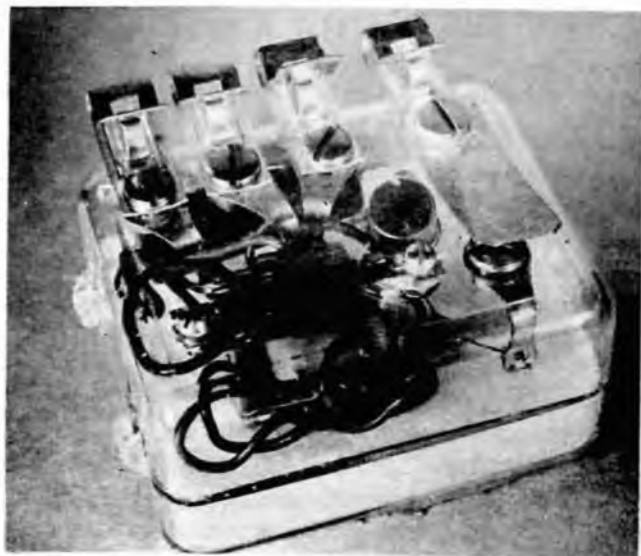

PARTS LIST

SYMBOL	DESCRIPTION	RADIO SHACK NO.
C	capacitor, .01 mfd tubular	71-0402
R	resistor, 150,000 ohms	70-0195
Q	transistor, 2N170	27-1703
T	transformer, AF output —500 ohm CT primary —3.2 ohm secondary	27-1379
B	3-volt battery supply "D" cell (2 req'd.)	23-466
E	earphone, low imp.	33-175

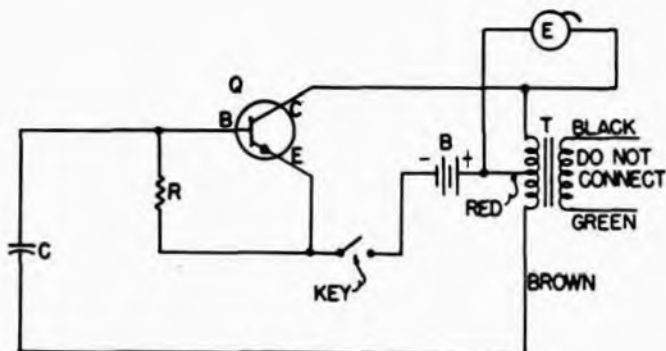

The key is made from $1\frac{1}{4}$ " x $\frac{1}{2}$ " strip of metal cut from a juice can. The head of a 6-32 bolt is the contactor against which the key is pressed for tone.

It is not necessary to disconnect the battery. The key acts like an on-off switch. Hint: think of a dash as "dah" and a dot as "dit."

INTERNATIONAL MORSE CODE ALPHABET

The International Morse Code is used for CW radio-communications throughout the world. It involves the use of combinations of short and long tone signals known as "dots" and "dashes," or more commonly today, "dits" and "dahs." The latter more closely resembles the actual sound, rather than the "short-hand" method of representing the characters visually. The following code table uses the more modern "dit" and "dah" combinations.

A	<i>di-dah</i>	end	<i>di-dah-di-dah-dit</i>
B	<i>dah-di-di-dit</i>	period	<i>di-dah-di-dah-di-dah</i>
C	<i>dah-di-dah-dit</i>	comma	<i>dah-dah-di-di-dah-dah</i>
D	<i>dah-di-dit</i>	hyphen	<i>dah-di-di-di-di-dah</i>
E	<i>dit</i>	colon	<i>dah-dah-dah-di-di-dit</i>
F	<i>di-di-dah-dit</i>	break	<i>dah-di-di-di-dah</i>
G	<i>dah-dah-dit</i>	wait	<i>di-dah-di-di-dit</i>
H	<i>di-di-di-dit</i>	error	<i>di-di-di-di-di-di-dit</i>
I	<i>di-dit</i>	?	<i>di-di-dah-dah-di-dit</i>
J	<i>di-dah-dah-dah</i>	semicolon	<i>dah-di-dah-di-dah-dit</i>
K	<i>dah-di-dah</i>	parenthesis	<i>dah-di-dah-dah-di-dah</i>
L	<i>di-dah-di-dit</i>	quote	<i>di-dah-di-di-dah-dit</i>
M	<i>dah-dah</i>	slant bar	<i>dah-di-di-dah-dit</i>
N	<i>dah-dit</i>		
O	<i>dah-dah-dah</i>		
P	<i>di-dah-dah-dit</i>	1	<i>di-dah-dah-dah-dah</i>
Q	<i>dah-dah-di-dah</i>	2	<i>di-di-dah-dah-dah</i>
R	<i>di-dah-dit</i>	3	<i>di-di-di-dah-dah</i>
S	<i>di-di-dit</i>	4	<i>di-di-di-di-dah</i>
T	<i>dah</i>	5	<i>di-di-di-di-dit</i>
U	<i>di-di-dah</i>	6	<i>dah-di-di-di-dit</i>
V	<i>di-di-di-dah</i>	7	<i>dah-dah-di-di-dit</i>
W	<i>di-dah-dah</i>	8	<i>dah-dah-dah-di-dit</i>
X	<i>dah-di-di-dah</i>	9	<i>dah-dah-dah-dah-dit</i>
Y	<i>dah-di-dah-dah</i>	0	<i>dah-dah-dah-dah-dah</i>
Z	<i>dah-dah-di-dit</i>		

No. **11** ADVANCED CODE INSTRUCTOR

This "code instructor" generates a tone that can be heard loud and clear across a large room. The loudspeaker of Project No. 4 is perfect for this one. In fact the code instructor is so compact, despite its power, that it can fit right inside the cabinet of the loudspeaker. Pen cells can be used for battery power making it possible to make the entire unit in just one piece. A key can be made from a flexible strip of metal, as in the previous project, and mounted on a board. The board can be installed in a plastic box, or on top of the loudspeaker cabinet.

Two transistors are used. Potentiometer R3 is a pitch control. Increasing its resistance increases the tone heard in the loudspeaker when the key is pressed. If the sound is

too loud, use of a single cell will decrease the volume. Increase volume by using up to 4 cells in series.

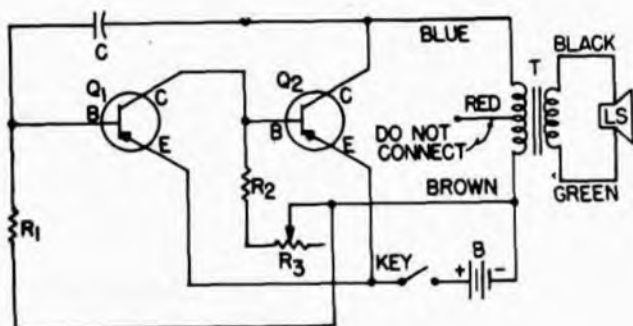
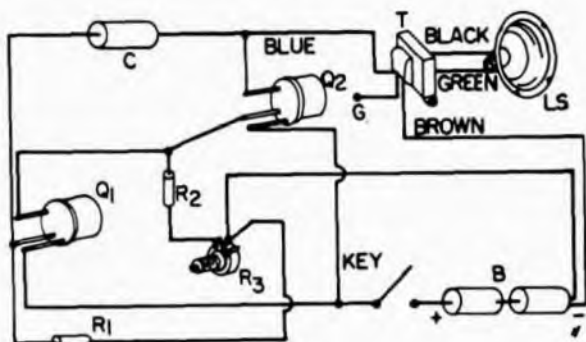

PARTS LIST

SYMBOL	DESCRIPTION	RADIO SHACK NO.
C	capacitor, .01 mfd tubular	71-0402
R1	resistor, 100,000 ohms	70-0195
R2	resistor, 470 ohms	70-0195
R3	potentiometer, 10,000 ohms, pitch control	27-1715
B	3-volt battery supply "D" cell (2 req'd.)	23-466
LS	loudspeaker, 3.2 ohm 2½"	40-247
T	transformer, AF output —500 ohm CT primary —3.2 ohm secondary	27-1379
Q1, Q2	transistors, 2N109	27-1702

No. 12 **ELECTRONIC TIMER**

Timing is important in many things, but especially so in sports events. A time out or a warmup period or an interval of play must be precisely controlled and a signal sounded to indicate "time's up." A transistor and an electrolytic capacitor for storing energy are the basics for this project.

The start-time switch is a spring-return single-pole, double-throw unit. It is shown in its normal position, in contact with the base of the transistor. Pressing this switch, after having turned on the power toggle-switch, places electrolytic capacitor C across the 3-volt battery and it becomes charged. Releasing the switch causes the capacitor to discharge current into the base of the transistor, which instantly increases the current it draws from the battery. Relay RY therefore closes and the buzzer sounds off. The buzzer stays on until the capacitor charge depreciates and the transistor no longer conducts enough current to hold the relay contacts closed.

Potentiometer R2 controls the time that "C" takes to discharge and, therefore, the duration of the buzzer operation. The values given in the diagram enable control of the time from approximately 1 second to 10 seconds. A dial can be made and placed on the base board under the timer's pointer

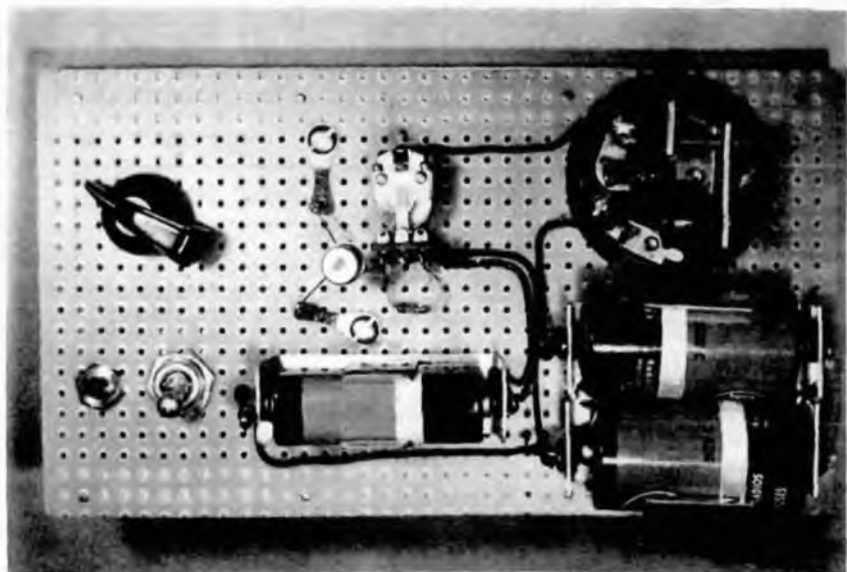

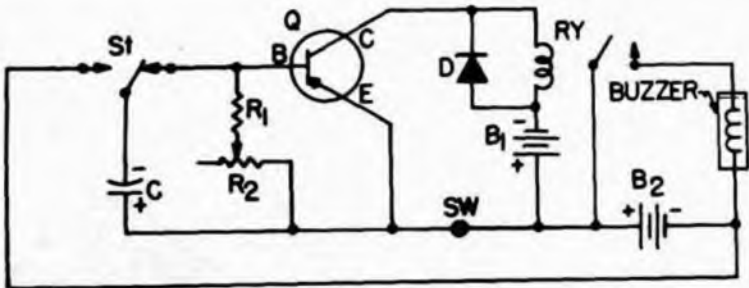
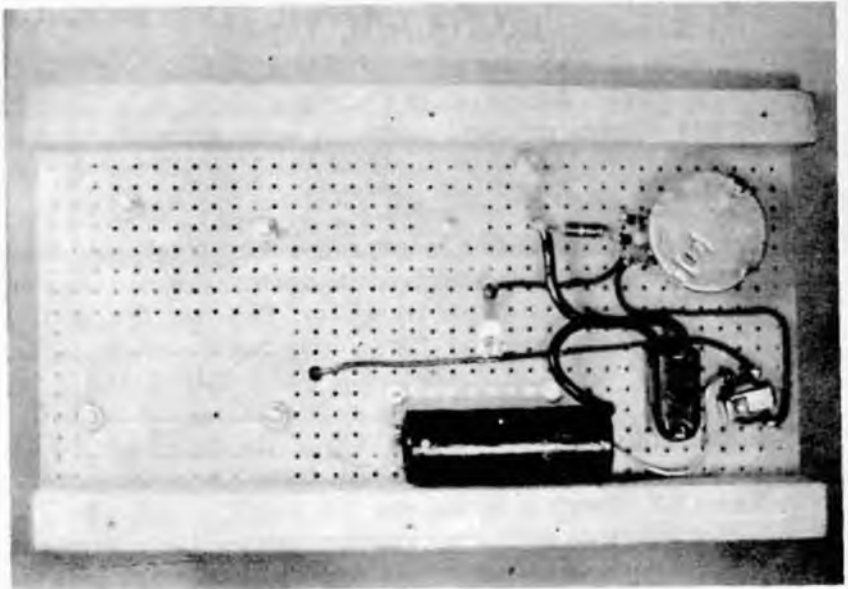

PARTS LIST

SYMBOL	DESCRIPTION	RADIO SHACK NO.
C	capacitor, 1,000 mfd, 6 volt electrolytic	27-1717
R1	resistor, 100 ohms	70-0195
R2	potentiometer, 10,000 ohms, time control	27-1715
Q	transistor, 2N270	27-1702
D	diode, 1N34A	27-1709
RY	relay, 5,000 ohm (miniature)	27-1712
B1	22½-volt battery supply	23-097
B2	battery supply, "D" cell	23-466
St	switch, s.p.s.t. spring-return	27-1385
Sw	switch, s.p.s.t.	27-602
	buzzer	20-1086

knob. Checked against a stop-watch, the dial can be calibrated to provide settings for any desired time up to 10 seconds.

A vector board mounted on two wood slats makes an excellent platform-like base on which to build the electronic timer.

Diode "D" in parallel with the relay protects the transistor against damage as the relay actuates and generates an instantaneous back e.m.f., a voltage induced by build-up of a magnetic field around the coil of the relay. Polarity of the diode is important, the black color band being closer to the transistor terminal of the relay than to the battery end.

No. 13 PHOTO EXPOSURE METER

In Project No. 5 we used a solar cell to power a 1-transistor radio. We know the radio works and the solar cell generates electricity, as a result of our experiments with that project.

If we connect the solar cell to a meter that indicates current, the meter will swing in relationship to the amount of sunlight that strikes the sensitive surface of the cell. In fact, we discover by making such a connection that even reflected light will make the needle of the meter give an indication. By calibrating the meter in relationship to the

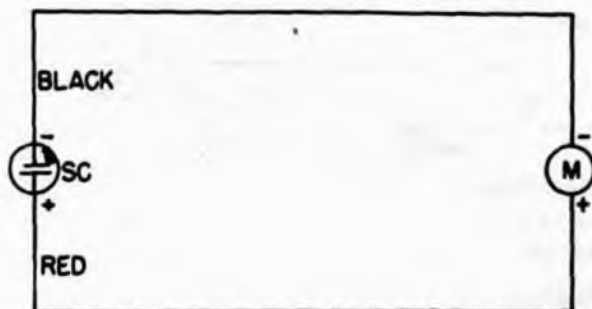

PARTS LIST

SYMBOL	DESCRIPTION	RADIO SHACK NO.
SC	solar cell	27-1710
M	meter, 0-1 milliampere	22-018

amount of light that reaches the solar cell, we have a light meter that can be used to determine the settings of a camera diaphragm and shutter.

A small can or box can be used to house the light meter. Cut a circular hole for the current meter in one end of the box, a small "peep" hole for the solar cell at the other.

Point the end with the solar cell at the object or person to be photographed and note the meter setting. The meter can be accurately calibrated by comparing readings against a commercial photo exposure meter.

No. 14 ELECTRONIC METRONOME

The old familiar pendulum of the music teacher's metronome can be replaced by a simple electronic circuit. No more winding up, no moving parts to be protected against rust and corrosion. The entire metronome is so small it can be installed in the same box as the loudspeaker which provides the "tick-tick-tick" sound.

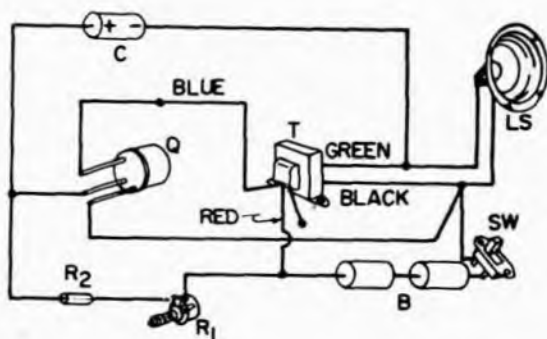

The circuit is that of a variable frequency "click generator." Potentiometer R1 varies the click rate from approximately 3 per second to 250 per second. Ordinary batteries provide many, many hours of operation. The only critical part of the wiring is in the connections from the secondary of the transformer. If the metronome doesn't work immediately and all wiring and parts check okay, try transposing

the green and black wires from the transformer. Do not transpose any of the other wires at the same time. You will find the electronic clicks sound just like the old mechanical metronome clicks.

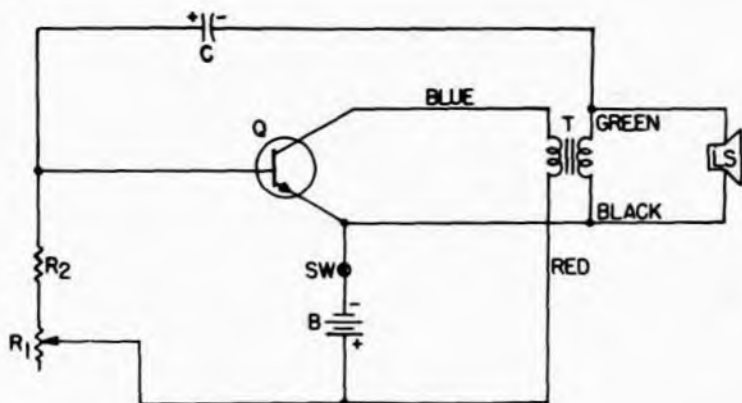

PARTS LIST

SYMBOL	DESCRIPTION	RADIO SHACK NO.
R1	potentiometer, 1,000,000 ohms	27-211
R2	resistor, 10,000 ohms	70-0195
C	capacitor, 10 mfd, 15 volt electrolytic	27-953
Q	transistor, 2N507	27-1703
SW	switch, s.p.s.t.	27-602
B	3-volt battery supply, 2 "D" cells	23-466
T	transformer, AF output —500 ohm CT primary —3.2 ohm secondary	27-1379
LS	loudspeaker	40-247

No. 15 ELECTRONIC ORGAN

This little electronic organ can be as much fun for Junior as the mighty Wurlitzer and Hammond are for Dad. It is rugged, too, so there is little to fear from "tiny hands."

A single transistor is used in a circuit that oscillates at an audible frequency each time a key is pressed. Capacitors C1 through C8 are connected in series with a tone key at each capacitor junction. Each key selects a different number of series connected capacitors, thereby changing the overall capacitance of the circuit. This changes the frequency of oscillation, thus a different note for each key.

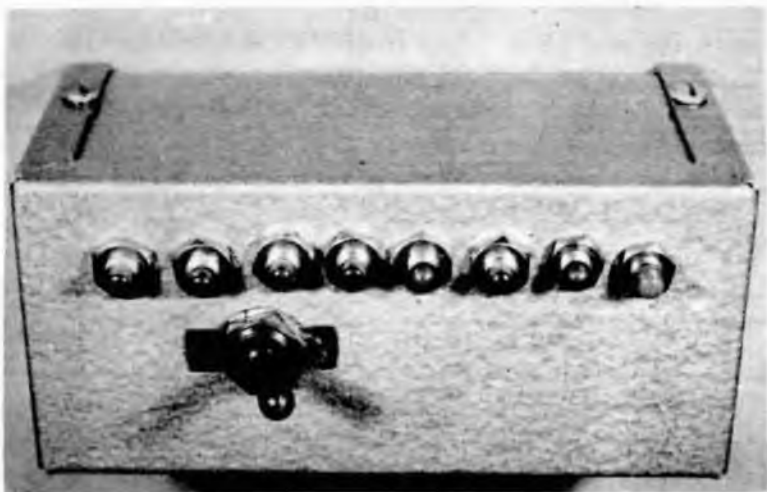

For a finished project, mount chassis in metal case, use spring-return push buttons to actuate tone keys.

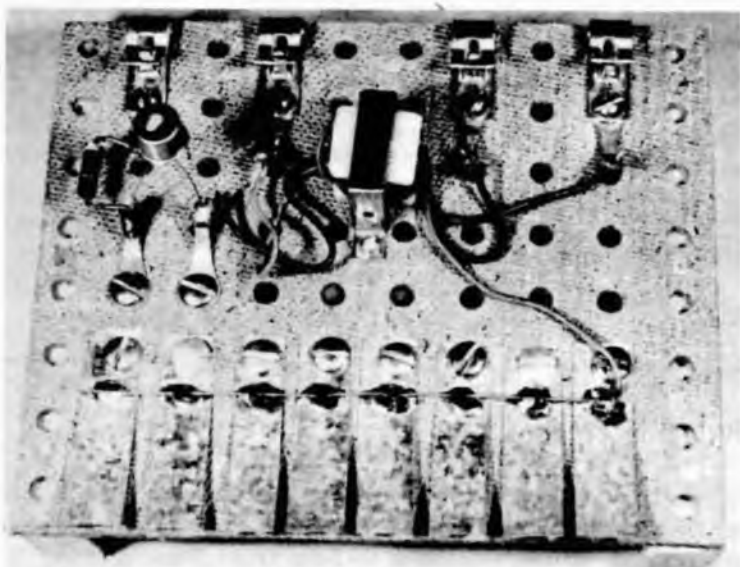

A 4" x 5" piece of pegboard mounted on $\frac{3}{4}$ " wooden slats makes an excellent chassis on which to build this project. Fahnestock clips and solder lugs serve as terminals for the battery and loudspeaker connections. The .02-mfd tubular capacitors C1 through C8 can be mounted under the board for neater appearance.

The organ works with as little voltage as that supplied by a single cell. However, the higher the voltage, up to 9 volts, the louder the sound. With 3 volts the tone is pleasant and not loud enough to disturb anyone.

Tone keys are made of strips of juice-can metal as with the code key in Project No. 10.

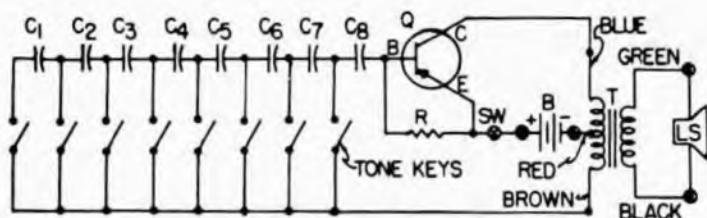

PARTS LIST

SYMBOL	DESCRIPTION	RADIO SHACK NO.
C1-C8	capacitors, .02 mfd tubular	71-0424
R	resistor, 100,000 ohms	70-0195
B	battery supply, 1.5-9V (as required)	23-466
Q	transistor, 2N109	27-1702
T	transformer, AF output —500 ohm CT primary —1.2 ohm secondary	27-1379
LS	loudspeaker, 3.2 ohm 2½"	40-247
SW	switch, s.p.s.t. tone keys, see text for construction	27-602

No. 16 HI-FI POWER METER

Have you ever wondered how many watts of audio power your hi-fi amplifier or portable transistor radio was putting out? This circuit can tell you. It measures the voltage across a known resistance.

Play a steady-tone test record through your hi-fi amplifier system. Stop the record, disconnect the loudspeaker and attach the power meter's test leads to the 8-ohm output terminal of the amplifier. Start the record again and check the meter reading against the table below for a direct translation into watts.

The two 15-ohm resistors, R1 and R2, are connected in parallel to approximate the 8-ohm loudspeaker resistance. Do not leave the test leads connected to the amplifier any

longer than necessary to take a reading when measuring full-scale readings. You'll be amazed at how loud 1 watt really is.

METER READING	POWER IN WATTS
1.0	1.0
.8	.8
.6	.5
.4	.3
.2	.1

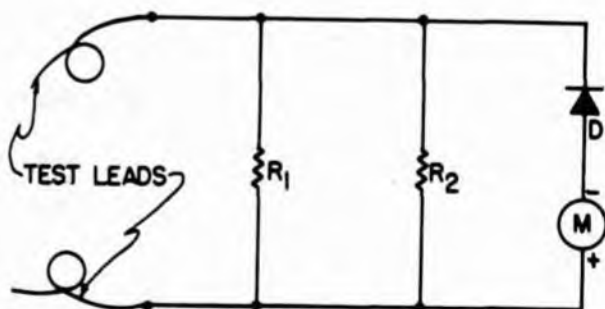

PARTS LIST

SYMBOL	DESCRIPTION	RADIO SHACK NO.
R1, R2	resistors, 15 ohms	70-0195
D	diode, 1N34A	27-1709
M	meter, 0-1 milliampere	22-018
	insulated flexible wire for test leads	

No. 17 AUDIO GENERATOR

An audio signal source is called an AF generator. It is valuable for testing many circuits in amplifiers, preamplifiers, earphones and small loudspeakers. In fact, this AF generator can be used very nicely for checking amplifier power output with the test meter of Project No. 16.

A single transistor operates as an oscillator. The frequency is not critical for single tone tests. What is important is the purity of the tone (freedom from harmonics and dis-

tion). Potentiometer R1 controls distortion. Listen to the tone on an earphone while setting R1 to give the "sweetest" tone.

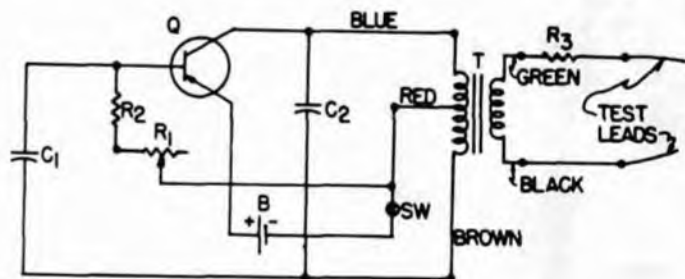

PARTS LIST

SYMBOL	DESCRIPTION	RADIO SHACK NO.
C1	capacitor, .01 mfd tubular	71-0402
C2	capacitor, .47 mfd tubular	71-0414
R1	potentiometer, 1,000,000 ohms	27-211
R2	resistor, 47,000 ohms	70-0195
R3	resistor, 10,000 ohms	70-0195
Q	transistor, 2N109	27-1702
SW	switch, s.p.s.t.	27-602
T	transformer, AF interstage — 2,000 ohm CT primary — 10,000 ohm secondary	27-1378
B	D-cell battery	23-466

Connect the tone generator's test leads to the input of your hi-fi amplifier and turn on the battery switch. Adjust volume with the amplifier controls. It is also useful in checking ham and CB transmitters for modulation.

No. 18 TRANSISTOR POWER AMPLIFIER

There's a lot of latent power in every small transistor radio. There's a lot of big sound hiding inside that can't come out because of the tiny size of the radio's cabinet. This project proves it and helps you get more enjoyment from your "cigarette pack" radio.

A huskier audio amplifier and bigger speaker arrangement are all you need. Project No. 4 shows you how to take care of the speaker problem. Here is the bigger amplifier in a plastic box only 2 $\frac{1}{4}$ " x 1 $\frac{3}{4}$ " x $\frac{7}{8}$ " . . . that's all!

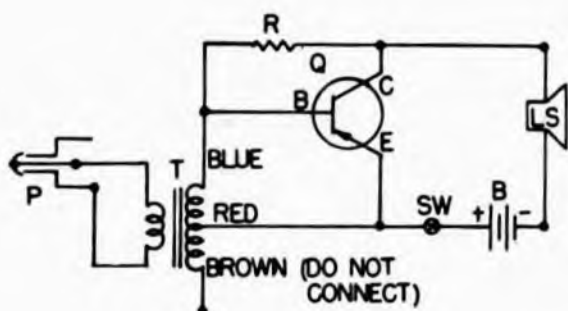

PARTS LIST

SYMBOL	DESCRIPTION	RADIO SHACK NO.
R	resistor, 330 ohms	70-0195
T	transformer, AF output —500 ohm CT primary —3.2 ohm secondary	27-1379
Q	transistor, 2N301	27-1705
P	plug, earphone type	75-3394
SW	switch, s.p.s.t.	27-602
B	6-volt battery supply	23-014
LS	loudspeaker, 10 ohm 2½"	40-247

The only parts are a power transistor, a transformer, an earphone plug that fits your transistor radio's output jack, a resistor, and a 6-volt battery supply of four D-cells in series.

The transformer is actually an AF output type. But we can use it nicely as an AF input transformer in this case by connecting it in reverse . . . the primary becoming the secondary, and vice-versa.

The 10 ohm winding of the transformer connects to the earphone plug, which is inserted in the radio output jack.

Connect the loudspeaker and batteries, turn on the transistor radio and you will immediately hear a new sound, a bigger, deeper sound from that tiny radio.

The volume control on the radio is simply used in the normal way to control the sound level. You'll be amazed at both the quality and power of the combination. Use one of your big hi-fi loudspeakers in place of the Project No. 4 loudspeaker to obtain even richer sound.

No. 19 TRANSISTOR TESTER

As you become more familiar with transistors you will want to learn more about their characteristics. In most of our projects so far the most important characteristics are the internal leakage and gain or amplification factors. This

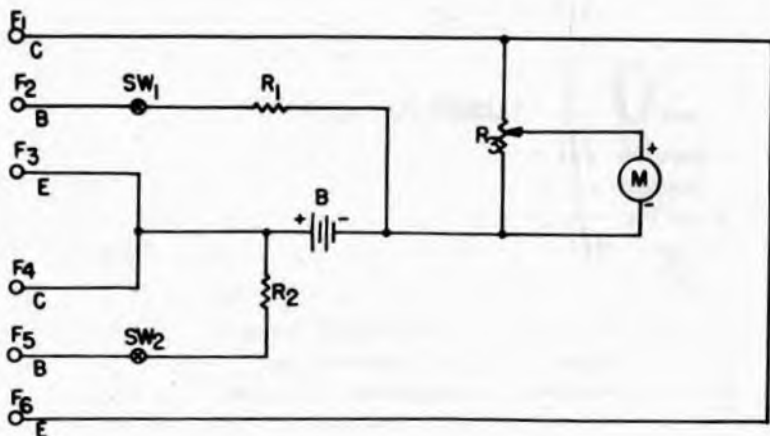

PARTS LIST

SYMBOL	DESCRIPTION	RADIO SHACK NO.
SW1	switch, s.p.s.t. spring-return (PNP gain)	27-1385
SW2	switch, s.p.s.t. spring-return (NPN gain)	27-1385
R1, R2	resistors, 220,000 ohms	70-0195
R3	potentiometer, 10,000 ohms	27-1715
M	meter, 0-1 milliampere	22-018
B	3 to 6 volt battery supply ("D" cells)	23-466
F1-F6	Fahnestock clips	

circuit gives you a very useful test instrument for determining those two things qualitatively.

A pegboard makes a good base for the tester. Make a bracket to support the meter, battery and two switches. An on-off switch is not needed. Potentiometer R3 is a calibration control. F1 through F6 are Fahnestock clips for the transistor leads.

Touch a bare wire from clip F1 to F3 and adjust R3 for a meter reading of 1. Remove the wire. To test a PNP transistor for leakage, connect its collector lead to F1, base to F2, and emitter to F3. (For NPN transistors, connect collector to F4, base to F5, and emitter to F6.) If the meter swings to 1, the transistor is shorted, no good. If the reading is over .2, leakage is too high. Next, press the "gain" switch. The meter reading should increase. The greater the ratio of gain to leakage readings, the better is the current amplification ability of the transistor.

No. 20 BURGLAR ALARM

A burglar alarm is just what its name says it is, an alarm that reports a possible burglar in action. It is not intended to trap him, just alarm him, hopefully to discourage him from committing the crime by letting him know he has been detected.

A transistor amplifies the small current generated by a solar cell to hold the relay contacts open. If the light is interrupted, the relay contacts close, setting off the buzzer alarm by completing the connection to the battery supply.

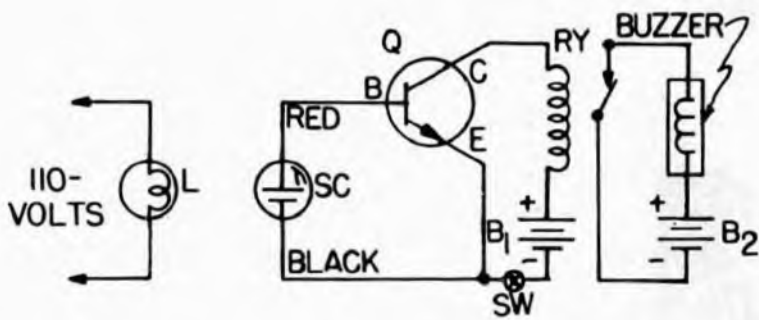
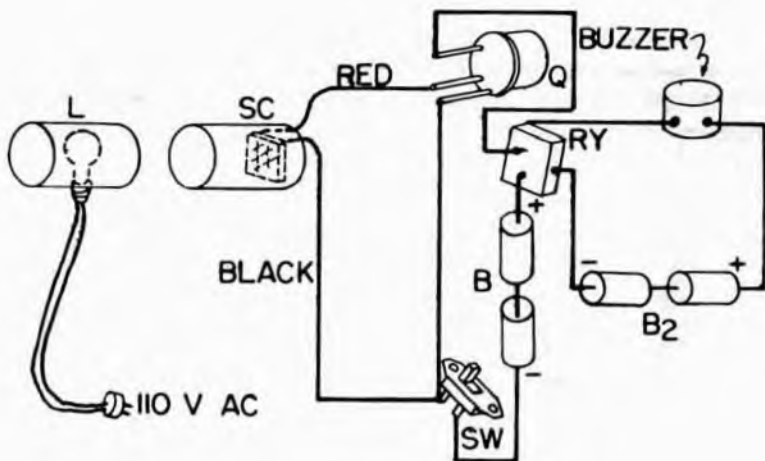

PARTS LIST

SYMBOL	DESCRIPTION	RADIO SHACK NO.
L	lamp, 110-volt (inside box or tube)	
SC	solar cell	27-1710
Q	transistor, 2N1431	27-1703
RY	relay, 5,000 ohms	27-1712
SW	switch, s.p.s.t.	27-602
B1	22½-volt battery supply	23-073
B2	3-volt battery supply "D" cell (2)	23-466
	buzzer	20-1086

The light should be a spot or beam concealed inside a box or tube and directed across a passageway. The solar cell is placed so that it catches the beam of light. Turn on the battery switch and adjust the positions of the light and the solar cell until the buzzer is stopped. A magnifying lens over the solar cell will increase its sensitivity. Glue or tape the lens over a cutout in the box or tube containing the solar cell. Shield the solar cell against stray light that might give false alarms.

No. 21 PHOTO EXPOSURE METER

Nighttime photography requires either an exceptionally good guess or a highly sensitive light meter to assure a good picture. The usual exposure meter is next to useless indoors or at night. We have seen how transistors amplify small currents into larger ones. By placing a meter in the transistor collector circuit, it is possible to indicate relative light levels that are very low to begin with.



A solar cell is used to convert light to electricity, as we have done before. The electricity is applied to the base of a transistor. As the electricity is decreased or increased at the transistor base, the current in the collector will decrease or increase. The meter scale can be calibrated against a commercial light meter. A single battery provides all the necessary power. Switch "SW" is a spring-return type. Press it to obtain a meter reading.

You will find that the sensitivity of this light meter is so great it will provide an indication when pointed at a match held about a foot away from the solar cell. The 10 ohm resistor in parallel with the meter "damps" the meter needle action to reduce the possibility of damaging it should the solar cell be accidentally pointed directly at the sun while "SW" is pressed.

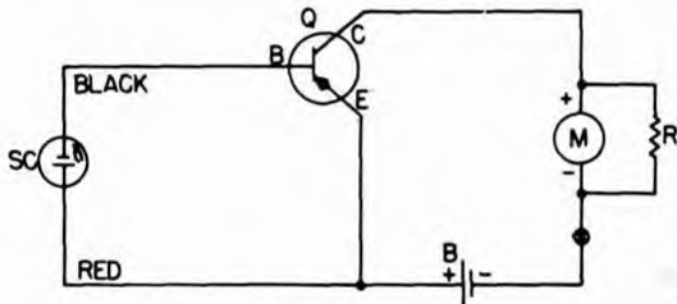

PARTS LIST

SYMBOL	DESCRIPTION	RADIO SHACK NO.
SC	solar cell	27-1710
Q	transistor, 2N270	27-1702
M	meter, 0-1 milliampere	22-018
R	resistor, 10 ohms	70-0195
B	1.5-volt battery supply ("D" cell)	23-466

The solar cell is mounted inside a tube 1" long and painted flat black inside. This shields the cell against stray or ambient light that might give false readings. Too, this makes the light meter highly directive. It will accept light from a relatively narrow field, which is desirable in photography of dimly lit subjects.

An aluminum box measuring only 4" x 2 $\frac{1}{8}$ " x 1 $\frac{3}{8}$ " makes an excellent, durable housing.

No. 22 SLAVE FLASH

This "slave" will flash a photolamp automatically when another flashlamp is fired in its vicinity. No wires interconnect the "slave" and its "master." A light sensitive solar cell generates a current the moment the master flash ignites. This current is amplified by the transistor to actuate relay RY. The relay transfers connections between ca-

pacitor C and the 22½-volt battery (from which it has been collecting a charge) to the flashlamp, causing it to ignite.

The "slave" can be tested before a flash bulb is inserted by depressing SW and watching the test lamp for a flash.

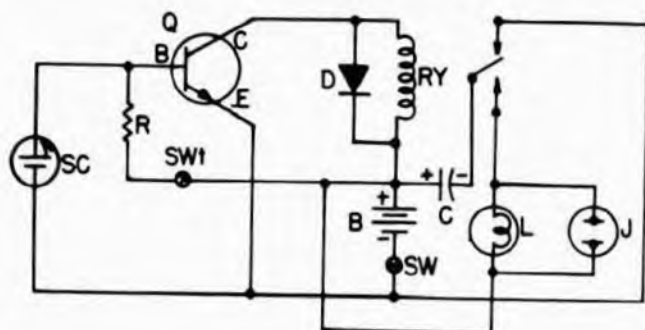

PARTS LIST

SYMBOL -	DESCRIPTION	RADIO SHACK NO.
SC	solar cell	27-1710
R	resistor, 220,000 ohms	70-0195
Q	transistor, 2N647	27-1703
D	diode, 1N34A	27-1709
RY	relay, 5,000 ohms	27-1712
SWt	switch, s.p.s.t. spring-return	27-1385
SW	switch, s.p.s.t.	27-602
C	capacitor, 100 mfd, 25 volt electrolytic	27-963
L	lamp, #47 bayonet	77-3396
J	socket, flash lamp	
B	22½-volt battery supply	23-097

If the "master" is the electronic "strobe" type, a test can be made by firing the master while watching the test lamp in the slave. The solar cell should be protected against stray light by a 1" tube painted flat black inside. In use, point the opening of the tube directly at the master flash or at some spot that will assure that a strong light reflection from the master flash will strike the solar cell.

No. 23 ALL-TRANSISTOR AMPLIFIER

A phonograph turntable, a ceramic or crystal phonograph pickup, the loudspeaker from Project No. 4, and the amplifier you build in this project make a complete, compact, system for playing and enjoying records.

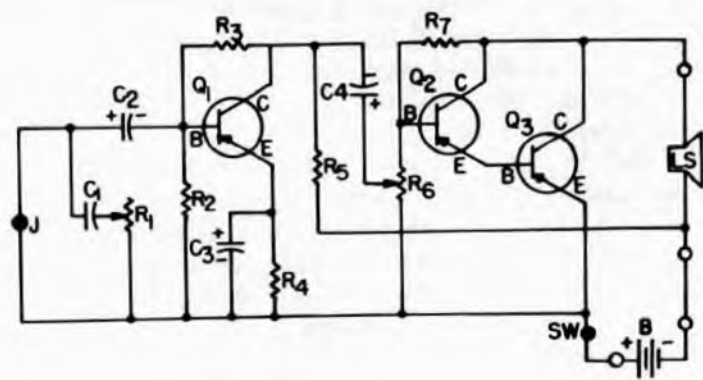
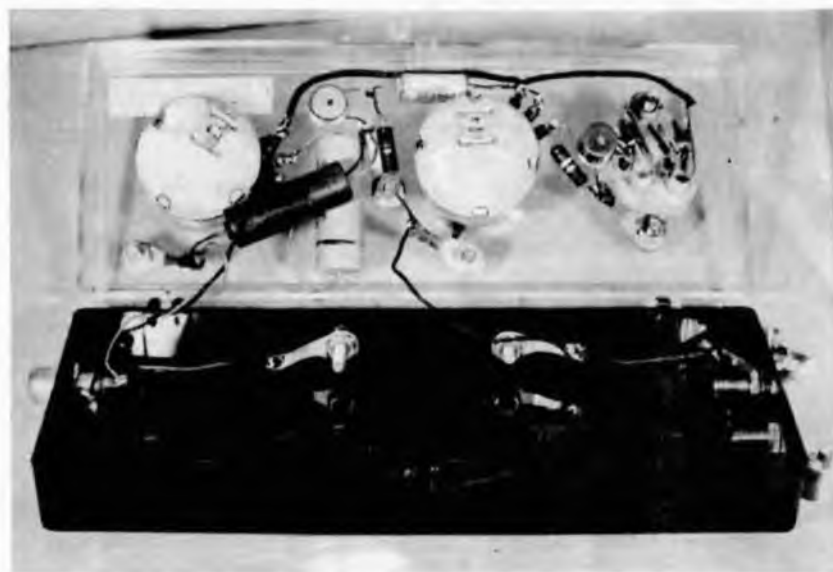
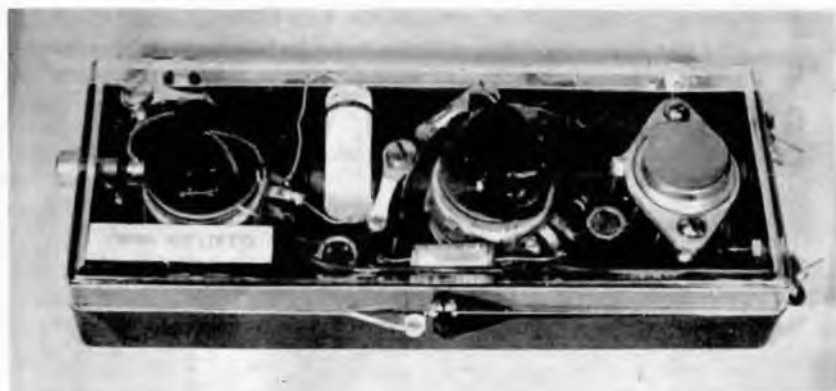

PARTS LIST

SYMBOL	DESCRIPTION	RADIO SHACK NO.
J	jack, phono	75-0966
C1	capacitor, .05 mfd tubular	71-0407
C2, C4	capacitor, 5 mfd, 15 volt electrolytic	27-952
C3	capacitor, 10 mfd, 15 volt electrolytic	27-953
R1	potentiometer, 50,000 ohms	27-1716
R2	resistor, 10,000 ohms	70-0195
R3	resistor, 270,000 ohms	70-0195
R4	resistor, 470 ohms	70-0195
R5	resistor, 4,700 ohms	70-0195
R6	potentiometer, 10,000 ohms	27-1715
R7	resistor, 47,000 ohms	70-0195
Q1	transistor, 2N107	27-1701
Q2	transistor, 2N465	27-1702
Q3	transistor, 2N301	27-1705
SW	switch, s.p.s.t.	27-602
LS	loudspeaker, 10 ohm 2½"	40-247
B	battery supply, 6 volts 4 "D" cells	23-466

The unit shown here can be built into a plastic box measuring only 6½" x 2½" x 1½". Always, when drilling holes in a plastic box, work slowly with light pressure to avoid cracking the thin plastic surface. The amplifier can, of course, be built on a wood board or vector board. Fahnestock clips at the back provide terminals for the battery. Clips at the right side are for the two loudspeaker wires. A small phono jack at the left side accepts standard phono plugs used in most hi-fi systems.

Potentiometer R1 is a tone control. The small signals from the phono pickup are amplified by transistor Q1 and fed to volume control R6. The volume control feeds the base of transistor Q2 which provides the amplified signal needed to drive power transistor Q3. Fahnestock clips are used for the two wire terminals of the power transistor.

If you feel brave and experienced enough in the handling of a soldering iron, you can solder directly to the tips of the rigid wires of Q3. Transistors are very heat sensitive, so be sure to use the long-nose pliers to dissipate the heat rapidly away from the transistor while soldering.

The amplifier will work very well with just one D-cell as the power supply. However, output power will be much greater with four D-cells (6 volts). Make all connections, turn on switch SW and adjust the volume and tone controls for good listening.

No. 24 HOME BROADCAST STATION

F.C.C. regulations permit you to operate an unlicensed transmitter with limited power that does not cause interference to other radio stations. This project is a complete, miniature radio-frequency transmitter and voice modulator that enables you to talk and be heard on a radio operating nearby.

The circuit uses two transistors and is small enough to fit into a plastic box or it can be built on a wooden board such as is used in Project No. 1. Keep all leads as short as possible, but do not cut any leads shorter than $\frac{1}{2}$ " from a component's body. Solder carefully. A crystal microphone or a crystal earphone works very nicely as a mike. The antenna must not be over 10' long. Turn on an AM radio and place it about 6' from the transmitter. Tune to 900 on

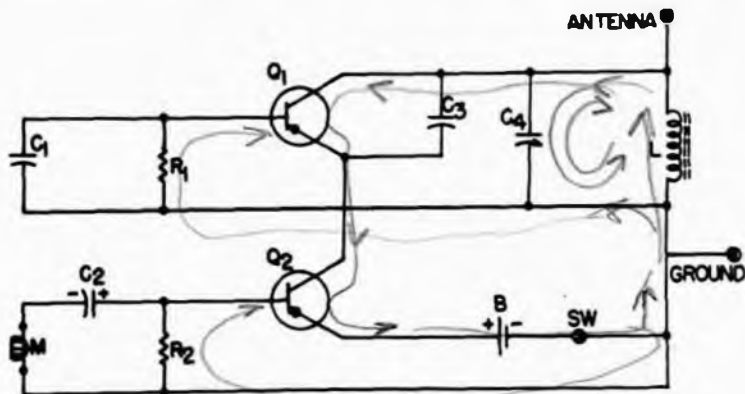

PARTS LIST

SYMBOL	DESCRIPTION	RADIO SHACK NO.
C1	capacitor, .01 mfd tubular	71-0402
C2	capacitor, 5 mfd, 15 volt electrolytic	27-952
C3	capacitor, 100 pf ceramic disc	71-5106
C4	capacitor, variable, 365 pf	27-1343
R1	resistor, 100,000 ohms	70-0195
R2	resistor, 150,000 ohms	70-0195
L	antenna coil	27-1430
Q1	transistor 2N247	27-1704
Q2	transistor, 2N109	27-1702
SW	switch, s.p.s.t.	27-602
M	microphone, crystal	33-100
B	3 to 9 volt battery supply (as required)	23-466

the dial or a clear spot near this setting. Turn on the transmitter. Rotate the variable capacitor slowly until you hear a "whoosh" on the AM radio. Talk into the microphone and tune the radio for the loudest signal.

You are now on the air!

No. **25** FIELD STRENGTH METER

A small coil, a variable capacitor, two disc ceramic capacitors, a diode rectifier and an indicating meter—all put together in a jiffy—provide the active ham or CB operator with one of the handiest projects he can build. The finished project is a "field strength meter," actually a small crystal-diode receiver similar to the first one in this book. However, instead of earphones, a meter is used to indicate the signal received. Instead of the ferrite coil and capacitor combination of Project No. 1, tuned to the AM-broadcast band, a combination is used to tune in the 20, 15 and 10 meter ham bands, and the 11 meter Citizens band.

The model shown in the photograph was built into an aluminum box measuring only 2¼" x 2¼" x 4". It is not at all necessary to enclose the components in a metal box. They can be assembled on virtually any base material; a pegboard, wood block or even a cardboard box. However, if you want to keep the unit on hand for regular use, the aluminum box construction is recommended. The principle of operation is quite straightforward. Following the wiring diagram, an antenna, consisting of a length of wire about 15" long is attached to J1. A straight length of #12 or #14 solid copper antenna wire can be used, too, for an antenna. In fact, the stiffer wire makes the FSM easier to handle.

The antenna picks up radio-frequency energy when it is placed close to an operating transmitter. Rotating capacitor C2 tunes L1 so that the combination resonates at the frequency of the transmitter's output signal. When this happens, the energy or RF voltage appearing across the parallel combination of C2 and L1 is maximum.

Diode rectifier D1 and meter M1 are in series and are connected across C2 and L1. D1 rectifies the RF voltage across C2 and L1, causing a direct current to flow through the circuit. The current is indicated on the scale of M1, increasing

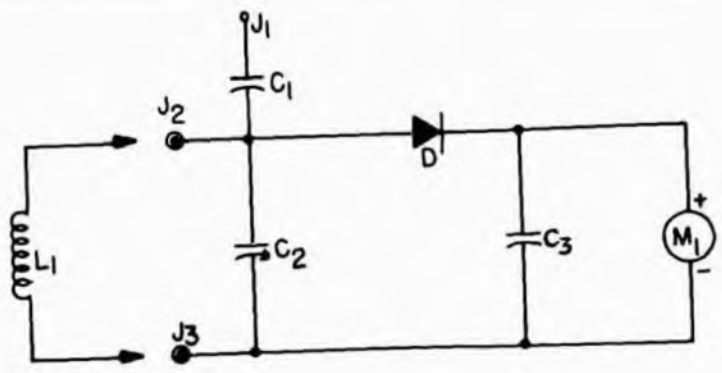
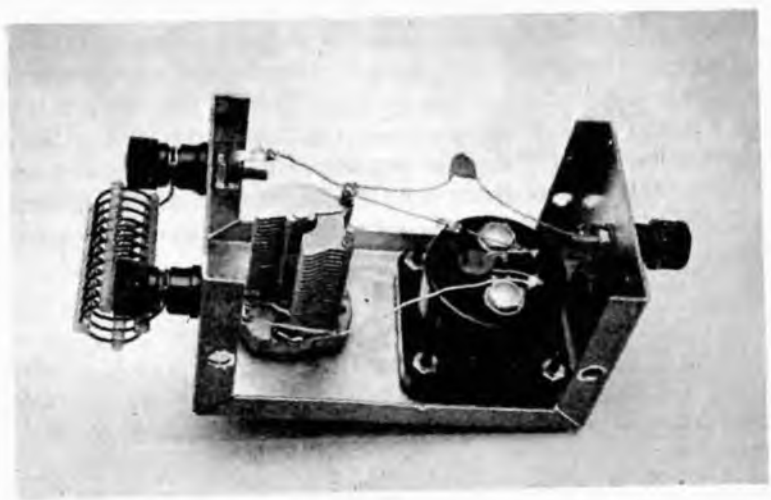

PARTS LIST

SYMBOL	DESCRIPTION	RADIO SHACK NO.
D1	1N34A	27-1709
C1	capacitor, 470 pf disc ceramic	71-5117
C2	capacitor, 140 pf variable	71-3291
C3	capacitor, .001 mfd disc ceramic	71-5123
M1	meter, 0-1 milliampere	22-018
L1	coil, 12 turns of hookup wire, 1/2" core dia. x 1 1/2" length	
J1-J3	Fahnestock clips, or jacks (must be insulated from metal chassis)	

and decreasing with the RF voltage picked up by the unit or as C2 is tuned through resonance.

M1 can be a 0-1 milliammeter. However, the sensitivity of the unit will be increased greatly if a 0-100 microammeter is used. The field strength meter is very useful in noting the effects on signal strength or radiation from a transmitting antenna when changes are made either in the transmitter or the antenna. It is exceptionally useful in tuning up a mobile ham or CB rig for maximum output from the antenna. The values given for C2 and L1 tune from approximately 14 mc to 30 mc. Experiments with other values will yield some interesting results and valuable experience.

INTRODUCTION TO PART 2

Presumably, you have already constructed many of the 25 projects in Part 1, and, if averages mean anything, you have had your share of wrong connections, poorly soldered joints, shorts, opens, etc. If you are ready and eager to go on, you are above average. Congratulations! There's a spot for you somewhere in the field of electronics. You not only learned that a well-built electronics project requires patience and careful construction techniques, but you have also gained some useful knowledge about transistors, capacitors, resistors, coils, and transformers. Now you are ready to advance.

In Part 1 we started out by guiding you with finished project photos and pictorial layout diagrams. You may have noticed, as you progressed, that the amount of guidance diminished. Now you have reached the point where you no longer have to be shown where and how to mount components. And you should be able to wire a circuit correctly by following nothing more than a schematic diagram. You'll have plenty of chances in Part 2!

The last two projects in this section are designed to be powered from a 110-volt AC source (such as provided by the standard wall outlets in your home). Do not attempt to build these until you have acquired the ability to wire, solder, and test several battery-powered projects perfectly. 110-volt "house power" **can be lethal!** Oh, yes—we know you may have been shocked several times, and you are still around to prove "it didn't hurt you." If you really don't know better, quit while you're ahead! Electrical currents are capable of "shocking" your entire "motor nerve" system (which automatically controls your breathing, heart action, etc.) into a complete "state of suspended animation." Higher currents can cause critical damage to vital organs.

As you have already learned, the amount of current through a conductor (the human body is a pretty fair conductor) depends on the applied voltage force and the resistance against this force. If a good contact between a "hot" line and "ground" is established by part of your body, enough current can flow to cause physical damage.

So, as we said before, electrical currents can be lethal—

even the ordinary 110-volt household kind. At the very least, it is dangerous—automatic reflex action may cause you to jerk your hand and strike it against something sharp, or you may react violently enough to fall over backward in your chair, etc., etc.

Your best protection against electrical shock is perpetual caution. It is unwise to touch the internal wiring of a device while it is connected to a power source. Don't just turn off the switch—**ALWAYS DISCONNECT THE POWER CORD AT THE SOURCE!** Another precaution is to make sure someone else is around. A person who has been shocked enough to stop breathing has a chance of being revived by artificial respiration. For your own safety, and that of others, make sure you know how to apply one of the approved methods of artificial respiration.

Okay, now you are ready to start earning your "Advanced Experimenter" license. In building the next 25 projects, you will be working with some components and circuits not used in Part 1. Many of the projects are no more difficult to build, but they can perform functions none of the previous projects could perform. Components you have not used in the previous projects will soon become as familiar as resistors and capacitors. You'll learn to recognize them from their physical appearance and of course from their schematic symbols.

MEET SOME NEW COMPONENTS



Crystals—used to control the resonant frequency of a circuit; identified by this schematic symbol.

Crystals for frequency control applications are actually small thin sheets of natural or synthetic mineral. The crystal element is compressed between two metallic plates, each connected to a terminal or "pin."

Crystals have a natural resonance; they oscillate or vibrate at a specific rate or frequency when excited or "shocked" by a small voltage. Crystals are housed in enclosures called "holders." The two types of holders you will see most frequently are popularly referred to as the "FT243" and the "HC6U."

The larger FT243 holder is held together by nuts and bolts. The second type, the smaller HC6U, is hermetically

sealed. The terminal pins are spaced approximately $\frac{1}{2}$ " apart. The HC6U pins are thinner than the pins of the FT243. Because of this difference, plug-in sockets for the



FT243



HC6U

two holders are different. In our projects, we will use only the HC6U holder.



HC6U Socket

Trimmer capacitors—often referred to as just “trimmers”; a form of the variable capacitor used in several of the preceding projects. Trimmers are compact, usually flat in shape. There are several different shapes available, and they can be used interchangeably if their electrical values are the same or similar. The physical aspects affect the



method of mounting, of course. The symbol for a trimmer is the same as that for a variable capacitor. A trimmer is sometimes used when there is not enough room for a full sized variable capacitor or when it is not necessary to regularly adjust the trimmer. (A small screwdriver is used to adjust a trimmer, while a knob is used for the larger variable capacitor normally used for circuit tuning.)

RFC—abbreviation for “radio frequency choke,” a coil wound on a bobbin. The bobbin, known as a “form,” is usually nonconducting and nonmagnetic. (There are some instances when a RFC uses a ferrite-filled bobbin.) The

RFC serves the very important purpose of isolating circuits that carry radio frequency signals from those that tend to absorb such signals or would not perform properly because of their presence. RF chokes are made in several different shapes. The most frequently used are the "pie-wound," and the "single-layer."

The electrical value for an RFC is defined in terms of the "henry," the unit of inductance. The henry is shown on diagrams and in parts lists by the letter "h." At short wave



and supersonic frequencies, chokes are relatively small; therefore, they may not have values of more than a few millionths (micro) or a few thousandths (milli) of a henry. When this is the case, the value is given in terms of μh (microhenries) or mh (millihenries). The electrical symbol for a choke is the same as that for an antenna coil, but without the broken line adjacent to it. Omission of the broken line indicates an air-wound coil, or nonmagnetic core. The coil may be wound on a paper or plastic tube or the wire may be rigid enough to support itself, without the necessity for a space-maintaining form.

Phono cartridge—the element in the head of a phonograph arm that retains the phonograph needle. It transforms the physical motion of the needle riding in the record groove into electrical signals. When the cartridge uses a "crystal" element, the symbol shown in diagrams resembles the one for a frequency-control crystal, with a diagonal arrow drawn through it.

Heat sink—has nothing to do with a kitchen, but refers to a technique for absorbing and carrying heat away from temperature-sensitive components. Transistors are very heat sensitive. When allowed to become overheated, transistors draw excessive current, more than they are designed to carry. If precautions are not taken to prevent overheating, the excess current can result in destruction of a transistor. It is important, then, to provide for rapid dissipation

of excess heat a transistor may generate or to which it may be exposed. This definitely applies to the heat from a soldering iron, which can be conducted through a transistor's wire leads into its body. That's why care must be exercised in soldering directly to transistor leads. And that's why it is recommended that long-nose pliers be used to hold the leads during the soldering operation. The pliers act as a heat sink, providing a large surface and easiest path for conducting away and dissipating unwanted heat.



The term "heat sink" is also used to define a small tool used during soldering as a "clamp." It acts as a third hand, very often helpful when soldering several components to the same terminal point. It is a spring-like device, sort of a miniature set of forceps, that can be clamped to the lead of a component close to the body. It is held in place by its own spring action, freeing both your hands for soldering. The device dissipates soldering heat before it can damage a heat-sensitive component such as a transistor.

A heat sink is also useful when soldering to the leads of miniature components such as the thin disc capacitors, and small resistors.



Coaxial connectors—plugs and jacks made especially for mating the ends of coaxial cables to the inputs and outputs of equipment. Automobile radios, for example, use a coaxial cable and connector to bring the antenna to the input

of the radio under the dashboard. Other circuits, especially those intended for short wave operation, use a connector that provides minimum signal losses at cable termination points.

Meters—calibrated instruments for measuring electrical constants such as volts and amperes. As a voltage or a current is applied to the terminals of a meter, an indicating needle in the meter swings on a pivot. It swings across a dial which has been calibrated to indicate the numerical value in volts or amperes.



The “ampere” is the unit of current. The “volt” is the unit of electrical force that causes current to flow. Transistors use relatively little current and operate at relatively small voltages. The current flow in a small signal transistor, for example, may be and usually is in the order of millionths (micro) or thousandths (milli) of an ampere. The meters used to indicate current flow in such transistors are, therefore, milliammeters and microammeters. In this book we will use a popular range, the 0-1 milliammeter. Full-scale deviation of the pointer is caused by a current flow of 1 milliamperere. Numerically this is 0.001 amperes. Voltage meters, or voltmeters, are calibrated directly in volts. When a meter is intended to read DC volts or amperes it has polarity of plus and minus (+ and -). When meter polarity is important in a circuit, it is shown in the diagram as illustrated below.

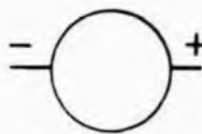

No. 26 WIRELESS CODE TRANSMITTER

The F.C.C. allows you to operate a radio transmitter with a power input and field of radiation below certain maximum limits. Too, the transmitter must not cause interference with other radio communications services. This project is designed to give you practical experience in several areas while conforming to all the requirements of the F.C.C.

This is a radio transmitter fitted with a code key. With it you can actually send Morse code across the room to an AM broadcast receiver with absolutely no interconnecting wires. An NPN type transistor is connected as a radio frequency oscillator. This makes it a signal generator which, when connected to a short antenna, becomes a small power transmitter.

The chassis is a $2\frac{1}{2}$ " x $3\frac{1}{4}$ " sheet of perforated vector board. Plywood, masonite, or plain pine that has been coated with shellac will do nicely, too. Slats of wood, $\frac{3}{4}$ " x $\frac{1}{2}$ " x $3\frac{1}{4}$ ", are nailed or glued to the underside of the baseboard to serve as feet. The key is made from a strip of tin cut from a juice can, cut and bolted at one end to give it a natural spring action. Below the free end of the strip of tin is a small bolt secured to the baseboard. It serves the purpose of the stationary contact for the key. When the "key" is pressed with a finger to tap out the code, the bat-

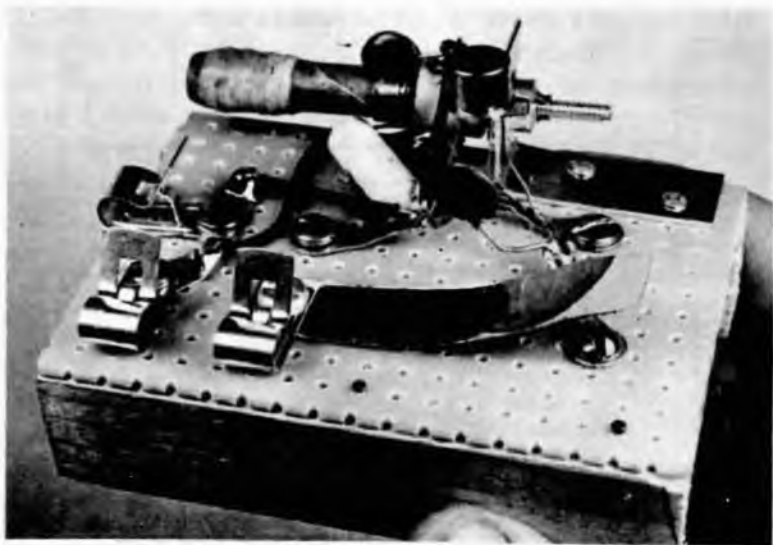

tery circuit is completed and the transmitter turns on.

Since the key actually operates as the battery switch, the transmitter is off when the key is not pressed down. The transistor draws current only when the switch-key is depressed, and a separate on-off switch is not needed.

The transmitter works very nicely with a single D cell. The antenna should not be longer than 10 feet. Such an antenna and a single cell give the transmitter a range of about 15 feet. Increasing the battery voltage to 3.0 volts will increase the range.

The ferrite antenna coil L has a threaded screw protruding from one end. This screw is attached to a molded cube of ferrite, powdered iron. Turning the threaded screw in or out slides the ferrite core along the inside diameter of the antenna coil. This changes the inductance of the coil and provides a convenient means for tuning the transmitter to a specific frequency within the AM broadcast band.

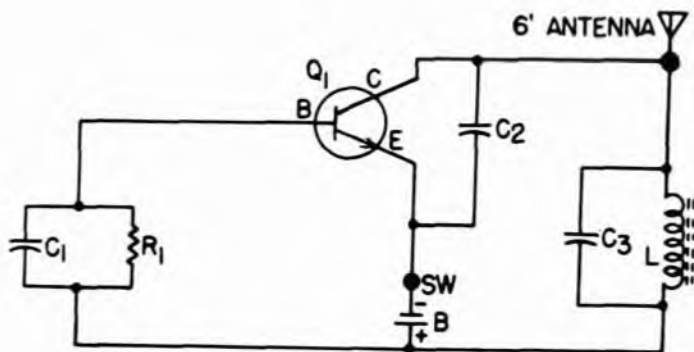

PARTS LIST

SYMBOL	DESCRIPTION	RADIO SHACK NO.
Q1	transistor, 2N357	27-1707
C1	capacitor, .01 mfd tubular	71-0402
C2	capacitor, 100 pf disc ceramic	71-5106
C3	capacitor, 50 pf disc ceramic	71-5101
R1	resistor, 100,000 ohms	70-0195
L	antenna coil	27-1430
SW	switch, keying (see text)	
B	battery supply, 1.5-3V "D" cell	23-466

Going "on the air" is easy. Turn on the AM broadcast band radio. Tune to the edge of a radio station at approximately 1,000 on the dial. The "edge" is indicated by an increase in the sharpness of the sound of the voice of the radio announcer. Connect the battery, observing correct polarity, and the antenna to the respective clips on the transmitter.

Hold the key down while slowly turning the antenna coil's threaded screw in and out, first all the way in one direction, then in the other. At some point you will hear a whistle-like tone in the radio. Prove it comes from your transmitter by operating the key. Now, adjust the antenna coil screw to give the tone that is loudest and that pleases you the most.

Moving the antenna wire may cause the tone to change pitch or to disappear. It is easily relocated by readjustment of the antenna coil screw.

Make certain you are not being picked up on a neighbor's radio that may be tuned to the same radio station. The correct name for the tone you hear is "beat note."

No. 27 LOUDSPEAKER-MICROPHONE

Perhaps it seems strange, but it is true that a small loudspeaker can also be used as a microphone. Take, for example, the loudspeaker of Project No. 4. Instead of connecting it to the output of an amplifier, we can connect it to the input. And, instead of hearing sounds from the loudspeaker, we put sound into it. The loudspeaker normally converts

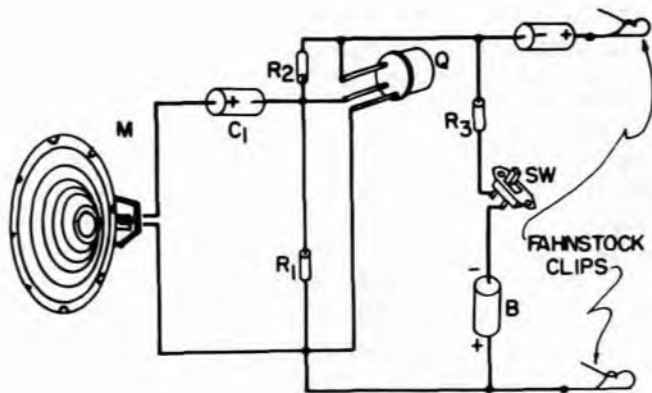

PARTS LIST

SYMBOL	DESCRIPTION	RADIO SHACK NO.
Q1	transistor, 2N107	27-1701
M	loudspeaker, 2½"	40-247
C1	capacitor, 50 mfd electrolytic	27-955
R1	resistor, 10,000 ohms	70-0195
R2	resistor, 150,000 ohms	70-0195
R3	resistor, 10,000 ohms	70-0195
SW	switch, s.p.s.t.	27-602
B	battery supply, 1.5-3V "D" cell	23-466

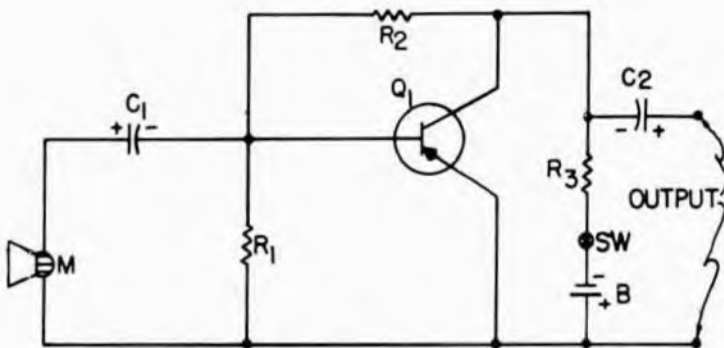

electrical energy into acoustic waves or sound, as when we connect it to the output of an amplifier. It can also be used in reverse, converting acoustic waves of sound into electrical energy when connected to the input of the amplifier shown here.

The transistor preamplifies the very tiny signals generated by the loudspeaker-microphone. The entire circuit is so small, batteries and all can be installed inside the loudspeaker cabinet. In fact, you can actually eliminate the baseboard chassis by cutting all wire leads of the components to ½" lengths and soldering them as shown in the circuit. Use the two terminals of the loudspeaker-microphone as the anchor points. Observe heat-sink precautions.

No. 28 MIKE PREAMPLIFIER

The loudspeaker-microphone is a low impedance device indicated by its resistance of 10 ohms. More conventional microphones are high-impedance, measuring as high as 500,000 ohms. These are designed to perform specifically as microphones which can be connected directly into an amplifier without special intermediate circuits. Such high impedance microphones are the popular variable reluctance, crystal, and ceramic types used with most home and semi-professional tape recorders and small public address systems.

The electrical signal voltages from high impedance microphones are much greater than those from the loudspeaker-microphone. However, they are still too small to be useful without amplification. This preamplifier circuit is quite simple and provides valuable experience with such circuits. So few parts are used, it is conceivable to mount them within the microphone case.

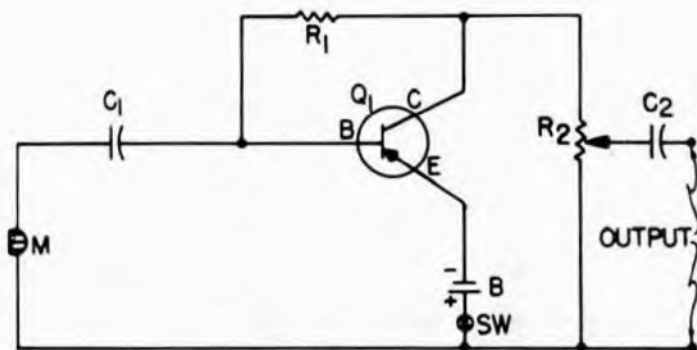

PARTS LIST

SYMBOL	DESCRIPTION	RADIO SHACK NO.
Q1	transistor, 2N107	27-1701
M	microphone, high-impedance crystal	33-100
C1, C2	capacitor, .47 mfd tubular	71-0414
R1	resistor, 270,000 ohms	70-0195
R2	potentiometer, 10,000 ohms	27-1715
SW	switch, s.p.s.t.	27-602
B	battery supply, 1.5 to 3 volt "D" cells	23-466

The addition of a potentiometer in the transistor collector circuit enables the talker to control the volume of the signals from the microphone. The transistor draws extremely little current; therefore, it is practical to use the small hearing-aid type mercury cells and to install them inside the microphone. This type of assembly is neat and compact, and the mercury cells add considerably to the effective sensitivity of the microphone.

No. 29 ALL-TRANSISTOR INTERCOM

This is an exceptionally useful project. It can be used in the home to interconnect the baby's room with other parts of the house for electronic babysitting, for example. Or, use it for two-way communications between the office and the shop in a place of business. Calls can be originated by either location in the two-station arrangement shown.

The intercom uses three transistors to provide high sensitivity and plenty of loudspeaker volume. This project is a practical example of how loudspeakers can also be used as microphones.

To make a call from either station, just push the switch. The calling station connects to the input of the intercom, making its loudspeaker perform as a microphone for the "call." Releasing the switch connects the loudspeaker to the output of the amplifier for listening. The battery at the remote station (B2) supplies power while the push-to-talk switch SW2 is operated.

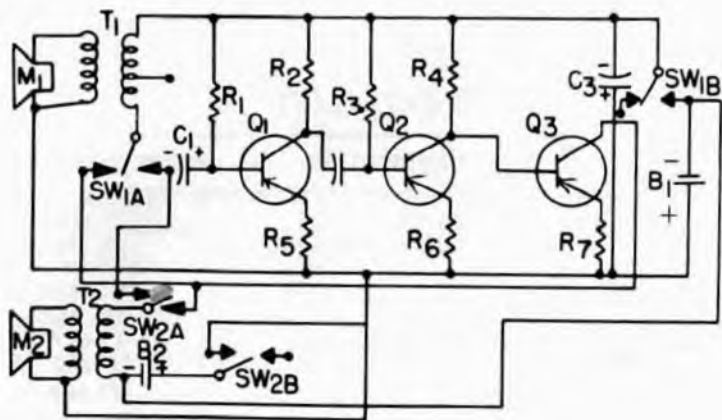

PARTS LIST

SYMBOL	DESCRIPTION	RADIO SHACK NO.
Q1, Q2	transistor, 2N107	27-1701
Q3	transistor, 2N270	27-1702
M1, M2	loudspeakers, 10 ohms, 2½"	40-247
T1, T2	transformers, AF output —500 ohm CT primary —3.2 ohm secondary	27-1379
C1, C2	capacitor, 10 mfd electrolytic	27-953
C3	capacitor, 30.mfd electrolytic	27-954
R1, R3	resistors, 470,000 ohms	70-0195
R2, R4	resistors, 4,700 ohms	70-0195
R5-R7	resistors, 150 ohms	70-0195
SW1, SW2	switches, d.p.d.t. spring-return	78-2408
B1, B2	battery supplies, 9 volts ea.	23-464

No. 30 RAIN ALARM

Electronics to the rescue, eliminating the surprise that can come from looking out of the window to discover it is raining. The alarm circuit operation is based on the fact that rain water contains impurities picked up during its flight through the air. These impurities are measurable as electrical resistance. This means the rain drops have some electrical conductivity; current will flow through them. Relatively speaking, the conductivity is not at all high.



However, if we can amplify the tiny current flow, we can use it to actuate the buzzer.

Transistors make excellent amplifiers for small currents, and that is the function performed by Q1 and Q2, the NPN transistors in the above circuit.

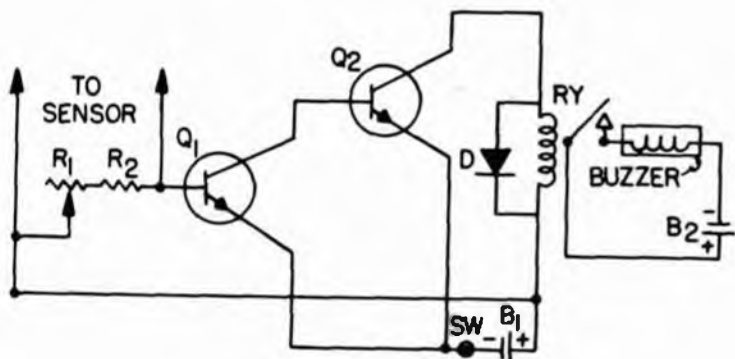

PARTS LIST

SYMBOL	DESCRIPTION	RADIO SHACK NO.
Q1, Q2	transistors, 2N1010	27-1703
R1	potentiometer, 1,000,000 ohms	27-211
R2	resistor, 470,000 ohms	70-0195
RY	relay, 5,000 ohm coil	27-1712
D	diode, 1N34A	27-1709
SW	switch, s.p.s.t.	27-802
B1	15 volts	23-509
B2	3 volts, 2 "D" cells	23-466
	buzzer	20-1086
	sensor (see text)	

The most important element in the circuit is the "rain sensor." This is easily constructed in a matter of minutes. Use a block of wood or masonite, 3" x 5" across its top surface. Coat one surface with rubber cement and let it dry. Cut a piece of aluminum foil (kitchen type) to fit the 3" x 5" surface. Coat one side of the foil with rubber cement and allow it to dry. Position the foil carefully on the wood block so that the two cemented surfaces contact each other. Smooth the foil to make it lie flat. Now, cut a zig-zag strip 1/32" wide out of the center of the foil, in the long direction.

Use the continuity tester of Project No. 8 to make certain the strip has electrically separated the foil into two sections. Drive a thumb tack with a wire lead wrapped around it into each half of the foil "islands." These are the leads to the electronic circuit. R1 is the sensitivity control. Adjust it to the point where the alarm sounds, then back up slowly so that the alarm stops but is on the threshold of starting again. Place the sensor where it will catch the first rain fall. Turn on switch SW, and let the buzzer tell you when to put on your raincoat.

No. 31 COLOR COMPARATOR

Two solar cells can be used to compare the light reflected from one surface with that from another. For example, if you have a color swatch and want to make sure that another sample is identical, or if you want to balance the light reflected from differently colored or textured surfaces, you can do it with this electronic circuit.

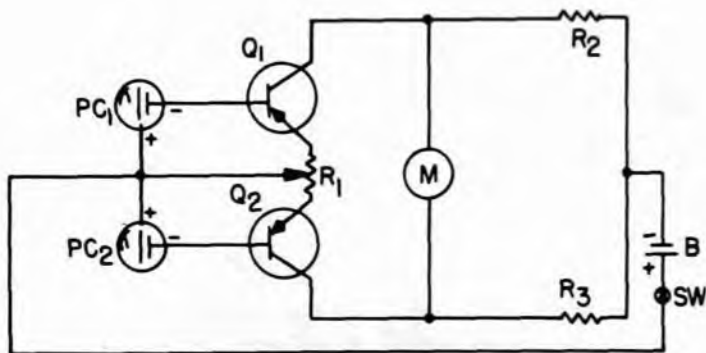

PARTS LIST

SYMBOL	DESCRIPTION	RADIO SHACK NO.
Q1, Q2	transistors, 2N524	27-1702
PC1, PC2	solar cells	27-1710
R1	potentiometer, 5,000 ohms	27-1714
R2, R3	resistors, 1,000 ohms	70-0195
M	meter, 0-1 milliampere	22-018
SW	switch, s.p.s.t.	27-602
B	battery supply, 9 volts	23-464

Start by balancing the solar cell circuits. Completely cover the sensitive surfaces of PC1 and PC2 so that they receive no light. Adjust R1 so that the meter "M" indicates zero current. Expose PC1 to the surface to be used as a reference. The meter will indicate current at this time. The switch to be checked is then exposed to PC2, taking care to duplicate the exposure conditions of PC1 as closely as possible. When the light reflections from the two exposed surfaces are identical, the meter will indicate zero current—the switch has been matched!

No. 32 CLEARANCE-LIGHT FLASHER

A clearance light such as is used to outline the perimeters of a truck gives illumination that can be seen at great distances. When it is made to flash, the "notice" it gives is considerable and commanding! An electronic switch provides a superbly dependable means for switching the light on and off repeatedly without making strong demands on the battery.

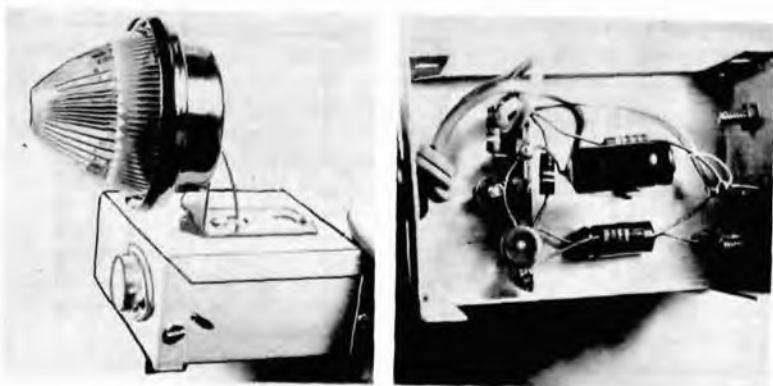

Because there are no moving parts to wear out, no pivoting joints or bearings that might corrode and stick when exposed to the weather, the electronic switch is exceptionally reliable in automobile and boat service.

Q2 is a power transistor. The lamp "L" is in the Q2 collector circuit. When the collector draws current the light goes on. Q1 is a small signal transistor. Both transistors are connected in a low frequency oscillator circuit called a "multivibrator." The frequency of operation is determined by the various capacitor and resistor values, with C1 and

C2 as the most significant determining elements. Decreasing the values of C1 and C2 increases the flashing rate which is about 2 for every 3 seconds with the values shown.

The entire flasher can be built without crowding into an aluminum box measuring only $2\frac{3}{4}$ " x $2\frac{1}{8}$ " x $1\frac{5}{8}$ ". Although many other chassis types will do, the aluminum box enhances the durability of the flasher by offering complete protection to the components.

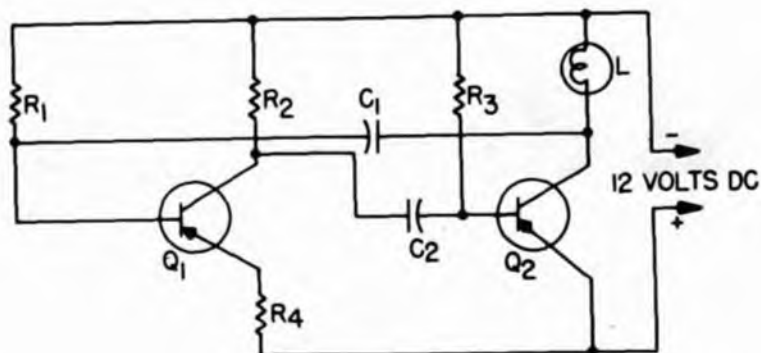

PARTS LIST

SYMBOL	DESCRIPTION	RADIO SHACK NO.
Q1	transistor, 2N217	27-1702
Q2	transistor, 2N540	27-1705
R1	resistor, 15,000 ohms	70-0195
R2, R3	resistors, 3,300 ohms	70-0195
R4	resistor, 100 ohms	70-0195
C1, C2	capacitors, 100 mfd electrolytic	27-963
L	12-volt automobile clearance light assembly	

The power transistor Q2 can be mounted directly to the aluminum box. This makes the box act as a "heat sink" for the transistor. Make certain the two rigid leads (base and emitter) of Q2 do not touch the aluminum box. Clearance holes should be large enough to assure the necessary space. The clearance light can be secured directly to the box. This automatically makes contact with the collector of Q2. The automobile 12-volt battery is an excellent source of power, as would be a 12-volt truck or marine battery, or 8 D-cells in series.

No. 33 SHORT WAVE CONVERTER

You can tune in on the world with this project connected to your car radio. You don't have to change your car radio in any way, or even take it out of the dashboard. This converter connects between the antenna and the radio.

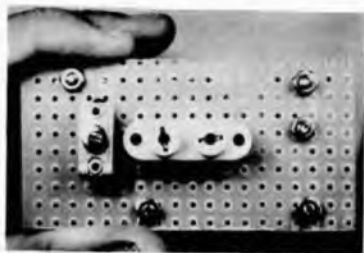

With the converter connected and using its own self-contained battery, instead of tuning AM broadcast stations across the dial you will hear transmissions from amateur radio stations, foreign broadcast stations, aircraft, and ships at sea. Simply by changing plug-in crystals, you can cover the frequency range of approximately 5500 kc to 9600 kc.

Note how simple the circuit is, now that you are becoming experienced in reading wiring diagrams. L1 is a coil that inductively connects the car antenna to L2. Trimmer C1

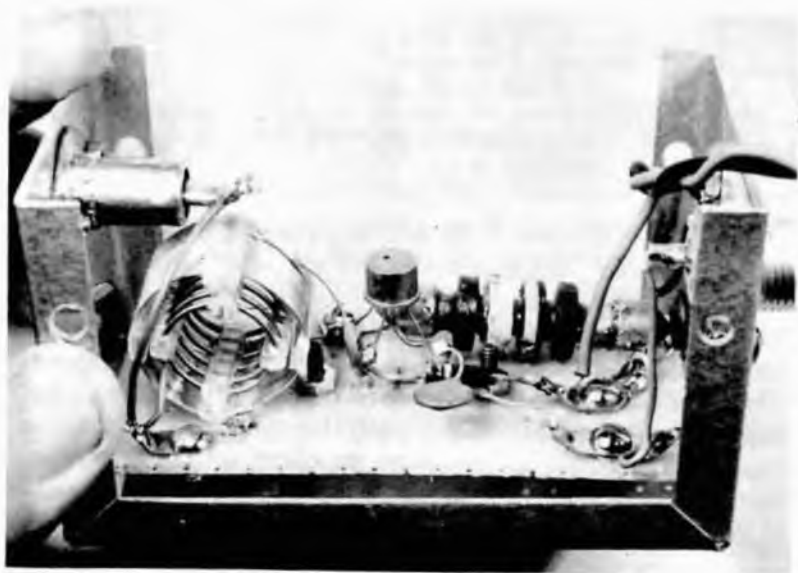

tunes L2 to give the strongest signals within the range of the converter. Q1, a PNP transistor, acts as a combination oscillator-mixer. The crystal determines the frequency of oscillation.

The incoming signal from the car antenna "beats" with the signal generated by the transistor circuit oscillations. This beating produces a signal that is the difference frequency between the incoming signal and the frequency of the crystal.

For example, if the crystal frequency is 7000 kc and the incoming signal is 8000 kc, the signal that appears in the collector circuit of the transistor is the difference between the two, or 1000 kc. Therefore, if we connect the output of the converter to the input of the car radio and tune the

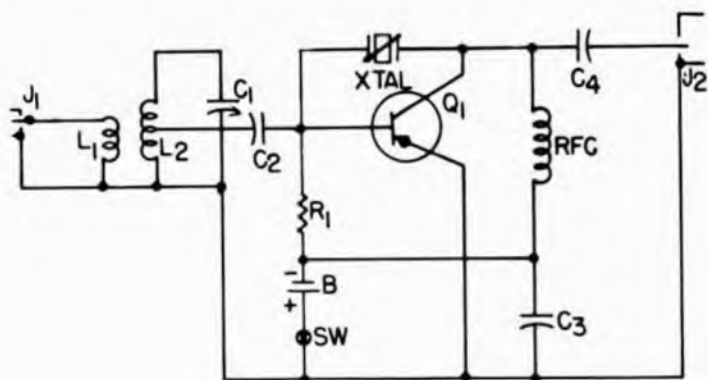

PARTS LIST

SYMBOL	DESCRIPTION	RADIO SHACK NO.
Q1	transistor, 2N247	27-1704
C1	capacitor, 100 pf trimmer	71-4035
C2	capacitor, 100 pf disc ceramic	71-5106
C3, C4	capacitors, .001 mfd disc ceramic	71-5123
R1	resistor, 390,000 ohms	70-0195
SW	switch, s.p.s.t.	27-602
J1	jack, antenna (auto radio)	75-0620
J2	coax connector (female), SO239	27-201
RFC	choke, 2.5 mh	27-1713
L1	9 turns of hookup wire wrapped around L2	
L2	22 turns of B&W miniductor #3016 (connect C2 to midpoint)	
B	battery supply, 4.2 to 4.5 volt "D" cells	23-466

radio to 1000 kc on the dial, we will hear the 8000 kc signal on the loudspeaker.

Because the input of the converter is broadly resonant, and doesn't tune sharply, if we tune to 550 kc on the car radio dial, we will hear signals coming in from the antenna that are at 7550 kc (the crystal frequency *plus* the radio dial setting). Thus, if we tune the car radio to 1550 kc, we will hearing incoming signals at 8550 kc.

With one crystal a bandwidth of approximately 1000 kc can be covered simply by tuning the car radio dial. So, if we change the crystal we change the band of frequencies covered by the converter in combination with the car radio.

The table shows the bands of frequencies covered by plugging in different crystals.

CRYSTAL FREQUENCY	CAR RADIO TUNING RANGE
4450 kc	5000-6050 kc
5500 kc	6050-7100 kc
6450 kc	7100-8050 kc
7500 kc	8050-9100 kc
8550 kc	9100-10150 kc

The entire unit can be enclosed in a 4" x 2 $\frac{1}{4}$ " x 2 $\frac{1}{4}$ " aluminum box. The electronic components mount on a 3 $\frac{1}{2}$ " x 1 $\frac{3}{4}$ " perforated board.

A hole is drilled in the top of the box to enable trimming C1 for maximum signals as heard on the loudspeaker.

The battery shown here is a 4.2-volt mercury cell that fits a pen-cell holder installed in the cover of the box with the on-off switch SW. However, you may wish to use less expensive 1.5-volt D-cells in series.

No. 34 CITIZENS BAND TRANSMITTER

Compact, efficient, and legal for communications with other Citizens band transmitters of the same type, you can put this one on the air in a jiffy.

A crystal-controlled oscillator circuit uses an inexpensive NPN transistor and a few other components. The complete

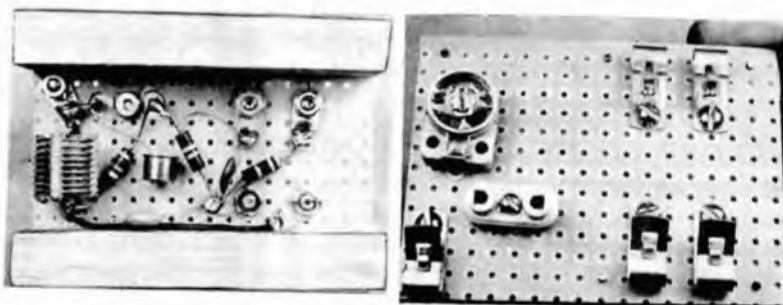

transmitter, microphone, batteries, and the antenna (no longer than 4') can all be enclosed in a single miniature plastic or metal box. A vector board, too, makes an excellent mounting base.

The microphone "M" is a conventional carbon type. R3 limits the current through the microphone and the transistor to protect them from excessive current flow. If the bat-

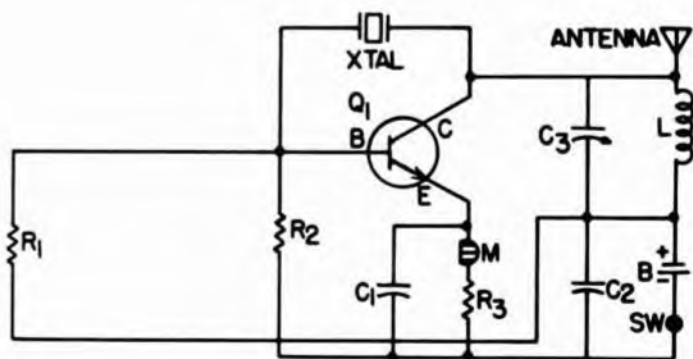

PARTS LIST

SYMBOL	DESCRIPTION	RADIO SHACK NO.
Q1	transistor, 2N1199	27-1707
R1	resistor, 47,000 ohms	70-0195
R2	resistor, 10,000 ohms	70-0195
R3	resistor, 330 ohms	70-0195
C1, C2	capacitor, .001 mfd disc ceramic	71-5123
C3	capacitor, 50 pf trimmer	71-4031
SW	switch, s.p.s.t.	27-602
M	microphone, carbon	27-1425
L	coil, 8 turns #16 wire 5/8" dia. core x 1"	
B	battery supply, 9 volts	23-464

tery voltage "B" is less than 9 volts, R3 may be eliminated and the microphone connected directly between the transistor's emitter and the negative terminal of the battery.

Make certain battery polarity is correct. With an NPN transistor, the + terminal of the battery is always nearest the collector.

The transmitter may be mounted on a perforated board, 2½" x 3½", with ¾" high wood slats to provide underside dimensions for the component installation area.

The crystal is the HC6U type, operating on its third overtone. (If the transmitter frequency is 27.255 mc, the crystal has a fundamental resonant frequency of one-third this value, or 9.085 mc.) C3 is a trimmer that tunes coil "L" with the antenna connected.

Use a spring-return single-pole, single-throw switch for "SW" and you will have professional push-to-talk operation. No other power switch is needed.

No. 35 TRANSISTORIZED VTVM

The term "VTVM" is actually made up of the initials for "Vacuum Tube Volt Meter," and was popularized in the vacuum-tube era. Today, of course, we can use transistors, and we do so in this circuit. The purpose of the instrument

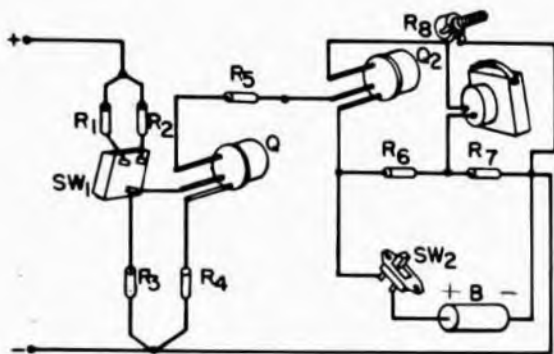

is to provide a means for measuring DC voltages in high impedance circuits without causing a change in electrical conditions, which is a problem when conventional voltmeters are used.

The instrument has two ranges: 1 volt and 10 volts. The input resistance on the lowest scale is 100,000 ohms. A conventional voltmeter might have an equivalent of 1,000 to 20,000 ohms.

Set range switch SW1 at the appropriate scale; turn on power switch SW2. Touch the test prods together and adjust R8 for zero meter current. Apply the prods to the circuit and read the voltage directly on the meter for the 1-volt range; multiply by 10 for the higher range.

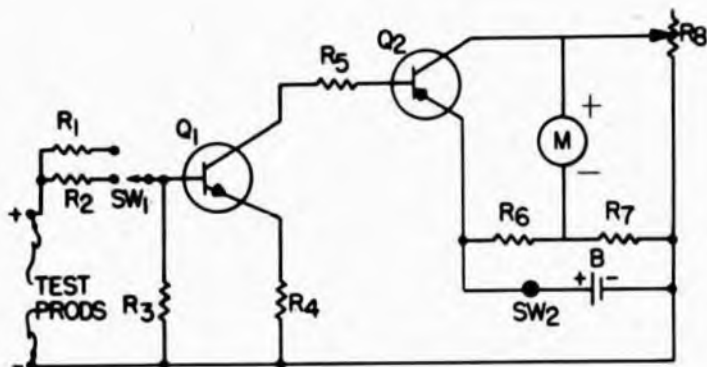

PARTS LIST

SYMBOL	DESCRIPTION	RADIO SHACK NO.
Q1	transistor	27-1707
Q2	transistor, 2N270	27-1702
R1	resistor, 1,000,000 ohms	70-0195
R2	resistor, 100,000 ohms	70-0195
R3	resistor, 10,000 ohms	70-0195
R4	resistor, 100 ohms	70-0195
R5	resistor, 1,000 ohms	70-0195
R6, R7	resistors, 470 ohms	70-0195
R8	potentiometer, 5,000 ohms	27-1714
M	meter, 0-1 milliampere	22-018
SW1	switch, s.p.d.t.	27-666
SW2	switch, s.p.s.t.	27-602
B	battery supply, 1.5 volts	23-466

No. 36 SIMPLE TACHOMETER

If you want to monitor the speed of a rotating disc such as a record turntable or the shaft of a motor, and you want the speed to be indicated on a meter rather than a strobo-

scope, this project is ideal for you. It consists of an inexpensive battery-type motor (such as used in driving small toy automobiles), a meter, and capacitor. No battery power is needed because the motor behaves like a voltage generator when its shaft is rotated. The voltage output of the motor increases with shaft speed.

The output voltage is DC, therefore it has polarity. Find the proper polarity by manually spinning the motor shaft with the meter connected to the two terminals of the motor. If the meter reads backwards, reverse the meter connections.

Capacitor C smooths out meter fluctuations to make the indications stable. Place a small rubber puck made from a pencil eraser on the motor shaft and position the shaft so that it is rotated by pressure against the turntable or motor shaft.

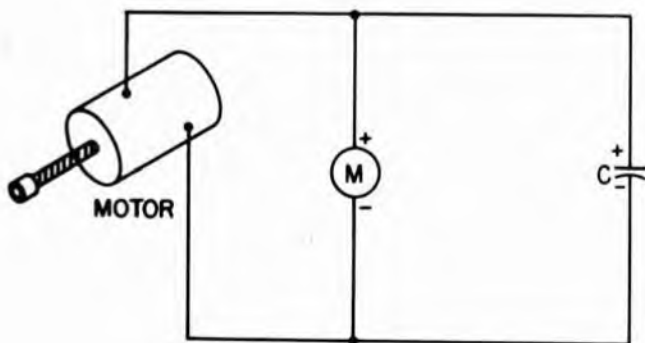

PARTS LIST

SYMBOL	DESCRIPTION	RADIO SHACK NO.
M	meter, 0-1 milliampere	22-018
C	capacitor, 100 mfd electrolytic	27-963
	motor (see text)	27-1550

No. **37**

TELEPHONE PICK-UP

A group of people can all listen to a single telephone conversation at the same time with this project. A telephone pickup coil (there are several types made and any one of

them may be used) is connected to the input of this very sensitive 3-transistor amplifier. The output of the amplifier is connected to a 2½" loudspeaker capable of delivering room-filling sound.

Transistor Q1 is a small high-gain preamplifier operated so as to step up the low currents induced into the telephone pickup. Q1 is connected to a volume control through a capacitor. The control sets the level of the signal fed to Q1. The output of Q1 drives Q2 and Q3 which are transformer coupled to the loudspeaker. It is possible to omit transformer T from the circuit and connect the terminals of the speaker between the battery and the collectors of Q2 and Q3. However, some loss in volume will be noted.

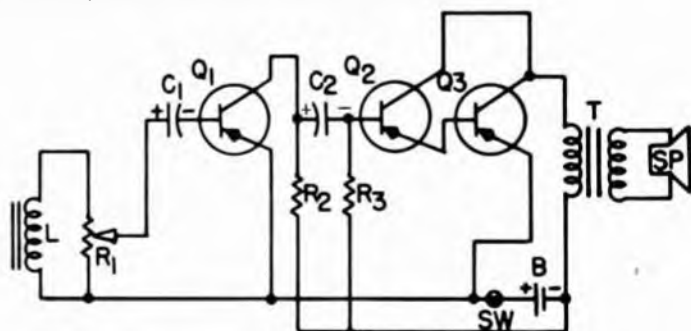

PARTS LIST

SYMBOL	DESCRIPTION	RADIO SHACK NO.
Q1, Q2	transistors, 2N107	27-1701
Q3	transistor, 2N270	27-1702
R1	potentiometer, 50,000 ohms	27-1716
R2	resistor, 10,000 ohms	70-0195
R3	resistor, 220,000 ohms	70-0195
T	transformer, AF output —500 ohm CT primary —3.2 ohm secondary	27-1379
SP	loudspeaker, 2½"	40-247
SW	switch, s.p.s.t.	27-602
C1, C2	capacitors, 10 mfd electrolytic	27-953
L	magnetic telephone pickup	44-533
B	battery supply, 9 volts	23-464

No. 38 DIRECTIONAL MICROPHONE

Because radar antennas are shaped like "dishes," this is what they are often called. The fact of the matter is, the

dish portion of a radar antenna is actually a parabolic reflector, designed to send and receive "beam-like" signals. In this project, we use an actual dish, right out of the kitchen, because it is shaped like a radar antenna.

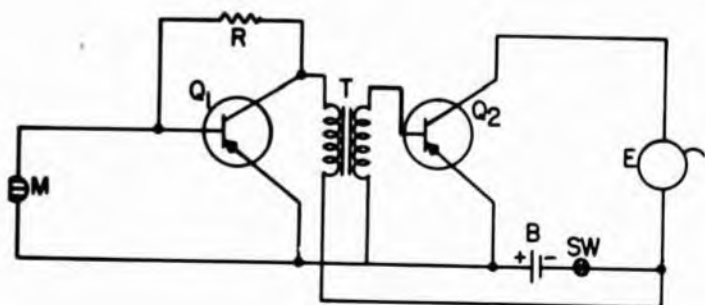
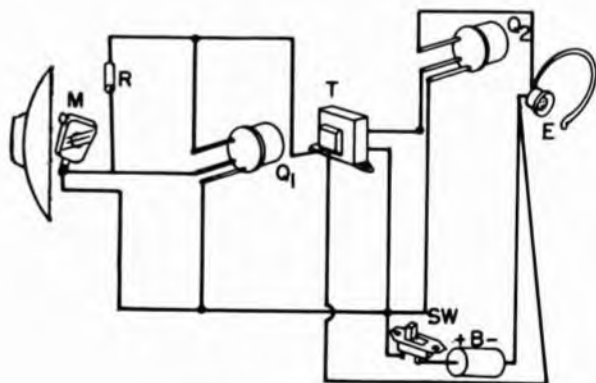

PARTS LIST

SYMBOL	DESCRIPTION	RADIO SHACK NO.
Q1, Q2	transistors, 2N107	27-1701
M	microphone, carbon	27-1425
R	resistor, 47,000 ohms	70-0195
T	transformer, AF — 10,000 ohm primary — 2,000 ohm secondary	27-1378
E	earphone, 2,000 ohm magnetic	33-180
SW	switch, s.p.s.t.	27-602
B	battery supply, 1.5 volts	23-466

The principle is something like the focused reflector of a spotlight. Point the dish at an object and the focus works in reverse. If you mount a microphone so that it is suspended in front of and pointed directly at the center of the dish, it picks up sounds reflected from the inside of the dish.

The dish can be a large wooden or hard plastic salad bowl, shallow, and at least 12 inches in diameter. The electronic circuit uses two PNP transistors connected by an interstage transformer. Amplification is quite high. Two of these units permit excellent two-way voice communications over several hundreds of yards without any necessity for shouting.

No. 39 STEREO BALANCER

In order to make certain your stereo amplifier will give optimum performance in the reproduction of your stereo records and stereo-FM tuner, it is important that the output levels of the two amplifier channels be equal. There are often differences in the sensitivity of the two channels of a stereo cartridge and of an FM tuner. Too, there are differences in the overall amplification of individual channels in the preamplifier stages. The fact that the volume control knobs are set at the same dial numbers for both channels doesn't necessarily mean they produce the same output

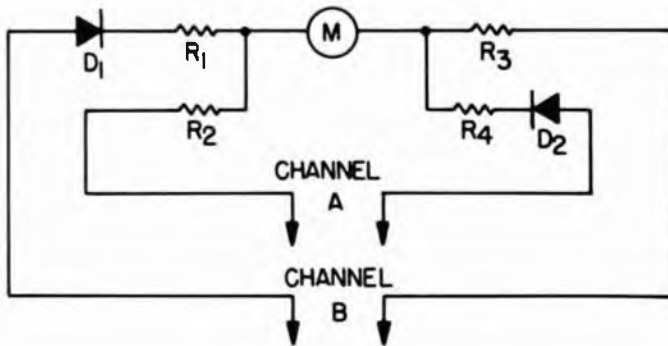

PARTS LIST

SYMBOL	DESCRIPTION	RADIO SHACK NO.
D1, D2	diodes, 1N34A	27-1709
R1-R4	resistors, 330 ohms	70-0195
M	meter, 0-1 milliampere	22-018

power at the loudspeaker terminals. This circuit enables you to electrically balance the signals at the amplifier's output.

Connect leads "A" across the speaker terminals of one stereo channel and leads "B" across the speaker terminals of the other channel. Play a single tone stereo test record through the system and adjust the stereo amplifier "Balance" controls. When the signals are equal and balanced, the meter will read zero current.

No. 40 STEREO PHASOR

Now that you have balanced the electrical power of your high-fidelity system, it becomes important that you also balance for differences in loudspeakers. When more than one loudspeaker is used in the same room and is fed by the same audio amplifier, the loudspeakers must be so connected that their sounds do not tend to cancel each other.

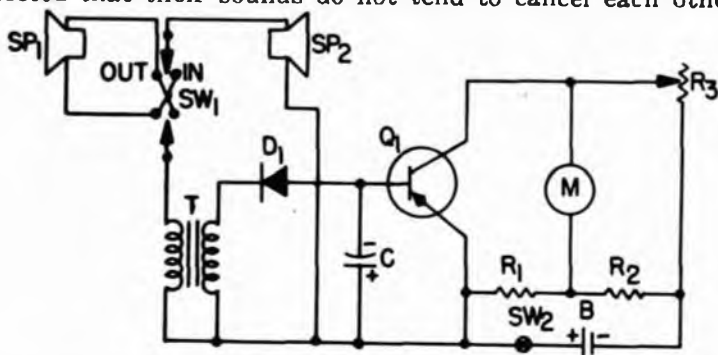

PARTS LIST

SYMBOL	DESCRIPTION	RADIO SHACK NO.
Q1	transistor, 2N109	27-1702
D1	diode, 1N34A	27-1709
SP1, SP2	loudspeakers, 2½"	40-247
SW1	switch, d.p.d.t. (phase)	27-666
SW2	switch, s.p.s.t. (on-off)	27-602
T	transformer, AF output —500 ohm CT primary —3.2 ohm secondary	27-1379
C	capacitor, 10 mfd electrolytic	27-953
R1, R2	resistors, 470 ohms	70-0195
R3	potentiometer, 5,000 ohms	27-1714
M	meter, 0-1 milliampere	22-018
B	battery supply, 9 volts	23-464

This is called phasing and is important to monophonic as well as stereo systems.

Two 2½" loudspeakers are used as microphones. Each is placed approximately 6 inches from the front of the high-fidelity loudspeakers being checked. Play a steady tone through the system and note the meter reading. Then move switch SW1 from one position to the other. If the meter reading increases when the switch is in the "OUT" position, the speakers are out of phase. The wires to only one of the high-fidelity loudspeakers should be transposed. If the meter reading decreases, all connections are correct.

No. 41 APPLIANCE TESTER

A handy gadget around the house is one that enables faulty fuses to be located quickly, and electrical outlets, lamps, toasters, electric irons, etc., to be checked. This calls for a combination AC voltmeter and ohmmeter.

Prods are connected to the "Common" terminal and to the "AC Volts" or "Resistance" terminal, depending upon the

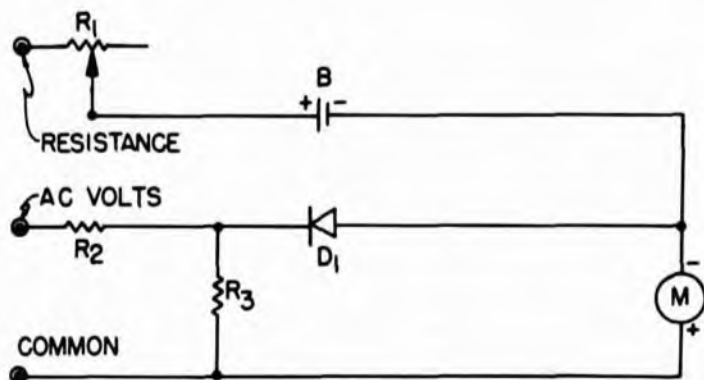

PARTS LIST

SYMBOL	DESCRIPTION	RADIO SHACK NO.
D	diode, 1N34A	27-1709
R1	potentiometer, 5,000 ohms	27-1714
R2	resistor, 100,000 ohms	70-0195
R3	resistor, 2,200 ohms	70-0195
M	meter, 0-1 milliampere	22-018
B	battery supply, 1.5 volts	23-466

function to be performed. On AC Volts, R2 and R3 serve as a voltage divider to protect the meter. D1 rectifies the AC so it may be indicated on meter M, which is a DC instrument. Full scale indication is about 150 volts. To use the ohmmeter, touch the two test prods together and adjust R1 for full-scale deflection of the meter. As the resistance between the two prods is increased, the meter reading decreases. At the mid-scale of the meter, resistance at the test prods is about 1,800 ohms. Typical appliance resistances are 10 to 20 ohms.

No. 42 ELECTRONIC STETHOSCOPE

Want to track down a noise problem in a machine? Want to locate a defective bearing in a motor? Or, do you want to be able to monitor a mechanical sound while you make adjustments? This stethoscope is exactly what you need.

The pickup is a crystal-type phono cartridge such as is used in an inexpensive record player. This type is durable, has high output, and is inexpensive. Use the type that has a knurled knob at the front end to hold phono needles in place. Instead of a phono needle, insert a 3" length of stiff wire and tighten the screw. Place the tip of the wire in contact with the machine being checked. Switch on the battery power and the noise will be heard loud and clear in the ear-

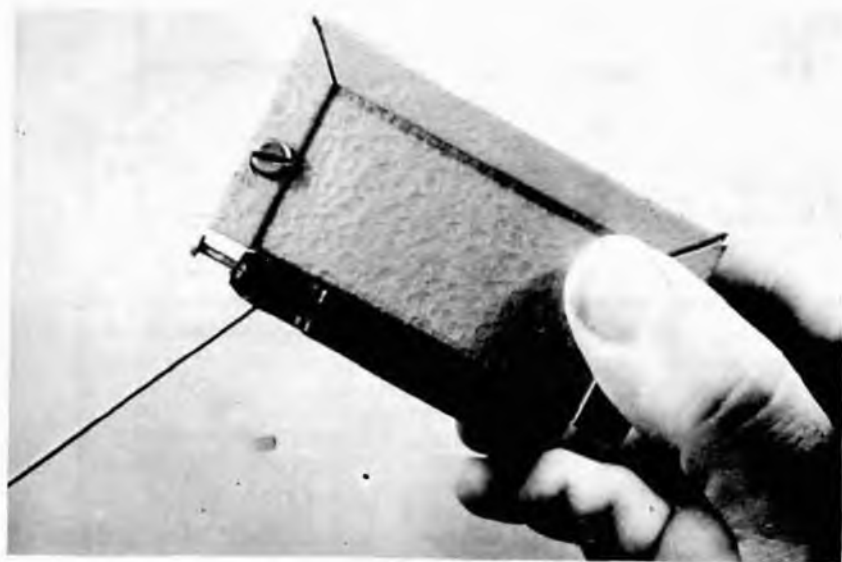

phone. The tip of the wire allows you to pinpoint the trouble right down to the exact bearing. The crystal cartridge can be secured to a stick or bolted to the box that holds the amplifier to make it a one-piece construction.

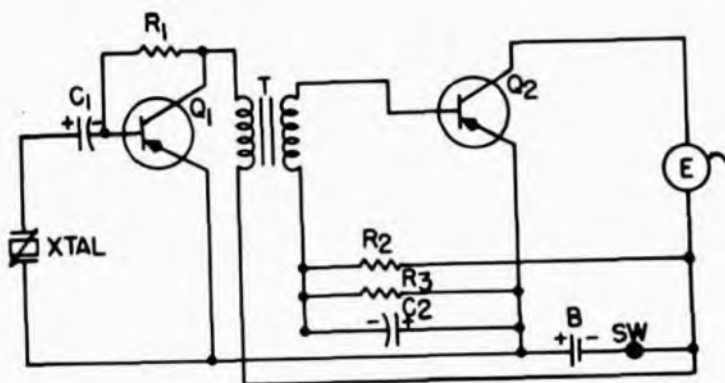

PARTS LIST

SYMBOL	DESCRIPTION	RADIO SHACK NO.
Q1, Q2	transistors, 2N107	27-1701
C1	capacitor, 5 mfd electrolytic	27-952
C2	capacitor, 10 mfd electrolytic	27-953
R1	resistor, 220,000 ohms	70-0195
R2	resistor, 150,000 ohms	70-0195
R3	resistor, 10,000 ohms	70-0195
XTAL	phono cartridge, crystal	42-005
T	transformer, AF — 2,000 ohm primary — 10,000 ohm secondary	27-1378
E	earphone, 2,000 ohms	33-180
SW	switch, s.p.s.t.	27-602
B	battery supply, 1.5 volts	23-466

No. 43 AUDIO MIXER

When you want to pick up and record the sound of a singer and his musical accompanist, it can be very difficult to get a good balance between voice and instrument with a single microphone. The optimum position for the single microphone that results in a clean, usable recorded sound is almost impossible to find. If you place the microphone to favor one, the other suffers. However, separate microphones that can be balanced electronically will solve the problems.

The microphones connect to J1 and J2, which are phono input jacks. R1 and R2 are potentiometers for individually balancing the outputs from the two microphones. The transistor amplifies the signals so they can be fed into a tape recorder. If the output of the transistor is too high, use a lower battery voltage. Often 1.5 volts is adequate battery power.

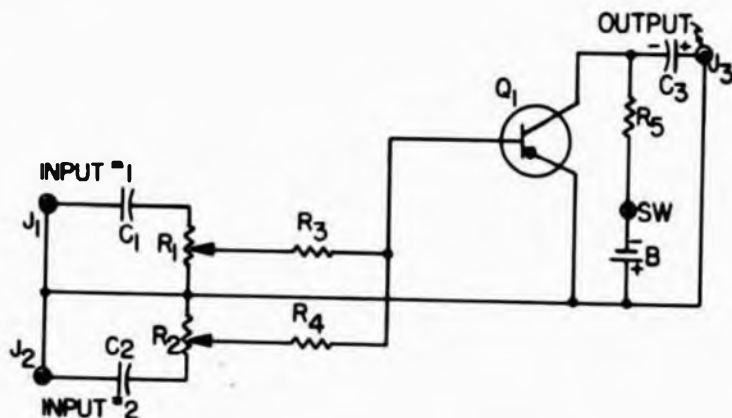

PARTS LIST

SYMBOL	DESCRIPTION	RADIO SHACK NO.
Q1	transistor, 2N107	27-1701
C1, C2	capacitors, .05 mfd tubular	71-0407
C3	capacitor, 5 mfd electrolytic	27-952
R1, R2	potentiometers, 1,000,000 ohms	27-211
R3, R4	resistors, 100,000 ohms	70-0195
R5	resistor, 15,000 ohms	70-0195
J1-J2	phono jacks	75-0966
SW	switch, s.p.s.t.	27-602
B	battery supply, 9 volts	23-464

No. 44 APPLAUSE METER

Amateur night performers are traditionally judged by the amount of applause, whistling, and cheering they get from the audience. Sometimes it is hard to tell who really got the most applause, the noise levels from the audience are so close together in apparent intensity. Electronics, such as given in this project, eliminates all doubt. A meter swings upward with the sound from the audience. The more the applause, the greater is the swing of the meter.

SP is a 2½" loudspeaker used as a microphone. It is connected through transformer T to the first transistor. R1 is a sensitive control to prevent unusually loud applause or shouting in a small room from driving the meter needle off scale. (This is called "pinning the needle.") The three transistors provide high amplification of the sound energy picked up by the loudspeaker-microphone. The output of the amplifier appears as a voltage at the junctions of D1-D2 and D3-D4. These four diodes are connected in a full-wave bridge rectifier circuit to assure maximum sensitivity of the applause meter. The diodes rectify the signal output voltage of the amplifier and feed it to the meter as a direct current that varies in accordance with the loudness of the applause.

When there is no applause, the meter is at rest. The meter

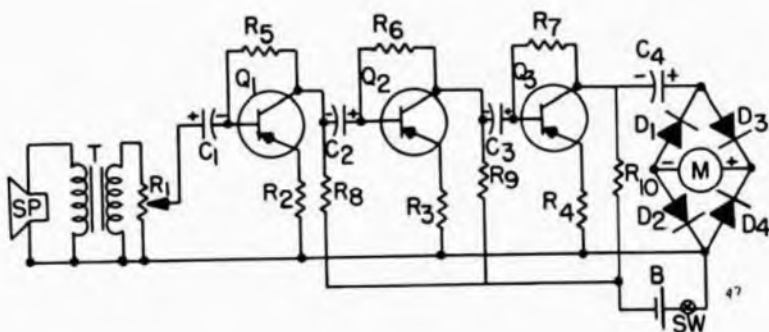

PARTS LIST

SYMBOL	DESCRIPTION	RADIO SHACK NO.
Q1-Q3	transistors, 2N109	27-1702
R1	potentiometer, 5,000 ohms	27-1714
R2-R4	resistors, 100 ohms	70-0195
R5-R7	resistors, 150,000 ohms	70-0195
R8-R10	resistors, 2,200 ohms	70-0195
C1-C4	capacitors, 10 mfd electrolytic	27-953
D1-D4	diodes, 1N34A	27-1709
SP	loudspeaker, 2½"	40-247
T	transformer, AF output —500 ohm CT primary —3.2 ohm secondary	27-1379
M	meter, 0-1 milliampere	22-018
SW	switch, s.p.s.t.	27-602
B	battery supply, 9 volts	23-464

is actuated only by the sound picked up by the microphone and converted to electrical signals. The microphone should be positioned so that it points directly at the center of the audience. It can be built into the same box as the meter and the transistor-amplifier.

Once the sensitivity control R1 has been set for a performer, it must not be touched until all performances have been judged. Adjustment of the sensitivity control will affect the swing of the meter.

No. 45 S-METER

"You're coming in loud" is a comparative term for the reception of radio signals. Only the person who makes the statement knows what it means. And, sometimes he is not sure himself just exactly what he means.

To overcome this extremely loose method of reporting

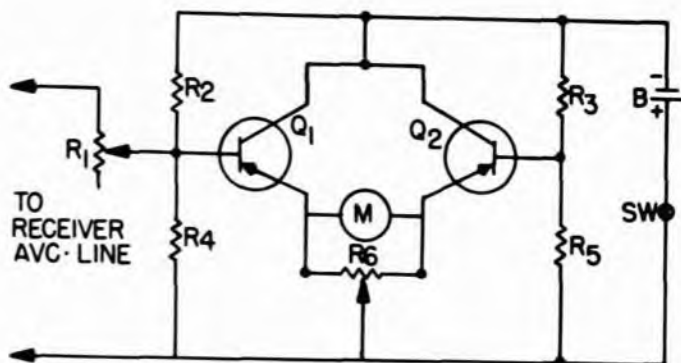

PARTS LIST

SYMBOL	DESCRIPTION	RADIO SHACK NO.
Q1, Q2	transistors, 2N109	27-1702
R1	potentiometer, 10,000 ohms	27-1715
R2, R3	resistors, 270,000 ohms	70-0195
R4, R5	resistors, 10,000 ohms	70-0195
R6	potentiometer, 5,000 ohms	27-1714
SW	switch, s.p.s.t.	27-602
M	meter, 0-1 milliampere	22-018
B	battery supply, 9 volts	23-464

signal strength, the "S" unit was invented and has been accepted internationally. In radiotelephone communications, "S" reports are given as numbers, from 1 to 9, with "9" representing the strongest signal. In order to be dependable and consistent, an S-meter should be connected to indicate only when a signal is received. The meter swings upward in accordance with the strength of the transmitted carrier. This may not actually indicate how loud the signal is, but it does indicate how well a signal is coming in at the receiver, or how effectively the background is being overcome by the received signal.

The circuit is similar to the transistorized VTVM of Project No. 35. This is a practical application for just such a circuit, where it is essential that the meter does not upset normal circuit operation.

Connect the input of the S-meter circuit to the AVC line of the receiver. This will have to be located separately for the individual receiver. Temporarily short the antenna and ground terminals at the receiver. Turn up the RF-GAIN control of the receiver, if it has one. Adjust R4 for zero meter current. You have now compensated for inherent noise in the receiver. Any deflection of the meter will be caused by an incoming signal, whether it be noise or a real signal.

With a strong signal being received, one you would estimate to be as strong as you usually hear, adjust R1 for a reading of .9 on the meter. Now, any signal strong enough to swing the needle to .9 is given a verbal "S-9" signal strength report.

No. 46

BFO

All communications receivers such as those intended for amateur or commercial 2-way radio-telegraph have BFO's built into them. A "BFO" is a Beat Frequency Oscillator. We first used one in Project No. 26, the Wireless Code Transmitter, and then again in Project No. 33, the Short Wave Converter.

First, let's understand when and why a BFO is needed. In the radio transmission of international code signals, it is common practice to "key the carrier." This means interrupting the radio-frequency energy radiated by the trans-

mitter, starting and stopping it in a pattern of dits and dahs to spell out words. This is what we did in Project No. 26; each time you pressed the key, the transmitter turned on, and turned off each time you released the key.

“Keying the carrier” does not transmit a tone signal. If the transmitter and receiver are tuned to a clear spot on the radio dial, a clear channel, the only sound that would be heard—without a BFO—would be a soft rushing noise generated by the receiver and its antenna as they are excited by the transmitted energy. There would be no musical tone with which we always associate Morse code. Something has to be added at the receiver to generate a musical tone, one that becomes audible only when the transmitter’s key is pressed. This is the job of the BFO. It enables us to hear the dits and dahs as the transmitter key is manipulated.

The BFO circuit is that of a single transistor connected as an oscillator. “L” is a transistor type IF transformer such

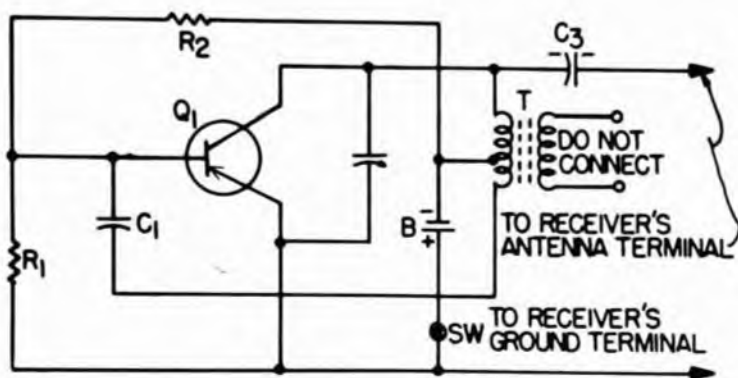

PARTS LIST

SYMBOL	DESCRIPTION	RADIO SHACK NO.
Q1	transistor, 2N544	27-1704
R1	resistor, 4,700 ohms	70-0195
R2	resistor, 10,000 ohms	70-0195
C1	capacitor, .01 mfd tubular	71-0402
C2	capacitor, 15 pf trimmer	71-4031
C3	capacitor, .001 mfd disc ceramic	71-5123
T	transformer, IF	27-1711
SW	switch, s.p.s.t.	27-602
B	battery supply, 1.5 volts	23-466

as is used in superheterodyne radio circuits. Only the primary connections of the transformer are used. The secondary is left unconnected. The output of the BFO connects from C8 to the receiver antenna terminal. The BFO should be connected as closely as possible to the antenna and ground terminals of the receiver.

The BFO can be enclosed within the receiver or built as what is called an "outboard," left outside the receiver's cabinet. The unit is small enough to be included inside the receiver cabinet, safely out of the way. Should this be done, place it where it will not be exposed to high heat.

A BFO is actually a small transmitter. It generates a small amount of radio frequency energy, but enough to be used because it is connected directly to the receiver. The BFO's frequency is tunable over a small range so that we can adjust the received signal tone that is best suited to our own ears. The BFO's frequency must be close to what is called the IF (intermediate frequency) of the receiver.

The overwhelming majority of short-wave communications receivers use 455 kc as the IF. If we mix a 456 kc signal with the IF circuit of the receiver, it is possible to hear the difference between the two frequencies, a 1000 cycle (1 kc) note when the signal from a short wave transmitter is being received. Thus, by varying the frequency of the BFO signal, we can vary the musical tone over the entire audible range. C2 provides the means for varying the frequency of the BFO.

No. **47** **BIG-VOICE MEGAPHONE**

Sheer simplicity of this circuit makes experimenters want to build this interesting and useful project. You don't have to own a boat to enjoy it, although it may be especially valuable as an electronic megaphone aboard small boats.

Transistors Q1 and Q2 are diamond shaped power transistors with which you have already gained some experience. They are connected in parallel to provide increased power capabilities in this application.

A carbon microphone converts the sound waves of the user's voice into varying resistance. This changes the current flow through R1 and R2, resulting in a change in base



currents of the two transistors. This change in base voltage follows the voice variations, and becomes a change in base current which is amplified by transistor action. The loudspeaker converts the amplified changes in current back into a reproduction of the user's voice—but louder!

The value of R2 must be found by experiment. Start with R2 as a 5,000 ohm potentiometer instead of a fixed resistor. Talk into the microphone and adjust R2 for the loudest and clearest loudspeaker sound. If you have a calibrated ohmmeter, measure the resistance of the potentiometer that is in the circuit and replace it with a fixed resistor.

Because of the loudness of the sound and the high sensitivity of the microphone, it is wise to separate the housings

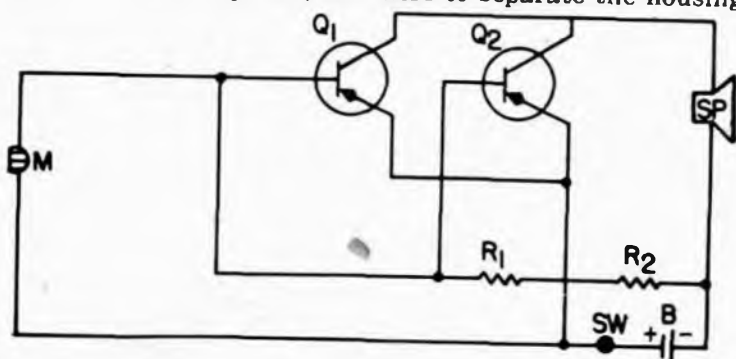

PARTS LIST

SYMBOL	DESCRIPTION	RADIO SHACK NO.
Q1, Q2	transistors, 2N301	27-1705
R1	resistor, 330 ohms	70-0195
R2	resistor (see text)	
SP	loudspeaker, 2½"	40-247
M	microphone, carbon	27-1425
SW	switch, s.p.s.t. spring return	27-1385
B	battery supply, 12 volts, 8 "D" cells	23-466

for them. Too, if the microphone is to be used inside the cabin or at an enclosed steering station, you will want to mount the loudspeaker in a weather-protected housing on the deck or topside. Battery power should be 12 volts for maximum loudness. The unit can be operated at 6 volts with reduced volume. It should not be operated above 12 volts.

The small plastic box used to package some transistors makes an excellent enclosure for the components. Perforations should be drilled for the microphone, which can be attached with cement. A push-to-talk spring return switch is positioned conveniently for the operator's thumb. Battery and loudspeaker leads come out through the bottom of the box.

No. 48 SHORT-THE-CIRCUIT

This one is easy to build and exciting to play, but beware! It is tougher to beat than it might appear to be. The object is to toss coins onto a board on which are installed a large number of screws, and to do it so skillfully requires that a coin touch two adjacent screw heads, thereby sounding a "short circuit" buzzer and a win!

The "board" is a perforated pegboard, 8" x 8" and with $\frac{1}{8}$ " holes placed $\frac{1}{2}$ " apart. The pegboard is mounted on a base frame made of $\frac{3}{4}$ " x $\frac{1}{2}$ " wood strips. The strip at the back is 1" x 8" x $\frac{3}{4}$ " to provide a backstop for the tossed coins. Mounted in a pattern of your own invention are machine screws (6-32 x $\frac{3}{8}$ ") with metal washers beneath their heads. The screws and washers are inserted into the $\frac{1}{8}$ " holes in the pegboard and secured with a solder lug and a 6-32 nut.

Use hookup wire to connect the solder lugs together into two separate circuits. Bare wire may be used with extreme

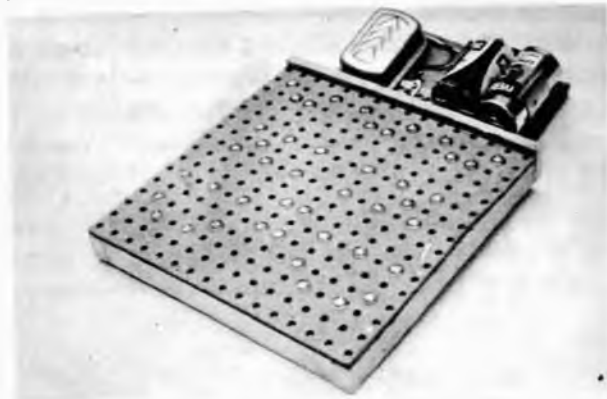

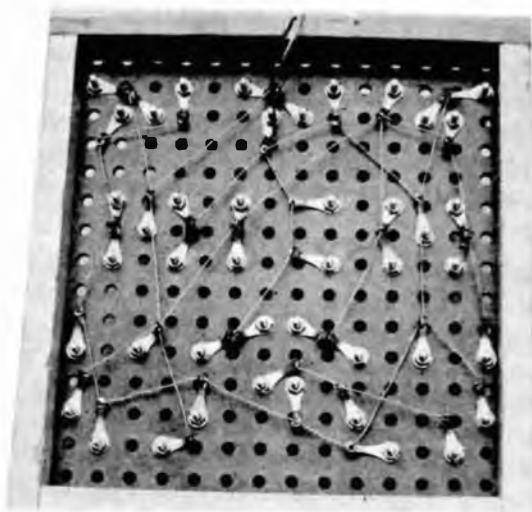

care taken to avoid unwanted short circuits. Plan the connections so that wherever possible adjacent screws are on different circuits. Connect two flexible wires, one from each circuit, to a "signal board" consisting of a 3-volt buzzer and two D-cells.

One wire from the buzzer is connected to a Fahnestock clip; one wire from the batteries to another Fahnestock clip. The two flexible wires from the pegboard connect to the clips. There is no polarity to the circuit so the wires may be

connected to any of the two clips without concern. Test the signal board by placing a coin across the two clips. The buzzer should sound. Remove the coin and place it across any two machine screw heads to test the board. The buzzer should sound.

Rules for the game can be devised to suit your own preferences or the whim of the group. Teams or any number of individual players can participate. Rules might include each player starting with 5 coins. Each player tosses. A coin that does not sound the buzzer or that bounces off the board, is considered lost. Players drop out as they lose their coins. When there is only one player remaining, he or his team wins.

CAUTION!!!

As you were told in the Introduction to this section, the next two projects are designed to be powered from a 110-volt AC source. Even though you may be an accomplished circuit builder, we nevertheless feel obliged to provide you with some precautionary notes.

PRECAUTIONS FOR WORKING ON ELECTRICAL EQUIPMENT

1. DO NOT work on equipment while it is connected to a power source, unless you have had proper instruction.
2. Be especially mindful of short circuits between wires, terminals, and solder joints. If a metal chassis is used, be especially careful of shorts which may connect the power source to the chassis. Even if a nonconductive material is used for a chassis, bolts or terminal connections on the underside may make contact with a metal surface. **DON'T ALLOW THIS TO HAPPEN!**
3. Learn one of the accepted methods for applying artificial respiration, and teach it to someone else who will be available when you are working with electrical equipment.
4. **ALWAYS BE SURE OF WHAT YOU ARE DOING.**
Common sense is the best conscience you have—**USE IT!**

Now, when you're ready, completion of one of the next two projects will earn you your Electronic Experimentor License.

No. 49 BATTERY ELIMINATOR

In experimental electronics, such as you engage in when building these projects, it is often inconvenient to use a battery as a power source. This is especially true when you want to observe the effects on a circuit's performance with different voltages. This project converts the 110-volt house current to the low direct current power you need.

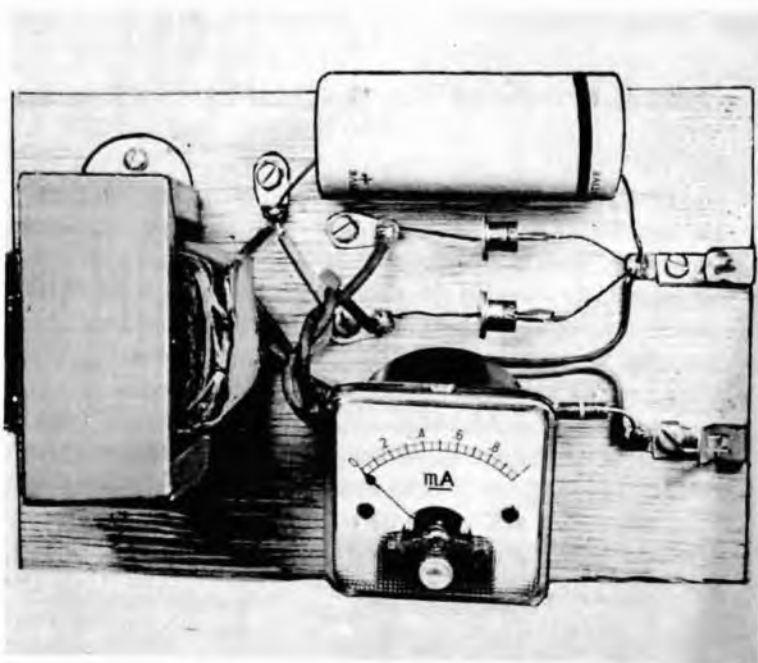
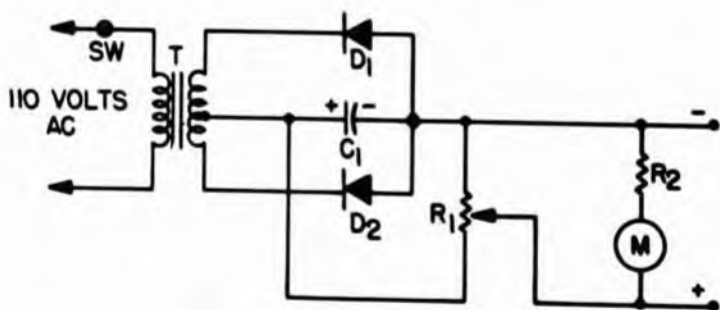

PARTS LIST

SYMBOL	DESCRIPTION	RADIO SHACK NO.
D1, D2	rectifiers, silicon power	27-1708
C1	capacitor, 1000-mfd electrolytic	27-1717
R1	potentiometer, 100-ohm, 2-watt	70-3214
R2	resistor, 10,000 ohms	70-0195
T	transformer, power (110 to 12.6 volts CT)	27-1505
M	meter, 0-1 milliampere	22-018
SW	switch, s.p.s.t.	27-602

Transformer T steps the AC house current down to approximately 12 volts AC. The lower voltage is rectified by the two silicon diode power rectifiers D1 and D2. They are connected in a full-wave rectifier circuit. "C" filters some of the hum out of the rectifier and tends to maintain the voltage at a fairly constant level. R1 is a 2-watt potentiometer that enables you to vary the voltage at the output terminals of the battery eliminator. Meter "M" reads the voltage value at the battery eliminator's output terminals. Multiply the meter scale by ten to read voltage directly from the meter.

No. 50 ACOUSTIC RECEIVER

This device can be used to turn garage lights on and off automatically for a preset period.

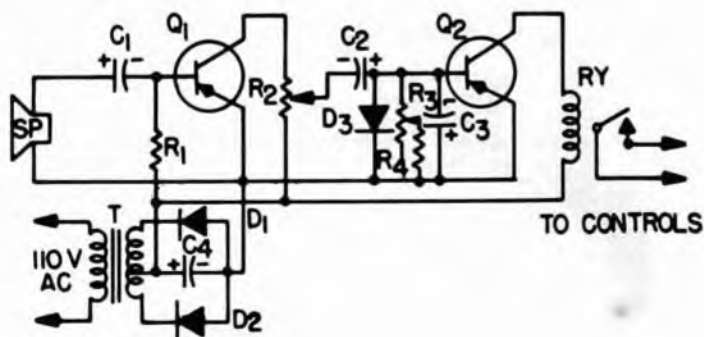

PARTS LIST

SYMBOL	DESCRIPTION	RADIO SHACK NO.
Q1, Q2	transistors, 2N109	27-1702
D1-D3	diodes, 1N34A	27-1709
C1	capacitor, 50 mfd electrolytic	27-955
C2	capacitor, 10 mfd electrolytic	27-953
C3, C4	capacitors, 1,000 mfd electrolytic	27-1717
R1	resistor, 470,000 ohms	70-0195
R2	potentiometer, 10,000 ohms	27-1715
R3	resistor, 10,000 ohms	70-0195
R4	potentiometer, 50,000 ohms	27-1716
SP	loudspeaker, 2½"	40-247
T	transformer, power (110 to 12.6 volts CT)	27-1505
RY	relay, 5,000-ohm coil	27-1712

A small loudspeaker is used as a sound detector. It should be installed at the outside of the garage door so that it picks up the car's horn sound only when the car is driven up to it. (This prevents the neighbor's horn from unintentionally opening the door.) R2 is the sensitivity adjustment that gives extra assurance that only your horn will work the equipment. R4 is the time control and enables control of automatic turn-off time from 1 to 15 seconds. Omitting R3 and R4 from the circuit will increase the time delay to 20 seconds. A power supply operating from house current enables you to keep the equipment on all the time. It uses a few hundredths of a watt of electric power.

MASTER ELECTRONIC PARTS LIST

TRANSISTORS	RADIO SHACK NO.	PRICE
2N107	27-1701	.49
2N109	27-1702	1.05
2N170	27-1703	1.17
2N217	27-1702	1.05
2N247	27-1704	1.77
2N270	27-1702	1.05
2N301	27-1705	1.59
2N307	27-1706	1.05
2N357	27-1707	1.47
2N408	27-1702	1.05
2N465	27-1702	1.05
2N507	27-1703	1.17
2N508	27-1702	1.05
2N524	27-1702	1.05
2N540	27-1705	1.59
2N1010	27-1703	1.17
2N1199	27-1707	1.47
Silicon rect.		
(100-volt, 1-a)	27-1708	.39
1N34A	27-1709	.27
Solar cell	27-1710	1.77

RESISTORS (Ohms)	RADIO SHACK NO.
10	70-0195
15	70-0195
100	70-0195
150	70-0195
330	70-0195
470	70-0195
1,000	70-0195
2,200	70-0195
3,300	70-0195
4,700	70-0195
10,000	70-0195
15,000	70-0195
47,000	70-0195
100,000	70-0195
150,000	70-0195
220,000	70-0195
270,000	70-0195
390,000	70-0195
470,000	70-0195
680,000	70-0195
820,000	70-0195
1,000,000	70-0195

Above Resistors (10%) Ea. .12
When ordering resistors specify value.

TRANSFORMERS	RADIO SHACK NO.	PRICE
AF output-	27-1379	.79
500-ohm CT. prim.		
3.2-ohm second.		
AF transformer	27-1378	.79
2000-ohm CT prim.		
10,000-ohm second.		
IF transformer-455 kc	27-1711	1.17
Power transformer	27-1505	1.69
110-volt prim.		
12.6-volt CT sec.		

CAPACITORS (disc & tubular)	RADIO SHACK NO.	PRICE
50 pf	71-5101	.16
100 pf	71-5106	.16
470 pf	71-5117	.16
.001 mfd	71-5123	.16
.01 mfd	71-0402	.16
.02 mfd	71-0424	.16
.05 mfd	71-0407	.17
.1 mfd	71-0409	.22
.47 mfd	71-0414	.41

CAPACITORS (variable)	RADIO SHACK NO.	PRICE
Air dielectric, 365 pf	27-1343	1.19
Trimmer, mica, 4-80 pf	71-4031	.32
Trimmer, mica, 30-280 pf	71-4035	.45
140 PF	71-3291	3.00

CAPACITORS (electrolytic)	RADIO SHACK NO.	PRICE
5 mfd	27-952	.29
10 mfd	27-953	.29
30 mfd	27-954	.29
50 mfd	27-955	.31
100 mfd	27-963	.45
1000 mfd	27-1717	.98

MISCELLANEOUS	RADIO SHACK NO.	PRICE
Battery holders,		
D-cell, single	27-1438	.19
D-cell, dual	27-1439	.35
Buzzer, 1 1/2 -volts	20-1086	.79
Coax connectors		
female	27-201	.49
male	27-200	.55
Jack, auto antenna	75-0620	.25
Jack, phono	75-0966	.10
Lamp, #47 bayonet	77-3396	.15
#49 bayonet	77-3392	.15
Meter, 0-1 ma	22-018	2.98
Motor (Kit of 3)	27-1550	1.49
Switch, s.p.s.t.	27-602	.30
s.p.d.t.	27-666	.42
s.p.s.r.	27-1385	.25
d.p.d.t.	27-666	.42

(Continued to next page)

MISCELLANEOUS (CONT'D)	RADIO SHACK NO.	PRICE
Battery Snaps	27-325	.69
Magnetic Telephone Pickup	44-533	.99
Phono Crystal Cartridge	42-005	1.29
DPDT Spring Return	78-2408	2.16
Telegraph Key	20-1085	.69
Line Cord	27-1255	.29
#112 Bulb	77-3480	.17
S-6 (120V) Bulb	77-3397	.25
Socket	87-3354	.08
Binding Post (Pkg. of 10)	27-333	.99
Plug	75-3394	.59
6x6x6" Box	77-0640	2.17

POTENTIOMETERS	RADIO SHACK NO.	PRICE
100 ohm, 2 watt	70-3214	1.32
5,000 ohm, 1/2 watt	27-1714	.59
10,000 ohm, 1/2 watt	27-1715	.59
50,000 ohm, 1/2 watt	27-1716	.59
1 megohm, 1/2 watt	27-211	.59

BATTERIES	RADIO SHACK NO.	PRICE
9 volt Battery	23-464	.29
1 1/2 volt "D" Cell	23-466	.15
1 1/2 volt Penlite Cell	23-468	.10
15V Battery	23-509	1.05
22 1/2 V Battery	23-097	1.29
6 volt Battery	23-006	1.05
6 volt Battery	23-014	1.05
22 1/2 volt Battery	23-073	1.69

COILS	RADIO SHACK NO.	PRICE
Ferrite antenna	27-1430	.59
Relay, 5,000 ohm	27-1712	2.95
RF choke, 2.5 mh	27-1713	.75

SPEAKERS & MICROPHONES	RADIO SHACK NO.	PRICE
Speaker, 2 1/2"	40-247	1.59
Earphone, 2,000-ohm	33-180	1.98
Microphone, carbon	27-1425	.79
Microphone, crystal	33-100	1.89
Earphone, low imp.	33-175	.98

RESISTOR COLOR-CODE GUIDE

Values of most carbon composition resistors are specified by a color code, each color having a value from 0 to 9 as shown in the chart. Three bands are used on standard components. Starting from the end (see drawing), the color of the first band denotes the first digit in the ohmic resistance value, and the second band denotes the second digit. The color of the third band specifies the multiplier, the number of zeros following the first two digits. Thus, bands of yellow, violet, and red would be read as "4" for the first digit, "7" for the second digit, and "2" for the number of zeros to be added—4,700 ohms. Brown, black, red would indicate a value of 1,000 ohms. A fourth band is sometimes used to indicate tolerance. When a fourth band is not used, the value is within 20%; thus, a 1,000-ohm resistor might range in value from 800 to 1,200 ohms. A silver tolerance band indicates the value is within 10% of the coded value. A gold band denotes a tolerance of 5%.

BROWN	1
RED	2
ORANGE	3
YELLOW	4
GREEN	5
BLUE	6
VIOLET	7
GRAY	8
WHITE	9
BLACK	0
SILVER	10%
GOLD	5%

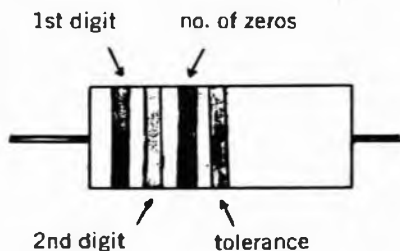

ELECTRIC CIRCUIT MODULES..

Easy To Build Around — Low In Cost!



- Solid State
- Fully Wired
- Screw Terminals
- Mounts In Any Position
- A Radio Shack Exclusive

Wireless Phono Oscillator (A)

No connections required. Plays music from your phonograph (crystal or ceramic cartridge) directly into your AM broadcast band radio. 1400-1600 KC. Size: 2½x2x7/8".

27-257, Ship. wt. ½ lb. Net 4.95

Intercom Amplifier (B)

Excellent for use as an intercom amplifier for home, office or workshop. Uses two speakers. 6 VDC supply, switch and control. Makes for an efficient system. 3¾x2¼x7/8".

27-254, Ship. wt. ½ lb. Net 4.95

Baby Nurse Amplifier (C)

Provides remote control baby sitter anywhere in the house! Its excellent sensitivity even allows you to hear baby's breathing sounds. Size: 3¾x2¼x7/8".

27-256, Ship. wt. ½ lb. Net 4.95

Phonograph Amplifier (D)

Designed for use with any high impedance crystal or ceramic cartridge. Up to 2 watts peak. Wide freq. resp.: 30-15,000 cps. 3¾x2¼x7/8".

27-261, Ship. wt. ½ lb. Net 4.95

Telephone Amplifier (E)

Permits "group listening" to a phone conversation. 1 watt peak. Volume fills a whole room. Just connect battery, speaker, telephone pickup coil. 3¾x2¼x7/8".

27-260, Ship. wt. ½ lb. Net 4.95

Super High Gain Amplifier (F)

Extremely high gain of 100,000. Can be used as a hearing aid, audio signal tracer, eavesdropper, etc. Size: 2½x2x7/8".

27-251, Ship. wt. ½ lb. Net 4.95

Power Amplifier (G)

Versatile 2 watt amplifier has frequency response of 30-15,000 cps. Ideal with tuners, mikes, paging system amplifier or as signal tracer. Size: 3¾x2¼x7/8".

27-253, Ship. wt. ½ lb. Net 4.95

Guitar Amplifier (H)

Use with any string instrument. Provides up to 2 watts peak. Freq. resp. 30-15,000 cps. Less than 1% distortion. Size: 3¾x2¼x7/8".

27-255, Ship. wt. ½ lb. Net 4.95



AC Power Supply

Converts 115 VAC to 6 VAC @ 1 Amp.

Use with rectifier, electrolytic filter. Line cord included.
27-258, WL 2 1/4", Net 1.38



Rectifier-Electrolytic Filter

Converts AC to DC. Used with AC Power Supply. 6 VDC output. 2AV @ 1 amp.
27-259, WL 1 1/2", Net 1.38

ACCESSORIES FOR ABOVE MODULES

Cat. No.	Description	Key Letters	Net Each
2781430	Loopstick Antenna	A	.59
2781465	"C" Cells (4 required)	A	.14
2781437	Battery Holder (2 required)	A	.25
2380066	6V Lantern Battery	B, C, D, E, G, H	1.05
2782258	AC Power Supply	B, C, D, E, G, H	1.95
2782259	Rectifier & Electrolytic Filter	B, C, D, E, G, H	3.95
4081203	3.2 ohm 4" Speaker (2 req'd)	B	1.99
2781284	4 PD1 Switch	B	.49
2780666	500 ohm Control w/Switch	B	.79
408719	8" Extension Speaker	C	8.95

Cat. No.	Description	Key Letters	Net Each
2781264	100 H. Speaker Wire	F	2.39
2781100	Lapel Microphone	C, F	1.89
2782172	500 K Control w/Switch	D, E, F, H	.79
4081213	8" Speaker	D, E, G, H	3.99
448333	Telephone Pickup	E	.99
358180	Headphone	F	1.88
2781680	Penlite Battery (2 req'd)	F	.10
2781433	Battery Holder	F	.22
338018	Dynamic Microphone	G	8.95
338115	Contact Type Microphone	H	1.49

Space Age PA Amplifier

- All Solid State
 - American Made
 - Ice Cube Size
- Completely wired, ready to use when connected to carbon mike, battery any speaker to 15". Encapsulated.
27-1424, Ship. wt. 3 oz. Net 1.98



Solid State Siren Module

- Encapsulated
 - Only 1¾x1¾x7/8"
- Reproduces upward scream and downward wail of police, fire, emergency sirens. Ultra-compact.
27-075, Ship. wt. ¼ lb. Net 3.50

Above Items Available at All Radio Shack Stores