

# TELEVISION

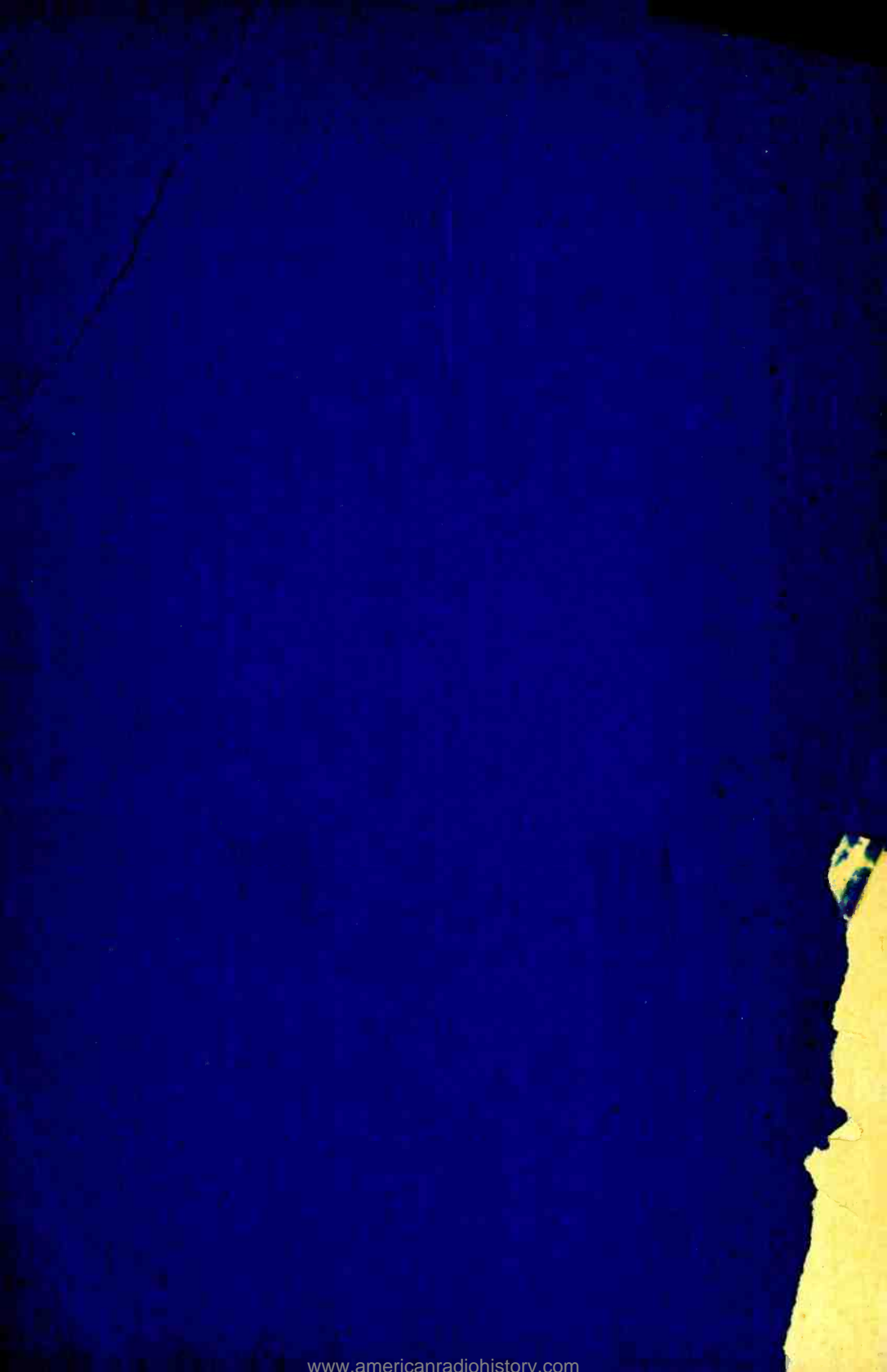

JULY, 1936

RCA INSTITUTES TECHNICAL PRESS



# TELEVISION

*Collected Addresses  
and Papers on the Future of the  
New Art and Its Recent Technical  
Developments*



VOLUME I  
JULY, 1936

*Published by*  
RCA INSTITUTES TECHNICAL PRESS  
*A Department of RCA Institutes, Inc.*  
75 VARICK STREET, NEW YORK

COPYRIGHT, 1936  
BY RCA INSTITUTES, INC.

# CONTENTS

	PAGE
Television.....	DAVID SARNOFF 1
RCA's Development of Television.....	DAVID SARNOFF 6
The Future of Radio and Public Interest, Convenience and Necessity .....	DAVID SARNOFF 7
Television in Advertising.....	DAVID SARNOFF 18
Television.....	DR. C. B. JOLLIFFE 20
A Study of the Propagation of Wavelengths Between Three and Eight Meters.....	L. F. JONES 28
Notes on Propagation of Waves Below Ten Meters in Length..... .....	BERTRAM TREVOR AND P. S. CARTER 67
A Study of Television Image Characteristics—Part I.....	E. W. ENGSTROM 107
A Study of Television Image Characteristics—Part II.....	E. W. ENGSTROM 129
An Experimental Television System.....	E. W. ENGSTROM 146
Description of An Experimental Television System and the Kinescope .....	V. K. ZWORYKIN 149
Description of Experimental Television Transmitting Apparatus..... .....	R. D. KELL 169
Description of Experimental Television Receivers.....	G. L. BEERS 187
The Iconoscope—A Modern Version of the Electric Eye..... .....	V. K. ZWORYKIN 202
Television.....	V. K. ZWORYKIN 220
An Experimental Television System:	
Part I—Introduction.....	E. W. ENGSTROM 253
Part II—The Transmitter.....	R. D. KELL, A. V. BEDFORD, and M. A. TRAINER 259
Part III—The Receivers.....	R. S. HOLMES, W. L. CARLSON, and W. A. TOLSON 279
Part IV—The Radio Relay Link for Television Signals..... .....	CHARLES J. YOUNG 300
Theory of Electron Gun.....	I. G. MALOFF and D. W. EPSTEIN 309
The Cathode Ray Tube in Television Reception.....	I. G. MALOFF 337
Scanning Sequence and Repetition Rate of Television Images..... .....	R. D. KELL, A. V. BEDFORD, and M. A. TRAINER 355
An Urban Field Strength Survey at Thirty and One Hundred Mega- cycles.....	R. S. HOLMES and A. H. TURNER 375
Ultra-High-Frequency Transmission Between the RCA Building and the Empire State Building in New York City.....	P. S. CARTER and G. S. WICKIZER 391
Electron Optical System of Two Cylinders as Applied to Cathode Ray Tubes.....	D. W. EPSTEIN 405



## FOREWORD

**W**HEN the Radio Corporation of America began to speed the development of television more than fifteen years ago, its engineers immediately recognized that the future of the new art lay entirely in the field of electronics.

At that time, however, there was as yet no starting point from which progress in an electronics method could be begun. The engineers were faced with the problem of moving forward from the then existing rotating scanning-disk system to a new method lying in a totally different division of science.

How this was done, beginning with the inventions of Dr. V. K. Zworykin for transmission and reception and proceeding by evolutionary steps until mechanical means had been entirely replaced by electron rays, is now part of the history of television. For several years, the new system has been the subject of intensive and continuous research work, carried on at the expense of many million dollars, and today it has reached a high stage of development in the laboratory. What its efficiency will be under actual service conditions is now being determined by extensive field tests through which the many problems to be solved before commercial television is a reality will be answered. Whatever further modifications may be necessary, one thing is certain: by carrying on the development of television in the field of electronics, the art has been released from the limitation of things mechanical and has been placed on a sound, fundamental base for further progress.

It is the forward looking policy of RCA to continue this development in a spirit of coöperation with the radio industry; to achieve standards of television, not as a replacement of the present system of sound broad-

casting but to carry the art another step forward in usefulness by adding sight to already existing facilities. Other manufacturers already have received licenses to use the results of RCA's extensive research work and its inventions in television receivers and in the tubes used in such receivers, in order that the fullest possible use and freedom may be given to the expression of the art in public service.

Plans for the future of television, outlined in addresses by David Sarnoff, President of the Radio Corporation of America, and reports by RCA research engineers on the principal recent steps in the evolution of the new art, appear on the following pages.





# TELEVISION

BY

DAVID SARNOFF

(President, Radio Corporation of America)

*Statement—Delivered at Annual Meeting of RCA Stockholders, New York City, May 7, 1935.*

**P**UBLIC interest in television continues unabated since the statement made in the annual report to the company's stockholders on February 27, 1935. In that report it was stated that the management of the Radio Corporation of America was diligently exploring the possibilities of a field demonstration, the next practicable step in the development of television, in order that subsequent plans may be founded on experience thus obtained.

As further stated in that report, our laboratory efforts have been guided by the principle that the commercial application of such a service could be achieved only through a system of high-definition television which would make the images of objects transmitted, clearly recognizable to observers. The results attained by RCA in laboratory experiments go beyond the standards accepted for the inauguration of experimental television service in Europe. We believe we are further advanced scientifically in this field than any other country in the world.

In view of our own progress, and recent public statements on television made both here and abroad, I feel that the annual meeting of our stockholders is an appropriate occasion for a statement of Radio Corporation's position in television and of its plans for the immediate future.

First, let me emphasize that television bears no relation to the present system of sound broadcasting, which provides a continuous source of audible entertainment to the home. While television promises to supplement the present service of broadcasting by adding sight to sound, it will not supplant nor diminish the importance and usefulness of broadcasting by sound.

In the sense that the laboratory has supplied us with the basic means of lifting the curtain of space from scenes and activities at a distance, it may be said that television is here. But as a system of sight transmission and reception, comparable in coverage and service to the present nation-wide system of sound broadcasting, television is not here, nor around the corner. The all important step that must now be taken is to bring the research results of the scientists and engineers out of the laboratory and into the field.

Television service requires the creation of a system, not merely the commercial development of apparatus. The Radio Corporation of America with its coordinated units engaged in related phases of radio communication services is outstandingly equipped to supply the experience, research and technique for the pioneering work which is necessary for the ultimate creation of a complete television system. Because of the technical and commercial problems which the art faces, this system must be built in progressive and evolutionary stages.

Considering these factors and the progress already made by your company, the management of the RCA has formulated and adopted the following three-point plan:

#### THE PLAN

1. Establish the first modern television transmitting station in the United States, incorporating the highest standards of the art. This station will be located in a suitable center of population, with due thought to its proximity to RCA's research laboratories, manufacturing facilities, and its broadcasting center in Radio City.
2. Manufacture a limited number of television receiving sets. These will be placed at strategic points of observation in order that the RCA television system may be tested, modified and improved under actual service conditions.
3. Develop an experimental program service with the necessary studio technique to determine the most acceptable form of television programs.

Through this three point plan of field demonstration we shall seek to determine from the practical experience thus obtained, the technical and program requirements of a regular television service for the home.

It will take from twelve to fifteen months to build and erect the experimental television transmitter, to manufacture the observation receivers and to commence the transmission of test programs.

The estimated cost to the RCA of this project will be approximately one million dollars.

In order that the promise, as well as the present limitations, of the art be thoroughly understood, I shall review briefly the present status of television and the position of RCA in this field.

## RECEPTION

Our research and technical progress may be judged by the fact that upon a laboratory basis we have produced a 343-line picture, as against the crude 30-line television picture of several years ago. The picture frequency of the earlier system was about 12 per second. This has now been raised to the equivalent of 60 per second. These advances enable the reception, over limited distances, of relatively clear images whose size has been increased without loss of definition.

From the practical standpoint, the character of service possible in the present status of the art, is somewhat comparable in its limitations to what one sees of a parade from the window of an office building, or of a world series baseball game from a nearby roof, or of a championship prize fight from the outermost seats of a great arena.

## TRANSMISSION

In the present state of the art, the service range of television from any single station is limited to a radius of from fifteen to twenty-five miles. National coverage of the more than three million square miles in the United States would require a multitude of stations with huge expenditures, and presents a great technical problem of interconnection in order to create a network system by which the same program might serve a large territory.

Existing and available wire systems are not suitable for interconnecting television stations. Therefore, radio relays must be further developed or a new wire system created to do the job now being done by the wires which connect present day broadcasting stations.

While the problem of interconnection still remains one of the great obstacles to the extension of sight transmission and reception, an outstanding accomplishment in the field of television research is the invention and perfection by RCA engineers of the "iconoscope". This is an electric eye, which has advanced the technique of television by facilitating the pickup of studio action and permitting the broadcast of remote scenes, thereby giving to the television transmitter the function of a camera lens. Through the use of the iconoscope, street scenes and studio performances have been experimentally transmitted and received.

## RELATIONSHIP OF TRANSMITTER AND RECEIVER IN TELEVISION

Television is a highly complicated system of transmitting and receiving elements with thousands of interlocking parts, each of which must not only function correctly within its own sphere of activity, but must also synchronize with every other part of the system. In broadcasting of sight, transmitter and receiver must fit as lock and key.

On the other hand, broadcasting of sound permits a large variety of receiving devices to work acceptably with any standard transmitter. Notwithstanding the great progress that has been made in sound broadcast transmission, a receiving set made ten years ago can still be used, although with great sacrifice in quality. This is not true in television, in which every major improvement in the art would render the receiver inoperative unless equivalent changes were made in both transmitters and receivers.

Important as it is from the standpoint of public policy to develop a system of television communication whereby a single event, program or pronouncement of national interest may be broadcast by sight and sound to the country as a whole, premature standardization would freeze the art. It would prevent the free play of technical development and retard the day when television could become a member in full standing of the radio family. Clearly, the first stage of television is field demonstration by which the basis may be set for technical standards.

## ESTABLISHMENT OF TELEVISION AS A PUBLIC SERVICE

From the foregoing it will be seen that a number of basic problems surround any effort to establish television on a regular basis of public service to the nation. The more important of these problems are:

1. The fact that if the new art of television is to make the required technical progress, there will be rapid obsolescence of both television transmitters and television receivers.
2. The creation of new radio or wire facilities of interconnection before a service on a national basis can be rendered.
3. Further development, through experimentation in the field, of a system of high definition television which calls for new radio technique inside and outside the studio,

and for the production of home television receivers which will increase the size of the picture and at the same time decrease the price at which the receiver can be sold to the public.

As in other related fields, the Radio Corporation of America is undertaking to encourage, develop and coordinate the research, engineering and technical processes by which a new art and a new industry may spring from the original root of radio communications. Television demands the most effective coordination of the equipment, facilities and services embraced by the operations of the various units of the RCA. It requires the utilization of the best engineering and manufacturing experience of the RCA Manufacturing Company in the production of television equipment; of the research facilities of the RCA laboratories for the development of new television tubes; of our experience in the construction of transmitting stations; of the studio, program, and broadcasting technique created by the National Broadcasting Company; and of the general experience of R.C.A. Communications.

Scientific research is the foundation of the radio industry and the achievements of RCA laboratories are most valuable assets. These research activities have helped to maintain the Radio Corporation's position of leadership in the field of radio.

In announcing this plan, I wish to emphasize the clear distinction that must be made between the coming field demonstration stages of television, and the ultimate fulfillment of the promise of world-wide transmission of sight through space—an achievement which will be second only to the world-wide transmission of sound through space. The sense of sight which television must eventually add to the body of radio communications cannot supplant the service of speech and music which permits any single event to be simultaneously broadcast to the nation as a whole, and which brings to millions of homes continuous programs of entertainment, information and education.

While the magnitude and nature of the problems of television call for prudence, they also call for courage and initiative without which a new art cannot be created or a new industry established. Your Corporation has faith in the progress which is being made by its scientists and its engineers, and the management of the Radio Corporation of America is exploring every path that may lead to an increasing business for the radio industry and to a new and useful service to the public.

# RCA'S DEVELOPMENT OF TELEVISION

By

DAVID SARNOFF

(President, Radio Corporation of America)

*Statement—Delivered at the Annual Meeting of the Stockholders of the Radio Corporation of America, Tuesday, April 7, 1936.*

**A**T OUR annual meeting last year I announced that the Board of Directors had approved a plan for a field test in television. At that time it was stated that in twelve to fifteen months the project would be taken from the laboratory and subjected to field tests. I am pleased to inform you that our construction work has proceeded on schedule with the building of a new television transmitter located on the Empire State Building in New York, and with an experimental television studio in the RCA Building as a part of the National Broadcasting Company's operations.

Tests will start Monday, June 29, 1936. A number of experimental receivers are to be placed at observation points in the hands of our technical personnel so that we may determine the requirements and further development necessary to the establishment of a public television service.

This corporation is second to none in the scientific and technical development of television. We have gone much beyond the standards fixed elsewhere for experimental equipment. But this is a far cry from the expectations of such a service aroused by pure speculation on the subject. There is a long and difficult road ahead for those who would pioneer in the development and establishment of a public television service.

# THE FUTURE OF RADIO AND PUBLIC INTEREST, CONVENIENCE AND NECESSITY

By

DAVID SARNOFF

(President, Radio Corporation of America)

*Statement—Presented before Federal Communications Commission,  
Washington, D. C., June 15, 1936.*

THE Radio Corporation of America welcomes the opportunity to testify at this informal hearing. We are deeply aware of the importance and urgency of the tasks before the Federal Communications Commission. We are pleased to place at your disposal the information and experience of RCA, gained from its operations in radio research, communications, broadcasting, manufacture and sales. These interrelated enterprises have enabled us to study and develop radio in ever widening fields of public usefulness.

In such a fast moving art as radio, government regulation must have wide powers of discretion. A strait-jacket of rigid rules would cripple its energies. In the Radio Act of 1927 and in the Communications Act of 1934, Congress recognized this fact and wisely refrained from prescribing hard-and-fast formulas. Instead it set up a high standard for flexible regulation, the standard of "public interest, convenience and necessity." That standard gives your Commission the power, and therefore the responsibility, of judging issues on the basis of past accomplishments, of present activities, and particularly on the capacity for future progress.

It is in relation to this standard of "public interest, convenience and necessity" that I desire to summarize briefly the position of radio, both as an art and as an industry, and to call your attention to the new services which it is evolving and to prospects for its future development.

We of the RCA are especially conscious of the complexity of the problems your Commission must solve in the public interest. That complexity results from a number of circumstances unique to the radio industry.

*First:* It is the youngest of our country's great industries. Because of the aggressive and dynamic development of the radio art, it has reached its present proportions and

its vast social significance in less than fifteen years. It has few precedents and no rules of thumb to formulate its policies. At every stage of its progress it must break new ground. It must always be a daring pioneer.

*Second:* It is an industry that functions in the present, although it lives also for a greater future. Important new radio services are ready today for practical demonstration. Tomorrow they will be ready to serve the public. Others are still in the laboratory stage of development. But beyond are widening perspectives of usefulness: the promises of further radio possibilities which may well outweigh all the achievements of the past. These developments must be safeguarded against unnecessary restrictions. Radio progress must not be "frozen" at any point.

*Third:* We deal in radio with a public treasure that—for the moment—is limited in its extent. The frequencies which make up the radio spectrum constitute one of the nation's most valuable natural resources. Each of them must be made to yield its maximum of service under the stimulation of every new discovery.

These are the realities of today. But tomorrow, the pioneers in the radio laboratories may open up unlimited reservoirs of new frequencies and then your Commission must be ready to remold its rules to take advantage of the new opportunities, so that the public may benefit at once from these achievements.

We have no definite yardstick with which to measure radio as a civilizing influence, in the education, entertainment and progress of mankind. But we do know that life itself has been revolutionized by the speed and completeness with which radio has drawn the most distant places, the most forgotten lives, into the orbit of civilization.

In 1920 the United States had direct cable connection with only two European nations, Great Britain and France, and with a few countries in South America and one in the Orient. Today our country is linked by nine public service radio companies to more than 60 nations in direct radio communication which cannot be broken by any other nation. More than 5,000,000 paid messages are handled annually by the radio-telegraph carriers reporting to your Commission. This development of American radio communications has sliced one hundred million dollars from the bills of international telegraph users here and abroad.



Until the advent of radio, no communication service could cover the oceans—seven-eighths of the world's surface. In 1902, there was only one American merchant ship equipped with radio—the S.S. Philadelphia. Today some two thousand American ships have radio telegraph equipment. A ship with modern radio apparatus can maintain uninterrupted communication with coastal stations in the United States during its entire circumnavigation of the globe. Radio direction finders guide vessels at sea. A facsimile service providing weather maps to ships at sea is now being introduced.

Broadcasting has made even more dramatic strides. When the Harding-Cox election returns were broadcast in 1920, only a few hundred radio amateurs listened in. Today 23,000,000 homes in our country, more than 70% of the total, are equipped with radio receivers, and 3,000,000 American automobiles, more than 10% of all registered motor cars, are radio-equipped. If all receiving sets were tuned to the same program, 90,000,000 persons, approximately three-quarters of our population, could listen at the same time to a single voice. The United States and its territorial possessions have 623 broadcasting stations, representing in ownership a cross-section of American life: industrial organizations, newspapers, labor groups, colleges, cultural and religious institutions. Affiliated with the two major networks are 196 broadcasting stations. Of these 22 are owned and managed by the network companies. The rest are independently owned and operated.

Not only do the American listeners enjoy the finest broadcast programs in the world without paying license fees, but they are buying the finest radio receivers in the world at the lowest prices. No wonder, as Professor Allport of Harvard has declared, we spend a billion hours a week listening to the radio!

During 1935 it is estimated that the people of the United States spent seven hundred million dollars on radio—truly a figure which demonstrates the magnitude of the industry and its importance to the prosperity of the nation.

To show how important radio is to other industries, the owners of radio sets spent one hundred fifty million dollars last year for electric power to operate their sets—almost twice the amount which the broadcasting companies received for broadcasting the programs which these listeners heard. In the same year, this “wireless” industry consumed a million miles of wire in the manufacture of its apparatus. And the world's largest

wireless broadcasting company, the NBC, was at the same time the largest customer of the world's greatest wire organization, the American Telephone and Telegraph Company. The annual telephone bill of the NBC for wire service exceeds three million dollars.

Probably the most striking figure in all the columns of radio statistics is the estimate that the American public has invested more than three billion dollars in broadcast receiving apparatus. This is more than ten times the investment in broadcasting stations and radio manufacturing plants. From this you will realize the extent of the general public's interest in the healthy development of radio.

No statistics, however, can suggest the magnitude of the future of the radio art. Each advance made by the laboratories into unexplored domains of the ether carries with it the possibility of creating even greater services. A few, such as television and high-speed facsimile communication, are ready now for field demonstrations. Others are on the way, although further laboratory experimentation will be necessary before they are ready for practical use.

This research represents an immense investment in capital and an incalculable investment in human genius. It is fascinating as a conquest of the unknown, and thrilling because of its promise of increased human power, knowledge and happiness. Yet, considered coldly as an economic element, it is particularly significant at this time when the country is emerging from the depths of an economic depression. The new instrumentalities of radio hold the promise of new industries, new services productive of new wealth and new employment.

Of the future industries now visible on the horizon, television has gripped the public imagination most firmly. Technically, television is an accomplished fact, although it is not yet ready commercially. In this field American research holds the lead and America's supremacy, as in other fields of radio, is universally recognized.

To bring television to the perfection needed for public service our work proceeds under high pressure at great cost and with encouraging technical results. Other nations are accepting the standards and methods of RCA engineers and are applying them to the solution of their own television problems. Most of these foreign nations have been working with public funds. No such government subsidies of course have been available in the

United States. None has been asked. But for more than a decade in years of plenty and in years of depression, a corps of RCA research engineers has been working unremittingly to give the art of television to the public. We are now entering advanced stages of that effort and will open an experimental television transmitting station in New York within two weeks. We believe that we have demonstrated again that private initiative can accomplish more in America than government subsidy has been able to accomplish elsewhere.

The television which is assuming shape in our laboratories will not, as many persons assume without warrant, replace sound broadcasting or make sound receiving sets obsolete. The present sound broadcasting services will proceed without interruption. Television must find new functions, new entertainment and new programs.

As soon as television has been brought to a point of practical service it will be made available to the American people. But to protect the public interest, television should not be launched until proper standards have been fixed. Television reception as we now know it differs from sound reception in at least one decisive technical aspect. In sound broadcasting every receiver is built to pick up any transmission within its range of reception. On the other hand, television represents an integrated system in which sending and receiving equipment must be fitted one to the other, as lock and key. We must avoid the danger of costly obsolescence which hasty commercialization might inflict upon the public.

We ask the Commission and the various government departments interested in radio to consider carefully the needs of this new industry. Frequencies should be made available not only for the expanded experimental and field demonstration work, but for the fullest measure of development toward a practical television service.

Radio broadcasting differs from all the other arts in that the service which it renders to the public is rendered free. There is no license fee for the use of radio receiving sets in the United States. And when television comes, it is my hope that despite the greater expense of its far more complicated program productions, there will still be no need for a license charge for television receivers.

Side by side with television, although in many respects nearer to final achievement, there is emerging from the field of radio

experimentation high speed facsimile communication. By means of this new development, written, printed, photographic and other visual matter can be sent by radio over long distances and reproduced at the receiving end with amazing exactness. It is difficult to imagine limits of the use of such an invention. It should make the dot-and-dash system of telegraphy as outmoded as the pony express. Pictures, sketches, handwriting, typewriting and every other form of visual communication, will be transmitted as easily as words are now sent over a telegraph wire. Even in its earlier stages facsimile will be a medium for the instant dissemination of information of a hundred different types, from weather maps to statistics, from educational data to comic strips. Far from displacing the existing media of information—and particularly the newspapers—facsimile should contribute to their progress, providing them with swifter and more effective facilities.

In this new facsimile service we have also reached an advanced stage. R.C.A. Communications, Inc., has built an experimental facsimile circuit between New York City and Philadelphia, demonstrated publicly for the first time last Thursday. It uses ultra-high frequencies linked into instantaneous transmission by automatic relays. This circuit will demonstrate the possibilities inherent in facsimile transmission and should also contribute to solving the difficult problems of relaying television programs on these ultra-high frequencies.

One of the triumphs of this demonstration circuit has been its success in combining, for the first time in radio history, the simultaneous transmission of visual matter with automatic type-writer telegraph operation on the same radio channels. This ability to carry separate services simultaneously on a single frequency is of great importance.

To make possible the greatest public use of this new development, radio channels should be provided which will make room for healthy expansion in facsimile research as well as in service, and the "public interest, convenience and necessity" of this new achievement should be recognized in the allocation of frequencies for this purpose.

It is the mastery of the ultra-high frequencies which is bringing television and facsimile within the area of practical use. We are steadily pushing farther into the higher regions of the spectrum which only yesterday constituted a "radio desert", now being made fruitful. One example will illustrate the great

possibilities in this direction: Ultra-high frequencies have a range which is limited approximately by the horizon so that the same frequency may be used over and over again by keeping the transmitters 100 to 200 miles apart. This means that a relatively few frequencies assigned for local broadcast use can be reassigned until every community in the land can possess a radio voice for its own local purposes.

This expansion of the useful radio spectrum has only begun. Beyond the ultra-high frequencies lie the "micro-waves"—frequencies that oscillate at the rate of a billion cycles a second, wavelengths measured in centimeters instead of meters.

Future developments in micro-waves may well prove revolutionary. In the past, radio operations have been confined to a limited part of the radio spectrum. Once we have conquered these micro-waves we shall have opened a radio spectrum of almost infinite extent. Instead of numbering the useable channels in a few scant thousands, the radio art will put millions of frequencies at the command of communication services of every kind. When that day comes—and I have no doubt that it will—there will be frequencies enough to make possible the establishment not only of an unlimited array of mass communication services, but of an unlimited number of individual communication connections. In that day each one of our millions of citizens may have his own assigned frequency to use wherever he may be.

Step by step we are working toward that far off goal. We are telegraphing and telephoning today by radio to and from ships at sea and planes in the air. There is no reason we should not also be able to communicate with moving trains, or for that matter with moving automobiles. We can almost say that without radio, aviation would be impossible. In approaching such potentialities we must not allow our imagination to be earth bound. Radio belongs to the new day—the search for service and wealth above the earth. The finding of a new range of frequencies is of more importance than the discovery of a new gold field.

Recently international broadcasting has been in the limelight. The European crisis made overseas events an important factor in our daily interest. The technique of this international broadcasting is being constantly improved. Although this use of shortwave radio is still in its infancy, it merits vigorous encouragement. International broadcasting should promote better

understanding among nations and—from our own national standpoint—better understanding of the United States among the nations of the world. The growth of international broadcasting should increase all other forms of international communications and promote our international commerce. To make such an achievement possible, America's international broadcasting should be organized as a definitely functioning service and the available international frequencies should be utilized to their fullest extent.

From time to time there are suggestions that it is the duty of the Federal Communications Commission to protect the wire services of the country against the encroachment of radio. Even if the Communications Act which created your Commission had not prohibited such an attempt, by saying that your Commission shall “generally encourage the larger and more effective use of radio in the public interest,” such an effort would be a futile one. Any effort to stop the progress of a new art in order to protect an existing art is bound to be futile.

Such a step would be contrary to the spirit of the country, contrary to the modern spirit of progress, and contrary to the whole experience of radio. For radio itself deliberately obsolesces today what is built yesterday. But for that fact, we would still be signalling with long waves from great alternators instead of spanning the earth with short waves from vacuum tubes.

So long as there is an insufficiency of frequencies, it is proper for your Commission to conserve those frequencies by not using them needlessly to compete with wires. However, the policy which underlies such a decision should never have for its object the protection of wire services. It should always have for its object the protection of radio frequencies.

Your Commission will not be afraid of progress. Millions of dollars are being spent by the radio industry to invent new equipment and erect new stations which are made obsolete by the very things we learn from building them. The facsimile and television stations which the RCA has just built, for instance, may be made obsolete by the lessons they will teach us. We set up new systems and then we encourage our research workers to continue their experiments even if they supplant what we have created. Why? Because it is the only way to make progress. Such experiments call for enormous capital investments. They call also for imagination of the highest order and for courage to follow where that imagination leads. It is

in this spirit that our laboratories and our radio scientists are diligently and devotedly engaged in a task of the highest service to humanity.

Radio research is so closely linked to the manufacture of apparatus that I feel warranted in explaining to your Commission the basic patent policy of the RCA, and particularly its application to the new fields of facsimile and television. It has been the policy of the Radio Corporation to grant licenses to its competitors engaged in the manufacture of radio broadcast receivers and tubes, and at the present time there are outstanding 52 such licenses for receivers and 13 for tubes. These licenses include the right to make and sell not only sound broadcast receivers and tubes, but also receivers and tubes for television and facsimile for the home, thus making available the results of our research in these fields to licensed manufacturers of the industry. In manufacturing and selling this apparatus the RCA licensees may utilize all of the inventions made or owned by the Radio Corporation, and all patents under which it has the right to grant licenses to others.

We are all proud of the fact that the United States has maintained freedom of the air while exercising flexible and intelligent regulation. We have succeeded in utilizing the motive power of private initiative while placing its achievements at the service of the whole population. In less fortunate portions of the world, we have warning examples of radio bound and gagged, along with other agencies of expression, its strength diverted to serve the autocratic purposes of dictators. Whatever else we do, whatever else your Commission may feel called upon to do, this valuable national possession of radio must remain, as heretofore, the instrument of democratic self-government and one of the important contributors to our national progress.

Measured by the advances made in other fields, radio in the last ten years has lived a century. Perhaps it may crowd a thousand years into the next decade. I am proud to be one of those who have participated in this development almost from the beginning. Next September I shall have been in the service of radio for thirty years. That is a long time in so young a science. During these thirty years I have watched, naturally with the keenest interest, the unfolding of the radio art. I have seen technical revolutions in radio communication, radio broadcasting and radio entertainment, but I can say to you that never before

have I seen so many developments emerging into practical achievement as the laboratories promise at this moment.

Out of this experience I should like to lay before you a number of suggestions. I trust they may be helpful to your Commission, and to the Government, in the task of formulating a basic and comprehensive radio policy. Such a policy is needed to maintain America's supremacy in radio and to fortify the independence of our country's position in this growing field. My suggestions, summarized, are as follows:

1. Because of the rapid strides of the radio art, advance reservations of frequencies should be made by the Federal Communications Commission to meet the needs of future services, such as television, facsimile and high-frequency broadcasting. This will enable these achievements of radio to give their greatest possible public service as soon as developed, instead of compelling them to contest with older services for adequate space in the spectrum.
2. Except for experimental purposes, no allocations to individual applicants should be made in these reserved frequencies until actual public service is possible. No one should be permitted to reserve frequency space for future use and then let it remain idle while others carry the burden of development.
3. In allotting frequencies the greatest economy and usefulness of the available channels should be promoted by requiring, so far as feasible, the multiple use of frequencies.
4. In determining precedence in the allocation of frequencies, consideration should be given to services on the basis of their comparative importance to the public, the urgency of the tasks to be performed, and the requirements of the public to be served. Radio has made possible outstanding progress in mass communication. Ample allocation should be made for the greatest use of this public service for the broadcasting of sight as well as of sound, nationally and internationally.
5. In time of war, or other emergency, all the equipment and resources of the radio industry, are by law placed at the disposal of the nation. The government departments interested in our national defense should, therefore, cooperate in making possible the greatest peace-



time development of radio by limiting the number of frequencies requested for exclusive government use.

6. A fundamental and comprehensive communications policy should be formulated, not only for the guidance of the Commission, but of all government departments, to safeguard the independence of America's communication system in international relations. This is especially important because American communication services are at a disadvantage in dealing with monopolistic state-owned foreign communication systems.
7. In helping to determine the attitude of the United States in the International Communications Conference to be held in Cairo in 1938, the Federal Communications Commission should recommend a policy which will promote the greatest possible international use of radio communications. That Conference will be called upon to apportion the hitherto unallocated frequencies in the upper portions of the radio spectrum. In the international field as well as in domestic use these allocations should be safeguarded against any possibility of freezing radio development.

I thank your Commission for this opportunity to appear before you and to present my views. I have devoted myself to the general aspects of the radio art, rather than to its engineering details. With your permission and at such time as you may designate, Dr. C. B. Jolliffe, Engineer in charge of the RCA Frequency Bureau, will testify concerning the engineering phases of these problems.

The radio industry, let me say in conclusion, is convinced that the best interests of the industry coincide with the best interests of the public. We are content to submit our suggestions and recommendations to the standard of "public interest, convenience and necessity" prescribed by Congress for the guidance of your Commission.

# TELEVISION IN ADVERTISING

BY

DAVID SARNOFF

(President of Radio Corporation of America)

*Excerpts from "The Message of Radio," an address delivered before the Advertising Federation of America, Boston, June 29, 1936.*

**W**HEN television broadcasting reaches the stage of commercial service, advertising will have a new medium, perhaps the most effective ever put at its command. It will bring a new challenge to advertising ingenuity and a stimulus to advertising talent.

The new medium will not supplant nor detract from the importance of present-day broadcasting. Rather, it will supplement this older medium of sound and add a new force to the advertisers' armament of salesmanship. Television will add little to the enjoyment of the symphony concert as it now comes by radio to your living room. Sound broadcasting will remain the basic service for the programs particularly adapted to its purposes. On the other hand, television will bring into the home much visual material—news events, drama, paintings, personalities—which sound can bring only partially or not at all.

The benefits which have resulted from the industrial sponsorship of sound broadcasting indicate that major television programs will come from the same source. It requires little imagination to see the advertising opportunities of television. Broadcasting an actual likeness of a product, the visual demonstration of its uses, the added effectiveness of sight to sound in carrying messages to the human mind—these are only a few of the obvious applications of television to merchandising. Commercial announcement can be expanded through television to include demonstration and informational services that will be of value to the public as well as to the advertiser.

Broadcasting has won its high place in the United States because—unlike European listeners—American set owners receive their broadcasting services free. Despite the greater cost of television programs, I believe that owners of television receivers in the United States will not be required to pay a fee for television programs. That is an aspect of the television

problem in which the advertising fraternity will doubtless cooperate in finding the commercial solution.

Whoever the sponsor may be, or whatever his interests or purposes, he will be under the compulsion to provide programs that will bring pleasure, enlightenment and service to the American public. That compulsion operates today and must continue to operate if we are to retain the American system of radio broadcasting. The public, through its inalienable right to shut off the receiver or to turn the dial to another program will continue to make the rules. In television as in sound broadcasting the owner of a set will always be able to shut it off. In other words, the ultimate censorship of television, as well as of sound broadcasting, will remain between the thumb and forefinger of the individual American.

# TELEVISION

By

DR. C. B. JOLLIFFE

(Engineer-in-charge, RCA Frequency Bureau)

*Statement—Presented by Dr. C. B. Jolliffe, concerning Television, on behalf of the Radio Corporation of America before the Federal Communications Commission at the Hearing on Frequency Allocation, June 15, 1936.*

FOR more than ten years RCA has been conducting research work looking toward the development of television. During this period many people have urged on this Commission or its predecessor, the Federal Radio Commission, the allocation of frequencies to commercial television on the basis that it was ready for acceptance. Up to the present time the engineers and executives of the RCA have not felt that television was ready for presentation to the public. Their decisions have been made on the basis of engineering analysis and adequate experimentation.

In making these decisions RCA has proceeded on the principle that rarely is a commercial device, method or system completely developed in the laboratory. At some time in its history a development must be taken out of the laboratory and put into operation under conditions that closely simulate those in the field in which it will be operated commercially. This is particularly true of a highly complicated system such as television.

Accordingly as television has passed through successive evolutionary stages in laboratory research RCA has put its most advanced developments under tests in the field. Such tests of a television system run into very large sums of money. However, RCA has expended and is now expending large amounts in the development of a television system both in the laboratory and in the field, and it is convinced that there is no substitute for the field tests in perfecting a satisfactory system. It is impossible to determine in the laboratory or with low power transmitters and facilities operated under laboratory conditions whether a system will fulfil the rigorous requirements of commercial application in the field.

In the course of their studies on this problem the research engineers of RCA have thoroughly investigated all the different methods by which television may be accomplished, including scanning disk, flying spot, cathode ray devices and other methods,

and have pushed each type to what was considered its maximum usefulness.

Prior to 1932 there was in operation in the research laboratories in Camden, N. J., a system of television which brought mechanical scanning to what was believed to be the highest level then obtainable in any system. In the receiving portion of this system a cathode ray tube was used. On the basis of this work it was decided in 1932 to install in New York City a transmitter using this mechanical system of scanning. At that time it was known that it was necessary to use ultra-high frequencies to obtain the picture quality then possible. Consequently the transmitter was built to operate on a frequency above 40,000 kc. This was the first full scale television broadcast transmitter for relatively high definition images. The experimental operation of this transmitter provided us with information as to many of the transmitter problems, one of which was the difficulty of serving a city such as New York. Primarily, however, these tests showed the inadequacy and limitations of a mechanical system of television.

While this transmitter was being used for the purpose of collecting data on the transmission problems our engineers in Camden were concentrating on a system of television based on electronic scanning in order to overcome the limitations of the mechanical system which had been emphasized by the New York tests. In 1933 there was put in operation in the laboratory in Camden, N. J., a new type of transmitter which employed electrical scanning, a greater number of lines, and other improvements. By 1934 this system had developed into one employing 343 lines interlaced with a frame frequency of 30 per second and a field frequency of 60 per second.

During the course of this experiment a synchronizing generator which was entirely electrical and employed no moving parts was incorporated in the system. This marked another of the major evolutionary steps in the progress of developing a television system, and in consequence of this it was then necessary to answer the question as to whether or not the system would meet the test of public acceptance. Consequently, a decision was made a little more than a year ago to test this system in the field by establishing facilities for such a test in New York City.

The announcement of the inauguration of the construction of a system to carry out this experiment was made by Mr. Sarn-

off to the stockholders of the RCA on May 7, 1935. The work has gone forward ever since. To carry on this experiment an 8 kw television transmitter with special antenna has been set up in the tower of the Empire State Building, a special studio of the National Broadcasting Company in the RCA Building has been adapted for television use, a few receiving sets of what we believe to be the most modern design have been constructed under factory conditions to be put in the hands of trained observers distributed through the service area of the transmitter. The first transmissions from this transmitter will be made June 29, 1936. It is to be regretted that data which will be obtained with a few months' operation of this experimental system are not available today to this Commission. However, you can be assured that you and your engineers will be kept fully informed of the progress of the experiment.

When the design of this experimental system was begun it was necessary to set standards on which to base the system and the engineers set up the same standards which they had been using in the test transmitter at Camden (343 lines interlaced, 30 frames per second, field frequency 60 per second). It was not the idea at that time, nor is it now, that the standards then set up were to be the final standards. It was known early in 1935 that these standards could be met in apparatus which it was possible to build and which would serve to give an answer to the problem. Frequency separation between the carrier frequency for television and carrier frequency for sound was set at 2250 kc, the entire transmission being included in a 4,000 kc. band. Other standards were incorporated but do not affect the frequency allocation problem. The carrier frequencies used are 49,750 kc for the sight and 52,000 kc for the sound transmission.

The Television Committee of the Radio Manufacturers Association has had under consideration for several years the question of proper standards for a television picture. These standards have been changed from time to time as developments have taken place and the RCA engineers have always given their assistance to the Committee. The Radio Manufacturers Association has submitted to you a set of standards which is not identical with that which has been incorporated in the test transmitter in New York. The RCA is in thorough agreement with the standards submitted by the Radio Manufacturers Association and if they are accepted by the Commission RCA will incorporate these standards in the present experimental system at such time as

it becomes convenient without destroying the usefulness of the present test schedule.

The necessity for a wide transmission band for the reproduction of images has been questioned in the past. I do not believe that a single engineer now questions this basic principle. The quality of a television picture is determined by the number of picture elements. The number of picture elements determines the frequency band which must be superimposed on the radio frequency carrier. There is no short-cut and there is no compromise. Consequently we must face the fact that good television requires a wide band of frequencies. Good television can be included in a band width of 6000 kc and any reduction in that band width will reduce the quality of the picture which it is possible to transmit.

For home moving pictures the optimum viewing distance from the screen is probably of the order of four times the screen height. It has been shown that this same relationship holds for television images. Exhaustive tests with television systems and with motion pictures having detail structures equivalent to television show that with a viewing distance of four times the image height in order to have sufficient detail, approximately 440 lines are necessary. Less detail than this will result in unsatisfactory viewing conditions as regards image structure; the scanning lines, for example, will become visible and bothersome. Greater detail (more lines) than this will permit closer viewing distances with satisfactory characteristics.

Using this number of lines and the other standards the maximum video frequency band width can be calculated. This calculation when carried through shows that 2,500 kc is necessary. With maximum video frequency of 2,500 kc the communication band with both side bands naturally becomes 5,000 kc. For practical receiver designs a guard band between the maximum video frequency of the upper side and the sound carrier should be 750 kc. Also the guard band between the maximum video frequency of the lower side band and the sound carrier of the adjacent channel should be 250 kc. Thus we have a 6000 kc channel.

In order to radiate a radio frequency modulated with this band width it is necessary to use frequencies for carriers which have the characteristics such that they can be radiated from an antenna system. It is now accepted by all engineers that this can be done only on frequencies above 30,000 kc and it is in that

location that the RMA Committee has made recommendations for the location of television.

During the past several years the Federal Radio Commission and the Federal Communications Commission have reserved the band of frequencies between 42,000 and 86,000 kc (except 56,000 to 60,000 kc) for television experimentation. We believe that approximately this amount of space should continue to be reserved for television and that other services should not be permitted to make inroads in this band and thus limit the space available for television. We are in accord with the limits proposed by the Radio Manufacturers Association that the space 42,000 to 90,000 kc (except 56,000 to 60,000 kc) be reserved for television. A space of this approximate width is the very minimum which should be allocated. Many people look on this amount of frequency space as being an extremely large amount to be assigned to a single service. The Commission must make a decision that television must either be eliminated or encouraged to go on. The allocation of insufficient frequencies for its development will be tantamount to its elimination. The expenditures which will be required to develop a system of television capable of serving even the major cities of the United States will be so great that unless there is promise in the beginning that there is opportunity for full development I do not believe that any company can afford to continue to take a chance in this development.

In the frequency band recommended for television only seven stations are possible in any one interference area. Using New York City as an example it is questionable whether or not a single transmitter on the highest building in New York can give an acceptable television service to all of New York and its surrounding suburban areas. Such a station has a service range of from 20 to 30 miles but it has an interference range of perhaps 200 miles. That means the same frequency could not be repeated in New York and Boston or New York and Philadelphia. When one considers the concentrated population in the large population centers in the eastern part of the United States it is obvious that seven frequency assignments can be used up and still not give complete service to all the large centers of population. Even with seven frequencies assigned it will be extremely difficult to provide for competitive programs.

So although we are talking of a frequency band nearly 50,000 kc wide it is still much too small to meet the needs of the large



metropolitan areas. It is quite probable that some methods may be used by which it is possible to include a slightly larger number of stations within a given area within this frequency band. There is a possibility of dealing with both power and height of antenna and it will probably be possible to define fairly clearly the service area of a station. The suggestion has been made that the carrier frequencies of television stations operating on the same channel be staggered so that the carrier waves of stations on the same channel be not identical. This may reduce the necessary geographical separation between stations on the same channel. However, this is full of conjecture and we cannot be sure until more measurements and more observations are made.

Another possibility is that a portion of one side band can be completely eliminated and more space made available for useful radiations from stations. In the experimental work several years ago it was learned that carrier and one side band would satisfactorily convey the picture information. Experimental and analytical work confirmed this and indicated limits and operating conditions. As picture detail increased it became apparent that an economical receiver design would be such as to receive carrier and only one side band. Since dropping or attenuating one side band is satisfactory for the transmission of the picture and since this results in the most economical receiver (provided certain design considerations are taken into account), this is naturally the way our development program has progressed. At present no method is known of designing a practical transmitter for completely eliminating one side band. It is, however, possible in the transmitter and receiver to favor one side band and to partially attenuate the other.

Future development may indicate how to obtain sufficient reduction in the lower television side band so as to permit placing the sound carrier of the next lower channel closer to the television carrier of the channel under consideration than that indicated in the above discussion of a 6000 kc channel. This, however, is a future development which may result from experience with television systems. If later it is found possible to operate television transmitters with essentially carrier and one side band, then it may be possible to reduce the 6000 kc channel, provided that receivers from the start have been built to accept carrier and one side band. This condition may be met since a logical receiver design would result in such characteristics. Such a later rearrangement would not affect existing receivers and

strengths in outlying territories where interference levels are likely to be lower.

Experience indicates that a field intensity of at least 5 millivolts per meter is required to give primary television service in an average residential district. In no case will a field strength less than 1 millivolt per meter give satisfactory performance even in an electrically quiet location. At signal levels less than this the receiver hiss becomes objectionable in the reproduced image.

The developments in Europe should be given more or less weight. England, France, Germany and Holland are all carrying on experimentation in television transmission. All of these countries are centering their attention on frequencies between 40,000 and 50,000 kc. While mutual interference or mutual conflict between the assignments in this country and the assignments abroad is impossible, it is always desirable to have all nations working within the same band of frequencies for the same service. The International Radio Conference in Cairo undoubtedly will attempt to standardize the frequency band to be allocated for television. The weight of the European opinion will be to start at some place in the vicinity of 40,000 kc. If we are out of line with that desire then it will be necessary for us to present strong reasons for them to change. If, however, we are within the same general range then the band can be standardized. This simplifies the problem of building interchangeable television receivers.

Concerning the method of distribution of television programs, there is no wire network at present capable of transmitting the broad bands necessary for television. The developments of the American Telephone and Telegraph Company with respect to coaxial cables are very interesting, but we are far from the realization of a network of such cables. It may be possible and practicable to use a radio distributing system. The feasibility of such a system was demonstrated as a part of the test from the Empire State Building in 1932 and 1933 at which time television programs were relayed from the Empire State Building via Arney's Mount, N. J., to Camden, N. J., with satisfactory results. The R. C. A. Communications, Inc., has under experiment an ultra-high frequency radio channel between New York and Philadelphia. Its television application has not been developed as yet. Whether the system of distribution of program will be by wire or radio cannot be answered at this time, but it is very

probable that radio frequencies will be used as a means of transporting television programs between centers of population.

Another use of radio frequencies accessory to television service is that of supplying programs of current events as they happen. It has been freely stated that when television comes it will be possible for people to sit in their homes and see and hear the President of the United States take his oath of office and deliver his inaugural address and to see as well as hear descriptions of the major sporting events. To get the events from the point at which they take place to the transmitter requires some means of transportation. In the operation of a broadcast station today there are frequencies available for picking up events and relaying them to wire line terminals from which they are carried by wire to the transmitters. Again, no such possibility exists in television. Space should be provided for picking up and transmitting sight programs by radio. At the moment this could be done in the television band, but when full use is made of this band then other space must be provided for this pick-up service.

The Radio Manufacturers Association has recommended that additional bands of frequencies above 120,000 kc be allocated for television research. We concur in this recommendation. In the early stages of development in the band 42,000 to 90,000 kc these additional bands above 120,000 kc could be used for short distance relaying of programs such as is done in sound broadcasting. As equipment is developed which is capable of giving public service in these bands proper permanent provision can be made for pick-up service. It is all part of the same system and can be incorporated in an integrated whole.

We realize that this presentation is sketchy and full of estimates and approximations. However, we just haven't advanced far enough to do anything else. The RCA expects to be able to answer many technical questions more definitely within the next few months. We ask now that sufficient space be reserved in the frequencies which we believe to be suitable for television in order that television may be made available in the United States. When and if television is far enough advanced to receive general acceptance, its development should not be hampered by the necessity of displacing other services.

We submit a list of papers on television which have been prepared and published by the engineers of the RCA. These papers contain much of the details of the tests which have been carried on in the past and a great deal of information concerning the propagation of radio waves in frequencies above 30,000 kc.

# A STUDY OF THE PROPAGATION OF WAVELENGTHS BETWEEN THREE AND EIGHT METERS

BY

L. F. JONES

(RCA Victor Company, Inc., Camden, New Jersey)

*Summary*—A description is given of the equipments used in an airplane, dirigible, automobile, and indoors to measure the propagation characteristics of wavelengths between about three and eight meters. The majority of observations were of television transmissions from the Empire State building.

The absorption of ultra-short-waves traveling through or around large buildings is shown to be in terms of amplitude about 50 per cent every 500 feet for seven meters and 50 per cent every 200 feet for three meters. A number of reflection phenomena are discussed and the influence of interference patterns on receiving conditions is emphasized. It is shown that any modulation frequency is partly or completely suppressed if propagation to the receiver takes place over two paths differing in length by half of the hypothetical radio wavelength of the modulation frequency. For a good television picture this corresponds to a difference of about 500 feet.

Various types of interference are mentioned. There are maps of the interference patterns measured in a typical residential room. The manner in which traffic movements cause severe fluctuations in ultra-short-wave field strengths at certain indoor points is shown by recorded field strengths.

It is shown that the service range of the Empire State transmitters includes most of the urban and suburban areas of New York, and that the interference range is approximately 100 miles. Variations of field strength with altitude, beyond line of sight, are shown. Observations made at a distance of 280 miles are described.

An empirical ultra-short-wave propagation formula is proposed. Curves are then calculated showing the relations between wavelength, power, range, attenuation, and antenna height.

## INTRODUCTION

ULTRA-SHORT waves are being widely applied experimentally to radio communication and broadcasting, and already have limited commercial application.<sup>1</sup> Undoubtedly the commercial utilization of these waves will increase rapidly. For the intelligent application of any band in the radio-frequency spectrum, the propagation characteristics of that band must be known. To learn such characteristics, the RCA Victor

<sup>1</sup> Beverage, Peterson, and Hansell, "Application of frequencies above 30,000 kilocycles to communication problems," Proc. I.R.E., vol. 19, pp. 1313-1333; August, (1931).

Reprinted from the Proceedings of the Institute of Radio Engineers.

Company, working jointly with RCA Communications, Inc., and the National Broadcasting Company, have investigated and are investigating the characteristics of wavelengths below ten meters. Others have experimented extensively on the same subject.<sup>2</sup>

Although the terms "ultra-short wave" and "ultra-high frequency" probably indicate a very wide band, from millimeters or centimeters to an upper wavelength limit of eight or ten meters, the range from about three meters to eight or ten meters will likely receive wide application prior to the still shorter waves. Transmitting and receiving equipment for operation on wavelengths below several meters is being developed by a number of investigators, but the necessity of parting from the more conventional radio practices retards commercialization of these wavelengths. The paper by Beverage, Peterson, and Hansell<sup>1</sup> shows that wavelengths higher than seven or eight meters are occasionally reflected from the Heaviside layer. The present paper deals only with the propagation characteristics of wavelengths between about three and eight meters. Probably wavelengths of eight to twelve meters have similar propagation characteristics to the shorter ones, except that sky wave reflections may be experienced during certain years of the eleven-year sun cycle, especially in the middle of the day. This may not prevent these waves from being widely used for some types of local communication.

#### PRELIMINARY TESTS

Early in 1930, Dr. Haigis<sup>3</sup> developed low power ultra-short-wave apparatus and conducted limited propagation experiments. Since the fall of that year various transmitters operating on wavelengths down to three meters have been manufactured and sold for special purposes.

Measurements made in 1930 of the coverage of a transmitter of several hundred watts power operating on about six meters, located 120 feet above the street level in Camden, indicated that valuable broadcast services could be rendered by ultra-short-wave transmitters. Television was partly in mind in view of the impossibility of securing adequate channel widths on higher

<sup>2</sup> E. Karplus, "Communication with quasi optical waves," *PROC. I.R.E.*, vol. 19, pp. 1715-1730; October, (1931); Fritz Schroter, "Concerning the question of ultra-short-wave broadcasting," *Elec. Nach. Teck.*, vol. 8, no. 10, pp. 431-437, (1931). (In German); J. R. Jouaust, "Some details relative to propagation of very short waves," *PROC. I.R.E.*, vol. 19, pp. 479-488. March, (1931).

<sup>3</sup> Then with RCA Victor Company, Inc.

wavelengths and of eliminating the effects of sky reflections. Later, under the direction of Mr. R. D. Kell, the transmitter power was increased to one kilowatt, and more extensive observations were made in the Camden-Philadelphia territory.

Activities were then transferred to New York, where the preponderance of steel buildings, the remote locations of the suburbs, and the large amount of automobile ignition interference were expected to make most conditions of reception as severe as will be found in any American city. A fifty-watt transmitter was installed on the RCA Building at 51st Street and Lexington Avenue, the antenna being 650 feet above street level.

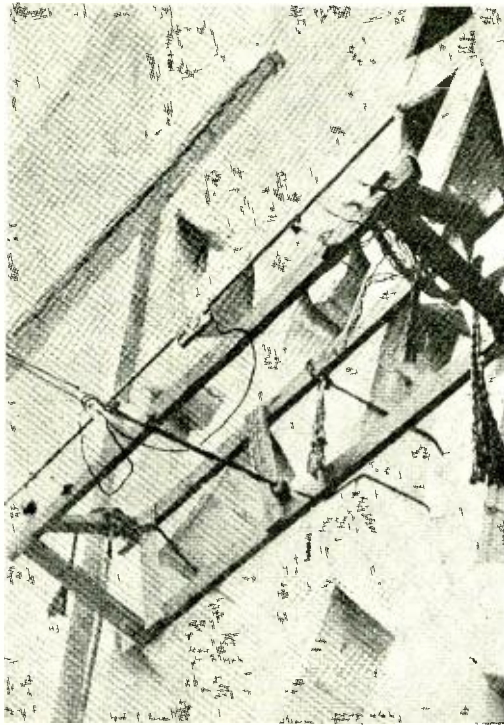

Fig. 1—Horizontal half-wave antenna.

A vertical half-wave antenna was used for the majority of the observations, and transmission was conducted on 3.5, 5, 6.5, and 8.5 meters. Observations were made in all directions inside and outside of buildings, and at distances up to thirty miles. It seemed advisable before making many observations to compare several antenna locations on the roof so that the optimum might be used

for propagation measurement purposes. Six antenna positions were tested in the tower that constitutes the topmost portion of the RCA Building. This tower is hollow, about forty feet in height, and is made of a latticework of stone and bricks that include many openings for artistic purposes. Fig. 1 shows one of the arrangements, where the antenna was placed horizontally within the hollow tower. Fig. 2 shows the final antenna location used for the tests. Differences between horizontally and vertically polarized waves appeared of little importance, but locating the antenna high enough to be practically clear of the surrounding stone work, as shown in Fig. 2, gave an increase in field strength of several hundred per cent. Absorption in the lattice stone work was very great for antenna locations such as shown in Fig. 1.

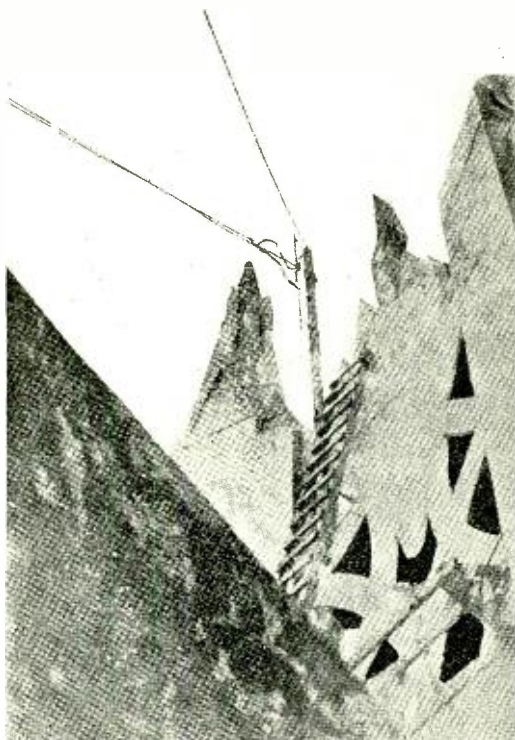

Fig. 2—Final antenna for RCA building test.

The propagation data gained from these preliminary Camden and New York tests were later enhanced by quantitative measurements made of transmission from the Empire State Building.

## EQUIPMENT FOR EMPIRE STATE TESTS

*Transmitting Equipment*

Preliminary tests made with a portable ultra-short-wave transmitter located on the top of the Empire State building had shown the superiority of the 1300-foot altitude of this building over the 650 feet of the RCA building, and for this and other reasons space was secured on the 85th floor for the installation of television transmitters and studios. A picture transmitter operating on a frequency of forty-four megacycles (6.8 meters) with about two kilowatts output, and sound transmitter operating on sixty-one megacycles (4.9 meters) with an output of about one kilowatt, were installed in July of 1931. Each transmitter was coupled through a 275-foot concentric tube transmission line to its antenna. Fig. 3 shows the antennas used for the propagation measurements. Each antenna was a half wavelength

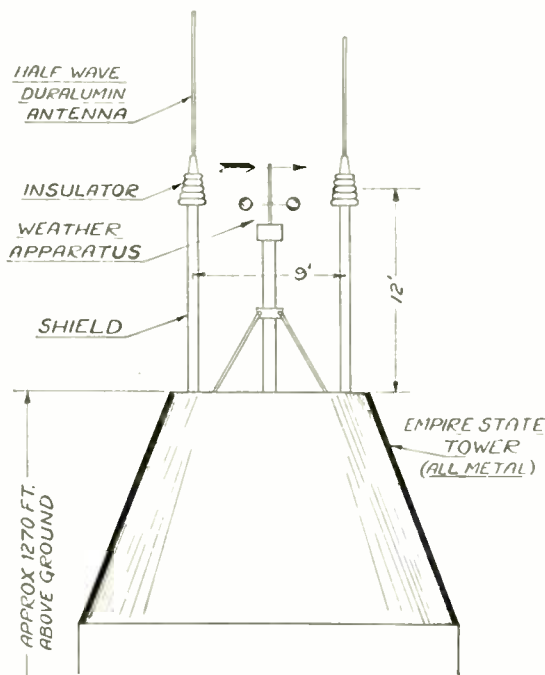

Fig. 3—General layout of Empire State building antennas.

long and was made of one and one-quarter inch duralumin rod. The antennas were elevated above everything else, their bases being at about the same level as the top of the weather apparatus. In fact, the antennas were the highest structures above ground



level ever erected anywhere. The antennas were spaced nine feet apart which rendered a reasonably small reflection effect of the one on the other.

The transmitters utilized precision quartz crystal oscillators, driving their respective power amplifiers through doubler and tripler stages. Each transmitter was modulated in its power amplifier stage, up to 100 per cent. Antenna currents as indicated by commercial thermocouple meters were about seven amperes, and five amperes on forty-four and sixty-one megacycles respectively, and are thought to indicate powers of about two kilowatts and one kilowatt.

### *Receiving Equipment Used*

Observations of the Empire State radiations were made by airplane, autogiro, dirigible, and automobile. The airplane observations were made by Bertram Trevor and are discussed in a separate paper.<sup>4</sup>

The measuring equipment used for the majority of observations consisted of a high sensitivity receiver of the superheterodyne type using detector, oscillator, three stages of six-megacycle intermediate-frequency amplification (using pentodes) and second detector. This receiver was developed and calibrated under the direction of Mr. G. L. Beers of the research division. An indicating microammeter, with bucking battery, was in the second detector plate circuit. Several stages of audio amplification followed for operating a loud speaker for the sake of convenience during certain tests. When used in an automobile the receiver was mounted on the rear seat and coupled to a half-wave vertical antenna. The receiver was calibrated by inserting a resistance of known value in the center of the half-wave receiving antenna, and by inducing therein a current of known value from a signal generator. This calibration was checked by other measurements. Although they checked reasonably closely, it is probable that considerable calibration error existed. The equipment was calibrated for field strengths between twenty microvolts and ten millivolts per meter, on frequencies between forty and eighty megacycles. To measure field strengths higher than ten millivolts a low sensitivity loop receiver, shown in Fig. 5, was constructed. It was a simple push-pull rectifier and covered the range from 10 to 400 millivolts. Both receivers were portable

<sup>4</sup> Bertram Trevor and P. S. Carter, "Notes on the propagation of wavelengths below ten meters in length," presented before November 2, 1932, New York meeting. PROC. I.R.E., this issue, pp. 387-426.

and were frequently carried from the automobile to the insides of buildings and residences.

The equipment used in the dirigible was the loop set described above for low sensitivity usage, except that the loop antenna was replaced by a half-wave wire fastened to a bamboo pole. As shown in Fig. 4, this pole was held by the observer sitting near an open door of the cabin and it could be held in any position desired. During flight maximum field strength indication was generally obtained by holding the antenna in a vertical position.

In the autogiro the field strength meter and altimeter were mounted together in front of a sixteen-millimeter movie camera, which was focused on the meters. Thus simultaneous recordings of altitude and field strength were readily made photographically. The Paulin altimeter was used in preference to any other type because there is a negligible time lag in the reading. A single-wire antenna as usually used with the field strength set was passed over the side of the cockpit, and during the descent of the autogiro hung very nearly vertically below the fuselage.

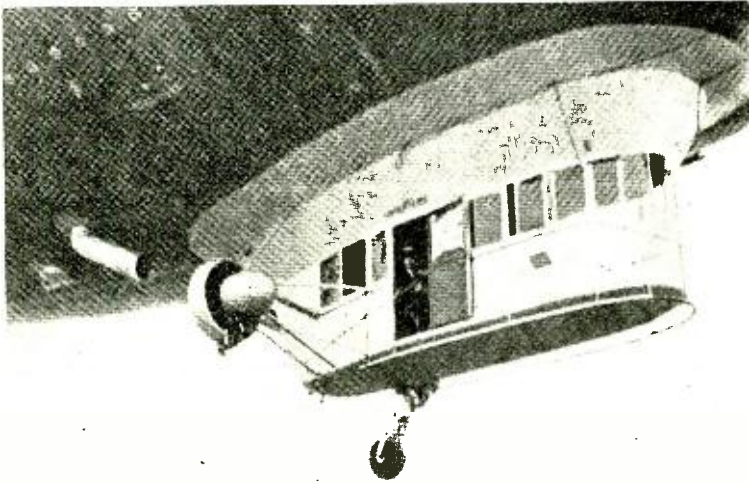

Fig. 4—Test in dirigible *Columbia*.

#### PROCEDURE

The phenomena particularly observed were attenuation, interference patterns, interference noises, service range, interference range, signal fluctuations, and local receiving conditions.

Measurements were made by Messrs. Gihring and Turner along radials from the Empire State building in all directions except where water intervened. Two of the radials extended to 100 miles and another to 130 miles. In all cases interference patterns were found to be very common, and the field strength at any point was therefore considered as the average of five minimum and five maximum readings as the car was driven through five suc-

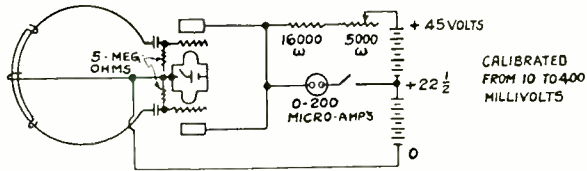

Fig. 5—Circuit used in low sensitivity loop receiver.

cessive minima and maxima. Several observations were made at a distance of 280 miles.

Readings were taken inside of suburban homes, city office buildings, and apartment houses. Fluctuations found on the first floors of city buildings were studied by attaching a recording microammeter to the measuring set so that continuous records of the fluctuations would be available. Television receivers were located in about twenty-five residences or apartments, both in the city and in suburbs, to ascertain the signal strengths required for television reception and to observe the effects of different types of interference.

The autogiro tests were made about sixty miles southwest of New York and were for the purpose of determining variation of field strength with altitude. It was useful for this particular purpose because with its motor shut off it could descend almost vertically. Descent of the ship was fairly regular with no appreciable swaying of the antenna. To eliminate ignition interference the motor was turned off during each descent, a dead-stick landing being made.

Tests in the dirigible *Columbia* were made to study signal variations directly above New York City. Various measurements were made at altitudes from 3000 feet down to 40 feet. Unfortunately, the data obtained are of doubtful utility due to the reflection of the received wave from the metal cabin of the ship and to excessive ignition interference.

## ATTENUATION

Fig. 6 shows the average signal strength of the forty-four-megacycle Empire State signal to 130 miles, and Fig. 7 shows the same for sixty-one megacycles. These curves represent the averages of measurements in several directions. The locations of the points of measurement at distances less than about thirty

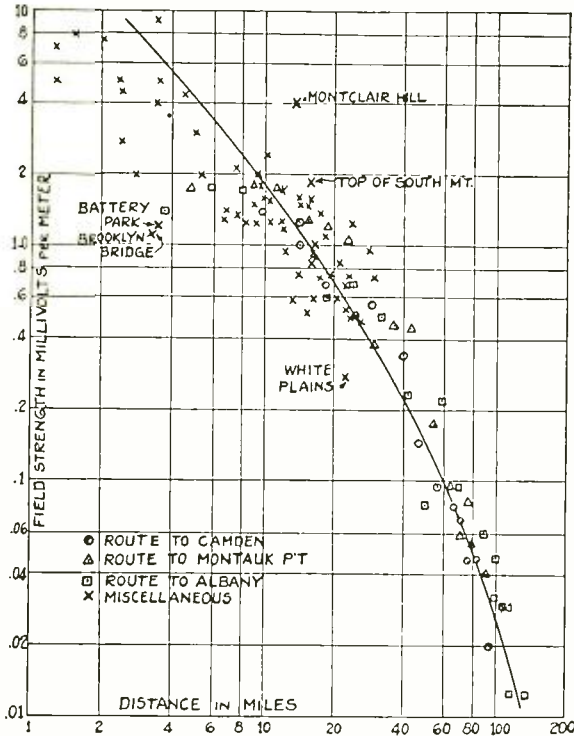

Fig. 6—Attenuation of 44-megacycle signals from Empire State building.

miles were chosen at random and correspond to average outdoor conditions. The points beyond thirty miles however were selected with an eye to elevation, since the maximum receiving distance was being considered, and therefore the field strengths for these points are somewhat optimistic. It is seen from Figs. 6 and 7 that the field strength within several miles of the transmitters is more variable than at greater distances. The diversity of the near-by measurements indicates that multistory steel-reinforced buildings have more influence on the field strength in the street than do the two- or three-story brick and frame houses farther away. On each of the three routes that extended 100 miles or

more, the forty-four-megacycle signal was heard to the end of the route whereas the sixty-one-megacycle signal was lost between seventy and ninety miles.

As mentioned above, each reading consisted of the average of about five maximum and minimum indications at any one location. If the maximum and minimum readings for any one loca-

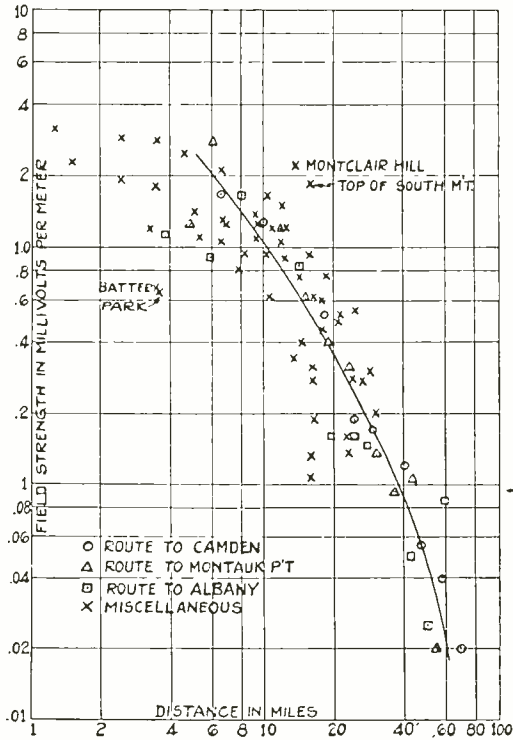

Fig. 7—Attenuation of 61-megacycle signals from Empire State building.

tion are compared to their average, a certain percentage of variation will be indicated. When these “percentage variation” or “percentage deviation” values are plotted for all distances measured, no correlation is found. In other words, the maxima and minima of the interference patterns are approximately as severe at great distances as at small distances. The mean “percentage variation” is sixteen per cent for forty-four megacycles and thirty-seven per cent for sixty-one megacycles. This apparently indicates, as expected, that sixty-one megacycles is more efficiently reflected than forty-four megacycles and that the sixty-

one-megacycle interference pattern is therefore more pronounced.

Fig. 8 shows the variation of signal strength with distance for the first several blocks from the Empire State building. The maximum signal strength exists approximately three blocks from the Empire State building. The low field intensity existing immediately adjacent to the building is probably caused by the small amount of energy radiated downward by a vertical half-wave antenna.

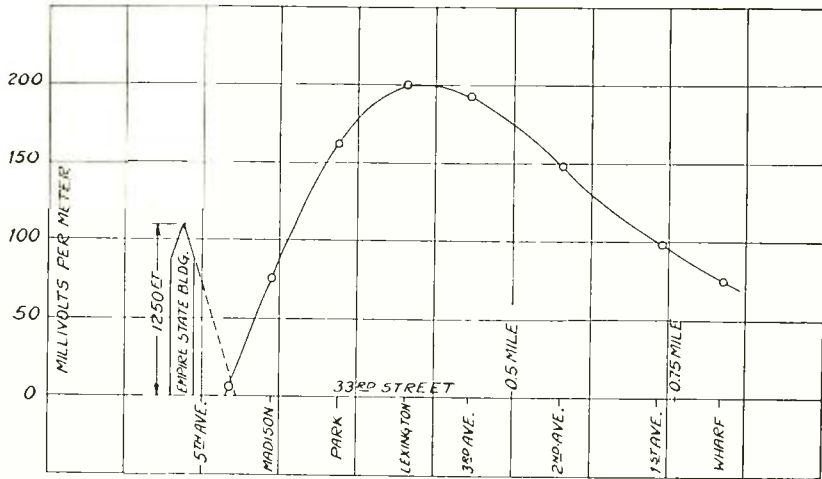

Fig. 8—Field strengths immediately adjacent to transmitter.

Observations made within buildings indicate considerable attenuation as the signal enters the building. Inside field strengths were from  $1/2$  to  $1/200$  of the field strengths immediately outside. (Refer to Figs. 15, 16, and 17, discussed below under "Reflections.") At the center of a number of large business buildings there was practically no signal. In such cases, at the side of the building toward the transmitter the signal increased, and similarly at the side of the building away from the transmitter the signal increased. The presence of a good signal on the side of a large building away from the transmitter when no signal could be heard in the center of the building indicated complete absorption of the wave by the building and fairly effective reflection from other surrounding buildings. To check this the receiver was taken to the top of the Woolworth tower. In that case, the signal inside the tower was zero, on the outside of the tower towards the transmitter the signal was very strong,

and on the outside of the tower away from the transmitter the signal was zero. This checked with predictions since there are no buildings high enough and near enough to the Woolworth tower to reflect south traveling waves on to the south side of the tower. All observations seemed to show that ultra-short waves were considerably diffused when they reached the buildings of a metropolitan area. This general diffusion or dispersion is probably fortunate since it provides signals on the "shadow" sides of buildings, just as light enters through a window not exposed to the sun.

Observations from the RCA building transmitter were on wavelengths of 3.5, 5, 6.5, and 8.5 meters. The lesser absorption of the longer waves was clearly observed, also their greater ability to diffract. Behind hills the 6.5- and 8.5-meter waves

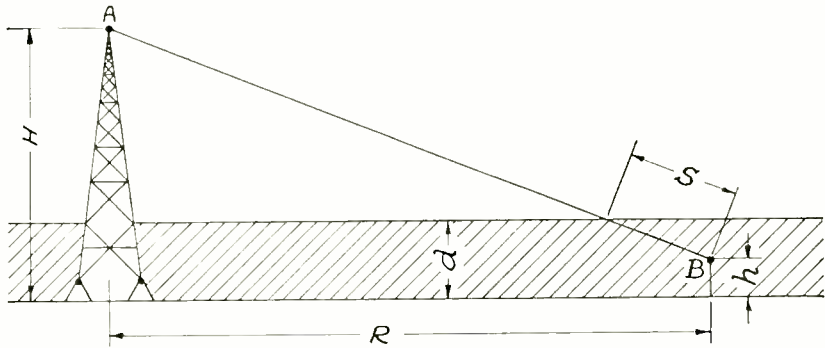

Fig. 9

could be heard fairly well whereas a definite "shadow" would exist for some distance for the 3.5-meter signal. Other experiments were conducted from the RCA building to compare vertical with horizontal polarization but no definite conclusions were reached.

#### *Attenuation Formula*

It was observed that at such points as Battery Park, where a large number of steel buildings project themselves between the transmitting and the receiving antennas, the readings were extremely low as compared to readings taken where line-of-sight exists between antennas.

An empirical measure of this attenuation caused by large buildings was obtained in the following manner. A practically identical method was used by Fritz Schroter.<sup>2</sup> Referring to Fig.

9,  $H$  is the height of the transmitting antenna,  $h$  is the height of the receiving antenna,  $R$  is the distance between transmitter and receiver, and  $d$  is the height of the absorbing layer. In the case of Manhattan the absorbing layer consists of an agglomeration of large and small buildings.  $S$  is the portion of the propagation path in which the wave must travel through or around buildings. We may assume that field strength varies inversely as the distance between the transmitter and receiver and that it has an additional attenuation, equal to  $e^{-\alpha S/\lambda}$ . The justification for using unity as the exponent for  $\lambda$  is discussed near the end of this paper. The attenuation constant is most conveniently evaluated by comparing field strengths measured under various conditions of  $R$  and  $h$ .

$$E_1 = \frac{K}{R_1} e^{-\alpha S_1/\lambda} \quad E_2 = \frac{K}{R_2} e^{-\alpha S_2/\lambda}$$

$$\frac{E_1}{E_2} = \frac{R_2}{R_1} e^{(-\alpha S_1/\lambda) - (-\alpha S_2/\lambda)} = \frac{R_2}{R_1} e^{\alpha(S_2 - S_1)/\lambda} \quad (1)$$

$$\log_e \frac{E_1}{E_2} = \log_e \frac{R_2}{R_1} + \alpha \left( \frac{S_2 - S_1}{\lambda} \right)$$

$$\alpha = \frac{\log_e \frac{E_1}{E_2} - \log_e \frac{R_2}{R_1}}{\frac{S_2 - S_1}{\lambda}} = \frac{\log_e \frac{E_1 R_1}{E_2 R_2}}{(1/\lambda)(S_2 - S_1)} \quad (2)$$

It is obvious that  $S_1 = R_1(d_1 - h)/(H - h)$  and  $S_2 = R_2(d_2 - h)/(H - h)$ , the refraction being negligible. Therefore, substituting in (2):

$$\alpha = \left( 2.303 \log_{10} \frac{E_1 R_1}{E_2 R_2} \right) \left( \frac{\lambda}{\frac{R_2(d_2 - h)}{H - h} - \frac{R_1(d_1 - h)}{H - h}} \right)$$

$$= \left( 2.303 \log_{10} \frac{E_1 R_1}{E_2 R_2} \right) \left( \frac{\lambda(H - h)}{R_2(d_2 - h) - R_1(d_1 - h)} \right) \quad (3)$$

If  $\alpha$  is to be evaluated on the basis of  $S$  and  $\lambda$  of (1) being expressed in kilometers, as is customary, (3) becomes:

$$\alpha = \left( 7550 \log_{10} \frac{E_1 R_1}{E_2 R_2} \right) \left( \frac{\lambda(H - h)}{R_2(d_2 - h) - R_1(d_1 - h)} \right) \quad (4)$$

where  $H$ ,  $h$ ,  $R_1$ ,  $R_2$ ,  $d_1$ , and  $d_2$  are expressed in feet.



TABLE I  
EVALUATION OF ATTENUATION CONSTANT.  $H=1300$  ft.  $h=8$  ft.  $\lambda=7$  meters.

Location	$R$	$d$	$E$	$\alpha$
86th and 5th Ave.	13700	20	12.5	
86th near 5th Ave.	13700	150	2.5	0.027
81st and Central Park West	12600	20	15	
73rd and Park Ave.	10500	100	7.5	0.031
14th and 10th Ave.	6600	100	4.5	
Battery Park	18500	300	1.0	0.029
Theoretical <sup>b</sup>	5280	0	20	
Several three-mile readings	15840	150	2	0.016
24th St.—Roof	3160	0	70	
24th St.—Street	3160	150	30	0.055

TABLE II  
EVALUATION OF ATTENUATION CONSTANT.  $H=1300$  ft.  $h=8$  ft.  $\lambda=5$  meters.

Location	$R$	$d$	$E$	$\alpha$
24th St.—Roof	3160	0	50	
24th St.—Street	3160	150	20	0.043
42nd St.—High balcony	4000	0	50	
42nd St.—Street	4000	150	25	0.026
80th St. and 1st Ave.	12700	100	1.9	
Battery Park	18500	300	0.65	0.024
42nd St.—High balcony	4000	0	50	
Jericho Turnpike	98000	30	0.4	0.016

<sup>b</sup> Calculated for line-of-sight at one mile.

Table I shows the attenuation constants derived from forty-four-megacycle field strengths received at eight New York points. It is seen that the attenuation constants obtained vary between 0.015 and 0.055, with 0.032 as the average value. Table II shows a similar set of data for sixty-one megacycles, the average value indicated being about 0.028. With due recognition of the several approximations involved, we may assume that an attenuation constant for the propagation of ultra-short waves through or around large buildings placed rather closely together is in the order of about 0.03 when used in (1). For seven meters this corresponds to an attenuation of about thirty-seven decibels per 1000 meters, or an attenuation in carrier amplitude of 50 per cent every 500 feet. For three meters this corresponds to an attenuation of 50 per cent every 225 feet. Of course this attenuation only applies to the distance through which propagation takes place in the absorbing area " $d$ ," and is in addition to the field strength decrease, that is, inversely proportional to the distance from the transmitter.

## REFLECTION

During propagation a radio wave always experiences attenuation, sometimes a change in polarization, and usually a certain amount of diffraction or other phenomenon changing the direction of travel. The more common phenomenon causing deviation of the direction of propagation are reflection, diffraction, and refraction. All may be grouped under the general heading of deflection.

Reflection may be of two types, diffused and specular. Diffused reflection is the throwing back of a wave by a surface having irregularities large compared to the wavelength. In specular reflection, the surface is smooth, with irregularities small compared to the wavelength. Diffraction is the deviating of a wave due to its finite size such as when the wave is partially cut off by an obstacle or passes near the edge of an opening. Refraction is the deviating of a wave as it passes through a medium of variable characteristics, wherein the velocity of propagation of some portions of the wave front are slower or faster than that of other portions. Another possible effect is scattering. Scattering is the dispersing of a wave in many directions by an object small compared to the wavelength.

In the case of ultra-short waves it will be shown below that the first of these phenomenon, reflection, is very common, both inside and outside of buildings. The extent to which diffraction and refraction take place should not be prophesied until more extensive data are available. The reception of five-meter signals at distances of 200 and 300 miles at points far below the line-of-sight, and reception behind hills, indicate that diffraction or refraction or both do exist to a very noticeable degree.

Returning to the subject of simple reflection, it was found that interference patterns invariably exist except where the terrain is open and flat. They are frequently caused by reflections from relatively near-by objects. In many cases they are so severe that excellent signals will be received in "live spots" whereas several feet away from these spots no signal can be heard. The general occurrence and severity of interference patterns on these wavelengths is of great importance in the design of antennas for ultra-short-wave broadcast reception. The question of receiver antenna design is not discussed in this paper. The existence of an interference pattern infers reception over two or more paths of propagation. If the paths of propagation are sufficiently different in length, a distortion phenomenon sim-

ilar to the distortion in ordinary selective fading will take place. In the case of television, where very high modulation frequencies are used when transmitting pictures of fine detail, the difference of path length that will produce distortion is surprisingly small.

If a transmitter working at the carrier frequency  $f$  is sinusoidally modulated by an audio frequency  $q$ , with modulation factor  $k$ , the radiated signal is

$$Y = A \sin 2\pi ft(1 + k \cos 2\pi qt).$$

As is well known this may be written

$$Y = A \sin 2\pi ft + \frac{1}{2}kA \sin 2\pi(f + q)t + \frac{1}{2}kA \sin 2\pi(f - q)t. \quad (5)$$

We shall analyze the case where two propagation paths exist between transmitter and receiver. The direct received ray may be represented by equation (5). Then the indirect (reflected) ray, traveling over a path  $S$  units longer than the direct path, reaches the receiver at the time

$$t - \frac{S}{C}$$

where  $C$  is the velocity of light expressed in the same units as  $S$ . Thus the direct signal received is:

$$\begin{aligned} Y_0 = & A \sin 2\pi ft && \text{carrier} \\ & + \frac{kA}{2} \sin 2\pi(f + q)t && \text{upper side band} \\ & + \frac{kA}{2} \sin 2\pi(f - q)t && \text{lower side band} \end{aligned} \quad (6)$$

and the indirect signal received is:

$$\begin{aligned} Y_1 = & B \sin 2\pi f\left(t - \frac{S}{C}\right) && \text{carrier} \\ & + \frac{kB}{2} \sin 2\pi(f + q)\left(t - \frac{S}{C}\right) && \text{upper side band} \\ & + \frac{kB}{2} \sin 2\pi(f - q)\left(t - \frac{S}{C}\right) && \text{lower side band.} \end{aligned} \quad (7)$$

Assuming that the two signals are received with equal amplitude, the terms  $A$  and  $B$  may be omitted.

The condition of distortion under discussion is that where the two upper side bands arriving over the different paths arrive 180 degrees out of phase, and the two lower side bands do also, but the carriers arrive in phase. For the two upper side bands to be 180 degrees out of phase:

$$\frac{k}{2} \sin 2\pi(f + q)t + \frac{k}{2} \sin 2\pi(f + q)\left(t - \frac{S}{C}\right) = 0 \quad (8)$$

and,

$$2\pi(f + q)t - 2\pi(f + q)\left(t - \frac{S}{C}\right) = \pi, 3\pi, 5\pi, \dots = n_1\pi \quad (9)$$

Similarly, the two lower side bands cancel when:

$$2\pi(f - q)t - 2\pi(f - q)\left(t - \frac{S}{C}\right) = \pi, 3\pi, 5\pi, \dots = n_2\pi \quad (10)$$

where,

$$n_1 = 1, 3, 5, 7, \text{ etc.}, \text{ and } n_2 = 1, 3, 5, 7, \text{ etc.}$$

We are interested in the case where the difference in the lengths of the propagation paths is minimum. In this case obviously  $n_2 = n_1 - 2$  for the side bands to be 180 degrees out of phase and for the carriers to be in phase. Substituting in (9) and (10),

$$2(f + q)t - 2(f + q)t + \frac{S}{C} 2(f + q) = n_1$$

$$2(f - q)t - 2(f - q)t + \frac{S}{C} 2(f - q) = n_1 - 2.$$

Subtracting,

$$2 \frac{S}{C} (f + q - f + q) = 2 \frac{4qS}{C} = 2 \quad (11)$$

$$S = \frac{C}{2q}$$

Thus  $S$ , the minimum difference in propagation path lengths producing cancellation of a modulation frequency of  $q$  cycles per second, is the velocity of light expressed in the same unit per second as  $S$ , divided by twice the modulation frequency. Thus  $S$  is equal to half the hypothetical radio wavelength of the modulation frequency. A similar conclusion was independently reached by Hans Roder of the radio engineering department of the General Electric Company.

Now if we assume the transmission of a television picture requiring a modulation frequency of 1,000,000 cycles, which would be a picture of good detail, equation (11) shows that a difference in path length of only 490 feet will cause the side bands corresponding to the highest modulation frequency to arrive at the receiver 180 degrees out of phase, causing partial or complete cancellation of these frequencies. It should be noted that the determining factors in producing this selective distortion are not the absolute lengths of the propagation paths or the wavelength used but rather are the difference between propagation path lengths, the number of propagation paths, and the relative field strengths of the signals arriving over the several paths.

This reduction of modulation frequencies by cancellation of side bands may be explained by considering merely that a plurality of propagation paths will produce "double images." In case of greatest detail, the picture would have its elements alternately white and black. If the signal is received from two paths differing in length sufficiently so that the wave received from the longer path is just one picture element later than the wave received from the shorter path, then for every dark picture element received from one path there will be a light picture element received from the other path at the same instant. If the signals are of equal intensity the received picture will be without image and will be of an intensity half way between light and dark. Obviously the type image referred to is unusual, but it indicates that the detailed portions of any image would be lost under the specified propagation conditions. If this "double image" analysis is applied to the 1,000,000-cycle picture previously referred to it will again be found that a difference in propagation path lengths of 490 feet will produce cancellation.

If this selective distortion phenomena occurred in practice it would be a serious hindrance to television; consequently careful observations were made at a number of points to ascertain if such distortion is produced. Pictures of 120 lines were transmitted. Fortunately, no indications of decreased picture detail were found, and therefore it may be assumed that at reasonable ranges, signals seldom if ever arrive at a receiving point over two or more propagation paths differing by as much as 2120 feet, that being the minimum path difference producing distortion of a 120-line picture. No observations were made on pictures of greater detail than 120 lines. Observations conducted at ranges

beyond thirty miles were not numerous enough to make predictions regarding image distortion at long range. Additional data on reflection are discussed below under "Signal Fluctuations."

A path length difference of somewhat less than  $S$  will of course result in partial cancellation. If the carriers arrive some-

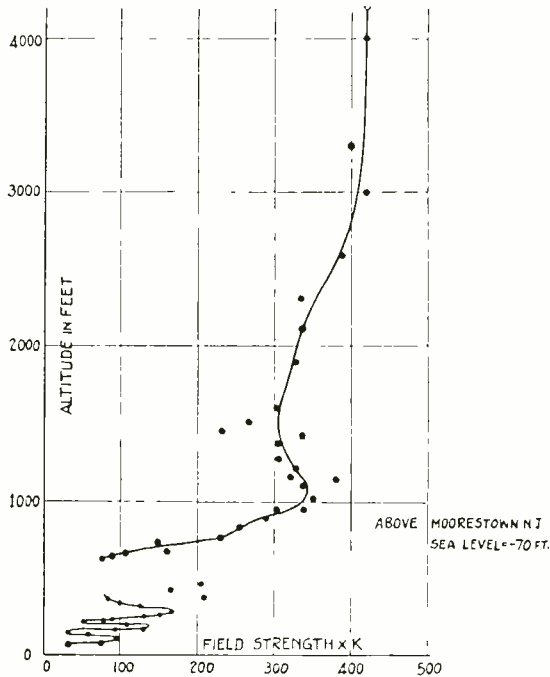

Fig. 10—Descent by autogiro over Moorestown, New Jersey

what out of phase the modulation frequency in question will not only be partly suppressed but will also be somewhat distorted. The various types of distortion that might arise will not be discussed in this paper.

When listening to the small transmitter in the RCA building an interesting type of distortion was produced by coupling the master oscillator too closely to the power amplifier. This caused excessive frequency modulation. This frequency modulation shifted the locations, at modulation frequencies, of the maximums and minimums of the interference pattern. Thus distortion would be observed when the receiver was located on certain points of the interference pattern.

Reflections within the rooms of a residence were investigated by Messrs. Koch and Grundman of the research division in connection with the design of television receiving antennas. This paper does not deal with reception, nevertheless the field strength contour lines obtained on the first floor of the residence are

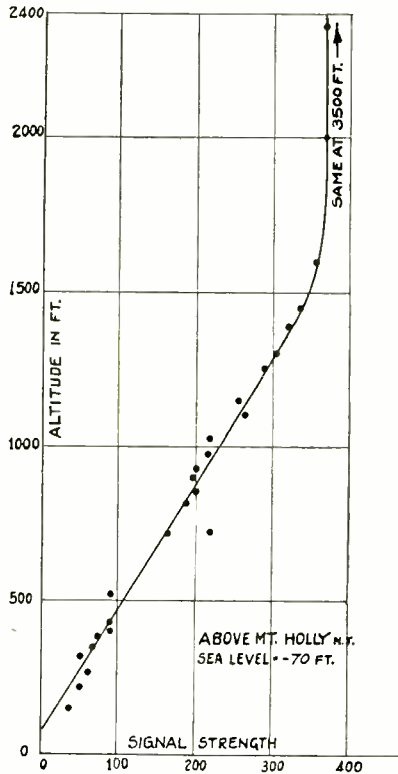

Fig. 11—Descent by autogiro over Mt. Holly, New Jersey

reproduced in Figs. 15, 16, and 17 to indicate the general intensity of reflections. The data were obtained by using a small transmitter placed one hundred feet from the residence, and a small calibrated receiver. Polarization was vertical. Fig. 15 shows contours for a transmitted frequency of fifty megacycles. In Fig. 16 the transmitter location was shifted ninety degrees. The contours within the building changed completely. In Fig. 17 the transmitter was returned to the first location and its frequency changed to seventy megacycles. Again the contours were quite different.

For all measurements made near the ground, the predominating interference is caused by automobile ignition systems. Some makes of cars can be heard at distances of several blocks, and all cars produce at least some interference. Airplanes in flight generally cause more trouble than automobiles but at most loca-

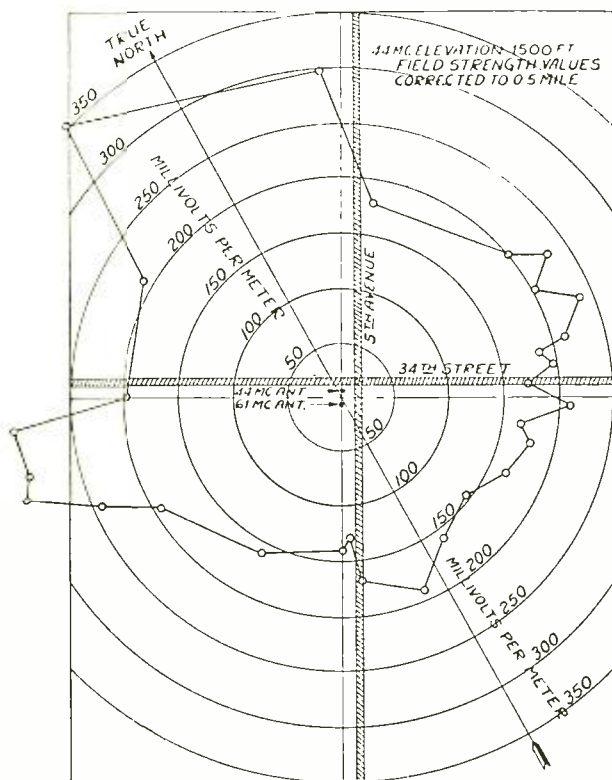

Fig. 12—Horizontal distribution of signal, 44 megacycles.

tions this type of interference is relatively rare. Telephone exchanges produce a distinct type of interference noise for a distance of several blocks. Street cars and elevated trains produce a clicking kind of interference, but often a six-car elevated train is not as troublesome as single automobiles of certain makes. Interference from automobiles is effectively suppressed by means of resistors in series with the spark plugs and distributors and condensers in shunt with the generators, but in view of the great number of automobiles now in existence without such radiation suppressors, it is probable that this type of interference will be



of prominence for a number of years. The ignition interference noise is best described as a series of short, sharp clicks. It was found on all wavelengths between three and ten meters with no apparent prominence at any one wavelength. During sound reception ignition interference is noticeable at very low level

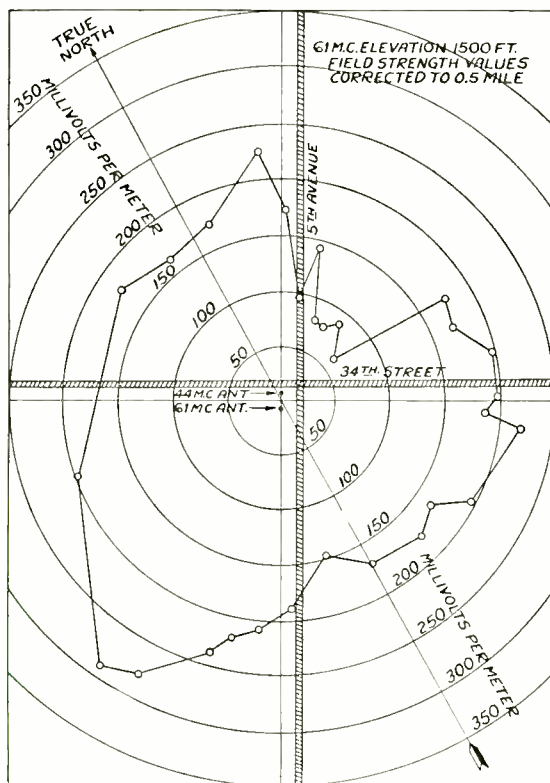

Fig. 13—Horizontal distribution of signal, 61 megacycles.

due to its unpleasant sound. During television reception black or white stripes appear across the picture.

When listening some distance above the ground, such as when on the fourth floor or higher of a large building, the ignition systems of the individual engines can no longer be differentiated and it is not known whether the general noise then heard is chiefly ignition interference or not. Elevator motors are not especially bothersome but, along with small motors, loose lighting connections, etc., cause a noticeable amount of trouble at certain locations.

Lightning struck the Empire State antennas several times when they were in operation with no effect except to produce a loud click in the output signal. Ordinary atmospheric static was not heard on ultra-short wavelengths, even during the middle of the summer, except on several occasions when lightning struck

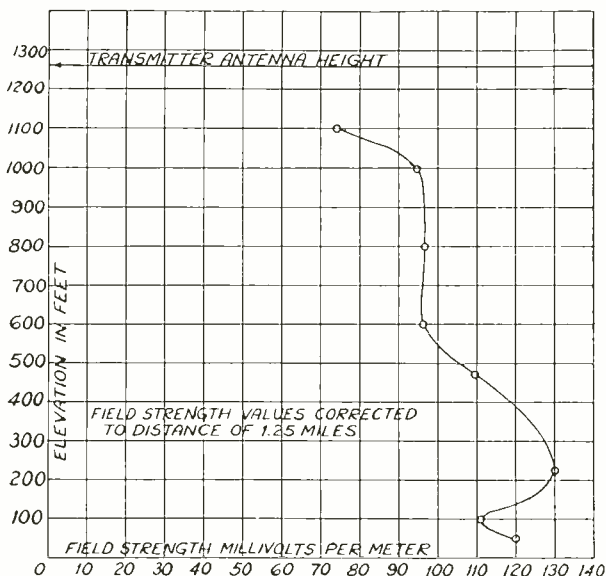

Fig. 14—Vertical distribution of signal, 44 megacycles.

within one mile of the receiving point. Then several clicks were audible.

#### MEASUREMENTS ABOVE GROUND

Fig. 10 shows measurements of field strength versus altitude, taken by Mr. C. J. Young in an autogiro over Moorestown, New Jersey. Moorestown is seventy-five miles from New York City. The field strength was practically constant from 4000 feet down to 3000, then fluctuated slightly down to 1000, and then decreased greatly during the remainder of the descent, with rapid but regular fluctuations during the last 400 feet. The causes of such relationships between field strength and altitude at distances beyond line-of-sight, and the constancy of this phenomena from day to day or from season to season, are not definitely known at this time. Fig. 11 shows the same data for the same frequency (forty-four megacycles) for a descent near Mt. Holly. Mt. Holly is sixty-four miles from New York City. In this case the signal

strength remained constant, down to about 1500 feet, then decreased more or less linearly to the ground.

It was noted from these and other measurements made at long distances that the field strength increases with altitude far

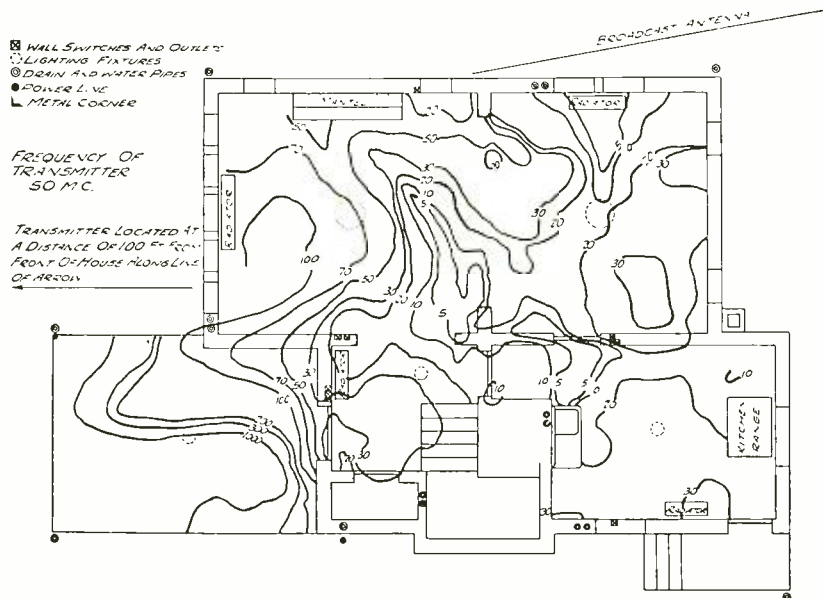

Fig. 15—Field strength within a residence, 50 megacycles.

above the altitude for line-of-sight. This indicates a marked attenuation in the direct wave when it passes close to the ground before reaching the receiving antenna. At high altitudes the field strength varies essentially inversely as the distance from the transmitter, indicating little or no absorption in propagation through clear atmosphere.

Measurements were made in the dirigible *Columbia* to explore the vertical and horizontal distribution of the field near the transmitting antennas. The ship proved somewhat unsuitable for the purpose because of the difficulty of flying in true circles, of making vertical descents, and of preventing reflections of the signals from the metal cabin. The ignition interference from one motor was very severe with the result that this motor was shut off during the test.

The horizontal distribution of the field at 1500 feet for forty-four megacycles is shown by Fig. 12 and for sixty-one megacycles by Fig. 13. Except for the possibility of the action of one trans-

- ⊠ WALL SWITCHES AND OUTLETS
- LIGHTING FIXTURES
- ⊙ DRAIN AND WATER PIPES
- POWER LINE
- └ METAL CORNER

FREQUENCY OF  
TRANSMITTER  
50 M.C.

TRANSMITTER LOCATED  
100 FT IN DIRECTION OF  
ARROW

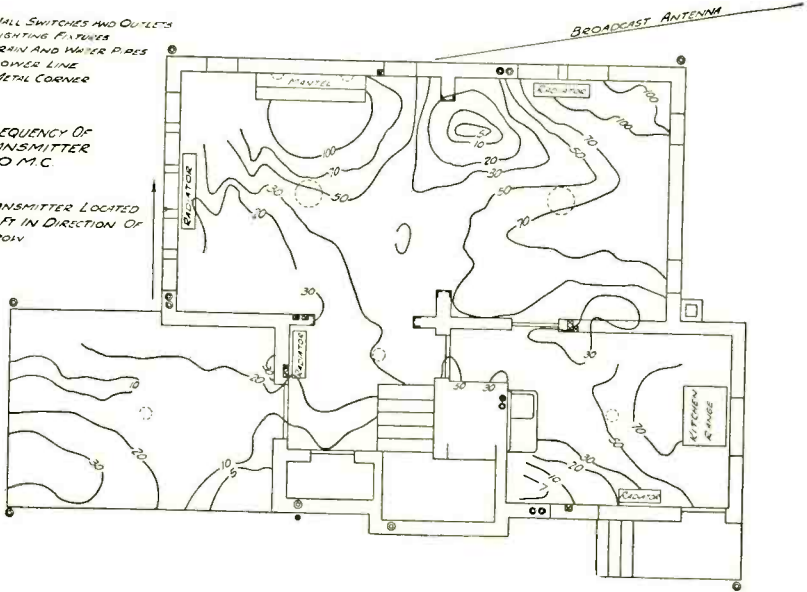

Fig. 16—Field strength within a residence, 50 megacycles.

- ⊠ WALL SWITCHES AND OUTLETS
- LIGHTING FIXTURES
- ⊙ DRAIN AND WATER PIPES
- POWER LINE
- └ METAL CORNER

FREQUENCY OF  
TRANSMITTER  
70 M.C.

TRANSMITTER LOCATED AT  
A DISTANCE OF 100 FT FROM  
FRONT OF HOUSE ALONG  
LINE OF ARROW

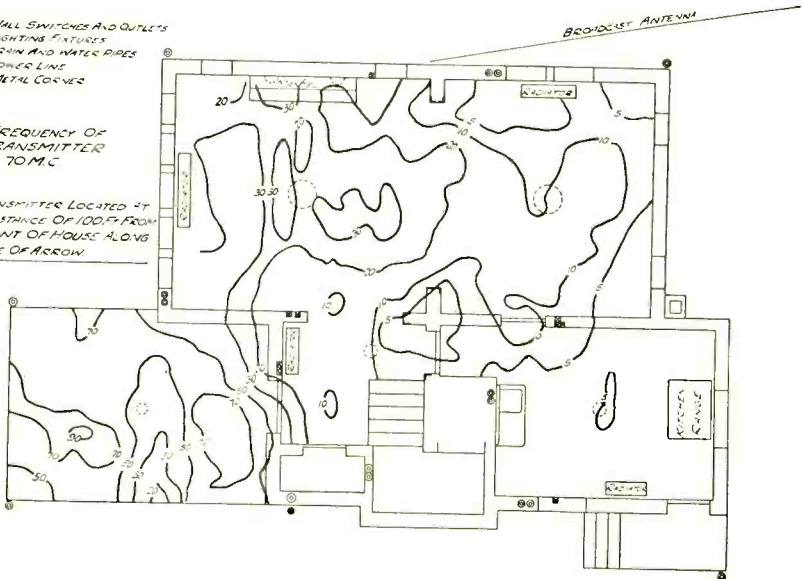

Fig. 17—Field strength within a residence, 70 megacycles.

mitting antenna upon the other, or of the weather instrument upon either antenna, the horizontal field patterns should be circles. The measured patterns are not circular but do not bear obvious relation to these reactions. An error was probably caused

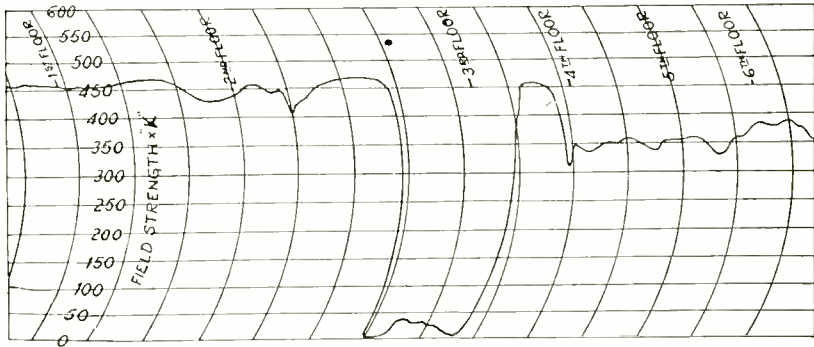

Fig. 18—Variation of field strength with elevator position.

by the cross wind which prevented the center line of the ship from being perpendicular to the line to the transmitter, for most portions of the circle. Fig. 14 shows the data from one vertical descent from 1000 feet down to fifty feet. The descent was made over the East River at a distance of about 6000 feet from the

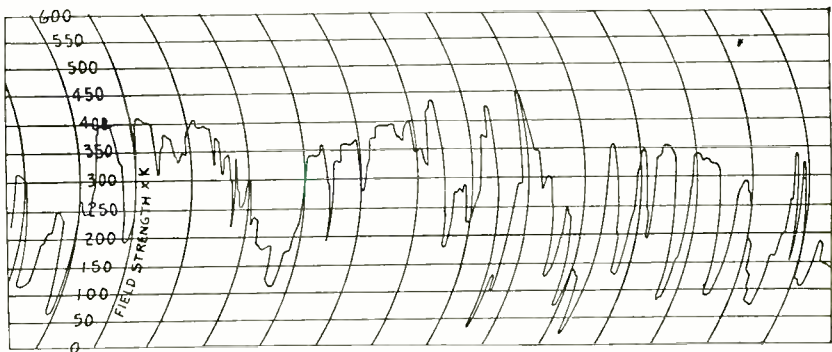

Fig. 19—Field strength at Twenty-fourth Street, 5 P.M.

Empire State antennas. The increase in signal strength at lower altitudes is probably accounted for by reflections from the ground and buildings, and especially from the water during the last several hundred feet of descent.

A number of observations made in the air by Bertram Trevor are described in a separate paper.<sup>4</sup>

## SIGNAL FLUCTUATIONS NEAR TRANSMITTER

All ultra-short-wave observations made at distances within the line-of-sight have shown no indications of fading. However, a type of artificial fading caused by conditions near the receiving location was observed when receiving on the lower several floors

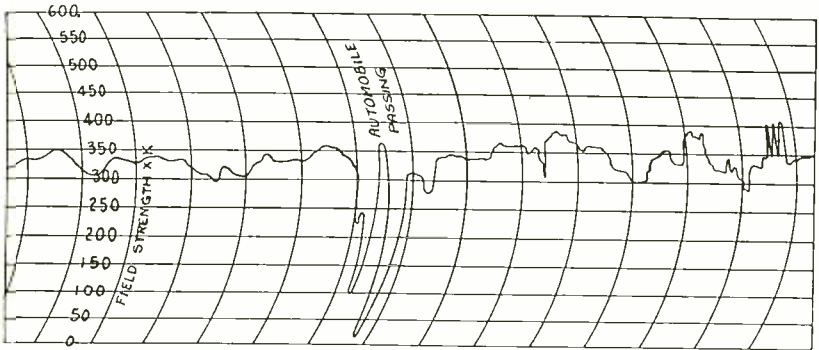

Fig. 20—Field strength at Twenty-fourth Street, 9 P.M.

of buildings on streets carrying considerable traffic. This type of signal fluctuation has been observed only in the business section of the city but may also apply to certain other locations. To study these fluctuations an automatic recorder was attached to the output of the field strength measuring set. Fig. 18, taken on the third floor of a large building about one mile from the Empire State Building, shows a severe decrease in field strength

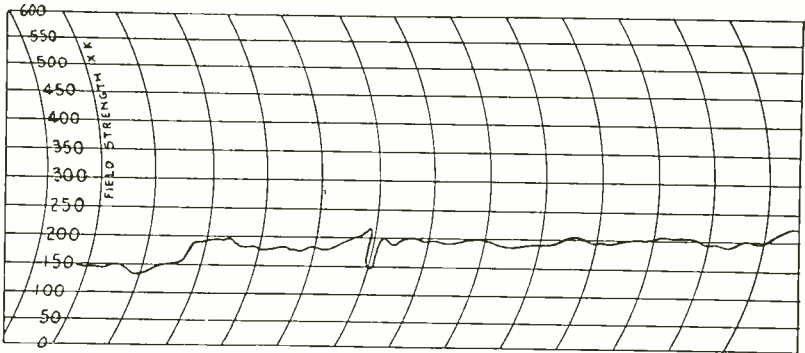

Fig. 21—Field strength at Twenty-fourth Street, 9 P.M., superior location.

at the time when a freight elevator passed this third floor. The receiving antenna was located near the entrance to the elevator shaft. Fig. 19 shows the field strength recorded on the first floor of a large building on 24th Street at 5 P.M., whereas Fig. 20

shows exactly the same measurement taken at 9 P.M. At point "A," an automobile passed the building. The greater smoothness of Fig. 20 over Fig. 19 is accounted for almost entirely by the lack of traffic on 24th Street at 9 P.M. It is surprising to know that the receiver was located almost in the center of the building,

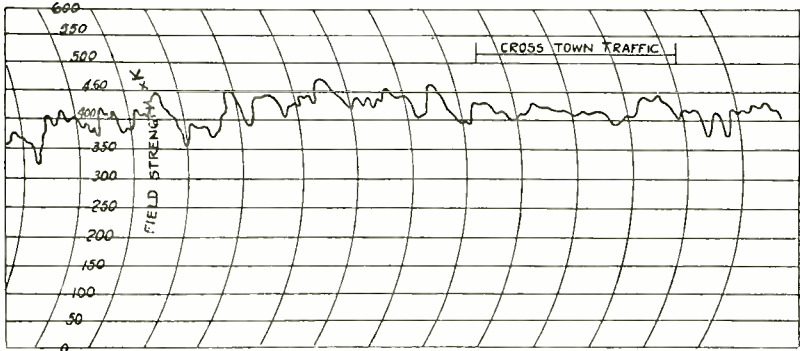

Fig. 22—Field strength in second floor of RCA building, superior location.

seventy to one hundred feet from 24th Street. The fluctuations shown had nothing to do with ignition interference, which in this case was completely overridden by the strong signal. For the measurements shown in Fig. 19 and Fig. 20 the receiving antenna was placed at a point of minimum field strength. Fig. 21 shows a record taken at 9 P.M. with receiving antenna moved several

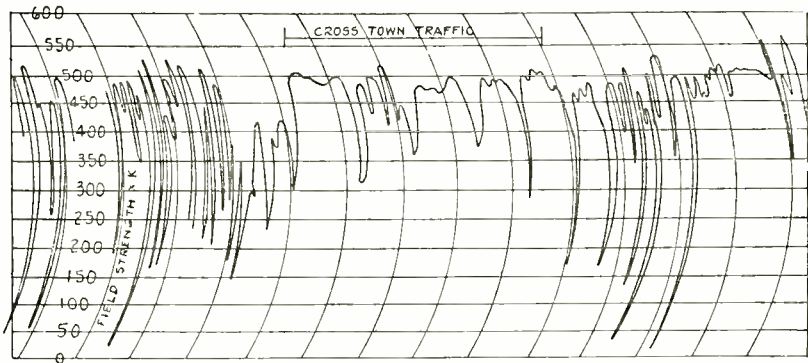

Fig. 23—Field strength in second floor of RCA building, inferior location.

feet to one side to a point of maximum field strength. This curve is much smoother than that in Fig. 20 and indicates the importance of locating the receiving antenna at a point of maximum field strength.

Fig. 22 shows a record of field strength of the forty-four-megacycle transmitter measured on the second floor of the RCA building, near the northeast corner (51st Street and Lexington Avenue). The receiving antenna was at a point of maximum field strength. Fluctuations were of only minor extent and were less severe when the traffic lights were "go" for cross-town traffic. Fig. 23 shows the same thing with the antenna moved several feet to a point of minimum field strength. In this case the fluctuations were prohibitively severe, particularly when Lexington Avenue traffic was running. Charts taken over a longer period of time than shown corroborate these statements. Again the necessity of locating a receiving antenna at a point of maximum field strength is made clear, and the surprising effect of moving objects upon the received field strength is shown. The major cause of the fluctuations is not so much an attenuation of the signal entering the building, although this effect may take place, as it is a shifting of the position and shape of the interference pattern within the building. This was indicated by locating several television receivers in a large first floor room of a downtown building. Television pictures would fluctuate in and out on the several receivers at random, seldom simultaneously, thereby indicating a shift of position of the interference pattern. It has been shown that elevators, automobiles, and trucks cause the fluctuations under discussion, and undoubtedly any moving metal object such as elevated trains and steel frame doors will have similar results. It is well known that a person walking near a half-wave ultra-short-wave receiving antenna will considerably affect the amplitude of the received signal. These fluctuations must be taken into account in designing ultra-short-wave broadcast receivers and receiving antennas.

Observations made on the first floors of residences in the suburban area, and on the higher floors of apartment houses and hotels in the city areas, indicate that fluctuations are much less severe when the receiving point is not near traffic. Fluctuations of the severity shown above will not have to be contended with in the majority of ultra-short-wave broadcast receiver installations.

#### LONG-DISTANCE RECEPTION

To find the maximum range of the transmitters, observations were made at several distant points including Mt. Greylock and Mt. Washington. The high sensitivity receiver previously described was used for these tests, with a half-wave antenna fif-



teen or twenty feet above ground. Both the sixty-one- and forty-four-megacycle transmissions were observed, the observations usually being carried on alternately on each frequency for periods of ten to fifteen minutes. (See Fig. 28.)

The top of Mt. Greylock is 3505 feet above sea level, 140 miles from New York, and 5000 feet below line-of-sight to the Empire State antennas. Both signals were received at Mt. Greylock, with large but gradual variations in signal strength. During the eclipse of August 31, 1932, nothing unusual was observed.

The top of Mt. Washington is 6290 feet above sea level, 284 miles from New York, and 37,600 feet below line-of-sight to the Empire State antennas. On September 3 both signals were strong. Thereafter, on September 6, 7, and 8, the forty-four-megacycle signal was usually audible but seldom delivered more than one microvolt to the receiver terminals. The sixty-one-megacycle signal was inaudible most of the time. Its apparent inferiority may be accounted for by the use of program modulation, which was not as favorable for threshold hearing as the 1000-cycle tone used on forty-four megacycles.

Various types of fading phenomena presented themselves. At times the signal was nearly constant and at other times faded at various rates up to ten or twenty cycles per second. The peak amplitudes varied greatly. Sometimes the signal would burst through sharply for a short period, then be inaudible for a few seconds, then rapidly burst through again at different amplitudes. At other times marked fading at several cycles per second would be heard, the signal frequently dying out after five or six peaks. At times 2000 cycles, the second harmonic of the modulation frequency, was distinctly heard. On September 8, at 9:35 A.M., the signal, after being very weak whenever observed during the previous two days, suddenly started to increase. After a series of fading cycles, with each peak higher than the previous one, the signal delivered over ten microvolts to the receiver terminals. After reaching this peak the signal died off in a similar manner, the entire process lasting about fifteen seconds. During the peak of the cycle the signal varied from zero to its full value about three times per second. These types of ultra-short-wave fading differ from the fading experienced on higher wavelengths in that, instead of the signal varying between relatively fixed maxima and minima, it reaches momentarily an occasional maxima of great intensity.

Measurements were made at 200, 150, and 100 miles from

New York at relatively low elevations. At 200 miles the signal was momentarily audible about every ten minutes or so. At 100 miles reception was almost identical to that on Mt. Washington, the same phenomena being noticed. This was north of New York. At Camden, eighty-five miles south of New York, the signal evidences less severe fluctuations. An observation taken at sea 170 miles east of New York, using an antenna sixty feet above sea level, indicated little or no variation in signal strength. Therefore long-distance reception is not always accompanied by severe fluctuations of the signal.

The exact manner in which long-distance ultra-short-wave propagation takes place cannot be predicted from the insufficient data on hand. Three possibilities regarding the Mt. Washington reception seem highly improbable. The first is that local conditions around the receiver caused some of the variations. This is unlikely because conditions near the location were exceptionally constant due to the isolation of the location. Also identical results were obtained at several points of reception.

The second possibility is that the variations were caused by a single ray varying in amplitude. This may have occurred when the signal varied irregularly. But at times periodic fading was observed, and it is improbable that a single ray would vary uniformly at a rate of several cycles per second. Furthermore, the reception of a 2000-cycle tone intimates the existence of multipath propagation.

The third possibility is that the variations were caused by interference between two ground rays or between a ground ray and some other ray. A ground ray would be highly improbable at Mt. Washington due to the great attenuation. Furthermore, since all signal variations heard were relatively rapid, cancellation of the steady ground wave should be for only brief periods, whereas actually the signal was often inaudible for hours. The presence of a ground wave of the type observed for higher wavelengths, therefore, seems unlikely.

Whether the signals heard were diffracted or refracted or propagated in some unknown manner cannot be predicted as yet. It is possible that refraction due to air layers of different density, as suggested by R. Jouaust<sup>6</sup> is a cause of the fluctuations observed. If such fluctuations are ever controlled or eliminated, ultra-short wavelengths may prove useful for services extending to several hundred miles.

<sup>6</sup> R. Jouaust, "Some details relating to the propagation of very short waves," *Proc. I.R.E.*, vol. 19, pp. 479-488; March, (1931).

## SERVICE AND INTERFERENCE RANGES

It seems incorrect to refer to a definite service range for an ultra-short-wave broadcast station. Conditions at receiver locations are so highly variable that many listeners twenty-five miles from a transmitting station will receive good service, when many fifteen miles from that station will receive poor service. Interference noises on wavelengths between three and ten meters propagate rather poorly, and therefore are sources of interference only in their immediate vicinity. Frequently a receiver several hundred yards from another will receive a serviceable signal when the other will not. Of course, this condition also occurs between the wavelengths of 200 and 550 meters, but not to such a great extent since interferences on higher wavelengths attenuate less rapidly and, in the case of thickly populated areas, tend to blend together into a considerably more uniform "interference level" than is found on ultra-short waves. Therefore, any estimation of service range for ultra-short-wave broadcast transmission must be made with the full knowledge that it is only an average range. Many listeners within and without the range will receive unserviceable and serviceable signals, respectively. From the television observations and field strength measurements made under various conditions at points in and around New York, it seems that the average minimum field strength required for a serviceable 120-line television signal using simple half-wave receiving antennas is at least one millivolt. Higher field strength would have been needed for receiving pictures with more lines, because the receiver would have been designed to cover wider side bands with resulting increase in noise pick-up. The use of improved receiving antennas and higher receiving antenna locations might have permitted the proper reception of 120-line television signals with available field strengths of somewhat less than one millivolt.

Referring to Figs. 6 and 7, it is seen that the 120-line picture service range of the Empire State forty-four-megacycle transmitter is fifteen miles or more, depending on the type of receiving antenna used. With due care in designing and installing receiving antennas, the Empire State transmitters will adequately serve the majority of the urban and suburban areas of the country's largest city.

The interference range of ultra-short-wave transmitters is difficult to define due to the major dependence of the field strength

upon altitude. As a consequence the question of whether or not a city 100 miles from an ultra-short-wave transmitter will receive interference depends largely upon the elevations of the two cities and the two antennas, and the elevations of the territory between them. It seems that transmitters of several kilowatts power with antennas approximately as high as those on the Empire State

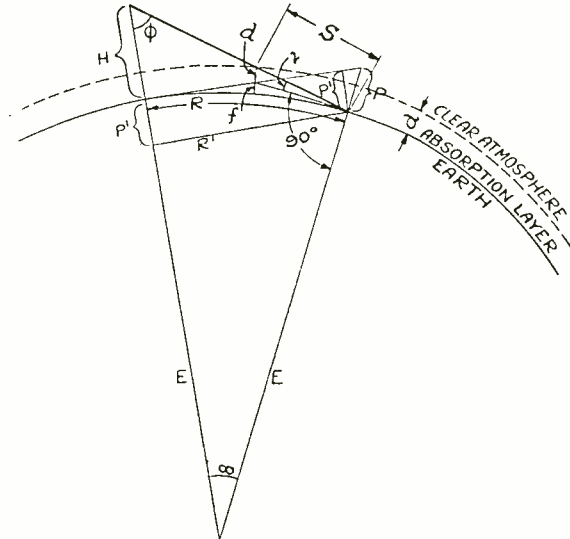

Fig. 24

building should not be located as near to each other as 100 miles, if high quality broadcast service is to be rendered.

The data discussed above on attenuation, reflection, interference, signal fluctuations, and service range should be of some assistance in planning the use of the ultra-short-wave band. But some empirical formula is needed to show the relationship between wavelength, power, attenuation, and transmitter antenna height, especially as applied to propagation in metropolitan areas.

The presentation of any ultra-short-wave propagation formula, even though empirical, is accompanied by some hesitation at this comparatively early stage of ultra-short-wave investigation. However, although the formula and curves given below for propagation over urban territories should be considered as preliminary, they are thought to be of enough value to justify their publication.

The calculated field strength is again based on the assumption that the wave, passing from transmitter antenna to receiver, first passes only through clear atmosphere with field strength

inversely proportional to distance and then passes through a layer of height " $d$ " in which trees and buildings and other objects produce an additional attenuation due to absorption. We are now interested in calculating field strengths for distances greater than several miles and the value of  $a$  found for propagation through large buildings cannot be used, neither can equation (3), because it does not take into account the curvature of the earth.

Referring to Fig. 24,  $H$  is the transmitter antenna height,  $d$  is the height of the absorbing layer,  $R$  is the distance from transmitter to receiver, and  $P$  is the elevation needed for tangential line-of-sight to the distance  $R$ . The receiver antenna is assumed to be within a few feet of the ground. When it is not, the value chosen for  $d$  should be reduced accordingly.

$$\begin{aligned}\gamma + 90^\circ + \phi + \alpha &= 180^\circ \\ \gamma &= 90^\circ - \phi - \alpha.\end{aligned}$$

It is well known that for distances not exceeding several hundred miles, the range of vision to point of tangency varies as the square root of the elevation. Thus,

$$R = K\sqrt{P} \quad P = \frac{R^2}{K^2}$$

For  $R$  and  $P$  in feet,  $K=6500$ . Since  $\alpha$  is not over several degrees,  $P$  practically equals  $P^1$ , and  $R$  practically equals  $R^1$ . These will be considered as equalities.

$$\phi = \cos^{-1} \left( \frac{H + P}{R} \right) = \cos^{-1} \left( \frac{H + \frac{R^2}{K^2}}{R} \right)$$

$$\alpha = \sin^{-1} \left( \frac{R}{E} \right)$$

$$\gamma - 90^\circ = - \cos^{-1} \left( \frac{H + \frac{R^2}{K^2}}{R} \right) - \sin^{-1} \left( \frac{R}{E} \right)$$

$$90^\circ - \gamma = \cos^{-1} \left( \frac{H + \frac{R^2}{K^2}}{R} \right) + \sin^{-1} \left( \frac{R}{E} \right)$$

$$\cos(A + B) = \cos A \cos B - \sin A \sin B$$

$$\begin{aligned} \cos(90^\circ - \gamma) = \sin \gamma &= \cos \left[ \cos^{-1} \left( \frac{H + \frac{R^2}{K^2}}{R} \right) \right] \cos \left[ \sin^{-1} \frac{R}{E} \right] \\ &\quad - \sin \left[ \cos^{-1} \left( \frac{H + \frac{R^2}{K^2}}{R} \right) \right] \sin \left[ \sin^{-1} \frac{R}{E} \right] \\ \sin \gamma &= \left( \frac{H + \frac{R^2}{K^2}}{R} \right) \sqrt{1 - \frac{R^2}{E^2}} - \frac{R}{E} \sqrt{1 - \left( \frac{H + \frac{R^2}{K^2}}{R} \right)^2} \end{aligned}$$

Just as,

$$\begin{aligned} P &= \frac{R^2}{K^2} & f &= \frac{S^2}{K^2} \\ S \sin \gamma &= d - f = d - \frac{S^2}{K^2} \end{aligned}$$

Solving,

$$S = \frac{K^2 \sin \gamma \pm \sqrt{K^4 \sin^2 \gamma + 4dK^2}}{2} \quad (12)$$

If  $H$ ,  $E$ ,  $R$ ,  $d$ , and  $S$  are in feet,  $K = 6500$  and  $E = 19.4 \times 10^6$ . Then,

$$\begin{aligned} \sin \gamma &= \left( \frac{H + \frac{R^2}{6500^2}}{R} \right) \sqrt{1 - \left( \frac{R^2}{376.4 \times 10^{12}} \right)} \\ &\quad - \left( \frac{R}{19.4 \times 10^6} \right) \sqrt{1 - \left( \frac{H + \frac{R^2}{6500^2}}{R} \right)^2} \quad (13) \end{aligned}$$

$$\begin{aligned} S &= [42.2500 \times 10^6 \times \sin \gamma \\ &\quad \pm \sqrt{(17.8506 \times 10^{14} \times \sin^2 \gamma) + (4d \times 42.2500 \times 10^6)}] / 2 \quad (14) \end{aligned}$$

Values of  $\sin \gamma$  for use in (14) are found by (13). The distance  $S$  then given by (14) is the distance through which absorption will take place. The field strength  $E_s$  may be represented by the equation

$$E_s = \frac{K_0 \sqrt{W}}{R_0} e^{-\alpha S_0 / \lambda^2} \quad (15)$$

where,

$W$  = antenna power in watts

$R_0$  = total distance in kilometers =  $1.61 \times R$ .

$S_0$  = absorption distance in kilometers =  $1.61 \times S$ .

$\lambda$  = wavelength in kilometers

$K_0$  = constant

$E_s$  = field strength in millivolts per meter.

The exponent of  $\lambda$ ,  $x$ , has been evaluated at unity, which value seems to render the closest agreement between (15) and the available measurements. By comparison with the measurements it is found that  $K_0$  should be evaluated at 0.72. This does not check with the theoretical value but, for the sake of consistency in this paper, it will be used in calculating the curves below. Then, whether absolute values of field strength are correct or not, the relative values will be correct and conclusions regarding service areas will be unaffected by any error in  $K_0$ . Therefore,

$$E_s = \frac{0.72 \sqrt{W}}{R_0} e^{-\alpha S_0 / \lambda}.$$

To evaluate  $d$ , the only unknown in the equation for  $S$  (equation (14)), and  $\alpha$ , which is the only remaining unknown of (16), several values of each were chosen arbitrarily and curves calculated for  $H = 1300$  which is the value corresponding to the Empire State antennas. Comparison of the calculated and measured curves indicated that  $d = 25$  feet and  $\alpha = 0.004$  were appropriate empirical values to choose. Fig. 25 shows the correlation, on forty-four and sixty-one megacycles, between the calculated and measured field strengths. The empirical constants were purposely chosen to indicate greater attenuation than the actual measurements because the curves of actual measurements are somewhat optimistic at long distances due to favorable selection of the distant points of measurement.

Using the values of  $d$  and  $\alpha$  that were chosen, Fig. 26 shows the relationship between field strength, antenna height, distance, and wavelength. These curves are based on a power of one kilowatt but of course are applicable to any power,  $E_s$  varying as the square root of the power. These curves are very useful in showing the increasing importance of antenna height with increasing distance, the necessity of very high antennas or very high powers for good television broadcast service, and the in-

creasing superiority of the higher wavelengths with increasing distance.

Fig. 27 contains part of the information of Fig. 26 in a different form. It shows the range at which 0.5 millivolt will be obtained for various values of transmitter power, antenna height, and wavelength.

It must be emphasized that the field strengths shown in Fig.

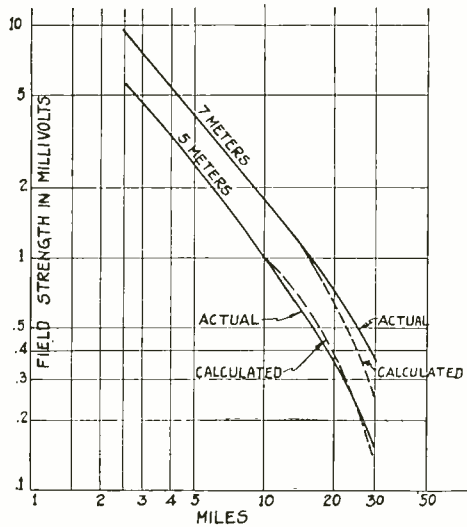

Fig. 25—Actual and theoretical attenuations.

26 and Fig. 27 are for outdoor points near the ground, such as when making measurements by automobile, and that higher intensities are always available by installing outdoor receiving antennas at higher elevations. The field strengths of Figs. 26 and 27 can be somewhat increased, for a given transmitter power, by the utilization of transmitting antennas producing greater horizontal concentration of the radiated energy. It must again be mentioned that the curves are based on (16), where  $K_0$  was arbitrarily chosen as 0.72 for the reasons stated, and furthermore that the curves do not apply to field strengths beyond the line-of-sight distance. The long-distance airplane observations indicated little or no absorption of the wave when the receiving point is sufficiently high so that the wave does not pass near the ground. Thus a five-meter transmitter with antenna 800 feet above ground will produce approximately the same field



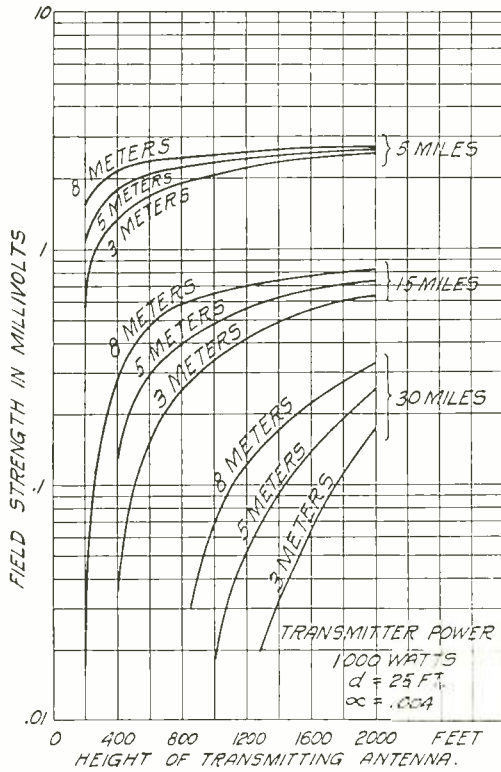

Fig. 26—Field strength vs. transmitter antenna height.

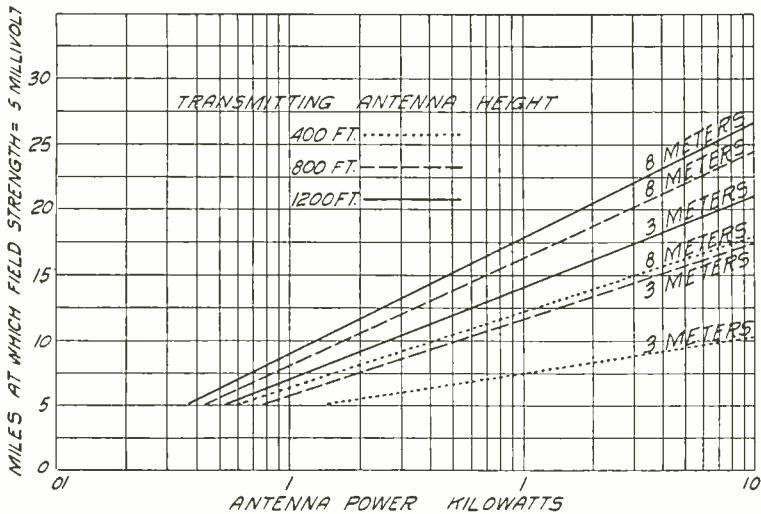

Fig. 27—Half-millivolt range vs. kilowatts.

strength at 100 miles at high altitude as at fifteen miles on the ground.

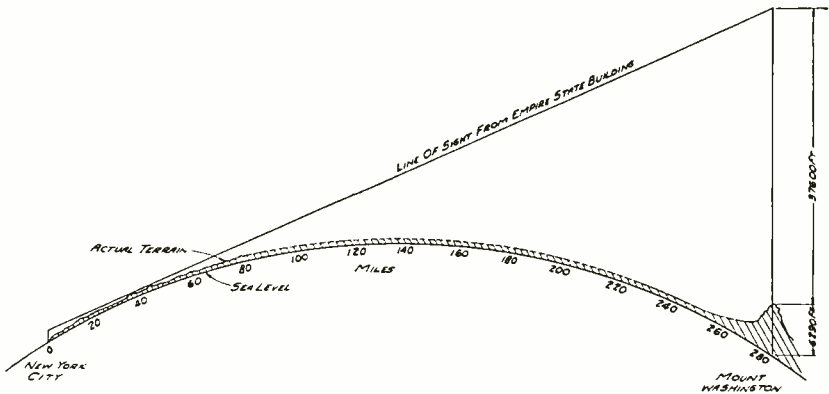

Fig. 28—Profile from New York to Mt. Washington.

### CONCLUSIONS

It is hoped that the above data and discussion will assist in visualizing the propagation of ultra-short waves and in bringing about their intelligent utilization. It is apparent that their propagation characteristics are as would be expected for wavelengths longer than those of light but shorter than those generally used for radio, and that no inexplicable phenomenon of immediate importance has as yet been encountered. It is assured that for the transmission of television broadcasting, sound broadcasting, facsimile broadcasting, aircraft communications, police communications and certain other types of public and private communications, ultra-short waves will prove definitely useful.

### ACKNOWLEDGMENT

Mr. W. S. Duttera of the National Broadcasting Company assisted in the measurement of signal fluctuations, and throughout all tests the cooperation of Messrs. R. M. Morris and R. E. Shelby of the same company was invaluable. Mr. C. J. Young of RCA Victor conducted the autogiro tests. Other engineers of RCA Victor who contributed to a major extent to the conducting of the tests were Messrs. G. L. Beers, R. D. Kell, A. H. Turner, H. E. Gihring, K. S. Sherman, and John Evans.

# NOTES ON PROPAGATION OF WAVES BELOW TEN METERS IN LENGTH<sup>1</sup>

BY

BERTRAM TREVOR and P. S. CARTER

(RCA Communications, Inc., Riverhead, L. I., N. Y.)

*Summary*—The results of a number of measurements of field strength variation with distance from the transmitter and height above ground for several wavelengths in the range below ten meters are shown. Observations of the two transmitters on the Empire State Building in New York City, on 44 and 61 megacycles, were made in an airplane over Long Island. These tests show the nature of the interference patterns set up by the combination of the direct and reflected rays. With low transmitting and receiving antennas, field strength measurements with distance were taken for both horizontal and vertical polarizations over Long Island sand on 41.4 and 61 megacycles. Similar tests were made over salt water with low antennas on 34.8 and 59.7 megacycles. Another airplane test was made on 34 megacycles with a higher transmitting antenna and increased power up to a distance of 200 kilometers. The intervening territory in this run was partly land and partly salt water.

The experimental data are discussed in comparison with the theoretical curves determined from optical principles. The experimental results are shown to conform in general with the predictions from theoretical considerations.

The derivation of the theoretical formulas is shown in the appendix.

## INTRODUCTION

WITH the increasing use of wavelengths below ten meters in connection with radio communication and television, it has become increasingly apparent that our knowledge of the propagation of waves in this range should be augmented. In a previous paper<sup>1</sup> the results of some experiments made by engineers of R.C.A. Communications, Inc., were described in a qualitative way. More recent developments of receiving and transmitting apparatus has made it possible to obtain quantitative data. At the present writing considerable additional information of value has been accumulated.

Experiments were made with several wavelengths over salt water and over Long Island ground with both horizontal and vertical polarizations on frequencies between 61 and 34 megacycles. A few tests were made on 435 megacycles but no quantitative information is available.

<sup>1</sup> H. H. Beverage, H. O. Peterson, and C. W. Hansell, "Application of frequencies above 30,000 kilocycles to communication problems," PROC. I.R.E., vol. 19, no. 8, pp. 1313-1333; August, (1931).

Reprinted from Proceedings of the Institute of Radio Engineers,

## I. EXPERIMENTS

*Propagation Over Long Island for Frequencies of  
44 and 61 Megacycles*

A number of measurements of field strength from two transmitters located in the Empire State Building were made in an airplane flying over Long Island. The transmitting antennas were located above the Empire State tower at a height of 396 meters above sea level and were radiating vertically polarized waves on 61 and 44 megacycles. The receiver used for measuring field strengths consisted of three stages of tuned radio-frequency amplification and high-frequency detector in one unit, feeding into a revamped RCA AR-1286 aircraft beacon receiver serving as an intermediate-frequency amplifier, at 3113 kilocycles, second detector, and direct-current amplifier. The output of the direct-current amplifier was maintained constant on a milliammeter in the plate circuit of this tube. With this set-up no modulation was required and the carrier alone was used for observing field strengths.

The receiver with its supply batteries was installed in a Curtiss-Robin cabin monoplane with complete bonding and shielding to eliminate ignition interference. A vertical duralumin pipe two meters long mounted on the fuselage near the rear edge of the wing served as an antenna. Each observation of field strength included readings of both radio-frequency and intermediate-frequency screen-grid voltages to give constant output of the direct-current amplifier, and a record of altitude and location.

The calibration of receiver and antenna in the plane was effected by observing the output of a signal generator radiating a calculated field strength at a measured distance of about one wavelength.

It was found that the receiving antenna was quite directive on 61 and fairly nondirective on 44 megacycles. The directive diagram on 61 megacycles is shown in Fig. 1, and was obtained by flying in a flat circle over the Suffolk County Airport. It will be seen that the antenna directivity on 61 megacycles shows a variation of nearly 2 to 1. Some of the data taken were corrected for this directivity.

The profile map, Fig. 2, shows Farmingdale to have direct vision to the Empire State Tower. Patchogue comes 30 meters, Suffolk Airport 259 meters, and Montauk Point 1120 meters below the line of sight. Field strength readings were taken from

0 to 1200 meters altitude at North Beach, Farmingdale, Patchogue, Suffolk Airport, and Montauk Point. Also, readings were taken at altitudes of 300 and 1200 meters flying between

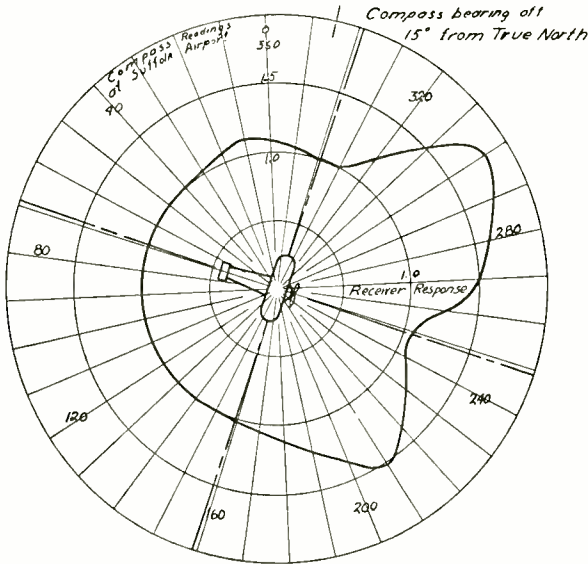

Fig. 1—Directive diagram of airplane antenna, 61 megacycles.

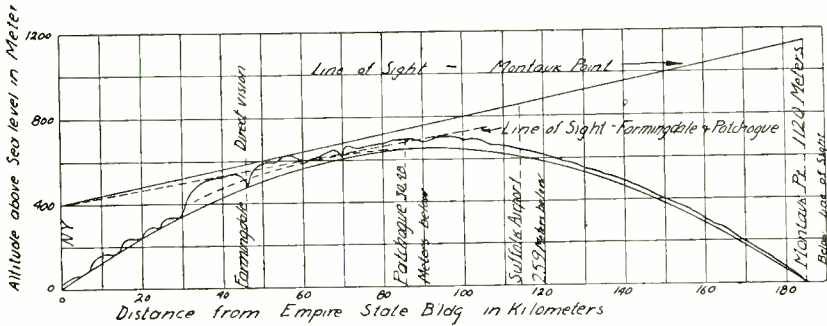

Fig. 2—Profile map airplane route from Empire State building over Long Island

these points. Both transmitters were observed in this manner with the exception that data were taken at 900 meters in place of 300 meters on 61 megacycles between Southampton and Montauk Point, because the signal below 900 meters was too weak to measure. At Southampton readings were taken at altitudes of from 200 to 1200 meters on 61 megacycles.

Figs. 3 to 7 show the field strength variation with altitude at North Beach, Farmingdale, Patchogue, Suffolk Airport, and

Montauk Point on 44 megacycles. The irregularities of Figs. 3, 4, and 5 show marked interference phenomena. As the inter-

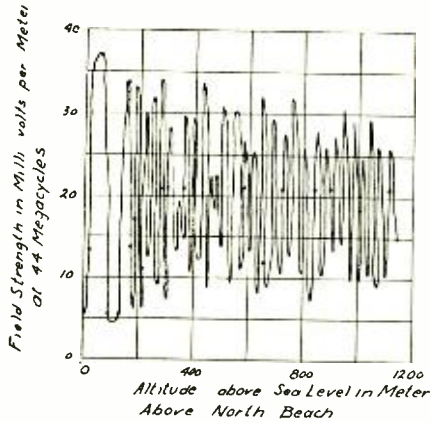

Fig. 3—Field strength vs. altitude at North Beach, 9.6 kilometers from Empire State 44-megacycle transmitter. Radiation 2 kilowatts.

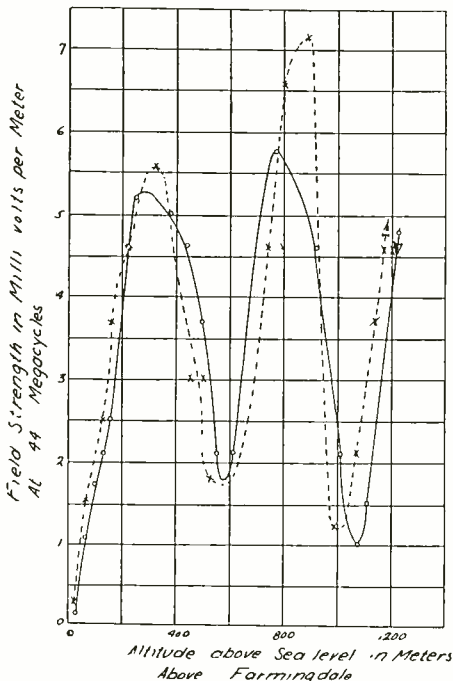

Fig. 4—Field strength vs. altitude at Farmingdale, 47 kilometers from Empire State 44-megacycle transmitter. Radiation 2 kilowatts.

ference patterns become more frequent nearing the transmitter, the variations in field strength were so rapid that it was not possible for the observer to record them all. For this reason the

curve, Fig. 3, from readings taken at North Beach, was drawn in by guesswork.

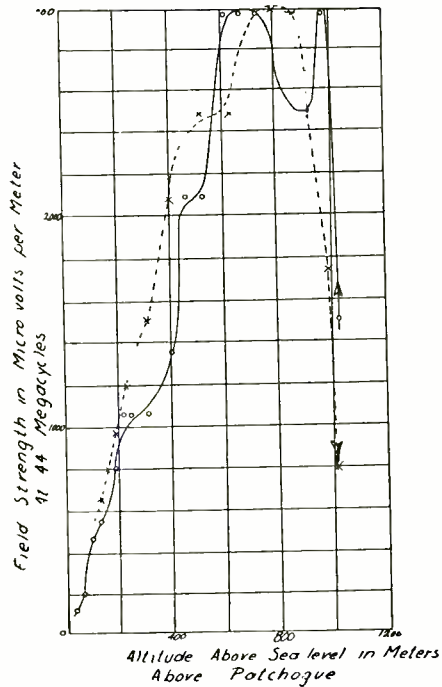

Fig. 5—Field strength vs. altitude at Patchogue, 85 kilometers from Empire State 44-megacycle transmitter. Radiation 2 kilowatts.

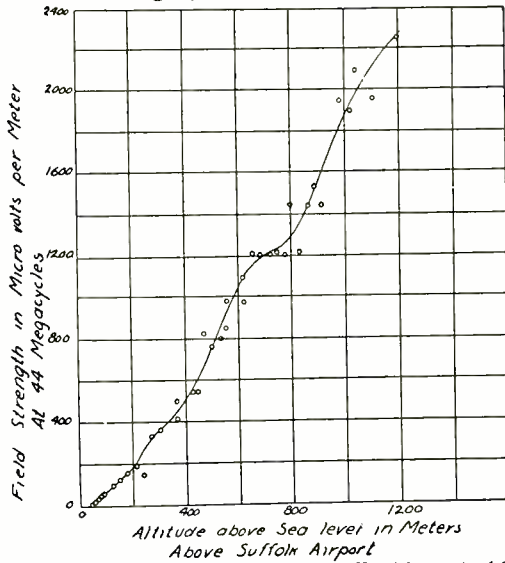

Fig. 6—Field strength vs. altitude at Suffolk Airport, 114 kilometers from Empire State 44-megacycle transmitter. Radiation 2 kilowatts.

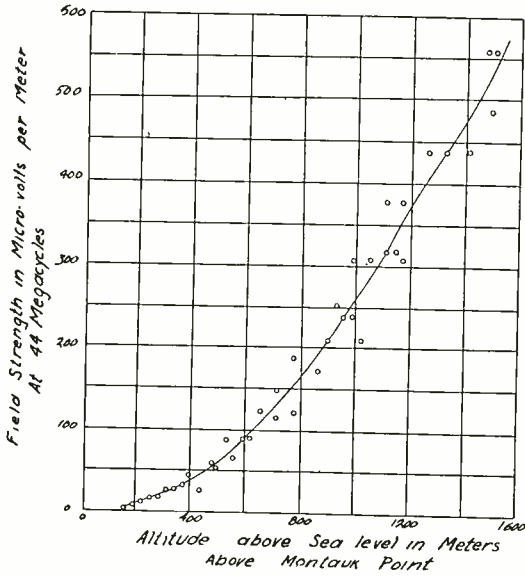

Fig. 7—Field strength vs. altitude at Montauk Point, 185 kilometers from Empire State 44-megacycle transmitter. Radiation 2 kilowatts.

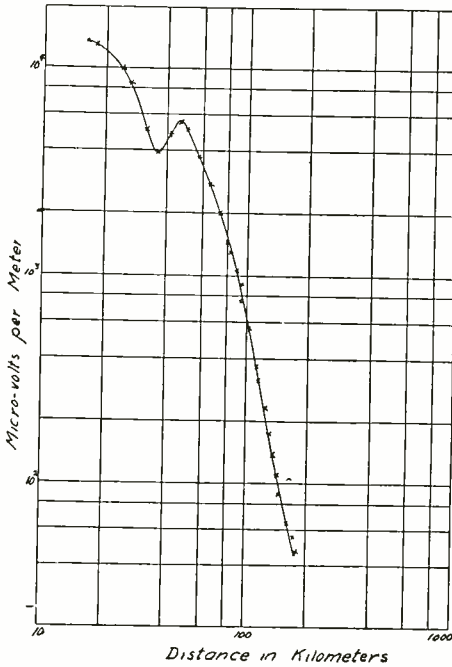

Fig. 8—Field strength vs. distance at 300 meters altitude—Empire State 44-megacycle transmitter. Radiation 2 kilowatts.



Fig. 8 represents the results of measurements when flying at 300 meters altitude between North Beach and Montauk Point,

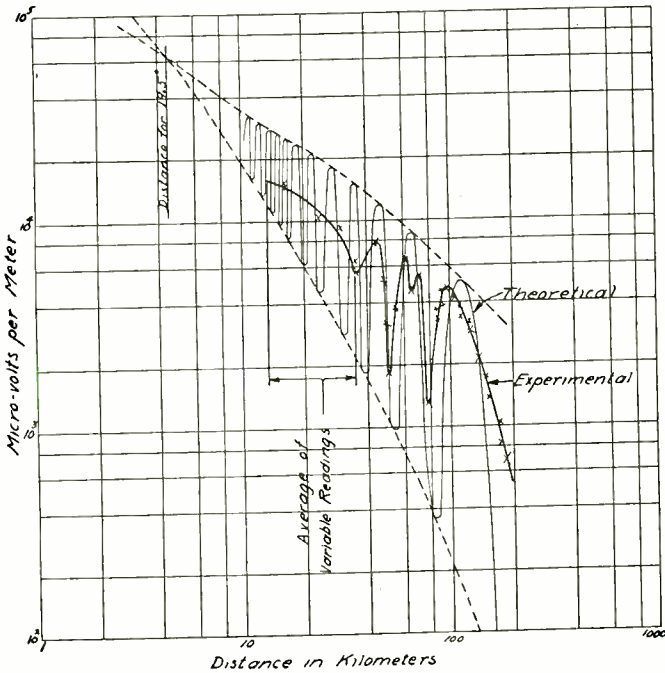

Fig. 9—Field strength vs. distance at 1200 meters altitude—Empire State 44-megacycle transmitter. Radiation 2 kilowatts.

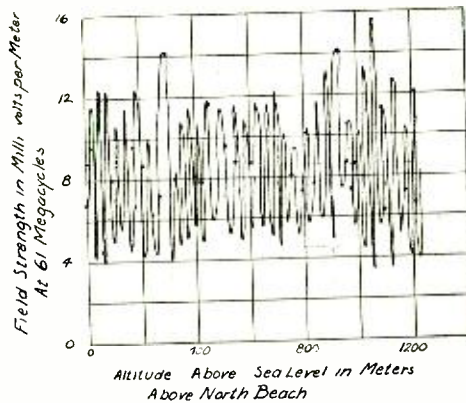

Fig. 10—Field strength vs. altitude at North Beach, 9.6 kilometers from Empire State 61-megacycle transmitter. Radiation 1 kilowatt.

while Fig. 9 is a similar curve showing the readings taken while flying at a 1200-meter altitude over the same route.

The curve, Fig. 4, from data taken at Farmingdale shows two distinct minimum points at 580 and 1000-1070 meters. The maximum points occur at 305, 760-910, and about 1200 meters. The two curves represent data taken descending and ascending, as shown by the direction of the arrows.

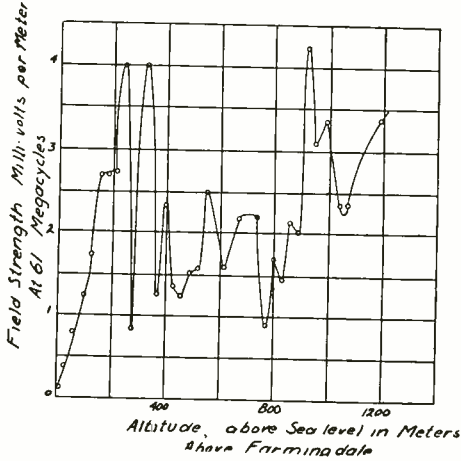

Fig. 11—Field strength vs. altitude at Farmingdale, 47 kilometers from Empire State 61-megacycle transmitter. Radiation 1 kilowatt.

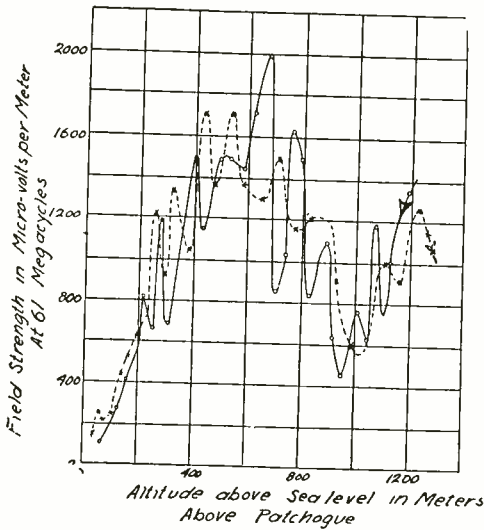

Fig. 12—Field strength vs. altitude at Patchogue, 85 kilometers from Empire State 61-megacycle transmitter. Radiation 1 kilowatt.

The data for 61 megacycles were more erratic than those on 44 megacycles, due partly to more uncertainty in the directivity

of the receiving antenna, more frequent interference effects, and possibly to more irregular reflections from large objects. Figs. 10 to 15 show the data on 61 megacycles at North Beach, Farmingdale, Patchogue, Suffolk Airport, Southampton, and Montauk

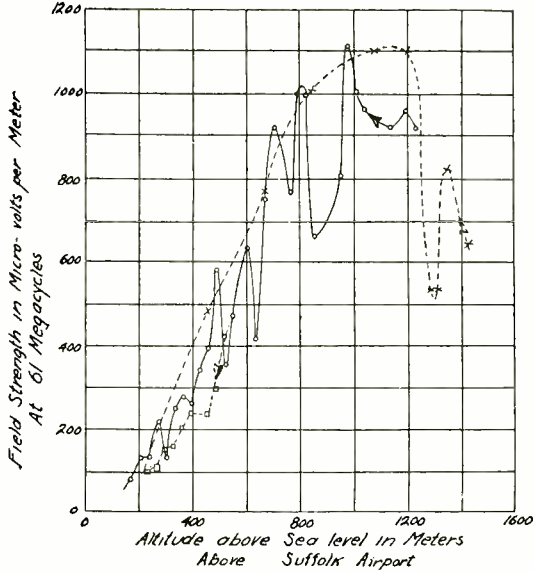

Fig. 13—Field strength vs. altitude at Suffolk Airport, 114 kilometers from Empire State 61-megacycle transmitter. Radiation 1 kilowatt.

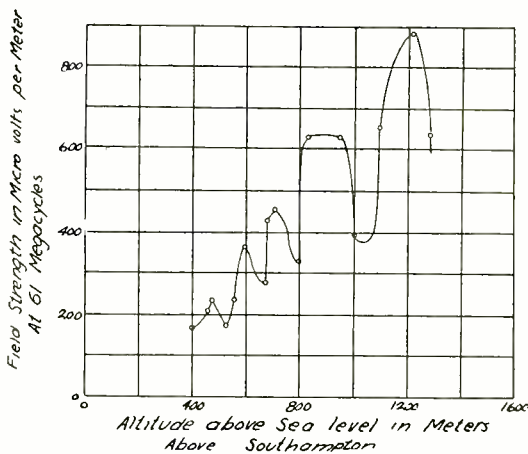

Fig. 14—Field strength vs. altitude at Southampton, 137 kilometers from Empire State 61-megacycle transmitter. Radiation 1 kilowatt.

Point. Fig. 10 is merely a symbolic representation of actual conditions as the interference effects were crowded extremely close together. The variation in field strength on 61 megacycles at Farmingdale and Patchogue follows a rapid oscillation in addition to the slower variation corresponding roughly to the curves for 44 megacycles.

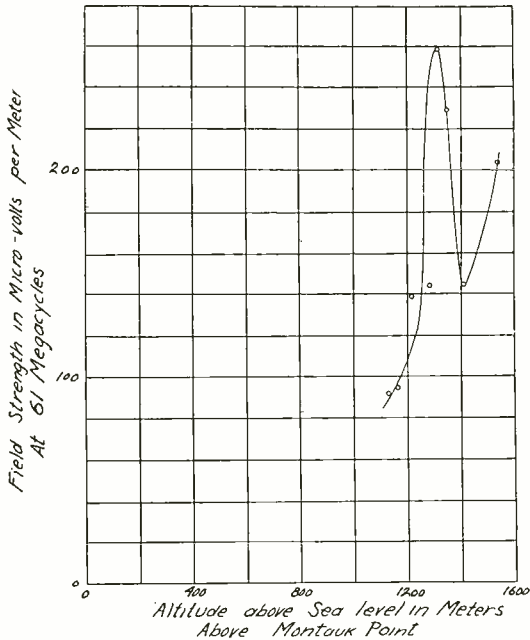

Fig. 15—Field strength vs. altitude at Montauk Point, 185 kilometers from Empire State 61-megacycle transmitter. Radiation 1 kilowatt.

#### *Measurements on the Ground with Low Transmitting Antennas*

Some further short-wave observations were made at Suffolk Airport by setting up a small transmitter at one end of the field and observing field strength versus distance for both vertical and horizontal polarization on 61 and 41.4 megacycles. The results of these tests are shown in Figs. 16 to 19. The center of the radiating antenna was 2.9 meters above level ground for both the horizontal and vertical positions. A vertical wire 2.11 meters long with its upper end 4.2 meters above ground was used for receiving the vertically polarized radiation, while a horizontal dipole 3.81 meters long, 1.6 meters above ground was used for receiving the horizontally polarized radiation. It will be seen that the horizontal polarization is attenuated more than the

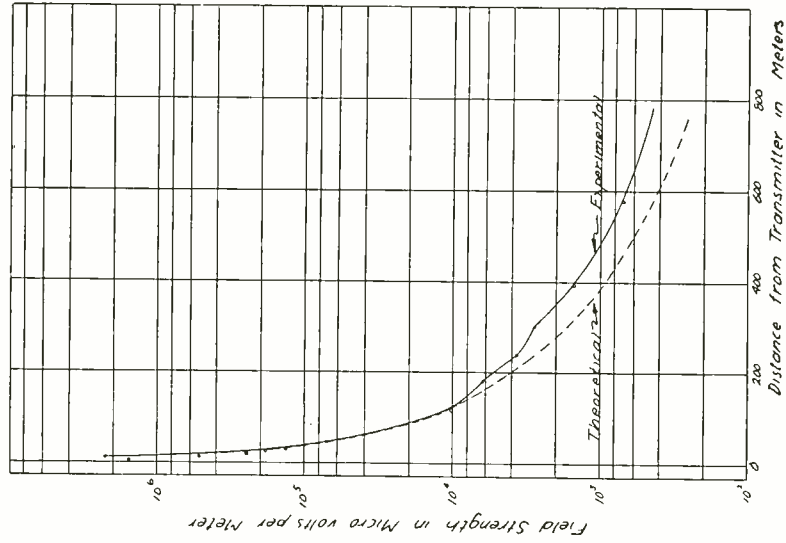

Fig. 17—Field strength vs. distance, horizontal polarization, 61 megacycles. Transmitting and receiving antennas 2.9 and 1.6 meters above Long Island ground.

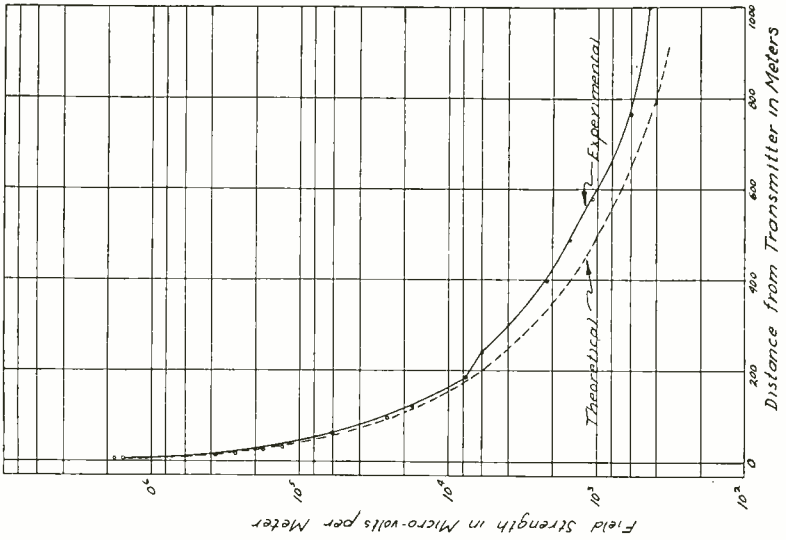

Fig. 16—Field strength vs. distance, vertical polarization, 61 megacycles. Transmitting and receiving antennas 2.9 and 3.1 meters above Long Island ground.

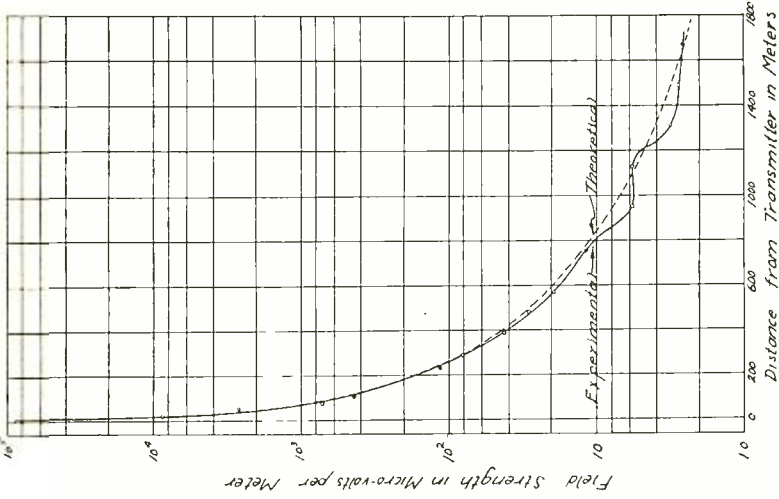

Fig. 19—Field strength vs. distance, horizontal polarization, 41.4 megacycles. Transmitting and receiving antennas 2.9 and 1.6 meters above Long Island ground.

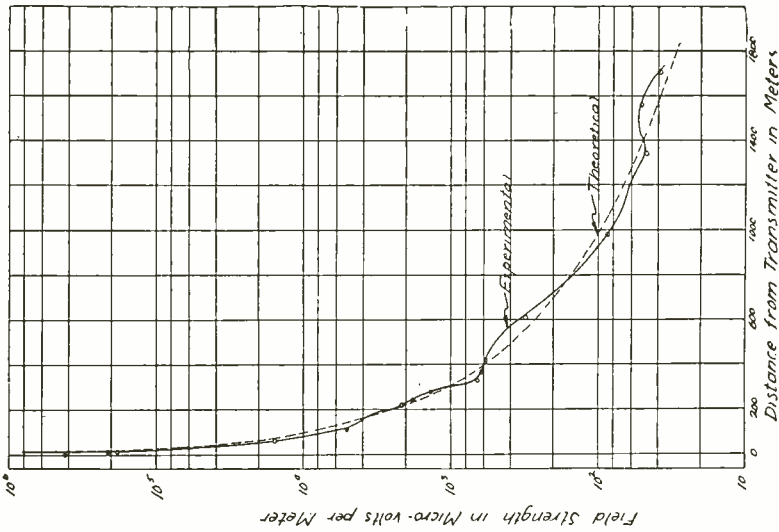

Fig. 18—Field strength vs. distance, vertical polarization, 41.4 megacycles. Transmitting and receiving antennas 2.9 and 3.1 meters above Long Island ground.

vertical and also that the higher frequency is attenuated more than the lower. It was interesting to note that any plane flying over the field would cause quite pronounced variations in receiver output due to the reflected radiation from the plane alternately reinforcing and weakening the direct ray from the transmitter. This phenomenon was most marked with a separation between the transmitter and receiver of about 800 meters. Interference effects caused by the plane were stronger as the plane came nearer the receiver, but were also noticeable with the plane beyond the receiver in a direction away from the transmitter.

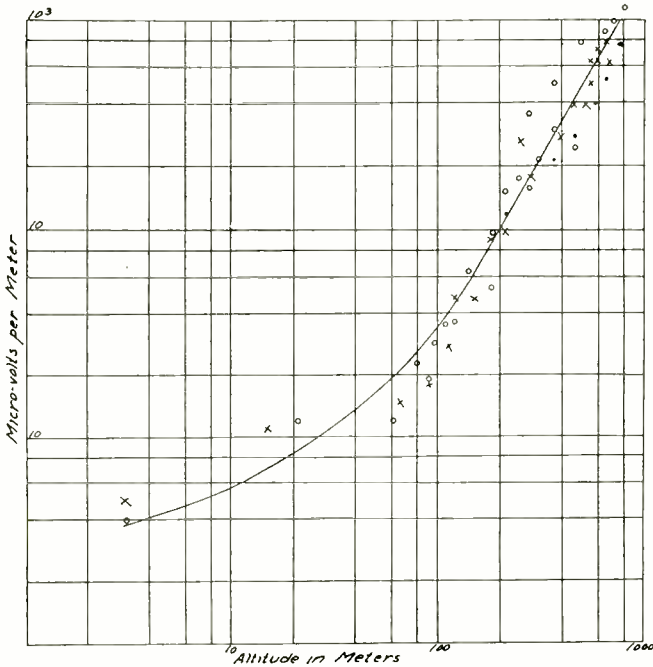

Fig. 20—Field strength vs. altitude at Roosevelt Field, 59.6 kilometers from Rocky Point 34-megacycle vertical transmitting antenna 39 meters high. Radiation 1 kilowatt.

#### *Airplane Tests on 34 megacycles*

A number of measurements were made on a Rocky Point transmitter radiating one kilowatt on 34 megacycles from a vertical antenna 39 meters above ground. A flight was made from Riverhead to Newark. Measurements were taken with altitude over Suffolk Airport, Farmingdale, Floyd Bennett Field, Roosevelt Field, and Newark Airport. A curve of data taken over Roosevelt Field is shown in Fig. 20. The curves for the other

airports are very similar and are not shown. The complete set of data is summarized in Fig. 21, which shows the variation of signal strength with both distance and altitude. This curve plainly shows the advantage gained by an increase in altitude at distances over 20 kilometers.

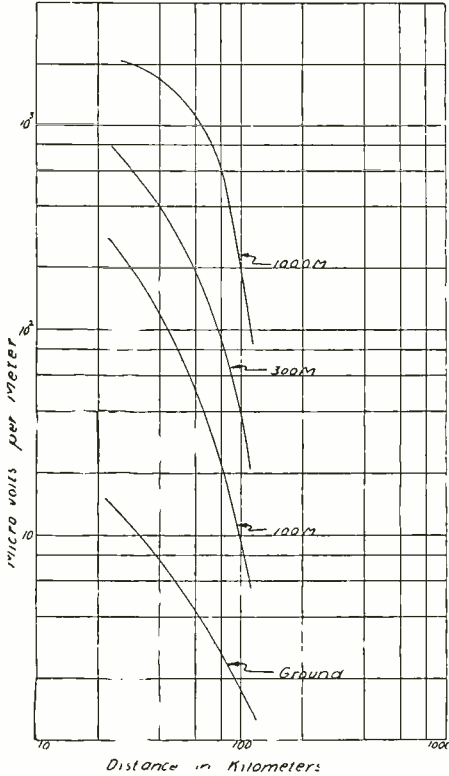

Fig. 21—Field strength variation with distance and altitude over Long Island from Rocky Point 34-megacycle verticle transmitting antenna 39 meters high. Radiation 1 kilowatt.

### Propagation Over Salt Water

Several tests were made with both horizontal and vertical polarization on frequencies of 59.7 and 34.8 megacycles on Peconic Bay. In all of these experiments the height of the center of the transmitting antenna was 2.0 meters and that of the receiving antenna 2.7 meters. Fig. 22 shows the results at 59.7 megacycles when both receiving and transmitting antennas were horizontal, and Fig. 23 when both antennas were vertical. Fig. 24 shows a similar curve for 59.7 megacycles for vertical polarization.



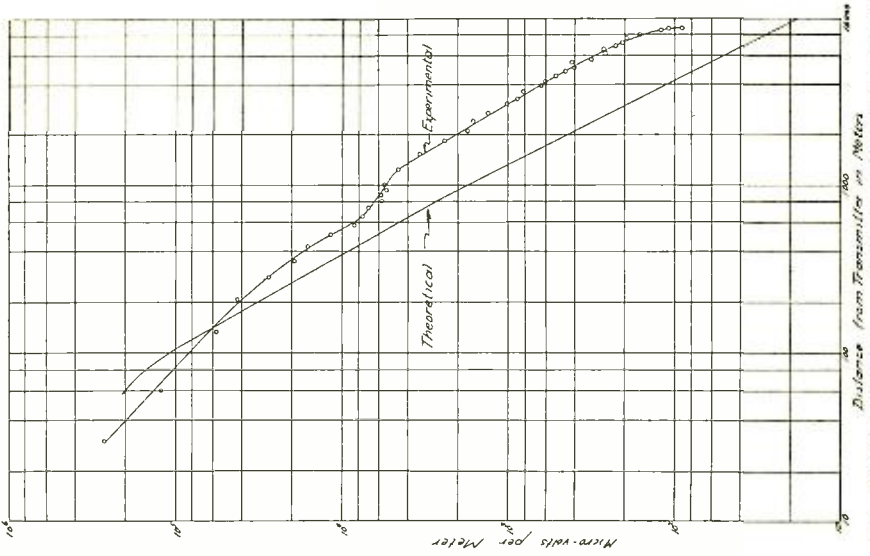

Fig. 23—Field strength vs. distance over salt water, vertical polarization, 59.7 megacycles. Transmitting and receiving antennas 2 and 2.7 meters high. Radiation 2.5 watts.



Fig. 22—Field strength vs. distance over salt water, horizontal polarization, 59.7 megacycles. Transmitting and receiving antennas 2 and 2.7 meters high. Radiation 1.8 watts.

The great improvement of vertical as compared with horizontal polarization will be noted when using low antennas.

Fig. 25 shows a run made with vertical polarization on 34.8 megacycles on Block Island Sound. This run was taken to about 33 kilometers beyond the line of sight.

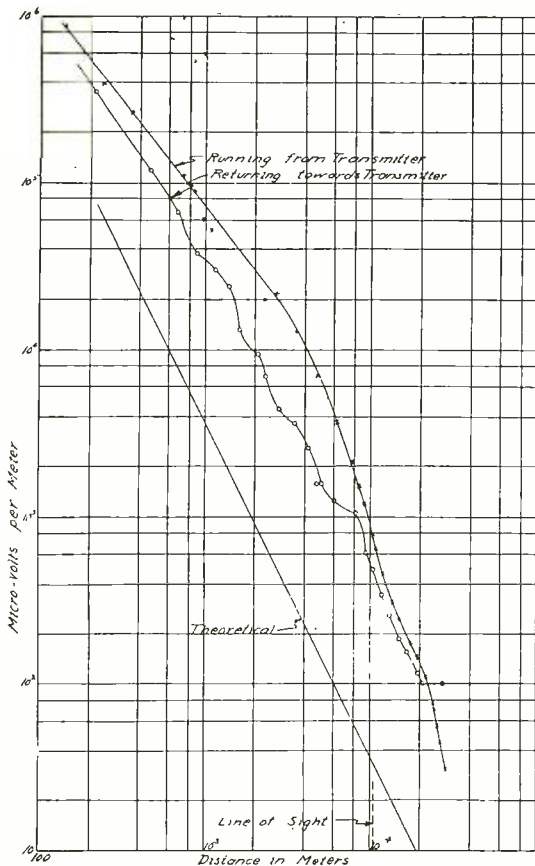

Fig. 24—Field strength vs. distance over salt water, vertical polarization, 59.7 megacycles. Transmitting and receiving antennas 2 and 2.7 meters high. Radiation 10 watts.

Airplane observations were made on 34 megacycles on a 1-kilowatt transmitter at Rocky Point, Long Island. The transmitting antenna was located 39 meters above ground and radiated vertically polarized waves. Fig. 26 shows the field strength variations with distance and altitude. This run was made between Rocky Point and Marion, Mass., which includes a path

partly over land and partly over salt water. At several airports a large number of readings were taken descending and ascend-

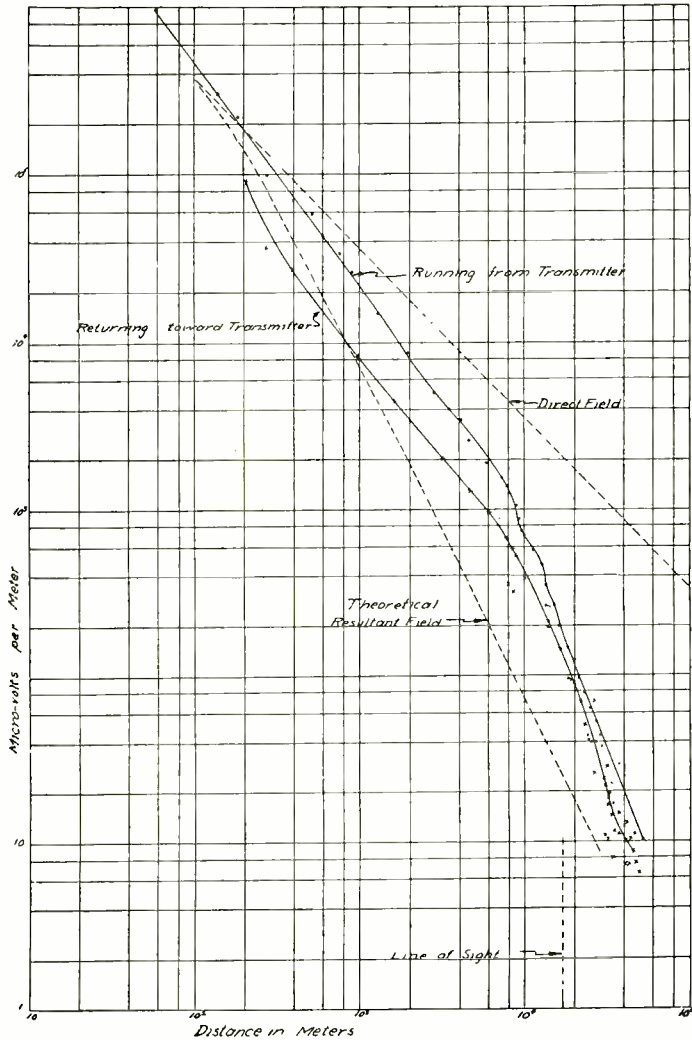

Fig. 25—Field strength vs. distance over salt water, vertical polarization, 34.8 megacycles. Transmitting and receiving antennas 2 and 2.7 meters high. Radiation 22 watts.

ing so that the curves in Fig. 26 give the average results of these measurements. A curve from observations taken over Round Hill, Mass., Fig. 27, is typical of the others that are not here shown.

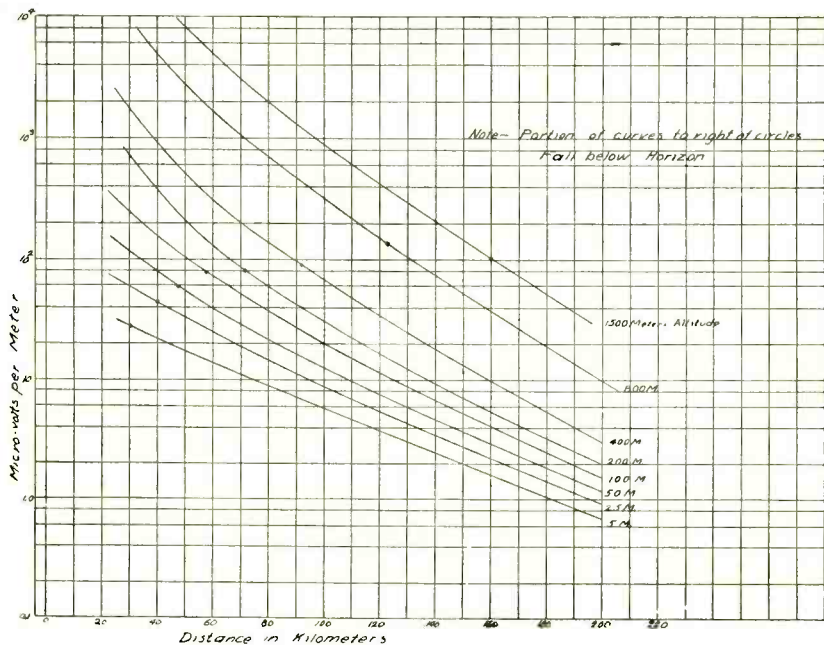

Fig. 26—Field variation with distance and altitude over water and land. Rocky Point 34-megacycle vertical transmitting antenna 39 meters high. Radiation 1 kilowatt.

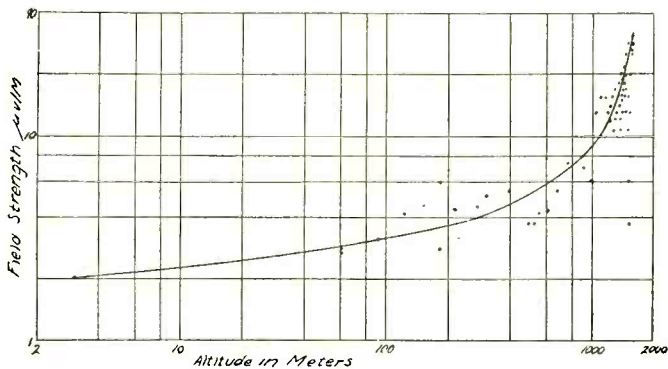

Fig. 27—Field strength vs. altitude at Round Hill, Mass. Rocky Point 34-megacycle vertical transmitting antenna 39 meters high, 182 kilometers distance from Rocky Point.

### Tests on 435 megacycles

About a year ago propagation observations were made on a Rocky Point 435-megacycle (69-centimeter) transmitter, on the ground, in an airplane, and on the Empire State Building in New York City. Reception up to 48 kilometers in an automobile, to nearly 110 kilometers in an airplane, and on the 300-meter level of the Empire State Building was accomplished, the distance from Rocky Point to New York being 90 kilometers. The 300-meter level of the Empire State Building is 200 meters below the line of sight from the Rocky Point antenna. This indicates considerable diffraction. No quantitative measurements were made at that time.

## II. THEORY AND DISCUSSION

The field from a transmitting antenna at a point in space may be considered as due to the combination of a direct and reflected ray<sup>2</sup> as shown in Fig. 28. The total distance of travel

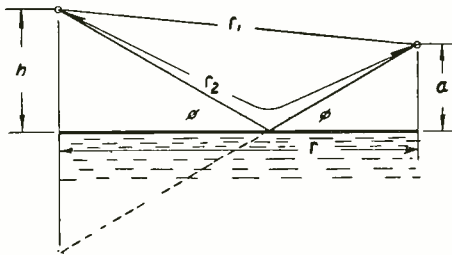

Fig. 28

$r_2$  of the reflected ray is greater than the distance of travel  $r_1$  of the direct ray, resulting in a phase difference between these two rays. In addition to this phase difference a phase shift in general takes place upon reflection. The laws of reflection are the same for radio waves as for light.

Consider first a pure dielectric. When a wave traveling through free space strikes a dielectric medium it divides into two rays, a refracted ray penetrating into the medium and a reflected ray. The angle of incidence of the reflected ray is equal to the angle of incidence of the main ray while the sine of the angle of incidence of the main ray is equal to the product of the square root of the dielectric constant of the dielectric medium and the sine of the angle of refraction.

Henceforth we shall speak in terms of the angle to the horizon rather than the angle of incidence. When the wave is

<sup>2</sup> P. O. Pedersen, "The Propagation of Electric Waves Along the Surface of the Earth and in the Atmosphere."

horizontally polarized, the phase is always changed by 180 degrees upon reflection from a pure dielectric. The amplitude of the reflected wave is equal to that of the wave before reflection at grazing incidence and continually decreases as the angle to the horizon is increased. When the wave is polarized in the plane of incidence (commonly called vertical polarization) the phenomenon is quite different. At grazing incidence the phase is shifted by 180 degrees, and the amplitude after reflection is equal to that before reflection. However, as the angle to the horizon is increased the amplitude of the reflected ray rapidly decreases until that angle is reached whose cotangent is equal to the square root of the dielectric constant. At this angle the amplitude of the reflected ray is zero. It is at this angle that the refracted and reflected rays become perpendicular to each other. In connection with light this is ordinarily called the angle of polarization. For angles greater than this critical value the phase remains unchanged upon reflection, and the amplitude of the reflected ray gradually increases again until it reaches a maximum at perpendicular incidence.

When the reflecting medium is partially conducting the phenomenon becomes more complex but in general is somewhat similar. When the approaching wave is polarized in the plane of incidence, a phase shift of 180 degrees takes place at grazing incidence and the amplitudes before and after reflection are equal, but as the angle is increased the phase shift decreases and there is no angle at which the reflected ray is of zero amplitude. However, there is a definite angle at which this amplitude becomes a minimum. Further increase of the angle gives a stronger reflected ray and a further decrease in the phase shift. For a fixed dielectric constant the angle of minimum reflection becomes smaller as the conductivity of the medium is increased or the frequency of the wave is decreased. For very long wavelengths and a ground which is highly conducting, the angle at which minimum reflection takes place may be only an extremely small fraction of a degree to the horizon.

In Fig. 29 is shown a polar diagram of the coefficient of reflection for salt water for a frequency of 33.3 megacycles when the wave is vertically polarized. The conductivity is assumed to be  $10^{10}$  electrostatic units and the dielectric constant 80. For Long Island ground a curve is shown in Fig. 30. The conductance of Long Island soil, which is mostly dry sand, is so low (about  $5 \times 10^4$  electrostatic units) that its effect upon the reflection is negligible. Its dielectric constant is about 9. Under the assump-

tion as to conductivity, Fig. 30 holds for any frequency. However, Fig. 29 is representative for the frequency assumed.

For a horizontally polarized wave the coefficient of reflection, from a good conductor such as salt water, is nearly 100 per cent at all angles, and the phase shift changes gradually from 180 degrees at grazing incidence to about 178 degrees at perpendicular incidence. Hence a diagram for this condition is not worth showing.

For Long Island soil and horizontal polarization a curve of the reflection coefficient is given in Fig. 30 together with that for a wave polarized in the plane of incidence.

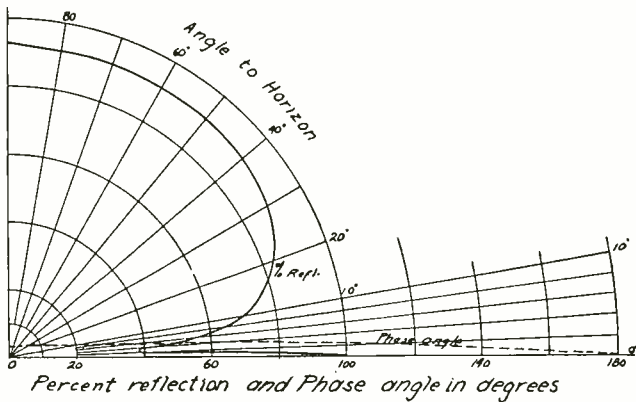

Fig. 29—Coefficient of reflection vs. angle to horizon for vertical polarization over salt water, 33.3 megacycles, assuming  $\xi = 80$ ,  $\sigma = 10^{10}$  electrostatic units.

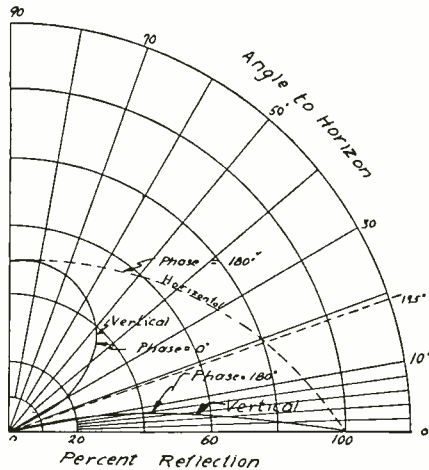

Fig. 30—Coefficient of reflection vs. angle to horizon for vertical and horizontal polarization for Long Island ground, assuming  $\xi = 9$ ,  $\sigma = 0$ .

The coefficient of reflection,  $K$ , is in general a complex quantity which may be expressed as:

$$K = Ae^{i\psi}$$

in which  $A$  is the ratio of the amplitude of the reflected to the incident wave and  $\psi$  is the phase shift between them. For polarization in the plane of incidence

$$K_V = \frac{\left(\epsilon - j\frac{2\sigma}{f}\right) \sin \phi - \sqrt{\epsilon - j\frac{2\sigma}{f} - 1 + \sin^2 \phi}}{\left(\epsilon - j\frac{2\sigma}{f}\right) \sin \phi + \sqrt{\epsilon - j\frac{2\sigma}{f} - 1 + \sin^2 \phi}} \quad (1)$$

For horizontal polarization

$$K_H = \frac{\sin \phi - \sqrt{\epsilon - j\frac{2\sigma}{f} - 1 + \sin^2 \phi}}{\sin \phi + \sqrt{\epsilon - j\frac{2\sigma}{f} - 1 + \sin^2 \phi}} \quad (2)$$

where,

- $\epsilon$  is the dielectric constant
- $\sigma$  is the conductivity in electrostatic units
- $\phi$  is the angle to the horizon
- $f$  is the frequency.

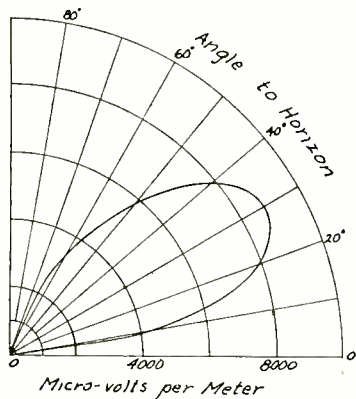

Fig. 31—Theoretical field strength vs. angle to horizon from horizontal Hertz doublet located one-half wavelength above salt water.  $f=33.3$  megacycles; power, 1 kilowatt; distance, 48 kilometers.

It may be of interest to show the theoretical resultant field strength with altitude for a given amount of power and at a



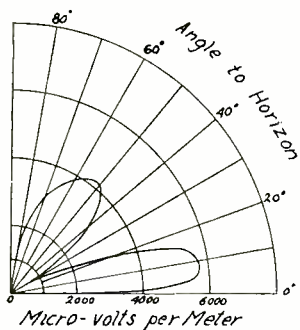

Fig. 32—Theoretical field strength vs. angle to horizon from vertical Hertz doublet located one-half wavelength above salt water.  $f = 33.3$  megacycles; power, 1 kilowatt; distance, 48 kilometers.

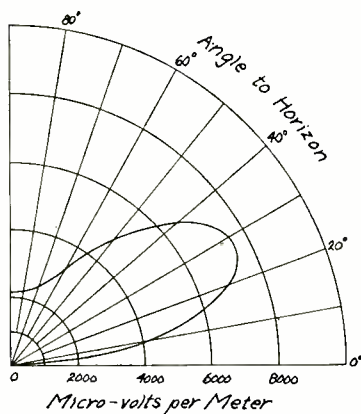

Fig. 33—Theoretical field strength vs. angle to horizon from horizontal Hertz doublet located one-half wavelength over Long Island ground.  $f = 33.3$  megacycles; power, 1 kilowatt; distance, 48 kilometers.

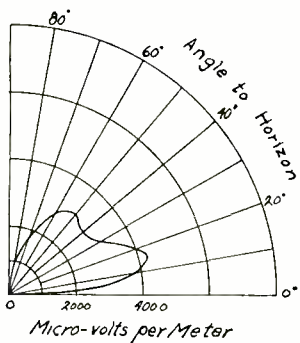

Fig. 34—Theoretical field strength vs. angle to horizon from vertical Hertz doublet located one-half wavelength over Long Island ground.  $f = 33.3$  megacycles; power, 1 kilowatt; distance, 48 kilometers.

fixed distance. For this purpose we shall take a distance of 48 kilometers, a wavelength of 9 meters and assume one kilowatt in a Hertz doublet located one-half wavelength above the ground or water, as the case may be. Fig. 31 shows the resulting field strength in microvolts per meter when the dipole is horizontal

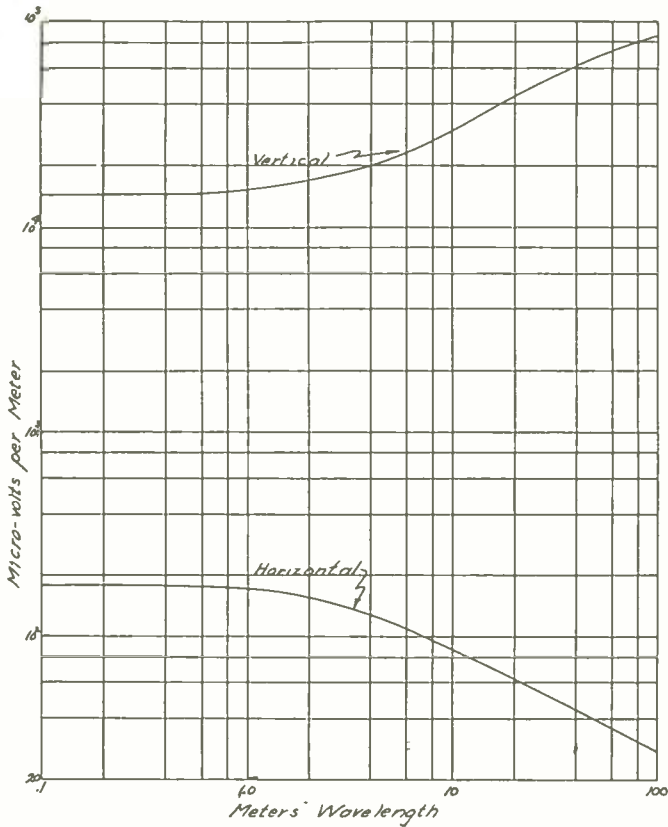

Fig. 35—Theoretical field strength vs. wavelength over salt water at a distance of 1 kilometer from a dipole 8 meters high radiating 1 watt for vertical and horizontal polarization. Receiving antenna height = 0.

and located above salt water. Fig. 32 is a similar curve for the same dipole located vertically above salt water. Figs. 33 and 34 are similar curves for a dipole located near Long Island ground.

Since the coefficient of reflection is dependent upon the frequency it is desirable to show its effect over salt water upon the received field strength at low angles. Fig. 35 shows the field strength at the surface (height = 0) vs. wavelength at a distance of one kilometer from a dipole at a height of eight meters

radiating one watt. It was previously stated that a high conductivity ground or a low frequency brings the reflected ray more nearly in phase with the direct ray at small angles with vertical polarization. This explains the rise of the curve with lower frequencies. With horizontal polarization there is no appreciable change in phase of the reflected ray with frequency, but the reflection becomes more efficient with decrease in frequency resulting in a lower field strength. The great difference between horizontal and vertical polarization over salt water at low angles may be seen from these curves.

At distances sufficiently great, neglecting curvature of the earth, certain approximations can be made. These result in the following formulas for field strength above poorly conducting ground, where " $h$ " is the height of the transmitting antenna and " $a$ " the height of the receiving antenna,  $E_d$  the direct field,  $\epsilon$  the dielectric constant, and  $r$  the distance.

For vertical polarization:

$$E_v = E_d \times \frac{1}{r} \sqrt{\frac{4\epsilon^2}{\epsilon - 1}(h + a)^2 + \left(\frac{4\pi ha}{\lambda}\right)^2} \quad (3)$$

or, for a half-wave dipole from which the radiated power is  $W$  watts

$$E_v = \frac{7\sqrt{W}}{r^2} \sqrt{\frac{4\epsilon^2}{\epsilon - 1}(h + a)^2 + \left(\frac{4\pi ha}{\lambda}\right)^2} \quad (4)$$

volts per meter for  $r$ ,  $h$ , and  $a$  in meters, only if

$$\frac{h + a}{r} < 0.05 \text{ and } \frac{4\pi ha}{\lambda r} < 0.05.$$

For horizontal polarization:

$$E_H = E_d \frac{1}{r} \sqrt{\frac{4(h + a)^2}{\epsilon - 1} + \left(\frac{4\pi ha}{\lambda}\right)^2} \quad (5)$$

or,

$$E_H = \frac{7\sqrt{W}}{r^2} \sqrt{\frac{4(h + a)^2}{\epsilon - 1} + \left(\frac{4\pi ha}{\lambda}\right)^2} \quad (6)$$

for a half-wave dipole under the same limiting conditions.

It will be noted that the factor by which the direct field must be multiplied to give the resultant total field varies as the inverse power of the distance. As the direct field is proportional to the

inverse power of the distance, the resultant field therefore varies as the inverse square of the distance.

For the actual case of a curved earth the same formulas may be used in a modified form. In the Appendix the modifications are derived, and it may be seen that the two heights  $a$  and  $h$  are replaced by new ones,  $a'$  and  $h'$ , which depend only upon the distance  $r$ ,  $a$ , and  $h$ .

The reflection laws discussed take no account of the diffraction effect. This makes the formulas of doubtful value for very small angles to the horizon and of no use for zero and negative angles. We should expect an appreciable signal at zero and negative angles from optical diffraction theory, but of a low order of intensity as compared to large positive ones.

It has been stated that for small positive angles the signal intensity drops off as the inverse square of the distance, and diffraction theory indicates a similar law below the line of sight. This should give a fairly uniform dropping off from positive to negative angles according to an inverse square law.

For this reason we might expect (3), (4), (5), and (6), without correction for earth curvature, to give a rough approximation of signal intensities at any distance.

The effects of reflection from poorly conducting ground are well brought out by the curves of Figs. 16, 17, 18, and 19. A dashed curve has been plotted corresponding to the inverse square law. It will be noted that the curves for 41.4 megacycles with either polarizations almost coincide with the theoretical curves. At 61 megacycles the solid curves representing the experimental data both lie above the theoretical curves, showing that the received signal strength was greater than that anticipated from the theory. Since the phase of a wave is reversed upon reflection from a poorly conducting ground, the direct and indirect rays tend to cancel for grazing angles of incidence. Obviously, attenuation of the reflected wave makes cancellation less perfect and increases the signal strength. A layer of vegetation constitutes a poor dielectric, the attenuation due to which, increases with frequency. In these tests the amount of brush along the surface of the ground was small, but it would appear that its effect was appreciable on the 61-megacycle frequency and little, if any, upon the 41.4-megacycle frequency. It might be of interest to use the ratio of field strength for horizontal and vertical polarization to determine the effective dielectric constant of the ground. For 41.4 megacycles the ratio is 13.5, and

for 61 megacycles, 13. From the theoretical considerations previously given it is apparent that this ratio should be equal to the dielectric constant for grazing angles of incidence. Some uncertainty exists in the effective heights of the horizontal and vertical receiving antennas used, so that the above conclusion is not reliable. The value 9 used in the theoretical curves was obtained from measurements of propagation along a wire pair buried in the soil under dry weather conditions.

In a paper by L. F. Jones entitled "Propagation of Wavelengths Between Three and Eight Meters," curves are shown giving the relationship between field strength and distance for the two transmitters in the Empire State Building on 44 and 61 megacycles. These curves show the result of a very large number of field strength measurements taken over a wide territory. These two curves have been replotted (Figs. 36 and 37) together with the theoretical ones, taking into account and neglecting the earth's curvature. In Fig. 36 for the 44-megacycle frequency

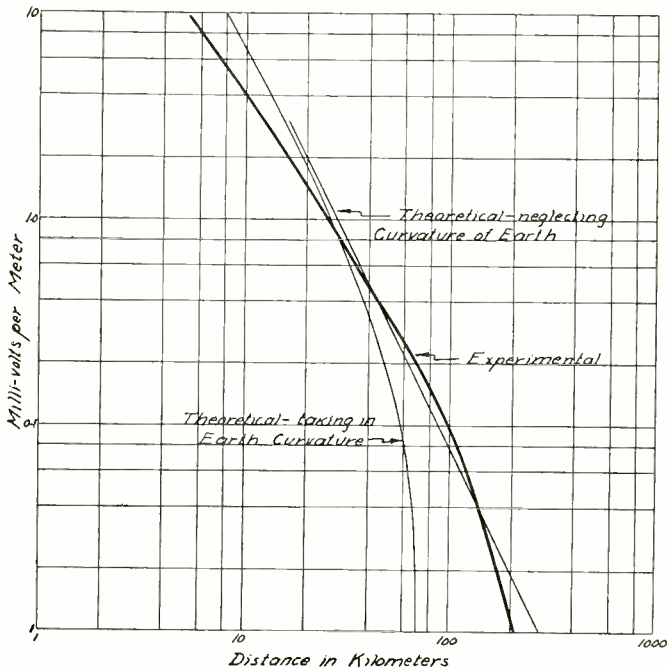

Fig. 36—Comparison of measured with theoretical field strength from the Empire State 44-megacycle transmitter. Radiation 2 kilowatts.

the theoretical curve neglecting the earth's curvature agrees quite well with the experimental measurements whereas the

curve taking into account the earth's curvature gives field strengths very much too low for large distances. This fact shows that neglecting the curvature of the earth approximately corrects for the effects of diffraction. In Fig. 37 the experimental curve lies between the two theoretical ones at the larger distances, indicating a smaller amount of diffraction with the higher frequency which is to be expected.

In many of the observations of the Empire State transmitters by airplane the height of the receiving and transmitting antennas was large enough to invalidate the approximate method of determining the field strength. When a transmitting antenna is located many wavelengths above ground it is obvious that a large number of maximum and minimum field intensity areas will be set up due to the combination of the direct and reflected rays. Referring to Fig. 28 it may be seen that when the phase angle of the reflected ray, with reference to the direct ray, is zero, addition takes place producing a strengthened field, and

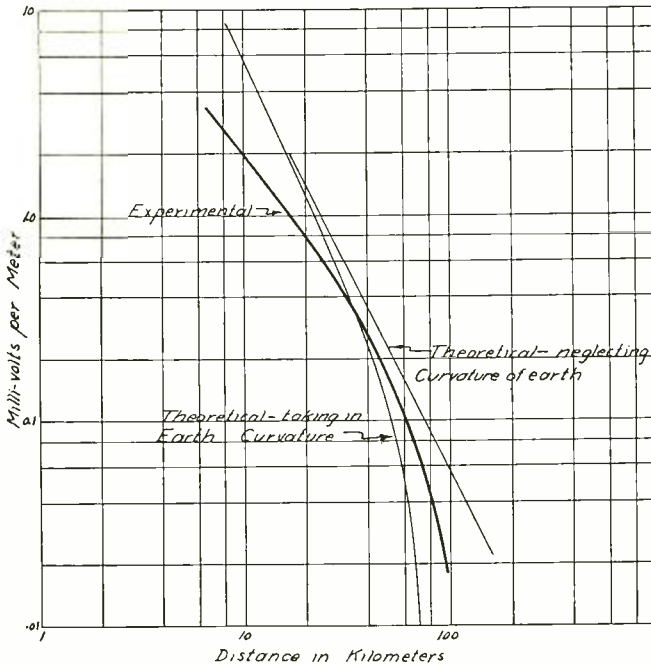

Fig. 37—Comparison of measured with theoretical field strength from the Empire State 61-megacycle transmitter. Radiation 1 kilowatt.

when the angle is 180 degrees, subtraction occurs, giving a weakened field. This phase angle is determined by the sum of the

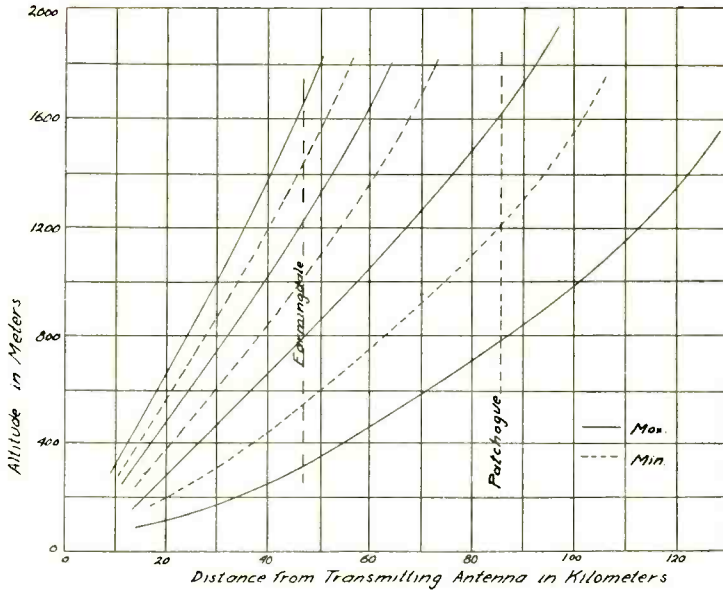

Fig. 38—Theoretical curves showing location of maximum and minimum field strengths produced by the Empire State 44-megacycle transmitter.

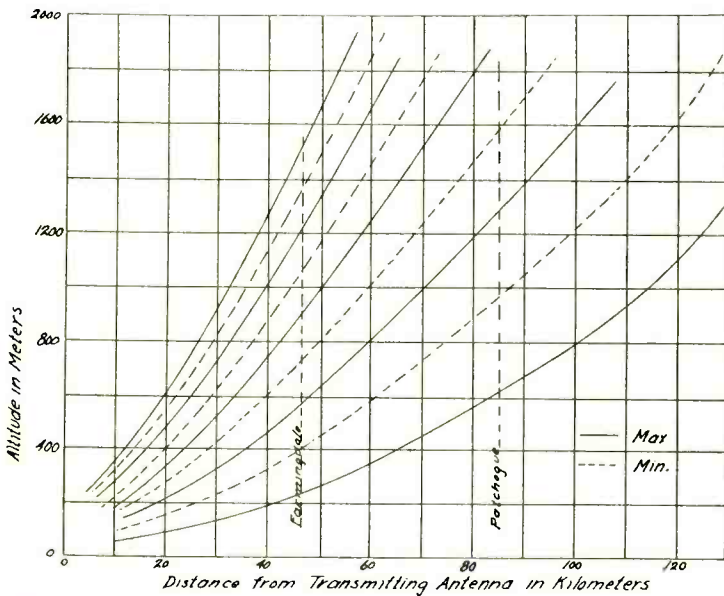

Fig. 39—Theoretical curves showing location of maximum and minimum field strengths produced by the Empire State 61-megacycle transmitter.

phase angles due to the phase shift at reflection and that produced by the difference in length of path between the direct and reflected rays. Since for Long Island ground the phase shift at reflection is practically 180 degrees, for reflection angles up to 19.5 degrees, the difference in length of path of the two rays is the determining factor for the interference patterns. Figs. 38 and 39 show families of curves taking into account the effect of the earth's curvature showing the location of these maximum and minimum field strength areas for 44 and 61 megacycles, and a transmitting antenna located 373 meters above ground. This is to correspond with the average conditions of reception on Long Island from the Empire State antenna. Although the actual height of this antenna above sea level is 396 meters, the average height above Long Island territory is about 23 meters less, as can be seen by inspection of the profile map. A small difference in the height above sea level at which reflection takes place has a large effect upon the altitude at which the maximum or minimum field strength will be received. It is of interest to compare the theoretical data with the experimental, which have already been shown. (Figs. 4, 5, 11, 12, and 13.) The tables below show a comparison of the theoretical heights for maximum and minimum field strength with the experimental at several distances from the transmitter.

TABLE I

<i>44 Megacycles</i>		
46.6 Kilometers from N. Y. (Farmingdale)		
Field Strength	Observed Altitude (meters)	Theoretical Altitude (meters)
Maximum	270-300	300
Minimum	550-580	530
Maximum	760-880	780
Minimum	990-1070	990
85.3 Kilometers from N. Y. (Patchogue)		
Maximum	670-790	760
Minimum	1000-1200	1190
<i>61 Megacycles</i>		
46.6 Kilometers from N. Y. (Farmingdale)		
Maximum	270	240
Minimum	460	400
Maximum	880(?)	560
85.3 Kilometers from N. Y. (Patchogue)		
Maximum	500-670	610
Minimum	940-1000	970
Maximum	1220(?)	1300
114 Kilometers from N. Y. (Suffolk Airport)		
Maximum	970-1130	990
Minimum	1300(?)	1500



It will be noted that for transmission at 44 megacycles the theoretical and actual minima and maxima are in very good agreement. At 61 megacycles there is such a rapid succession of minor interference effects taking place that a comparison between theoretical and actual results is difficult to make. Although the positions of maxima and minima check very well with theory it will be noted that the ratio of maximum to minimum amplitudes is very much less than that which would be predicted by theory. In fact, this ratio corresponds to a coefficient of reflection which, on the average, is not over 60 per cent. Theory would give values ranging from 85 to 92 per cent for the distances considered. The actual conditions are no doubt considerably more complex than those assumed in the theory. The wave which is reflected from ground must first be propagated through what we might term a transition medium consisting of trees, brush, buildings, telephone and power wires, etc. This would cause considerable attenuation of the indirect ray both before and after reflection, thus giving a much more imperfect field cancellation than under the conditions of a perfectly smooth surface having no transition layer above it.

In Fig. 9 the theoretical curve showing the variation in field strength at a constant elevation of 1200 meters has been plotted along with the experimental data from the Empire State observations. The close agreement between the positions of the actual and theoretical maximum and minimum field strength areas is quite striking.

The curves in Figs. 22 and 23 show the theoretical and observed field strengths over salt water for a radiated power of 1.8 and 2.5 watts on 59.7 megacycles. The constants of salt water were assumed as  $\epsilon = 80$  and  $\sigma = 10^{10}$  electrostatic units. It will be noted that the theoretical curves fall considerably below the experimental at the greater distances. Some doubt exists as to the reliability of the absolute values of measured field strength but it is felt that the relative values are good for any one curve.

The ratio between the intensity for vertical and horizontal polarization at a distance of 3000 meters, assuming the curve for horizontal polarization extended, is 300, correcting for difference in power. This should be approximately equal to  $2\sigma/f$  or 334 when  $\sigma$  is taken as  $10^{10}$  electrostatic units. This value of  $10^{10}$  electrostatic units is the average of the data given by a number of investigators. However, a recent measurement of resistivity

gave a value of 22 ohms per centimeter cube, which is equivalent to a conductivity of  $4 \times 10^{10}$  electrostatic units.

Since the ratio of field intensity for vertical polarization to that for horizontal over salt water is 334 at 59.7 megacycles, a horizontal transmitting dipole, tilted by an angle of  $1/334$  radian, or 0.17 degree, would give equal vertical and horizontal components at the receiving antenna. This probably accounts for the possibility of receiving a signal from a horizontal antenna on a vertical one as a slight tilt would be unnoticed. A slight unbalance in the feeding currents to the transmitting antenna would result in a vertical component in the radiated wave.

Fig. 24, showing another vertical polarization test on 59.7 megacycles, gives information over a greater distance than Fig. 23. Here the theoretical curve falls very much below the experimental one due probably to a faulty receiver calibration of absolute field strength values. There has been no opportunity to find the discrepancy between the absolute values of Figs. 23 and 24. Fig. 25 giving the results of the 33.4-megacycle run using vertical polarization, shows less attenuation than the higher frequency run, Fig. 24, which is to be expected.

In addition to the effects of diffraction upon the signal at distances where the receiver is below the horizon, it is well to consider the effects of refraction. In general, the dielectric constant of the air changes with altitude to such an extent that a ray of light is bent downward with a radius of curvature of about 5.7 times the earth's radius.<sup>3</sup> This gives a condition equivalent to that of an earth with a 21 per cent larger radius. This condition is subject to considerable variation due to temperature changes in the air. At night the temperature changes in the atmosphere are different from those existing during the daytime, which might account for increased refraction and a consequent increase of signal at night.

Propagation over land generally takes place partly through a transition layer of vegetation. Trees give the effect of a gradual increase in the dielectric constant from that of air at a height of around 50 feet at the tree tops to some higher value near the ground, where the vegetation is more dense. The conductivity undergoes a similar change from zero at the tree tops to a finite value near the ground. Under such conditions, a wave propagated through this medium must follow a curved path. If the effective dielectric constant changes from 1 to 1.002 in a

<sup>3</sup> Humphreys, "Physics of the Air," p. 450.

distance of 50 feet, the radius of curvature of a ray will be approximately equal to the radius of the earth. Considerable attenuation must also take place through this medium, the lower rays being attenuated the most.

The resultant field intensity below the horizon is due to the combination of all the diffraction and refraction effects. It is obvious that the effects mentioned are capable of producing considerable bending of the rays beyond the horizon so that the signal intensity shows no sudden change with altitude as the horizon is passed.

### CONCLUSION

It seems reasonable to assume that the field strength values of waves below 10 meters can be calculated with reasonable accuracy since there is no sky wave phenomenon to consider. The foregoing experimental results indicate that we may approximately predict the field strength under various conditions. It should be mentioned that it is quite difficult to obtain an accurate calibration of the receiver in terms of absolute field strength at these high frequencies. This is especially true when the receiver and its antenna are installed in an airplane or a boat.

The superiority of vertical as compared with horizontal polarization over salt water with low antennas has been pointed out. However, this should not be misconstrued to indicate that such a relation necessarily holds true for high antennas. Previous tests in the Hawaiian Islands<sup>1</sup> have indicated no appreciable difference between vertical and horizontal polarization tests when using high antennas located several thousand feet above sea level.

A considerable amount of study of high-frequency propagation still remains to be done. It is felt that further knowledge will enable us to predict results with considerable accuracy under various conditions encountered in practice.

### ACKNOWLEDGMENT

We are indebted to several engineers of R.C.A. Communications, Inc., for their help in obtaining data. Mr. G. W. Wickizer obtained many of the airplane observations as well as assisting in the salt water tests. Mr. D. R. Goddard furnished his boat, and together with Mr. G. E. Hansell also assisted with the salt water tests. Mr. N. E. Lindenblad and Mr. O. E. Dow furnished transmission on 435 and 34 megacycles while Mr. R. W. George

made observations on 435 megacycles. This work was under the supervision of Mr. H. H. Beverage, Chief Research Engineer, and Mr. H. O. Peterson, who gave valuable suggestions.

We also acknowledge the valuable cooperation of the NBC engineers for the transmissions on 44 and 61 megacycles from the Empire State building.

#### APPENDIX

##### 1. Theory of Reflection

Although the theory of reflection of electromagnetic waves is well known<sup>1</sup> a brief development will be given here for the sake of completeness before deriving the formulas made use of in connection with the particular conditions of propagation treated.

As general laws, we have Maxwell's equations:

$$-\frac{\mu}{c} \frac{d\mathbf{H}}{dt} = \text{curl } \mathbf{E} \quad (1)$$

$$\left(4\pi\sigma + \epsilon \frac{d}{dt}\right) \frac{\mathbf{E}}{c} = \text{curl } \mathbf{H} \quad (2)$$

where  $E$  and  $H$  are the electric and magnetic forces in electrostatic and electromagnetic units, respectively,  $\mu$  the permeability,  $\epsilon$  the dielectric constant,  $\sigma$  the conductivity in electrostatic units, and  $c$  the velocity of light.

When  $E$  and  $H$  are sinusoidal and represented by the real part of  $E'e^{j\omega t}$  or  $H'e^{j\omega t}$   $d/dt = j\omega$  and the two fundamental equations become:

$$-j \frac{\omega\mu}{c} \mathbf{H} = \text{curl } \mathbf{E} \quad (3)$$

$$\left(\frac{4\pi\sigma + j\omega\epsilon}{c}\right) \mathbf{E} = \text{curl } \mathbf{H}. \quad (4)$$

It is convenient to take care of a partially conducting medium by thinking of a complex dielectric constant  $\epsilon_0 = \epsilon - j(2\sigma/f)$  in which case the relations for conducting and nonconducting mediums become the same. In this discussion we shall assume  $\mu = 1$  under all conditions. The relations (3) and (4) then become:

$$-j \frac{\omega}{c} \mathbf{H} = \text{curl } \mathbf{E} \quad (5)$$

$$j \frac{\omega}{c} \epsilon_0 \mathbf{E} = \text{curl } \mathbf{H}. \quad (6)$$

<sup>1</sup>Drude, "Theory of Optics"; Jeans, "Mathematical Theory of Electricity."

These relations result in the wave equations:

$$\nabla^2 \mathbf{E} = -\frac{\omega^2}{c^2} \epsilon_0 \mathbf{E} \text{ and } \nabla^2 \mathbf{H} = -\frac{\omega^2}{c^2} \epsilon_0 \mathbf{H}. \quad (7)$$

For a plane wave the solution is

$$E = E' e^{j\omega(t-d/v)} \quad (8)$$

where  $V = C/\sqrt{\epsilon_0}$  = the velocity and  $d$  is the distance of travel from the position of reference for the time  $t$ . A similar equation holds for  $H$ .

In Fig. 40 let the  $ZY$  plane be the boundary between free space designated as (1) and a medium (2) having a generalized dielectric constant  $\epsilon_0$ . Assume that the electric field  $E$  of the incident wave lies in the  $XY$  plane or plane of incidence and that the ray makes an angle of incidence  $\theta_1$  to the  $X$ -axis. This ray must divide into a refracted and reflected ray at angles  $\theta_2$  and  $\theta_3$  to the  $X$ -axis.

We may now write (8) in terms of the components, putting  $d$  in terms of  $X$  and  $Y$  and the direction cosines. Then:

$$E_{x1} = E_{x1}' e^{j\omega(t - (x_1 \cos \theta_1 + y_1 \sin \theta_1) / V_1)} \quad (9)$$

$$E_{y1} = E_{y1}' e^{j\omega(t - (x_1 \cos \theta_1 + y_1 \sin \theta_1) / V_1)} \quad (10)$$

$$H_1 = H_1' e^{j\omega(t - (x_1 \cos \theta_1 + y_1 \sin \theta_1) / V_1)}. \quad (11)$$

Similar relations are also true of the reflected and refracted waves. The following conditions must be satisfied at the boundary:

1. The tangential components of electric and magnetic force must be continuous.

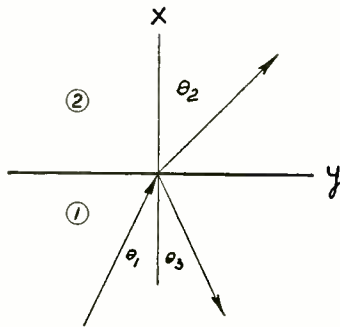

Fig. 40

2. The normal components of electric displacement and magnetic induction must be continuous.

Therefore,

$$E_{x1} + E_{x3} = \epsilon_0 E_{x2} \quad (12)$$

$$E_{y1} + E_{y3} = E_{y2} \quad (13)$$

$$H_1 + H_3 = H_2. \quad (14)$$

These relations can be satisfied only if

$$\frac{\sin \theta_1}{V_1} = \frac{\sin \theta_2}{V_2} = \frac{\sin \theta_3}{V_3}. \quad (15)$$

Hence  $\sin \theta_1 = \sin \theta_3$  but  $\theta_3$  cannot be identical with  $\theta_1$ , so

$$\theta_3 = 180 \text{ degrees} - \theta_1 \quad (16)$$

and,

$$\cos \theta_3 = -\cos \theta_1. \quad (17)$$

Also from the fundamental relations (5) and (6) we have

$$j\omega\epsilon_0 E_x = \text{curl}_x H = -j\frac{\omega}{V} H \sin \theta \quad (18)$$

$$j\omega\epsilon_0 E_y = \text{curl}_y H = j\frac{\omega}{V} H \cos \theta \quad (19)$$

$$-j\frac{\omega}{c} H = \text{curl}_x E = -j\frac{\omega}{V} E_y \cos \theta + j\frac{\omega}{V} E_x \sin \theta \quad (20)$$

for all three rays.

Hence,

$$\frac{E_x}{\sin \theta} = \frac{-E_y}{\cos \theta} = \frac{H_z}{\sqrt{\epsilon_0}} \text{ for all three rays.} \quad (21)$$

Combining these relations we get

$$-H_1 \cos \theta_1 + H_3 \cos \theta_3 = \frac{-H_2 \cos \theta_2}{\sqrt{\epsilon_0}} \quad (22)$$

$$H_1 + H_3 = H_2 \quad (14)$$

or,

$$\frac{H_3}{H_1} = \frac{1 - \frac{\cos \theta_2}{\sqrt{\epsilon_0} \cos \theta_1}}{1 + \frac{\cos \theta_2}{\sqrt{\epsilon_0} \cos \theta_1}} = \frac{\sqrt{\epsilon_0} \cos \theta_1 - \cos \theta_2}{\sqrt{\epsilon_0} \cos \theta_1 + \cos \theta_2} \quad (23)$$

but,

$$\sin \theta_2 = \frac{\sin \theta_1}{\sqrt{\epsilon_0}}. \quad (24)$$

Hence,

$$\cos \theta_2 = \sqrt{1 - \frac{\sin^2 \theta_1}{\epsilon_0}} = \sqrt{\frac{\epsilon_0 - \sin^2 \theta_1}{\epsilon_0}} \quad (25)$$

and,

$$K_V = \frac{H_3}{H_1} = \frac{\epsilon_0 \cos \theta_1 - \sqrt{\epsilon_0 - \sin^2 \theta_1}}{\epsilon_0 \cos \theta_1 + \sqrt{\epsilon_0 - \sin^2 \theta_1}} \quad (26)$$

where,

$$\epsilon_0 = \epsilon - j \frac{2\sigma}{f}$$

In terms of the angle  $\phi$  to the boundary plane, since  $\phi = 90$  degrees  $-\theta$ , we obtain

$$K_V = \frac{\epsilon_0 \sin \phi - \sqrt{\epsilon_0 - 1 + \sin^2 \phi}}{\epsilon_0 \sin \phi + \sqrt{\epsilon_0 - 1 + \sin^2 \phi}} \quad (27)$$

For horizontal polarization a similar procedure gives:

$$K_H = \frac{\sin \phi - \sqrt{\epsilon_0 - 1 + \sin^2 \phi}}{\sin \phi + \sqrt{\epsilon_0 - 1 + \sin^2 \phi}} \quad (28)$$

## 2. Approximation for Field at a Receiver

Let "h" be the height of the transmitting antenna, "a" of the receiving antenna, r the intervening distance, and  $\phi$  the angle to the ground of the reflected ray,  $r_1$  the length of the path of the direct ray, and  $r_2$  that of the reflected ray. (See Fig. 28.) The difference  $\Delta$  in length of the two paths is then

$$\Delta = r_2 - r_1 \quad (29)$$

but,

$$r_2^2 = r^2 + (h + a)^2 \text{ and } r_1^2 = r^2 + (h - a)^2. \quad (30)$$

When r is large compared to  $a + b$

$$r_2 = r + \frac{1}{2} \frac{(h + a)^2}{r} \quad (31)$$

$$r_1 = r + \frac{1}{2} \frac{(h - a)^2}{r} \quad (32)$$

and  $\Delta = r_2 - r_1 = \frac{2ah}{r}$  and the phase angle  $\psi = \frac{2\pi}{\lambda} \Delta = \frac{4\pi ah}{\lambda r}$ . (33)

Also, when  $r$  is large compared to  $a$  and  $h$  we may write

$$\sin \phi = \phi = \frac{h+a}{r} \quad (34)$$

For horizontal polarization we then obtain

$$\begin{aligned} K_H &= \frac{\sin \phi - \sqrt{\epsilon_0 - 1 + \sin^2 \phi}}{\sin \phi + \sqrt{\epsilon_0 - 1 + \sin^2 \phi}} \approx \frac{\phi - \sqrt{\epsilon_0 - 1}}{\phi + \sqrt{\epsilon_0 - 1}} \\ &\approx - \left( 1 - \frac{2}{r} \frac{(h+a)}{\sqrt{\epsilon_0 - 1}} \right) \end{aligned} \quad (35)$$

and,

$$\begin{aligned} K_V &= \frac{\epsilon_0 \sin \phi - \sqrt{\epsilon_0 - 1 + \sin^2 \phi}}{\epsilon_0 \sin \phi + \sqrt{\epsilon_0 - 1 + \sin^2 \phi}} \\ &\approx - \left( 1 - \frac{2\epsilon_0(h+a)}{r\sqrt{\epsilon_0 - 1}} \right) \text{ when } \frac{h+a}{r} \ll \left| \frac{1}{\sqrt{\epsilon_0}} \right|. \end{aligned} \quad (36)$$

For the field at the receiver we then have for horizontal polarization

$$\begin{aligned} E_H &\approx E_d(1 + K_{He^{i\psi}}) \approx E_d \left[ 1 - \left( 1 - 2 \frac{h+a}{r\sqrt{\epsilon_0 - 1}} \right) e^{i\psi} \right] \\ &\approx E_d e^{i\psi/2} \left[ 2 \frac{h+a}{r\sqrt{\epsilon_0 - 1}} - j \frac{4\pi}{\lambda} \frac{ha}{r} \right] \text{ when } \frac{4\pi ha}{\lambda r} < 0.05. \end{aligned} \quad (37)$$

For vertical polarization

$$\begin{aligned} E_V &\approx E_d e^{i\psi/2} \left[ \frac{2\epsilon_0(h+a)}{r\sqrt{\epsilon_0 - 1}} - j \frac{4\pi}{\lambda} \frac{ha}{r} \right] \text{ when } \frac{h+a}{r} \ll \left| \frac{1}{\sqrt{\epsilon_0}} \right| \\ &\text{and when } \frac{4\pi ah}{\lambda r} < 0.05. \end{aligned} \quad (38)$$

For Long Island ground or other conditions where the conductivity may be neglected  $\epsilon_0 = \epsilon$  and we have for the effective value of the field

$$E_H = \frac{E_d}{r} \sqrt{\frac{4(h+a)^2}{\epsilon - 1} + \left( \frac{4\pi ha}{\lambda} \right)^2} \text{ when } \frac{4\pi ha}{\lambda r} < 0.05 \quad (39)$$

and,

$$E_V = \frac{E_d}{r} \sqrt{\frac{4\epsilon^2(h+a)^2}{\epsilon - 1} + \left( \frac{4\pi ha}{\lambda} \right)^2} \text{ when } \frac{4\pi ha}{\lambda r} < 0.05. \quad (40)$$



The direct field from a half-wave dipole is  $7 (\sqrt{W}/r)$  volts per meter for a distance  $r$  in meters and a radiated power  $W$  in watts. For a dipole considerably shorter than a half wavelength the direct field is  $6.7 (\sqrt{W}/r)$  volts per meter. For long Island ground where  $\epsilon=9$  we then get for the field from a half-wave dipole:

$$E_V = 44.5 \frac{\sqrt{W}}{r} \text{ volts per meter} \tag{41}$$

$$E_H = 4.95 \frac{\sqrt{W}}{r} \text{ volts per meter if } \frac{2\pi ha}{r} \ll \left(\frac{h+a}{2}\right)^2. \tag{42}$$

For salt water if  $\epsilon=80$  and  $\sigma=10^{10}$  electrostatic units

$$\epsilon_0 = \left(80 - j \frac{2 \times 10^{10}}{f}\right). \tag{43}$$

It is roughly correct to assume  $\epsilon_0 - 1 \approx \epsilon_0$ .  
Then,

$$\frac{\epsilon_0}{\sqrt{\epsilon_0 - 1}} \approx \sqrt{\epsilon_0}. \tag{44}$$

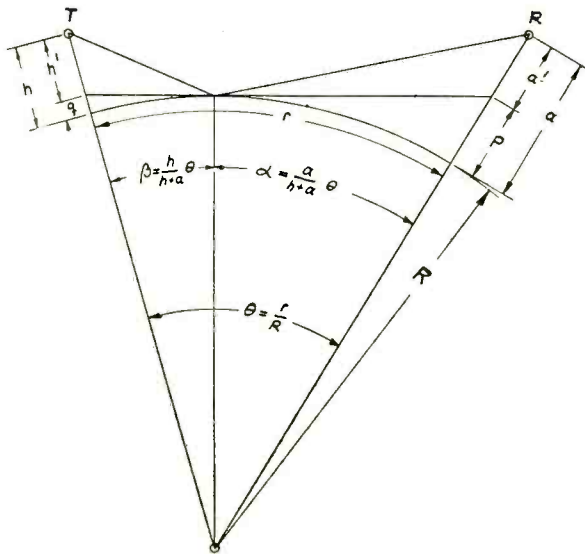

Fig. 41

### 3. Effect of Earth's Curvature

The preceding formulas for field strength may be used for the curved surface of the earth by using corrected heights  $h'$  and  $a'$  where  $h' = h - p$  and  $a' = a - q$  where

$$p = \frac{r^2}{2R} \left( \frac{h}{a+h} \right)^2 \quad (45)$$

and,

$$q = \frac{r^2}{2R} \left( \frac{a}{a+h} \right)^2 \quad (46)$$

in which  $R$  is the radius of the earth. Referring to Fig. 41 it is apparent that we may write the following approximate relations

$$\alpha = \frac{a}{a+h} \theta, \quad \beta = \frac{h}{a+h} \theta \quad (47)$$

$$p = \frac{R}{\sqrt{1 - \sin^2 \alpha}} - R = R \times \frac{\alpha^2}{2} \quad (48)$$

$$q = \frac{R}{\sqrt{1 - \sin^2 \beta}} - R = R \times \frac{\beta^2}{2}. \quad (49)$$

Then,

$$p = \frac{r^2}{2R} \left( \frac{h}{a+h} \right)^2 \quad (50)$$

and,

$$q = \frac{r^2}{2R} \left( \frac{a}{a+h} \right)^2. \quad (51)$$

# A STUDY OF TELEVISION IMAGE CHARACTERISTICS

By

E. W. ENGSTROM

(RCA Victor Company, Inc., Camden, New Jersey)

*Summary*—An investigation was carried out to obtain quantitative information on the several characteristics of television images, particularly those relating to image detail. The tests were conducted largely through the use of equivalents so as to provide sufficient range of measurement. Such data are of value in establishing operating standards, determining satisfactory performance, and in guiding development work. It was found possible to define satisfactory television image characteristics for those items studied. The results are given in such form as to be readily applicable to practical conditions.

## INTRODUCTION

**B**ECAUSE of the lack of quantitative measures of performance, expression of the degree of satisfaction provided by a television image has been bounded on one hand by the optimism or conservatism of the observer, and on the other hand by the practical limitations which prevent for the moment an increase of picture detail, picture steadiness, picture illumination, picture contrast, and frame repetition frequency. It is the purpose of this paper to describe investigations made regarding some of these picture properties.

Picture detail is determined by the quantity of information that the entire system can handle in a given time. Also, the communication band is proportional to the frame repetition frequency. (Frame repetition frequency determines steadiness of action and picture flicker.) Optical, sensitivity, and transformation problems are present in the pick-up gear and become apparent as attempts are made to go beyond present practical limits. Somewhat similar problems are present in the reproducing elements. These limits are contingent upon the particular state of the art, and, therefore, are constantly receding and yielding to development.

Since the frequency band required is proportional to the quantity of information to be transmitted, the limitations of the electrical channels must be considered. These problems include

Reprinted from Proceedings of the Institute of Radio Engineers.

the ability to handle wide frequency bands and to provide space in the radio spectrum for television channels. This may be illustrated by the following table for certain conditions which are stated.

*Aspect Ratio* 1.33 (4×3).

*Frame Repetition Frequency* 24 per second.

*Picture Frequency*

It is assumed that the picture resolution along the scanning line is approximately the same as the width of the scanning line (square picture elements) and that each picture element (of maximum resolution) requires one-half cycle for transmission in elemental form. The maximum picture frequency, therefore, determines the steepness of wave front of change in contrast along the scanning line.

It is also assumed that pictures will be transmitted for ninety per cent of the total time, the remaining ten per cent being necessary for control functions.

Scanning Lines	Picture Elements	Maximum Picture Frequency	Maximum Picture Communication Band
60	4,798	63,970	127,900
120	19,200	256,000	512,000
180	43,190	576,000	1,152,000
240	76,780	1,024,000	2,048,000
360	172,800	2,302,000	4,604,000
480	307,100	4,094,000	8,188,000

The limitations present in the electrical circuit are also determined by the state of the art at any particular time, and, therefore, are subject to advances as a result of development. It is probable that the ultimate limit may be the space available for television channels in the radio spectrum.

#### GENERAL CONSIDERATION OF IMAGE CHARACTERISTICS

Determination of satisfactory picture quality in television images is difficult because of the inadequacy of present television apparatus for such a study and because the reactions involved are largely psychological and physiological. During the growth of television detail, as the development work has progressed, improvement of picture quality has been noted, for example, through stages of *a*, *2a*, *3a*, and *4a* scanning lines, where *4a* represents the present practical limits. We are not in a position to work with and study *5a*, *6a*, etc., scanning lines in such a determination. Therefore, in studies of picture detail, picture size, and viewing distance, many subterfuges have been used.

Because of the wealth of detail, extreme ranges of brightness,

and contrast in nature, the eye tends to demand image resolution up to the acuity and perception limits of the eye. We have, however, become accustomed to certain compromises in these image characteristics through long association with paintings, photographs, projected transparencies, and other forms of reproduction, because of the limitations of these agencies of reproduction.

The perception of form or acuity of the eye is usually defined as the minimum angular separation which permits resolution of two point objects. For the average normal eye this approximates one minute of arc for that portion of the field which falls on the fovea of the retina. Other measures include minimum dimensions for seeing a point, line, or separation between two lines or groups of lines, change of contour, etc. Some of these become rather indefinite if the object is self-luminous. Other eye char-

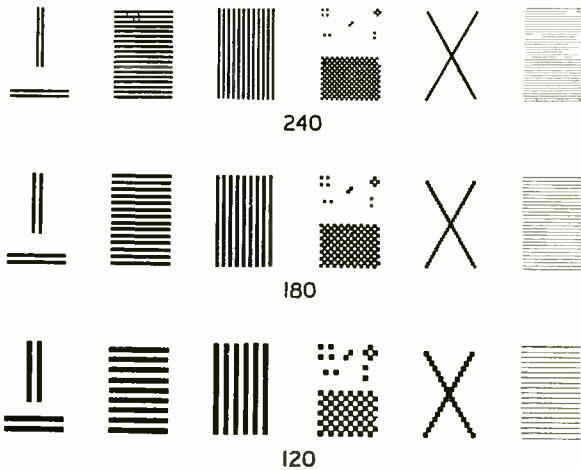

Fig. 1

acteristics of interest in such a study include perception of movement, perception of contrast, color vision, color sensitivity, perception of light, and effects of flicker.

Elementary studies of some properties of vision may be made through the use of the chart indicated by Fig. 1. This chart includes a group of patterns which may be obtained from the scanning system used in television. The numbers under each group indicate the total number of scanning lines for the height of the chart. This chart assumes equal horizontal and vertical resolution for the groups of five figures to the left of the chart. It also assumes that the scanning lines will coincide

40 foot candles. The contrast on the charts was the maximum possible in a normal photographic print.

The pairs of lines to the left of the chart were used to obtain data for the first curve. For each degree of "scanning line detail" a viewing distance was chosen at which the two lines could just be resolved; at greater distances the two lines blurred into one. At this same viewing distance the group of horizontal and the group of vertical lines (the second and third groups of figures from the left) could just be resolved into lines; at greater distances they blurred into a uniform gray. The curve plotted in Fig. 3 is the average for the three observers. A curve was plotted for resolving the two squares, a part of the fourth group from the left (the two squares at the left, just above the checkerboard pattern). A curve was plotted for resolving the checkerboard pattern, in the lower half of the fourth figure from the left. A curve was also plotted for the crossed lines, the fifth figure from the left. In this case the viewing distance chosen was the point at which the line structure could just be seen; at greater viewing distances the line structure was missing, and the cross appeared to be made up of two straight lines of constant width. All of the curves were plotted using the average viewing distance for the three observers. An interesting point noted from the observations was the consistency of the viewing distances chosen. Two of the observers picked viewing distances very nearly the same. The third observer picked viewing dis-

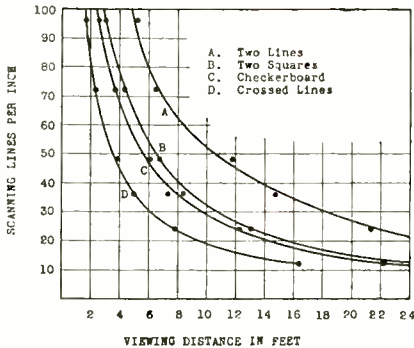

Fig. 3

tances slightly greater (10 to 20 per cent). In the case of the third observer, this difference was consistent for all of the tests. These curves indicate the range of satisfactory viewing distances for the types of detail chosen. In general, the detail types prob-

ably do not cover the extremes, but do cover at least the average range encountered in scanned television images. Some interesting deductions may be made by comparing these data with the theoretical curves for one-half, one, and two minutes of arc separations between center lines of scanning paths. For convenience these curves are shown in Fig. 4, superimposed. The data from the observations are indicated by a dark band including the span between the test for the two lines and the test for the crossed lines of the previous curves. The one-half-, one-, and two-minute arc curves are shown as solid lines. The data presented in Fig. 4 indicate that the types of detail on which the tests were made require, for any chosen viewing distance, a range of from a little over one-half minute to a little less than two minutes of arc separation between centers of scanning lines. It is also indicated that the average acuity of the three observers is above that of the "average eye"—near the upper limit of acuity. From the standpoint of these tests and the tests to follow, this is a safe condition because, for any viewing distance, detail satisfactory to this group of three observers will certainly be satisfactory to the average observer.

In viewing reproductions the observer tends to position himself so that he is satisfied regarding the information and the effect he wishes to obtain. (The position or viewing distance for greatest resolution is about eight to ten inches for the average person.) Because of habit and experience we have learned to temper our acuity demands. The following generalizations are of interest, and are given in terms of general experience rather than technical knowledge. When viewing a painting we

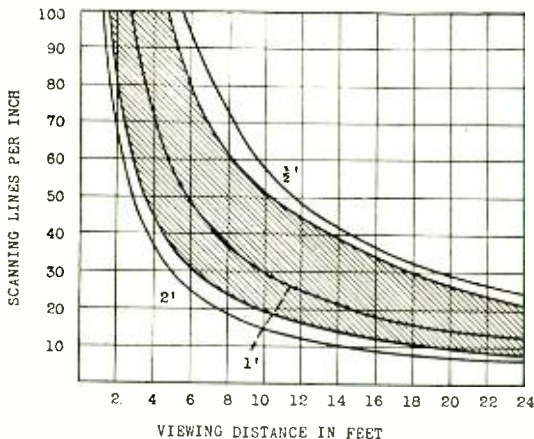

Fig. 4

rather unconsciously choose a position where the brush stroke detail becomes unnoticeable, and where we obtain the effect the artist wished to convey. We have learned that a newspaper illustration contains only a certain amount of detail, and that such illustrations will not bear close inspection. We also know in general what to expect from motion pictures of the theater and home types. We, further, know that good photographs go beyond the acuity limits of the eye, and that the field may be optically enlarged to improve the resolution. Other examples could be given, but the above are sufficient to illustrate the effect of experience on the average person.

The value of the above curves is to indicate the maximum useful detail from the standpoint of eye acuity, assuming favorable conditions for all other related factors. For a particular viewing distance, the amount of detail required in a reproduction (still image) is dependent upon the type of information to be conveyed by the picture. Since this varies, it is safe to assume that, for limiting conditions, detail corresponding to that indicated by the curves should be provided. For average conditions and for general use it is also safe to assume that sufficient satisfaction can be provided by considerably less detail than that indicated. This is verified by the various types of printed reproductions.

#### DETERMINATION OF SCANNING LINES, PICTURE SIZE, AND VIEWING DISTANCE FOR TELEVISION IMAGES

It is difficult to interpret television image quality in terms of the relationships discussed. The first reason for this is that television images are the result of scanning at the pick-up end which introduces an aperture effect, and at the reproducing end the aperture effect is introduced for the second time. This results in a definite and peculiar line and detail structure. Detail along each line is dependent upon the ability of the system to reproduce changes in contrast. The second reason is that television images are made up of rapidly superimposed, individual pictures much the same as motion pictures. The third reason is that television images usually include motion having certain continuity. The effects of motion will be taken up more in detail later in the paper.

Photographs have been made which consist of scanned reproductions of an ordinary photograph or scene. These, therefore, have picture structures which correspond to television images



and are useful in studies of the character outlined by this paper. Such scanned reproductions are usually limited in the number of scanning lines possible by much the same reasons that a television system is limited in the number of scanning lines unless elaborate apparatus is specially constructed. Other forms of reproductions have been used to simulate television picture structures. Such methods of comparison are, naturally, limited to inspection of one picture frame and, as such, a still image.

In television we are concerned with moving images and with a succession of movements or scenes which have certain continuity. Also, the vision is aided by sound accompanying the picture. Because of the wide gap between a still picture of certain detail and a television reproduction having the same equivalent detail, it is difficult to draw any definite information regarding the number of scanning lines desired for a particular condition from any of the methods of study which have been discussed. These methods are helpful in preliminary studies, but fall short when an attempt is made to draw general conclusions.

Motion in a picture directs the observer's interest to the object or objects in motion. Under these conditions the eye requires less detail than for a still picture, assuming that the detail is sufficient so that the purpose of the movements may be understood. Proper use of this may be made in television in the choice of "story action" and choice of background for the action. Also, in an image which is the result of scanning at the pick-up end, motion of the objects being scanned positions these objects for particular frames in favorable relation to be analyzed and reproduced when these objects are small and approach in at least one dimension the size of the scanning beam.

For a more complete study of television image, it seems necessary to have available the ability to produce image reproductions which have picture structures equivalent to television, controllable illumination, controllable size, flicker frequency equivalent to television, and capacities for subjects which will be used in television. It is also desirable to cover a range of picture detail equivalent to television images of 60, 120, 180, 240, and even larger numbers of scanning lines. These equivalents should be so made that they represent nearly perfect picture structures for the detail included. This seems desirable so as to avoid mistakes in judgment. Also, it will permit study with images equivalent to the more advanced stages of television which will later be attained as a result of continued devel-

opment. Such an experimental set-up will allow reasonable determination of several related picture properties—picture detail, picture size, and viewing distance.

As has been pointed out, it is impracticable to make use of television systems for this study. This is because of limitations in our ability at present to produce television images with sufficient detail, illumination, and size for this investigation and to have these characteristics variable. We must, therefore, resort to suitable equivalents. A motion picture film having a picture structure equivalent to a television image provides a very flexible means for carrying out this work. Such a method was chosen, and the procedure used will be described. There are numerous ways in which such a film may be made, but the method used for this investigation is flexible and presents only a reasonable amount of preparatory work.

In the system of television that we are considering, the scanning paths are horizontal and the beam progresses from left to right (when facing the object or reproduction) and from top to bottom. The scanning beam is usually round or square in cross section. Since the scanning beam has width in the direction of the scanning path, a certain form of distortion is introduced. This is known as aperture distortion, and has been adequately treated in the general television literature. This much has been indicated about the image characteristics because we shall later make comparisons between the structure of a television image and the motion picture equivalents we are to use.

The equipment used in making sixteen-millimeter motion pictures with detail structure equivalent to television images consisted essentially of a thirty-five-millimeter to sixteen-millimeter optical reduction printer. A system of optics was interposed between the two picture gates for the purpose of breaking up the picture image into small areas, each of which was uniformly illuminated, and which transmitted the same total quantity of light as a corresponding area in the picture image. A diagram of the optical system is shown in Fig. 5. The filament of an incandescent lamp 1 is focused by means of condenser lenses 2 upon a corrected lens 4. Lens 4 in turn forms an image of the thirty-five-millimeter picture aperture 3 on the plane surface of condenser lens 7. The equivalent of thousands of tiny spherical lenses 6 are placed directly in front of lens 7. Each of the tiny lenses forms an image of aperture 5. The plane con-

taining the many images of aperture 5 is brought to focus upon the sixteen-millimeter aperture 9 by means of a corrected lens 8. Condenser lens 7 makes it possible for lens 8 to collect an equal quantity of light from each of the images formed by lenses 6. The horizontal dimension of the rectangular aperture 5 is such that the sides of the images formed by lenses 6 just touch, thereby forming continuous bands of light in the horizontal direction. The dimension of aperture 5 in the vertical direction is narrower, thereby producing narrow dark spaces between the horizontal lines formed. This was done to simulate television image lines. The image at aperture 9 of a motion picture film at aperture 3 is broken up by this optical system into as many elementary areas as there are lenses or equivalent lenses in 6, each of which contains no detail within itself. By adjusting the

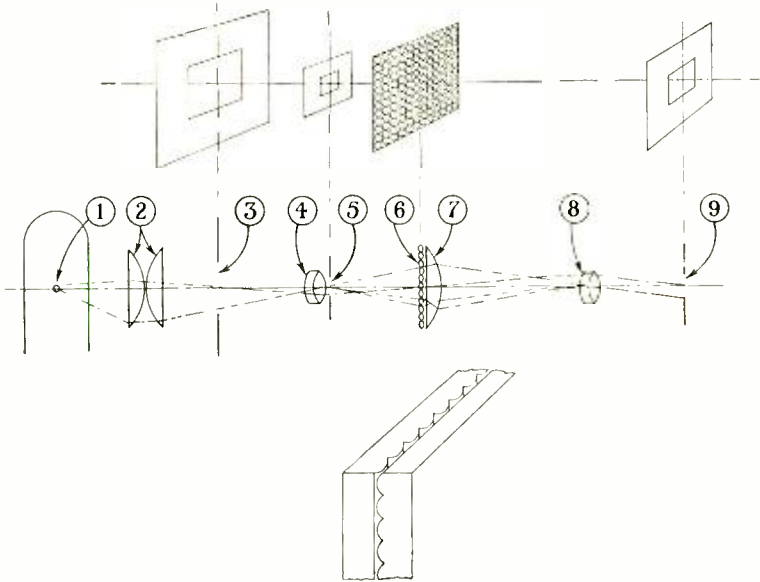

Fig. 5

reduction ratios of lenses 4 and 8, and by having sufficient equivalent lenses at 6, it is possible to vary the number of picture elements.

Since it would have been quite difficult actually to obtain the thousands of minute spherical lenses, an approximate but more practical scheme was resorted to. It is known that two crossed cylindrical lenses are very nearly equivalent to a single spherical lens. Thus, it would be quite possible to approximate the required condition by crossing two layers of fine glass rods, the

rods being in actual contact with each other. Fortunately, an even simpler solution was found. Kodacolor film is embossed with minute cylindrical lenses having focal lengths of about 6 mils. By crossing two pieces of Kodacolor film with the embossed surfaces in contact, very satisfactory results were obtained. The focal lengths of the equivalent spherical lenses formed by crossed Kodacolor film were so short that the size of aperture 5 would have had to be larger than the diameter of lens 4. This condition was corrected by forming a cell made up of two pieces of Kodacolor film crossed, and filling the space between the embossings with a transparent solution having an index of refraction greater than air and less than the index of the film base. By varying the index of refraction of this transparent solution, it is possible to make the lenses have any desired focal length from 6 mils to infinity.

The Kodacolor cell and lenses 4 and 8 were arranged in a suitable mounting and mounted on the reduction printer between the thirty-five-millimeter aperture and the sixteen-millimeter aperture. Arrangements were provided for adjustment of these various lenses. The subject matter was taken from a thirty-five-millimeter positive print. The first printing operation gave a sixteen-millimeter negative having the desired picture structure. A sixteen-millimeter positive was then made by printing from the negative in a sixteen-millimeter contact printer. The sound was transferred in the usual manner.

Films were made up for a variety of scenes and subjects. These, in general, included:

- Head and shoulders of girls modeling hats,
- Close-up, medium, and distant shots of a baseball game,
- Medium and semiclose-up shots of a scene in a zoo,
- Medium and distant shots of a football game,
- Animated cartoons,
- Titles.

These were assembled for one group with all scenes of the same detail (line structure) on the same run of film. For another group these were assembled with each scene progressing from 60- to 240-line structure. The pictures made included:

- 60-line structure,
- 120-line structure,
- 180-line structure,
- 240-line structure,
- Normal projection print.



120 Scanning Lines  
(b)



240 Scanning Lines  
(d)

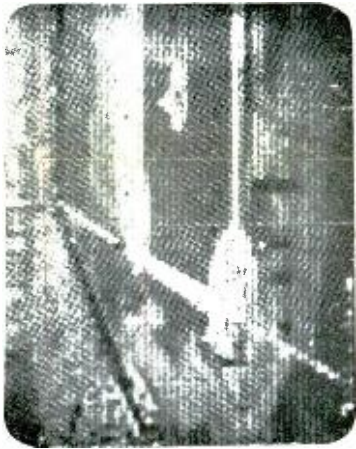

60 Scanning Lines  
(a)

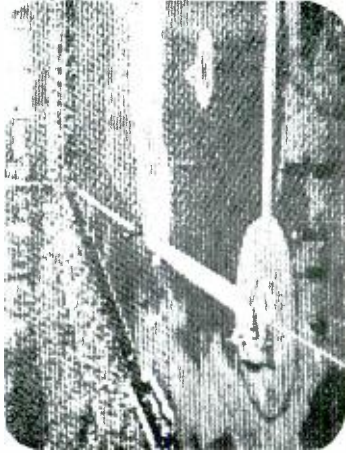

120 Scanning Lines  
(b)

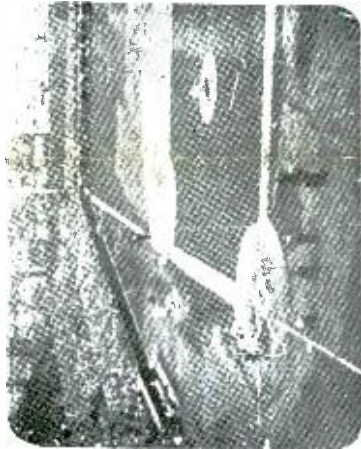

180 Scanning Lines  
(c)



240 Scanning Lines  
(d)

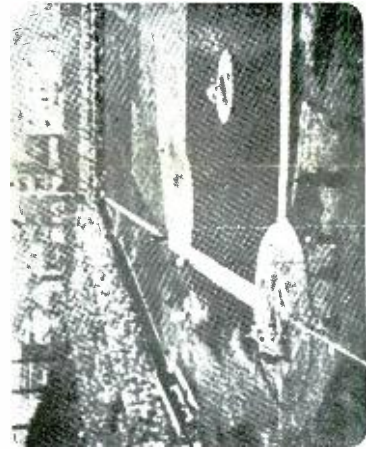

Enlargement  
(e)





60 Scanning Lines  
(a)



180 Scanning Lines  
(c)

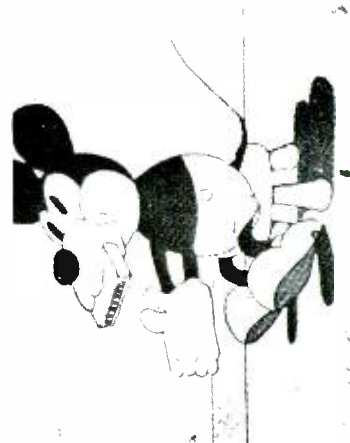

Enlargement  
(e)



120 Scanning Lines  
(b)



240 Scanning Lines  
(d)



60 Scanning Lines  
(a)



180 Scanning Lines  
(c)



Enlargement  
(e)





It was planned at the start to produce pictures having detail structures greater than 240 lines, but it was found that limitations, mainly in film resolution, prevented this. The resolution of the sixteen-millimeter film used was naturally considerably greater than a 360-line structure, but, with the averaging process used in producing each small section of the picture, the resolution was not sufficient to prevent merging of one section into the next. Later determinations made from viewing these films indicated that the 240-line structure pictures were sufficient for the purposes of the investigation since the results were of such a nature that the relationship could be extended to higher numbers of scanning lines.

Samples of three picture frames are given as Figs. 6, 7, and 8. These are all enlargements from the sixteen-millimeter negatives and include structures of 60, 120, 180, and 240 lines, and, also, a normal photographic enlargement. It is interesting to note how near the 240-line structure approaches the normal enlargement in picture quality.

An RCA Photophone sixteen-millimeter sound projector equipment was used in projecting these films. The light cutter in the projector was modified so as to interrupt the light only during the time that the film was being moved from one frame to the next by the intermittent movement. This modification consisted in removing one blade from the light cutter. The light was, therefore, cut off once per frame, giving for these tests a flicker frequency of 24 per second. The films were shown to several groups of people, using projected picture sizes 6, 12, and 24 inches high. The major reaction from these showings was the expression of satisfaction obtained from viewing pictures 12 inches high and larger in comparison to smaller pictures.

It will be of interest at this point to record some of the reactions on how well these films form equivalents of television images. These reactions were formed as a result of observations and tests made with the films. The horizontal-line structure was so clearly equivalent that we may pass by this without comment. The changes of contrast along the horizontal "scanning" lines for the 60-line structures appeared somewhat "mosaic" in arrangement. This was because the boundaries of the individual picture arrangements were determined by the multiple lens arrangement used to produce the image. This effect was not noticed in 120-line structures or in those of higher detail. The 120-, 180-, and 240-line structures, and also the 60-line structure,

except for the effect explained above, were well suited for study of image detail. In general a particular line structure on the film was considerably better than a television image (as we are at present able to produce them) of the same number of scanning lines. This is a desirable condition because the results of the tests will then be in terms of television of an advanced stage rather than in terms of present capabilities.

In order to obtain some quantitative information, a number of practical viewing tests were made. These tests were made by the same three observers who made the tests covered earlier in this paper. For these observations the same projector equipment as described in a paragraph above was used (one light interruption per frame). The projection lamp was operated at rated voltage (normal brilliancy) and the projection lens was stopped down to give the desired screen illumination. A screen illumination of five to six foot candles was chosen. This was measured at the screen, looking toward the projection lens, and with the projector running, but without film in the picture aperture. This value of screen illumination, though less than for theatre or home movies, was chosen because it gives a fairly bright picture and because it falls within a range to be reasonably expected for television. For the pictures of various sizes the foot candles of illumination (surface density) was kept the same, varying the total luminous flux in proportion. The stray room illumination was of the general order of one-tenth foot candle.

Viewing tests were made with projected pictures of various heights, using the film subjects listed earlier. For pictures of given height and line structure, observations were made for each type of subject matter on the film. These data were averaged, and the information used in the curves to be plotted includes this in terms of an over-all average for the three observers. In taking the observations, viewing distances were chosen at which the lines and detail structure became noticeable. At closer viewing distances the picture structure became increasingly objectionable. At the viewing distances chosen the picture detail was just satisfactory. At greater viewing distances the picture detail was, naturally, sufficient. It was noted that the type of picture subject did not influence the viewing distance chosen by more than ten per cent. This is explainable on the basis that we are determining minimum conditions in terms of line and detail structure. Data were taken for pictures 6, 12, and 24 inches high, and for picture structures of 60, 120, 180, and 240 lines,

and also for a normal projection print. This information is given in curve form in Fig. 9.

In order to present these observed data in more general form, the above curves are shown, in Fig. 10, replotted in terms of scanning lines per inch. The curve drawn through the observed points is the two minutes of arc curve from Fig. 2. This, as explained earlier in the paper, is a curve between scanning lines

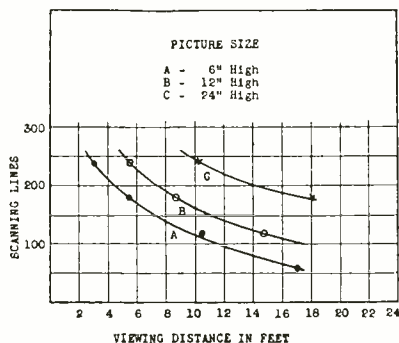

Fig. 9

per inch and viewing distance where the dimension between centers of scanning lines subtends an angle to the eye of two minutes. Because of the correspondence between the plotted points and the two minutes of arc curve, we shall use this two minutes of arc curve in our discussion as representing the average results (for the three observers) for practical viewing conditions.

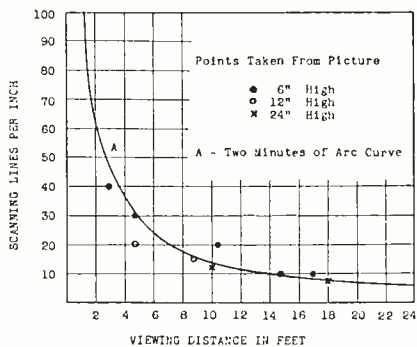

Fig. 10

It is of interest to compare these observed results from viewing the films of several detail structures, with the observed results of viewing the chart, Fig. 1, the curves of which are shown in Fig. 4. In the case of the still chart observations, the average falls on the one minute of arc curve; in the case of the

observed motion picture television equivalents, the average falls on the two minutes of arc curve.

In order to indicate the relative viewing distances for a normal projection print, the data taken are shown in another graphical form. The plotted points for picture structures of 60, 120, 180, and 240 lines are the same as for the curves in

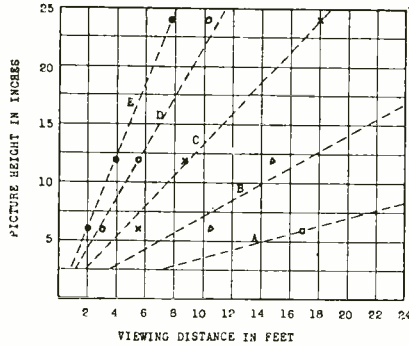

Fig. 11 A— 60 scanning lines  
 B—120 scanning lines  
 C—180 scanning lines  
 D—240 scanning lines  
 E—projection print

Fig. 9. The plotted points for a normal projection print were taken in the same manner as for the other films. In this instance the viewing distance chosen was where the picture just began to show loss of detail. Thus Fig. 11 indicates in a general measure the relative merits of the several picture structures. It also shows how near the 240-line structure approaches a normal sixteen-millimeter projection print. In inspecting this chart it will be noted that the observed data do not entirely check the theoretical acuity conditions. This is also to be noted by the variation of the points from the theoretical curve in Fig. 10. An example of this for the chart, Fig. 11, is that curve *D* for 240 lines should indicate viewing distances one half that for curve *B* of 120 lines. Curve *B* for 120 lines and curve *A* for 60 lines show the proper one-to-two relationship for viewing distances. It is probable that for the higher number of lines the observed data err on the side of being too "good."

With a screen illumination of the order used in these tests (5 to 6 foot candles) an increase in apparent detail can be obtained with higher values of illumination, thereby providing a greater range of contrast. To determine the general order of this increase, several tests were made with a screen illumination of 20 foot candles. With this value the apparent picture detail

was improved, but also the picture structure was more pronounced, requiring a choice of viewing distance from thirty to forty per cent greater than for an illumination of 5 to 6 foot candles. Since 5 to 6 foot candles is more in keeping with television possibilities for the next several years, and since the

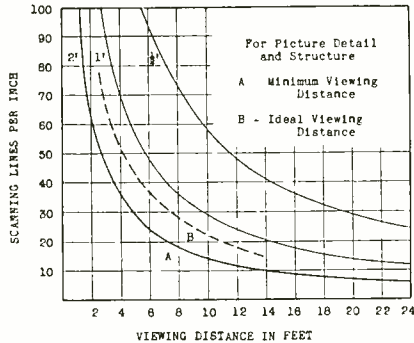

Fig. 12

difference in apparent detail and viewing distance is within the accuracy tolerances of the generalizations to be drawn, this particular condition will not be taken into account.

Some interesting data were obtained from direct comparisons of these projected television equivalents with the same subjects having "perfect detail." Two similar projectors were set up so that the projected images were side by side on the screen and the illumination of each the same. One projector was used to project the film having television line structure; and the other projector, the same film subjects but a normal projection print. Observations were made using pictures of several heights and using the films having picture structures of 120, 180, and 240 lines. Viewing distances were chosen at which the two screen images had the same apparent detail. At these viewing distances the image from the normal projection print had a detail structure beyond eye acuity in fineness, and in this sense "perfect." These viewing distances might, therefore, be termed "ideal viewing distances" from the standpoint of picture detail and structure for the television equivalents. The data taken indicate that this "ideal viewing distance" is approximately fifty per cent greater than the "minimum viewing distances" shown by the curves in Figs. 9 and 10. This information is shown in graphical form by Fig. 12.

We have determined from these observations two viewing distances in terms of picture detail and structure. The first is a

minimum viewing distance, and the second an ideal viewing distance. If the total picture size were limited, we would, in viewing this picture, tend to approach it until the picture detail and structure became unsatisfactory. We would for this condition choose the minimum viewing distance referred to above. If the total picture size were ample, we would tend to position ourselves so that we would view it at the ideal viewing distance. This relationship will be covered more fully later in the paper.

The tests we have made on picture detail are rigorous. We have set as standards the ability of the eye to see the elements of detail and picture structure. Another less exacting standard would be the "ability" of images having various degrees of detail to "tell the desired story." In this case the detail required is dependent upon the kind of story and information to be presented. The detail requirements would increase as the scenes became more intricate. During the early stages of development such a standard is useful, but, for obvious reasons, it is not of a lasting type since it is the eye and the reactions of vision that must be satisfied. The standards we have used are definite and of a character which will not become obsolete as the development of television progresses.

If we qualify and limit "the ability to tell a desired story" to specific conditions, the experience we have had with television and these tests allows us to make some interesting approximate generalizations. If we take as a standard the information and entertainment capabilities of sixteen-millimeter home movie film and equipment, we may estimate the television images in comparison.

60 scanning lines			entirely inadequate
120	"	"	hardly passable
180	"	"	minimum acceptable
240	"	"	satisfactory
360	"	"	excellent
480	"	"	equivalent for practical conditions

This comparison assumes advanced stages of development for each of the line structures. It relates to the ability of observers to understand and follow the action and story. It does not relate to the ability to reproduce titles and small objects.

We stated earlier in this paper that motion in a picture has an effect on the apparent detail. There are several reasons for this. The observer's interest is directed to the object or objects in motion. The eye then does not tend to explore the

picture step by step, examining each section critically. Under these conditions the eye requires less detail than for a still picture, assuming that the detail is sufficient so that the purpose of the movements may be understood. Objects made up of too few picture elements to recognize while still, may be recognizable and realistic while in motion. A portion of this improvement is due to experience on the part of the observer in associating the motion with things and processes he understands. A portion of the improvement is due to more favorable conditions for scanning while the object is in motion. Another portion of the improvement, as already stated, is due to concentration of interest around the motion. This effect is very important in dealing with crude television images, but becomes minor in images having sufficient detail to satisfy eye acuity. An image made up of 30 scanning lines, though inadequate for almost any subject, provides much more satisfactory results for objects in motion than for still scenes. On the other extreme, a normal sixteen-millimeter projected image of a scene including motion is not, in any large measure, superior to a scene containing no motion. There is, of course, a decided difference in the center or centers of interest.

Reference to Figs. 6, 7, and 8 will illustrate this. In particular, in the 60-line print of the baseball scene, the players are about five picture elements high, and considerable imagination must be used to locate them. With the same scene in motion the observers can pick out the players, roughly determine their action, and, in a general sense, follow the game. In other words, the condition has changed from a reproduction of a scene containing no motion, and which gives practically no information except that it is a baseball field, to a reproduction of the same scene in which the players move, and which in general allows the observers to follow the action roughly. It is apparent from examining the other prints, particularly as the amount of detail increases, that reproductions with motion would naturally improve the satisfaction obtained, but the difference would not be as great and would decrease as the picture detail improved. Summarizing the effects of motion in a television image, we may conclude that the major improvement is that of observer interest. This is true because, to be generally satisfactory, the image must contain sufficient detail to satisfy eye acuity. This same condition holds in the case of motion pictures. We are, therefore, justified (and safe from the standpoint of results) in discount-

ing the effects of motion in the generalizations to be drawn from this analysis.

Thus far in our investigation we have considered picture detail and structure and have arrived at certain relationships between number of scanning lines and viewing distances. We have not taken into consideration the picture size. By reference to the curve in Fig. 10, and by knowing the total number of scanning lines available for the system we are considering, we may readily determine the size of the picture in terms of height. This does not, however, tell us, at the viewing distance we have chosen, that the picture will be of a size pleasant to view. If the picture is too small it will be unsatisfactory because too fixed an attention will be required for viewing. If the picture is too large it will be unsatisfactory because too large movements of eyes or head will be required for viewing. In television, because of the practical limitations in detail (scanning lines), we are confronted in general with too small rather than too large pictures.

In television we use the same ratios of picture width to picture height (aspect ratio) as in motion pictures (6 to 5, or 4 to 3). In moderately large theaters the distance from the back row of the orchestra section to the screen does not usually exceed six to seven times the screen height. The front row of seats may be as close as one and one-half to two times the screen height. The choice position is probably at four times the screen height from the screen. In home movies (where less detail is available because of the smaller size film) the desired viewing distances cover a span of from four to eight times the picture height. Since television, of the type we are considering, is for home entertainment, we shall in this consideration of television picture size use the accepted ratio of picture height to viewing distance for home movies (span of one to four—one to eight) in our comparisons. To make this more specific we shall follow through an example. For this illustration we shall use a picture one foot high. The desired viewing distance range is from four to eight feet. Going beyond eight feet, viewing conditions become decreasingly satisfactory and at twelve feet and beyond become quite unsatisfactory. This is based on the assumption that the same general run of subject matter will be used as for motion pictures.

We have now accumulated data which allow preparing a chart including relationships between scanning lines, picture size, viewing distance, and desired ratios of picture height to



viewing distance. The information on this chart, which is given as Fig. 13, is based on the observed data recorded in curve form in Fig. 10. Using this "minimum viewing distance" relation between scanning lines per inch and viewing distance, the chart in Fig. 13 shows for a number of viewing distances the picture size—total scanning line relationship. Superimposed on this are horizontal broken lines for picture height to viewing distance ratios of one to four, one to eight, one to twelve, and one to sixteen. In using this chart we must take into consideration the fact that between the one-to-four and one-to-eight picture height to viewing distance lines, the viewing conditions will be satisfactory. As we drop below the one-to-eight ratio line the viewing conditions become less satisfactory, and below the one-to-twelve ratio line, generally unsatisfactory.

This chart (Fig. 13) includes all the necessary information to determine scanning lines required if viewing distance and picture height have been decided upon; or picture size, if a certain number of scanning lines are possible and a certain viewing distance

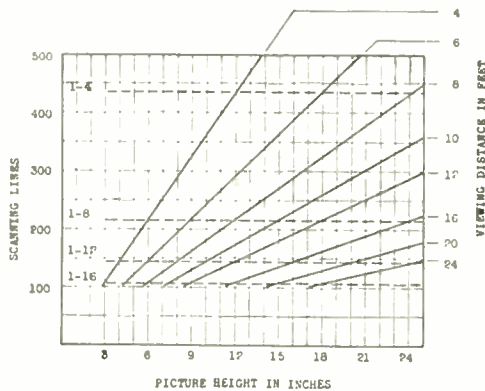

Fig. 13—Relationship between scanning lines and picture size for several viewing distances. Broken lines indicate picture height to viewing distance ratios.

is desired. The chart also provides a guide for the desired picture sizes for general viewing conditions. To illustrate, we might decide that we wish to view a television image at eight feet. Starting down the eight-foot viewing distance line, we find that with 360 scanning lines we may have a picture twenty inches high. We also learn that the picture height to viewing distance ratio is a very desirable one. With 240 scanning lines we find that we may have a picture thirteen and one-half inches high. Here the picture height to viewing distance is about one-to-eight

ratio line and, therefore, satisfactory. With 180 scanning lines we may have a picture ten inches high. We note that we have dropped below the one-to-eight ratio line, a less desirable viewing condition. At this point the picture will, in general, be satisfactory for viewing but probably the minimum desirable for an eight-foot viewing distance.

The viewing distance lines on this chart mean, in accordance with the explanation given a few paragraphs previously, that, at this particular distance and for the number of scanning lines and picture height indicated at any point along the line, this is the minimum viewing distance for a picture of this number of scanning lines and height. Since this information is based on tests made by three observers who have, as previously pointed out, acuity above average, this is a safe condition for average use. Suppose, as in the above illustration, we have chosen an eight-foot viewing distance and, with 240 scanning lines available, a picture height of thirteen and one-half inches. The nearest an observer should view this image is, then, at eight feet. Observers more distant will naturally find satisfactory detail conditions. To determine if the general viewing conditions at more distant points are satisfactory because of the picture size, we may start at the eight-foot viewing distance line and the thirteen and one-half inch picture size and drop down along the thirteen and one-half inch ordinate. At a ten-foot viewing distance we are just a little under the one-to-eight ratio. At a twelve-foot viewing distance we are nearing the one-to-twelve ratio and approaching unsatisfactory viewing conditions. Therefore, a picture of 240 scanning lines and thirteen and one-half inches high may be viewed from eight feet to about twelve feet.

#### ACKNOWLEDGMENT

The author expresses appreciation for the assistance of Messrs. W. L. Carlson and T. V. DeHaven who together with the author were the three observers referred to in the paper, for the assistance of Mr. T. V. DeHaven in preparing some of the test set-ups, and for the assistance of Mr. G. L. Dimmick in preparing the films having the special detail structures.

# A STUDY OF TELEVISION IMAGE CHARACTERISTICS

## PART TWO<sup>1</sup>

### DETERMINATION OF FRAME FREQUENCY FOR TELEVISION IN TERMS OF FLICKER CHARACTERISTICS

BY

E. W. ENGSTROM

(RCA Victor Company, Inc., Camden, N. J.)

*Summary*—During 1931 and 1932 an investigation was carried out to obtain quantitative information on the several characteristics of television images. Part One of this paper covered those characteristics relating to image detail. This paper, Part Two, covers a determination of frame frequency in terms of flicker characteristics. The analysis is based on a number of simple tests largely in terms of equivalents so that a wide range of conditions might be studied. Conclusions are reached regarding several means for minimizing flicker.

TELEVISION images consist of rapidly superimposed, individual frames much the same as motion pictures. In the case of motion pictures a group of time related stills is projected at a uniform rate, rapid enough to form a continuous picture through persistence of vision. By present methods each frame of a television image is built up element by element in some definite order, and these time related frames are reproduced at a rapid rate.

In motion pictures the taking or camera frame frequency determines how well the system will reproduce objects in motion. This has been standardized at 24 frames per second. In television it is assumed that we shall use a frame frequency of 24 per second or greater. Since this is satisfactory for motion pictures, it is also satisfactory for television and this characteristic of frame frequency will, therefore, not be considered further.

In the reproduced image there is another effect of frame frequency which has been the subject of investigation. This is the effect of frame frequency on flicker. Motion picture projectors commonly used are of the intermittent type. The usual

<sup>1</sup> E. W. Engstrom, "A study of television image characteristics, Part I," PROC. I.R.E. vol. 21, no. 12, pp. 1631-1651; December, (1933).

Reprinted from the Proceedings of the Institute of Radio Engineers.

cycle of such a projector is that at the end of each projection period the projection light is cut off by a "light cutter," the film is then moved and stopped so that the succeeding frame registers with the picture aperture, the light cutter then opens, starting the next projection period. This is repeated for each frame—24 per second. Since projection at 24 light stoppages per second with the illumination levels used in motion pictures causes too great a flicker effect, the light is also cut off at the middle of the projection period for each frame for a time equivalent to the period that it is cut off while the film is moved from one frame to the next. This results in projection at 24 frames per second with 48 equal and equally spaced light impulses. Such an arrangement provides a satisfactory condition as regards flicker. In television we also may have a reproduced image at 24 frames per second, but because of the manner in which the image is reconstructed, a continuous scanning process, it is not practicable further to break up the light impulses by means of a light chopper in a manner similar to that used in the projection of motion pictures. We, therefore, have for the usual systems of television a flicker frequency which corresponds with the actual frame frequency (24 per second, for example). This is satisfactory at very low levels of illumination but becomes increasingly objectionable as the illumination is increased.

It is of interest to review very briefly some of the fundamental considerations regarding time relations in vision. Full treatment of this may be found in most texts on optics dealing with the eye and the physiological aspects of the subject.

When the retina of the eye (adapted to darkness) is suddenly exposed to a field of steady brightness, the sensation rises rapidly to a maximum, and then falls to a lower constant value. When the stimulus is removed, the sensation does not immediately disappear but takes a finite time to decay below the limit of perception. Thus, if the eye is exposed to a source of rapidly varying intensity, the effects of the finite rates of growth and decay of sensation (or the persistence of vision) may prevent flicker from being noticeable. This is true provided that the total cycle of variations is regular and of high enough frequency.

If the frequency of a varying source is sufficiently high so that flicker is imperceptible, the eye is able to integrate the brightness over the cycle of variation. Thus  $I = (1/t) \int i dt$ , where  $I$  is the apparent brightness,  $t$  the total period of one complete cycle of variation, and  $i$  the instantaneous brightness. The

effect is as if the light for each cycle were uniformly distributed over the period of the cycle.

The highest frequency at which flicker can just be detected is called the critical frequency. It has been shown that the critical frequency is practically a linear function of the logarithm of the brightness of the field (over the range of interest for television). The sensitivity of the eye to flicker is noticeably increased when increasing the field of view from a few degrees to an image of the size and viewing distances encountered in motion picture practice. The sensitivity to flicker is also greater for averted vision when viewing large fields of varying brightness.

In television there are a number of factors that contribute to flicker effects. These in general are:

Number of frames (light impulses) per second.

Brightness of image.

Percentage of time the image is illuminated for one frame cycle.

Wave form of rise and decay of light impulse.

Size of image in terms of angle subtended at the eye of observer.

Because information of the type in which we are interested for a study of television flicker was not directly available, a number of general tests were made. The first tests were with a simple flicker disk. The set-up included the elements of a motion picture light and optical system—an incandescent lamp light source, a reflector and condenser system, a light cutter (sector disk), a picture aperture, a projection lens, and a reflecting type screen. A diagram of the light cutter is shown in Fig. 1. In order to have the light cutter mechanically balanced, two light openings were used on opposite halves of the disk. A complete cycle of 360 degrees, therefore, consists of one-half revolution of the light cutter disk. The dimensions of the light cutter and picture aperture were such that the aperture was just fully covered (illuminated) by the smallest light opening used (10 degrees) and just fully cut off by the sector for the largest light opening used (350 degrees).

In this set-up the wave form of illumination was determined by the speed of rotation, the dimensions of the light cutter and picture aperture. The variables for the tests were the angle of opening on the light cutter and the speed of rotation. The size of the image used was one foot high, four-by-three ratio of width to height, and was viewed at a distance of six feet (a

picture height to viewing distance ratio of one to six). The color of the light was determined by the incandescent lamp (home movie projector type) which was used within the operating voltage range. Tests were made with the above-determined factors on the relationship of number of frames, illumination, and opening of light cutter. For these tests the stray room illumination was of the general order of one-tenth foot candle.

Tests were made for a number of light openings from 10 degrees to 350 degrees. For each light opening, observations were made for several levels of integrated illumination of the screen image from one-half to twenty foot candles. The illumination was measured at the screen with a Weston direct reading illuminometer, looking toward the projection lens and with the light cutter operating. The screen was a large sheet of very white, matte surface drawing paper having a reflection coefficient of about 75 per cent. For each value of light opening and screen image illumination a frame or light impulse frequency was chosen at which the flicker on the image could just be noticed when vision was concentrated at the center of the image. At higher frequencies the flicker was unnoticeable—at lower frequencies the flicker became increasingly noticeable. Each frequency value chosen was the average for four observers. Care was taken in making these observations but, because of the type of the effect, the results are only approximate. The data taken are shown in chart form in Fig. 1.

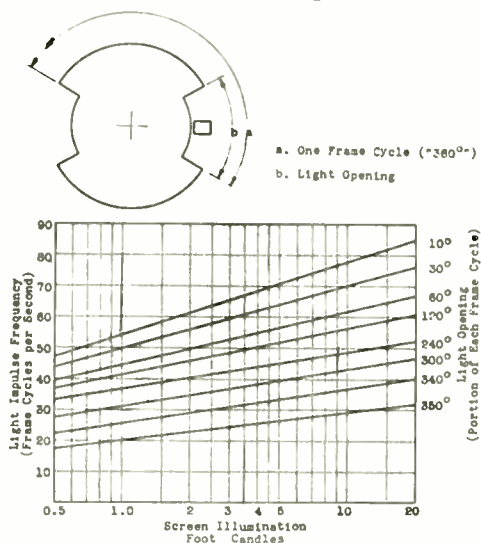

Fig. 1—Sector disk tests. Conditions for just noticeable flicker.

Similar observations were taken for another qualification of flicker. For the same conditions as used in the tests just described, frame or light impulse frequencies were chosen at which the flicker effect became disagreeably objectionable. This rating was difficult to judge. Comparison of the data taken with Fig. 1 indicated that the frequency for disagreeably objectionable flicker was lower for all conditions by a fairly constant value (10 to 15 frames) than that for just noticeable flicker.

For practical conditions of viewing, flicker is most noticeable with averted vision. One of the conditions for the above observations was that vision was concentrated at the center of the screen image. If vision is concentrated at one edge of the image, then the other edge is positioned at a larger angle from the central portion of the eye than when vision is concentrated at the center of the image. In order to determine the magnitude of this effect for various image sizes in terms of viewing angles, several observations were made. It was found that with a picture height to viewing distance ratio of one-to-four, and with vision concentrated on the image edge, either left or right, flicker from the opposite edge required the choice of a frame or light impulse frequency approximately ten per cent greater than that indicated when vision was concentrated at the center of the image, for conditions of just noticeable flicker. With a picture height to viewing distance ratio of one-to-eight, a little less difference was noted between these same two conditions. With a picture height to viewing distance of one-to-twelve, very little difference was noted.

Several observations were made to determine the effect of general room illumination on flicker. The same screen material was used as in the previous tests. The screen area was several times that of the projected picture aperture. Tests were made by evenly flooding the screen and room with daylight, measuring the stray illumination at the screen, measuring the added illumination of the projection device, and making observations for the condition of just noticeable flicker. These tests indicated that if the difference between the measured illumination of the image and the measured illumination of the surrounding screen was used as the value of screen illumination, then the results obtained were the same as given in Fig. 1. These observations were carried up to the point where stray illumination equaled the illumination from the projection device.

In order to visualize more readily the effect that the time the image is illuminated for each frame cycle has on flicker, the data in Fig. 1 have been replotted in the form shown in Fig. 2. From these curves obvious conclusions may be reached regarding the portion of each frame that the image must be illuminated and the number of frames per second for the illumination level desired. The results are in terms of just noticeable flicker.

After this general study of flicker we shall proceed to con-

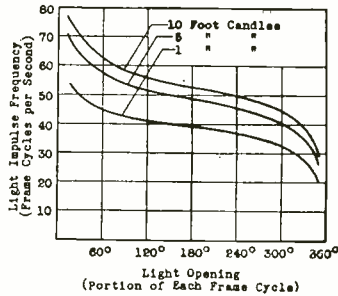

Fig. 2—Sector disk tests.

sider several specific conditions more definitely related to television systems. In television systems using moving mechanical devices in combination with a light source which is varied by the incoming picture signal, each element of the image is illuminated for only that portion of each frame that the light source covers that picture element—an extremely short period of time. Persistence of vision is relied upon to carry the effect from one frame to the next.

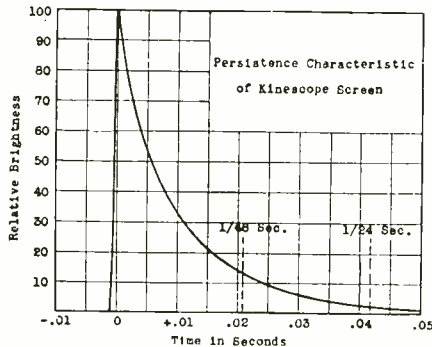

Fig. 3

In a television system using a cathode ray tube (kinescope) in the receiver, each element of the image on the luminescent screen, when excited by the electron beam, fluoresces and assumes a value of brightness corresponding with the value of excitation.



Upon removing the excitation this brightness then decays (phosphoresces) in an exponential manner dependent upon the screen material. The phosphorescence or persistence of the image screen aids the persistence of the eye in viewing the reproduced image. The persistence characteristic of a kinescope screen of the type generally used (zinc orthosilicate phosphor—"wille-

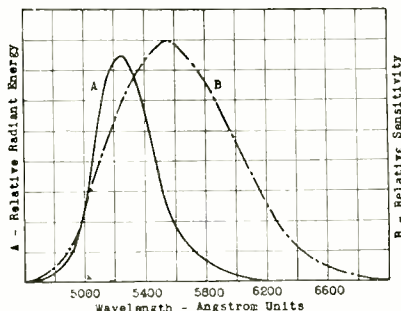

Fig. 4—A—Spectral energy characteristic of kinescope screen.  
B—Sensitivity of eye.

mite”) is shown in Fig. 3. The spectral distribution characteristic is given in Fig. 4 (the band maxima of this figure are not related in intensity).

In order to obtain data on the flicker from a kinescope under several conditions of operation, a series of observations was made. The deflecting circuits were arranged so that the vertical speed (frames per second) could be varied. The screen

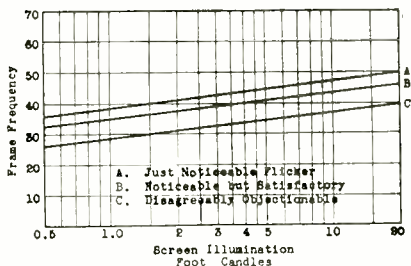

Fig. 5—Kinescope tests.

height used was six inches and the viewing distance three feet—a picture height to viewing distance ratio of one to six. The stray room illumination was of the general order of one-tenth foot candle. The luminescent screen illumination was measured with a Weston direct reading illuminometer at the kinescope glass envelope looking toward the screen. This was a measure of the light directed to the observer. Sufficient number of lines

of even distribution were used to fill completely the picture height of six inches.

Data were taken for three conditions of flicker:

Just noticeable; noticeable but satisfactory; disagreeably objectionable. The results of these observations are shown by Fig. 5.

These observations indicate that for even one foot-candle screen illumination 38 frames per second are required for just noticeable flicker, 35 frames per second for noticeable but satisfactory flicker, and 28 frames per second result in disagreeably objectionable flicker. Thus a standard of 24 frames per second cannot be justified. These data also indicate that 48 frames per second will be satisfactory from the standpoint of flicker for values of illumination likely to be encountered in television.

The light from such a kinescope is restricted to a rather narrow band in the green portion of the spectrum. In order to compare the flicker effect of this green light with the flicker effect of light from a projection type incandescent lamp, an additional set of observations was made. For these tests the same sector disk set-up was used as for the data shown on Fig. 1. The sector disk setting used for this comparison was the 240-degree light opening. Tests were repeated for just noticeable flicker with the normal light from the incandescent lamp, and then again introducing filters so that the light at the screen was about equivalent to the green light from the luminescent screen of the kinescope. The flicker results from the two colors of light of the same illumination were the same within limits of experimental error.

Because of the kinescope operating characteristics and the associated "a-c" type picture signal amplifiers of the usual type television system, the average illumination of the entire screen remains constant. Sections of the picture "ride" on this average illumination, varying above and below. For some reproduced images, sections of the picture may remain at a higher level of illumination than average and, thereby, make flicker of these sections more pronounced. However, in practice this effect is not noticeable, and observations indicate that the flicker of a plain deflection pattern of given illumination is more pronounced than when a signal of an average picture is impressed. It is probable that the television systems of the future will include methods for modifying the average illumination in accordance with the total illumination of the original scene which

is being reproduced. For this condition, a frame frequency should be chosen based on the higher sustained levels of illumination in reproduction.

Reference to the persistence characteristic of the kinescope screen shown in Fig. 3 indicates that a change of frame speed affects first, the rapidity of the successive light impulses and, second, the amount of illumination existing at the end of each light impulse cycle. These operate in the same direction, that is, reducing the effects of flicker as the frame frequency is increased and increasing the effects of flicker as the frame frequency is decreased. With the usual shape of decay curve the effect of the persistence characteristic of the screen is limited in the control of flicker. Also, if the persistence is too great, a blurring effect or tail will follow bright moving objects on a reproduced image.

In order to determine the relationship between persistence of the kinescope screen and flicker, a number of tests were conducted. These tests were made through a series of equivalents using a special projection device so as to provide sufficient range for measurement. The projection device consisted of a modified motion picture projector having a constant speed sprocket in place of the intermittent sprocket so as to pull the film past the picture aperture at a uniform rate of speed. Provision was made for a wide range of operating speeds (frames per second) and for a wide range of screen illumination. A group of special films was prepared in which the light transmission characteristic of each frame from top to bottom decreased exponentially at a given rate for each film. Six films were made having attenuation characteristics in accordance with Fig. 6. The dotted lines indicate the number of frames that would be required for the transmission to be reduced to one per cent. Sample prints of one frame are shown in Fig. 7.

These films were projected in the normal manner, that is, sharply focused on the viewing screen. Since the film passed by the picture aperture of the projector at a constant rate of speed, the visual effect at the screen was practically the same as if viewing a kinescope having a luminescent screen of persistence characteristics corresponding with the particular film used. Comparison with the persistence characteristic for willemite, shown in Fig. 3, indicates that at 24 frames per second film No. 2 corresponds approximately with willemite, and at 48

frames per second film No. 4 corresponds approximately with willemite for this test set-up.

Observations were made with a screen image one foot high and with a viewing distance of six feet. The screen illumination was measured for each film and for each observation at the

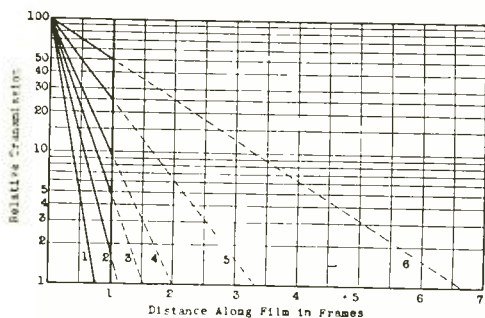

Fig. 6—Transmission characteristics of special films.

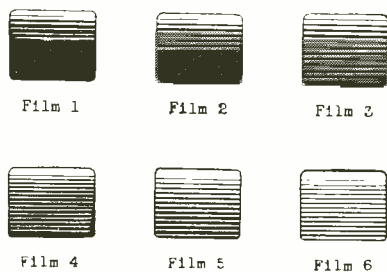

Fig. 7—Sample frames of special films for flicker tests.

screen with a Weston direct reading illuminometer looking toward the projection lens and with the projector in operation. For each film a series of data was obtained, for a wide range of screen illumination, on the frame frequency per second (light impulse frequency) required for just noticeable flicker. The observed values used were the average for three observers. These data are shown in chart form by the next three figures—Figs. 8, 9, and 10. This information has been presented in several forms so as to be most useful for indicating the effect of screen persistence.

Inspection of these charts indicates the range of control that the persistence characteristic of the luminescent screen has on flicker. During the tests made, no consideration was

given to the "hang-over"—blurring effect that too great a persistence would have on bright moving objects in the reproduced image. It is probable that film No. 6 exceeds the allowable time lag from the standpoint of this characteristic. From these data it does not appear logical that the complete solution to the flicker

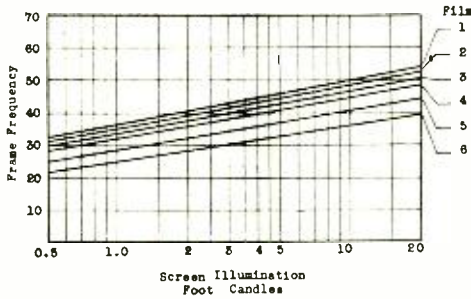

Fig. 8

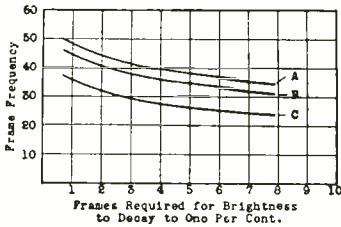

Fig. 9

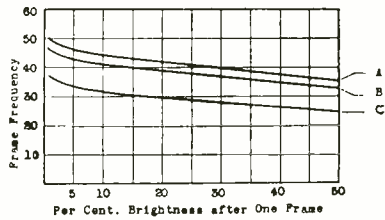

Fig. 10

- A—10 foot candles.
- B— 5 foot candles.
- C— 1 foot candle.

Figs. 8, 9, 10—Conditions for just noticeable flicker. Special film tests.

problem can be arrived at through screens of greater persistence so long as the decay characteristic is exponential in form. It is obvious that the desired wave shape of persistence (brightness versus time) is one which would be flat-topped for the period of one frame or slightly less, and then drop rapidly to zero.

In motion picture practice the projection light is broken up at the rate of two or more times the frame frequency during projection to reduce the flicker effect. A directly similar method is not practicable for television. However, in television certain special procedures in scanning have been used to reduce the effects of flicker. In order to determine the merit of such a system a number of tests were made.

In the usual systems the object scanned is covered by equal horizontal strips or lines from top to bottom in the regular order of lines 1, 2, 3, 4, 5, 6, . . . (progressive scanning). This results in one over-all light impulse for each frame repetition in the reproduced image. If this procedure is modified so that the scanning is, for the first half of one frame period, in the order of lines 1, 3, 5, 7, 9, . . . from top to bottom of the frame, and for the second half of the frame period in the order of lines 2, 4, 6, 8, 10, . . . from top to bottom of the frame (interlaced scanning), then the flicker effect of the reproduced image is changed. Each frame period now consists of two portions with respect to time, the first of alternate lines and the second of the remaining set of alternate lines, properly staggered to form a complete interlaced pattern. This results in an over-all effect of two light impulses for each frame repetition—twice that of the usual method of scanning. However, another effect is now present. In progressive scanning each line flickers at the rate of once per frame, and neighboring lines differ in time relation only by the time required for scanning one line. There is, therefore, no noticeable interline effect. In the interlaced pattern each line also flickers at the rate of once per frame, but neighboring lines differ in time relation by one half a frame period. This results in two flicker effects—an over-all effect and an interline effect.

A test set-up was made to obtain preliminary information on an interlaced scanning pattern. Fig. 11 is a reproduction of a disk, reduced in size, which was prepared for this test. It was mounted on a mechanism and rotated at 24 revolutions per second. The disk was masked except for one aperture having an opening 30 degrees wide and high enough to include the two sections of lines. It was evenly illuminated with daylight; about 20 foot candles. The inner section of the disk corresponds to a condition where each line is illuminated for two thirds of each frame cycle and (for 24 revolutions per second) at the rate of 48 frames per second—a progressive scanning pattern. The outer section corresponds to a condition where each line is illuminated for two thirds of each frame cycle and at the rate of 24 frames per second, but so that alternate groups of lines are illuminated 180 degrees out of phase—an interlaced scanning pattern with a field frequency twice the frame frequency. The width of white lines in each section is the same.

The inner section of the disk was prepared as a check for the observations on the outer section. The results from viewing

the inner section were in accordance with the data previously presented. Starting with a viewing distance considerably beyond that which allowed resolution of the individual lines, it was naturally noted that the flicker effect was not noticeable on the inner section. Approaching the disk, a definite distance was reached where the lines could just be seen as separate units. The flicker at this point was, also, unnoticeable. Approaching

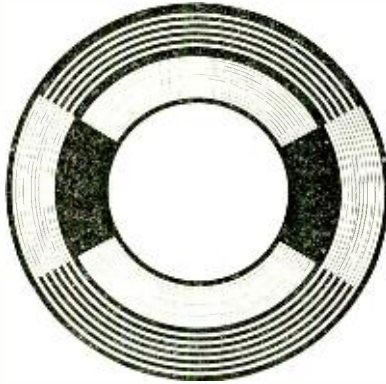

Fig. 11—Special disk for flicker tests with interlaced scanning.

the disk still closer made the line structure increasingly more pronounced, but the flicker effect was still unnoticeable. The same test was repeated for the outer section (interlaced line structure). Starting with a viewing distance considerably beyond that which allowed resolution of the individual lines, a flicker effect was unnoticeable. Approaching the disk it was observed that the line structure could be resolved at the same distance as for the inner section. In addition, a peculiar inter-line effect was observed and this started sharply at the distance where the line structure was first defined. This effect is rather difficult to describe, but, roughly, the adjacent lines appear to interweave. Approaching the disk closer caused this action to become very pronounced and jumpy. Assuming that the line structure could just be resolved at ten feet, then this jumpy, interweaving effect would first be noticed at this distance. At nine feet the effect would be more definite, and at closer distances it would be objectionable and tiring to the eyes. It was noted that blinking, rapid movements of the eye, or jerky movements of the head, particularly movements at right angles to the lines, caused the interlacing to be momentarily destroyed. The visual effect was apparently to see only one set of alternate lines with spaces between.

From these observations some approximate generalizations may be drawn. An interlaced pattern of the type just described is a means of minimizing flicker. The reproduced image must be viewed at distances equal to or greater than that at which the line structure can be resolved, to prevent undesirable effects from interline flicker. In Part One of this paper<sup>1</sup> it was determined desirable to view reproduced images at distances which were also in accordance with the above findings from considerations of image detail. With progressive scanning the only effect at closer distances is the noticeable line and picture structure. With an interlaced pattern of scanning the limitation becomes more definite because of the interline flicker.

In the test described, each frame of the image was divided into two sets of alternate lines. It might have been broken down into other forms—three groups of every third line, four groups of every fourth line, etc. Since we are using as a base a frame frequency of 24 per second, and since dividing each frame into two over-all light impulses results in satisfactory flicker condition, further subdivision seems unnecessary. Also, with further subdivision the flicker and crawling effect between groups of three lines, groups of four lines, or whatever subdivision above two is chosen, will become increasingly pronounced, requiring in turn proportionately greater viewing distances.

Observations were made on a system using an interlaced scanning pattern with a television receiver using a kinescope. These observations confirmed in general the results of the tests just described with the rotating disk. The indications are that satisfactory flicker conditions are obtained for kinescopes having screen persistence characteristics as in Fig. 3, when using a frame frequency of 24 per second and a field frequency of 48 per second, resulting in an interlaced pattern having the equivalent of 48 light impulses per second. Viewing conditions are in general limited to those equal to or greater than the position where the line structure may be resolved. It is obvious that an interlaced scanning pattern of the type just described requires the same maximum frequency for transmission as an image resulting from progressive scanning with the same base frequency (24 per second). With the interlaced scanning pattern the horizontal line deflecting frequency remains the same as for a progressive scanning pattern but the vertical deflecting frequency is doubled—24 to 48.



The method of obtaining an interlaced pattern and the incidental problems to be solved are beyond the scope of this paper. However, one phase of this is of interest since it influences the required band width for transmission. This is in connection with the practical application of alternating-current power supply systems to cathode ray type receivers using interlaced scanning. The effect of ripple voltages from the power supply system appears in the reproduced image from numerous sources. In progressive scanning, adjacent lines are closely related in time and, therefore, the displacement (due to the effects of ripple) of one line from its true position with respect to adjacent lines is small. The effect of ripple is, therefore, somewhat of an over-all image effect causing to be superimposed on the scanning pattern a varying brightness or line density effect. If the frame frequency differs from the supply frequency—differs except in terms of whole number multiples or sub-multiples—then the effect of this ripple will move across the image. If the frame frequency is a submultiple of the power supply frequency—30 frames for a 60-cycle source—then the effect of this ripple is stationary on the image and much less pronounced. This moving ripple pattern is almost as disturbing as the true flicker and the visual effects are about the same. (The improvement due to the reduction of the ripple effects might make a 30-frame per second image desirable for 60-cycle supply sources for progressive scanning, even at the expense of the increased frequency band.) With the interlaced scanning pattern, adjacent lines are separated in time by one half the period of one frame—one forty-eighth of a second for a 24-frame image where the field frequency is twice the frame frequency. With an interlaced pattern where the frame frequency or field frequency differs from the power supply frequency (such as 24 frames, 48 groups of alternate lines per second for a 60-cycle supply source) the ripple effects also move across the image. Since adjacent lines are widely separated in time, the phase difference of the ripple effect will cause adjacent lines first to draw together and then to separate in correspondence with the time difference between the frame and supply frequencies. With even very well filtered alternating-current to direct-current supply systems and with good magnetic shielding, this effect is sufficiently pronounced and random to destroy the effect of interlacing. The means for reducing the level of ripple to that required to prevent such action are of a classical rather than a

practical order. The visual effect is apparently to lose one half of the total number of lines. The solution is found in changing to a submultiple of the power supply frequency, for example, a 30-frame interlaced pattern for a 60-cycle source. The ripple effect is then stationary and, with reasonably well-designed supply systems, is quite unnoticeable. Tests were made which indicated that for a 30-frame per second picture, the transmitter supply frequency and the receiver supply frequency need not be synchronous; a difference up to one cycle per second in power supply frequencies may be tolerated. The choice of a 30-frame per second interlaced scanning has naturally increased the frequency band required in the ratio of 30 to 24.

#### SUMMARY

We may summarize the results of the study of television image flicker as follows. Naturally the frequency band required for transmission is proportional to the frame frequency.

For a system of television reproduction where the light output of each elementary area is effective only during the scanning period for that area (equivalent of scanning disk), a very high frame frequency is required for useful levels of illumination—Fig. 1.

For a system of television reproduction using a kinescope as the translating device and which has screen luminescence characteristics of the same order as willemite, a frame frequency in excess of 40 per second is required—Fig. 5. A frame frequency of 48 per second will be satisfactory for levels of illumination likely to be encountered in television. (At 48 frames and with a 60-cycle power system the effects of ripple voltages will travel across the image; the choice of 60 frames per second provides a complete solution to the visual effects of both flicker and ripple.)

A generally ideal translating device would be one in which each elementary area consisted of a light source, the brightness of which would be adjusted once each frame. A kinescope luminescent screen is very roughly such an arrangement. However, the persistence of brightness after excitation follows an exponential decay. The choice of material and its fluorescent and phosphorescent characteristics provides only a partial solution in the control of flicker for practical conditions—Figs. 8, 9, 10.

For a system of television using an interlaced scanning pattern and with a frame frequency of 24 per second, or more,

satisfactory flicker conditions exist if each frame consists of two groups of alternate lines (equivalent to 48 frames per second). If, for interlaced scanning, a kinescope is used as the translating device, then the frame frequency must bear a definite relation to the power supply frequency; for a 60-cycle supply the frame frequency may be 30 per second and the field frequency 60 per second. The minimum viewing distance for such an image is limited simultaneously by interline flicker and resolution of line structure.

#### ACKNOWLEDGMENT

The author expresses appreciation for the assistance of Messrs. W. L. Carlson, R. S. Holmes, and T. V. DeHaven in making the observations recorded in this paper; to Messrs. W. A. Tolson, R. D. Kell, and A. V. Bedford for some of the kinescope circuit arrangements and test set-ups. The work relating frame frequency of interlaced scanning to the power supply frequency was done by Mr. W. A. Tolson.



with the image resolution and pick-up performance of the system. To be satisfactory, a television system should provide an image of more than 120 lines. A more general discussion of the image detail requirements for television has been given in a previous paper.<sup>1</sup> The operating tests indicated that the fundamentals of the method of synchronizing used were satisfactory. The superiority of the cathode ray tube for image reproduction was definitely indicated. With the levels of useful illumination possible through the use of the cathode ray tube, the image flicker was considered objectionable with a repetition frequency of 24 per second. The receiver performance and operating characteristics were in keeping with the design objectives.

Information has been presented on the results of the propagation study made as a part of this project.<sup>2</sup> It is the purpose of the following papers to describe the system and the experimental apparatus used. The description of the entire system is covered by three papers: a description of the system, the cathode ray tube, and associated circuits; a description of the transmitting equipment; and a description of the receiving equipment. Each paper has been prepared by the engineer responsible for that portion of the project.

Acknowledgment is made to all the members of the RCA Victor organization who participated in the work, and for the assistance of others in associated companies of the RCA group.

<sup>1</sup> E. W. Engstrom, "A study of television image characteristics," *PROC. I.R.E.*, this issue, pp. 1631-1651.

<sup>2</sup> L. F. Jones, "A study of the propagation of wavelengths between three and eight meters," *PROC. I.R.E.*, vol. 21, pp. 349-386; March, (1933).



# DESCRIPTION OF AN EXPERIMENTAL TELEVISION SYSTEM AND THE KINESCOPE

BY

V. K. ZWORYKIN

(RCA Victor Company, Inc., Camden, New Jersey)

*Summary*—A general description is given of an experimental television system using a cathode ray tube (kinescope) as the image reproducing element in the receiver. The fundamental considerations underlying the design and use of the kinescope for television are outlined. A description of the circuits associated with the kinescope and an explanation of the application to an experimental receiver are included.

## INTRODUCTION

THE experimental television system placed in operation by RCA Victor in New York late in 1931, and on which practical tests were made during the first half of 1932, was based on the use of a cathode ray tube as the image reproducing

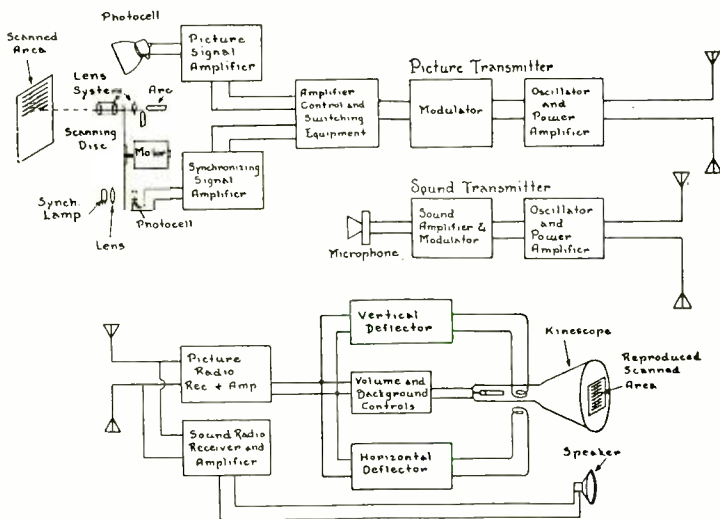

Fig. 1

element in the receiver. This allowed the use of a system with 120 scanning lines and a frame repetition frequency of 24 per second with adequate illumination for the reproduced image.

Reprinted from Proceedings of the Institute of Radio Engineers.

A block diagram of the system is shown in Fig. 1, where the components and their location in the system are indicated. Naming the units in order, we have for television from the studio: The photo-electric tubes, the flying spot scanning equipment, the picture signal and synchronizing signal amplifiers, the control and switching equipment, and the modulating and radio transmitter equipment. The units comprising the television receiver are: An antenna system feeding two radio receivers, one for sight, including the cathode ray unit with its associated horizontal and vertical deflecting equipment, and the other for sound, including the usual loud speaker.

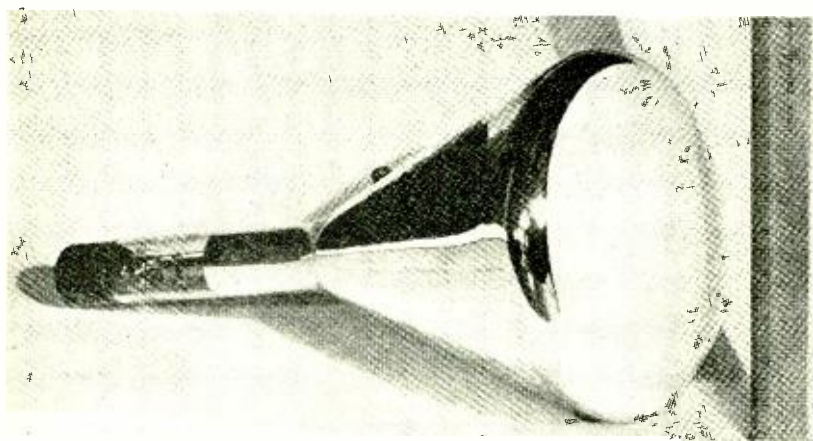

Fig. 2

### THE KINESCOPE

The name "kinescope" has been applied to the cathode ray tube used in the television receiver to distinguish it from ordinary cathode ray oscilloscopes because it has several important points of difference; for instance, an added element to control the intensity of the beam. Fig. 2 gives the general appearance of the tube which has a diameter of 9 inches, permitting a reproduced image of approximately  $5\frac{1}{2} \times 6\frac{1}{2}$  inches. Fig. 3 is a cross-section view of one of these tubes, showing the relative position of the electrodes, especially the cathode and its surrounding assembly, which is usually referred to as the "electron gun." The indirectly heated cathode, *C*, operates on alternating current. Its emitting area is located at the tip of the cathode sleeve and is formed by coating with the usual barium and strontium

oxides. The control electrode, corresponding to the grid in the ordinary triode, is shown at *G*. It has an aperture, *O*, directly in front of the cathode emitting surface, and besides functioning as the control element it also serves as a shield for the cathode.

The first anode,  $A_1$ , has suitable apertures which limit the angle of the emerging electron beam. The electron gun is situated in the long, narrow neck attached to the large cone-shaped end of the kinescope, the inner surface of the cone being silvered or otherwise metallized, and serves as the second anode. The purpose of the second anode,  $A_2$ , is to accelerate the electrons emerging from the electron gun and to form the electrostatic field to focus them into a very small, thread-like beam. The first anode usually operates at a fraction of the second anode voltage.

The focusing is accomplished by an electrostatic field set up by potential differences applied between elements of the electron

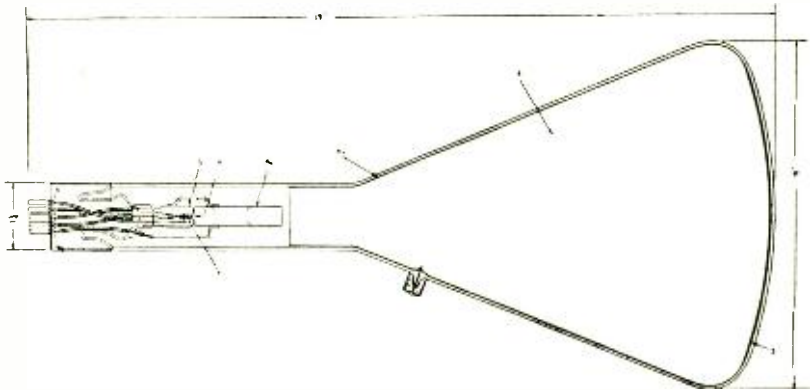

Fig. 3

gun and the gun itself and the metallized portion of the neck of the kinescope.

The theory of the electrostatic focusing is described in detail in a recent paper by the writer.<sup>1</sup> The lines of force of the electrostatic field, between properly shaped electrodes, force the electrons of the beam to move toward the axis, overcoming the natural tendency of electrons to repel each other. This action is analogous to the focusing of light rays by means of optical lenses. The electrostatic lenses, however, have a peculiarity in that their index of refraction for electrons is not confined to the boundary between the optical media, as in optics, but varies throughout all the length of the electrostatic field. Also, it is

<sup>1</sup> V. K. Zworykin, *Jour. Frank. Inst.*, pp. 535-555, May, (1933).

almost impossible to produce a simple single electron lens; the field always forms a combination of positive and negative lenses. However, by proper arrangement of electrodes and potentials, it is always possible to produce a complex electrostatic lens which will be equivalent to either positive or negative optical lenses.

The distribution of electrostatic fields in the electron gun of the kinescope is shown on Fig. 4. In this particular case, the total action of fields on electrons is equivalent to a combination of four lenses, as is shown in the same figure.

The first two lenses force the electrons through the apertures of the first anode and assure the desired control of the beam by the control element *G*. The final focusing of the beam on the

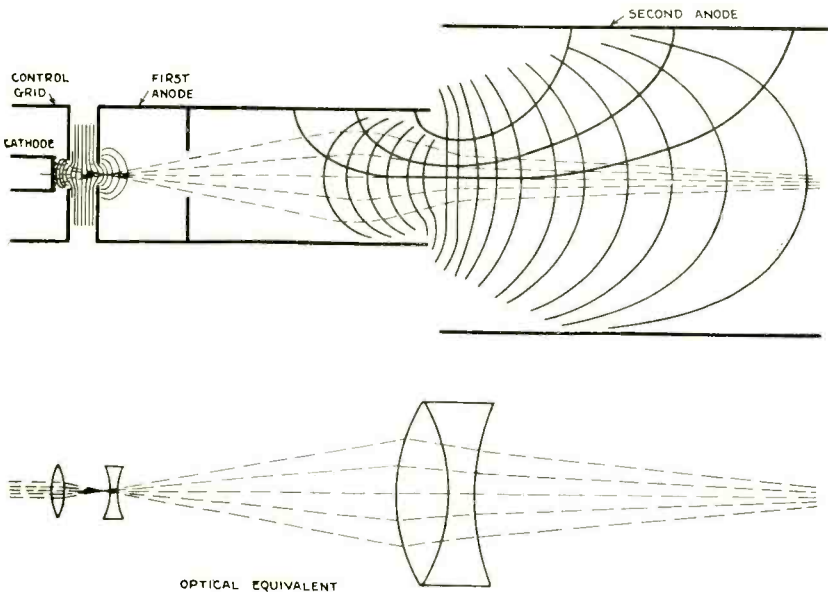

Fig. 4

screen is accomplished by the second pair of lenses created by the field between the end of the gun and the neck of the bulb. Thus, the final size of the spot on the screen, as in its optical analogue, depends chiefly on the size of the active area of the cathode and the optical distances between the cathode, lenses, and the fluorescent screen.

The velocity of the beam is expressed by the equation

$$v = 5.95 \times 10^7 \sqrt{V}$$

where  $v$  = beam velocity in centimeters per second and  $V$  is the



second anode voltage. For  $V = 4500$  volts, as used in kinescopes, the beam velocity is somewhat greater than one tenth that of light.

After leaving the first anode, the focused, accelerated beam impinges upon the fluorescent screen deposited upon the flat end of the conical portion of the kinescope. The fluorescent screen serves as a transducer, absorbing electrical energy and emitting light. Thus there is produced a small bright spot on the screen, approximately equal in area to the cross section of the beam. The fluorescent screen is very thin, so a large portion of the emitted light is transmitted outside of the tube as useful illumination.

In order to reproduce the light intensity variations of the original picture, it is necessary to vary the intensity of the spot

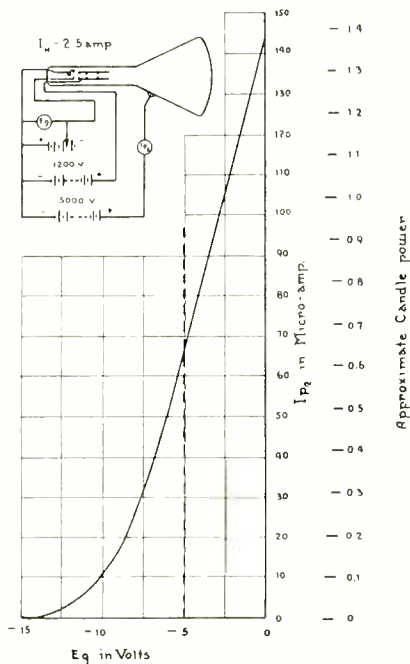

Fig. 5

of light upon the fluorescent screen. This is accomplished by means of the control element,  $G$ , of the electron gun. For satisfactory reproduction, the control of the electron beam intensity should be a linear function of the input signal voltage. Furthermore, it is very essential that during the exercising of this control the sharp focusing of the spot shall not be destroyed. Still

another requirement is that this control will not affect the velocity of the electron beam because the deflection of the beam is inversely proportional to its velocity, and, therefore, a slight change due to picture modulation would disturb the image, making the bright lines shorter and the darker lines longer. As a result of careful design, the variation of velocity of the beam (from complete cut-off to full brilliancy) in the kinescope is so small as to be unnoticeable to the observer of the picture.

The characteristic curve of the kinescope is shown in Fig. 5. From this it will be seen that an input of 10 volts alternating current will give practically complete modulation (i.e., a change from maximum to minimum brilliancy) of the cathode ray beam. The shape of this curve gives the proportionality between input voltage and second anode current and corresponding brightness of the spot. (It is to be noted that the values of current, voltage,

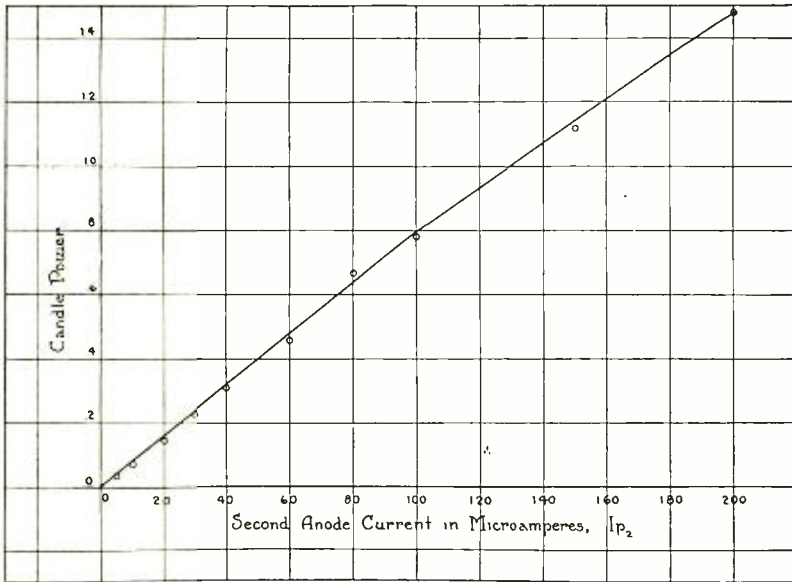

Fig. 6

illumination, etc., given on Fig. 5, and all figures in this report, are illustrative rather than specific values for a particular type of cathode ray kinescope tube.) By referring to Fig. 6, which shows a graph of the relation of second anode current to the light emitted from the fluorescent screen, it will be noted that a linear proportionality exists. Therefore, we can draw the conclusion that a television picture, varying in shade from black

to white, will have accurately reproduced all the intermediate shadings necessary for good half-tone pictures.

If we inspect the fluorescent spot by means of an enlarged photograph, we find that the light intensity is not uniform. When measured for a stationary spot, enlarged fifty times, the curve obtained from densitometer observations (see Fig. 7) shows that the light intensity increases toward the center of the spot. The actual diameter of the spot was 2 millimeters. During the scanning of a picture, when the spot is in motion, the light intensity per square unit of screen decreases proportionately to the scanned area. Therefore the edges of the spot, being less luminous, disappear and the apparent size of the spot decreases. This explains the fact that the diameter of the static spot is larger than the value calculated by dividing the picture height by the number of scanning lines. The photograph of the spot also shows why black spaces between the scanning lines of the received picture

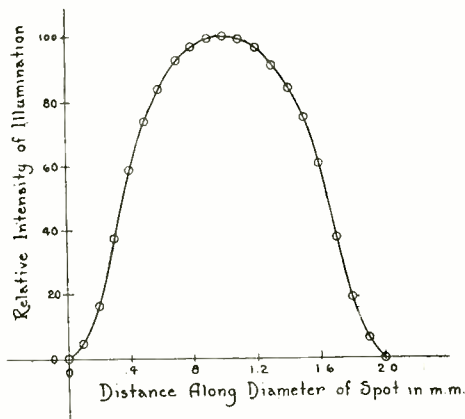

Fig. 7

may be noticed upon close observation. This is caused by the differences in light intensity between the center and the edges of the spot.

The material used for the fluorescent screen is a synthetic zinc orthosilicate phosphor almost identical with natural willemitite. Zinc orthosilicate phosphor was chosen because of its luminous efficiency, its short time lag, its comparative stability and its resistance to "burning" by the electron beam. The good luminous efficiency is due to the fact that the light, green in color, emitted by the zinc orthosilicate phosphor lies in the visible spectrum in a narrow band peaked at 5230A, close to the wavelength of maximum sensitivity of the eye (5560A) as shown in

Fig. 8. The luminous efficiency of incandescent tungsten lamps ranges from 2.5-4.0 per cent<sup>2</sup> whereas the zinc orthosilicate phosphor has an efficiency of 1.8-2.7 per cent when expressed on the basis of lumens per watt, assuming 690 lumens per watt as the maximum theoretical efficiency.<sup>3</sup> Fig. 9 shows candle power plotted against second anode voltage and Fig. 6 shows candle power plotted against current carried by the electron beam for the cathode excitation of zinc orthosilicate phosphor. The general relation between candle power, applied voltage, and current intensity for phosphors excited by cathode rays is given by the equation:<sup>4</sup>

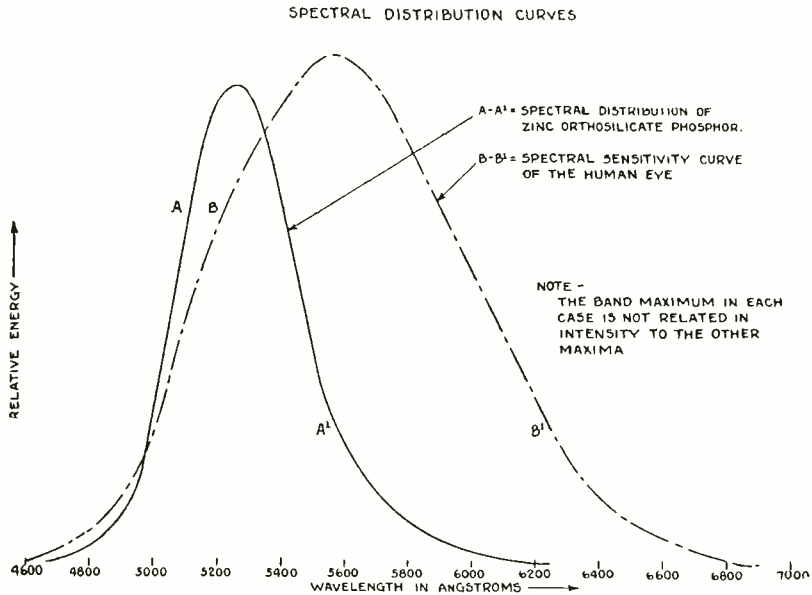

Fig. 8

$$I = AQ(V - V_0)$$

$I$  = the intensity of emitted light in candle power.

$A$  = a constant characteristic of the phosphor.

$Q$  = the current intensity in the beam in amperes per cm.<sup>2</sup>

$V$  = the applied voltage (in volts).

$V_0$  = the extrapolated minimum exciting voltage (in volts)  
(a constant for each phosphor).

<sup>2</sup> Forsythe and Watson, *Jour. Frank. Inst.*, vol. 213, no. 6; June, (1932).

<sup>3</sup> A. Schloemer, "Kathodenszillograph und Leuchtmasse," *Zeit. für Tech. Physik*, vol. 13, no. 5, (1932).

<sup>4</sup> Wien-Harms, "Handbuch der Experimentalphysik," part 1, ch. 23, p. 158.

Fig. 10 shows the time decay curve of the zinc orthosilicate phosphor luminescence. The decay curve shows that at the end of approximately 0.06 second practically all visible luminescence has ceased. For reproducing 24 pictures per second, the decay curve of the ideal phosphor should be long enough so that the phosphor just loses its effective brilliancy at the end of 1/24th of a second. If the time of decay is too long, the moving portions

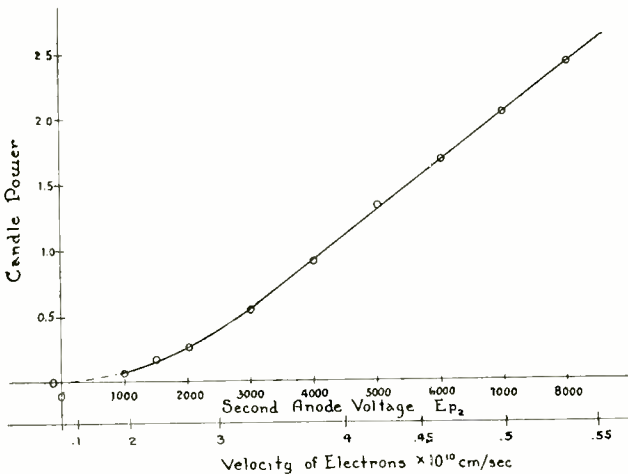

Fig. 9

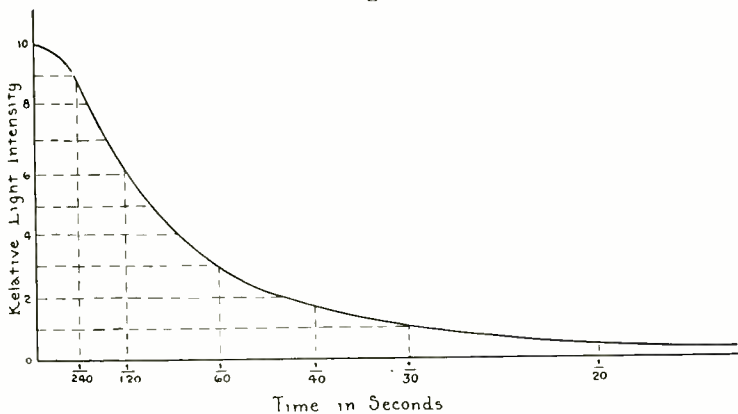

Fig. 10

of the picture will "trail," as, for instance, the path of a moving baseball would be marked by a comet-like tail. If the time of decay is too short, flicker is noticeable because of the space of comparative total darkness between the times when the fluorescent material is excited between successive pictures.

When the electron beam strikes the fluorescent screen, the screen would acquire a negative charge, which, because of the good dielectric properties of the phosphor, would remain on the surface and act as a repulsive force upon the electron beam and may completely repulse the beam from the screen, thus stopping the light emission. To remove this charge, we used to have a half-transparent, metallic film between the end of the kinescope tube and the fluorescent screen. Later, we found that a properly prepared phosphor emits a sufficient ratio of secondary to primary electrons to remove the accumulated charges. The secondary electrons are attracted to the high, positively-charged, metalized inner surface of the kinescope and thus the negative charge is carried away. Consequently, the kinescopes used in this equipment do not have transparent metallic film under the fluorescent screen.

The advantages of the kinescope in television over other means for reassembling the picture of the receiver are: the use of an inertialess beam, easily deflected and synchronized at speeds far greater than required for television; a sufficiently brilliant fluorescent spot which may be viewed directly on the end of the tube eliminating the restricted viewing angle usually present in mechanical scanners; noiseless operation; and the outstanding feature of the flexibility of the cathode ray tube itself.

### SCANNING

The problem of picture transmission is essentially three-dimensional, two dimensions being required for expression of area, while a third is required to indicate intensity. Since a single radio channel is ordinarily capable of transmitting only two-dimensional intelligence, namely, intensity of signal and duration of time, it is evident that the concept of area in a picture must somehow be effectively reduced to a succession of undimensional signals. This requirement introduces the necessity of scanning; that is, exploring the picture area, element by element, in some logical order in an interval of time so brief as not to be detectable by the human eye due to its persistence of vision.

One of the simplest methods of scanning a picture is to cause a spot of light to sweep across it in a succession of parallel horizontal lines. The motion of the spot across the picture may be either unidirectional or sinusoidal. An example of the latter type of scanning is employed with motion picture film in the system

described in an earlier paper.<sup>5</sup> At the transmitter this was accomplished by means of a galvanometer mirror which reflected the scanning beam onto the continuously moving film. In the cathode ray receiver this kind of motion is easily duplicated by deflecting the beam by a magnetic field produced by a sinusoidal current identical with the one energizing the galvanometer. This was superseded by unidirectional scanning. An example of unidirectional motion in scanning is that produced by the Nipkow disk widely used in television. The disk contains a single row of holes equally spaced around the circumference, successively spaced at smaller distances from the center.

The general arrangement of the transmitter used in the

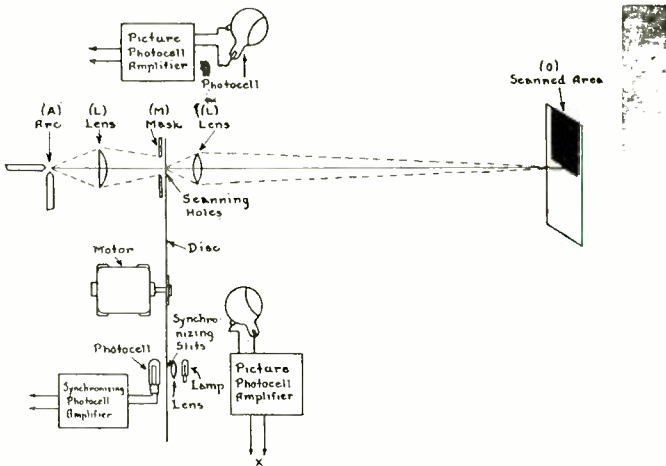

Fig. 11

present system is illustrated in Fig. 11. The components of this will be explained in an accompanying paper. Light from the source, *A*, is concentrated on the disk and images of the moving holes are projected through the lens, *L*, on to the object, *O*, to be televised. By means of the mask, *M*, only one hole is imaged at a time and, therefore, the flying spot covers the object completely with a series of parallel lines during each revolution of the disk. It is evident that the motion of spot across the object is uniform and in one direction only.

Light from the flying spot, reflected by the object, is gathered into a system of photo-electric cells and thus transformed into

<sup>5</sup> V. K. Zworykin, "Television with cathode ray tube for receiver," *Radio Eng.*, vol. 9, no. 12, pp. 38-41; December, (1929).

electrical impulses. These impulses, amplified, serve to modulate the output of the radio transmitter.

In televising moving picture film, the spiral row of scanning holes is replaced by a circular row, the vertical component of scanning being supplied by motion of the film, itself, passing the scanning line with a constant velocity. Here, as before, the flying spot explores the entire picture in a series of parallel lines, the light being transmitted directly through the object into a photocell situated behind the film.

In the experimental system described, the picture is made up of 120 lines and is transmitted at the rate of 24 per second. The picture has a 5-to-6 ratio of vertical to horizontal dimensions, and, therefore, the horizontal detail is equal to 144 lines. The beam traces a succession of equally spaced horizontal lines across the fluorescent screen, constructing the television picture in the identical manner that the flying spot at the transmitter has scanned it, beginning from the top downward and after the last, or 120th line, jumping back to the position at the start of a new picture.

In order to scan with a cathode ray beam in this manner, two variable magnetic fields are applied to the beam just as it emerges from the electron gun; a vertical one, pulsating 24 times per second, and a horizontal one, pulsating 2880 times per second.

$$\delta_1 = \frac{evB}{2m} \frac{l^2}{v^2}$$

$\delta_1$  = the displacement from the initial straight line.

$e$  = the charge on the electron.

$m$  = the mass of the electron.

$B$  = the intensity of the magnetic field.

$l$  = the length of path in the magnetic field.

$v$  = the velocity of the electron.

(All quantities expressed in electromagnetic and c.g.s. units.)

$\delta_2$ , the further displacement, during the time necessary to traverse the path from the magnetic field to the screen =  $evBlL/mv^2$ . The total displacement is given by

$$\delta = \delta_1 + \delta_2 = \frac{c}{m} \frac{Bl}{v} \left( \frac{l}{2} + L \right) \text{ cm}$$

$L$  = the distance from the deflecting magnetic field to the fluorescent screen.



When an electron beam passes through a magnetic field it is deflected in a direction normal to the magnetic lines of force according to the well-known equation<sup>6</sup>

In order that the cathode beam at the receiver follow the unidirectional scanning at the transmitter, the variation of intensity of both horizontal and vertical deflecting fields plotted against time is of a "saw-tooth" shape, as shown in Fig. 12. Each cycle consists of two parts; the first, linear with respect to time and lasting practically the whole cycle, and the second, or return period, lasting only a small fraction of the cycle. The picture is reproduced during the first part of the scanning period by varying the bias of the control element according to the light intensities of the transmitted picture, as described above.

There are a number of methods that will produce "saw-tooth"-shaped electrical impulses. A simple one has been described in an earlier paper,<sup>5</sup> consisting of charging a condenser through a

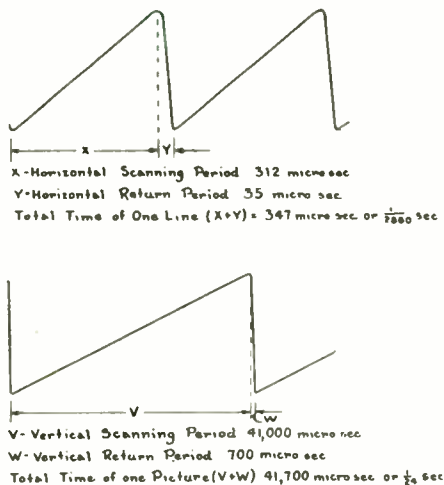

Fig. 12

current limiting device such as a saturated two-electrode vacuum valve and then discharging the condenser through a thermionic or gas-discharge tube. The practical limitation of this "saw-tooth" generator lies in the fact that there is no such thing as a completely saturated thermionic tube. Therefore, the condenser cannot be charged exactly linearly with time, and, consequently,

<sup>6</sup> J. T. Irwin, "Oscillographs," Isaac Pitman and Sons, Ltd., London, (1925).

the line reproduced on the fluorescent screen will be not exactly straight.

In order to straighten the scanning lines and improve the quality of the reproduced picture, a more complicated circuit was used, involving one dynatron oscillator and two amplifying tubes, as shown in Fig. 13. The condenser, *C*, in the horizontal deflecting circuit is charged continuously through the resistance, *R*. Periodically, at the end of predetermined intervals, the condenser is discharged. During these intervals, the accumulated charge does not reach saturation value, for the time ( $1/2880$  of a second) is insufficient. The vacuum tube through which the discharge takes place is controlled by impulses supplied from a dynatron oscillator having a distorted wave shape. The frequency of oscil-

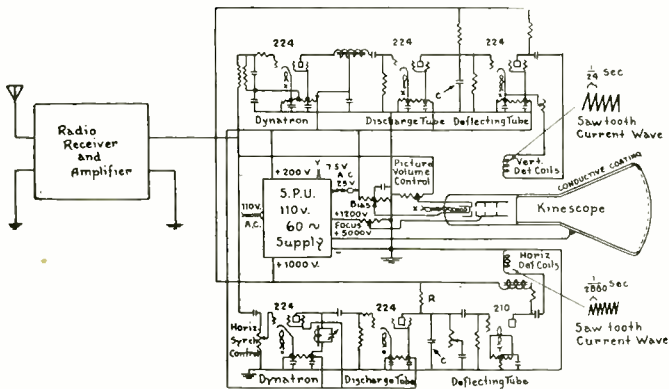

Fig. 13

lation of the dynatron (which can be made to vary over a fairly wide range) is initially adjusted to approximately 2880 cycles per second, so that received synchronizing signals will have no difficulty in pulling the dynatron into step with the synchronizing impulses generated by the transmitter scanning disk, as explained later. The charging and discharging of condenser, *C*, represent saw-tooth variations of potential, which, when applied to the grid of an amplifying tube, produce saw-tooth current impulses in deflecting coils connected in the plate of the amplifier.

The vertical deflecting circuit is similar to the horizontal circuit just described. Both vertical and horizontal deflecting systems operate on the beam by the magnetic fields generated by coils placed about the neck of the cathode ray tube.

The choice of electromagnetic deflection in preference to electrostatic was made more as a result of economical consider-

ation than mechanical choice. The kinescope for electromagnetic deflection is much cheaper to make than the one equipped with inside deflecting plates for electrostatic deflection. On the other hand, the electromagnetic deflecting unit itself requires more power and is more costly to build than the electrostatic one. The predominance of one or more factors depends chiefly upon the frequency of deflection and velocity of the beam.

The constants of the electrical circuits for vertical and horizontal deflection are, of course, entirely different, due to the great difference in the operating frequencies of the two deflection circuits.

### SYNCHRONIZATION

When both deflecting circuits are properly adjusted and synchronized with the transmitter, a pattern consisting of 120 paral-

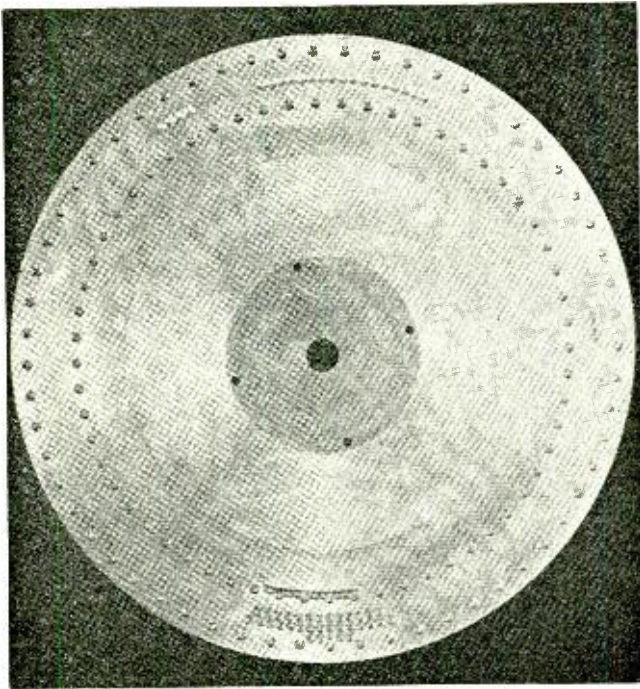

Fig. 14

lel lines is seen on the fluorescent screen. The sharpness of the pattern and perfection of its synchronization with the transmitter determines to a large extent the quality of the reproduced picture. This pattern is transformed into the picture by apply-

ing the picture signal impulses from the transmitter to the control element of the kinescope, so as momentarily to vary the brilliancy of the spot.

For sending synchronizing impulses, the transmitting scanning disk has an auxiliary row of slits, one for each scanning aperture. (See Fig. 14.) These slits, together with a separate illuminating lamp and photocell, produce impulses, one at the end of each line and at the end of each picture frame. The synchronizing impulses are transmitted over the picture signal channel. They do not interfere with the picture signals, because they occur at an instant when the picture actually is not being transmitted.

To allow the transmission of horizontal synchronizing signals at a time when the beam at the receiver is returning to start a new horizontal trace, the generation of picture signals is cut off for ten per cent of the scanning time. This is done by simply spacing the scanning disk apertures ten per cent farther apart than the width of the scanned frame. Vertical synchronization is carried out in the same manner, synchronizing impulses for this purpose being transmitted at the completion of each frame.

There is considerable advantage gained from using a synchronizing system in which the beam at the receiver is brought

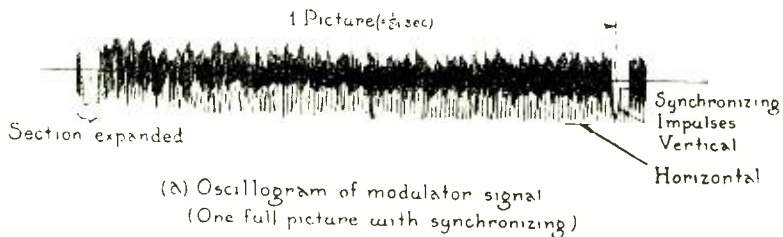

Fig. 15

into step with the transmitter at the end of each horizontal line because momentary disturbances of the nature of static do not appreciably affect the picture.

It will be seen that the transmitter is modulated by picture, horizontal synchronizing, and vertical synchronizing signals. The resulting composite signal which is fed to the modulator grid, therefore, appears as shown in Fig. 15. A clearer view of the components of this composite signal can be gathered from Fig. 16, the top curve of which represents the irregular-shaped picture signals which are often unsymmetrical about the axis, usually more positive than negative. Both synchronizing signals are

arranged to have their peaks on the negative side of the axis. The difference in shape of the horizontal and vertical impulses, of course, is due to the shape of the corresponding openings in the scanning disk, and this difference in wave shape is utilized at the receiver for the purpose of separating these two synchronizing impulses. The three signals mentioned above differ in frequency and in amplitude, since the horizontal synchronizing

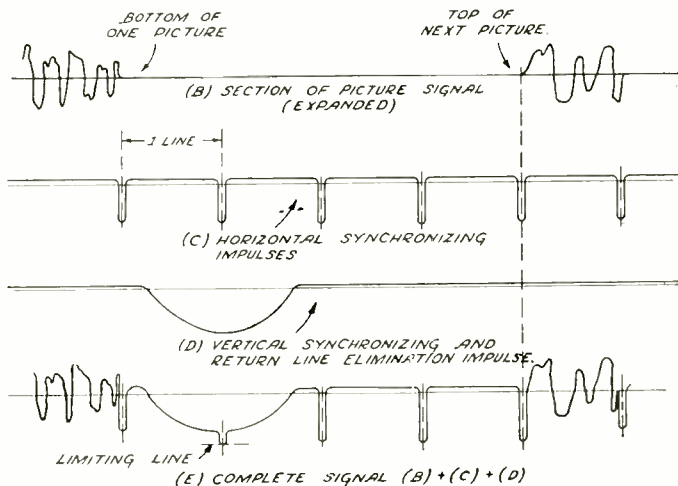

Fig. 16

impulses occur at a rate of 2880 per second, the vertical impulses 24 times a second and the picture signals at a widely varying rate. The peak picture signal amplitude is carefully adjusted to be always less than the horizontal and vertical impulses, the amplitude of the latter being approximately equal.

The separation of the three signals at the receiver is accomplished by a very simple means which is described in detail in an accompanying paper, so that the fundamentals only will be mentioned here. If we trace the signals at the receiver from the antenna through the radio receiver and amplifier, shown in Fig. 13, we find that they are applied to three independent units, the vertical deflecting system, the horizontal deflecting system, and the input to the kinescope. The synchronizing impulses do not affect the picture on the kinescope because they are transmitted at a time when the cathode ray beam is extinguished, that is, during its return period. The picture signals do not affect the deflecting circuits because amplitude selection is utilized; that is, the amplitude of the picture signals is never sufficient to affect the input tubes of either deflecting system. The selection between

vertical and horizontal synchronizing impulses is made on the basis of wave shape selection. A simple filter in each of the input circuits of the two deflecting units gives satisfactory discrimination against undesired synchronizing impulses. The plate circuits of both dynatron input tubes contain circuits approximately resonant to the operating periods of their respective deflecting circuits, thus aiding in the matter of selectivity.

When the electron beam returns to the position from which it starts to trace a new line, and particularly when it returns

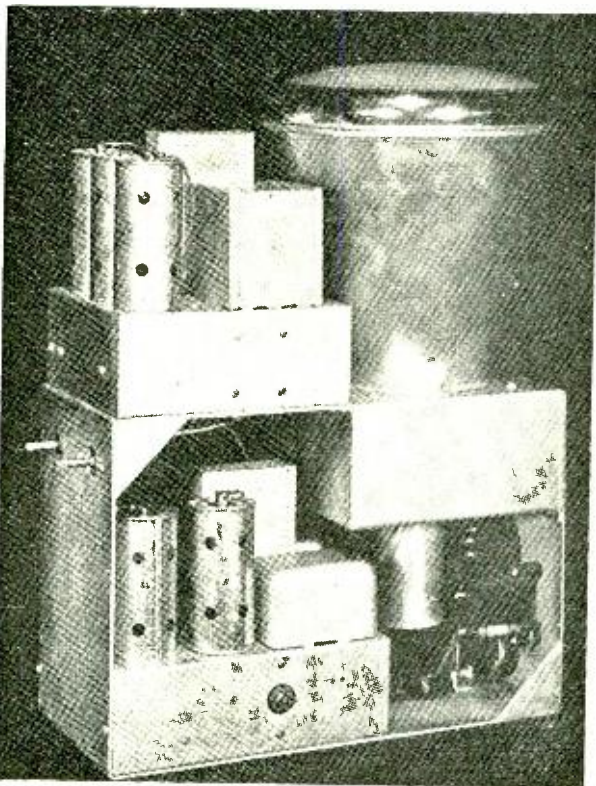

Fig. 17

from the bottom of the picture to start a new frame, an undesirable light trace, called the return line, is visible in the picture. To eliminate this the synchronizing impulses which are in the negative direction are applied to the control electrode of the kinescope, so as to bias it negatively and thus eliminate the return line by extinguishing the beam during its return.

To produce a picture, the intensity of light on a fluorescent

screen is varied by impressing the picture signal on the kinescope control element. If the bias adjustment on the kinescope is set so that the picture signals have the maximum swing on the characteristic curve of the kinescope (shown in Fig. 5) a picture with optimum contrast is produced. The picture background, or the average illumination of the picture, can be controlled by the operator by adjusting the kinescope bias.

### REPRODUCING EQUIPMENT

The arrangement of the television receiver built for these tests is shown in Figs. 17 and 18. The former is a photograph



Fig. 18

of the chassis containing the deflecting unit and kinescope. This chassis slides as a unit into the cabinet. Fig. 18 is a photograph of the complete receiver which contains a power unit, kinescope unit, two radio receivers—one for picture and one for sound signals—and a loud speaker.

The reproduced image is viewed in a mirror mounted on the inside lid of the cabinet. In this way the lid shields the picture from overhead illumination. This method also affords a greater and more convenient viewing angle. The brilliancy of the picture is sufficient to permit observation without the necessity of completely darkening the room. Since this type of television receiver has no moving mechanical parts it is quiet in operation.

The operations to be performed in tuning such a receiver are as follows: After the power switch is turned on, the picture and sound receivers are tuned to their respective signals in the ordinary manner. Next, the picture "volume" control (radio sensitivity control) is increased to that point at which the picture locks into synchronism. Then the signal voltage (picture-frequency amplification) to the kinescope is adjusted to the best operating point determined by observation. The background control is adjusted to the desired value depending upon the type of picture being transmitted.





# DESCRIPTION OF EXPERIMENTAL TELEVISION TRANSMITTING APPARATUS

BY

R. D. KELL

(RCA Victor Company, Inc., Camden, New Jersey)

*Summary*—A description is given of an experimental television transmitter. This equipment was installed in the Empire State Building and was used in making practical tests on an experimental television system. The installation included facilities for radiating sound and picture signals from studio and from motion picture film. The general considerations underlying the design and performance of television terminal and transmitting apparatus for this experimental system are reviewed.

## THEORETICAL CONSIDERATIONS

THE utilization of that part of the radio-frequency spectrum in the vicinity of 50 megacycles has removed from television the limitations of a narrow communication channel. The remaining question to be answered before an experimental system could be decided upon was how great a resolution of the picture would be practicable with the available terminal equipment. In the resolution of the picture, the limiting factor was found to be in the quantity of light available for scanning in the studio. In other words, as the picture resolution is increased with a corresponding decrease in the scanning spot size, the signal-to-noise ratio reaches a value beyond which the television signals are unusable. A ratio of ten to one has been found by experience to be about the limit of usefulness. From measurements on 48-, 60-, and 80-line television studio pick-up equipment, it was determined that with a light source of the highest intrinsic brilliancy available, the ratio of signal to noise would approach the limiting ratio of ten to one with 120-line mechanical scanning.

The terminal equipment developed for use at the transmitter consists of the usual photo-electric tubes with their associated amplifiers and scanning disk, using modified forms of the conventional type. At the receiver, a special cathode ray tube replaces the well-known scanning disk with its associated neon lamp. The scanning beam is made to move across the fluorescent screen of the receiving tube in synchronism with the scanning spot at the transmitter by means of special deflecting circuits.

Reprinted from Proceedings of Institute of Radio Engineers.

The scanning spot produced at the transmitter moves with constant velocity across the object being scanned. To produce an undistorted image of the object on the cathode ray tube, the scanning spot at the receiver must also move at constant velocity. After tracing a line across the screen, the beam must return before it can start the scanning of the next horizontal line. The scanning beam is often spoken of as being inertialess, which should allow its return across the screen in zero time. This is practically true, but the inertia of the deflecting circuits is such that approximately one tenth of the scanning time is required for the return of the scanning beam across the screen. To allow for this at the transmitter, the spacing of the apertures in the scanning disk is such that for ten per cent of the time there is no scanning spot on the object. Fig. 1 shows the useful picture

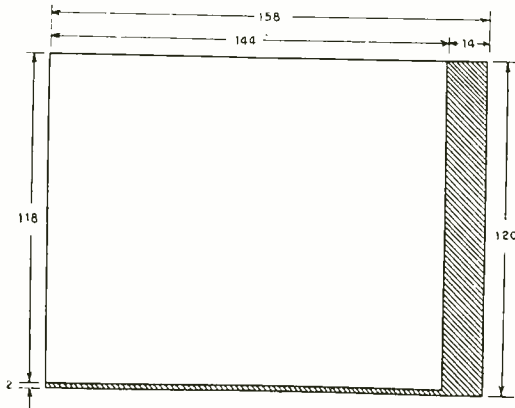

Fig. 1

area plus the shaded area which is that lost due to the time required for the return of the scanning beam. The dimensions shown are in picture elements, which in the vertical direction corresponds with the number of horizontal scanning lines.

The theoretical elements shown in the shaded area at the side of the useful picture area are to allow sufficient time for the horizontal return. The two lines at the bottom of the picture, likewise, allow sufficient time for the vertical return. The total theoretical number of elements which must be transmitted for the production of a picture of  $144 \times 118$  or 16,992 elements, is found to be  $120 \times 158$  or 18,960, which is a loss of 1968 elements due to the time required for the horizontal and vertical return of the scanning beam. The highest theoretical frequency required

of the system may be simply arrived at by assuming that the maximum frequency is produced when alternate elements are black. This produces  $18,960 \div 2 = 9480$  cycles per picture. At 24 pictures per second, the top frequency is then  $9480 \times 24 = 227,520$  cycles.

The lowest frequency that may be produced in the scanning of a stationary object is produced when the scanning field is half black and half white about a horizontal axis. For a scanning speed of 24 pictures per second, this lowest frequency is 24 cycles per second. These frequencies, 24 and 227,520 cycles, define the frequency band required for the production of a 120-line picture.

The synchronizing signals, to be sufficiently accurate for a picture having as many as 17,000 elements, must be supplied to the receiver directly from the transmitter. The use of even a common power supply for synchronizing the transmitter and

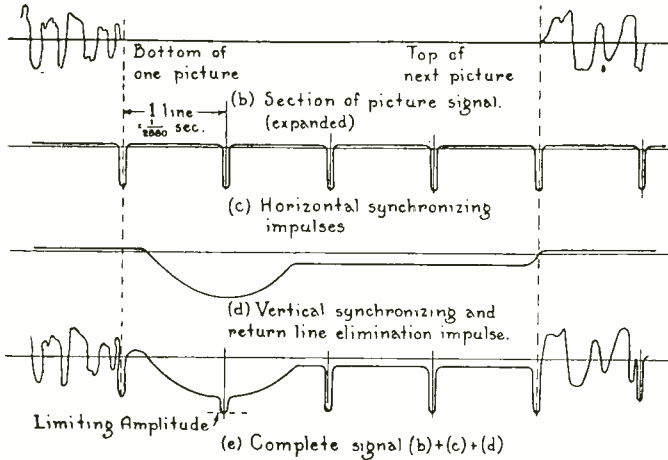

Fig. 2

receiver introduces difficulties when such a great number of picture elements are used. The horizontal synchronizing signals must have a frequency at least equal to the line frequency of the picture if the synchronizing is to be sufficiently accurate in a horizontal direction. A second frequency is required to frame the picture properly in the vertical direction. This also must be supplied from the transmitter.

Because of the time required for the scanning beam to return across the screen at the receiver, a loss of 1968 picture elements per picture is unavoidable. The use of this lost time for transmitting the synchronizing signals seemed, if possible, to be the

most desirable solution of the problem. The system developed makes use of this time during which no picture is transmitted for the transmission of both horizontal and vertical synchronizing signals. The first advantage of this is that it is possible to mix the synchronizing and the picture signals at the transmitter, and utilize them for their distinctive purposes at the receiver without the use of filters. The second advantage is that no additional width of frequency band is required for the synchronization of the picture.

At 24 pictures per second, the vertical synchronizing signal is 24 impulses per second and the line frequency of a 120-line picture repeated 24 times per second is  $120 \times 24 = 2880$  impulses per second. These then are the two impulse rates that must be transmitted to the receiver for the proper synchronizing and framing of the picture. The term "impulse" is used here instead of cycles, because the synchronizing signals are square-topped waves having a duration of approximately one fiftieth of their

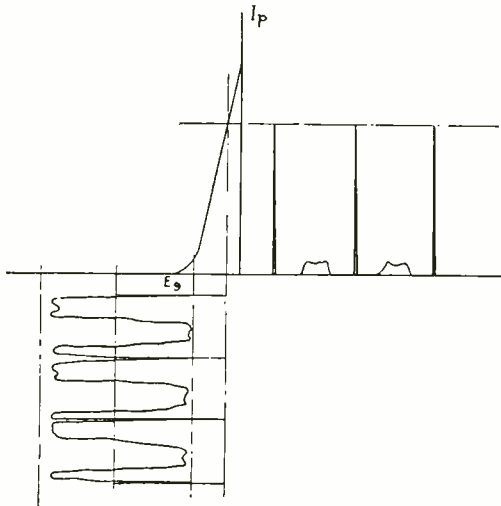

Fig. 3

repetition rate. Fig. 2 shows the general shape of the impulses and their relation to the picture signal. These impulses are generated at the end of each scanning line and last for 10 microseconds. They are produced by means of an auxiliary set of slits in the scanning disk at the transmitter through which light is directed into a photo-electric tube. At the end of each scanning of the picture, or every 24th of a second, a vertical synchronizing impulse, lasting for 350 microseconds, is produced by means of

a longer slit passing between the same lamp and photo-electric tube as used for the production of the horizontal synchronizing impulses. These synchronizing impulses are mixed with the picture in such a phase that all synchronizing signals are in the same direction as picture signals produced by the scanning of black, that is, all synchronizing impulses extinguish the scanning beam at the receiver. The vertical synchronizing impulse causes the scanning beam at the receiver to start its return to the top of the picture for the next vertical scanning. The beam moves from bottom to top across the scanning area on its return path, and would produce a bright diagonal line across the picture if some means of extinguishing the scanning beam during its return path

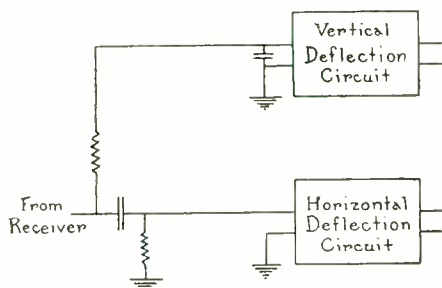

Fig. 4

were not employed. The signal produced by light passing through the low amplitude end of the vertical synchronizing slot serves this purpose, that is, it extinguishes the scanning beam until it has reached the top of the scanning area. During the horizontal return of the scanning beam it is extinguished, as no light falls into the picture photo-electric tube during the scanning of the ten per cent area at the side of the picture during which time the receiving beam is returning. The horizontal and vertical impulses are so adjusted as to have the same amplitude. Also, the picture signal level is maintained at such a value that it never exceeds the synchronizing impulses in amplitude. This allows the use of "amplitude selection" in the receivers to separate the synchronizing from the picture. Fig. 3 shows the condition of operation of the final synchronizing amplifier tube in the receiver, for selecting between the picture and synchronizing signals by amplitude selection. The grid bias is adjusted to such a value that the picture signal causes practically no change in plate current, and only the synchronizing impulses are amplified. The selection between the horizontal and vertical synchronizing impulses depends upon the difference in steepness of the wave front

of the two impulses. We have termed this method of separating the impulses "wave front selection." Fig. 4 shows the arrangement of the synchronizing circuits for making the selection between the horizontal and vertical synchronizing signals. In selecting the vertical impulse, the voltage across the condenser which is in series with a resistor is used. The values of condenser and resistor are such that the impedance presented by the condenser to the steep wave front of the horizontal synchronizing impulses is low, while its impedance is high to the gradual slope of the vertical synchronizing impulse. As a result, in the output of the network, the vertical impulses as applied to the vertical deflecting unit have approximately ten times the amplitude of the horizontal synchronizing impulses in the same circuit. It is important that the horizontal synchronizing impulses after passing through the selecting circuit be of such low amplitude that they do not affect the vertical synchronizing. If they are not sufficiently low, the picture may be improperly framed on any horizontal impulses. The principle of the action in the network for the horizontal selection is the same. But in this case the voltage across the resistor is used to operate the deflecting circuit. No serious harm is done if the horizontal and vertical impulses are mixed in the input to the horizontal deflecting unit, because during the vertical synchronizing impulse there is no picture on the receiving screen.

#### MECHANICAL DESIGN OF FILM SCANNER

Fig. 5 is a photograph of the motion picture film scanner designed and constructed for our television experiments. This scanner consists of the conventional scanning disk having apertures equally spaced around its periphery and on equal radii. The apertures in the disk are illuminated by a standard motion picture projection arc. Fig. 6 shows the optical system employed. The image of the scanning aperture is focused on the film by means of a projection lens placed at twice its focal length from the disk, so that its dimensions will be the same as the aperture in the disk. Ordinarily, when a photo-electric tube is placed behind the film, the scanning spot which moves across the film also moves across the cathode of the photo-electric tube. The result is undesirable variations in the photo-electric current due to the nonuniform sensitivity of portions of the cathode. To overcome this difficulty, a second lens was placed behind the film in such a position as to image the projection lens on the photo-electric tube.

This causes the light passing through the film to fall in a small stationary spot on the cathode.

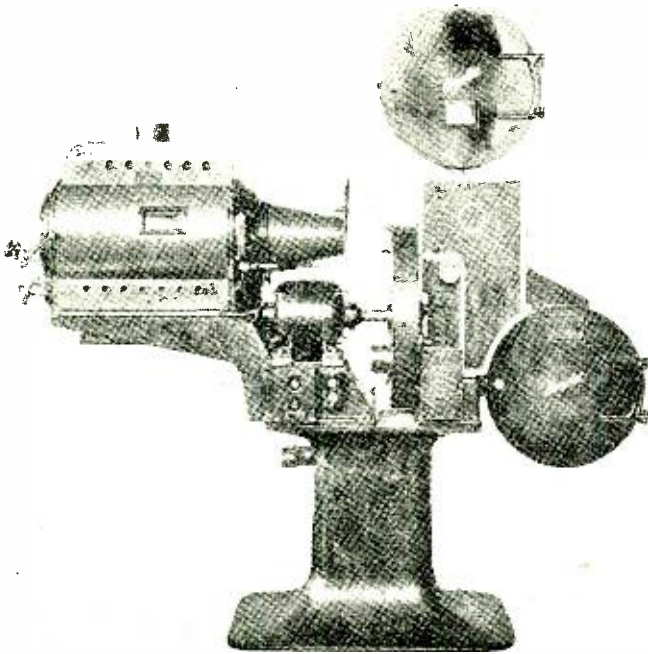

Fig. 5

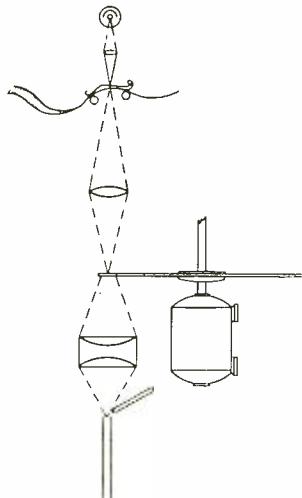

Fig. 6

Fig. 7 is a photograph showing the arrangement of the gates and sprockets in the motion picture scanner head. The path of the film is over a pull-down sprocket and through the picture gate. In order to insure an absolutely constant speed of film through the picture gate, it is necessary that some form of mechanical filter be provided to eliminate slight variations in speed intro-

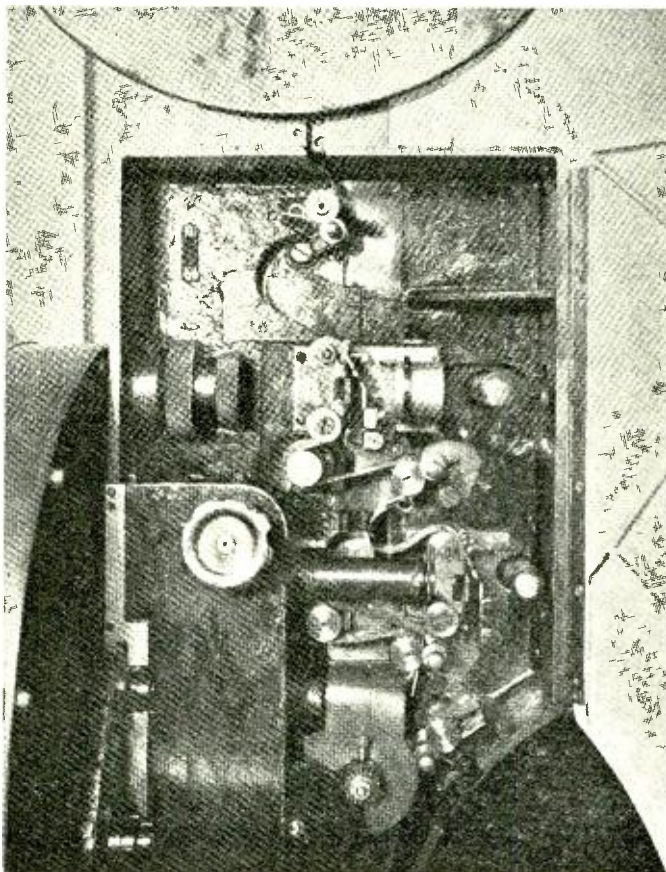

Fig. 7

duced by gear backlash, mechanical vibration, and the jerky feed inherent with sprocket-tooth drive. In this mechanism a device known as an impedance roller is used for this purpose. The impedance roller consists of a flywheel attached to a roller about the size of a sprocket wheel. The roller is driven by the film passing around it and is not connected to the drive mechanism in any other way. The film after leaving the picture gate passes over the roller to the constant speed sprocket. The inertia of the roller



serves to prevent any variations in the linear speed of the film, and causes the film to be drawn through the gate at an absolutely constant speed. The vertical framing of the picture is accomplished by manually adjusting the position of the film in the picture gate with respect to the vertical synchronizing aperture so that the vertical synchronizing impulse comes just as the scanning of a picture frame is completed. To make this adjustment, the impedance roller next to the picture gate is moved by means of the framing knob so as to vary the length of the film between the pull-down sprocket and the picture gate.

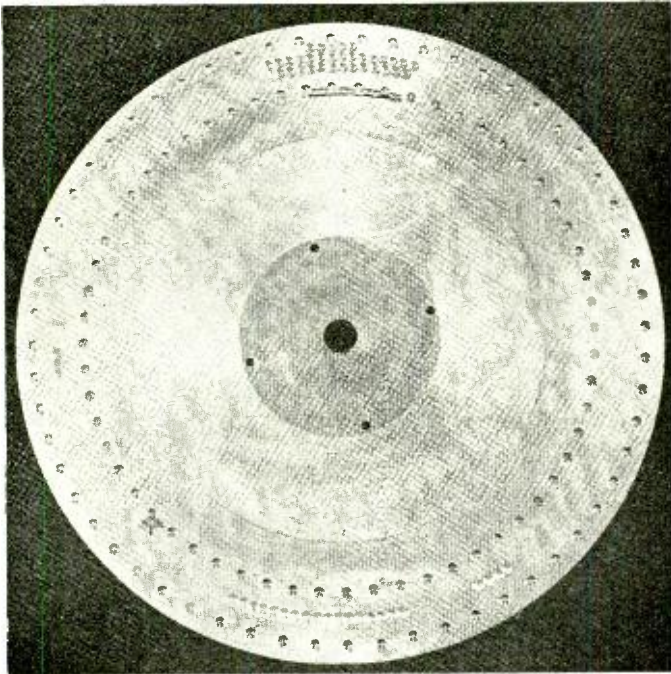

Fig. 8

Tests with the ordinary 120-line scanning disk proved it to be large and unwieldy. As a result a disk was used having half the required number of apertures and driven at double speed. Fig. 8 is a photograph of the scanning disk. Each of the 60 square apertures measures 0.006 inch on a side. The chordal distance between apertures is 0.926 inch. This dimension is the width of the picture (0.875 inch) plus ten per cent. The additional ten per cent is to allow the scanning beam to return across the screen at the receiver as already described.

Fig. 9 is a photograph showing the arrangement of the incandescent lamp and photo-electric tube used for obtaining the synchronizing signals from a second set of apertures in the disk having the same angular spacing as the picture scanning apertures, but on a shorter radius. The horizontal synchronizing apertures are 0.100 inch in length and 0.010 inch in width, while the vertical synchronizing slot is 2.8 inches in length and 0.100 inch in width at its widest part. The shapes of these two types

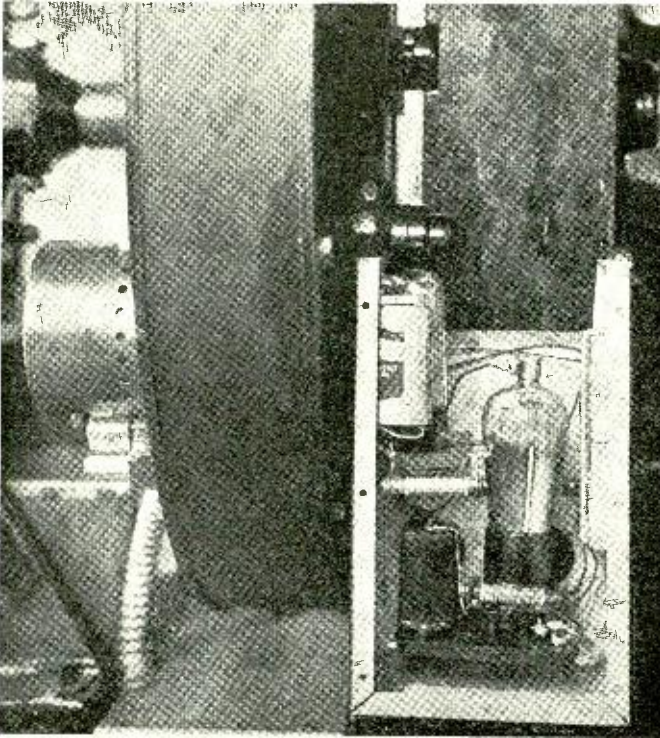
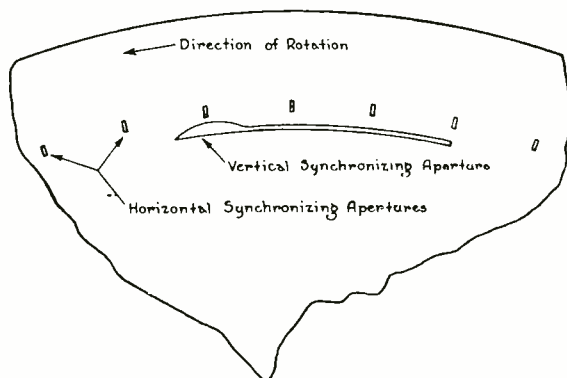

Fig. 9

of synchronizing apertures are shown in Fig. 10. An exciter lamp is used with a lens system arranged to place an image of the filament on the synchronizing apertures.

The position of the synchronizing lamp is such that the light passes through the horizontal synchronizing apertures and into the photo-electric tube just as the corresponding picture aperture moves from the edge of the picture into the ten per cent area in which no light falls on the picture photo-electric tube.

Fig. 11 shows the arrangement for securing the vertical synchronizing signal. A rotating shutter containing a slot is driven through a gear train so that at the completion of each picture the aperture for producing the vertical synchronizing impulse is uncovered. The gearing between the scanning disk and the film



Broken Section of disc.

Fig. 10

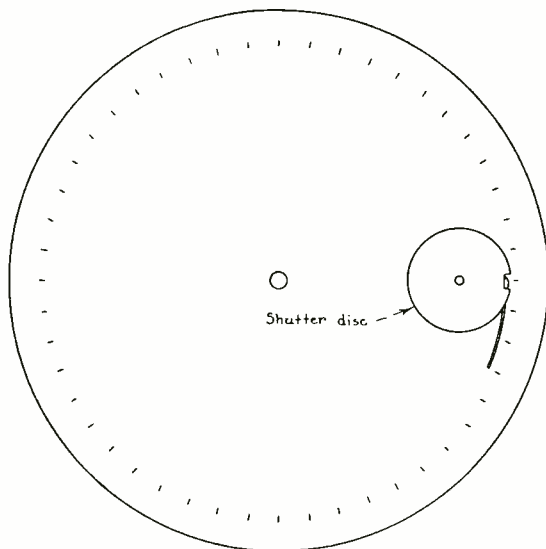

Fig. 11

drive sprockets is so arranged that two revolutions of the scanning disk (the passing of 120 apertures across the film) occur while the film moves one frame. With the disk running at 2880 revolutions per minute, the film runs at 24 frames per second, the standard sound film projection speed. A four-pole synchro-

nous motor operating from a 96-cycle power supply gives the required disk speed (2880 r.p.m.) without the use of gears between the disk and driving motor.

Any fairly constant speed drive would be suitable because receiver synchronization depends directly upon the scanning disk

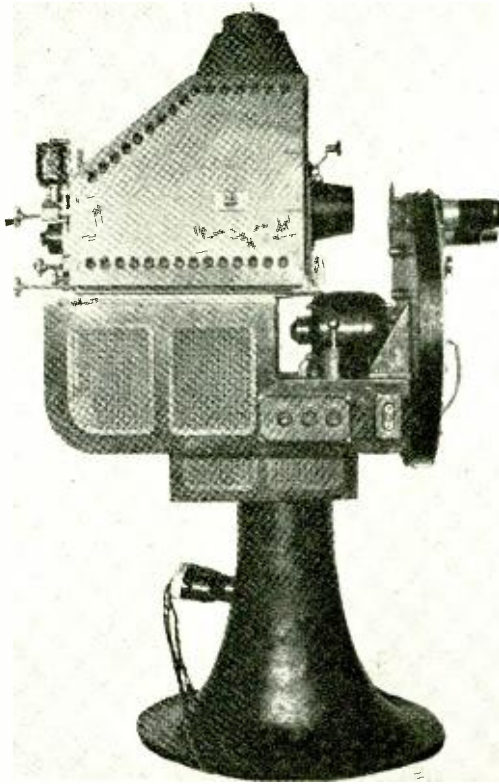

Fig. 12

speed; therefore, any change in speed or hunting of the scanning disk produces no displacement of the received picture. This is in contrast with the synchronizing of two mechanical scanning devices, where for a picture of 10,000 elements or more it is very difficult to obtain a speed control at the receiver sufficiently accurate to prevent appreciable shifting of the received image, due to hunting.

#### MECHANICAL DESIGN OF THE STUDIO SCANNER

Fig. 12 is a photograph of the studio scanner. A high intensity arc with a condensing lens system is used to illuminate the rec-

tangular picture aperture. Three lenses of different focal lengths are mounted on the disk housing in such a way that they may be changed back and forth with little effort or delay during a program, so that a quick change in the size of the scanning field in the studio for the transmission of either close-ups or of scenes

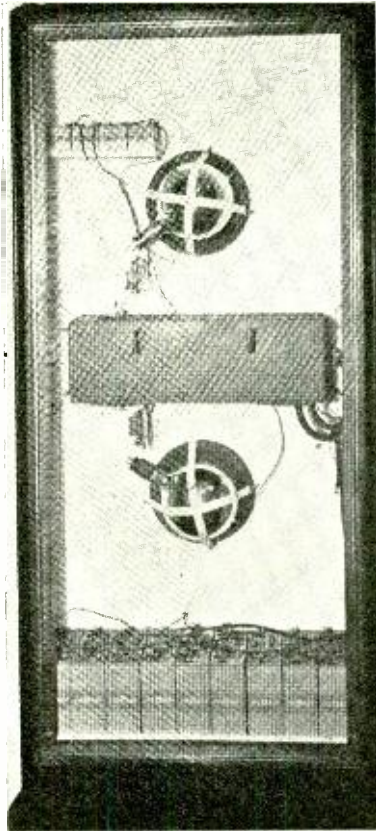

Fig. 13

containing several persons may be secured. The complete scanner is mounted on pivots so that it may be rotated and at the same time tilted upward or downward, to follow action in the studio. Two motors supply the tilting and rotating forces through reduction gears. These motors are both controlled by a special four-position toggle switch located near the monitor, so that the monitoring operator can easily keep the scanning field in the desired position in the studio. A duplicate toggle switch is placed in the studio, enabling the studio director also to control the position of the scanning field if desired.

## STUDIO PICK-UP EQUIPMENT

When a picture of 17,000 elements is to be transmitted from a studio, the photo-electric pick-up equipment must be capable of: (a) As great a ratio of picture signal to noise as possible; (b) uniform response to light variation up to 225,000 per second;

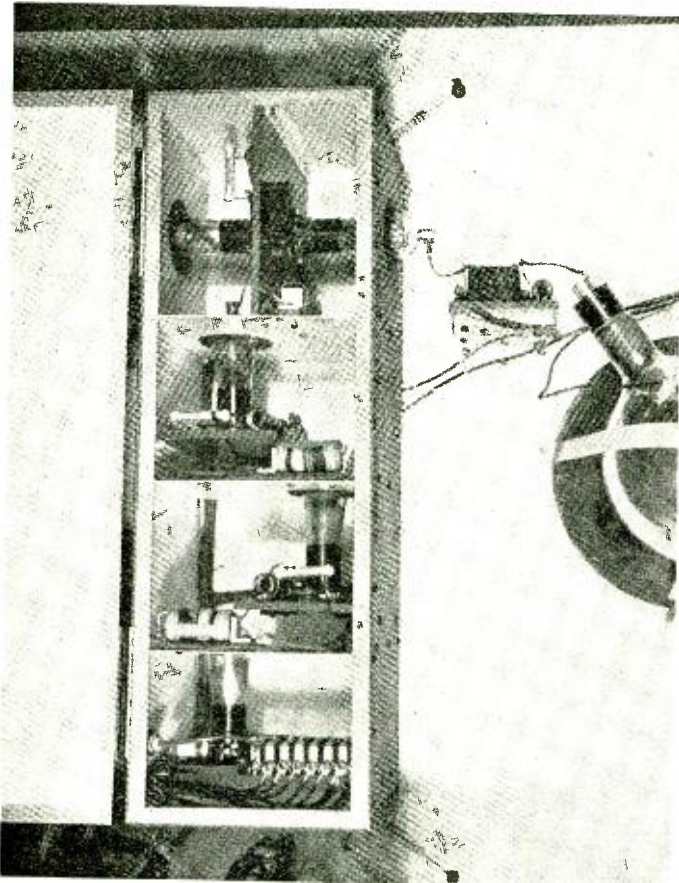

Fig. 14

and (c) arrangement permitting satisfactory close-ups and long-distance views.

For studio work spherical photo-electric tubes of caesium oxide, gas-filled type are used, two tubes forming a pick-up unit. Between each pair of photo-electric tubes is placed a shielded amplifier which may be seen in Fig. 13, a photograph showing the rear view of one of the units with the back removed. Fig. 14 shows the arrangement of the picture amplifier.

THE PRODUCTION OF THE TELEVISION SIGNALS

The photo-electric tubes used in the studio and in the film scanner are gas-filled and have appreciable time lag. Fig. 15 shows a typical frequency response curve of the tubes with different polarizing voltages. The response is seen to increase

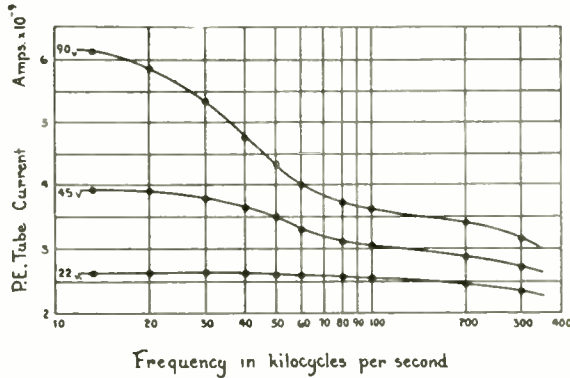

Fig. 15

quite rapidly with increased polarizing voltage at the lower frequencies, but above 60 kilocycles only a small increase in response is secured by increasing the polarizing voltage. The maximum polarizing voltage that is practicable with this type

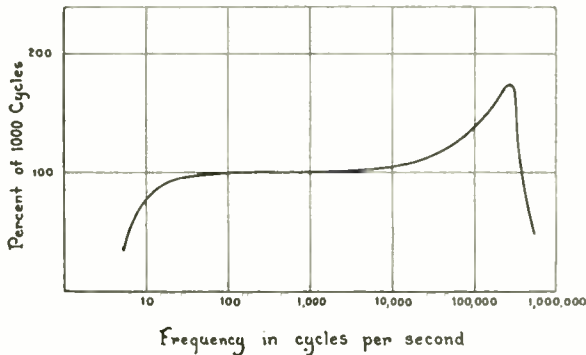

Fig. 16

of tube when working at frequencies above 200 kilocycles is 45 volts. When sufficient light is available to secure satisfactory signal-to-noise ratio, an operating voltage of 22 is preferable.

The capacity across the load resistance at the input to each amplifier stage is very important in determining the frequency characteristic of the system, and must be kept as low as possible

if the output voltage to the amplifier is to remain practically constant up to 225 kilocycles. At this frequency 10 micromicrofarads have an impedance of only 70,000 ohms. The photo-electric tubes in the studio pick-up units are connected directly to the grids of special screen-grid tubes, with the shortest possible connections. The photo-electric tube in the film scanner is also connected directly to the grid of its amplifier tube.

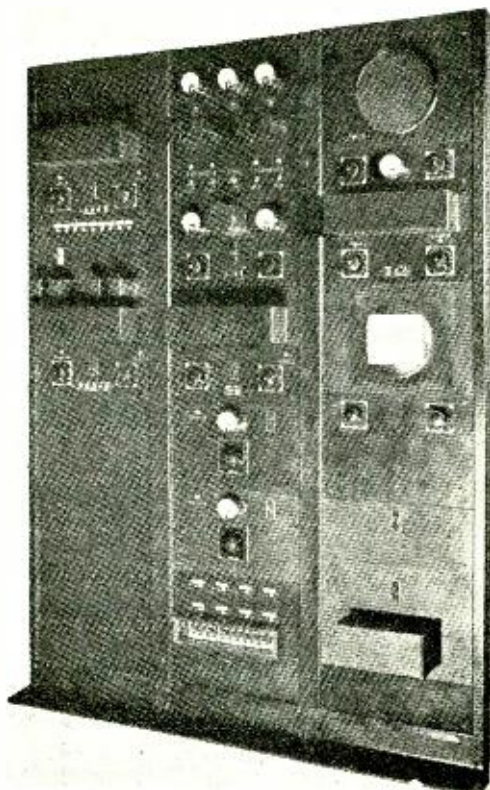

Fig. 17

The amplifiers make use of special coupling circuits to produce the desired frequency characteristic. The plate circuit of each voltage amplifier contains an inductance having a value such that the tube and stray capacity across the coil produce a parallel resonant circuit having a natural period well above the working range of the amplifier. This method of coupling between stages makes possible an amplifier having practically any desired characteristic over a wide band of frequencies. Actually the ampli-



fiers are designed to have a rising characteristic such that the response at 200 kilocycles is approximately twice that at 1000 cycles as shown in Fig. 16. This rising characteristic compensates electrically for the decrease in light change at both the transmitter and receiver when the width of the detail being scanned approaches the width of the scanning spot.

The amplifiers in the film scanner and in the studio pick-up units have an output impedance sufficiently low to allow the transmission of the signal over special low capacity cable to the con-

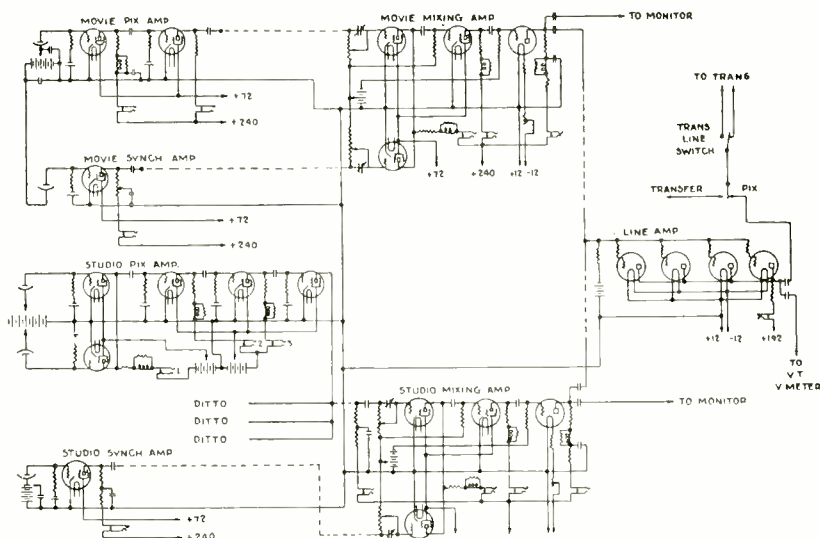

Fig. 18

trol room. The output from the synchronizing amplifiers on both the studio scanner and the film scanner are transmitted to the control room over low capacity cable in the same manner as the picture signal.

In the control room the synchronizing signal is mixed with the accompanying picture signal in an arrangement of two amplifier tubes having a common plate resistor. The synchronizing signal is applied to the grid of one and the picture signal to the grid of the other. The combined signal is then amplified to give approximately 2 volts (peak) across 1000 ohms, after which it is applied to the line amplifier. This amplifier consists of a group of low impedance tubes in parallel and has a voltage amplification of unity. Its output impedance is sufficiently low to allow the transmission of the television signals over special low capa-

city cable to the radio transmitter without objectionable attenuation of the high frequencies. Fig. 17 is a photograph showing the general arrangement of the amplifier racks. Fig. 18 is a schematic diagram showing the complete amplifier layout of the installation in the Empire State Building. The switching is so arranged that the signals from the film scanner or the studio may be passed through the line amplifier to the radio transmitter. The picture monitor may be connected to either the output of the picture amplifier or to a radio receiver, which makes possible the monitoring of the radiated signals. All speech equipment is arranged to be switched simultaneously with the picture signals so that the picture with its accompanying sound are always together.

### THE RADIO TRANSMITTERS

Both the picture and sound transmitters utilize quartz crystal oscillators driving power amplifiers through frequency doubler and tripler stages. The sound transmitter was modulated in its power amplifier stage by a class "B" modulator of conventional design.

The picture transmitter was also modulated in its power amplifier, but the requirements were unusual in that the transmitter had to be capable of being modulated uniformly by frequencies from 24 cycles to 225,000 cycles. To accomplish this, the power stage was modulated by means of two UV-848 modulator tubes. The modulation reactors were of special design having very low distributed capacity. The voltage amplifiers preceding the UV-848 tubes have circuit constants such that practically constant response is obtained over the desired frequency range. The adjustment of the modulation at the transmitter is unusual in that amplitude distortion of the synchronizing signals is purposely permitted in order that these signals produce over one hundred per cent modulation. The polarity of modulation is such that the synchronizing impulses drive the plate current of the modulator practically to zero, causing the radio-frequency output to increase. So far as the radiated picture signals are concerned, this means the black portions of the picture correspond to an increase in amplitude of the radio-frequency carrier. The advantage of this method of operation is that the carrier may be driven to one hundred and twenty-five per cent modulation on the synchronizing impulses, thus permitting one hundred per cent modulation for the picture signals.

# DESCRIPTION OF EXPERIMENTAL TELEVISION RECEIVERS

BY

G. L. BEERS

(RCA Victor Company, Inc., Camden, New Jersey)

*Summary*—Several television and sound receivers were constructed for use in an experimental system. The major considerations involved in the design of these receivers are outlined. Curves are shown which illustrate the receiver performance characteristics. A brief discussion of some of the observations which were made during the field tests of the receivers is included.

## INTRODUCTION

THE necessity for a wide communication band to realize even limited picture detail has brought about a consideration of frequencies above 30 megacycles per second for the dissemination of television programs. One of the major factors in determining the desirability of these frequencies for television applications is the possibility of designing suitable receivers for such frequencies. Experimental television and sound receivers have been built for these ultra-high frequencies and have given satisfactory results in the reception of both sound and television programs. It is the purpose of this paper to describe the design of these receivers and report some of the observations which were obtained through their use. These receivers were used in the general television field tests and survey work referred to in the first paper of this series.

## GENERAL

When the problem of providing experimental ultra-high frequency receiving equipment capable of receiving both picture and sound programs was first considered, it was decided to use separate receivers for the sound and picture communication bands. The use of two receivers would provide considerably greater flexibility in the choice of the picture and sound carrier frequencies than would have been possible if a combination picture and sound receiver had been used. The general performance requirements for the two receivers were as follows:

1. The sensitivity should be sufficient under normal receiving conditions to reach the level where noise and interference becomes objectionable.

Reprinted from Proceedings of Institute of Radio Engineers.

2. The selectivity of the receivers should be as great as consistent with the use of a reasonable number of tuned circuits designed to pass the necessary communication bands.
3. The fidelity of the sound receiver should be comparable with the fidelity of the modern broadcast radio receiver. The fidelity of the picture receiver should be such as to provide the faithful reproduction of the transmitted image. The maximum frequency required to reproduce the picture and synchronizing impulses with the television system in use was approximately 227,500 cycles per second.

After a brief consideration of these specifications, it was evident that the superheterodyne type of receiver was best suited to

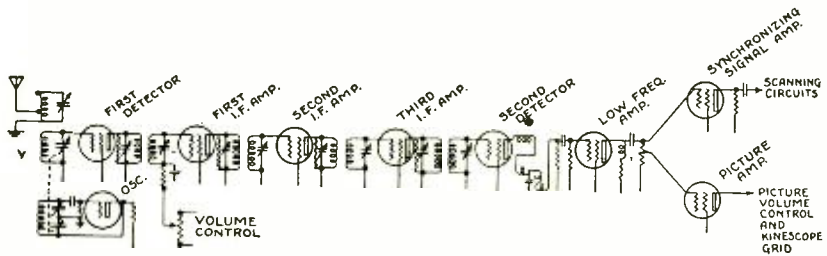

Fig. 1

provide the desired performance. Since both the sound and picture receivers were to operate in the same cabinet, the tuning range of the picture receiver was limited to 35 to 55 megacycles per second, and the sound receiver from 55 to 75 megacycles per second. These limitations on the tuning range of the two receivers

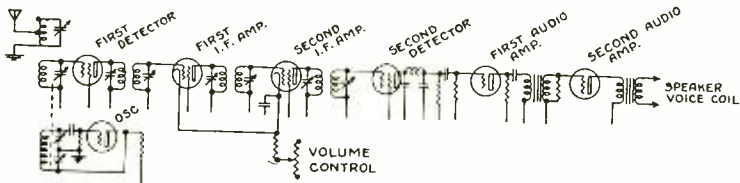

Fig. 2

were imposed in order to prevent the interference which might result from the oscillator frequency of the one receiver being adjusted to a frequency in the tuning range of the other receiver.

The schematic circuit diagrams of the picture and sound receivers are shown in Figs. 1 and 2. The same general design was employed in both the sound and picture receivers. The main differences between the two receivers were in the intermediate-

frequency and low-frequency amplifiers. These differences will be discussed in detail in the sections of the paper devoted to these amplifiers.

### ANTENNAS

Several types of ultra-high-frequency antennas were tested to determine the most suitable type for installation in the average home. Directional antennas were the most efficient of the types tested, but these would be unsatisfactory for receiving signals from television broadcast stations located in different directions unless some means for rotating the antenna structure were provided. A vertical half-wave antenna connected directly to the receiver was found to be the most satisfactory in the majority

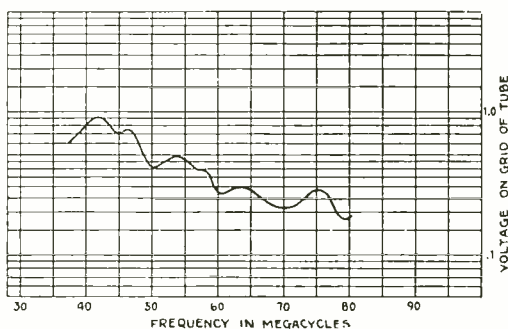

Fig. 3

of locations. An antenna of this type will function satisfactorily over a fairly wide frequency range, as indicated by the curve in Fig. 3. This curve shows the voltage developed across a tuned circuit directly connected to a half-wave vertical antenna 96 inches long.

A small number of homes were found where the indoor half-wave antenna did not intercept signals of sufficient strength to permit satisfactory reproduction of the television programs. At these locations it was necessary to erect the antenna in an unshielded location, such as above the roof of the building, and connect it to the receiver through a transmission line.

The field strength interference patterns encountered in the frequency range from 40 to 80 megacycles made it necessary to determine experimentally the antenna location which would provide the greatest signal strength. An indication of these variations in field strength is given by the contours in Fig. 4, which show the relation between received signal strength and antenna location on the ground floor of a house. A vertical half-wave

antenna directly connected to a tuned circuit and vacuum tube voltmeter was used to determine the signal strength. From the contours in this figure it is evident that moving the receiving antenna a distance of but one or two feet may change the strength of the received signals by several hundred per cent. These interference patterns are functions of both the frequency on which the transmitter is operating and its geographical location. More than one antenna might, therefore, be necessary to obtain satis-

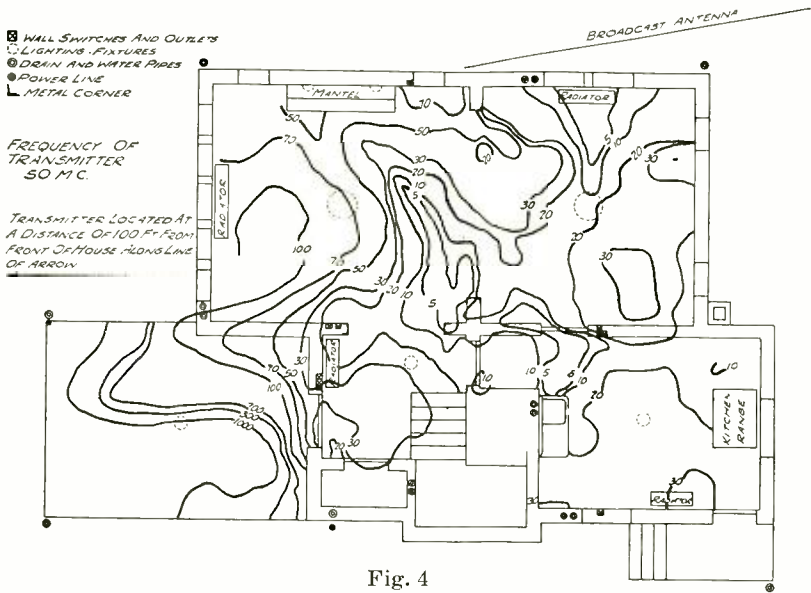

Fig. 4

factory results in receiving signals from a number of television transmitters. This requirement is not as serious as it would seem at first thought, since a half-wave antenna for frequencies above 30 megacycles is small and easily erected.

### RADIO-FREQUENCY CIRCUITS

Two coupled tuned circuits were used in both receivers to transfer the received signals from the antenna to the grid of the first detector. The first tuned circuit was provided with suitable terminals so that the antenna might be connected across either a part or all of the tuned circuit. This tuned circuit was also provided with a separate tuning control so that experiments with various antenna arrangements might be conducted. The coupling between the two tuned circuits was so adjusted as to provide a flat-topped selectivity characteristic. The self-supporting coils

used in these tuned circuits were one inch in diameter, wound with No. 10 B. & S. copper wire. The radio-frequency resistance of the coils was as low as permissible on the basis of the communication band which the radio-frequency circuits must pass.

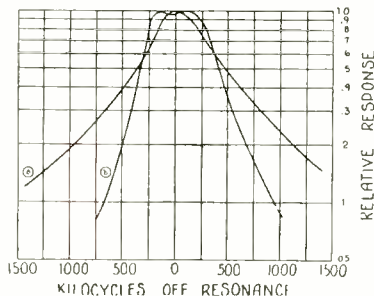

Fig. 5

The  $\omega L/R$  ratio for the individual tuned circuits was approximately 125. Curve (a) in Fig. 5 shows the selectivity characteristic of a single tuned circuit at 50 megacycles. The selectivity characteristic of the two coupled tuned circuits is shown in curve (b) of the same figure.

#### OSCILLATOR AND FIRST DETECTOR

The oscillator circuit used in both the sound and picture receivers is shown in Fig. 6. A UY-227 tube functioned satisfactorily in this circuit up to 80 megacycles. Electromagnetic coupling between the oscillator and first detector tuned circuits was

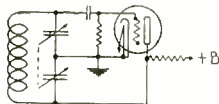

Fig. 6

used to apply the desired oscillator voltage to the grid of the first detector which was a negatively biased UY-224 tube. Fig. 7 shows the radio-frequency coil and tuning condenser arrangement.

In order to prevent the necessity of frequent retuning of a superheterodyne receiver, it is essential that the width of the frequency band which the intermediate-frequency amplifier is designed to pass be greater than the frequency deviations of the oscillator. The fulfillment of this requirement may make it necessary to design the intermediate-frequency amplifier to pass a frequency band which is several times the width of the com-

munication band it is intended to amplify. This condition was encountered in the design of the sound receiver. The maximum frequency variation of the oscillator, due to temperature changes of the oscillator tuned circuit elements and variations in line voltage, was approximately 0.1 per cent. With the oscillator tuned to 60 megacycles, this degree of oscillator frequency instability might result in a frequency deviation as great as four times the width of the communication band which the sound re-

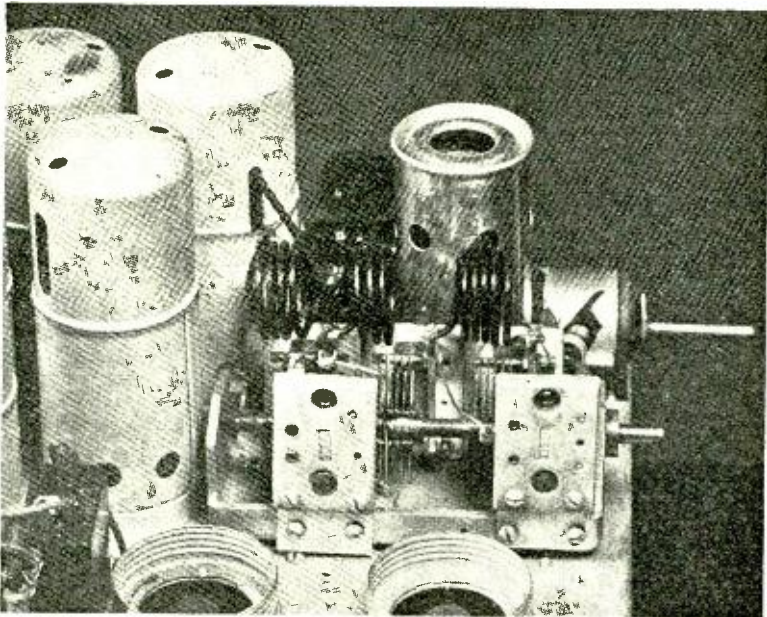

Fig. 7

ceiver was required to amplify. The communication band required for the reception of the picture signals, however, was several hundred kilocycles, making it unnecessary to consider the oscillator frequency variations in the design of the intermediate-frequency amplifier for the picture receiver.

#### PICTURE RECEIVER INTERMEDIATE-FREQUENCY AMPLIFIER

The wide communication band necessary to provide satisfactory reproduction of the television program required the use of a comparatively high intermediate frequency to obtain the desired amplification and selectivity characteristics. A high intermediate frequency was also desirable to minimize the interference due to a transmitter separated in frequency by twice the



intermediate frequency from the transmitter whose signals it was desired to receive. A consideration of both these factors led to the choice of 6 megacycles as the intermediate frequency for the picture receiver. The complete intermediate-frequency amplifier used four transformers, each having two tuned circuits so coupled as to give a selectivity characteristic of the desired band width. A damping resistor was used across the primary of each transformer to flatten the top of the selectivity characteristic.

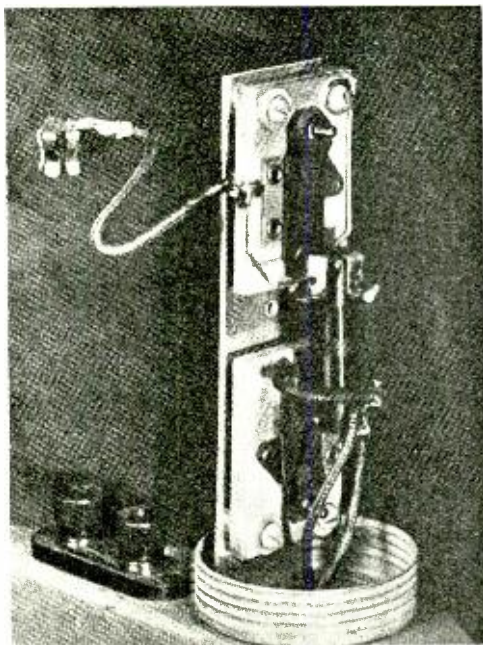

Fig. 8

The two resonant circuits in each transformer were tuned by means of small adjustable condensers. The arrangement of the coils and condensers in an individual transformer is shown in the photograph in Fig. 8. The long, narrow transformer construction permitted the location of a tuned circuit at the top and bottom of each transformer, thus making possible the use of very short leads to the grid and plate of the associated tubes. The same type of metal shield was used for both the transformer and amplifier tube.

The selectivity characteristic obtained from a single intermediate-frequency stage of the picture receiver is shown by curve (a) in Fig. 9. The over-all selectivity characteristic of the three-

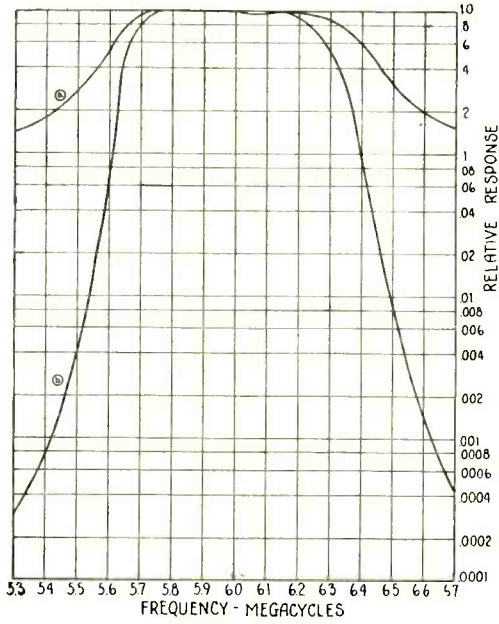

Fig. 9

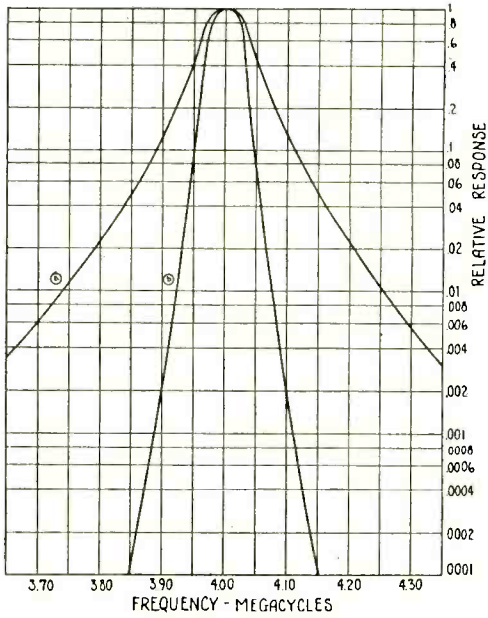

Fig. 10

stage amplifier is shown in curve (b) of the same figure. The voltage gain of this amplifier as measured from the grid of the first detector to the grid of the second detector was approximately 7000.

### SOUND RECEIVER INTERMEDIATE-FREQUENCY AMPLIFIER

Both the sound and picture receivers were to operate in the same cabinet, and it was therefore undesirable to use the same intermediate frequency in both receivers because of the possibility of coupling between the two amplifiers causing interference. Four megacycles was chosen as the intermediate frequency

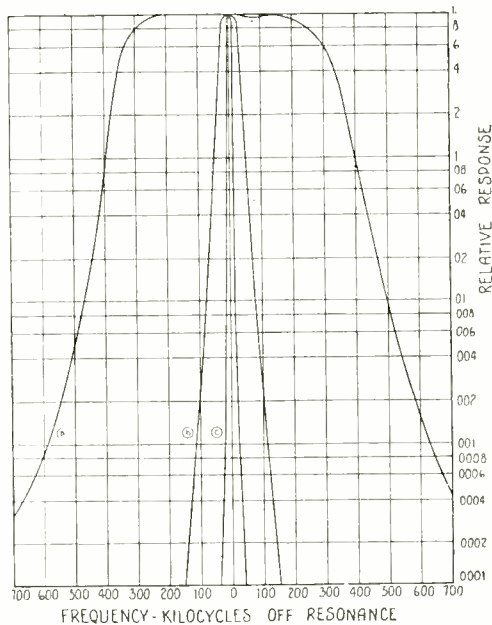

Fig. 11

for the sound receivers. The intermediate-frequency amplifier was designed to pass a band of 50 kilocycles in order to minimize the effects of the oscillator-frequency variations. The sound receiver intermediate-frequency transformers were similar in design to those used in the picture receiver. Three transformers were used in the complete amplifier. The selectivity characteristic of an individual transformer is shown in curve (a) in Fig. 10. Curve (b) in the same figure shows the over-all selectivity characteristic of the complete amplifier. The voltage gain, as measured from the grid of the first detector to the grid of the second

detector, was 8000. Fig. 11 shows a comparison between the intermediate-frequency amplifier selectivity characteristics of the picture receiver, the sound receiver, and a typical broadcast receiver. These characteristics are shown in curves (a), (b), and (c), respectively.

#### PICTURE-FREQUENCY AMPLIFIER AND DETECTOR

The picture-frequency system of the television receiver consisted of a negatively-biased detector and a two-stage resistance-coupled amplifier. The television system for which the receivers were designed made use of a carrier wave which was modulated with both picture and synchronizing impulses. The synchronizing impulses were slightly larger in amplitude than the picture impulses. In order that this difference in amplitude between the picture and synchronizing impulses might be accentuated in the receiver, two separate output tubes were provided. One of these tubes was used to supply the picture impulses to the grid of the kinescope, while the other was used to impress the synchronizing impulses on the vertical and horizontal deflection circuits in the kinescope unit. The bias on the synchronizing output tube was made sufficiently negative to distort the impulses supplied to its grid, and thereby accentuate the difference in their amplitudes. The high negative bias used on the synchronizing output tube caused a decided reduction in amplification. In order that sufficient output might be obtained from the synchronizing output tube without overloading the picture output tube, the grids of these two tubes were connected to a tapped resistor which was coupled to the plate of the first low-frequency amplifier tube through the usual coupling condenser. The grids of the two output tubes were connected to the tapped resistor so that the impulses applied to the grid of the synchronizing output tube had twice the amplitude of those applied to the picture output tube. A potentiometer connected in the plate circuit of the picture output tube was used to control the amplitude of the signals applied to the grid of the kinescope. A potential variation of only ten volts on the grid of the kinescope was sufficient to provide full modulation of this type of light source. This voltage could readily be obtained from a UY-224 tube, even though a comparatively low value of load resistance was used to obtain the desired frequency response characteristic. UY-224 tubes were likewise used for the synchronizing output tube, the first low-frequency amplifier and the negatively-biased detector. The over-

all frequency response characteristic of the complete amplifier is shown in curve (a) Fig. 12.

### AUDIO-FREQUENCY AMPLIFIER AND DETECTOR

The audio-frequency system of the sound receiver was similar to that employed in conventional broadcast receivers. The negatively-biased UY-224 detector was followed by a resistance-coupled audio-frequency stage using a UY-227 tube. This tube, in turn, was coupled through a transformer to the UX-210 output tube. The UX-210 tube was used because it minimized the power required from the combined socket power unit since the high plate potential used with this tube was also required for the synchronizing circuits. The frequency-response characteristic of the complete audio-frequency amplifier is shown in curve (b) of Fig. 12. A comparison between curves (a) and (b) in this figure shows the relative frequency characteristics of both the picture and sound low-frequency amplifiers.

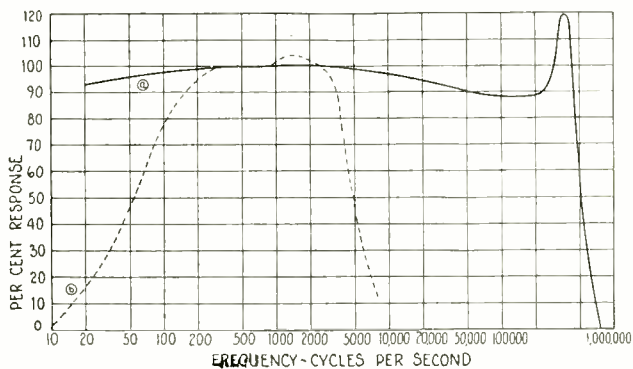
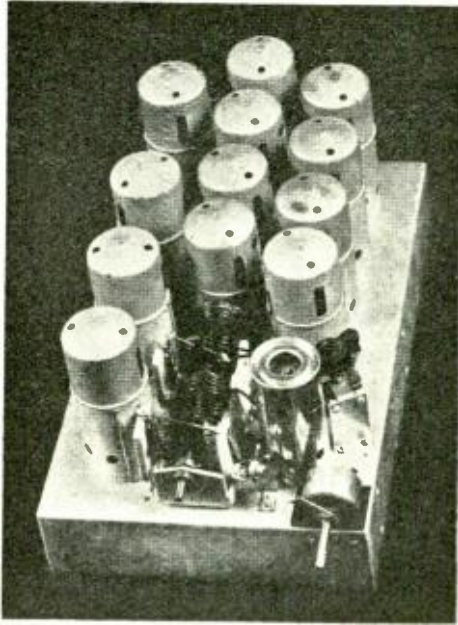

Fig. 12

### COMPLETE RECEIVERS

The general chassis arrangement of the picture receiver is shown in Fig. 13. The four metal shields in the middle of the chassis contain the intermediate-frequency transformers. The tubes are enclosed in the other shields. Fig. 14 is a photograph showing the bottom view of the chassis. The arrangement of the by-pass condensers and coupling resistors is illustrated in this figure. Fig. 15 shows the general arrangement of the sound receiver chassis. Three of the shields on this chassis contain intermediate-frequency transformers; the remainder are tube shields. Both receivers were mounted in the cabinet on blocks of sponge



**Fig. 13**

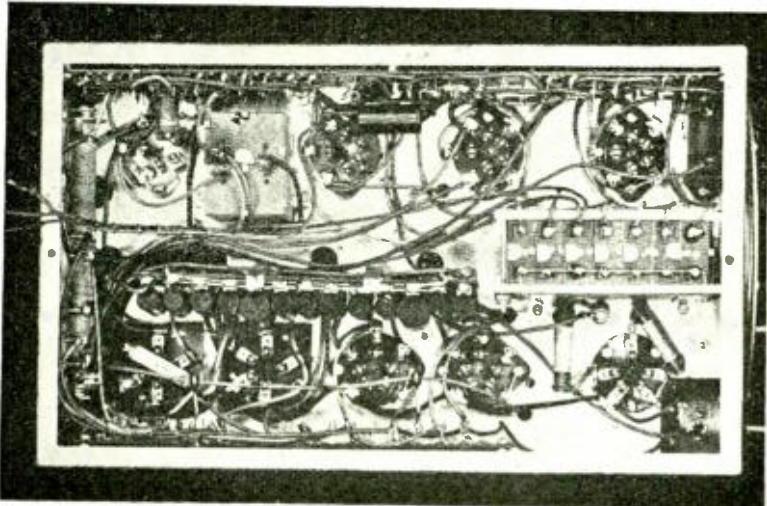

**Fig. 14**

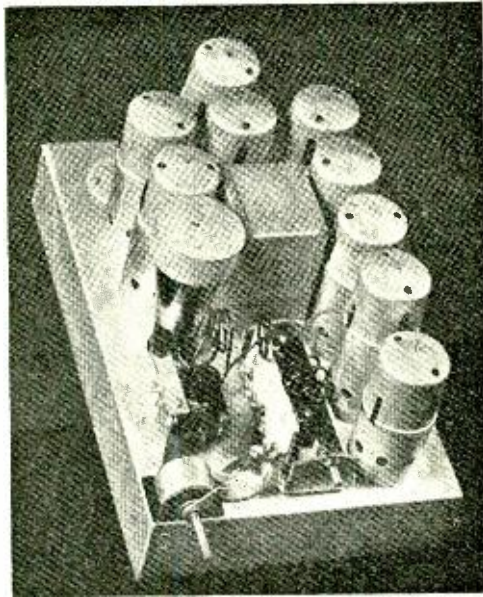

Fig. 15

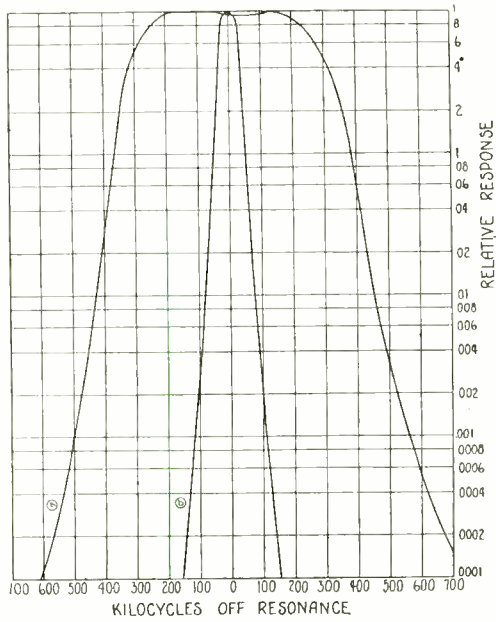

Fig. 16

rubber to prevent the vibrations from the loud speaker being transmitted to the receiver chassis. The plate, grid, and filament potentials for both receivers were supplied from the common socket power unit.

At the time the receivers were designed and built, a reliable attenuator for ultra-high frequencies was not available for use in measuring the absolute sensitivity of the receivers. Field tests of the receivers at various locations, however, indicated that the sensitivity of both the sound and picture receivers was sufficient to reach the normal noise or interference level. The over-all selectivity curves of the sound and picture receivers are shown in Fig. 16. Curve (a) is the selectivity characteristic of the picture receiver, and curve (b) the corresponding characteristic of the sound receiver. The over-all fidelity characteristics of the two receivers are substantially the same as the characteristics of their low-frequency amplifiers, as shown in Fig. 12. The fidelity of the picture receiver was such that the reproduced pictures were practically identical in detail with those obtained on the monitor unit at the transmitter.

#### OBSERVATIONS ON THE RECEPTION OF TELEVISION AND SOUND PROGRAMS

These experimental ultra-high-frequency picture and sound receivers were in use for some time, and a number of interesting observations were made.

The only evidence of static which was encountered during the field tests was an occasional click from the loud speaker at the time of a lightning flash in the vicinity. No evidence of multiple images or fading was found. The only fluctuations in the strength of the received signals which were noted were due to the motion of objects near the receiving antenna. An automatic volume control could compensate for these fluctuations satisfactorily if the minimum signal strength were sufficient to give the required signal-to-noise ratio. The chief source of man-made interference which was observed was the ignition systems of airplanes and automobiles. Tests which were made indicated that this type of interference can be greatly reduced by the use of resistors in the spark plug and distributor loads. At those locations where the field strength is weak and the receiver is located near a street on which there is considerable traffic, it may be desirable to erect the receiving antenna as far from the street as possible and connect it to the receiver through a shielded transmission line.



The psychological effect of interference in the picture and sound programs is very interesting. Prior to the tests it was felt that for a given interference the field strength necessary to give a satisfactory signal-to-noise ratio would be much greater for the picture signals than for the sound signals, because of the wider communication band required for the picture signals. The conclusion reached by a number of observers, however, indicate that the effect of interference, such as that due to the ignition systems of automobiles, on the picture programs was not as serious as expected on the basis of the above assumption. In several instances such interference produced a more objectionable effect on the sound program than it did on the picture program. Whenever the interference was of sufficient amplitude to destroy the picture synchronization, it likewise prevented the satisfactory reception of the sound program. The effect of interference of a temporary nature on the picture program could easily be avoided by glancing away from the picture. With the sound program, however, the only means of obtaining relief from such interference was either to turn off the set or turn down the volume control.

In the case of the usual sound broadcast program, the listener can obtain some measure of enjoyment while reading or engaged in some other diversion. To derive any degree of pleasure from a television program requires the entire attention of the observer.

# THE ICONOSCOPE—A MODERN VERSION OF THE ELECTRIC EYE

BY

V. K. ZWORYKIN

(RCA Victor Company, Inc., Camden, New Jersey)

*Summary*—This paper gives a preliminary outline of work with a device which is truly an electric eye, the iconoscope, as a means of viewing a scene for television transmission and similar applications. It required ten years to bring the original idea to its present state of perfection.

The iconoscope is a vacuum device with a photo-sensitive surface of a unique type. This photo-sensitive surface is scanned by a cathode ray beam which serves as a type of inertialess commutator. A new principle of operation permits very high output from the device.

The sensitivity of the iconoscope, at present, is approximately equal to that of photographic film operating at the speed of a motion picture camera. The resolution of the iconoscope is high, fully adequate for television.

The paper describes the theory of the device, its characteristics and mode of operation.

In its application to television the iconoscope replaces mechanical scanning equipment and several stages of amplification. The whole system is entirely electrical without a single mechanically moving part.

The reception of the image is accomplished by a kinescope or cathode ray receiving tube described in an earlier paper.

The tube opens wide possibilities for applications in many fields as an electric eye, which is sensitive not only to the visible spectrum but also to the infra-red and ultra-violet region.

THE idea of being able to observe far-away events is a fascinating one. A device which will enable a person to do so has been for centuries the dream of inventors and for decades the goal of earnest scientific workers.

The goal of television is to make this dream a reality. The problem, however, is a difficult one and requires for its solution a great many component elements, most of them unknown up to quite recent years.

The meaning of seeing over a great distance can be interpreted as sending instantaneously a picture through this distance. This requires means of communication extremely rapid and free from inertia. The discovery of electricity and the development of electrical communication, therefore, laid the foundations for the future realization of television.

The first step which enabled the conversion of the picture

Reprinted from Proceedings of Institute of Radio Engineers.

into electrical energy was taken by May in 1873 through the discovery of the photo-resistive property of selenium. Further advance came from Hertz fifteen years later by the discovery of the photo-electric effect. The succeeding years witnessed rapid progress in this line from the study of the effect by Hallwachs, Elster, Geitel, and others.

How eagerly the experimenters were taking advantage of these new tools placed at their disposal is illustrated by the fact that the first proposal of a solution of the television problem by means of the selenium cell was made by Carey in 1875, or only two years after its discovery. Carey proposed to imitate the human eye by a mosaic consisting of great numbers of minute selenium cells. The second attempt to construct a mosaic of this kind with a small number of elements was made by Ayrton and Perry in 1877. Later in 1906 Rignoux and Fournier actually used a mosaic of this type to transmit simple patterns and letters. Their transmitter consisted of a checkerboard of sixty-four selenium cells. Each cell was connected by two wires to a corresponding shutter in a similar checkerboard comprising a receiver. The picture was projected on selenium cells, creating in them electric currents which, in turn, operated the shutters. The light from behind the shutters reproduced the picture.

The idea of separating the picture into small elements, converting the illumination of each element into electrical current, and sending each through a separate wire is a good one, but leads to a very elaborate system. To transmit a picture of good quality, a great many pairs of separate wires would be required, which, of course, is impracticable. To simplify the problem, Nipkow in 1884 proposed, that instead of sending all the elements of the picture at once, to transmit the picture point by point, or to scan the picture. This proposal simplified the problem considerably, since it enabled the transmission of the picture over a single wire or over a single communication channel.

The means by which this simplification was achieved, was the scanning disk. The introduction of the scanning disc alone, however, did not bring the solution of the problem, due to the lack of some more essential elements. Almost forty years later, through the development of the thermionic amplifier for radio purposes and gas-discharge tubes, television became possible, and various inventors demonstrated television images transmitted by radio.

In the next few years progress was rapid and remarkable results were obtained, considering the difficulties encountered

during this period of development. Practically all the work was done with mechanical methods of scanning, using either Nipkow discs, polygonal mirrors, mirrored screws, etc. This involved purely mechanical complications in construction of sufficiently precise scanners, difficulties in increasing the number of picture elements and particularly in obtaining sufficient light. This last limitation actually introduced a stone wall which prevented the increase of the resolution of the transmitted picture to obtain the necessary quality and practically excluded all hope of transmitting an outdoor picture—the real goal of television.

In order fully to understand the reasons for this difficulty we should remember that the picture in all conventional systems of television is scanned point by point and therefore the photosensitive element is affected by the light from a given point only for a very short interval of time corresponding to the time of illumination of one picture element. Assume for a picture of good quality, we desire 70,000 picture elements. For twenty repetitions per second, this means that the time of transmission of one picture element is  $1/1,400,000$  of a second. On the other hand, the output of the photocell, which goes into the amplifier is proportional to the intensity of the light and time during which the light is acting on the photocell. A brief computation shows how microscopic will be the output of the photocell for this number of picture elements. If we take an average photographic camera with a lens F-4.5, the total light flux falling on the plate from a bright outdoor picture is of the order of  $1/10$ th of a lumen. Substituting a scanning disk for the plate suitable for 70,000 picture elements and placing a photocell of 10 microamperes per lumen sensitivity, we will have a photo current from a single picture element

$$I_e = \frac{1 \times 10^{-6}}{10 \times 70,000} = 1.43 \times 10^{-11} \text{ amperes.}$$

The charge resulting from this current in the time of one picture element is

$$Q = I_e \times t = \frac{1.43 \times 10^{-11}}{1.4 \times 10^6} = 1 \times 10^{-17} \text{ coulombs.}$$

Comparing that with a charge of one electron,  $e = 1.59 \times 10^{-19}$  coulombs, we see that only 63 electrons are collected during the scanning of one element. The amplification of such small amounts of energy involves practically insurmountable difficulties. If we

now compare this condition with that of a photographic plate during exposure, we shall see that the latter operates under much more favorable conditions since all its points are affected by the light during the whole time of exposure. This time for studio exposure is several seconds, and of the order of one hundredth of a second for outdoor exposures, or many thousand times greater than in the case of the scanned televised picture. The human eye, which we regard as an ideal of sensitivity, operates also under the same favorable condition.

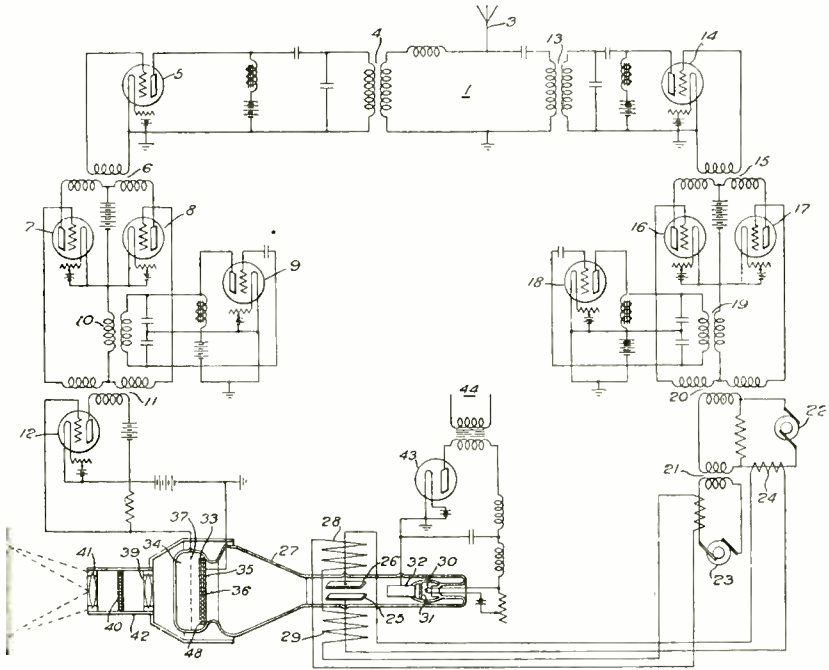

Fig. 1

If a television system could be devised which would operate on the same principle as the eye, all the points of the picture would affect the photosensitive element all the time. Then in our example of a picture with 70,000 elements the photo-electric output for each point would be 70,000 times greater than in the conventional system. Since scanning is still necessary in order to use only one communication channel, we should have some means for storing the energy of the picture between two successive scanings of each point.

The writer began to work on the realization of this idea years ago, and devised various solutions of the problem. One

of the solutions of this problem involved the use of a special cathode ray tube with a photosensitive mosaic structure applied on an insulated metallic plate, as shown in Fig. 1. This represents a picture from one of the patents already issued upon one form of the development.<sup>1</sup> Each element of the mosaic is a miniature photo-electric cell. The picture is projected on this mosaic, resulting in continuous emission of photo-electrons according to the distribution of light of the picture. The charge acquired by each element of the mosaic is released by the cathode ray beam once in each repetition of the picture. The resulting impulses were amplified and used to modulate the intensity of the cathode ray beam in the receiving tube, in which the picture was reproduced on a fluorescent screen.

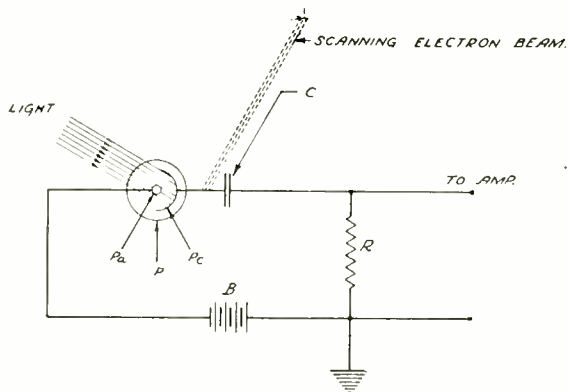

Fig. 2

Transmitting tubes of this type were actually built quite a few years ago and proved the soundness of the basic idea. During the succeeding years this development was carried on in the Research Laboratories of the Westinghouse Electric and Manufacturing Company in East Pittsburgh.

One of the first receptions of a picture with a cathode ray tube was achieved in 1929, using a mechanical galvanometer for transmitter.<sup>2</sup> This was reported at the Rochester meeting of the I.R.E. in November, 1929. The next year the work was moved to the laboratories of RCA Victor Co., in Camden, where development of the cathode ray receiving system was continued, the pick-up being obtained with a scanning disk. This has been described in a series of papers in the PROCEEDINGS of the I.R.E.

<sup>1</sup> U. S. Patent No. 1,691,324. Issued November 13, 1928. Filed July 13, 1925.

<sup>2</sup> V. K. Zworykin, *Radio Engineering*, December, (1929).

In the meantime, the development of the pick-up tube was pushed on and the results obtained from it soon surpassed the results of mechanical scanning and eventually completely replaced it. The tube itself is called the "iconoscope" from the Greek word "icon" meaning an image and "scope" signifying observation.

To understand fully the operation of the iconoscope, it is best to consider the circuit of a single photo-electric element in the mosaic, as shown in Fig. 2. Here  $P$  represents such an element and  $C$  its capacity to a plate common to all elements, which hereafter will be called the "signal plate." The complete electrical circuit can be traced starting from the cathode  $P_c$  to  $C$ , then to resistance  $R$ , source of electromotive force  $B$  and back to the

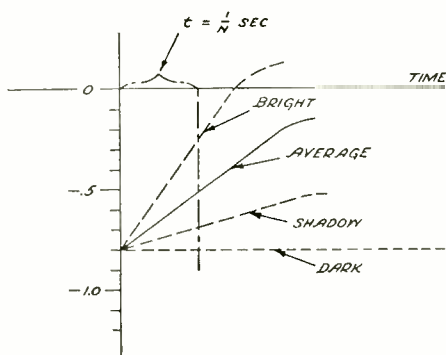

Fig. 3

anode  $P_a$ . When light from the projected picture falls on the mosaic each element  $P_c$  emits electrons, and thus the condenser element  $C$  is positively charged by the light. The magnitude of this charge is a function of the light intensity. When the electron beam which scans the mosaic strikes this particular element  $P_cC$  that element receives electrons from the beam and may be said to have become discharged.

This discharge current from each element will be proportional to the positive charge upon the element and, hence, the discharged current will be proportional to the light intensity at the particular element under question. The electrical circuit then transforms this discharge current into a voltage signal across the output resistor  $R$ .

If we plot the rise of charge of the element  $P_cC$  with respect to time, as shown on Fig. 3, the potential will continuously increase due to the light of the picture. The slope of this increase or  $dv/dt$

will depend only on the brightness of the particular point of the picture shining on this element. This linearity will be preserved until the saturation of the capacity  $C$ , which is so chosen as never to be reached at a given frequency  $N$  of repetition of the discharge. Since the scanning is constant, the interval of time,  $t$ , which is equal to  $1/N$  is also constant and therefore the value of charge depends only on the brightness of this particular point of the picture. With constant intensity of the scanning beam, the impulse through  $R$  and consequently the voltage drop  $V_I$

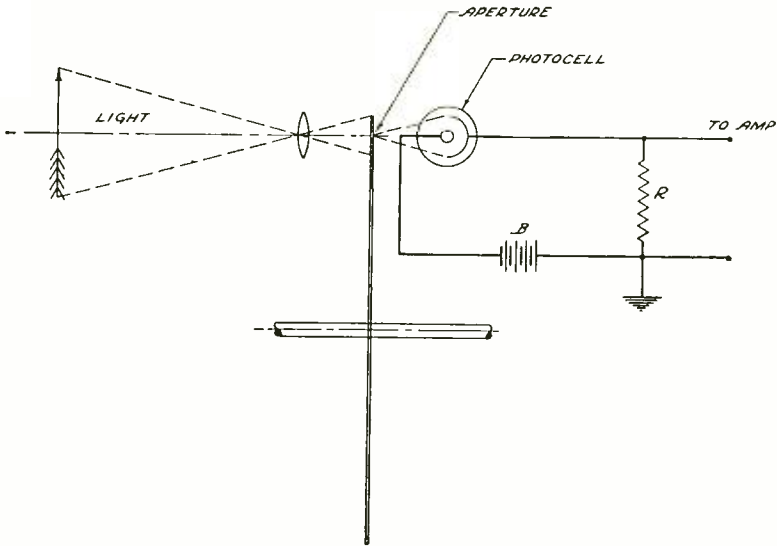

Fig. 4

across  $R$  is also proportional to the brightness of a given point of the picture. This potential  $V_I$  is the output of each single photo element of the iconoscope, and is applied to an amplifier.

The above explanation is actually somewhat complicated by the fact that this discharging beam not only neutralizes the positive charge of the photo-element, but charges it negatively. The equilibrium potential of the element is defined by the velocity of the beam and the secondary emission from the photo-emitting substance due to bombardment by the electrons of this velocity. This equilibrium condition in the dark, for a normal iconoscope, is of the order of 0.5 to 1.0 volt negative. The light causes the element to gain a positive charge, thus decreasing the normal negative charge, and the scanning beam brings it back again to the equilibrium potential.



Another complication is due to the existence, beside the discharge impulses, of a charging current of the entire mosaic due to light. This current is constant for the stationary picture and varies when the picture, or part of it, begins to move across the mosaic. This variation, however, is very slow and does not affect the amplifier which has a cutoff below 20 cycles.

In order to compare the magnitude of this output with that of the conventional television system, using a perforated disk, under identical conditions, we shall write down the value of the output for the iconoscope and for the usual mechanical method. A typical circuit for mechanical scanning is shown in Fig. 4.

The output of the photo-electric cell measured across the resistance,  $R$ , from the disc scanner is

$$V_d = R \times \frac{L}{n} \times S$$

$L$  = light flux corresponding to the total image,

$S$  = sensitivity of the photo element,

$n$  = number of picture elements,

$R$  = input resistance.

Considering the time necessary to build up the picture signal, we have to satisfy the condition that the time constant  $CR$  of the input circuit ( $C$  being the capacity of the photo element and associated circuits to ground) should be at least equal to or less than the time of scanning of a picture element,

$$\frac{1}{Nn} \text{ where } N = \text{number of picture frames per second.}$$

or,

$$CR = \frac{1}{Nn}$$

from which,

$$R = \frac{1}{NnC}$$

Introducing this in the expression of output of the photo-electric cell, we have

$$V_d = \frac{L}{n} \times S \times \frac{1}{NnC}$$

which shows that the output decreases as the square of the number of picture elements.

For the charge on one picture element of the iconoscope, we can write approximately

$$q = \frac{L}{n} \times S \times t$$

where  $t$  is the time during which the light shines on the element and which roughly equals

$$t = \frac{1}{N}.$$

The output voltage from the iconoscope will be

$$V_I = \frac{q}{C_I} \quad \text{where } C_I \text{ is the total input capacity of iconoscope and associated circuits to the ground.}$$

or,

$$V_I = \frac{L \times S}{n \times N \times C_I}$$

The ratio between outputs from the iconoscope and disk scanner will be

$$\eta = \frac{\frac{L \times S}{n \times N \times C_I}}{\frac{L \times S}{n^2 \times N \times C}} = n \frac{C_I}{C}$$

or for equal output capacity

$$\eta = n \text{ (the number of picture elements).}$$

If we take the previously given number of picture elements  $n = 70,000$ , the net theoretical gain of the mosaic system against the conventional system of television is equal to 70,000 times. It should be noted, however, that 100 per cent efficiency can hardly ever be attained for various reasons, but we have already achieved approximately 10 per cent efficiency which gives us a net gain of several thousand times. These several thousand times increase of picture signal output do not serve merely to decrease the necessary amplification. In the conventional television system, we have already pushed the amplification as far as it is possible from the point of view of permissible noise to picture signal ratio. This gain, therefore, is the only factor whereby real television can be achieved, if we understand by this term not only the transmission of a picture of limited definition under arti-

ficial conditions, but the actual transmission of a picture of high resolution under reasonable or natural conditions of illumination.

The scanning of an object with the flying spot is not considered in this computation, because it represents an entirely artificial condition and cannot be used for television pictures of distant objects.

The schematic diagram of a complete electrical circuit for the iconoscope is shown in Fig. 5. Here the two parts of the photo element  $P$ , shown on Fig 2, are entirely separated. The cathodes are in the shape of a photosensitive mosaic on the surface of the signal plate and isolated from it, the anode is common and consists of a silvered portion on the inside of the glass bulb.

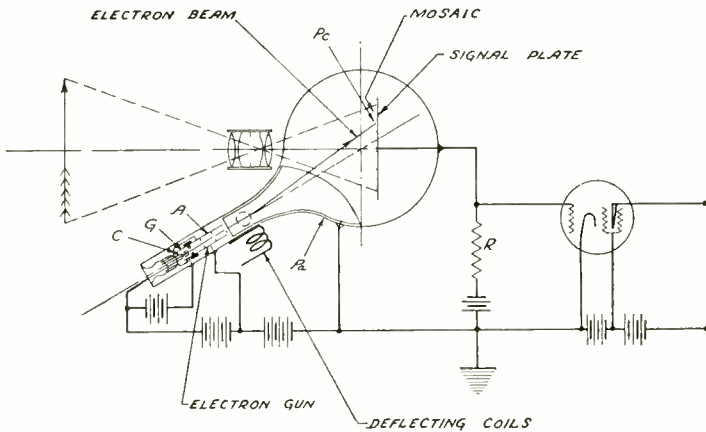

Fig. 5

The capacity  $C$  of each individual element with respect to the signal plate is determined by the thickness and dielectric constant of the insulating layer between the elements and the signal plate. The discharge of the positive charge of the individual elements is accomplished by an electron beam originating from the electron gun located opposite the mosaic and inclined at 30 degrees to the normal passing through the middle of the mosaic. Both mosaic and electron gun are enclosed in the same highly evacuated glass bulb. The inclined position of the gun is merely a compromise in the construction in order to allow the projection of the picture on the surface of the mosaic.

The resolution of the iconoscope is determined by both size and number of picture elements in the mosaic and size of the scanning electron beam. In practice, however, the number of individual photo elements in the mosaic is many times greater

than the number of picture elements, which is determined entirely by the size of the scanning spot. This is shown diagrammatically on Fig. 6. From the initial assumptions formulated in the analysis of the ideal circuit for individual elements, as shown on Fig. 2, we find the qualifications which should satisfy the mosaic for the iconoscope. These assumptions required that all the elements be of equal size and photosensitivity and equal capacity in respect to the signal plate. The fact that the exploring spot is much larger than the element modifies and simplifies this requirement so that the average distribution, surface sensitivity, and capacity of elements over an area of the mosaic corresponding to the size of the scanning spot should be uniform. This allows considerable tolerance in the dimensions of individual elements.

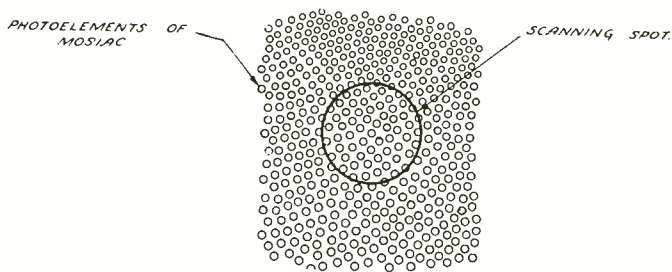

Fig. 6

The requirement of uniformity, which at first glance is quite difficult to accomplish, is solved by the help of natural phenomena. It is known that such a common material as mica can be selected in a thin sheet of practically ideal uniform thickness, and it therefore serves as a perfect insulating material for the mosaic. The signal plate is formed by a metallic coating on one side of the mica sheet. The mosaic itself can be produced by a multitude of methods, the simplest of which is a direct evaporation of the photo-electric metal on to the mica in a vacuum. When the evaporated film is very thin it is not continuous but consists of a conglomeration of minute spots or globules quite uniformly distributed and isolated each from the other. Another possible method is that of ruling the mosaic from a continuous metallic film by a ruling machine.

Although the initial method of formation of the photosensitive mosaic was the deposition of a thin film of alkali metal directly on an insulating plate, subsequent developments in the

photocell art resulted in changes in the method of formation of the mosaic.

The mosaic which is used at present is composed of a very large number of minute silver globules, each of which is photosensitized by caesium through utilization of a special process.

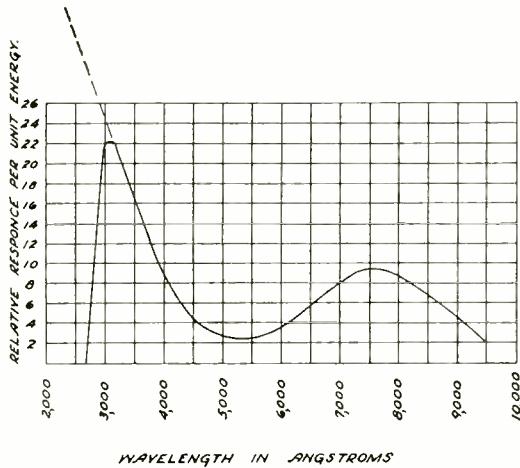

Fig. 7

Since the charges are very minute the insulating property and dielectric losses should be as small as possible. Mica of good quality satisfies this requirement admirably. However, other insulators can also be used and thin films made of vitreous enamels have proved to be entirely satisfactory. The insulation is made as thin as it can be made conveniently.

The sensitivity is of the same order as that of corresponding high vacuum caesium oxide photocells. The same is true also of the color response. The spectral characteristic is shown on Fig. 7. The cut-off in the blue part of the spectrum is due to the absorption of the glass. The actual color sensitivity of the photo elements themselves is shown as a dotted curve.

The electron gun producing the beam is quite an important factor in the performance of the iconoscope. Since the resolution is defined by the size of the spot, the gun should be designed to supply exactly the size of spot corresponding to the number of picture elements for which the iconoscope is designed. For the given example of 70,000 picture elements and a mosaic plate about 4 inches high, the distance between two successive lines is about 0.016 inch and the diameter of the cathode ray spot

approximately half of this size. This imposes quite a serious problem in gun design.

The electron gun used for this purpose is quite similar to the one used for the cathode ray tube for television reception or the kinescope, which has already been described in several papers.<sup>2</sup> The components of the gun are shown in Fig. 8. It consists of an indirectly heated cathode, *C*, with the emitting area located at

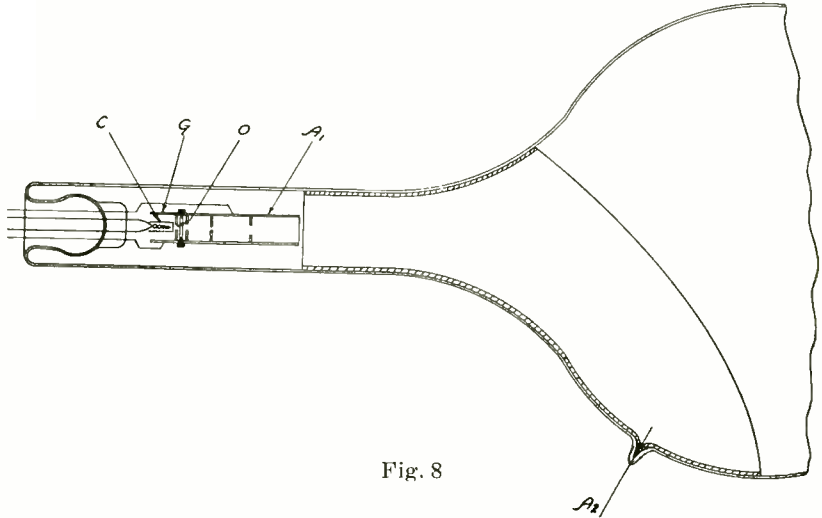

Fig. 8

the tip of the cathode sleeve. The cathode is mounted in front of the aperture *O* of the controlling element *G*. The anode *A*<sub>1</sub> consists of a long cylinder with three apertures aligned on the same axis with cathode and control element. The gun is mounted in the long narrow glass neck attached to the spherical bulb housing the mosaic screen. The inner surface of the neck as well as the part of the sphere is metallized and serves as the second anode for the gun and also as collector for photo electrons from the mosaic. The first anode usually operates at a fraction of the voltage applied to the second anode, which is approximately 1000 volts.

The focusing of the electron beam is accomplished by the electrostatic field between elements of the gun and between the gun itself and the second anode. The distribution of equipotential lines of the electrostatic field is shown on Fig. 9. The theory of electrostatic focusing for this type of gun has already been published by the writer.<sup>3</sup> Briefly summarized, it amounts to the fact that a properly shaped electrostatic field acts on moving

<sup>3</sup> V. K. Zworykin, *Jour. Frank. Inst.*, May, (1933).

electrons in the manner as a lens on a beam of light. The action of the field in the iconoscope gun is roughly equivalent to a com-

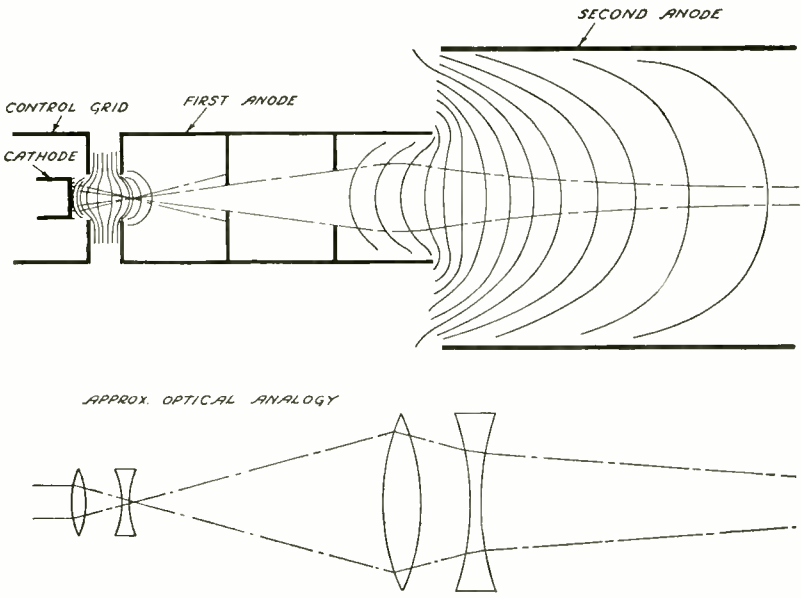

Fig. 9

posite lens consisting of four glasses, two positive and two negative. The optical analogy is shown on the same figure. The

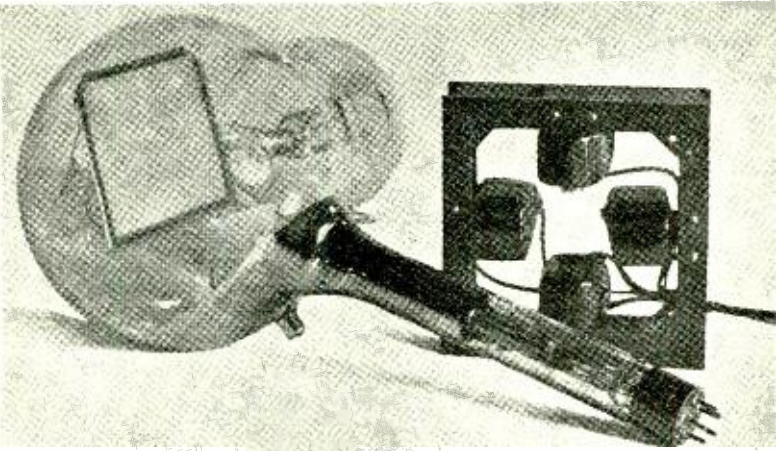

Fig. 10

actual appearance of the iconoscope is shown on Fig. 10. Its over-all length on this particular model is 18 inches and diameter of the sphere 8 inches.

The deflection of the electron beam for scanning the mosaic is accomplished by a magnetic field. The deflection coils are arranged in a yoke which slips over the neck of the iconoscope. The assembled deflecting unit is shown beside that of the tube. The scanning is linear in both vertical and horizontal directions

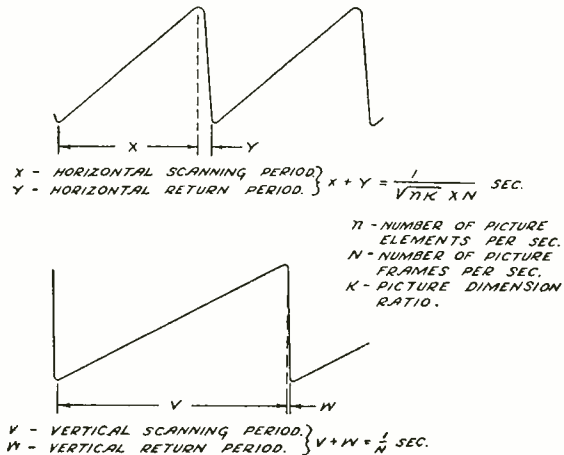

Fig. 11

and is caused by saw-tooth shaped electrical impulses passing through the deflecting coils and generated by special tube generators. The resultant path of the scanning cathode ray spot plotted with respect of time is shown on Fig. 11. The circuits for those generators as well as methods of synchronizing were given in a previous series of papers in the PROCEEDINGS.<sup>4</sup>

Since the iconoscope is practically a self-contained pick-up unit, it is possible to design a very compact camera containing the iconoscope and a pair of amplifier stages connected with the main amplifier and deflecting units by means of a long cable. Since the camera is portable, it can be taken to any point of interest for the transmission of a television picture. The photograph of such a unit is shown on Fig. 12.

The reception of images transmitted by the iconoscope is accomplished by means of the cathode ray receiving tube or kinescope. This tube was described in the writer's earlier papers.<sup>2,3</sup> The picture of the tube is shown in Fig. 13.

<sup>4</sup> Proc. I.R.E., vol. 21, pp. 1631-1706; December, 1933.



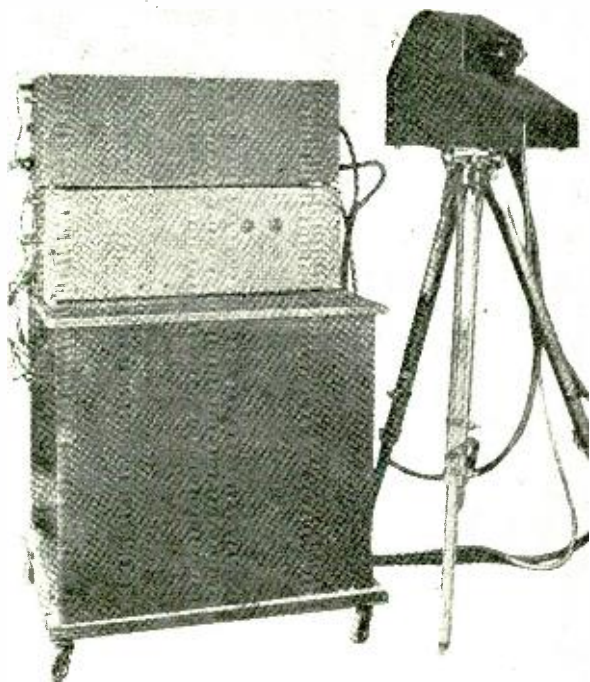

Fig. 12

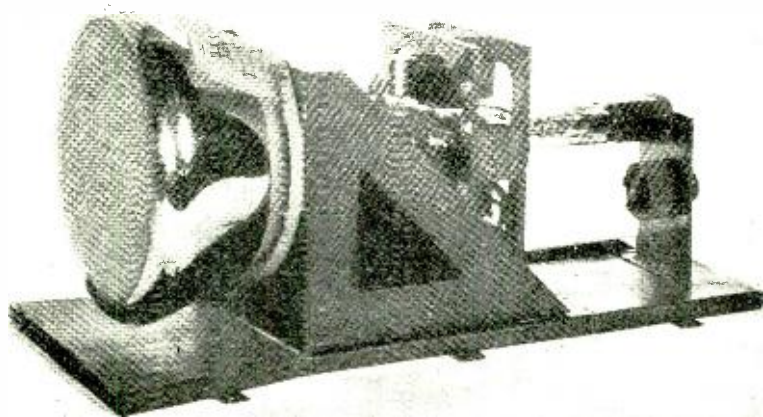

Fig. 13

The complete block diagram of the circuit associated with the transmitting and receiving ends of the whole system is shown on Fig. 14.

The main feature of this scheme, as seen from this diagram, is that in the whole system there are no mechanically moving parts and the transmission of the picture is accomplished entirely by electrical means.

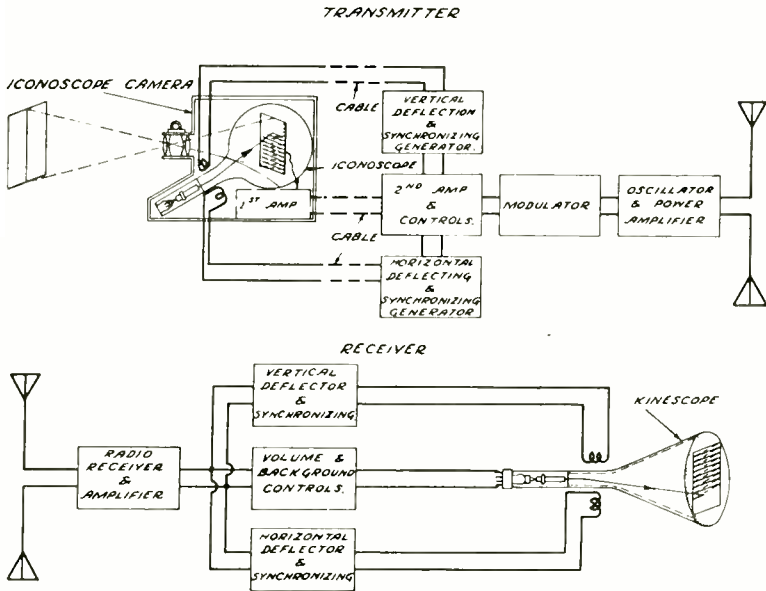

Fig. 14

From the color response curve shown on Fig. 7, it is clear that the iconoscope can be used not only for transmission of pictures in visual light but also pictures invisible to the eye in which the illumination is either by ultra-violet or infra-red light.

The present sensitivity of the iconoscope is approximately equal to that of a photographic film operating at the speed of a motion picture camera, with the same optical system. The inherent resolution of the device is higher than required for 70,000 picture element transmission. Some of the actually constructed tubes are good up to 500 lines with a good margin for future improvement.

With the advent of an instrument of these capabilities, new prospects are opened for high grade television transmission. In addition, wide possibilities appear in the application of such

tubes in many fields as a substitute for the human eye, or for the observation of phenomena at present completely hidden from the eye, as in the case of the ultra-violet microscope.

#### ACKNOWLEDGMENT

The writer wishes gratefully to acknowledge the untiring and conscientious assistance of Messrs. G. N. Ogloblinsky, S. F. Essig, H. Iams, and L. E. Flory, who carried on much of the theoretical and experimental work connected with the development which has been described in the foregoing, and whose ability was the major factor in the successful solution of the many problems arising in the course of this work.

# TELEVISION

By

DR. V. K. ZWORYKIN, E.E., PH.D.

Research Division, RCA Victor Company, Inc., Camden, N. J.

*Synopsis*—This paper gives an outline of a new television system developed in the laboratories of RCA Victor Company, in Camden, N. J.

The system is truly electrical and employs only electronic devices, without a single mechanically moving part.

The translation of the visual image is accomplished by means of a vacuum tube called the iconoscope. This tube is a virtual electric eye and consists of a photo-sensitive mosaic corresponding to the retina of the human eye, and a moving electron beam representing the nerve of the eye. The image is projected optically on the mosaic and transformed within the tube into a train of electrical impulses, representing the illumination of individual points of the image.

The reproduction of the image is accomplished by means of another vacuum tube, the kinescope, which transforms the electrical impulses back into the variation of light intensity through the bombardment of a fluorescent screen by the moving electron beam.

The movement of the electron beams in both tubes, which is responsible for both transformations, is linear and divides the picture into a series of parallel lines. The movements are synchronized so that the instantaneous position of the beams with respect to a point in the picture is always identical. The synchronization is transmitted together with the picture signals, and operation of the receiver is completely automatic.

The sensitivity of the iconoscope, at the present time, is approximately equal to that of a photographic film operating at the speed of a motion picture camera, permitting the transmission of outdoor scenes. The resolution is high, much higher than necessary for television images of the highest quality.

The paper describes the theory of the system, its characteristics, mode of operation, and includes photographs of images obtained on the fluorescent screen of the receiver.

## INTRODUCTION

“TELEVISION” has become a familiar word in recent times and conveys to us the idea of an artificial reproduction of transient visual images. Since it is artificial, we cannot expect to have an absolutely perfect reproduction of the original, and therefore, for better definition, the word “television” itself requires an additional adjective to identify the degree of perfection.

It is an accepted practice in reproducing pictures in printed matter, such as books and newspapers, to resolve the picture into

Reprinted from the Journal of the Franklin Institute.

a number of dots. The definition of the picture is then identified by the number of dots to a square inch. An ordinary picture may contain 4000 picture elements, or approximately 65 lines per linear inch, while for finer works a larger number is used. Similarly, in television, due to the requirement of transmission by one channel, the picture is dissected into a number of elements, which are transmitted in succession, one element after another in a series of parallel lines. It has, therefore, become quite common to refer to the reproduction in terms of lines. Thus we speak of 30, 60 or 120 line television, which means that the whole reproduced image is composed of 30, 60 or 120 lines, each line varying in density throughout its length.

The greater the detail is, the more difficult is the solution of the television problem; it is very important to determine accurately how far the compromise can be carried without affecting the quality of the reproduced image. In other words, what is the minimum number of lines in the television picture with which the reproduced image can be accepted as satisfactory?

A number of excellent works have already been published on the subject, both from the theoretical and experimental points of view.<sup>1</sup> The results of these works agree quite accurately, and predict that the increase in the number of lines at first gives a great increase in definition, then the rate of increase slows down and finally approaches a certain saturation value, after which a further increase in the number of lines gives a negligible increase in the definition of the image.

In order to give a better idea of this relation, Fig. 1<sup>2</sup> shows a comparison of four reproductions of the same picture made by 60, 120, 180 and 240 lines, respectively. These pictures are made not by television, but by special optical methods, and do not contain the distortions which are possible during various transformations involved in the process of television. Therefore, they should be regarded as an optimum for television reproduction. This set of pictures indicates that for an image with a great deal of detail, we should regard 240 lines as a minimum. For a picture with less detail, these requirements can be some-

<sup>1</sup> William H. Wenstrom, "Notes on Television Definition," *Proceedings I. R. E.*, September, 1933, Vol. 21, No. 9, p. 1317. Selig Hecht and Cornelis Verrijp, "The Influence of Intensity, Color and Retinal Location on the Fusion Frequency of Intermittent Illumination," *Proc. Nat. Academy of Science*, Vol. 19, No. 5, p. 522. E. W. Engstrom, *Proceedings of I. R. E.*, December, 1933.

<sup>2</sup> Courtesy of Mr. E. W. Engstrom.

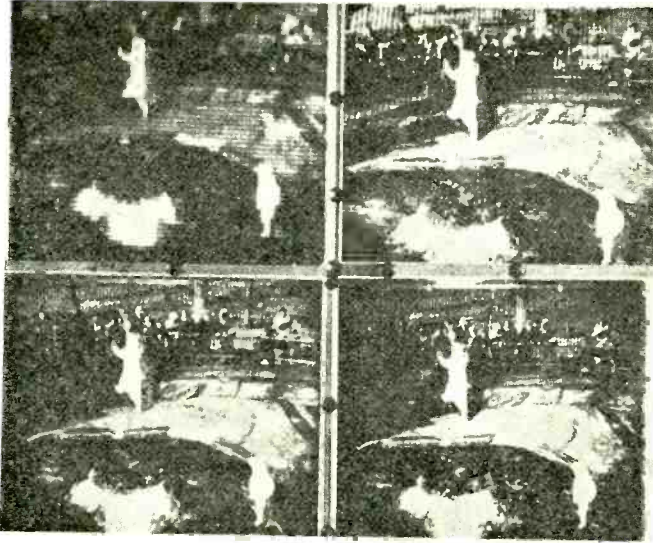

Fig. 1

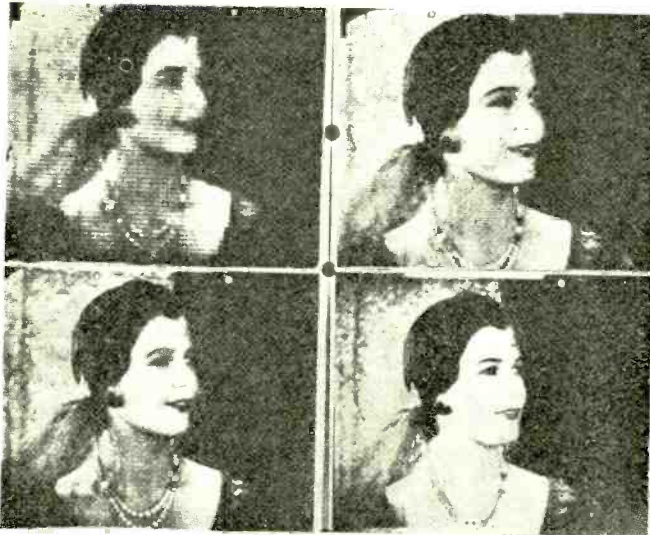

Fig. 2

what lower, as can be seen clearly from Fig. 2. Both these examples are given for half-tone reproduction. The black and white picture requires approximately the same number of lines for the corresponding definition, as shown on Fig. 3.

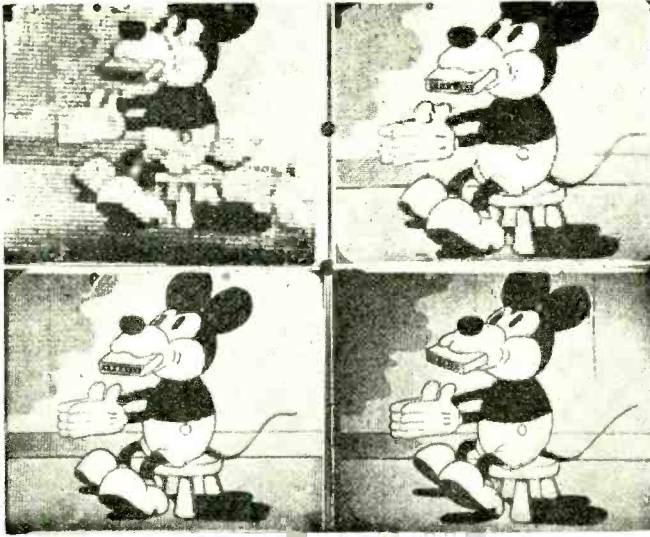

Fig. 3

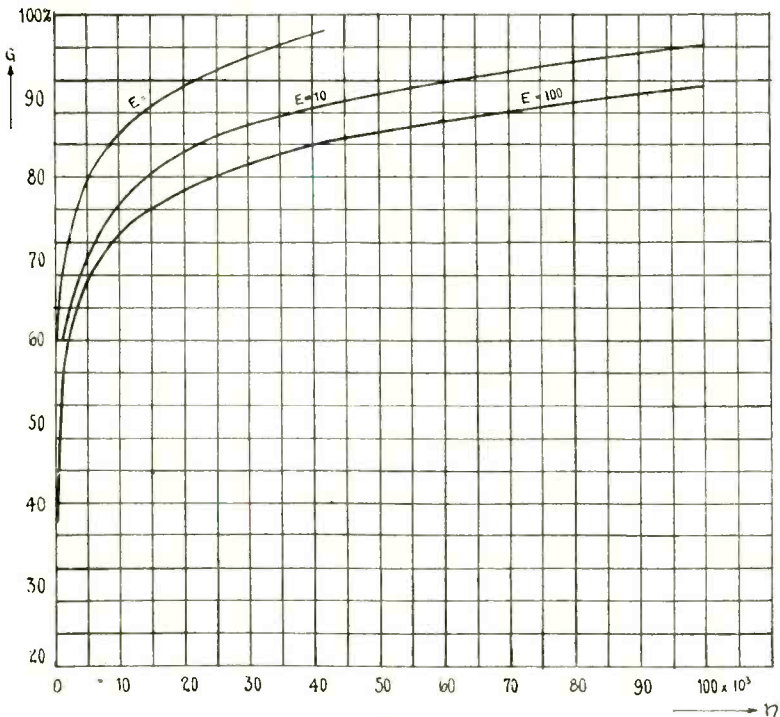

Fig. 4

This relation between the definition and the number of lines can also be shown by a curve, such as in Fig. 4.<sup>3</sup> This curve is obtained theoretically from the resolution of the human eye and is represented by the expression,

$$G = \rho \log n,$$

where  $G$  is the definition of the picture,

$n$ —the number of picture elements,

and  $\rho$ —coefficient depending on the size of the picture and the viewing angle.

The three curves are for three different intensities of the illumination of a picture of 1, 10 and 100 lumens. All these relations are considered for a still picture. Television pictures of moving objects give better resolution for a smaller number of lines, due to the fact that television, like moving pictures, repeats many pictures per second. Therefore, some of the details missing in one image may be reproduced in others and integrated by the eye, as one combines the picture with a greater number of details.

The practical difficulties in the development of a television system are proportional to the quantity of information to be transmitted and therefore increase with the increase in the number of picture elements. These difficulties are found not only in dissecting the image, but also in the amount of light required at the transmitter and receiver, in the construction of electrical circuits, and in the limitations of the electrical channels used for transmission.

The following table illustrates the relation between the number of lines, number of picture elements, and maximum picture frequency assuming the aspect ratio of the picture as 3 to 4 with 24 repetitions per second.

Scanning Lines.	Picture Elements.	Maximum Picture Frequency. <sup>4</sup>	Maximum Picture Communication Band.
60	4,798	63,970	127,900
120	19,200	256,000	512,000
180	43,190	576,000	1,152,000
240	76,780	1,024,000	2,048,000

<sup>3</sup> J. A. Ryftin, *J. Zeitschrift für Technische Physik*, Band III, Heft 2-3, 1933.

<sup>4</sup> 10 per cent. is added to compensate the loss of time for synchronizing signals.



The width of communication band for pictures with over 100 lines definition makes impossible the use of radio channels of frequencies utilized for sound broadcasting. The only solution for transmission of these pictures, therefore, lies in ultra-high frequencies. The communication, however, is a separate subject which will not be discussed in this paper. Also, it is not the intention of this presentation to give a history of television development. It is sufficient to say only that practically all the previous work was done with mechanical methods as a means of scanning or resolving the picture into picture elements for transmission. Likewise, mechanical methods were employed at the receiver to reconstruct the picture from the transmitted elements. This involved purely mechanical complications in construction of sufficiently precise scanners, and difficulties in increasing the number of picture elements and particularly in obtaining sufficient light. This last limitation actually introduced a stone wall which prevented the increase of resolution in the transmitted picture necessary to obtain the desired quality and practically excluded all hope of transmitting an outdoor picture—the real goal of television.

To understand the reasons for this difficulty, we should remember that the picture is scanned point by point, and, therefore, that the photo-sensitive element is affected by the light from a given point only for a very short interval of time corresponding to the time of illumination of one picture element. Assume for a picture of good quality we desire 240 lines, or 76,000 picture elements. For twenty-four repetitions per second, this means that the time of transmission of one picture element is  $1/1,824,000$  of a second. On the other hand, the output of the photocell to the amplifier is proportional to the intensity of the light and time during which the light is acting on the photocell. A brief computation shows how microscopic will be the output of the photocell for this number of picture elements. If we take an average photographic camera with a lens  $F-4.5$ , the total light flux falling on the plate from a bright outdoor picture is of the order of  $1/10$ th of a lumen. Substituting a scanning disc suitable for 76,000 picture elements for the plate and using a photocell of 10 micro-amperes/lumen sensitivity, we will have a photo current from a single picture element

$$I_e = \frac{I \times 10^{-5}}{10 \times 76,000} = 1.3 \times 10^{-11} \text{ amp.}$$

The charge resulting from this current in the time of one picture element is

$$Q = I \times t = \frac{1.3 \times 10^{-11}}{1.824 \times 10^6} = .7 \times 10^{-17} \text{ coulombs.}$$

Comparing that with the charge of one electron,

$$e = 1.59 \times 10^{-19} \text{ coulombs,}$$

we see that only 44 electrons are collected during the scanning of one element. The amplification of such small amounts of energy involves practically insurmountable difficulties.

If we now compare this condition with that of a photographic plate during exposure, we will see that the latter operates under much more favorable conditions, since all its points are affected by the light during the whole time of exposure. This time for studio exposure is several seconds, and of the order of one hundredth of a second for outdoor exposures, or many thousand times greater than in the case of an element in the scanned television picture. The human eye, which we regard as an ideal of sensitivity, operates also under the same favorable condition.

If a television system could be devised which would operate on the same principle as the eye, all the points of the picture would affect the photo-sensitive element all the time. Then in our example of a picture with 76,000 elements, the photo-electric output for each point would be 76,000 times greater than in the conventional system. Since scanning is still necessary in order to use only one communication channel, we should have some means for storing of the energy of the picture between two successive scanings of each point.

The light requirement and necessity of avoiding the mechanically moving parts resulted in the development of an entirely electrical television system, employing special electronic devices for both transmission and reception.

### ICONOSCOPE

On the transmitting end this device took the form of a virtual artificial electric eye. The device was named iconoscope, the name being derived from two Greek words signifying "image observer." The photograph of this device is shown on Fig. 5.

It consists of two principal parts enclosed in an evacuated glass bulb. The first part is the photo-sensitive mosaic, consisting of a metal plate covered with a great number of miniature

photo-electric cells, insulated from the plate and each from the other. The function of the mosaic is similar to that of the retina of the eye. It transforms the energy of the light from the image into electrical charges and stores them until they can be transformed point by point into electrical impulses and transmitted. This transformation is accomplished by an electron beam scanner, the nerve of this electric eye.

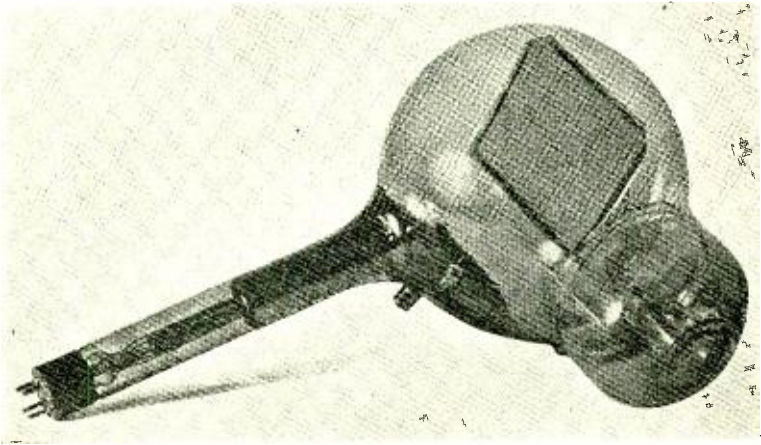

Fig. 5

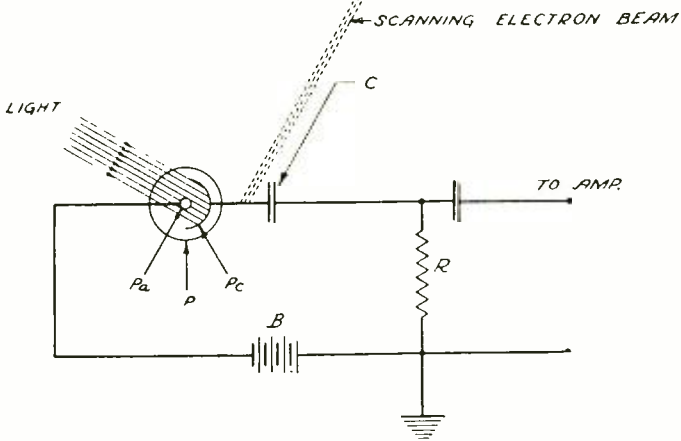

Fig. 6

To complete the analogy of the iconoscope with the human eye, we shall mention that it possesses an electrical memory, because with a good dielectric the charges of the mosaic can be preserved for a considerable length of time.

To fully understand the operation of the photo-sensitive mosaic of the iconoscope, it is best to consider the circuit of a single photo-electric element in the mosaic, as shown in Fig. 6. Here  $P$  represents such an element, and  $C$  its capacity to a plate common to all the elements, which hereafter will be called the "signal plate." The complete electrical circuit can be traced starting from the cathode  $P_c$  to  $C$ , then to resistance  $R$ , source of e.m.f.  $B$ , and back to the anode  $P_a$ . When light from the projected picture falls on the mosaic, each element  $P_c$  emits electrons, and thus the condenser element  $C$  is positively charged by the light. The magnitude of this charge is a function of the light intensity. When the electron beam which scans the mosaic strikes the particular element  $P_cC$  that element receives electrons from the beam and may be said to have become discharged. This discharge current from each element will be proportional to the positive charge upon the element.

If we plot the rise of charge of the element  $P_cC$  with respect to time, as shown on Fig. 7, the potential will continuously increase due to the light of the picture. The slope of this increase or  $dv/dt$  will depend only on the brightness of the particular

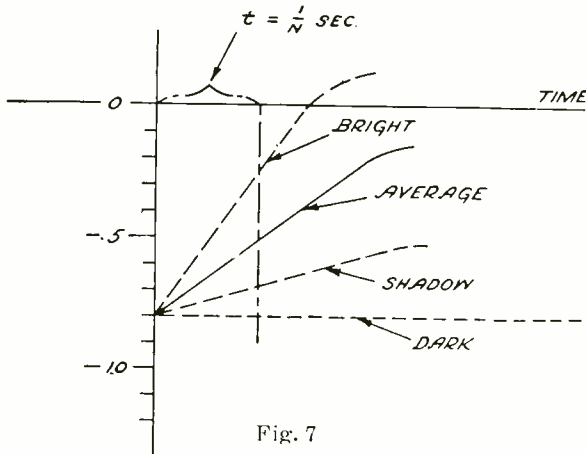

Fig. 7

part of the picture focused on this element. This linearity will be preserved until the saturation of the capacity  $C$ , which is so chosen as never to be reached at a given frequency  $N$  of repetition of the discharge. Since the scanning is constant, the interval of time,  $t$ , which is equal to  $1/N$ , is also constant and therefore the value of charge depends only on the brightness of this particular point of the picture. With constant intensity of the scan-

ning beam, the impulse through  $R$ , and consequently the voltage drop  $V_1$  across  $R$ , is also proportional to the brightness of a given point of the picture. This potential  $V_1$  is the output of each single photo-element of the iconoscope, which is applied to an amplifier.

The above explanation is actually somewhat complicated by the fact that this discharging beam not only neutralizes the positive charge of the photo-element, but charges it negatively. The equilibrium potential of the element is defined by the velocity of the beam and the secondary emission from the photo-emitting substance due to bombardment by the electrons of this velocity. This equilibrium condition in the dark, for a normal iconoscope, is of the order of .5 to 1.0 volts negative. The light causes the element to gain a positive charge, thus decreasing the normal negative charge, and the scanning beam brings it back again to the equilibrium potential.

Another complication is due to the existence, besides the discharge impulses from the individual elements, of a charging current due to light on the whole mosaic. This current is constant for a stationary picture but varies when the picture, or part of it, begins to move across the mosaic. This variation, however, is very slow and does not affect an amplifier which has a cut-off below 24 cycles.

Fig. 8 gives an idea of conditions on the surface of the mosaic. Here the shaded picture represents the electrical charges accumulated by the individual elements of the mosaic due to the light of the projected image. Although the background of this image is of uniform density, the corresponding charges at a given instant are not uniform but vary, as shown on the left part of this picture. The highest charge occurs just before the exploring beam has discharged the elements. After the beam has passed the charge is momentarily near its equilibrium condition and begins to increase throughout the whole scanning period, attaining its maximum value again just before the scanning by the beam.

The electron beam, in neutralizing the charge of a particular point of the picture, releases practically instantaneously the energy stored there during the whole  $1/24$ th of the second. The electrical impulse created on the opposite side of the mosaic energizes the amplifier. The magnitude of this impulse is greater than the corresponding impulse, produced by a system not utilizing the storing effect, in ratio of time intervals during which

the light from the picture point acts on the photo-sensitive element. In this case, it is equal to the number of picture elements,

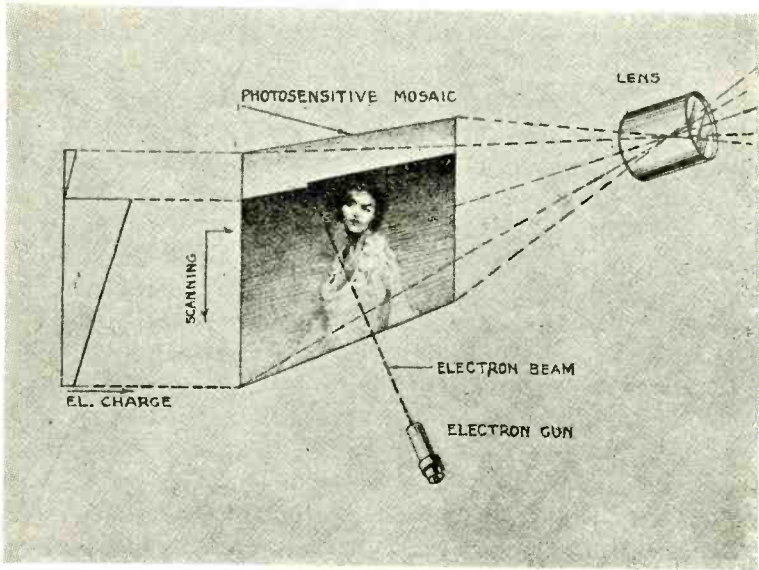

Fig. 8

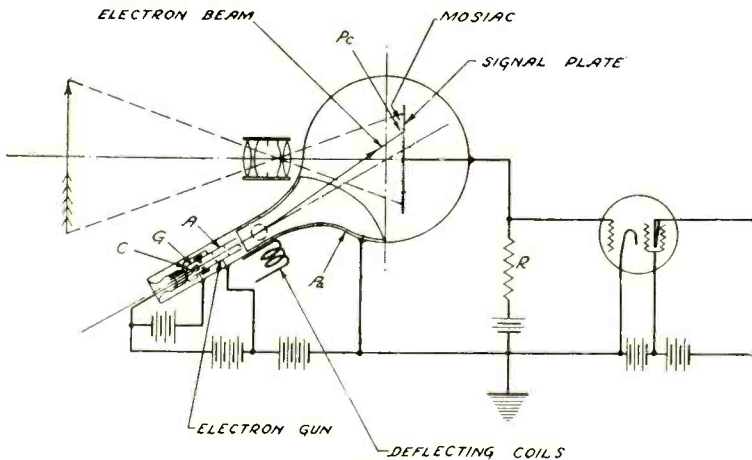

Fig. 9

or 76,000 times as great. This is true, assuming that the device has 100 per cent. efficiency. This, however, is a practical impossibility due to various losses, and at the present we have to satisfy ourselves with only about 10 per cent. of the possible gain.

The schematic diagram of a complete electrical circuit for the iconoscope is shown in Fig. 9. Here the two parts of the photo-element  $P$ , shown on Fig. 6, are entirely separated. The cathodes are in the shape of photo-sensitive globules on the surface of the signal plate and insulated from it. The anode or collector is common and consists of a silvered portion on the inside of the glass bulb.

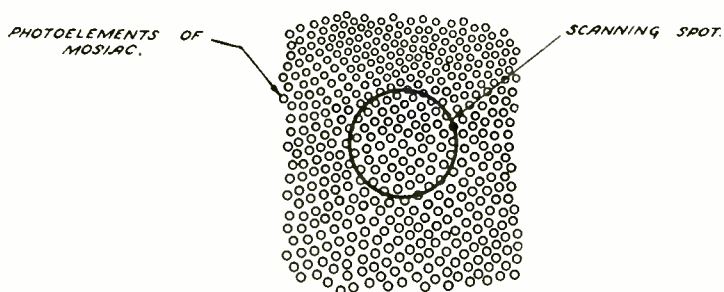

Fig. 10

The capacity  $C$  of each individual element with respect to the signal plate is determined by the thickness and dielectric constant of the insulating layer between the elements and the signal plate. The discharge of the positive charge of the individual elements is accomplished by an electron beam originating in the electron gun located opposite the mosaic and inclined at  $30^\circ$  to the normal passing through the middle of the mosaic. Both mosaic and electron gun are enclosed in the same highly evacuated glass bulb. The inclined position of the gun is merely a compromise in the construction in order to allow the projection of the picture on the surface of the mosaic.

The resolution of the iconoscope is determined by both the size and number of picture elements in the mosaic, and the size of the scanning electron beam. In practice, however, the number of individual photo-elements in the mosaic is many times greater than the number of picture elements, which is determined entirely by the size of the scanning spot. This is shown diagrammatically on Fig. 10. From the initial assumptions formulated in the analysis of the ideal circuit for individual elements, as shown on Fig. 6, we find the qualifications which should satisfy the mosaic for the iconoscope. These assumptions required that all the elements be of equal size and photo-sensitivity and equal capacity in respect to the signal plate. The fact that the exploring spot is much larger than the element modifies and simplifies

this requirement so that the average distribution, surface sensitivity and capacity of elements over an area of the mosaic corresponding to the size of the scanning spot should be uniform. This allows considerable tolerance in the dimensions of individual elements.

The requirement of uniformity, which at first glance appears quite difficult to obtain, is solved by the help of natural phenomena. It is known that such a common material as mica can be selected in a thin sheet of practically ideal uniform thickness and it therefore serves as a perfect insulating material for the mosaic. The signal plate is formed by a metallic coating on one side of the mica sheet. The mosaic itself can be produced by a multitude of methods, the simplest of which is a direct evaporation of the photo-electric metal onto the mica in a vacuum. When the evaporated film is very thin it is not continuous, but consists of a conglomeration of minute spots or globules quite uniformly distributed and insulated each from the other. Another possible method is that of ruling the mosaic from a continuous metallic film by a ruling machine.

Although the initial method of formation of the photo-sensitive mosaic was the deposition of a thin film of alkali metal directly on an insulating plate, subsequent developments in the photocell art resulted in changes in the methods of formation of the mosaic. The mosaic which is used at present is composed of a very large number of minute silver globules, each of which is photo-sensitized by caesium through utilization of a special process.

Since the charges are very minute the insulating property and dielectric losses should be as small as possible. Mica of good quality satisfies this requirement admirably. However, other insulators can also be used and thin films made of vitreous enamels have proven to be entirely satisfactory. The insulation is made as thin as it can be conveniently.

The sensitivity of the mosaic is of the same order as that of corresponding high vacuum caesium oxide photocells. The same is true also of the color response. The spectral characteristic is shown on Fig. 11. The cut-off in the blue part of the spectrum is due to the absorption of the glass. The actual color sensitivity of the photo-elements themselves is shown as a dotted curve.

The electron gun producing the beam is quite an important factor in the performance of the iconoscope. Since the resolution is defined by the size of the spot, the gun should be designed to



supply exactly the size of spot corresponding to the number of picture elements for which the iconoscope is designed. For the given example of 76,000 picture elements and a mosaic plate about 4" high, the distance between two successive lines is about

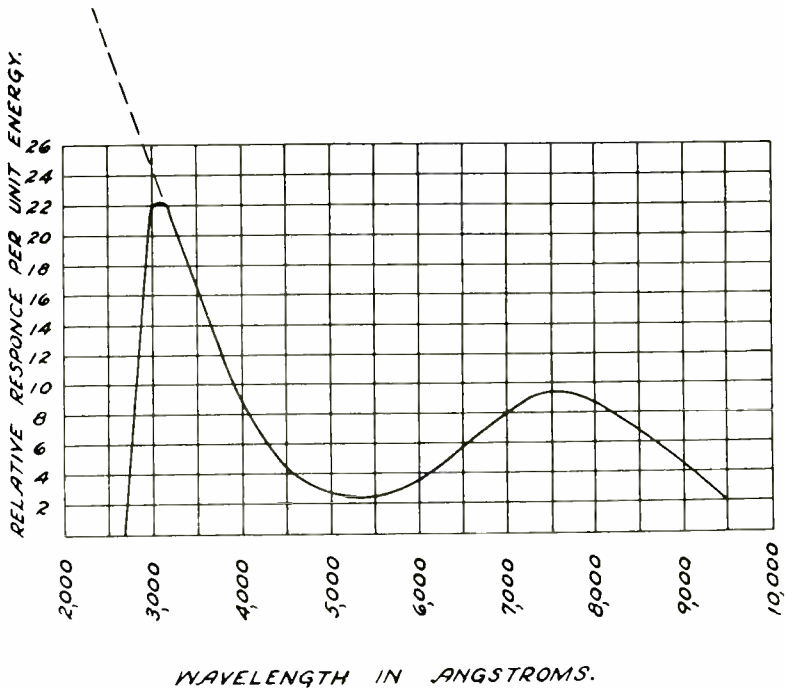

Fig. 11

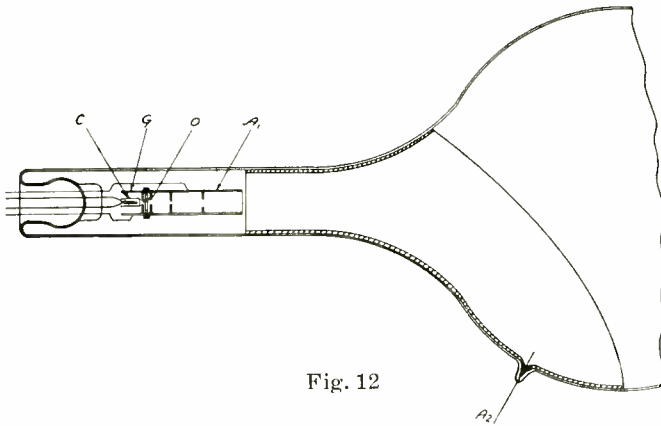

Fig. 12

.016" and the diameter of the cathode ray spot approximately half of this size. This imposes quite a serious problem in gun design.

The electron gun used for this purpose is quite similar to the one used for the cathode ray tube for television reception, or the kinescope, which has already been described in several papers.<sup>5</sup> The components of the gun are shown in Fig. 12. It consists of an indirectly heated cathode, *C*, with the emitting area located at the top of the cathode sleeve. The cathode is mounted in front of the aperture *O* of the controlling element, *G*. The anode *A*<sub>1</sub> consists of a long cylinder with three apertures aligned on the same axis with cathode and control element. The gun is mounted in the long narrow glass neck attached to the spherical bulb housing the mosaic screen. The inner surface of the neck as well as the part of the sphere is metallized and serves as the second anode for the gun and also as collector for photoelectrons from the mosaic. The first anode usually operates at a fraction of the voltage applied to the second anode, which is approximately 1000 volts.

The focusing is accomplished by an electrostatic field set up by potential differences applied between parts of the electron gun, and between the gun itself and the metallized portion of the neck of the iconoscope.

If an electron enters the field along the lines of force, its velocity, but not the direction of motion, will be affected. If an electron enters the field with velocity, *V*, at an angle  $\alpha$ , as shown on Fig. 13, both the velocity and the direction will be affected, as shown by the vector diagram. In case the field is accelerating, the direction of motion of the electron will be bent toward the axis of symmetry of the field, and if the field is decelerating, the electron will be deflected in the opposite direction. Thus a stream of electrons can be made to converge or diverge.

This interaction between the electrons and electrostatic field can be used to form a sort of lens, as shown on Fig. 14. The lens in this case is converging, but it can be changed to a diverging one simply by reversing the potentials.

The same effect can be accomplished by a field produced by a difference in potential of two cylindrical electrodes or between two diaphragms. The lines of force in both cases will force the electrons of a beam, moving inside of these electrodes, toward the axis, overcoming the natural tendency of electrons to repel each other. This action is analogous to the focusing of light rays by means of optical lenses. The electrostatic lenses, however, have a peculiarity in that their index of refraction for electrons

<sup>5</sup> V. K. Zworykin, *Jour. Radio Engineering*, December, 1929.

is not confined to the boundary between the optical media, as in optics, but varies throughout all the length of the electrostatic field. By proper arrangement of electrodes and potentials, it is always possible to produce a complex electrostatic lens which will be equivalent to either positive or negative optical lenses.

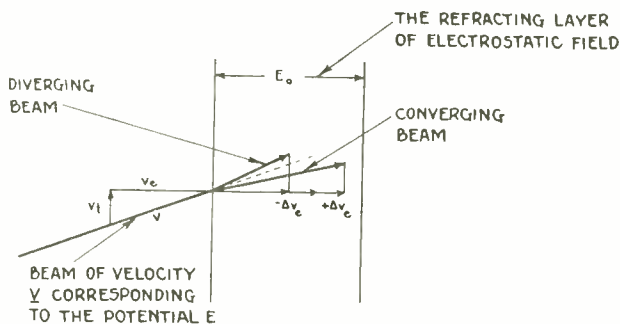

Fig. 13

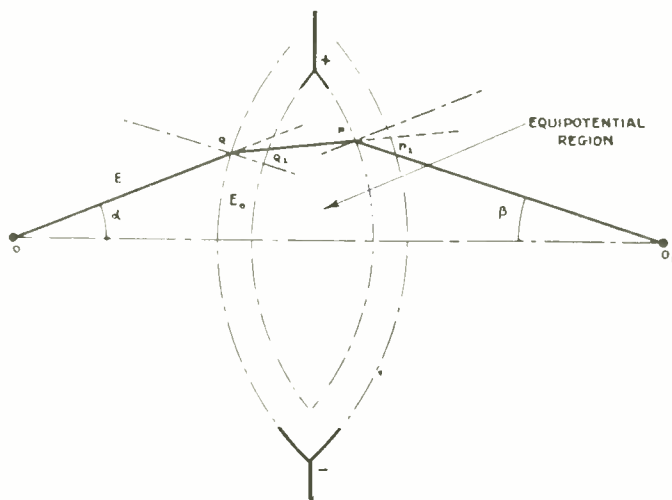

Fig. 14

The distribution of electrostatic fields in the electron gun is shown on Fig. 15. In this particular case, the total action of fields on electrons is approximately equivalent to a combination of two non-symmetrical lenses, as is shown in the same figure.

The first lens forces the electrons through the aperture of the first anode and assure the desired control of the beam by the control element,  $G$ . The final focusing of the beam on the mosaic is accomplished by the second lens created by the field

between the end of the gun and the neck of the bulb. Thus, the final size of the spot on the mosaic, as in its optical analogue, depends chiefly on the size of the active area of the cathode and the optical distances between the cathode, lenses and the mosaic.

The deflection of the electron beam for scanning the mosaic is accomplished by a magnetic field. The deflection coils are arranged in a yoke which slips over the neck of the iconoscope.

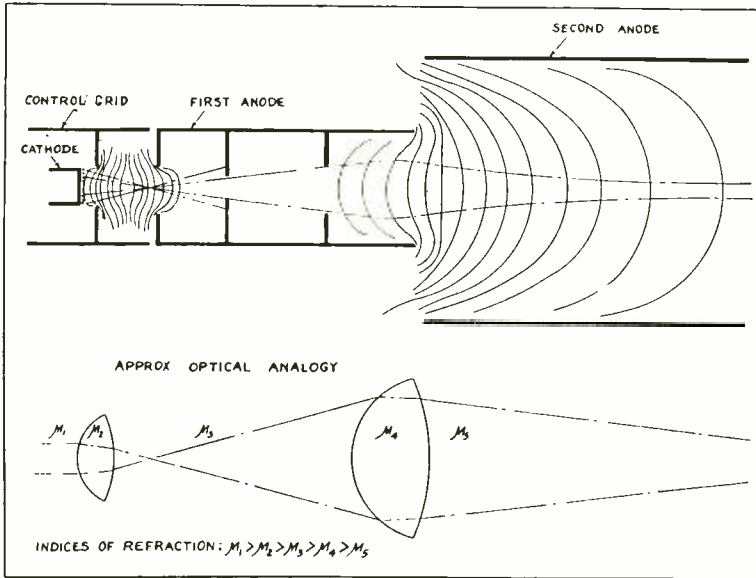

Fig. 15

The scanning is linear in both vertical and horizontal directions and is caused by saw-tooth shaped electrical impulses passing through the deflecting coils and generated by special tube generators.

From the color response curve shown on Fig. 11, it is clear that the iconoscope can be used not only for transmission of pictures in visible light but also for pictures invisible to the eye, in which the illumination is either by ultra-violet or infra-red light.

The present sensitivity of the iconoscope is approximately equal to that of a photographic film operating at the speed of a motion picture camera, with the same optical system. The inherent resolution of the device is higher than required for 76,000 picture element transmission. Some of the actually constructed

tubes are good up to 500 lines with a good margin for future improvement.

Since the iconoscope is practically a self-contained pickup unit, it is possible to design a very compact camera containing the iconoscope and a pair of amplifier stages connected with



Fig. 16

the main amplifier and deflecting units by means of a long cable. Since the camera is portable, it can be taken to any point of interest for the transmission of a television picture. The photograph of such a camera is shown on Fig. 16.

The complete block diagram of the circuit associated with the transmitting and receiving ends of the whole system is shown on Fig. 17, where the components and their location in the system are indicated. Naming the units in order, we have for television from the studio: The iconoscope camera, the picture signal and synchronizing signal amplifiers, the control and switching equipment, the modulating and radio transmitter equipment. The units comprising the television receiver are: A radio receiver, the cathode ray unit or kinescope, and its associated horizontal and vertical deflecting equipment.

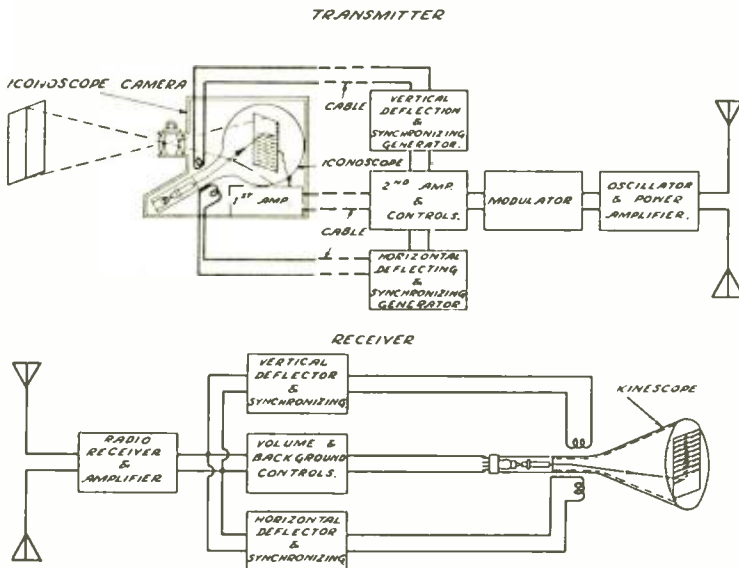

Fig. 17

The name "kinescope" has been applied to the cathode ray tube used in the television receiver to distinguish it from ordinary cathode ray oscilloscopes because it has several important points of difference: for instance, an added element to control the intensity of the beam. Figure 18 gives the general appearance of the tube which has a diameter of 9", permitting a reproduced image of approximately  $5\frac{1}{2}'' \times 6\frac{1}{2}''$ . The electron gun is quite similar to the one used for the iconoscope, except that it operates at a higher potential for the second anode.

As in the latter, the gun is situated in the long, narrow neck attached to the large cone-shaped end of the kinescope, the inner surface of the cone being silvered or otherwise metallized to

serve as the second anode. The purpose of the second anode,  $A_2$ , is to accelerate the electrons emerging from the electron gun and to form the electrostatic field to focus them into a very small, threadlike beam.

After leaving the first anode, the focused, accelerated beam impinges upon the fluorescent screen deposited upon the flat end of the conical portion of the kinescope. The fluorescent screen serves as a transducer, absorbing electrical energy and emitting light. Thus there is produced a small bright spot on the screen, approximately equal in area to the cross-section of

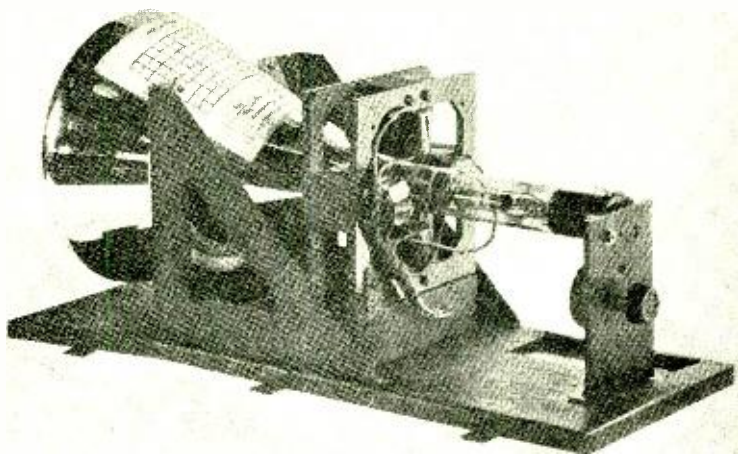

Fig. 18

the beam. The fluorescent screen is very thin, so a large portion of the emitted light is transmitted outside of the tube as useful illumination.

In order to reproduce the light intensity variations of the original picture, it is necessary to vary the intensity of the spot of light upon the fluorescent screen. This is accomplished by means of the control element,  $G$ , of the electron gun. For satisfactory reproduction, the control of the electron beam intensity should be a linear function of the input signal voltage. Furthermore, it is very essential that during the exercising of this control the sharp focusing of the spot shall not be destroyed. Still another requirement is that this control will not affect the velocity of the electron beam because the deflection of the beam

is inversely proportional to its velocity and, therefore, a slight change due to picture modulation would disturb the image, making the bright lines shorter and the darker lines longer. As a result of careful design, the variation of velocity of the beam (from complete cut-off to full brilliancy) in the kinescope is so small as to be unnoticeable to the observer of the picture.

The characteristic curve of the kinescope is shown in Fig. 19. From this it will be seen that an input of 10 volts A.C. will give practically complete modulation (i.e., a change from maximum to minimum brilliancy) of the cathode ray beam. The shape of

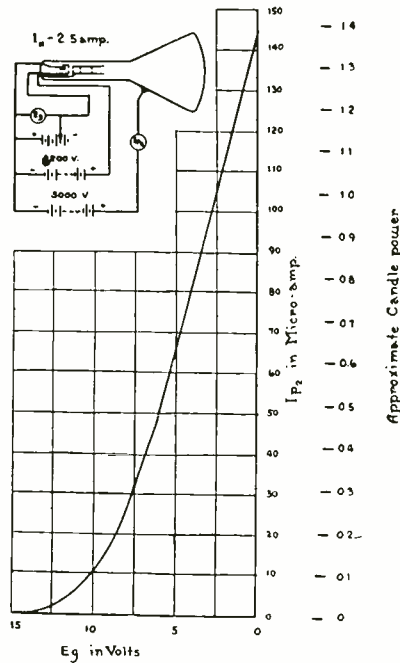

Fig. 19

this curve gives the proportionality between input voltage and second anode current and corresponding brightness of the spot. (It is to be noted that the values of current, voltage, illumination, etc., given on Fig. 19, and all figures in this report, are illustrative rather than specific values for a particular type of cathode ray kinescope tube.) By referring to Fig. 20, which shows a graph of the relation of second anode current to the light emitted from the fluorescent screen, it will be noticed that a lin-



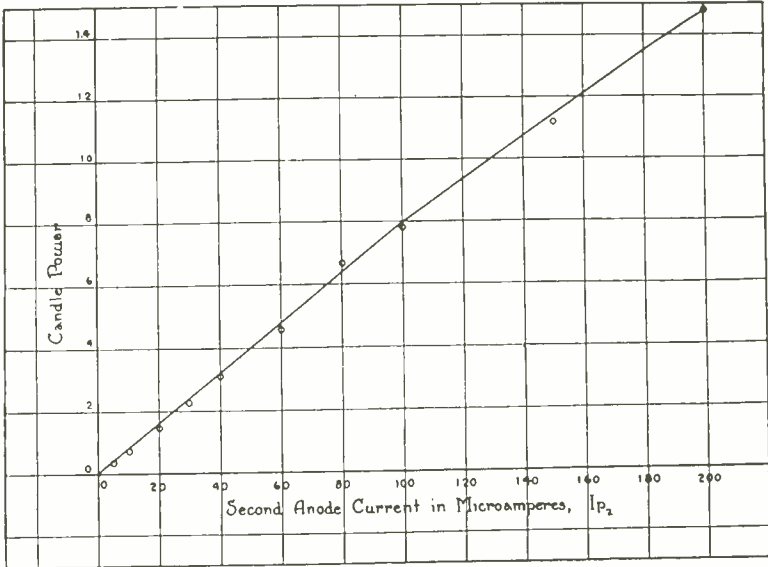

Fig. 20

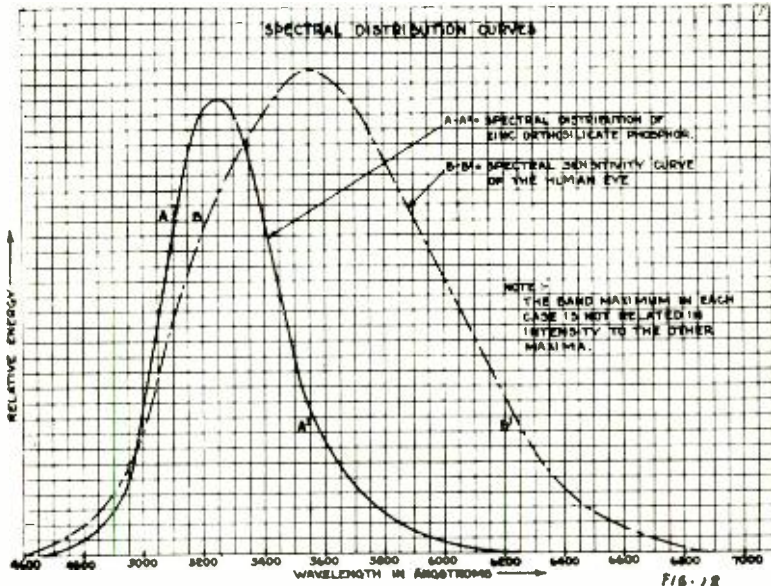

Fig. 21

ear proportionally exists. Therefore, we can draw the conclusion that a television picture, varying in shade from black to white, will have accurately reproduced all the intermediate shadings necessary for good half-tone pictures.

The material used for the fluorescent screen is a synthetic zinc ortho-silicate phosphor almost identical with natural Willemite. Zinc ortho-silicate was chosen because of its luminous efficiency, its short time lag, its comparative stability and its resistance to "burning" by the electron beam. The good luminous efficiency is due to the fact that the light, green in color, emitted by the zinc ortho-silicate lies in the visible spectrum in a narrow band peaked at 5230A, close to the wavelength of maximum sensitivity of the eye (5560A), as shown in Fig. 21.

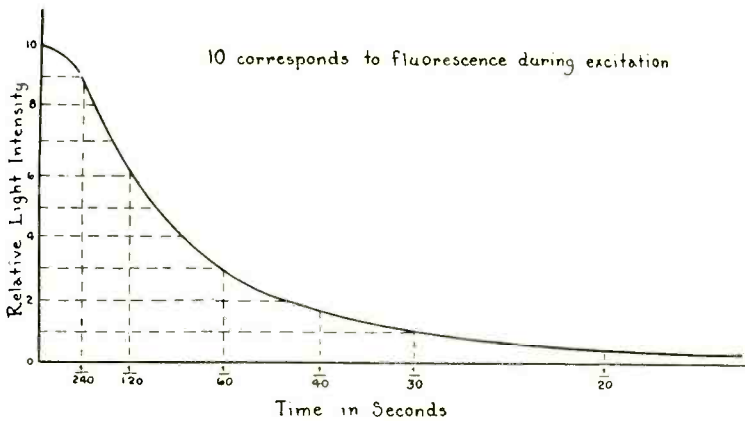

Fig. 22

Fig. 22 shows the time decay curve of the zinc-ortho-silicate luminescence. The decay curve shows that at the end of approximately 0.06 second practically all visible luminescence has ceased. For reproducing 24 pictures per second, the decay curve of the ideal phosphor should be long enough so that the phosphor just loses its effective brilliancy at the end of 1/24th of a second. If the time of decay is too long, the moving portions of the picture will "trail," as, for instance, the path of a moving baseball would be marked by a comet-like tail. If the time of decay is too short, flicker is noticeable because of the space of comparative total darkness between the times when the fluorescent material is excited between successive pictures.

## SCANNING

The requirement of transmitting the picture impulses through a single channel introduces the necessity of scanning; that is, exploring the picture area, element by element, in some logical order in an interval of time so brief as not to be detectable by the human eye due to its persistence of vision.

One of the simplest methods of scanning a picture is to cause a spot of light to sweep across it in a succession of parallel horizontal lines. The motion of the spot across the picture may be either uni-directional or sinusoidal. An example of the latter type of scanning is employed with motion picture film in the system described in an earlier paper.<sup>6</sup> An example of uni-directional motion in scanning is that produced by the Nipkow disc widely used in television.

In the present system the scanning is also uni-directional and is accomplished by deflecting the electron beams, both of the iconoscope and kinescope, by means of electromagnetic fields. The beam traces a succession of equally spaced horizontal lines across the fluorescent screen, reconstructing the television picture in the identical manner that the spot at the transmitter has scanned it, beginning from the top downward and after the last line jumping back to the position at the start of a new picture.

In order to scan with a cathode ray beam in this manner, two variable magnetic fields are applied to the beam just as it emerges from the electron gun; a vertical one, pulsating  $N$  times per second, and a horizontal one, pulsating as many times faster as the number of lines in the picture.

In order that the cathode beam at the receiver will follow the uni-directional scanning at the transmitter, the variation of intensity of both horizontal and vertical deflecting fields plotted against time is of a "saw-tooth" shape as shown in Fig. 23. Each cycle consists of two parts; the first, linear with respect to time and lasting practically the whole cycle, and the second, or return period, lasting only a small fraction of the cycle. The picture is reproduced during the first part of the scanning period by varying the bias of the control element according to the light intensities of the transmitted picture, as described above.

There are a number of methods that will produce "saw-tooth" shaped electrical impulses. A simple one has been de-

<sup>6</sup> V. K. Zworykin, "Television with Cathode Ray Tube for Receiver," *Radio Eng.*, Vol. IX, No. 12, December, 1929, pp. 38-41.

scribed in an earlier paper,<sup>7</sup> consisting of charging a condenser through a current limiting device such as a saturated two-electrode vacuum valve and then discharging the condenser through a thermionic or gas-discharge tube. The practical limitation of this "saw-tooth" generator lies in the fact that there is no such thing as a completely saturated thermionic tube. Therefore, the condenser cannot be charged exactly linearly with time, and, consequently, the line reproduced on the fluorescent screen will be not exactly straight.

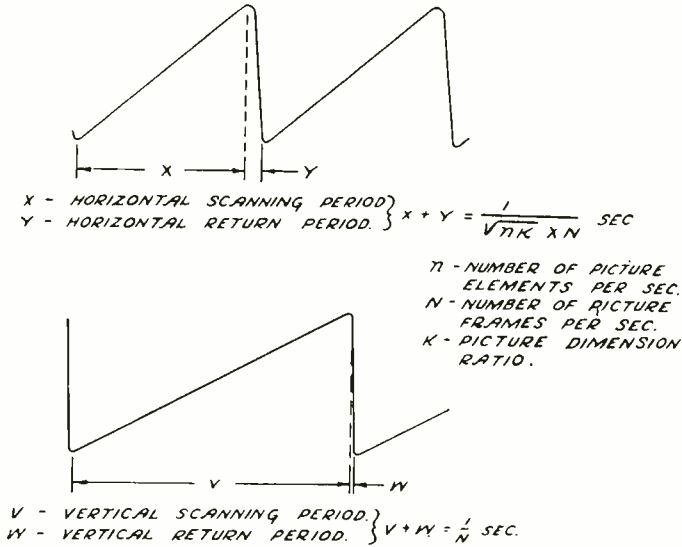

Fig. 23

In order to straighten the scanning lines and improve the quality of the reproduced picture, a more complicated circuit was used, involving one dynatron oscillator and two amplifying tubes, as shown in Fig. 24. The condenser, *C*, in the horizontal deflecting circuit is charged continuously through the resistance, *R*. Periodically, at the end of predetermined intervals, the condenser is discharged. During these intervals, the accumulated charge does not reach saturation value, for the time is insufficient. The vacuum tube through which the discharge takes place is controlled by impulses supplied from a dynatron oscillator having a distorted wave shape. The frequency of oscillation of the dynatron (which can be made to vary over a fairly wide range) is initially adjusted approximately to the fre-

<sup>7</sup> V. K. Zworykin, "Television with Cathode Ray Tube for Receiver," *Radio Eng.*, Vol. IX, No. 12, December, 1929, pp. 38-41.

quency of the scanning of the transmitter, so that received synchronizing signals will have no difficulty in pulling the dynatron into step with the synchronizing impulses generated at the transmitter. The charging and discharging of condenser, *C*, represent saw-tooth variation of potential, which, when applied to the grid of an amplifying tube, produce saw-tooth current impulses in deflecting coils connected in the plate of the amplifier.

The vertical deflecting circuit is similar to the horizontal circuit just described. Both vertical and horizontal deflecting

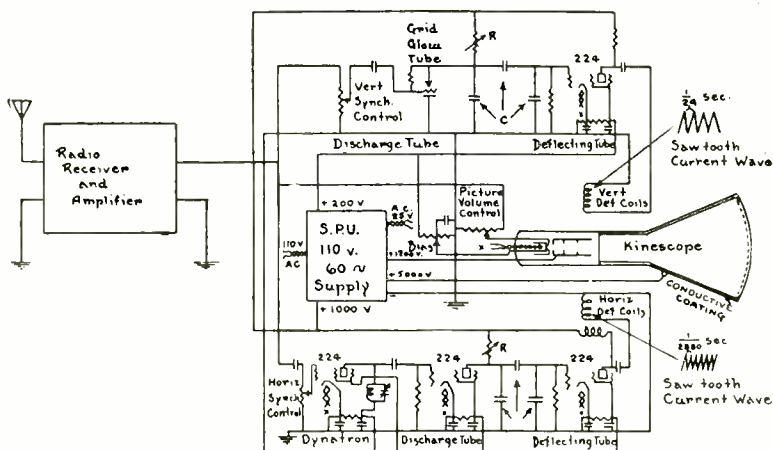

Fig. 24

systems operate on the beam by the magnetic fields generated by coils placed about the neck of the cathode ray tube.

The choice of electro-magnetic deflection in preference to electrostatic was made more as a result of economical consideration than as a mechanical choice. The kinescope for magnetic deflection is much cheaper to make than the one equipped with inside deflecting plates for electrostatic deflection. On the other hand, the electromagnetic deflecting unit itself requires more power and is more costly to build than the electrostatic one. The predominance of one or more factors depends chiefly upon the frequency of deflection and velocity of the beam.

The constants of the electrical circuits for vertical and horizontal deflection are, of course, entirely different, due to the great difference in the operating frequencies of the two deflection circuits.

## SYNCHRONIZATION

When both deflecting circuits are properly adjusted and synchronized with the transmitter, a pattern consisting of a number of parallel lines is seen on the fluorescent screen. The sharpness of the pattern and perfection of its synchronization with the iconoscope determine to a large extent the quality of the reproduced picture. This pattern is transformed into the picture by applying the picture signal impulses from the transmitter to the control element of the kinescope, so as to momentarily vary the brilliancy of the spot.

For sending synchronizing signals to the receiver, the impulses produced by the deflecting generators of the iconoscope are fed into the amplifier and united with the picture signals and, therefore, are transmitted over the picture signal channel. They do not interfere with the picture signals, because they occur at an instant when the picture is not being transmitted.

Vertical synchronization is carried out in the same manner, synchronizing impulses for this purpose being transmitted at the completion of each frame.

Considerable advantage is gained from using a synchronizing system in which the beam at the receiver is brought into step with the transmitter at the end of each horizontal line, because momentary disturbances of the nature of static do not appreciably affect the picture.

It will be seen that the radio transmitter is modulated by picture, horizontal synchronizing and vertical synchronizing signals. The resulting composite signal which is fed to the receiver's modulator grid, therefore, appears as shown in Fig. 25, the top curve of which represents the irregular-shaped picture signals which are often unsymmetrical about the axis, usually more positive than negative. Both synchronizing signals are arranged to have their peaks on the negative side of the axis. The difference in shape of the horizontal and vertical impulses, of course, is due to the time of duration of both signals and the resultant difference in wave shape is utilized at the receiver for the purpose of separating these two synchronizing impulses. The three signals mentioned above differ in frequency and in amplitude. The peak picture signal amplitude is carefully adjusted to be always less than the horizontal and vertical impulses, the amplitude of the latter being approximately equal.

The separation of the three signals at the receiver is accomplished by a very simple means which is described in detail in

another paper,<sup>8</sup> so that the fundamentals only will be mentioned here. If we trace the signals at the receiver from the antenna through the radio receiver and amplifier, shown in Fig. 24, we find that they are applied to three independent units, the vertical deflecting system, the horizontal deflecting system and the input to the kinescope. The synchronizing impulses do not affect the picture on the kinescope because they are transmitted at a time when the cathode ray beam is extinguished, that is, during its return period. The picture signals do not affect the deflecting circuits because amplitude selection is utilized; that is, the

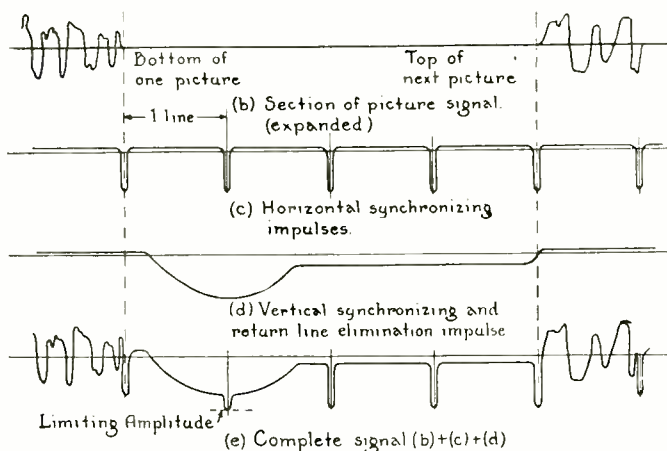

Fig. 25

amplitude of the picture signals is never sufficient to affect the input tubes of either deflecting system. The selection between vertical and horizontal synchronizing impulses is made on the basis of wave shape selection. A simple filter in each of the input circuits of the two deflecting units gives satisfactory discrimination against undesired synchronizing impulses. The plate circuits of both dynatron input tubes contain circuits approximately resonant to the operating periods of their respective deflecting circuits, thus aiding in the matter of selectivity.

When the electron beam returns to the position from which it starts to trace a new line, and particularly when it returns from the bottom of the picture to start a new frame, an undesirable light trace, called the return line, is visible in the picture. To eliminate this the synchronizing impulses which are in the

<sup>8</sup> R. D. Kell, *Proceedings I. R. E.*, December, 1933.

negative direction are applied to the control electrode of the kinescope, so as to bias it negatively and thus eliminate the return line by extinguishing the beam during its return.

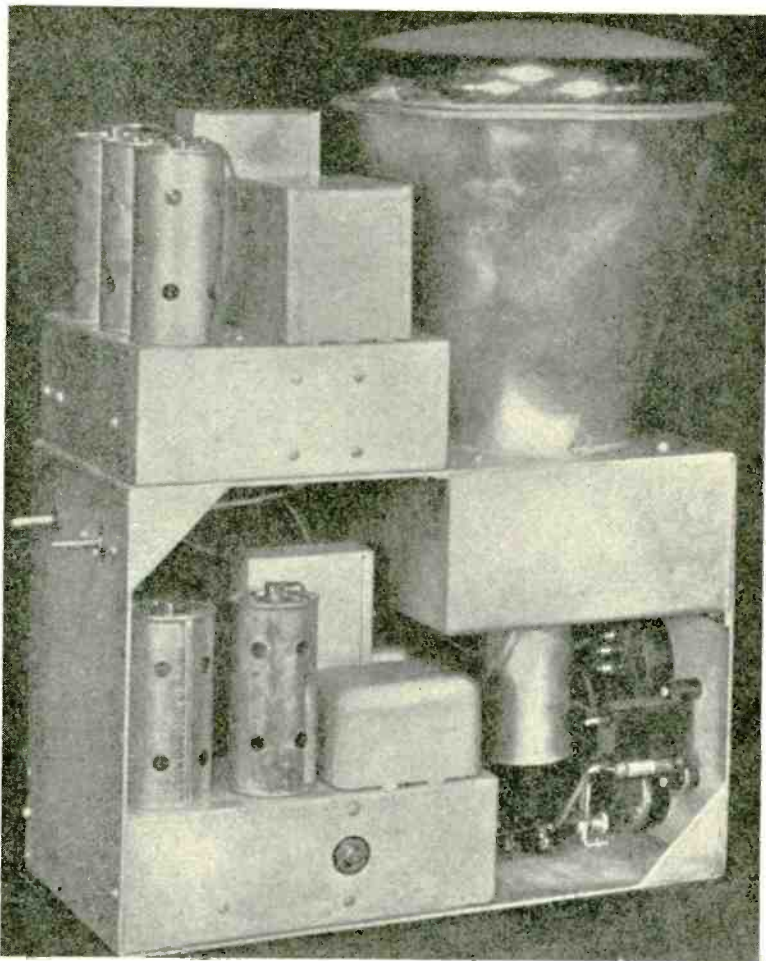

Fig. 26

To produce a picture, the intensity of light on a fluorescent screen is varied by impressing the picture signal on the kinescope control element. If the bias adjustment on the kinescope is set so that the picture signals have the maximum swing on the characteristic curve of the kinescope (shown in Fig. 19) a picture with optimum contrast is produced. The picture back-





Fig. 27

ground, or the average illumination of the picture, can be controlled by the operator by adjusting the kinescope bias.

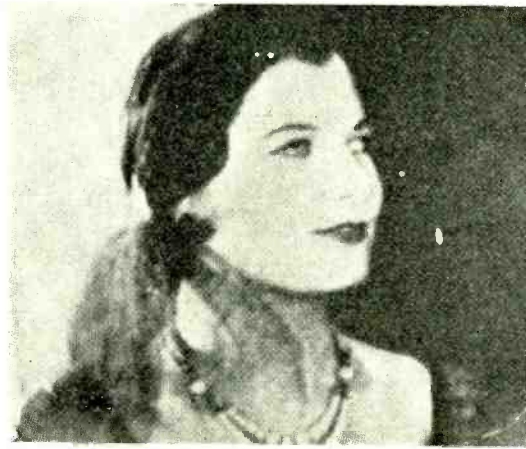

Fig. 28

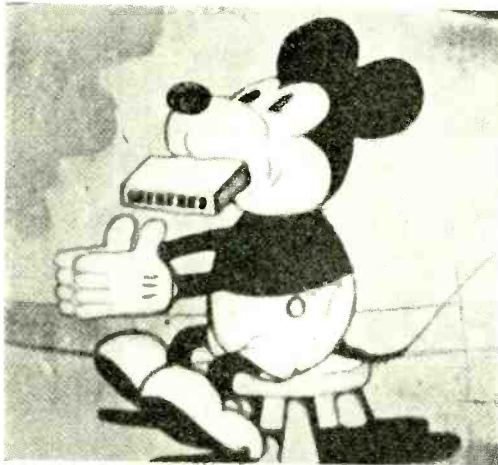
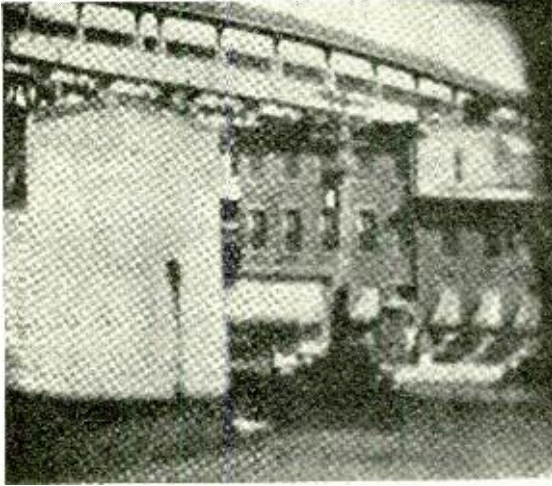

Fig. 29

#### REPRODUCING EQUIPMENT

The arrangement of the television receiver built for these tests is shown in Figs. 26 and 27. The former is a photograph

of the chassis containing the deflecting unit and kinescope. This chassis slides as a unit into the cabinet. Fig. 27 is a photograph of the complete receiver which contains a power



**Fig. 30**



**Fig. 31**

unit, kinescope unit, two radio receivers—one for picture and one for sound signals—and a loud speaker.

The reproduced image is viewed in a mirror mounted on the inside lid of the cabinet. In this way the lid shields the picture from overhead illumination. This method also affords a greater and more convenient viewing angle. The brilliancy of the picture is sufficient to permit observation without the necessity of completely darkening the room. Since this type of television receiver has no moving mechanical parts, it is quiet in operation.

The next pictures show the results obtained by means of the above described system. Figs. 28<sup>9</sup> and 29 show photographs of the fluorescent screen of the kinescope when the same pictures as used for Figs. 2 and 3 were being transmitted.

Figs. 30 and 31 are actually the pictures transmitted with the iconoscope camera in the studio and outdoors.

With the advent of an instrument of these capabilities, new prospects are opened for high-grade television transmission. In addition, wide possibilities appear in the application of such tubes in many fields as a substitute for the human eye, or for the observation of phenomena at present completely hidden from the eye, as in the case of the ultra-violet microscope.

The writer wishes gratefully to acknowledge the untiring and conscientious assistance of Messrs. G. N. Ogloblinsky, S. F. Essig, H. A. Iams, A. W. Vance and L. E. Flory, who carried on much of the theoretical and experimental work connected with the development which has been described in the foregoing, and whose ability was the major factor in the successful solution of the many problems arising in the course of this work.

<sup>9</sup> Courtesy of Mr. R. D. Kell.

# AN EXPERIMENTAL TELEVISION SYSTEM

By

E. W. ENGSTROM

(RCA Victor Company, Inc., Camden, N. J.)

*Summary*—During the first part of 1933 a complete experimental television system was placed in operation in Camden, New Jersey. Practical tests were made under conditions as nearly as possible in keeping with probable television broadcast service. Program material was obtained from studio pick-up and outdoor pick-up. The outdoor pick-up was from a point a mile from the studio and transmitter. In addition, a studio program originating in the Empire State Building in New York was relayed to Camden by radio and broadcast in Camden. The transmitter used an iconoscope as the pick-up element and the receiver a kinescope as the reproducing element.

This paper is an introduction to a group of three papers which describe the transmitter terminal equipment and the transmitter, the New York-to-Camden radio relay circuit, and the receiver apparatus.

## PART I—INTRODUCTION

A GROUP of papers has been published in these PROCEEDINGS describing an experimental television system on which tests were made in the metropolitan area of New York during the first half of 1932.<sup>1</sup> These tests indicated many of the objectives for continued research in the laboratory. In order to make practical tests on the next stage of television research, a complete system was built in Camden and operated during the first several months of 1933.

In the New York tests the major limitation to adequate television performance was the studio scanning apparatus. This consisted of a mechanical disk, flying-spot type, for an image of 120 lines. Even for small areas of coverage and for 120 lines, the resulting signal amplitude was unsatisfactory. In the Camden system, an iconoscope was used as the pick-up device. The iconoscope and its operation have been described in the PRO-

<sup>1</sup> E. W. Engstrom, "An experimental television system"; V. K. Zworykin, "Description of an experimental television system and the kinescope"; R. D. Kell, "Description of experimental television transmitting apparatus"; G. L. Beers, "Description of experimental television receivers"; Proc. I.R.E., vol. 21, pp. 1652-1706; December, (1933); and L. F. Jones, "A study of the propagation of wavelengths between three and eight meters," Proc. I.R.E., vol. 21, pp. 349-386; March, (1933).

Reprinted from Proceedings of the Institute of Radio Engineers.

CEEDINGS by Zworykin.<sup>2</sup> The use of the iconoscope permitted transmission of greater detail, outdoor pick-up, and wider areas of coverage in the studio. Experience indicated that it provided a new degree of flexibility in pick-up performance, thereby removing one of the major technical obstacles to television.

The picture characteristics for this experimental television system included 240-line progressive scanning, 24 frames per second. The choice of 240 lines was not considered optimum,<sup>3</sup> but all that could be satisfactorily handled in view of the status of development. It is of interest to compare the resulting image and electrical specifications with those for the New York tests. These are given in Table I.

Aspect ratio	1.33 (4×3)
Frame repetition frequency	24 per second
Video frequency (picture frequency)	
Assumed that each arbitrary picture element is square and requires one-half cycle and that 10 per cent of the time is required for control functions.	

TABLE I

Scanning lines	Picture element	Maximum video frequency	Maximum video communication band
120	19,200	256,000	512,000
240	76,780	1,024,000	2,048,000

In the New York tests the picture and sound transmitters were widely separated in frequency to simplify apparatus requirements. In our analysis of television systems, it had been decided desirable that there be two transmitter carriers, one for picture and one for sound. It had further been concluded that the picture carrier should include the video signal, synchronizing impulses, etc. Thus the problem of television reproduction requires the reception and utilization of two transmitted carriers with their respective modulations (one for picture and control signals and the other for sound), without interference from each other and without interference from other television stations. These considerations plus a study of station allocation in a national system, receiver design and tuning problems, and other related factors, indicated that the two carriers for one

<sup>2</sup> V. K. Zworykin, "The iconoscope—a modern version of the electric eye," *PROC. I.R.E.*, vol. 22, pp. 16-32; January, (1934).

<sup>3</sup> E. W. Engstrom, "A study of television image characteristics," *PROC. I.R.E.*, vol. 21, pp. 1631-1651; December, (1933).

station should be adjacent, their spacing being dependent upon image detail, and transmitter and receiver selectivity characteristics. For these tests it was assumed that a television channel for picture and sound should be 2000 kilocycles wide and that the picture and sound carriers should be spaced by 1000 kilocycles. This particular channel width and carrier spacing are not given as optimum but rather as practical limitations for the tests. Diagrammatically, a television channel of this type is shown in Fig. 1.

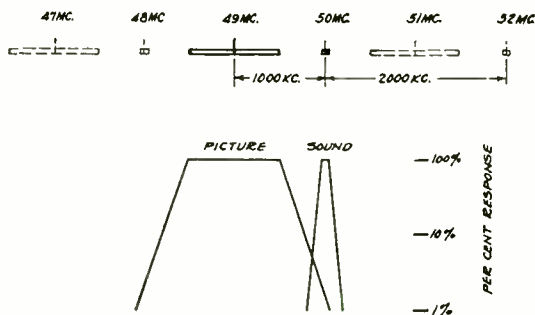

Fig. 1—Over-all transmitter and receiver selectivity characteristics.

In the Camden tests, the picture carrier was at 49,000 kilocycles and the sound carrier 50,000 kilocycles. This spacing of 1000 kilocycles, when compared with the maximum video frequency band of Table I for 240 lines, indicates that the system did not permit use of the full arbitrarily assumed frequency band. The combined transmitter and receiver selectivity characteristic was such as to pass a frequency band approximately 0.6 of the carrier spacing and, also, in this case 0.6 of the maximum video frequency of Table I.

Since the tests were essentially for the purpose of obtaining experience with the system fundamentals and with the terminal apparatus, the picture and sound transmitters had nominal outputs. The two transmitters were located in one of the RCA Victor buildings and the antennas on masts above the building. The studio and control apparatus were located in another building about 1000 feet direct-line distance from the building housing the transmitters. Most of the receiving tests were made at a point four miles from the transmitter.

One of the problems in television is to provide facilities for program pick-up at points remote from the studio and transmitter. In this experimental system a pick-up point was located

approximately one mile from the studio. Here an outdoor program was televised and relayed to the main studio and transmitter by radio. Fig. 2 indicates the Camden system.

Another problem in television is to tie groups of stations together for network service. The interconnecting link might either be a special land wire or radio. In this experimental sys-

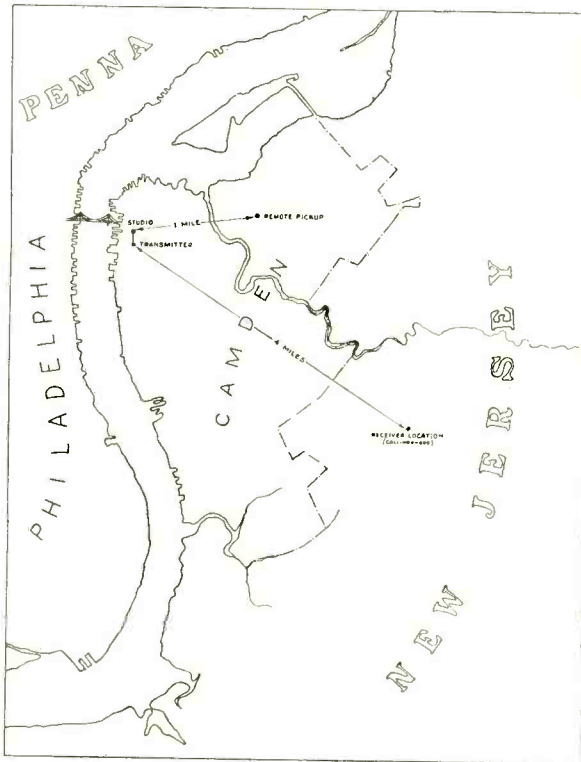

Fig. 2

tem tests were made on radio relaying of television programs between New York and Camden. A program originating in the Empire State Building studio was transmitted by radio, relayed at an intermediate point, received and broadcast in Camden. For these tests 120-line scanning was used, since this was the standard for the New York equipment. Fig. 3 indicates the complete system.

The increase of image detail (from the New York tests—120 to 240 lines) widened very considerably the scope of the material that could be used satisfactorily for programs. Experience with



this system indicated that even with 240 lines, for critical observers and for much of the program material, more image detail was desired. The desire was for both a greater number of lines and for a better utilization of the detail capabilities of the system and lines chosen for the tests. The iconoscope type pick-up permitted a freedom in subject material and conditions roughly equivalent to motion picture camera requirements.

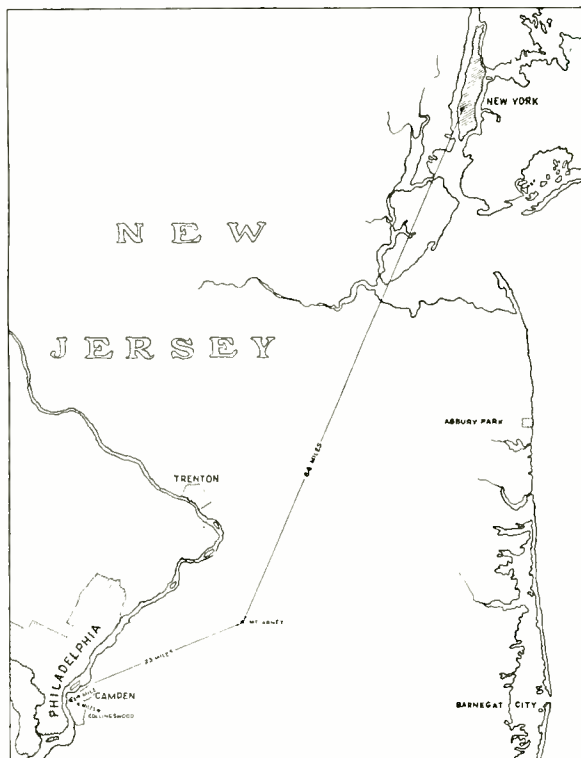

Fig. 3

As in the New York tests, much valuable experience was obtained in constructing and placing in operation a complete television system having standards of performance abreast of research status. Estimates of useful field strengths were formulated. The need for a high power television transmitter was indicated. Further studies were made of interference caused by automobile and airplane ignition systems. Consideration was given to receiver antenna problems. Technical and lay opinion was obtained on receiver operation, image characteristics, and entertainment possibilities. Some work was done on program,

studio, and pick-up technique. Again the tests indicated directly or as a result of analysis the objectives for further research. It is the purpose of this group of papers to describe the system, the experimental apparatus, and the tests that were made. The description is divided into three parts: the transmitter, radio relay circuit, and receiver.

Acknowledgment is made to all members of the RCA organization who participated in the work.



# AN EXPERIMENTAL TELEVISION SYSTEM

BY

R. D. KELL, A. V. BEDFORD, AND M. A. TRAINER

(RCA Victor Company, Inc., Camden, N. J.)

*Summary*—A description is given of an experimental television pick-up and transmitting installation which used a special form of cathode ray tube, the iconoscope, as the signal generating device. The installation included facilities for remote pick-up of outdoor scenes and the relaying of programs by radio. The transmitted subject matter for the tests included motion picture film, studio scenes, and outdoor scenes. Description is given of video frequency amplifiers having uniform frequency response from about 20 cycles to 600,000 cycles per second. Discussions are given on several of the problems which arose in the use of the iconoscope.

## PART II—THE TRANSMITTER

**A**FTER the completion of the Empire State experimental television installation, work was concentrated on producing a picture containing greater detail, using the same type of terminal equipment. The number of scanning lines was increased from 120 to 180. This number of lines gave a television signal having a satisfactory signal-to-noise ratio only when motion picture film was scanned. The light obtainable in the studio was of too low a value to be usable.

The results indicated that the iconoscope offered the most satisfactory solution of the problem of increased detail. Due to its mode of operation, as has already been explained,<sup>1</sup> the sensitivity of the iconoscope was sufficient to allow a further increase in the number of scanning lines. With considerable increase in detail, there was still sufficient sensitivity to make possible the use of the camera with light conditions suitable for a regular motion picture camera. This device also gave television the hoped-for freedom of operating conditions. It has made possible the broadcasting of outdoor events as well as studio scenes.

Early preliminary tests with the iconoscope had indicated that the resolution of the system was no longer limited by the television elements. Strictly speaking, these elements are only the kinescope and iconoscope; the resolution of each is consider-

<sup>1</sup> V. K. Zworykin, "The iconoscope—A modern version of the electric eye," *PROC. I.R.E.*, vol. 22, no. 1, pp. 16-32; January, (1934).

Reprinted from Proceedings of the Institute of Radio Engineers.

ably greater than could be transmitted through the remainder of the system. In using film transmission of 180 lines, all component parts had been designed to pass the top theoretical frequency of 500 kilocycles. Without major changes, it was found possible to extend this range to 600 kilocycles.

The conventional method of calculating the maximum video frequency required for a given number of lines is as follows:

$$f = \frac{1}{2}a^2Rn \text{ or } a = \sqrt{2f/nR}$$

where  $f$  is the maximum frequency in cycles,  $a$  is the number of scanning lines,  $n$  is the frame repetition frequency, and  $R$  is the aspect ratio of the picture. This equation gives the fundamental frequency which would be generated by scanning a pattern composed of alternate black and white vertical bars in which each bar has a width equal to the line pitch. The line pitch is the distance between centers of adjacent scanning lines. A system capable of transmitting the maximum frequency given by this equation and having a scanning spot of diameter no greater than the line pitch, would resolve the bars in so far as peaks of black and white are concerned. This would hold for any horizontal displacement of the test pattern. With the same test pattern in a horizontal position so that the bars lie along the scanning lines and with the bars and lines coinciding, proper resolution is again obtained. If the pattern is now moved vertically a distance equal to half the line pitch—due to each line covering half of a white bar and half of a black bar—no signal will be generated and the resolution will be zero regardless of the frequency band the system is capable of transmitting. For intermediate positions of the pattern, the resolution will vary gradually from 100 per cent to zero.

It is axiomatic that for best resolution of random picture subject matter, equal resolution should be obtained along all axes. The equation given above fails to fill this demand for at least two axes at right angles to one another, using even the basic test pattern upon which the equation is founded. Analyses for other axes are difficult but observations indicate that they would generally support the same conclusion. Therefore, the above equation makes the number of scanning lines too low to secure the maximum amount of detail in a given video frequency band width.

In television we are not interested in viewing uniform bars in various positions, any more than we wish to listen to sine

waves of sound, but such bars and waves are considered best for analytical purposes. Tests made with a calibrated resolution pattern projected upon the plate of the iconoscope and with a variable number of scanning lines showed the resolution to be substantially equal along horizontal and vertical axes when the number of scanning lines,  $a$ , was approximately 1.25 times that calculated by the equation given above. This justifies the introduction of an additional constant,  $k$ , making the formula

$$f = \frac{1}{2}a^2Rnk \text{ or } a = \sqrt{2f/nRk}$$

where  $k$  equals  $1/(1.25)^2$  or 0.64. From the above corrected equation the 600-kilocycle channel is found to give equal vertical and horizontal detail when 240 lines are used at a repetition rate of 24 pictures per second. With this number of scanning lines a

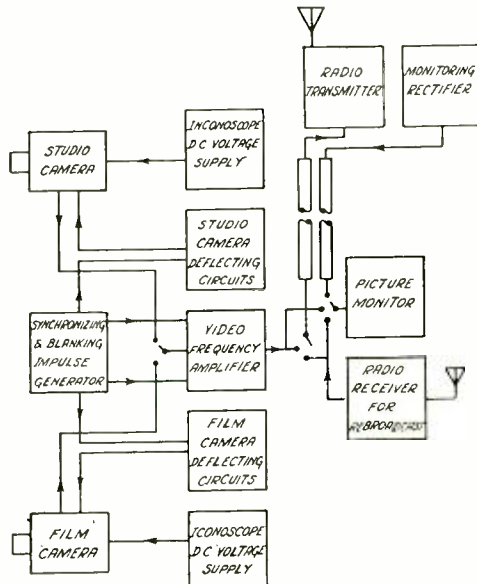

Fig. 1

complete television installation was made having facilities for transmitting studio, film, and outdoor scenes. The method of synchronizing the transmitter and receivers was the same as previously described.<sup>2</sup> Impulses having an amplitude greater than the picture signal were transmitted at the end of each scanning line and at the end of each frame.

<sup>2</sup> R. D. Kell, "Description of experimental television transmitting apparatus," PROC. I.R.E., vol. 21, no. 12, pp. 1673-1691; December, (1933).

The relationship of the major components of the installation is shown in the block diagram, Fig. 1. The film and studio cameras are practically identical. In the film camera a motion picture projector was used to project the image upon the iconoscope plate, while in the studio camera a photographic lens formed the image of the scene to be transmitted on the iconoscope plate. Fig. 2 is a photograph showing the general appear-

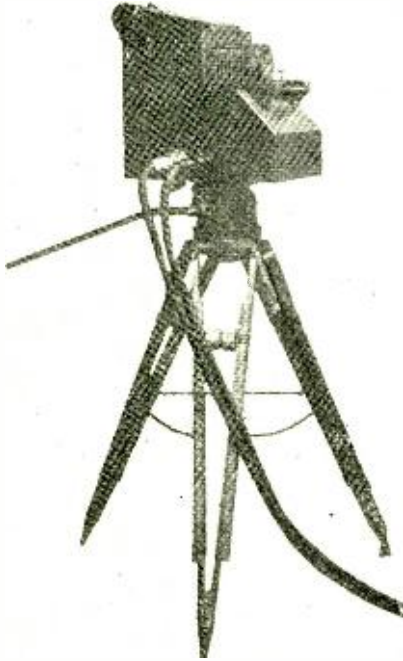

Fig. 2

ance of a studio camera. Fig. 3 shows the general arrangement of parts in the camera. The partition (*a*) through the center is an electrostatic shield separating the video frequency amplifier from all other voltages applied to the iconoscope. This shielding is quite essential due to the magnetic and electrostatic fields around the deflecting coils and plates. The deflecting coils for causing the scanning beam to move vertically are seen at (*b*). The deflecting plates for causing the beam to move horizontally are not visible in the photograph. They are mounted directly on the electron gun structure. The leads from the plates are brought out through the base with the other voltage leads.

The amplifier (c) consists of three stages. The third stage has an output impedance sufficiently low to allow the video fre-

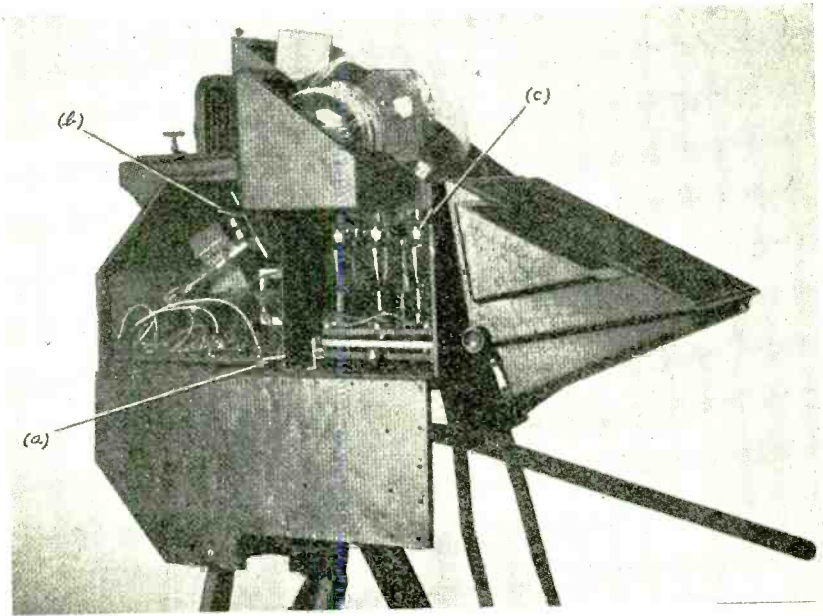

Fig. 3

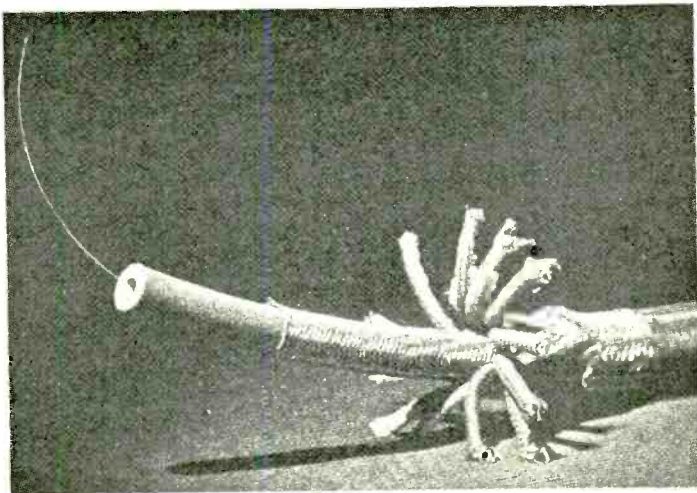
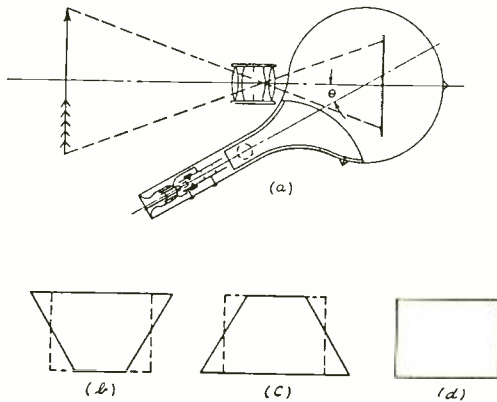

Fig. 4

quencies to be transmitted to the control room through a considerable length of special cable. A section of this cable is shown in Fig. 4. It consists of a shielded flexible insulating tube con-

taining a single conductor for carrying the video frequencies. Since the capacity of a concentric cable is dependent upon the ratio of the diameters of the two conductors, the inner conductor of the cable was made as small as physically practical and the flexible tube was made as large as convenient for handling. All other amplifier voltages are carried by the conductors fitted around the central tube. An external shield and braid complete the cable. A similar cable is used to supply all deflecting and operating voltages for the iconoscope. The horizontal deflecting voltage is supplied through the central conductor in this cable.



**Fig. 5**

The circuits for causing the electron beam of the iconoscope to scan the photo-electric mosaic plate are similar to those used for deflecting the beam of the receiving kinescope, the greatest difference being due to the fact that the mosaic plate is not at right angles to the electron gun.

Since the scanning beam and the optical image strike the same side of the iconoscope mosaic, it is impractical for the axis of both the electron gun and the lens to be at right angles to the mosaic plate. The use of standard lenses requires that the plate be perpendicular to the optical axis of the lens. This requires that the scanning beam strike the plate at an angle. An outline of an iconoscope is shown in Fig. 5(a).

If the iconoscope is subjected to the regular scanning a "keystone" shape pattern will be formed due to the longer beam path to the top of the mosaic plate as shown in Fig. 5(b). The deflecting means serve only to vary the direction of travel of the electron scanning beam. Hence, the amplitude of the deflection at the



plate depends upon the distance from the deflecting means to the plate. In order to scan a rectangular area, Fig. 5(d), on the iconoscope plate and avoid distortion of the transmitted picture, it is necessary to deflect the beam by the scanning action in such a way that if it fell upon a plate at right angles to the average axis of the beam, it would scan a pattern such as Fig. 5(c). The required horizontal scanning voltage wave is obtained by modulating the horizontal saw-tooth in amplitude by the vertical saw-

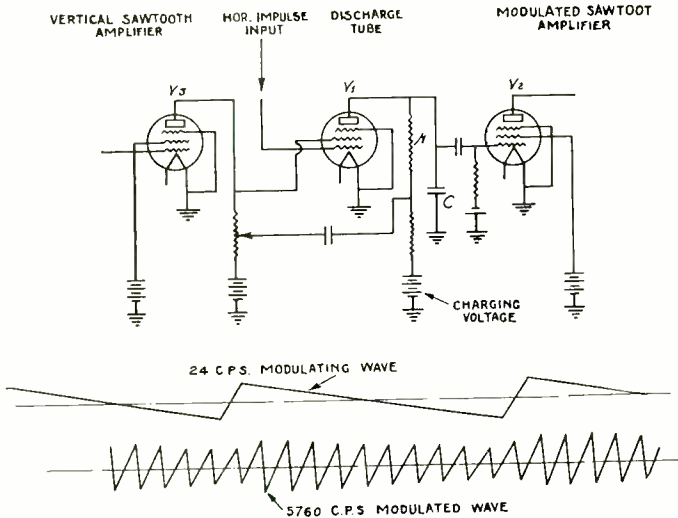

Fig. 6

tooth wave. The modulation requirements are unusual in that, to produce a symmetrical scanning pattern, the modulated horizontal saw-tooth wave must contain no component of the vertical saw-tooth wave. Furthermore, the modulated wave must retain a good saw-tooth (or triangular) wave shape throughout its cycle of modulation. Due to the very extended range of harmonics and the precise phase relations required to form a good saw-tooth wave, wave filters have been found to be of little aid in the problem of separating the modulating and modulated waves after they are once mixed. It has been found much easier to guard against any mixing of the waves in the modulating process, by using a special type of balanced modulation.

A circuit arrangement for accomplishing this is shown in Fig. 6. The horizontal deflecting circuit makes use of a condenser *C* charged through a high resistance *r* and intermittently discharged by a four-electrode vacuum tube *V*<sub>1</sub>. This arrangement

produces a saw-tooth wave of voltage across the condenser  $C$  which is amplified and applied to the deflecting plates. During the vertical scanning cycle, the amplitude of the condenser charges on the condenser  $C$  in the horizontal deflecting circuit is decreased at a constant rate by decreasing the supply voltage to the charging resistor,  $r$ , by means of a vertical saw-tooth of voltage. To maintain the discharge always equal to the charge, the control-grid or the screen-grid voltage of  $V_1$  is also varied in exact proportion by means of the vertical saw-tooth of voltage. The combined action of these two vertical saw-tooth voltages on the horizontal saw-tooth generating circuit is to produce the desired amplitude modulation of the horizontal deflection of the scanning beam.

As previously mentioned, the resolution of the iconoscope is considerably better than the rest of the system is capable of transmitting. As a result of this, it is possible to scan an area considerably smaller than the full size of the iconoscope plate before the resolution of the iconoscope becomes the limiting factor. This makes possible an unusual flexibility in the use of the camera. By changing the horizontal and vertical scanning amplitudes simultaneously, the effect of moving the camera forward or away from the subject is obtained without physically moving the camera. By adjusting the position of the scanning pattern to various sections of the mosaic, the effect of turning the camera may also be obtained. This shifting of the scanned area with respect to the entire area of the mosaic is accomplished by introducing direct-current components into the saw-tooth deflecting circuits. The combined result of these two controls makes possible various effects; for example, first showing a close-up of a person, moving slowly away to take in the full scene, and again moving forward to a close-up of another person; all this apparent movement of the camera being accomplished by purely electrical means.

The principles of operation of the iconoscope have already been discussed and will only be outlined here. The picture signal generated by the iconoscope is produced by the electron beam discharging the elemental condensers forming the surface of the mosaic. The current released as a signal at any picture element is a function of the illumination of the point under scanning and also upon the time the scanning beam covers the elemental picture area. In other words the signal generated is not only a function of illumination but also a function of the velocity

of the scanning beam. This means that to produce a picture signal which is truly representative of the light values of the picture, the velocity of the scanning beam must be constant. By careful design of the circuits for deflecting the scanning beam, this has been practically accomplished during the actual picture scanning time. But during the reversal and return of the scanning beam the velocity cannot be constant and undesirable signals are generated. The total signal generated has the general appearance of that shown in Fig. 7 (*a*). The undesired signal generated during the reversal and return of the scanning beam may have

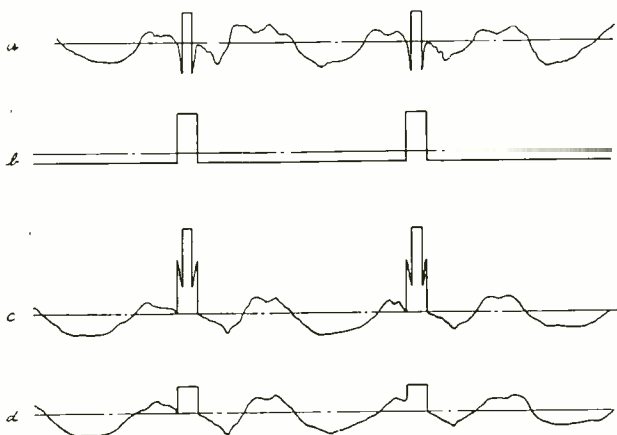

Fig. 7

an amplitude of several times the useful picture signal and, of course, it must be removed from the final transmitted television signal. To do this a square wave shaped signal generated by the disk that produces the synchronizing impulses is introduced into the amplifier. The wave shape of this signal is shown in Fig. 7 (*b*). The amplitude of the signal is such that the white parts of the undesired signal are shifted with respect to the axis to a point that corresponds to black, as shown in Fig. 7 (*c*). The picture frequency amplifier is so arranged that this combined signal is of such a polarity and amplitude that the undesired signal swings the grid of an amplifier tube beyond cut-off. The result is a signal in which the amplitude of the blanked-out section is, for practical purposes, a constant with respect to the axis, as shown in Fig. 7 (*d*).

Fig. 8 is a photograph of an electrical impulse signal generator. A disk containing two circular rows of apertures is driven by a motor at 1440 revolutions per minute or 24 revolutions per

second. An illuminated optical slit is imaged on each of the two rows of apertures. Behind each row is a phototube with its associated amplifier. One set of apertures is of sufficient width to generate the wave which blanks out the amplifier signal during the return line time of the iconoscope horizontal scanning beam. These are the impulses used to remove all extraneous signals, as previously described. They occupy a time equal to 10 per cent of the horizontal scanning cycle. The vertical impulse is sufficiently long to produce a black signal for a time interval slightly longer than the vertical return line time on the kinescope. This

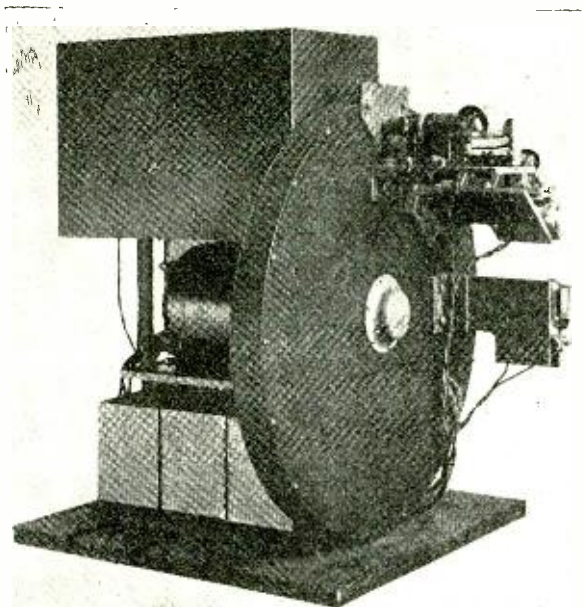

Fig. 8

serves to extinguish the kinescope scanning beam during its vertical return across the screen.

The synchronizing impulses are generated by the light passing through the second set of apertures in the disk. These signals are introduced into the amplifier after the signal level for black has been set by the cut-off action of the amplifier. They are so phased that they occur at the beginning of the blank or black sections. Since all signals generated in the iconoscope pass through the limiting tubes that remove the undesired signals, it is impossible for any picture signal to become of such an amplitude as to interfere with the proper synchronization of the receivers. Fur-

thermore, since the synchronizing impulses are superimposed upon the blank sections or "pedestals," the height of the synchronizing impulses will remain constant, thus facilitating the use of amplitude separation of synchronizing signals from the picture signals at the receiver. The appearance of a complete signal as viewed on an oscilloscope is shown in Fig. 9.

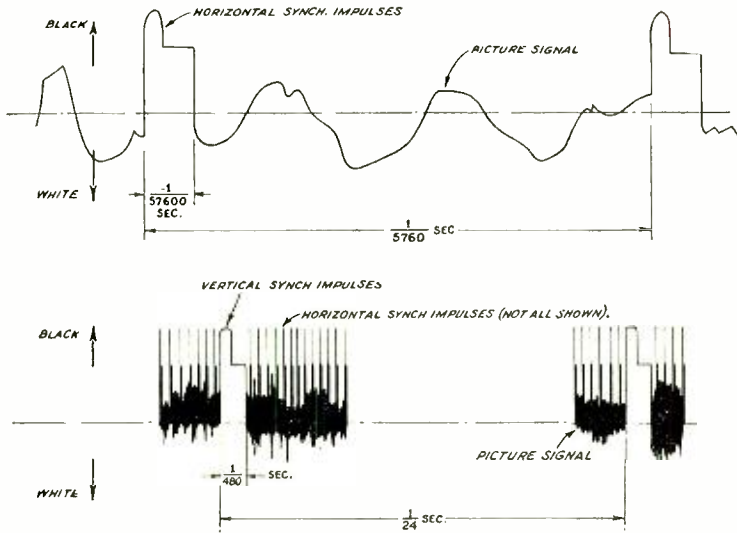

Fig. 9

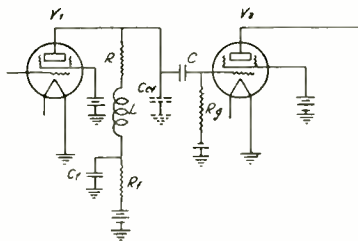

Fig. 10

The peak signal obtained directly from the iconoscope is approximately 0.001 volt across 10,000 ohms. With this input, an amplifier having a voltage gain of 2000 is sufficient to supply signal at a two-volt level. A typical amplifier stage is shown in Fig. 10. The response of the amplifier at the high frequencies is

equalized by placing a small inductance  $L$  in series with each plate resistor  $R$ . The value of the inductance for a given circuit may be determined by a very simple rule which gives a flat amplifier characteristic and negligible phase distortion. The plate resistor in an amplifier stage should be equal in ohms to the effective reactance of the tube and distributed capacity  $C_{ef}$  at the highest frequency which it is desired to pass. The reactance of the inductance in the plate circuit at this frequency should be equal to one-half the value of the plate resistor. In order to obtain a flat frequency response at the low frequency end, plate filters are used. Each plate supply is filtered through a resistor

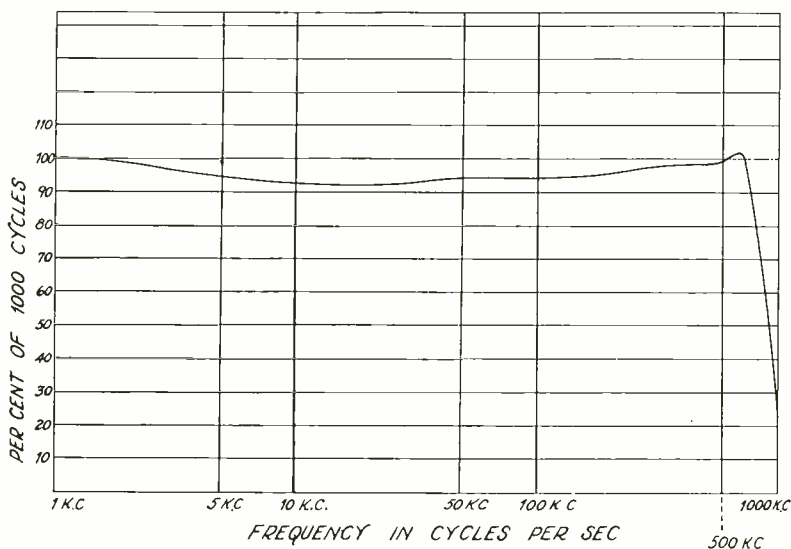

Fig. 11

$R_f$  by-passed by a condenser  $C_f$ . The circuit constants are so selected that, as the reactance of the coupling condenser between stages rises as the signal frequency is lowered, tending to cause a loss in voltage applied to the grid of the following stage, the reactance of the by-pass condenser on the plate filter rises, increasing the effective plate circuit impedance. This balance of constants makes possible not only a flat frequency response but a response free from phase distortion at the lowest desired frequency. A frequency response curve of the complete picture amplifier is shown in Fig. 11.

Fig. 12 is a view of the main television signal control room. These racks contain the circuits for amplifying and mixing the

picture signals, blanking signals, and synchronizing impulses. They contain the deflecting and control circuits for both studio

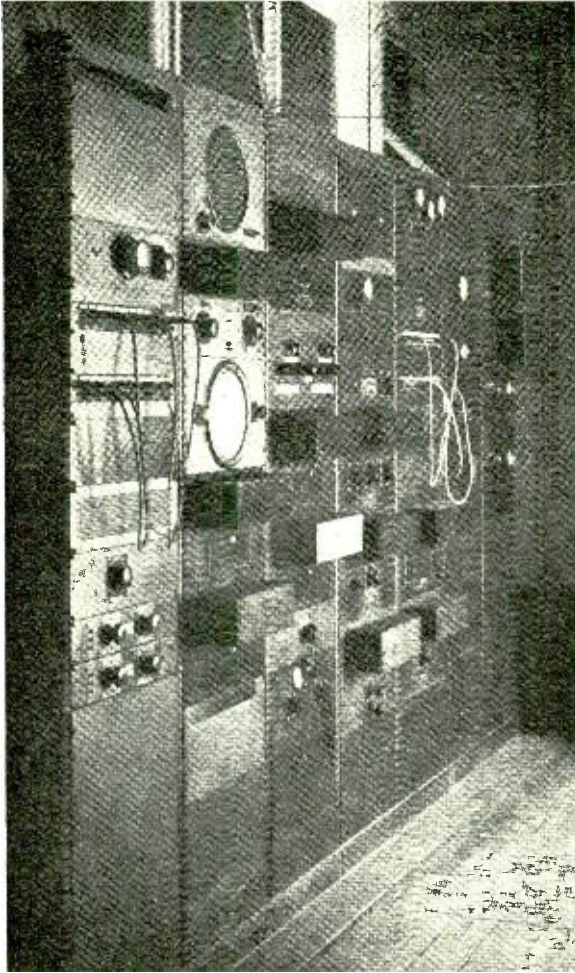

Fig. 12

and motion picture iconoscope, a monitor for checking the operation of the system, and all switching facilities to change the input to the radio transmitter from studio to motion picture or to the radio receiver used to receive the signals from a remote pick-up point. All sound circuits are also provided in these racks.

The video frequency signal generated in this portion of the system is at a level of approximately two volts across 30 ohms.

The low impedance output is such as to match the impedance of a special cable. This cable carries the signal underground from the control room to the radio transmitter, a cable distance of 1500 feet. Fig. 13 shows the frequency response of this cable

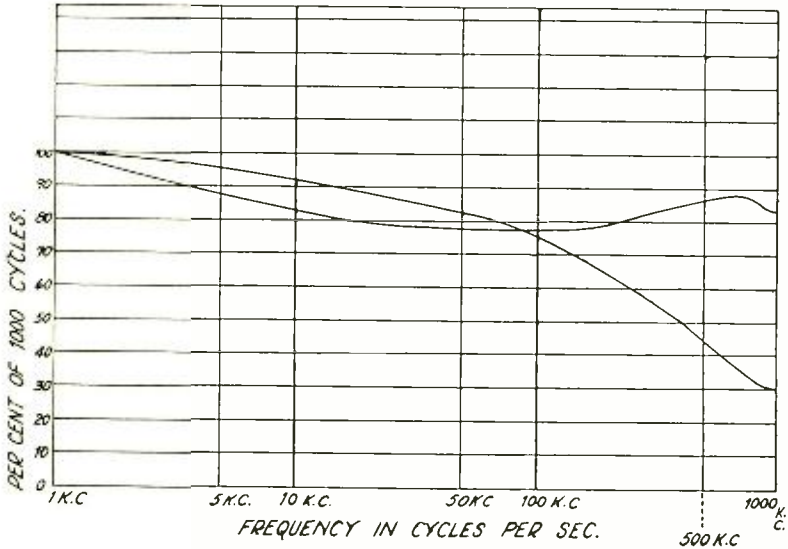

Fig. 13

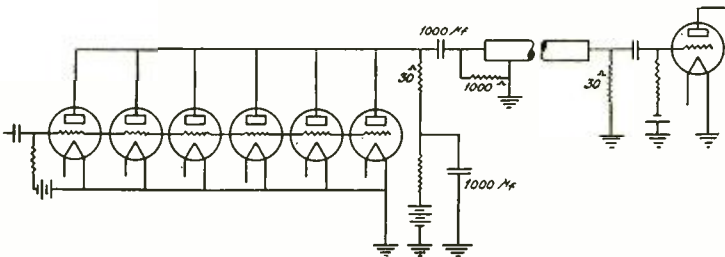

Fig. 14

before and after equalization. In order to make the switching of the output of the video frequency amplifier practicable, it was necessary to prevent the direct current from flowing through the cable. This requirement made capacity coupling into the cable necessary.

Since the line impedance and distant termination were only 30 ohms, the problem of coupling into such a low impedance was unusual. The circuit arrangement is shown in Fig. 14. Here again the filter in the plate circuit was made to have such a



value that, as the drop across the coupling condenser increases with decreasing frequency, the impedance in the plate circuit also increases, maintaining the voltage across the cable a constant. Even with this circuit arrangement it was necessary to use coupling and filter condensers of 1000 microfarads each in order for the phase shift at 24 cycles per second to be unobjectionable.

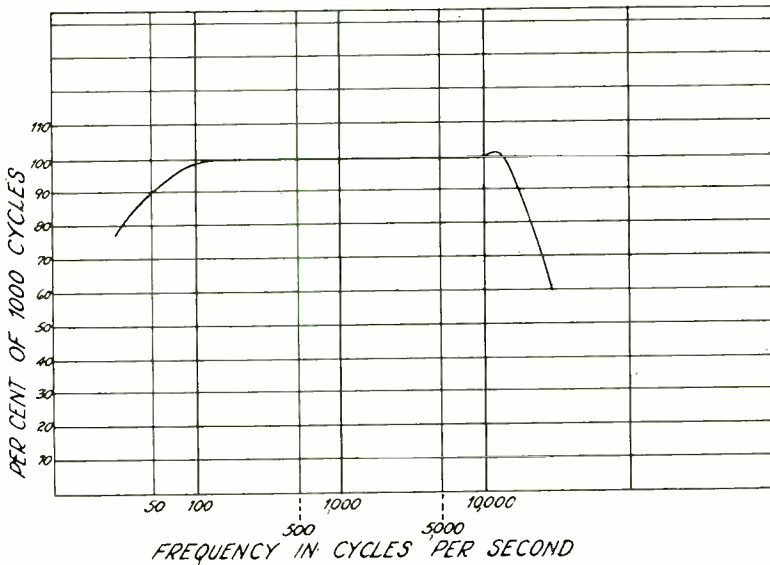

Fig. 15

Both sound and picture radio transmitters were crystal controlled. The spacing between carriers was accurately maintained at 1000 kilocycles. The power amplifier of the sound transmitter consisted of a pair of RCA-831 tubes in push-pull. These were modulated by means of a high fidelity class B amplifier. A carrier power of 600 watts was obtained. The frequency response of this transmitter is shown in Fig. 15.

The picture transmitter contained a pair of RCA-846's in push-pull as the final power amplifier. The modulator was a conventional plate modulator containing a pair of RCA-848's, which had sufficient power to modulate the four-kilowatt carrier. Because of the high input capacity of these tubes, it was necessary to use six RCA-831's in parallel to maintain constant voltage over the required frequency range, on the grids of the RCA-848's. These in turn required three RCA-860's in parallel

to maintain constant voltage on their grids. The modulation reactor was designed to maintain a fairly uniform impedance over the entire frequency range.

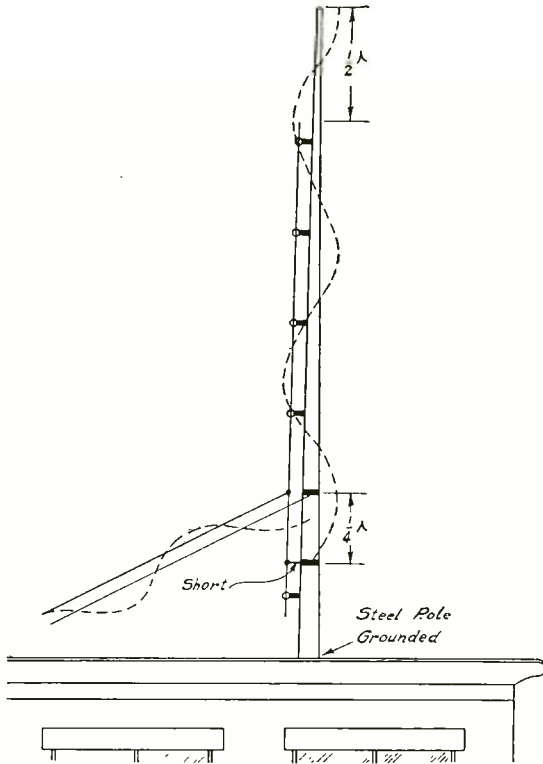

Fig. 16

To secure the greatest possible effective height of the transmitting antennas, a new type of structure was developed. Fig. 16 shows the general arrangement. A hollow steel pole forms

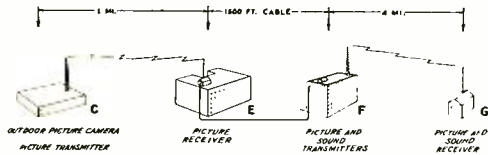

Fig. 17

the antenna and one side of the transmission line for conveying the signal to the upper end of the pole. The other side of the transmission line is a copper conductor spaced from the pole as shown. Power is supplied to the pole by a balanced transmis-

sion line tapped on to the pole and the copper wire a quarter wavelength about the point where the feeder wire is attached to the pole. By standing wave phenomena this arrangement effectively insulates the structure from ground as far as the operating frequency is concerned. The dotted lines indicate the voltage distribution on the system. This arrangement has the advantage of using a metal structure which may be either guyed or self-supporting, in which the top section only serves as the radiator, while the bottom is effectively grounded for strength and protection against lightning.



Fig. 18

To demonstrate the possibilities of taking a television camera to a point of interest such as a football game or other news event, and relaying the signals by radio to the central broadcast station for rebroadcast, an installation was made at a point approximately one mile from the main laboratory. The elements involved in this relay circuit are shown pictorially in Fig. 17. The camera installation at the remote pick-up point is represented at *C*. The radio transmitter connects this installation to *E* which is the radio receiver and amplifier for supplying signal to the cable connecting to the main transmitter at *F*. The final receiving station is represented at *G*. At the pick-up point *C* a complete transmitting installation was made. A view of the relay installation is shown in Fig. 18. It consists of a synchro-

nizing impulse generator, three racks of circuits, and a radio transmitter. The first rack is the video frequency amplifier, the second the monitor for checking the operation of the installation, and the third contains all the voltage supplies and circuits for the operation of the iconoscope. Fig. 19 is a front view of the thirty-watt crystal controlled transmitter used for transmitting the signal back to the laboratory. Directive V type antennas were used at both the transmitter and receiver of the relay circuit.

Operating the complete installation for a considerable time gave us much valuable and practical information. The installation involved all of the elements of a flexible and practical television system. Sources of program material were studio, motion picture film, relayed pictures from the Empire State Building in

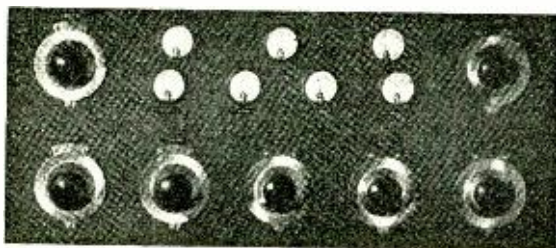

Fig. 19

New York, and remote pick-up of a street scene located a mile from the main control room. All signals were carried by cable a reasonable distance from the control room to the radio transmitter. Our principal problems were those concerned directly with terminal facilities. The radio transmitter was considered only as an element necessary in the testing of this equipment. However, as a result of the tests using such a wide band of modulation frequencies, it was found that the service area was definitely limited by the low power of the transmitter rather than by the height of the transmitting antenna. The development of a high power ultra-high-frequency transmitter capable of being modulated over a wide band of frequencies is now being carried forward.

The quality of the transmitted pictures may be judged by Figs. 20, 21, and 22. These are time exposure photographs of the picture on the kinescope in the monitoring rack in the main control room. Figs. 20 and 21 were each taken with sta-

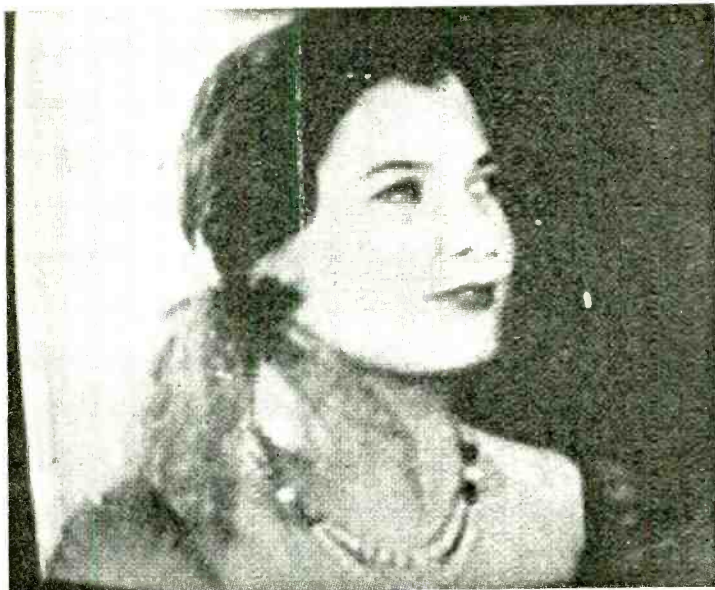

Fig. 20

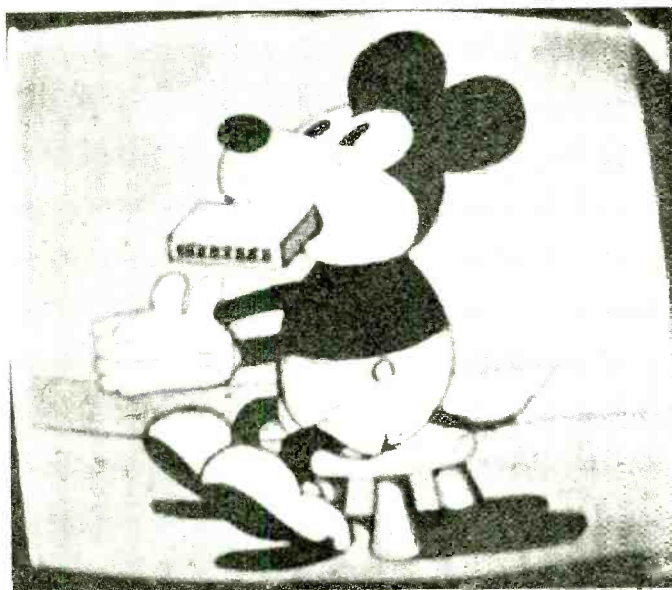

Fig. 21

tionary frames of moving picture film projected upon the iconoscope by a standard moving picture machine. Fig. 22 was taken with the studio camera pointed out the window and focused upon an adjacent street corner and buildings. The immediate foreground shows the court between two laboratory buildings and the upper background shows part of the Delaware River bridge.

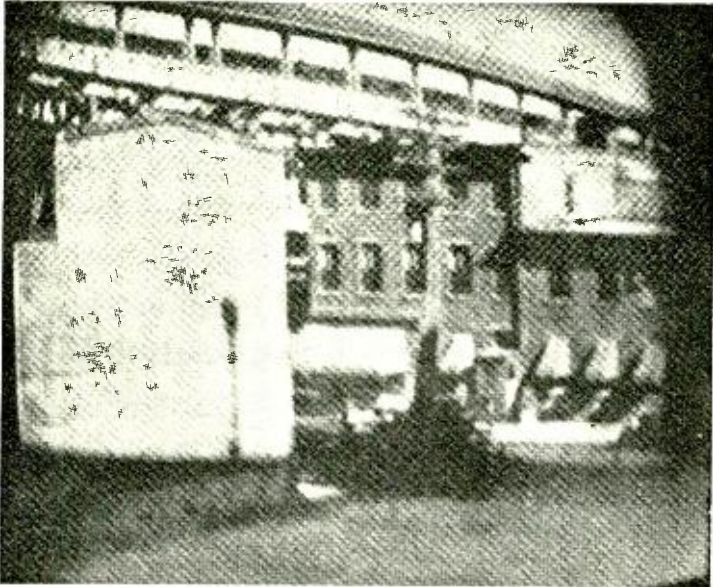

Fig. 22

These pictures do not reveal the well-known gain in apparent transmitted detail that occurs when moving subjects are televised. The line structure may be observed upon close examination, but it is not considered objectionable. Incidentally, the fact that the lines are distinguishable after a time exposure of a half minute is a tribute to the steadiness of the picture and the accuracy of the synchronization of the transmitter and receiver scanning patterns.

#### ACKNOWLEDGMENT

The authors express appreciation for the assistance of Messrs. J. Evans and J. P. Smith. Mr. Evans was responsible for the design and operation of all radio transmitters used in the tests. He also developed the special transmitting antenna described. Mr. Smith was responsible for the installation and operation of the outside pick-up.

# AN EXPERIMENTAL TELEVISION SYSTEM

BY

R. S. HOLMES, W. L. CARLSON, W. A. TOLSON

(RCA Victor Company, Inc., Camden, N. J.)

*Summary*—Several television receivers were built and operated as a part of the experimental television system set up in Camden during the early part of 1933. The receiver arrangements, including sound, picture, synchronizing, and deflecting circuits are described together with some of the factors influencing the design. The performance of the receivers is discussed and characteristic curves are given.

## PART III—THE RECEIVERS

### GENERAL

**I**N THE experimental television system set up and operated in Camden during the first part of 1933, tests were made to obtain, under practical operating conditions, a measure of the improvements made during the year that had elapsed since the previous tests made in New York City.<sup>1</sup> These advancements were reflected in the receiver design as improvement in performance, simplification of operation, more efficient apparatus arrangement, and the ability to reproduce images of greater detail—240 lines.

The receivers used for the previous tests in New York consisted of two separate superheterodyne receivers, independently tuned. This arrangement was entirely satisfactory for a preliminary experimental set-up, but in looking toward a more practical arrangement it was felt desirable to provide a receiver with only a single tuning adjustment which would control reception of both the sound and picture signals. This can be accomplished by combining the sound and picture transmissions in an orderly manner throughout the television band (40 to 80 megacycles).

One such system would be to transmit both the sound and picture signals on a single carrier by means of double modulation. This could be accomplished in a number of ways, but all

<sup>1</sup> E. W. Engstrom, "An experimental television system," Proc. I.R.E., vol. 21, no. 12, pp. 1652-1654; December, (1933).

Reprinted from Proceedings of the Institute of Radio Engineers.

are subject to the possibility of serious cross-talk in some portion of the circuit, either in the transmitter or in the receiver, and are inefficient in transmitter power utilization. A further disadvantage is that the transmission channel would be very wide, necessitating very wide band radio- and intermediate-frequency systems in the receiver, resulting in costly construction and difficulty in tuning.

Another transmission system permitting single dial tuning consists in systematically allocating the sound and picture carriers in the television band. One such allocation system would be to group all the sound carriers at one end of the television band and space the corresponding picture carriers in the same order over the remainder of the band. With this arrangement the tuning condensers of the two receivers could be geared together in the proper ratio and controlled by a single knob. The difficulty with this system is that numerous beats would be generated between the two oscillators and the incoming carriers. The elimination of these extraneous beat frequencies would result in serious complications in the design of receiver equipment.

Another system consists in alternating the sound and picture carriers throughout the television band, with each sound carrier adjacent to its accompanying picture carrier and spaced a fixed frequency away. A television channel then consists of a picture carrier and modulation plus an accompanying sound carrier and modulation. This system was chosen for the Camden set-up. One complete television channel was provided in Camden, with the picture transmitter operating at 49 megacycles and the sound transmitter operating at 50 megacycles.

The receiver had a single radio-frequency tuning system which consisted of two coupled radio-frequency circuits having sufficient band width to accept both carriers and their side bands simultaneously, and a heterodyne oscillator which beat with the two carriers to produce two intermediate frequencies one megacycle apart. The radio-frequency system tuned over the proposed television band of 40 to 80 megacycles. Two first detector tubes supplied the resulting intermediate frequencies to two separate intermediate amplifiers, which were tuned to 6 and 7 megacycles for the sound and picture signals, respectively. Since the sound intermediate amplifier was relatively sharp, it furnished a sharp reference for tuning the receiver, and assured that when the sound was tuned in, the picture signal was also properly tuned. No cross-talk occurred between the sound and



picture signals in the receiver since the signal level is low at the first detectors and the intermediate amplifiers are entirely separate.

The system of carrier spacing and the resulting receiver operation can be readily seen by reference to Fig. 1. In the upper part of the figure is shown the television channel with the sound carrier (*S*) and its side bands and the picture carrier (*P*) with its side bands. The probable location of the adjacent channel stations is also illustrated. In the lower part of the figure are shown the characteristics of the double intermediate amplifiers

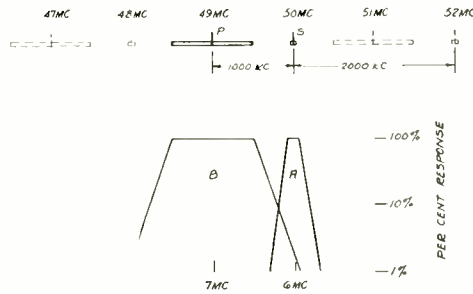

Fig. 1—Channel arrangement and receiver selectivity characteristic.

of the receiver, the sound intermediate selectivity characteristic *A* being relatively sharp, as it is required to pass only a relatively narrow band of frequencies, and the picture intermediate selectivity characteristic *B* being broad to pass a wide band of frequencies. The high-frequency transmissions indicated by the scale in the upper part of the figure have been converted into intermediate frequencies when referred to the receiver characteristics indicated by the companion scale in the lower part of the figure, but the channel frequency separation remains unchanged.

When the receiver is tuned in the normal manner so that the sound carrier *S* in terms of its intermediate frequency is properly tuned with respect to curve *A*, then the corresponding picture intermediate frequency is also correctly tuned in the center of curve *B*.

A guard band was provided between the edge of the picture selectivity curve and the accompanying sound carrier, and also an additional guard band to the proposed adjacent sound channel on the other side.

## ANTENNA

In the majority of locations where receivers were tested, an inside antenna approximately a half wavelength long was found to be satisfactory. In more remote or particularly bad locations, it was necessary to erect an outside antenna and connect it to the receiver by means of a transmission line. This antenna was usually of the Zeppelin type, with a half wavelength exposed. Satisfactory transmission lines were usually of the form of two wires spaced one or two inches apart. Directive antennas were used in some instances, and, as was expected, gave a better signal than nondirective antennas.

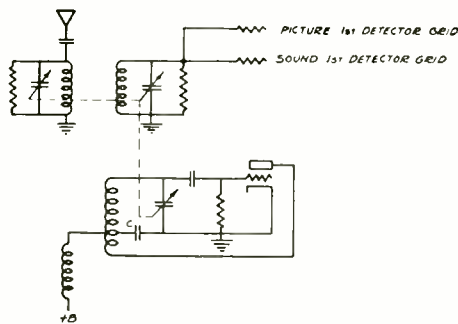

Fig. 2—Radio-frequency and oscillator system.

## RADIO-FREQUENCY CIRCUIT AND OSCILLATOR

The antenna was coupled to the first tuned circuit in the receiver by a small coupling capacitor. This method of coupling gave slightly better results than magnetic coupling between 40 and 80 megacycles, the frequency range of the receiver. The radio-frequency and oscillator system are shown in Fig. 2. From the antenna coupling capacitor, the signal was impressed on the high side of the first radio-frequency circuit. This circuit was coupled by a combination of capacitive, inductive, and conductive coupling to the second tuned circuit to which were connected the grids of the two first detector tubes in parallel. The coupling and loading of the radio-frequency circuits were adjusted so that the band width of the combination was substantially 1.5 megacycles over the tuning range of 40 to 80 megacycles. The gain from the antenna to the grids of the first detectors remained substantially constant over this band.

An RCA-56 tube was found to be satisfactory over the range when used in the oscillator circuit of Fig. 2. At the high-

frequency end of the range the circuit of the oscillator was essentially a straight feed-back circuit, on account of the high impedance of the tuning condenser compared to that of the padding capacitor  $C$ . As the capacity of the tuning condenser was increased, lowering the frequency, the ratio of these impedances decreased, thus effectively increasing the feed-back in the oscillator and maintaining a substantially uniform oscillation. The padding capacitor  $C$  also performed the usual function of properly aligning the oscillator and radio-frequency circuits over the 40- to 80-megacycle band. The oscillator operated at a higher frequency than the incoming carriers and heterodyned them to 6 and 7 megacycles. A combination of capacitive, inductive, and

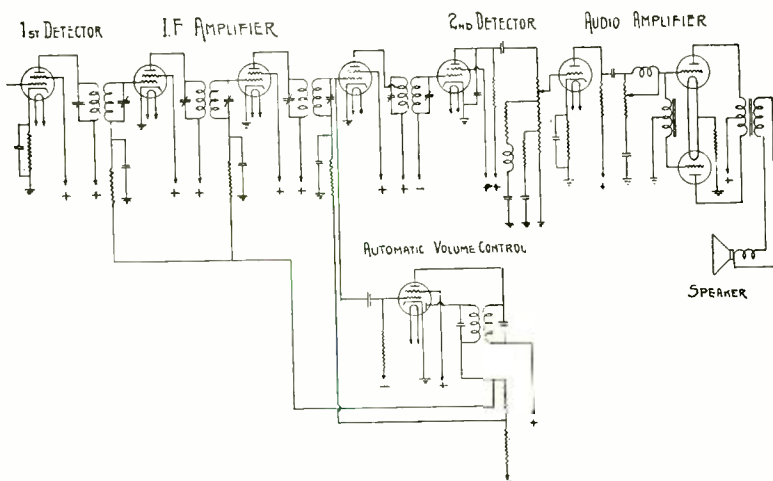

Fig. 3—Receiver sound channel.

conductive coupling between the oscillator and first detector circuit maintained a substantially uniform oscillator voltage on the first detector grids. The oscillator and the two radio-frequency circuits were all tuned by the variable gang condenser.

#### SOUND CHANNEL

A schematic diagram of the sound channel is shown in Fig. 3. The sound intermediate-frequency amplifier consisted of a first detector and three intermediate-frequency stages tuned to 6 megacycles, having an over-all gain from first to second detector grids of approximately 10,000 with a band width of 130 kilocycles at 90 per cent of the peak amplitude. It was sufficiently wide to allow for oscillator drift and permit easy tuning of the re-

ceiver. Extensive filtering was provided in the supply leads to the intermediate-frequency stages to prevent regeneration. An automatic volume control stage was incorporated in parallel with the last intermediate-frequency stage and controlled the bias on all three intermediate-frequency tubes, with full control on the first two and partial control on the last one. In this man-

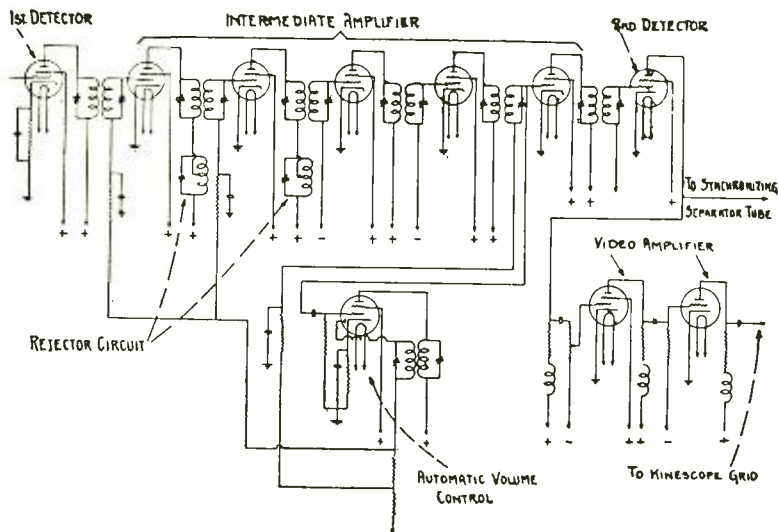

Fig. 4—Receiver picture channel.

ner, the signal on the grid of the second detector was maintained substantially constant for signals in excess of about 100 microvolts impressed on the antenna post.

With the wide spacing between carriers chosen for these tests, there was no serious problem of cross-talk or "monkey chatter" from the side bands of the picture transmitter such as is encountered in wide band broadcast receivers. The proposed spacing between adjacent television channels should also prevent any interference from this source. With the intermediate-frequency band width of 130 kilocycles, no side band cutting occurred in the intermediate-frequency system. Therefore, conditions were ideal for providing excellent high fidelity sound reception. Following the screen-grid second detector was a tone-compensated volume control. An audio amplifier with a band-pass tone control supplied the audio signal to push-pull 45's in the output stage. The loud speaker was a special high fidelity unit having good response to 8 kilocycles.

## PICTURE CHANNEL

- The schematic circuit of the picture channel is shown in Fig. 4. The picture intermediate-frequency amplifier consisted of

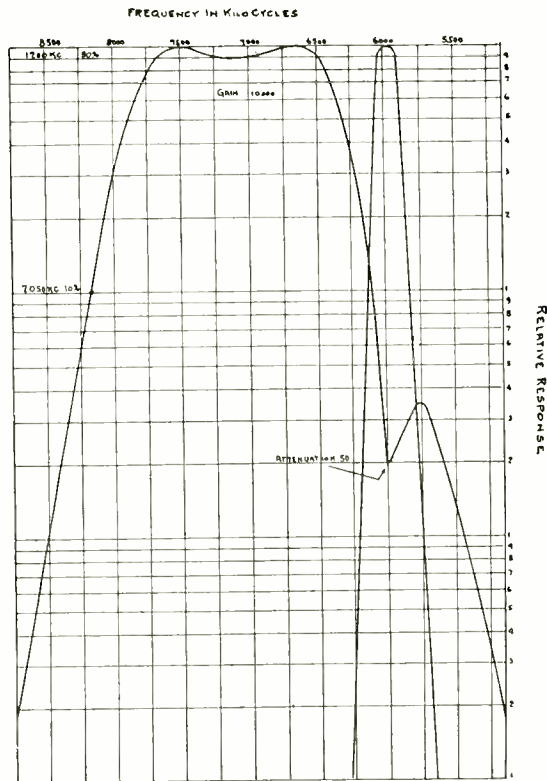

Fig. 5—Sound and picture intermediate-frequency characteristics.

five stages tuned to 7 megacycles, having an over-all gain of approximately 10,000 and a band width of 1200 kilocycles at 90 per cent of maximum amplitude. This characteristic is shown in Fig. 5. (This figure also shows the sound intermediate-frequency characteristic.) The number of intermediate-frequency stages chosen for the picture intermediate amplifier was determined by the intermediate-frequency gain and band width required, and was not determined on the basis of required selectivity. The six band-pass transformers in the amplifier did not of themselves furnish sufficient selectivity to prevent cross-talk from the sound signals into the picture channel. In order to increase the attenuation, rejector circuits tuned to the sound frequency were coupled to the second and third picture inter-

mediate transformers. The net attenuation at 6 megacycles compared to 7 megacycles was about 50, which, combined with the cut-off of the video amplifier, effectively eliminated any interference on the picture due to the sound signal. The wide band-pass characteristic in the picture intermediate-frequency stages was obtained by winding the transformers with resistance wire and adjusting the coupling between the primary and secondary windings to give a flat-topped response. Extensive filtering was provided in the supply leads to prevent any possible regeneration due to common coupling through the supply circuits.

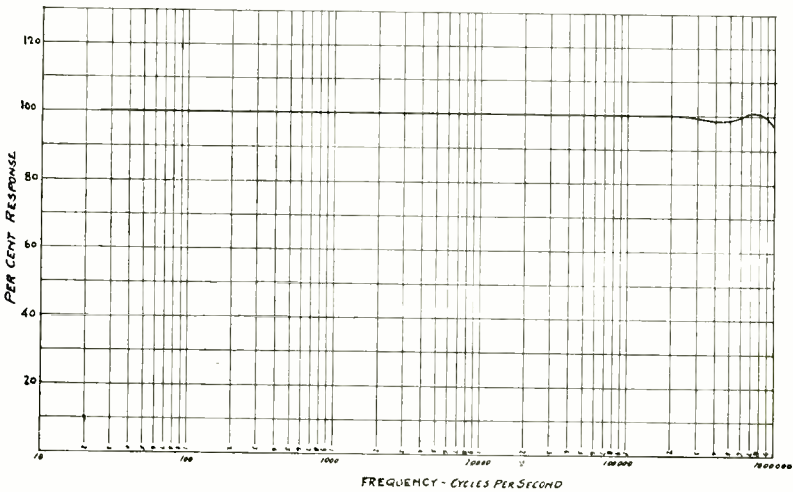

Fig. 6—Receiver video amplifier characteristics.

An automatic volume control stage in parallel with the last intermediate-frequency stage controlled the bias on the first two and last intermediate-frequency tubes to maintain the signal on the second detector grid constant when the signal on the antenna post of the receiver exceeded approximately 100 microvolts.

Following the second detector, the video signal was applied to the video amplifier, whose frequency characteristic is shown in Fig. 6, and to the synchronizing separating circuit. The output of the video amplifier was applied to the grid of the kinescope.

### SYNCHRONIZATION

In order to reproduce the picture represented by the received signals, it is necessary that the scanning point on the mosaic of the iconoscope and the scanning point on the kinescope be main-

tained in synchronism. A random variation of synchronization at the receiver, corresponding to the linear equivalent of one picture element, will result in a loss of 50 per cent of the normal resolving power. This made it imperative that the synchronizing signals be separated in such a manner that integration would not seriously distort the wave fronts of the synchronizing signals. If it is assumed that such distortion shall be less than one-half picture element, the variation in timing of adjacent synchronizing signals, due to integration of video or extraneous

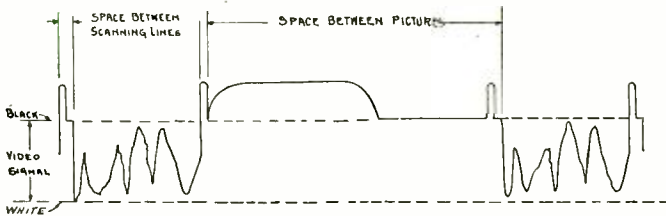

Fig. 7—Composite signal as received.

signals, must be less than 0.5 microsecond for horizontal synchronizing signals and 800 microseconds for vertical synchronizing signals, approximately. It was found that with the signal-separating methods employed in these receivers, such a condition was obtainable under normal operating conditions.



Fig. 8—Received signal after removal of video component.

Fig. 7 shows a section of the received signal voltage wave taken over a period of time equivalent to that of four scanning lines. The section is taken at the bottom of the picture in order to include the vertical synchronizing impulse. It should be noted that the horizontal synchronizing impulses are superimposed upon the "black" signal between scanning lines, and the vertical impulse is superimposed upon the "black" signal between pictures. The fact that the video signal cannot go beyond the "black" amplitude assures that the video signals will not interfere with the synchronizing action. The circuit and operating characteristics of the arrangement used for removing the video component from the incoming signal are shown in Figs. 9 and 10, respectively. Referring to Fig. 9, it should be noted that

the bias battery potential is such as to make the grid of the tube positive with respect to its cathode. The positive potential of the grid is limited by the presence of  $R_2$  in series with this circuit.  $R_2$  is made very large with respect to the grid-cathode

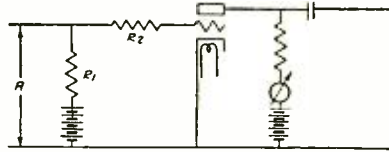

Fig. 9—Circuit for removal of video component from composite signal.

resistance for positive values of grid potentials. Thus, for all values of positive potential applied at  $A$ , substantially all the voltage appears across  $R_2$  rather than across the grid-cathode circuit. For all values of negative potential at  $A$  in excess of

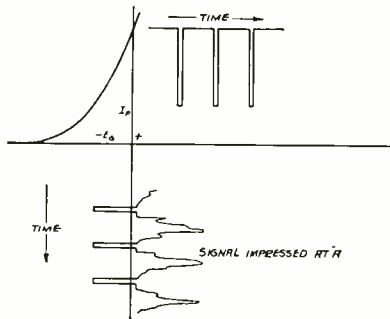

Fig. 10—Operating characteristic of circuit for removal of video component from composite signal.

the positive bias potential, the grid is negative with respect to its cathode, and the resistance is very high compared with  $R_2$ ; thus the effect of the series resistance is negligible. The net effect of such a response characteristic is shown by comparison of Fig. 7 with Fig. 8, which shows the signal after the video component has been removed.

Due to the wide divergence between the time constants of the horizontal and vertical synchronizing signals, either may be removed from the composite synchronizing signal by means of very simple frequency selective circuits. Figs. 11 and 12 show the circuit and characteristics of the arrangement utilized for separating the horizontal and vertical synchronizing signals and confining them to their respective channels, while Fig. 13 shows the horizontal and vertical signals after separation. The hori-



zontal and vertical synchronizing signals were then applied, respectively, to the horizontal and vertical deflection oscillators.

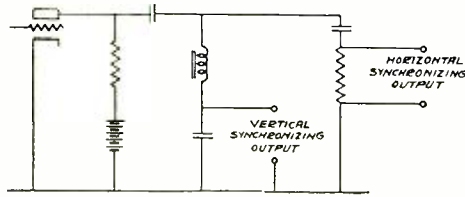

Fig. 11—Circuit for separation of vertical and horizontal synchronizing signals.

### DEFLECTING CIRCUITS

#### General

The oscillator used for producing a voltage of saw-tooth wave form must, in general, meet three fairly definite requirements.

A - RESPONSE OF VERTICAL SYNCHRONIZING OUTPUT CIRCUIT  
 B - RESPONSE OF HORIZONTAL SYNCHRONIZING OUTPUT CIRCUIT

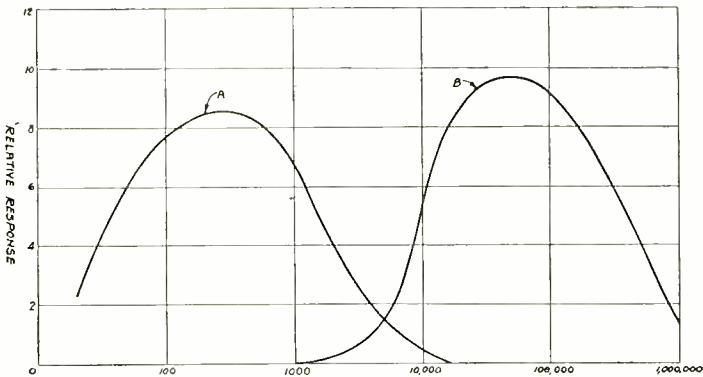

Fig. 12—Response characteristics of circuit shown in Fig. 11.

It must produce an output having a sharply peaked wave form. For horizontal deflection the ratio of the duration of the peak to

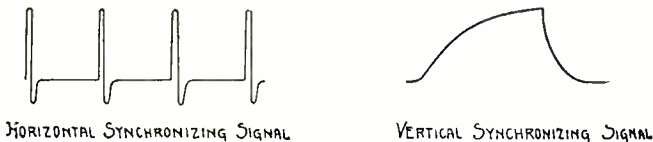

Fig. 13—Synchronizing signals after passing through separating circuit.

the time for a complete cycle should not be greater than 1:15. For vertical deflection this ratio should not be greater than 1:80.

As an alternative to this requirement, the oscillator may produce an output having a wave front sufficiently steep so that impulses having the required characteristic can be secured through the use of high-pass circuits. Fig. 14 shows the output voltage wave of a special dynatron circuit, together with the wave shape resulting from the use of a high-pass coupling circuit to the next tube. The second requirement of an oscillator for deflection purposes is that it must be capable of synchronization over the range of free-oscillating frequencies covered by the "drift" of the oscillator under operating conditions. The

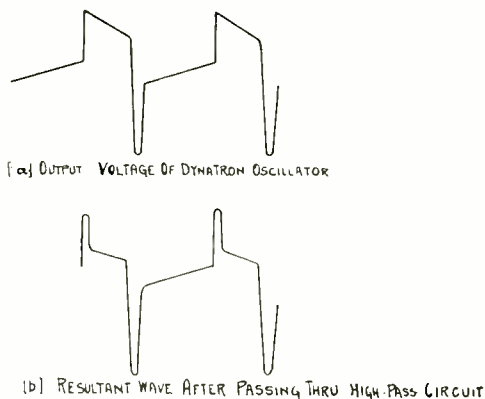

Fig. 14—Voltage wave shapes obtainable with dynatron oscillator.

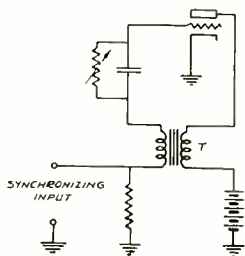

Fig. 15—The blocking oscillator.

third requirement for a deflection oscillator is that the drift of the free-oscillating frequency shall be small. The reason for this requirement is apparent, since it minimizes the difficulties encountered in synchronization. An oscillator known as a blocking oscillator was chosen as most satisfactorily meeting all the above requirements.

The blocking oscillator is similar in circuit to, but having constants differing from, a conventional inductively coupled

sine wave oscillator. A typical circuit is shown in Fig. 15. The coupling, damping, grid condenser, and grid leak are so proportioned that the grid current drawn during the positive portion of the grid voltage wave is sufficient to build up a negative voltage across the grid condenser greater than the value required for plate current cut-off. This action is shown by the graphs of grid-circuit potentials shown in Fig. 16. At the conclusion of one cycle of oscillation at the natural period of the transformer *T*, the circuit is maintained in an inoperative condition, by virtue of the high negative grid bias, until the charge

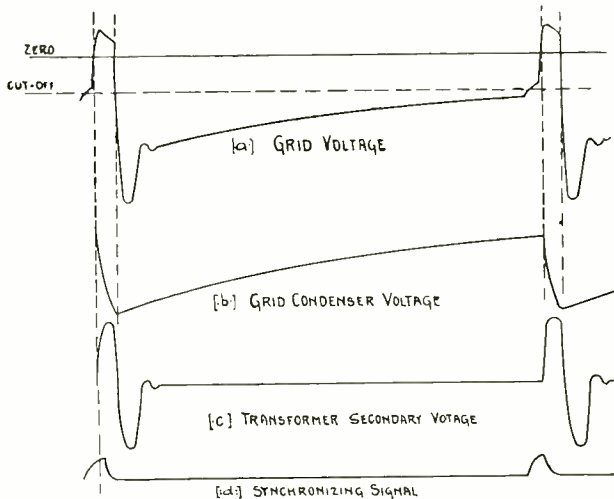

Fig. 16—Blocking oscillator circuit voltage.

on the grid condenser is dissipated by the grid leak to the point where the grid potential is just sufficient to allow plate current to flow. At this point the above cycle of operation repeats itself. The next cycle may be initiated at any time before this point is reached, by applying to the grid a positive impulse of sufficient amplitude to cause plate current to flow. This function is normally performed by the synchronizing impulse, as shown by (d) of Fig. 16.

#### VERTICAL DEFLECTING CIRCUIT

The choice between the use of magnetic and static fields for deflection of the cathode ray beam in the vertical direction is made relatively simple by virtue of the fact that the fundamental frequency is very low (24 per second), thus presenting a minimum of difficulty in passing a current of saw-tooth wave form through a comparatively large inductance. The fact that a

highly inductive deflecting coil may be employed permits the use of a low voltage, low current output tube, whereas the voltage requirements for static deflection are not reduced by the low operating frequency. For static deflection, the impedance and phase-shift requirements considerably complicate the design of a suitable output transformer and make necessary the use of a low impedance output tube. A consideration of the foregoing indicated the use of magnetic deflection in the vertical direction as being best suited to the purposes of the tests to be made.

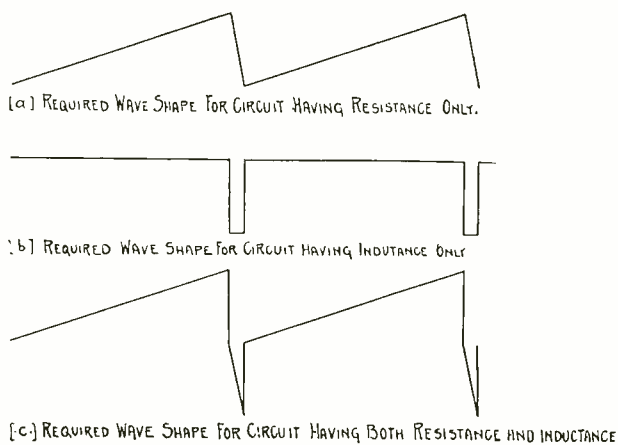

Fig. 17—Wave shape required to force a saw-tooth current wave through resistive and inductive circuits.

Fig. 17 shows the voltage wave shape required to produce a saw-tooth wave form of current through a pure resistance, a pure inductance, and a circuit containing both resistance and inductance. Such a required voltage wave may be produced in a very simple circuit, as shown by Fig. 18. Condenser  $C$  is charged in series with resistor  $r$  at a substantially constant rate through resistor  $R$ . The periodic positive impulses from the blocking oscillator are applied to the grid circuit of the discharge tube, the plate circuit of which is connected across the charging source and resistor  $R$ . The discharge tube thus periodically discharges  $C$  by a definite amount. The voltage wave across  $C$  is saw-tooth in shape, while that across  $r$  is a pure impulse. It is evident that by properly proportioning  $C$  and  $r$ , it is possible to produce a voltage wave shape having the required amount of saw-tooth and impulse components to force a saw-tooth of current through any given combination of output tube and deflecting coils.

The design of a suitable structure for the application of a

magnetic deflecting field to a cathode ray tube is influenced by several considerations. Assuming that a linear saw-tooth wave form of flux is produced normal to the axis of the cathode ray beam, a linear saw-tooth deflection of the beam will result only if the flux field is of constant density throughout the range of movement of the beam. A second effect of nonuniform flux dis-

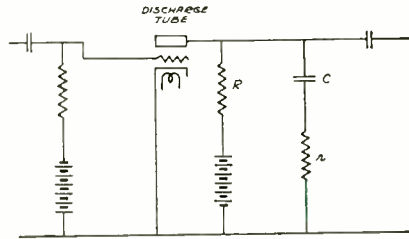

Fig. 18—Circuit for producing a composite wave having saw-tooth and impulse components.

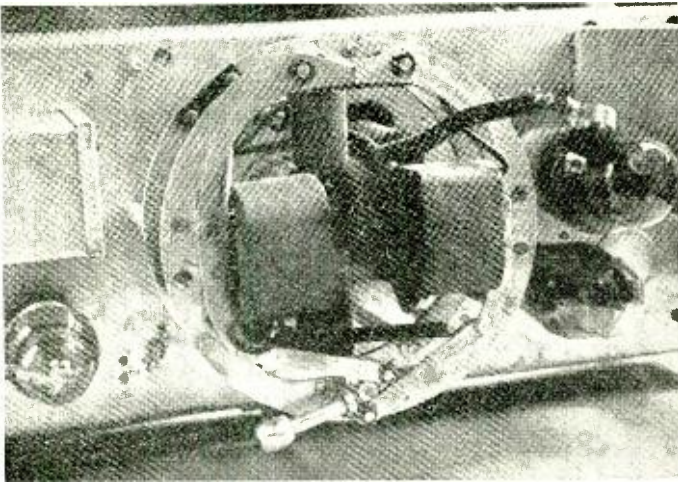

Fig. 19

tribution is defocusing due to the finite size of the beam at the point of deflection. It is obvious that a nonuniform distribution of flux will produce deflection of the electrons by an amount depending upon the flux density at each point in the cross section of the beam, thus resulting in a partial destruction of the focus on the fluorescent screen. Components of the deflecting flux which act along the path of the beam in a direction parallel to the motion of the electrons also produce defocusing, since such

components constitute a focusing field varying in accordance with the instantaneous density of the deflecting field. Such considerations imposed limitations on the design of the magnetic deflecting structure and resulted in the adoption of a form which differs markedly from one based entirely upon considerations of magnetic efficiency alone. The magnetic yoke employed in the receiver is shown by Fig. 19.

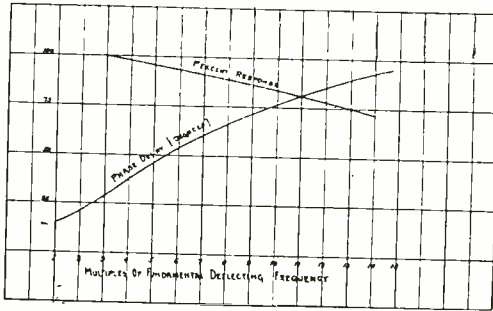

Fig. 20—Response and phase delay characteristics of horizontal deflecting circuit.

#### HORIZONTAL DEFLECTING CIRCUIT

The choice between magnetic and static fields for horizontal (5760 cycles) deflection is somewhat more involved than in the case of vertical deflection. In the case of magnetic deflection, the voltage across the deflecting coils involved in producing a saw-tooth current wave increases directly as the scanning frequency. For frequencies of the order of 6000 cycles the required voltage peaks are so high as to be destructive unless the circuit design is such as to minimize the voltage requirements. The voltage may be reduced by reducing the inductance of the deflecting coils, with a corresponding increase in the current requirements. The current limits are set by the output tube used. A secondary problem is presented by the interaction between the fluxes in the vertical and horizontal deflecting yokes. The most serious results of such interaction are distortion of the scanning field and defocusing of the scanning spot. In the case of static deflection, the voltage requirements are not affected by the scanning frequency, but the required frequency band to be passed by the output transformer increases directly as the scanning frequency. From an economic standpoint there are factors favoring either system, but from the standpoint of sharpness of focus and minimum distortion of the scanning pattern, better results were obtained with static deflection in the horizontal direction. The

design of the output transformer for application of deflection potential to the static deflecting plates is limited by several considerations. Chief among these are the alternating-current potential required across the deflecting plates of the kinescope, the voltage available on the plate of the output tube, and the required frequency vs. response and frequency vs. phase characteristics. Fig. 20 shows the response and phase characteristics of the horizontal deflecting circuit which produced a deflection having a maximum variation in scanning velocity of 5 per cent and a scanning to return ratio of 13:1.

The oscillator and discharge tube circuits were diagrammatically the same for the horizontal and vertical deflecting

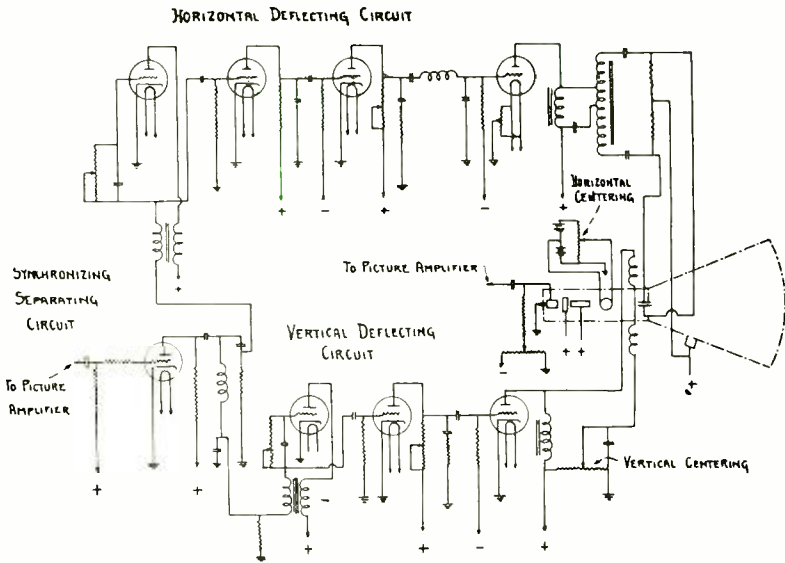

Fig. 21—Schematic arrangement of kinescope deflecting circuit.

circuits. The circuit constants were, of course, proportioned to the widely different frequencies at which they operated. The complete deflecting arrangement is shown schematically by Fig. 21.

The exact position of the scanning pattern on the end of the kinescope is affected to a minor extent by the mechanical line-up of the electron gun, by a permanent magnetization of deflecting structures or other magnetic materials near by, and by the magnetic field of the earth. In order to insure the exact location of the scanning pattern in the viewing aperture, means were

provided for adjusting the position of the scanning pattern in both the vertical and horizontal directions. For centering in the vertical plane a bridge arrangement was used whereby a small amount of direct current could be passed through the vertical deflecting coils in either direction. For centering in the horizontal plane an arrangement similar to that employed for vertical centering was used, except that it was entirely independent of the horizontal deflecting circuit. Both arrangements are shown in Fig. 21.

### RECEIVER CONTROLS

On account of the system used for transmission of sound and picture on carriers spaced one megacycle apart and the double intermediate amplifier in the receiver, only a single tuning control was necessary, so that tuning the receiver was no more difficult than tuning a standard broadcast receiver. The major controls located on the front of the cabinet were tuning, sound volume, sound tone, picture brightness, and picture contrast. These were the controls it might be necessary to adjust when tuning from one station to another. Another group of controls which required less frequent adjustment were arranged under the lid of the cabinet. These were focus, deflecting oscillator frequency controls, and scanning pattern size and centering. Screw driver adjustments were provided inside the receiver for scanning pattern distribution and kinescope screen-grid voltage. These adjustments needed to be changed only when the receiver was set up for operation.

### GENERAL ARRANGEMENT OF THE RECEIVER

The general arrangement of the receiver is shown on Figs. 22 and 23. The parts were assembled on three units. All the radio-frequency and intermediate-frequency circuits and the video and audio amplifier were mounted on the receiver chassis, Fig. 24 and 25. The tuning capacitor was in the center, with the sound channel on one side and the picture channel on the other. The deflecting circuits were on another chassis mounted below the receiver chassis. The kinescope was mounted from this chassis inside a steel shield extending up through the receiver chassis. The picture was viewed by means of a mirror mounted in the adjustable lid of the cabinet. The power supply unit was mounted in the bottom of the cabinet. The rectifiers on this unit supplied 250 volts to the receiver and kinescope chassis and first and



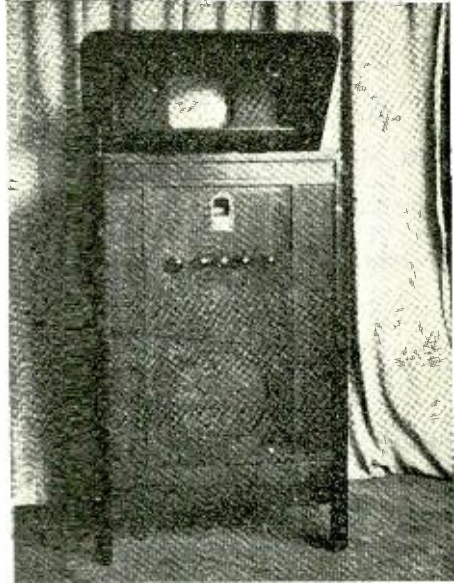

Fig. 22



Fig. 23

second anode supply to the kinescope. The second anode voltage on the kinescope was 4600 volts, and the spot was focused by means of the adjustable first anode supply.

#### OBSERVATIONS ON THE PERFORMANCE OF THE RECEIVERS

No evidence of natural fading of signals in the frequency band of 40 to 80 megacycles was noted, but considerable variation in the signal applied to the receiver was encountered in most locations. These variations were usually attributed to changes

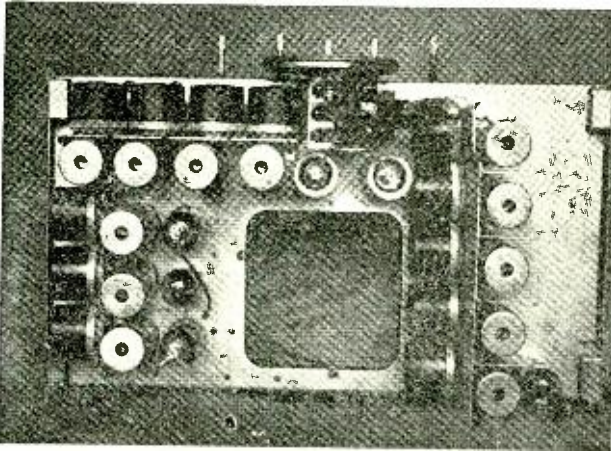

Fig. 24

in the pick-up system, such as swinging antenna or transmission line or movement of conductors in their vicinity. These fluctuations were entirely overcome by the automatic volume controls in the receiver, either on windy days when the outside antenna was swinging considerably, or when people walked near an inside antenna and changed the standing wave patterns.

The sensitivity of the receivers was approximately 100 microvolts for both the sound and picture channels. However, a signal of 100 microvolts did not provide satisfactory operation of the picture channel, on account of the presence of random electrical variations usually referred to as "hiss" being present. This "hiss" disturbance limited the minimum satisfactory signal to about 1000 microvolts. The sound side gave a satisfactory signal on less than 1000 microvolts. The amount of "hiss" or other interference that can be tolerated in the picture signal is greater than would be expected compared to that of the sound signal, when considered on the basis of their respective band widths.

This was also noted on previous tests of a television system by Beers.<sup>2</sup> The most serious source of external interference was the ignition systems of airplanes. Interference was also created by automobiles driven within a hundred feet or so of the receiving antenna. These interferences were less troublesome than would be expected on the picture as compared to the sound, considering the great difference in band width.

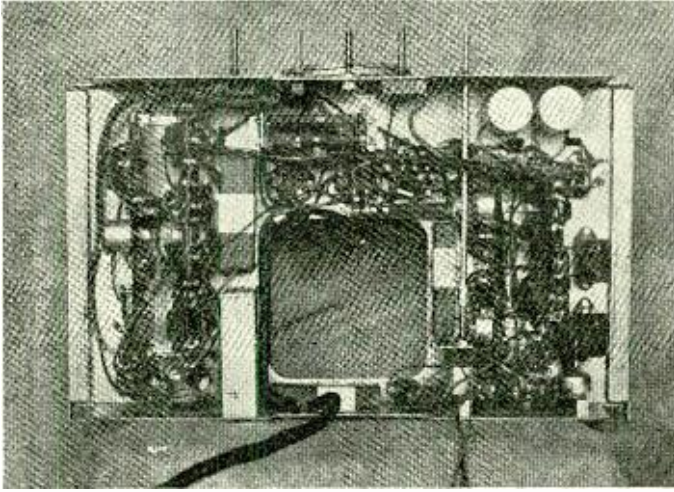

Fig. 25

In general the results of the tests were gratifying. Even when the program material originated in New York City and was relayed twice, interference and other difficulties were not serious. In all the tests the performance of the apparatus was up to expectations, and the reproduced picture and sound were satisfactory and had entertainment value.

#### ACKNOWLEDGMENT

The authors acknowledge the assistance of Messrs. H. C. Allen, C. D. Kentner, W. J. Poch, A. H. Turner, and M. Flaherty in the development and design of the circuits and receivers for this experimental television system.

<sup>2</sup> G. L. Beers, "Description of experimental television receivers," *PROC. I.R.E.*, vol. 21, no. 12, pp. 1692-1706; December, (1933).

# AN EXPERIMENTAL TELEVISION SYSTEM

BY

CHARLES J. YOUNG

(RCA Victor Company, Inc., Camden, N. J.)

*Summary*—A radio relay circuit is described for carrying 120-line television programs from a studio in New York to a broadcast station in Camden, New Jersey. Details of the actual relay station used are given as well as the characteristics of directive antennas especially designed for this service. The completed system satisfactorily relayed television pictures over this 86-mile distance.

The project was carried out jointly by the following companies: RCA Communications, Inc., RCA Victor Company, Inc., National Broadcasting Company, Inc., General Electric Company, Inc., and the Westinghouse Electric and Manufacturing Company.

## PART IV—THE RADIO RELAY LINK FOR TELEVISION SIGNALS

**I**N THE early part of 1933 an experimental television system was placed in operation in Camden. As a part of this system it was felt very desirable that engineering information be obtained bearing on the problem of networking television stations.

The history of sound broadcasting has shown the importance of such interconnection. With television it is likely, for economic reasons, that a networked system may prove to be even more essential. At the same time the technical difficulties are multiplied enormously with the increase in channel width required, from a frequency band of 7000 cycles for good sound to a band of over 200 kilocycles for a 120-line television picture.

There are several possible methods of distributing television programs. In this country, and in Europe, it has been proposed to syndicate television programs by airplane delivery of movie films, but this is not attractive for many reasons. The two important possibilities remaining are a special wide channel wire line with the necessary repeaters, or a radio system with relay-stations. The latter was chosen for this project.

The starting point of the relay channel was the 44-megacycle transmitter on the Empire State Building in New York City.

Reprinted from Proceedings of the Institute of Radio Engineers.

The object was to relay the television signals radiated from there to Camden where they might be rebroadcast. The video frequency band which had to be transmitted was determined as 210 kilocycles for the 120-line picture, and the length of the circuit was 86 miles air line. Preliminary study of profile maps showed that while two intermediate relay stations might be required, there was a possibility of using only one. The Empire State antenna was some 1250 feet above sea level, and there were nine hills between there and Camden almost high enough to "see" it and at the same time give promise of placing a good signal in Camden.

To fix definitely upon a site for the relay station, a field strength survey was made at each of these possible locations. The equipment used consisted of a semiportable receiver, the sensitivity of which had been determined, and approximately calibrated in microvolts per meter. It was used with a vertical half-wave antenna which could be raised on a pole some eighteen feet above ground. This apparatus was easily carried about by automobile and served its purpose very well.

During the period of the survey, test transmissions were made both from the Empire State Building, on 44 and 61 megacycles, and from Camden on 44 megacycles. The field strength observed on these transmissions showed at once that there were only two possible locations for the relay station, and that the best one was undoubtedly Arney's Mount, a few miles east of Mt. Holly, N. J. The summit of this isolated hill is 230 feet above sea level; high enough to give line of sight to the receiving point 23 miles distant at Camden, and only about 200 feet below line of sight from the New York antenna, 63 miles distant. This unequal division of the total relaying distance was justified for several reasons: first, the great height of the 44-megacycle antenna in New York; next the fact that the second lap of the relay was to be carried on 79 megacycles, which would probably require a direct optical path; and finally because a strong signal would be needed in Camden to override severe induction interference from the factories there.

As a final confirmation of the choice of Arney's Mount, an experimental television receiver<sup>1</sup> was set up there and picture transmissions observed alternately from New York and Camden. The pictures were fair and it was calculated that they would be entirely satisfactory when antennas of considerable height or

<sup>1</sup> G. L. Beers, "Description of experimental television receivers," *PROC. I.R.E.*, vol. 21, pp. 1692-1706; December, (1933).

directivity, or both, had been erected. It will be noted that in all of the survey work the observations on the second lap of the circuit were made at Arney's Mount on transmissions from Camden. It was assumed that these data would apply to transmission in the reverse direction, and it was much more practical to set up a receiver at Arney's Mount than a test transmitter.

The general plan for erection of antennas at the station was worked out before starting construction. Additional signal strength was needed to insure reliable reception from New York. The practical question was whether to obtain this by an extensive highly directive antenna near the ground, or by a small antenna high up on a tower. It was answered in favor of the tower by an observation of the vertical distribution of field strength over the location, made in an autogyro and previously reported in these PROCEEDINGS.<sup>2</sup> These measurements were confirmed by others which had been independently made in an airplane at comparable distances over Long Island.<sup>3</sup> Apparently there was no abrupt change in signal strength as one fell below line of sight, and in this region the signal strength was roughly proportional to the elevation of the receiving antenna above ground. This generalization is, of course, subject to many rapid fluctuations in signal with altitude due to reflections from the ground surface along the transmission path. These were observed sufficiently to make certain that the final antennas were not at a minimum of field strength.

The relay station, as built on Arney's Mount, included a 165-foot steel tower, a 20-foot square steel building housing the apparatus, and three wooden poles supporting the transmitting antenna directed on Camden. There was just room enough on top of the wooded sand hill for the three structures, and the slope fell rapidly away on all sides from the 230-foot elevation of the summit to the normal ground level, which is about 100 feet above sea level in this vicinity.

The steel building was divided into two rooms, one for the receiver and one for the transmitter. The latter was double shielded with copper, and filters were provided for all circuits passing through the partition, as well as for the incoming underground power cable. These precautions made it possible to locate the receiver, which worked on the relatively weak 44-

<sup>2</sup> L. F. Jones, "A study of the propagation of wavelengths between three and eight meters," *PROC. I.R.E.*, vol. 21, pp. 349-386; March, (1933).

<sup>3</sup> Bertram Trevor and P. S. Carter, "Notes on propagation of waves below ten meters in length," *PROC. I.R.E.*, vol. 21, pp. 387-426; March, (1933).

megacycle signals from New York, in the same building with the relay transmitter. The power of this relay transmitter had been set at 100 watts as this was felt to be reasonable for the experimental study of the system.

The block diagram of Fig. 1 shows the equipment installed at the relay station. The receiving antenna consisted of three vertical dipoles, connected in proper phase and feeding a 450-ohm two-wire transmission line. The upper dipole was mounted on the top of the 165-foot steel tower and a reflector was placed behind it. The other two were without reflectors and were placed

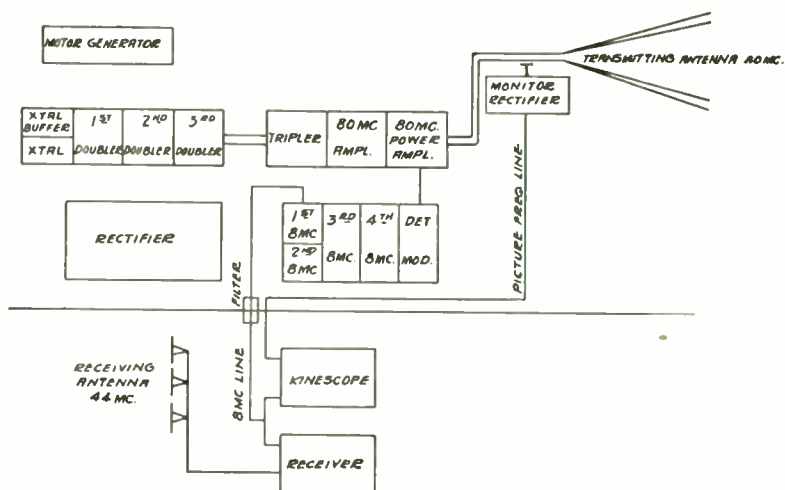

Fig. 1—Block diagram of relay station at Arney's Mount.

in a vertical line beneath. It is interesting to note that the top-most point of this antenna array lay only 35 feet below the line of sight from the New York antenna.

The receiver was a specially designed superheterodyne. The intermediate frequency was 8 megacycles and the circuits were adjusted to give the maximum sensitivity consistent with the necessary total band width of 420 kilocycles. There was no second detector and the output was delivered at 8-megacycles into a 500-ohm concentric tube transmission line. The over-all sensitivity of the receiving system is indicated by the fact that one volt of signal was measured at the output with the antenna system exposed to an estimated field strength of 200 microvolts per meter.

The 8-megacycle receiver output was carried by the transmission line through a 20-megacycle low-pass filter into the

transmitter room. Here it was further amplified by four stages operating in push-pull class B, the circuits being tuned and damped to give the necessary band width. The high level thus obtained excited a pair of tubes acting as a combined high power detector and modulator. In the plate circuit of this modulator an undistorted power of 200 watts at video frequency was obtained, and this was sufficient to modulate 100 per cent the power amplifier in the transmitter.

The modulator tubes were biased somewhat beyond cut-off and were operated so as to give linear detection of the 8-megacycle intermediate frequency. Thus, in the entire receiving and relaying system, there was only this one stage carrying video frequency signal. Therefore the problem of maintaining good frequency characteristic and reducing phase distortion was greatly simplified. There was only one video frequency circuit to be considered in addition to such distortion as might occur in the radio circuits. The measured total phase shift of the transmitter was a constant  $2\frac{1}{2}$  microseconds over the band used.

This method of direct transfer of modulation from one carrier to another in a single stage has the characteristic of inverting the modulation on the second carrier. In other words a positive peak on the first carrier becomes a negative on the second. This, of course, is no handicap in a relaying system, but would make it undesirable as a general method of modulation.

The radio-frequency circuits of the transmitter were more orthodox. The original crystal frequency was 3.3 megacycles and this was amplified and multiplied by a crystal buffer stage, first doubler, second doubler, third doubler, a tripler, an 80-megacycle amplifier, and a final 80-megacycle power amplifier. Some precautions were necessary in plate circuits of the power amplifier to reduce the capacity of the parts to ground and permit the wide band of modulation. The output was inductively coupled to a two-wire transmission line which passed out of the building and up the adjacent 70-foot pole to the transmitting antenna. Direct-current filament power and bias voltages for the transmitter were supplied by a motor generator and plate voltages by a 3000-volt rectifier. The proper operation of this transmitting system was due largely to the efforts of W. H. Nelson of the General Electric Company.

Another essential part of the relay installation was a kinescope used for monitoring purposes. This, by means of transfer switching, could be connected either to the receiver or to a recti-



fier coupled to the sending antenna. Thus a direct comparison was possible between the received and the relayed pictures.

For the link from Arney's Mount to Camden, horizontally polarized waves were used. They proved to have a real advantage when it came to receiving at Camden, as the horizontal type receiving antenna was noticeably less susceptible to pick-up of interfering electrical noise. The radiating antenna erected at Arney's Mount was designed by P. S. Carter of RCA Communications, Inc., to have a power directivity of 18 to 1 as compared

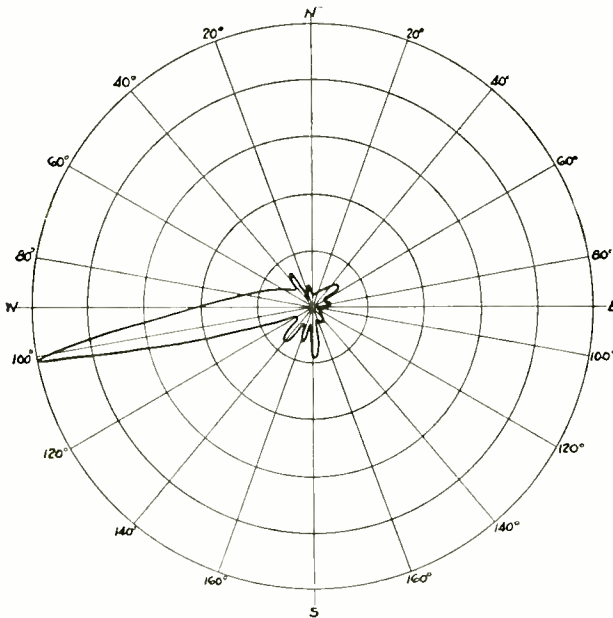

Fig. 2—Directivity of Arney's Mount transmitting antenna. Plane flying at 600 feet altitude in a circle 4.2 miles in diameter.

with a single dipole. It was supported on three 70-foot wood poles and consisted of four wires, each 16 wavelengths or about 200 feet long. These wires formed two flat V's having a common apex and with the bisector of their open angle pointed westward toward Camden. The wires of the upper V were horizontal while those of the lower V were directly under them but sloping downward as the sides of the V spread apart. As indicated in Fig. 1, the transmission line was connected at the apex, one wire to the right sides of both V's and the other wire to the left sides. When the angles of this antenna structure are properly chosen, both horizontal and vertical concentration of the radiation is obtained.

Also the system is sharply resonant to the chosen frequency and it was found desirable to add resistance loading at the extremity of each wire, in order to broaden the tuning sufficiently for the wide transmission band. This loading had the added advantage of reducing unwanted radiation in the reverse direction.

Directivity measurements made on this antenna are shown in Figs. 2, 3, and 4. These measurements, as well as those made

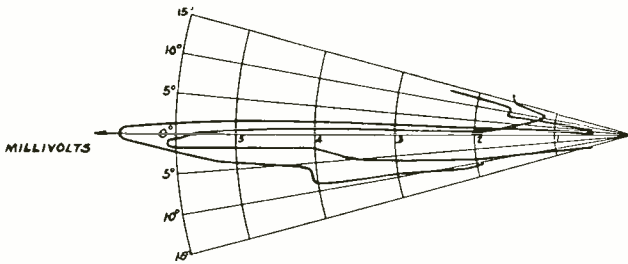

Fig. 3—Directivity of Arney's Mount transmitting antenna, plane flying at 700 feet altitude, 11.5 miles distant.

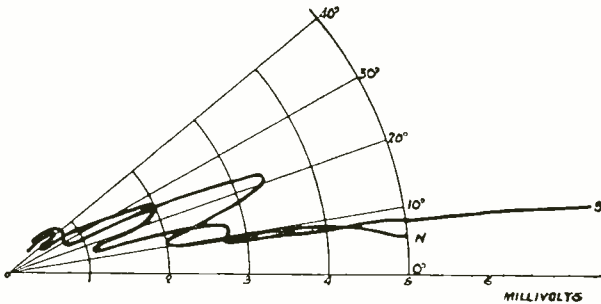

Fig. 4—Signal intensity vs. angle to horizon for Arney's Mount transmitting antenna. Data taken over a point one mile distant.

at Camden, and many of the field strength surveys, were carried through by Bertram Trevor of R. C. A. Communications, Inc. Fig. 2 was obtained by placing a field strength set in an airplane and flying in a circle around the antenna. In this case the radius of the circle was 4.2 miles and the altitude of the airplane 600 feet above the antenna. Fig. 3 shows a similar curve made by flying back and forth across the beam at a distance of 11.5 miles. In this case, while flying at an altitude of 700 feet, the conditions were quite variable and the two curves show two successive runs. It is clear from Figs. 2 and 3 that good directivity was obtained in this antenna, the beam being about 10 degrees wide at 50 per cent of its maximum value.

In order to determine the vertical directivity of the antenna, flights were made back and forth across the beam at a distance of one mile from the transmitter and at altitudes up to 5000 feet. The results are shown in Fig. 4. The curves are very irregular due to interferences of reflections. Nevertheless they demonstrate the important point that the radiation becomes small at 45 degrees and that the maximum field strengths occur at low angles, as is required for this service.

At the Camden terminal of the relay circuit the receiver and antenna were installed on the roof of one of the RCA Victor Company buildings. The receiver proper was the same as that used at Arney's Mount except that a second detector was included and the output taken at video frequency instead of intermediate frequency. A kinescope for monitoring, and a line amplifier through which the video frequencies were sent to the control board at the studio were provided.

The receiving antenna presented somewhat of a problem as it was difficult to obtain a sufficiently good signal-to-noise ratio when operating in a city location. The field strength was of the order of 400 microvolts per meter. This proved ample for the 120-line picture in the evening when factory interference had ceased. By day, however, good pictures were not received until the simple horizontal dipole antenna was replaced by a horizontal V type raised 50 feet above the roof of the building, or 120 feet above the street. With this arrangement there was a tendency to balance out the noise pick-up from below, and there was a much stronger signal due to the antenna directivity. This directivity was measured by installing a small transmitter in an airplane and flying it around the receiving point. The radius of the circle flown was 20,000 feet and the height of the plane 2000 feet. Fig. 5 gives the polar diagram thus obtained. The system gives two sharp beams, being in this case bidirectional because no resistance loading was provided at the extremities of the V.

After the relay station at Arney's Mount and the receiving station at Camden were properly adjusted, a number of television programs were relayed from the Empire State Building in New York. These were necessarily of 120-line detail, being limited to this by the studio apparatus used. After being received in Camden, the video signals went by low capacity cable to the control board and thence to the television broadcast transmitter. Received from this transmitter, the picture detail, while

not as good as the original transmission, was still entirely acceptable.

It is worth pointing out that when a studio program originating in New York City was finally seen on the kinescope in the suburbs of Camden, it had passed on the way, without appreciable distortion, through three transmitters and three receivers.

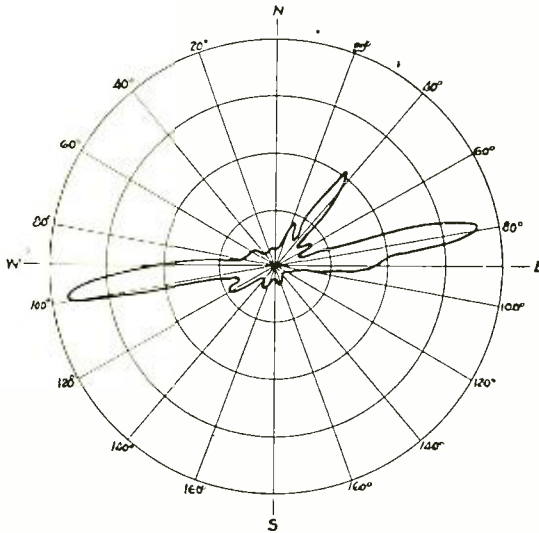

Fig. 5—Camden relay receiving antenna second detector deflection vs. bearing, plane flying at 2000 feet altitude in a circle 40,000 feet in diameter.

#### ACKNOWLEDGMENT

Acknowledgment is made to the engineers of the five companies which cooperated in carrying out this project: R. C. A. Communications, Inc. RCA Victor Co., Inc., National Broadcasting Company, General Electric Company, and Westinghouse Electric and Manufacturing Company. In addition to these men, especial credit is due to Mr. Bertram Trevor of R. C. A. Communications, Inc., and Mr. W. H. Nelson of the General Electric Company, who carried out much of the field work involved, and adjusted the varied equipment at the relay station.

# THEORY OF ELECTRON GUN

By

I. G. MALOFF AND D. W. EPSTEIN

(RCA Victor Company, Inc., Camden, New Jersey)

*Summary*—The function of the electron gun irrespective of the purpose for which the cathode ray tube is used is to generate, to concentrate, to control, and to focus an electron beam to a spot of a desired size. This paper describes the theory of the above-mentioned functions. The point of view of electron optics is presented and the theory of thick electron lenses with variable indexes of refraction is given. A somewhat detailed analysis of the action of the various parts of the gun is given, using the concepts of electron optics whenever convenient. Then a relevant part of thermionic emission is treated, with an emphasis on the distribution of velocities of emission. The initial concentration in the proximity of the cathode, the control of the beam intensity, and the effects of space charge are presented next. In closing, the performance of the gun as a whole is given, and a mathematical and graphical design procedure, made possible by certain assumptions and approximations, is described.

## INTRODUCTION

**O**F THE great number of cathode ray tube applications a radio engineer is interested mostly in three; namely, the oscillograph and its simpler form the oscilloscope, the kinescope or the television receiver tube, and the iconoscope or the television image pick-up tube.

In all of these three applications, the cathode ray tube consists essentially of five component parts: first, the glass envelope, sealed for the maintenance of vacuum; second, the cathode from which the cathode rays or, using a more up-to-date term, the electron beam, originates; third, a device for concentrating, controlling, and focusing of this electron beam; fourth, an arrangement (either internal or external) for deflecting the beam; and fifth, the screen or the target which is covered with fluorescent material in case of the oscillograph and the kinescope and photo-sensitive material in case of the iconoscope.

The term "electron gun" is fairly new and is used to describe the part of the cathode ray tube which comprises the arrangements for generation, concentration, control, and focusing of the electron beam. Fig. 1 shows a typical modern gun. The

Reprinted from Proceedings of the Institute of Radio Engineers.

tubular cathode with a flat emitting surface is indirectly heated. The emitting surface *A* is coated with some oxide preparation. The grid sleeve *B* surrounds the cathode and has a circular opening just opposite the cathode emitting area. An insulator is inserted between the grid and an auxiliary anode *C*, the latter often being called the first anode. The electrostatic field created by the potential applied to the first anode penetrates the grid opening and draws the emitted electrons into the beam. The

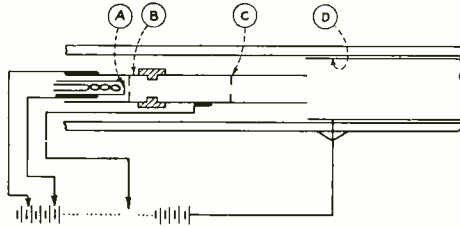

Fig. 1—Typical electron gun.

beam enters the first anode and passes through a central aperture. The purpose of this aperture, called the masking aperture, is to cut off some of the peripheral portions of the beam similar to a stop in a photographic lens. Then the beam enters the region of the field produced by the difference of potentials between the first and the second anodes. The second anode *D* is usually in the form of a cylinder surrounding the first anode. It may be either a separate electrode or it may be in the form of a conducting coating on the inside of the glass tube. In this field a strong focusing action takes place, which gives the electrons a radial velocity component directed towards the axis of symmetry of the beam. The radial momentum acquired by the electrons is sufficient to bring them after a flight through the equipotential space of the main body of the bulb to a focus at the screen.

This explanation may be taken as an introduction to this paper which is devoted to a more detailed treatment of the theory of operation of electron guns for cathode ray tubes.

### ELECTRON OPTICS

In order to treat the operation of the electron gun in detail it is very convenient to use a rather young branch of applied physics which is called electron optics. The original name of the electron beam was the cathode ray. Thus we see that the

analogy of the behavior of streams of electrons in vacuum with the behavior of light rays was self-evident to even the very early explorers. At present this analogy is firmly established and electron optics play a major part in theory and design of electron guns.

We are using electron optics for the explanation and prediction of the generation, concentration, control of intensity, and focusing of electron beams in high vacuum *only*. In a broader sense it applies to similar phenomena in rarified gases, but there the secondary phenomena complicate the analysis. In high vacuum the effects of electric and magnetic fields produced by various electrodes and poles are not obscured by the action of ions which result from collision of electrons with molecules of residual gas.

Much to be regretted is the fact that very little practical information can be found in the technical literature related to this interesting subject. That is, practical from the gun designer's standpoint. True enough there are two excellent theoretical articles by Bush<sup>1</sup> written in 1926 and 1927 (in German) proving that a sufficiently narrow bundle of electrons will focus in any nonuniform magnetic and electric field provided the fields have an axial symmetry with respect to the beam. Then comes a series of articles on electron optics and electron microscopes by Knoll and Ruska<sup>2</sup> and several others, dealing with simplified cases of thin electron lenses.

A recent article by Picht<sup>3</sup> discusses a case where electrons go through a continuously varying electrostatic field. He treats the focusing system as a thick electronic lens. He uses analytical methods for treating his problem and indicates a particular solution. His methods are of limited practical value, however, because they imply that the potential along the axis has to be expressed by an analytical function. The accuracy of Picht's solution depends on the accuracy of this analytical expression and not only on the accuracy of the expression itself, but primarily on the accuracy of its first and second derivatives. Unfortunately, there is no such general analytical function and, furthermore, all the attempts by the writers to find simple particular functions to express some of the commonly used fields failed completely.

<sup>1</sup> *Ann. der Physik*, vol. 86, p. 974, (1926), and *Archiv für Elektrotech.*, vol. 18, p. 583, (1927).

<sup>2</sup> *Ann. der Physik*, series 5, vol. 12, Heft 6, p. 641, (1932).

<sup>3</sup> *Ann. der Physik*, series 5, vol. 15, Heft 8, p. 56, (1932).

It is well known from the theory of geometric optics that when we are dealing with a thin lens, a knowledge of its focal length enables us to calculate the distance and the size of the image, if the distance and the size of the object are known. In case of a thick lens consisting of several separate lenses the story is somewhat different. It was proved by Gauss some ninety years ago that it is not necessary to treat the single surfaces of a thick lens separately, but a compound lens can be treated as a whole and some very simple formula can be used for computation of the image size and position provided certain values or constants of the lens are known. It is also well known that it is impossible to find a single lens that, placed in any one position, will act the same way as a system of lenses does. For the prediction of image position and of optical magnification of a symmetrical optical system, it is sufficient to investigate the procedure of paraxial rays in any meridian plane containing the axis. A paraxial ray is a ray whose path lies very near the optical axis of the system, so that the sine of the angle between the path and the axis can be taken as equal to the angle. Taking into consideration the rays which are making larger angles with this axis brings out a number of secondary effects such as aberrations and involves considerably more work. In what follows, except when specified, the discussion is limited to paraxial rays:

For the prediction of a path of a single electron through a known electric or magnetic field in high vacuum, the laws of classical dynamics are sufficient. The general motion of electrons may be governed by, say, modern quantum theory, but since the concentrations of thermionically emitted electrons are very small, the principles of classical dynamics still apply to them. Richardson expressed this in nearly the same words as early as 1916 and just lately Professor Kennard showed definitely and with help of all the up-to-date information, that unless the distances between the electrons in a given phenomena are of the order of their radii, the classical dynamical laws apply and are sufficient for a detailed study of the phenomena. This simply means that we are justified in treating electrons as particles of known mass; the light phenomena are best explained by means of wave analogy.

Many years ago, Newton explained all the laws of geometric optics by means of particles. We are interested only in geometric electron optics. The Newton optics then apply for the



prediction of the behavior of electrons in high vacuum and when forces between the particles are of a negligible magnitude. When these forces are of noticeable magnitude, certain simple precautions are needed, and the Newton optics still apply.

A general solution of the path of an electron through a known electrostatic field is briefly<sup>4</sup> as follows (see Fig. 2): Suppose an electron, moving with a velocity  $v_0$  enters a space, the electrostatic potential  $V$  of which is known at every point of the space. The force on the electron by the field will be  $e \nabla V$ , where  $e$  is the charge on the electron. The resultant acceleration is then  $a = \nabla V e/m$ .

The electron while going through a portion of the path  $\Delta s$  will undergo a change of velocity  $\Delta v$  and its velocity will become

$$v_1 = v_0 + \Delta v$$

where  $\Delta v$  is found as follows

$$\Delta v = \int_t a dt.$$

The actual path of the electron is given by the expression

$$\Delta s = v_0 t + \int dt \int a dt.$$

The velocities and the path of an electron through a known nonuniform electric field can be computed by successive approximations. By taking  $\Delta s$  of a magnitude small enough to consider the gradient  $\nabla V$  as of a constant value throughout this element of path, the above equations can be very much simplified, becoming

$$\Delta v = \nabla V e/m t$$

and,

$$\Delta s = v_0 t + 1/2 \nabla V e/m t^2$$

where  $t$  is the time duration of the electron going through the path  $\Delta s$ .

The older cathode ray tube technique utilized the magnetic method of focusing. The present-day practice, especially on tubes for voltages lower than 10,000 volts on the second anode, is to use the electrostatic method almost exclusively. Therefore, in our discussion we shall limit ourselves to this method after mentioning, however, that there is no difference between the

<sup>4</sup> A practical method of making actual computations is given in Appendix I.

two methods in fundamentals (as was shown in the mentioned works of Bush) and all the derivations made for the electrostatic electron lenses could be easily modified for magnetic focusing.

Bush defined an electron focusing system. He showed that any system of electric or magnetic fields will bring an electron beam to a focus provided the fields have an axial symmetry with respect to the beam. Restricting this statement to electrostatic fields, it can be easily seen that the only fields possessing such symmetry are produced by electrodes having geometric axial

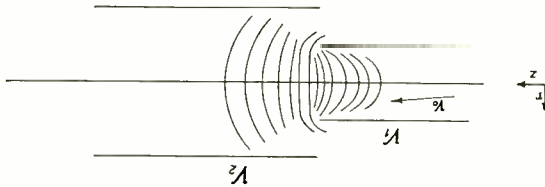

Fig. 2—Equipotential line plot of the main focusing field.

symmetry, such as coaxial cylinders, combinations of cones, disks with apertures, rings arranged in the manner shown, etc., as on Fig. 3. It is customary to arrange these fields in such a way as to have regions of equipotential space in the regions

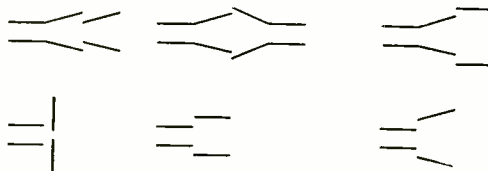

Fig. 3—Axial cross sections of focusing electrode combinations.

just adjacent to the focusing fields of the electronic lenses. The focusing fields are extremely difficult to compute, but are quite easy to determine by making enlarged water-emersed models<sup>5</sup> and surveying the fields by means of a probe connected to a sensitive voltage bridge. The authors utilized a number of plots taken by L. B. Headrick of the RCA Radiotron Company's laboratories, whose cooperation in this work is hereby acknowledged.

A typical plot of this kind is given on Fig. 2. The path of an electron through such a field can be computed by the method outlined earlier in this paper. A step-by-step method of successive approximations is recommended. It is the only workable way to do the job, since we are dealing with a field of continu-

<sup>5</sup> *Electronics*, June, (1932).

ously varying potential. In normal optics we seldom deal with such lenses, except in the case of the crystalline lens in the human eye. The reason for saying that this is the only suitable method for solving the path of an electron through an electron lens is the fact that the problem with which we are dealing is a rather difficult one. One way of stating it is in the form of two related integral equations.

Referring to Fig. 2, if the position of the electron at any time be denoted by its two coördinates  $r$  and  $z$ , then the equations of the path are as follows:

$$z = \iint_t e/m \nabla_z V dt dt \quad \text{where, } \nabla_z V = f_1(r, z)$$

$$\text{and, } t = F(r, z)$$

$$r = \iint_t e/m \nabla_r V dt dt \quad \text{where, } \nabla_r V = f_2(r, z)$$

$$\text{and } t = F(r, z).$$

So much for the general case. The case of paraxial rays is much more simple, especially because of the fact that only the axial distribution of potential is needed for its solution.

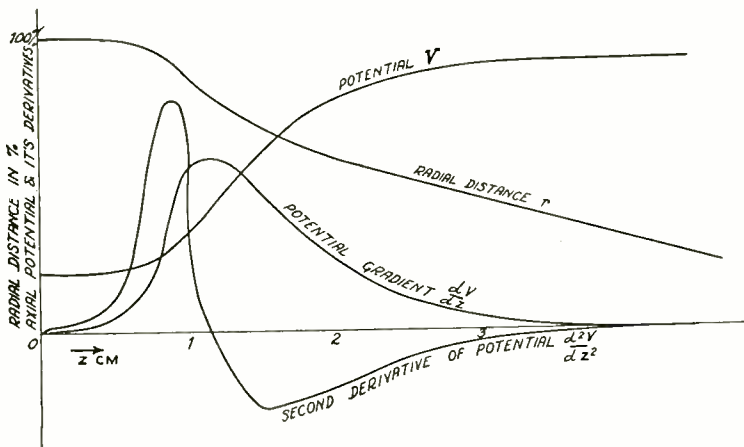

Fig. 4—Computed paraxial electron path.

From a plot of equipotential surfaces such as on Fig. 2, we can take the values of the potential  $V$  along the axis and plot it as a function of  $z$ , as shown on Fig. 4. Then from this plot of  $V$  we can graphically compute the values of gradient of the potential  $V$  along the axis. It is  $dV/dz$ . In Appendix II it is

shown that the value of the radius of curvature of the equipotential surface through a point on the axis is given by the relation

$$R = \frac{2f'(z)}{f''(z)}$$

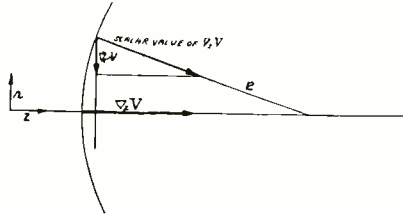

Fig. 5—Relation between axial and radial potential gradients.

The function  $f''(z)$  or  $d^2V/dz^2$  is also easily obtained graphically from the plot on Fig. 2.

For a paraxial case there is a very simple relation which is evident from Fig. 5, between the radial and axial gradients:

$\nabla_r V : r = \nabla_z V : R$  which can be transformed as follows:

$$\nabla_r V = r \frac{\nabla_z V}{R} = r \frac{f'(z) f''(z)}{2f'(z)} = 1/2 r f''(z)$$

where  $r$  is the radial distance of the paraxial electron from the axis. The radial acceleration of an electron is therefore

$$\begin{aligned} \frac{d^2r}{dt^2} &= \frac{1}{2} \frac{e}{m} r \frac{d^2V}{dz^2} \quad \text{but} \quad \frac{dz}{dt} = \sqrt{2 \frac{e}{m} V} \\ \frac{d^2r}{dt^2} &= \frac{dz}{dt} \frac{d}{dz} \left( \frac{dr}{dz} \frac{dz}{dt} \right) = 2 \frac{e}{m} V \frac{d^2r}{dz^2} - \frac{e}{m} \frac{dr}{dz} \frac{dV}{dz} \\ \frac{d^2r}{dz^2} &= \frac{1}{4} r \frac{1}{V} \frac{d^2V}{dz^2} - \frac{1}{2} \frac{1}{V} \frac{dr}{dz} \frac{dV}{dz} \\ r &= \int \int_z \frac{1}{4} r \frac{1}{V} \frac{d^2V}{dz^2} dz dz - \int \int_z \frac{1}{2} \frac{1}{V} \frac{dr}{dz} \frac{dV}{dz} dz dz. \end{aligned}$$

On Fig. 4 a complete paraxial electron path computed by the above described method is shown.

One thing is important to note, that a close examination of the relation just given shows that the path depends only on  $r$ ,  $z$ , and relative  $V$ , which in turns means that it depends on the geometry of the field and focusing voltage ratio only, and that

the units of voltage and length can be arbitrarily chosen since all the converting factors and  $e/m$  drop out. Also the relation just given is a proof that an electron moving with a velocity corresponding to a drop through a voltage  $V_1$ , and going through an electrostatic field caused by a potential difference  $V_2 - V_1$ , follows a path, which is independent of the individual values of  $V_1$  and  $V_2$ . This path is completely determined by the ratio  $V_2/V_1$  and by the configuration of the electrodes to which these potentials are applied. This is a fundamental theorem of electron optics. It means that once we have a given configuration of electrodes and a fixed position of the object and the image screen, the image will always come to focus on that screen at the same ratio of voltages on the electrodes.

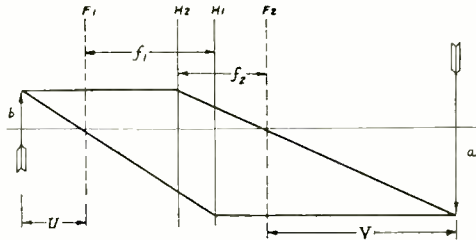

Fig. 6—Optical constants of a thick electron lens.

On the basis of the foregoing discussion we may state that if we know the distribution of the potential on the axis of an electron lens, we may compute the path of any paraxial electron through it. Now if we compute the paths of two paraxial electrons entering the field under consideration from opposite directions and both parallel to the axis, we shall have all of the optical constants of such lenses determined. Naturally the electrons must enter the field with velocities corresponding to the equipotential spaces from which they enter the field.

Planes normal to the axis and passing through the points of intersections of the original directions of the respective electrons with the directions of their emergence from the field are called the principal planes of the optical system. Points of intersection of the directions of emergence and axis of symmetry are called the focal points of the system. The distances between the focal points and the respective principal planes are called focal distances. As seen from Fig. 6 these locations or "cardinal points" and distances (which constitute the set of optical constants of the system) are closely related to the object and image distances.

By plane geometry we find the following relations

$$m = a/b = V/f_2 = f_1/U \quad (1)$$

$$f_1 f_2 = UV \quad (2)$$

where  $m$  is the value of optical magnification.

So much for the general electron optics. We shall have to come back to it again when we consider the performance of the complete gun.

### THEORY OF ELECTRON GUN

#### *Cathode and Emission*

We already mentioned that the cathode of a modern cathode ray tube is usually made in a tubular form with a flat emitting surface at its end and is indirectly heated by means of a coiled tungsten filament on the inside of the metal tube. The emitting surface is oxide coated. From the standpoint of electron optics, our source of rays is a plane. The electrons are emitted from a plane in accordance with Maxwell's law. There has been some question regarding the correctness of the law, which caused the authors to perform a number of computations of cases which could be easily checked by simple experiments. Results of these checks have convinced the authors that whether or not the law describes the phenomena completely, it can be considered as a law from the gun designer's standpoint. Various investigators claim that the total number of electrons emitted is predicted inaccurately by Maxwell's law, but in practice this number varies such a great deal with the methods of application and formation of the oxides that the theoretical number emitted is of very little interest. The point of great interest is the velocity distribution, and this Maxwell's law predicts very accurately.

One of the simple experiments made by the authors will be described. Two parallel metal disks about five centimeters in diameter were spaced one centimeter apart in high vacuum. A center point (or as nearly a point as practicable) was covered with an oxide preparation and heated to a normal cathode temperature. The inside surface of the second plate was covered with fluorescent material and a potential of 1000 volts was applied between the two plates. The electrons from the emitting point produced a luminous spot on the fluorescent plate. The diameter of the spot was then calculated from the Maxwellian distribution of velocities and was found to be the same as observed within the accuracy of the measurements. The density

distribution of the electrons arriving at the fluorescent screen in the case just described is shown on Fig. 7.

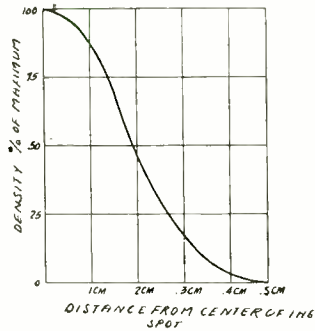

Fig. 7—Computed electron density distribution for the experimental check of Maxwell's law of velocity distribution of electron emission.

### Control

For many purposes for which cathode ray tubes are used it is necessary to vary the intensity of the beam. It is easiest to do so when the electrons have low speeds and so the controlling element is placed near the cathode. There are various methods of control, but this paper will limit itself to aperture control as is the practice of today. The controlling element is usually called a grid, although no gratings or perforations may be present, as indicated in Fig. 1.

The action of the control aperture is twofold. It applies a negative potential near some parts of the cathode and so prevents any electrons from leaving these parts and, together with the first anode and cathode, it forms an electronic lens which is of great importance in determining the spot size. Fig. 8 shows the potential distribution near the cathode of a particular gun for zero and  $-30$  volts on the grid. It is seen that in Fig. 8(B), for  $-30$  volts bias, only the center portion of the cathode is emitting and the negative voltage near the outer edges of the cathode prevents any electrons from leaving the cathode. In the case of Fig. 8(A) nearly the entire cathode is emitting.

The space charge near the edge of the beam at the cathode further reduces the area of emission. This will be seen a little later under the discussion of space charge.

Fig. 8 shows the equipotential lines comprising the thick electronic lenses just mentioned and it is seen that one of the disadvantages of aperture control is the fact that the lens is

changed whenever the intensity of the beam is varied, so that the spot on the target will vary somewhat with intensity.

The action of this electronic lens is rather complicated. One of the difficulties lies in the fact that the density of the electrons in the beam is sufficiently large so as not to be negligible. This

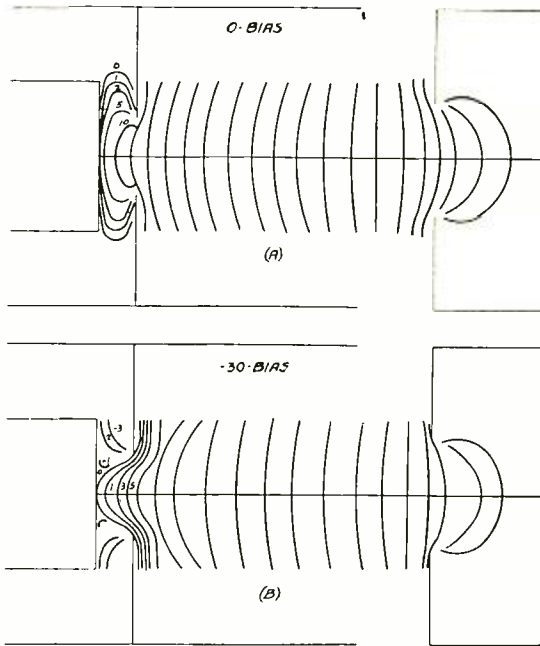

Fig. 8—Equipotential surfaces in proximity of cathode.

is especially true close to the cathode where the electron velocity is low. Later in this paper a method for computing the effect of space charge will be outlined, and some of the results obtained will be given. At present an analysis of the action of the field near the cathode will be made, neglecting space charge. The effect of space charge does not radically alter the action of the lens.

An analysis of the focusing field near the cathode may be made by determining the cardinal points of the centered system of spherical refracting surfaces given in Fig. 8. This is somewhat involved by the fact that the electrons incident on the lens are not moving with constant speed. The cardinal points will, of course, depend upon the particular initial speed assumed. This corresponds to chromatic aberration in the case of light. To



determine the effect of chromatic aberration, it is necessary to obtain the cardinal points of the field for several different initial speeds of the electrons. Some deductions regarding the chromatic aberration can be made directly by inspection of the equipotential line plots of Fig. 8. Thus, in the case of zero bias, the two-volt equipotential surface is very close to the cathode so that, regardless of the initial speed (zero to 0.35 equivalent volt) the electrons almost immediately assume speeds ranging from 2 to 2.3 equivalent volts and so the chromatic aberration will be small. In the case of the  $-30$ -volt bias, the chromatic aberration is much larger.

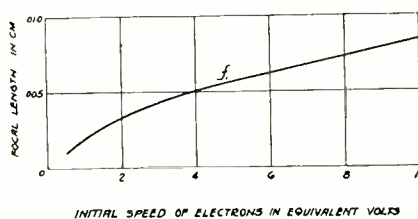

Fig. 9—Variation of first focal length with initial speed of electrons; second focal length does not vary and is equal to 0.38 centimeter.

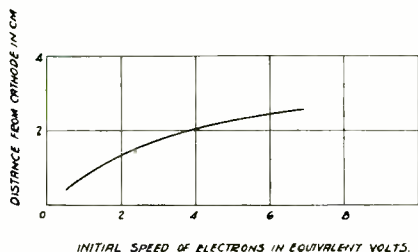

Fig. 10—Variation of position of cathode image with initial speed of electrons showing the chromatic aberration.

In Fig. 9 are given the focal lengths,  $f_1$ , computed for several values of initial speeds of electrons for the  $-30$ -volt bias case. An interesting fact is that the effect of the initial speeds of chromatic aberration is to alter the cardinal points of the object space only; the cardinal points of the image space, viz.,  $F_2$  and  $H_2$ , are not appreciably altered even up to 0.5 equivalent volt initial speeds.

Taking the cathode, the source of the electrons, as the object, we can compute the position of the image of the cathode by means of (1) and the magnification by means of (2). Perform-

ing the computation for the  $-30$ -volt bias case, there results a different image distance for each different initial electron speed assumed. In Fig. 10 are given the positions of the cathode image for several initial electron speeds. It is seen that the chromatic aberration is considerable.

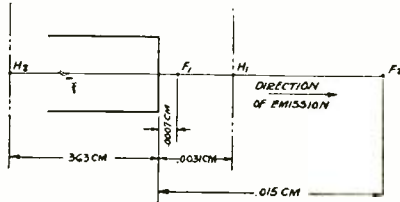

Fig. 11—Cardinal points of first electron lens.

The cardinal points of the first lens for a particular set of voltages on the electrodes and initial speed of electrons are shown in Fig. 11.

A further analysis of the focusing field near the cathode may be made by calculating the paths of several special electrons. The paths of two electrons, one having the initial radial velocity of  $+0.35$  equivalent volt, and the other of  $-0.35$  equivalent volt (normal velocity assumed zero) was determined. Their paths are

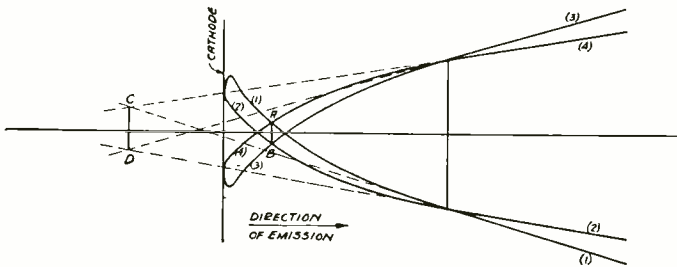

Fig. 12—Analytical determination of electron beam boundary in proximity of cathode.

shown by curves (1) and (2) of Fig. 12. The paths of all the electrons emitted from this point on the cathode having initial radial velocities of less than  $0.35$  equivalent volt will lie in the region included between these two paths, and, similarly, no electrons of the assumed initial velocities emitted by the portion of the cathode above the axis will cross the path of the uppermost electrons when it is above the axis. Paths (3) and (4) of Fig. 12 are the corresponding paths below the axis.

Now consider the point  $A$ . Through point  $A$  pass electrons (1) and (4). Similarly, electrons of suitable velocities coming from every point of the cathode pass through point  $A$ . Point  $A$  is, therefore, a new source of electrons; similarly with point  $B$  and with every point of the cross section  $AB$ . The cross section  $AB$  is thus a new source of electrons and has been called the crossover, for lack of a better name. Thus  $AB$  can be considered as an object to be imaged and the position and size of the image can be found by extending rays (1) and (4) backward until they meet in  $C$ ; then  $C$  is the virtual image of  $A$ . Similarly,  $D$  is the virtual image of  $B$ . It is this virtual image of the crossover that is focused on the screen when the spot is a minimum.

### *Space Charge*

If the space charge is negligible, then the path of an electron can be determined from the equipotential line plot shown in Fig. 8. If, however, the space charge is not negligible, then the potential distribution in space is no longer given by Fig. 8, but by a modified distribution. To find this modified distribution, it is necessary to find the potential distribution in space due to the space charge and the charges induced on the electrodes by the space charge, and add this to the distribution shown in Fig. 8. Having the modified field, we can forget space charge and proceed as though there were none there.

The equations necessary for the calculation of space charge are given in Appendix III. In this part of the paper only a general outline of the procedure used in obtaining the potential distribution in space due to the electron beam will be given and some of the results obtained presented. The process is as follows:

(1) Neglecting space charge, the shape of the beam near the cathode is obtained from the paths of several electrons through the fields of Fig. 8, or the shape of the beam may be experimentally determined. In Fig. 13 is shown the shape of the beam obtained from the paths of several electrons.

(2) From the equipotential line plot and the initial velocity of the electrons, the velocity of any electron at any point may be calculated. Knowing the velocity of the electrons, the shape of the beam and the current in the beam, the density of charge at any point may be calculated. Fig. 14 gives the charge density along the axis so calculated.

(3) From the charge density and the shape of the beam the potential at any point due to the beam can be calculated. Curve (1) Fig. 15, gives the calculated potential along the axis due to the beam.

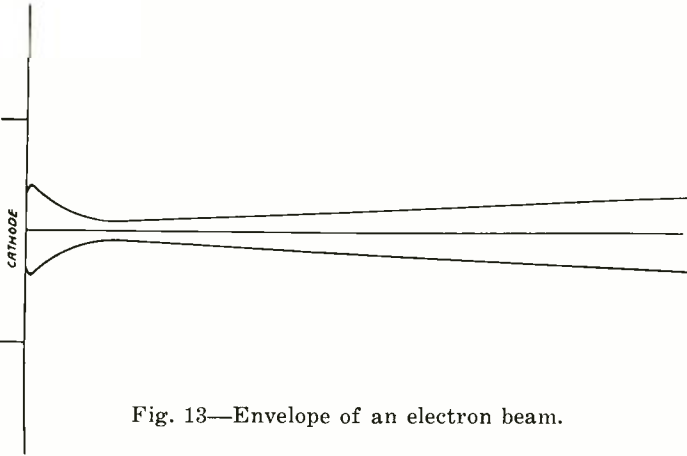

Fig. 13—Envelope of an electron beam.

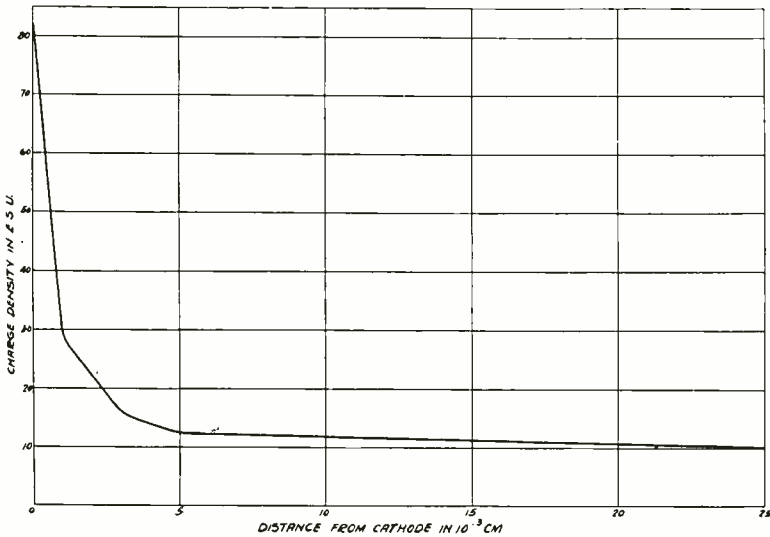

Fig. 14—Charge density along the axis of an electron beam.

(4) The charges induced on the electrodes are then calculated and the potential distribution in space due to these induced charges is obtained. Curve (2) Fig. 15 gives the calculated potential along the axis due to the charges on the electrodes induced by the space charge.

(5) The difference between the potential distributions obtained in paragraphs (3) and (4) above gives the potential distribution that is subtracted from that of Fig. 8 to get the distribution sought. Curve (3), Fig. 15, gives the potential along the axis obtained as the difference between curves (1) and (2).

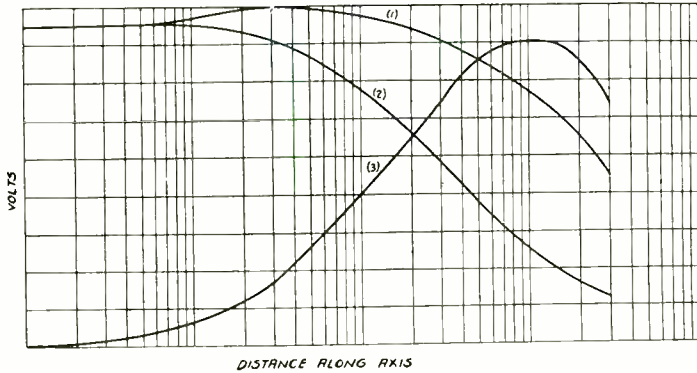

Fig. 15—Curve (1) potential along the beam axis due to beam itself.  
 Curve (2) potential along the axis due to induced charges.  
 Curve (3) difference between the two (half scale).

If a better approximation is desired, it is necessary to repeat the process starting with the potential distribution obtained in step (5) instead of the distribution of Fig. 8.

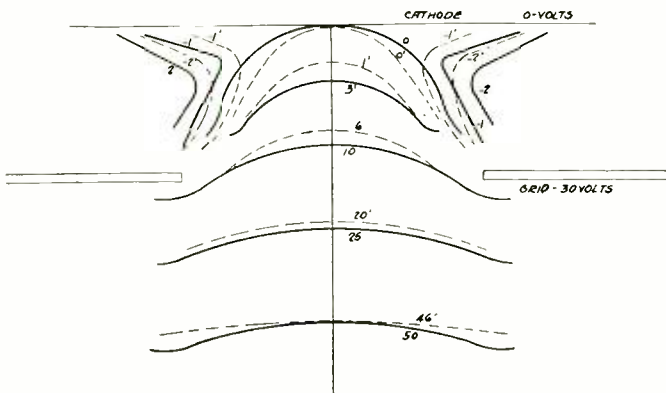

Fig. 16—Effect of the space charge on the potential distribution of first lens.

The solid lines of Fig. 16 give the distribution without space charge, i.e., the distribution of Fig. 8, and the dotted lines give the potential distribution after the space charge has been accounted for.

*Main (Second) Focusing Field*

The divergent beam leaving the first focusing field strikes an aperture about midway in the first anode. This aperture serves as a stop to remove all the stray electrons on the periphery of the beam. The beam then enters the second or main focusing field. An equipotential line plot of the main focusing field is shown in Fig. 2.

When the electron beam enters the second focusing field, the electrons in the beam are already traveling at high velocity, and the cross section of the beam is such that the electron density of the beam is small so that the force exerted by the electrons in the beam on any electron is negligible. Hence the effect of space charge may be neglected in making an analysis of the second focusing field.

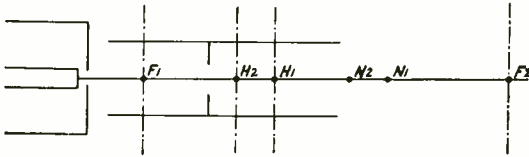

Fig. 17—Positions of cardinal points of second focusing field.

Inspection of Fig. 2 will convince one that near the axis the equipotential surfaces are portions of spheres. Hence, the second focusing field may be considered as a centered optical system of spherical refracting surfaces. As in the case of light, the focusing action of the field is obtained by considering only paraxial electrons. The effects of the nonparaxial electrons are then described as aberrations or failure of the electrons to arrive at the points calculated from the paraxial assumption.

The cardinal points of the second focusing field are found by the method previously outlined. Fig. 17 shows the positions of the cardinal points of the second focusing field of a kinescope for one set of voltages. In this diagram  $F_1$  and  $H_1$  are the focal and principal planes of the object space;  $F_2$  and  $H_2$  the focal and principal planes of the image space;  $N_1$  and  $N_2$  are the nodal points of the object and image space, respectively. The focal lengths  $f_1$  and  $f_2$  are then defined as

$$H_1F_1 = f_1, \quad H_2F_2 = f_2$$

Further, let  $P$  in Fig. 18 be an object point and  $Q$  its image

and denote  $PF_1$  by  $U$  and  $F_2Q$  by  $V$ . Then as has already been given

$$UV = f_1 f_2.$$

This equation determines the position of the image  $V$  providing the position of the object  $U$  and the focal lengths  $f_1$  and  $f_2$  are known; or it determines the position of the object  $U$ , if the location of the image and the focal lengths are known.

As already mentioned, the magnification of the focusing field is then determined from the relation

$$m = \frac{V}{f_2} = \frac{f_1}{U}. \tag{1}$$

It is to be noted that the second focusing system is one with crossed principal planes and that the first focal length is smaller than the second focal length. This result is not surprising if it is remembered that the indexes of refraction<sup>6</sup> on the two sides of the focusing system are different.

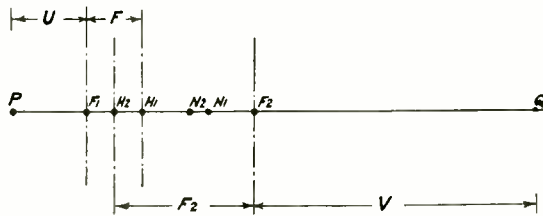

Fig. 18—Object and image positions and cardinal points of the first field.

For a given first and second anode diameter the cardinal points are determined solely by the ratio of second anode to first anode voltage. The actual value of the first or second anode voltage does not affect the cardinal points of the field, it is only their ratio that matters. In the design of a kinescope, however, the actual voltage on the anodes does matter, for although it does not affect the cardinal points of the focusing system, there are other factors in the tube which it does affect. Thus the brightness of the spot depends upon the actual voltages. Fig. 19 gives the variation of the first and second focal lengths with the ratio of second anode to first anode voltages.

In a given kinescope, the fluorescent screen is at a fixed distance from the end of the gun, say 30 centimeters. This fixes the position of the image,  $V$ , as  $30 - F_2$ . Knowing  $f_1$  and  $f_2$ , the object distance,  $U$ , may be calculated. Thus, with the position of

<sup>6</sup> As in the case of light, the relative index of refraction of two media is defined as the ratio of the velocities of the electrons in the two media and is given by  $\mu = \sqrt{V_2/V_1}$  where  $V_2$  and  $V_1$  are the potentials of the second and first media, respectively.

the image fixed at the screen 30 centimeters away from the gun, the changes in location (along the axis) of the object due to changes in the focusing voltage ratio may be computed from (2). The result is shown in Fig. 20 where it is seen that as the voltage ratio is decreased, the location of the object that is focused on the screen 30 centimeters away from the end of the gun, is moved further and further away from the screen.

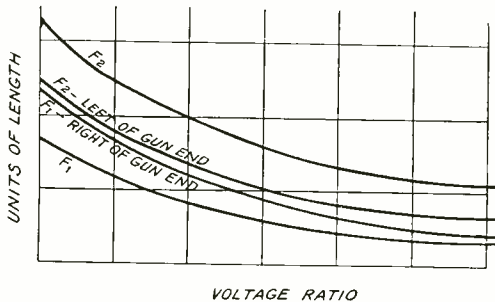

Fig. 19—Variation of optical constants of an electron gun with ratio of voltages on first and second anodes.

Similarly, by the use of (1) the magnification of the second focusing field for any given voltage ratio may be computed. The result is shown in Fig. 21 where it is seen that as the voltage ratio is increased, the magnification of the object, which is focused on the screen 30 centimeters away from the end of the gun, is increased. Fig. 22 shows how the magnification varies

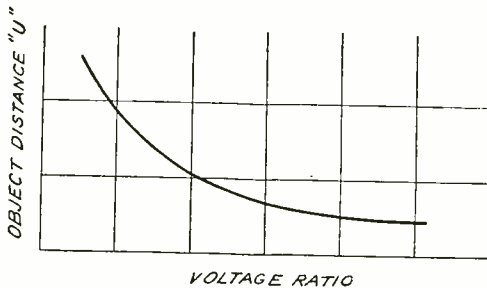

Fig. 20—Variation of object distance with voltage ratio keeping image distance constant.

with the position of the object, assuming the image to be on the screen.

Although Figs. 20 to 22 apply only in case the screen is 30 centimeters away from the end of the gun, similar curves can be obtained for any distance between screen and gun from the curves of Fig. 19, giving the cardinal points of the field, and (1) and (2).



Fig. 19 gives the variation of the cardinal points with varying voltage ratios on second and first anode for a given ratio of diameters between second and first anode. Similar curves can be obtained for other diameter ratios.

It is of importance to have some measure of the aberration of the second focusing field. To determine the spherical aber-

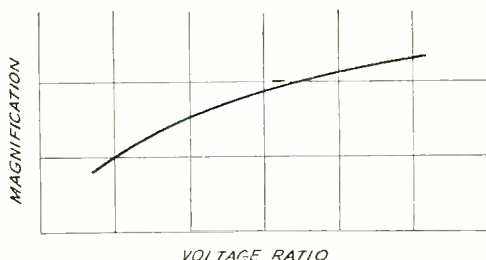

Fig. 21—Variation of optical magnification with voltage ratio keeping image distance constant.

ration, the path of several electrons moving parallel to the axis at different distances from the axis is computed. The method of computing the path of a nonparaxial electron is given in Appendix II. Fig. 23 gives the path of several electrons so calculated. It is seen that electrons (*a*), a nonparaxial electron, originally on the outside of the beam, intersects the axis at  $L_2$ ,

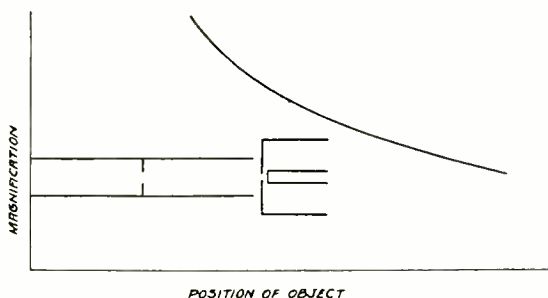

Fig. 22—Variation of optical magnification with position of the object keeping the image distance constant.

while electron (*b*), a paraxial electron, intersects the axis at  $F_2$ . The distance  $L_3F_2$  is a measure of the axial spherical aberration of a direct cylindrical bundle of incident electrons. The chromatic aberration of the second focusing field is negligible.

Although only the cylinder type of focusing electrodes has been considered so far, they are by no means the only ones that

may be treated in the above manner. Cardinal points can be obtained, in the above-described manner, for any focusing system having axial symmetry.

It is interesting to follow what is being focused on the fluorescent screen as the second anode voltage is varied, everything else remaining unchanged. If the second and first anodes are at the same potential, then there is a poorly focused inverted image of the cathode on the screen; as the voltage on the second anode

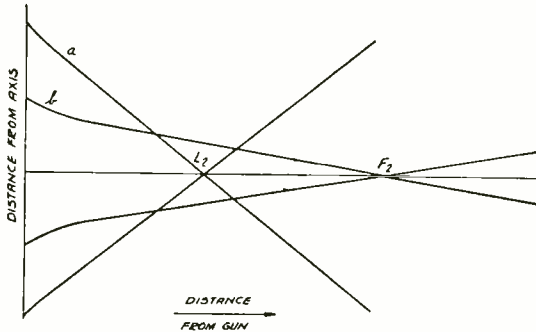

Fig. 23—Determination of spherical aberration of an electron lens.

is increased, the distance between the cross section being imaged and the second focusing field is decreased. As this distance is decreased, so is the diameter of the cross section being imaged. This continues until the image on the screen is that of the virtual image of the crossover; at this position the diameter of the cross section is a minimum.

As the second anode voltage is further increased, the spot on the screen increases as the cross section of the object being imaged increases. As the second anode voltage is still further increased, the image on the screen is that of the image of the cathode produced by the first focusing field; this image is, however, erect and a much better one than the inverted one produced when the second anode voltage is nearly that of the first anode.

### CONCLUSION

It is only by considering the fields as thick lenses with indexes of refraction different on the two sides of the lens and variable inside the lens that we can obtain a fairly true picture of the mechanism of the tube, and so obtain sound information for design purposes in general.

For particular purposes a thin lens can be used. Thus it is possible to assign to a thin lens focal lengths and positions so that correct image distances and magnification values can be calculated for a limited range of voltage ratios and image distances. As soon as this limited range is exceeded, it is necessary to find another thin lens with different focal lengths and probably another position. This lens will serve for another range of values and so on, until the entire range is covered.

The fact that different thin lenses will be required for different ranges would not be so objectionable. The real difficulty is in determining the right constants for different thin lenses and the exact region to which these constants apply.

For a real story of the performance of the gun, the theory of thick electron lenses seems to be the only satisfactory tool of analysis.

#### APPENDIX I

##### Approximate Calculation of the Path of an Electron through any Electrostatic Field with Axial Symmetry

Due to the axial symmetry the path of an electron through a field such as shown in Fig. 2 can be considered as a two-dimensional problem. From Fig. 2 it is seen that the force acting on an electron varies throughout its path. If, however, two equipotential lines are sufficiently close together both in distance and potential, the force acting on an electron in this interval can be taken as constant throughout this interval. The constant field is given by  $\Delta V/\Delta S$  where  $\Delta V$  is the difference in potential between the two equipotential lines and  $\Delta S$  is the shortest distance between them at the place under consideration. Hence the force acting on the electron during the time it is between the two equipotential surfaces is

$$F = m \frac{d^2S}{dt^2} = e \frac{\Delta V}{\Delta S} \quad (1)$$

This equation, after being broken up into its components, becomes

$$m \frac{d^2r}{dt^2} = e \frac{\Delta V}{\Delta S} \sin \theta$$

$$m \frac{d^2z}{dt^2} = e \frac{\Delta V}{\Delta S} \cos \theta \quad (2)$$

where  $\theta$  is the angle between the direction of the field (or  $\Delta S$ ) and the axis. Now  $\sin \theta = r_0/\rho$  and  $\cos \theta = \sqrt{\rho^2 - r_0^2}/\rho$  where  $\rho$  is the radius of curvature obtained by averaging the radii of the two surfaces and  $r_0$  is the value of  $r$  at the first surface. Hence equations (2) become

$$\frac{d^2r}{dt^2} = \frac{e}{m} \frac{\Delta V}{\Delta S} \frac{r_0}{\rho} = K_1 = \text{constant} \quad (3)$$

$$\frac{d^2z}{dt^2} = \frac{e}{m} \frac{\Delta V}{\Delta S} \frac{\sqrt{\rho^2 - r_0^2}}{\rho} = K_2 = \text{constant.}$$

Integrating once

$$\frac{dr}{dt} = K_1 t + \left(\frac{dr}{dt}\right)_0 \quad (4)$$

$$\frac{dz}{dt} = K_2 t + \left(\frac{dz}{dt}\right)_0$$

Integrating once more

$$\Delta r = r - r_0 = 1/2 K_1 t^2 + \left(\frac{dr}{dt}\right)_0 t \quad (5)$$

$$\Delta z = z - z_0 = 1/2 K_2 t^2 + \left(\frac{dz}{dt}\right)_0 t$$

where  $z_0$ ,  $r_0$ ,  $(dz/dt)_0$ , and  $(dr/dt)_0$  represent the given location and velocity of the electron at the first surface. To find the location and velocity of the electron at the second surface it is necessary to solve (4) and (5). To do this the time  $t$  which the electron spends between the two surfaces has to be known. This time can be determined in any number of ways. In practice, with the attainment of a little skill, one can, in a single trial, estimate the time surprisingly accurately by using the relation  $\Delta S/v$  as a guide; in this relation  $v$  is the average speed of the electron in the interval. The time may be calculated from

$$1/2m \left[ (K_1^2 + K_2^2)t^2 + 2 \left\{ K_1 \left(\frac{dr}{dt}\right)_0 + K_2 \left(\frac{dz}{dt}\right)_0 \right\} t \right] = e\Delta V \quad (6)$$

the relation obtained from the law of conservation of energy. The calculation of the time by means of this relation becomes, however, quite laborious.

Having  $t$ , the position and velocity of the electron at the second surface is known and the process is continued until the path of the electron through the entire field is determined.

The case of a paraxial path is much simpler. As  $dr/dt \ll dz/dt$ ,  $\Delta S \doteq \Delta z$ , and  $t$  is entirely determined by the relation  $\Delta z/v$ . It is only necessary to compute  $r$  and  $dr/dt$  from the first equations of (4) and (5). The work required for the calculation of a paraxial path is less than half of that for an actual path.

### APPENDIX II

#### The Determination of the Radii of Curvature at the Axis of a Coaxial System of Equipotential Surfaces

If, for a system having axial symmetry, the value of the potential and its derivatives along the axis are known, then the value of the potential off the axis can be obtained from the expansion.<sup>7</sup>

$$V(z, r) = f(z) - \frac{r^2}{2^2} f''(z) + \frac{r^4}{2^4 4^2} f^{IV}(z) \tag{1}$$

where  $f(z) = V(z, 0)$  is the value of the potential along the axis.

If the equipotential lines such as shown in Fig. 2 are given in the form

$$V(z, r) - C = F(z, r) = 0 \tag{2}$$

then the expression<sup>8</sup> for the radius of curvature is

$$\rho = - \frac{\left\{ \left( \frac{\partial F}{\partial z} \right)^2 + \left( \frac{\partial F}{\partial r} \right)^2 \right\}^{3/2}}{\frac{\partial^2 F}{\partial z^2} \left( \frac{\partial F}{\partial r} \right)^2 - 2 \frac{\partial^2 F}{\partial z \partial r} \frac{\partial F}{\partial z} \frac{\partial F}{\partial r} + \frac{\partial^2 F}{\partial r^2} \left( \frac{\partial F}{\partial z} \right)^2} \tag{3}$$

<sup>7</sup> H. Bateman, "Part. Diff. Equ. of Math. Physics," pp. 406.

<sup>8</sup> "Smithsonian Mathematical Formulae," p. 38.

For points along the axis there results from (1) and (2) that

$$\left. \begin{aligned} \frac{\partial F(z, r)}{\partial r} &= \frac{\partial V(z, r)}{\partial r} = 0 \\ \frac{\partial^2 F(z, r)}{\partial z \partial r} &= \frac{\partial V(z, r)}{\partial z \partial r} = 0 \\ \frac{\partial F(z, r)}{\partial z} &= \frac{dV(z, 0)}{dz} = f'(z) \\ \frac{\partial^2 F(z, r)}{\partial z^2} &= - \frac{d^2 V(z, 0)}{dz^2} = - f''(z) \\ \frac{\partial^2 F(z, r)}{\partial r^2} &= \frac{\partial^2 V(z, r)}{\partial r^2} = - \frac{1}{2} \frac{d^2 V(z, 0)}{dz^2} = - \frac{1}{2} f''(z) \end{aligned} \right\} \quad (4)$$

By substituting (4) into (3) the expression for the radius of curvature along the axis becomes

$$\rho = 2 \frac{\frac{dV(z, 0)}{dz}}{\frac{d^2 V(z, 0)}{dz^2}} = \frac{2f'(z)}{f''(z)}$$

### APPENDIX III

#### Approximate Calculation of Space Charge

Due to the form of the equipotential surfaces near the cathode, the electrons on the periphery of the beam are moving slower than those near the axis of the beam. The density, therefore, increases with the distance from the axis. Along the axis the density varies as that shown in Fig. 17. The exact problem of determining the potential distribution in space due to the distributions of charge, as that existing in the beam, is almost hopeless.

The problem was approximately solved by considering only small portions of the beam at a time. The small portions were chosen so that in each portion: (a) the beam is either a disk or cylinder; (b) the density along the axis is either constant or varies linearly; and (c) the density normal to the axis is either constant throughout, or the disk or cylinder of charge can be obtained from the superposition of several disks or cylinders of various radii and charge densities.

To calculate the charges induced on the electrodes, the potential at the electrodes due to the charges in the beam was obtained and the induced charges were so determined so as to reduce this potential to zero. The induced charges were assumed to be in the forms of disks and rings of charges of constant density. It was later found that the effect of the induced charges for the —30-volt bias case can be obtained to a sufficient degree of accuracy by assuming the cathode to be an infinite plane and considering the induced charges to be the image of the charges in the beam.

The equations found most useful in the calculation of the potential distribution due to the space charge are:

(a) The potential along the axis due to a cylinder of charge of constant density  $\rho$ , of length  $2l$ , and radius  $a$ , is given by

$$V = \pi\rho \left[ (l-x)\sqrt{(x-l)^2+a^2} + (l-x)\sqrt{(x+l)^2+a^2} - 4xl + a^2 \log \frac{\{\sqrt{(x-l)^2+a^2} + (l-x)\}}{\{\sqrt{(x+l)^2+a^2} - (l-x)\}} \right] \tag{1}$$

where  $x$  is measured from the center of the cylinder

(b) The potential at any point  $(r, \theta)$  due to a disk of total charge  $Q$  and radius  $a$  is

$$V = \frac{2Q}{a} \left[ \frac{1}{2} \frac{a}{r} - \frac{1.1}{2.4} \left(\frac{a}{r}\right)^3 P_2(\cos \theta) + \frac{1.1.3}{2.4.6} \left(\frac{a}{r}\right)^5 P_4(\cos \theta) - \dots \right] \tag{2}$$

$r > a$

$$V = \frac{2Q}{a} \left[ 1 - \frac{r}{a} P_1(\cos \theta) + \frac{1}{2} \left(\frac{r}{a}\right)^2 P_2(\cos \theta) - \frac{1.1}{2.4} \left(\frac{r}{a}\right)^4 P_4(\cos \theta) + \dots \right]$$

$r < a, \theta < \frac{\pi}{2}$

(c) The potential at any point  $(r, \theta)$  due to a circular ring of small cross section of total charge  $Q$  and radius  $a$  is

$$\begin{aligned}
 V &= \frac{Q}{a} \left[ \frac{a}{r} - \frac{1}{2} \left( \frac{a}{r} \right)^3 P_2(\cos \theta) \right. \\
 &\quad \left. + \frac{1.3}{2.4} \left( \frac{a}{r} \right)^5 P_4(\cos \theta) - \dots \right] r > a \\
 &= \frac{Q}{a} \left[ 1 - \frac{1}{2} \left( \frac{r}{a} \right)^2 P_2(\cos \theta) \right. \\
 &\quad \left. + \frac{1.3}{2.4} \left( \frac{r}{a} \right)^4 P_4(\cos \theta) - \dots \right] r < a.
 \end{aligned}
 \tag{3}$$

(d) The potential at any point due to a line of charge of total charge  $Q$  and length  $l$  is

$$V = \frac{Q}{l} \log \frac{r + r' + l}{r + r' - l}
 \tag{4}$$

where  $r$  and  $r'$  are the distances from the point under consideration and the two ends of the line of charge.

(e) The potential at any point due to a point charge  $Q$  is

$$V = \frac{Q}{r}.
 \tag{5}$$

Equations (4) and (5) are used if the point at which the potential is desired is sufficiently far from the charges under consideration.



# THE CATHODE RAY TUBE IN TELEVISION RECEPTION

By

I. G. MALOFF

(RCA Mfg. Company, Inc., Camden, N. J.)

Delivered before the Radio Club of America, September 18, 1935

THE discoveries of the electron and of electron emission and the development of means of controlling the electron emission, opened a wide way which led to the present day radio broadcasting, sound recording and communication systems in general. In exactly the same way the gradual development of means for concentrating electron beams and especially the development of means for controlling these beams in intensity and direction, are directly responsible for the present day television systems of high definition.

An electron beam is a narrow pencil of negatively charged particles moving with great velocities of the order of 30,000 miles per second. While electron beams were discovered and used as early as the end of the last century, it is only in the last decade that their properties were understood, and means for their generation and control were developed.

A television system of high definition, just as any television system, must have several component parts.

Fig. 1a shows a block diagram of a practical television system.

It has been shown time after time that in order to transmit a picture over wires or radio it is necessary to split the picture having two dimensions, namely, height and width, into one dimension of length. In other words, we have to scan a picture in order to transmit it, and moreover we have to scan synchronously the picture at the receiver and to vary the intensity of the spot at the receiver in synchronism with the variation of brightness under the scanning spot at the transmitter.

The only difference between television systems of high and of low definition is in the degree of detail transmitted and received. The old mechanical systems are satisfactory for televising pictures having definitions up to 100 lines and reach their

limit of definition somewhere between 100 and 200 lines. High definition systems employing electron beams have hardly a limit to their capability of definition. The limitations on these are imposed chiefly by the associated communication apparatus.

On Fig. 1b a block diagram of a complete sound communication system is shown. The only essential difference between the two systems is the fact that a television system requires synchronizing arrangements while a sound system does not. Outside of that, the similarity is striking.

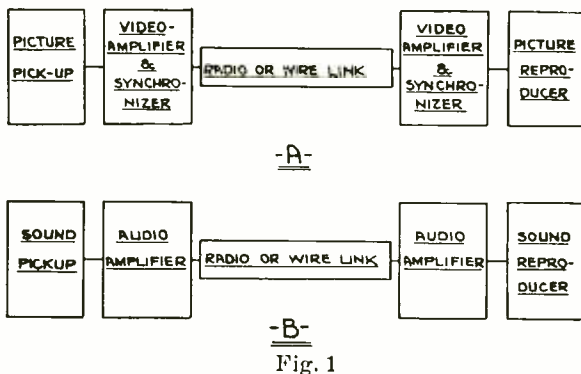

Fig. 1

True, the amplifiers have to pass frequency bands of differing widths, but in all essentials the systems are alike. Both systems pick up forces affecting our senses and translate these forces into electrical intensity vs. time variations; both systems pick them up at low levels and have to use vacuum tube amplifiers in order to bring them to levels suitable for transmission over distance; both systems may or may not use carriers to transmit the intelligence over the distance by means of either the air or cable. On the receiving end, both systems have to demodulate and amplify the received signals to bring them to the required power levels and then, by means of suitable transducers, reproduce the forces similar to those which were originally picked up.

The microphone in the sound system corresponds to the "Iconoscope" in television, and the power output stage and the loud speaker similarly correspond to the cathode ray tube with its electron gun and fluorescent screen.

While both the "Iconoscope" and the cathode ray receiving tube, or the "Kinescope" employ electron beams, the structure, operation and characteristics of the two are widely different.

In this discussion we will deal with the "Kinescope" or the cathode ray television receiving tube, with its construction, characteristics and operation.

### THE "KINESCOPE"

A typical "Kinescope" is shown on Fig. 2.

It consists essentially of five component parts: first, a glass envelope, sealed for maintenance of high vacuum; second, a

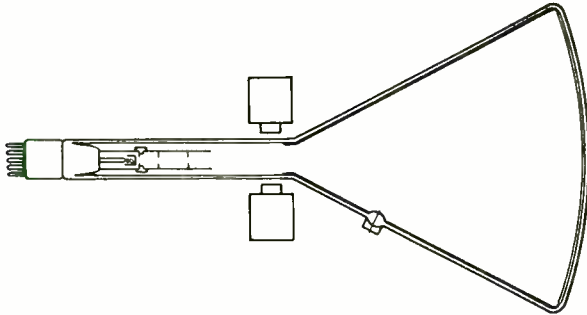

Fig. 2

cathode from which the cathode rays or, utilizing the modern term, the electrons are emitted; third, a device for concentrating, controlling and focusing of the electron beam; fourth, an arrangement (either internal or external) for deflecting the beam; and fifth, a fluorescent screen on which the received image is reproduced.

The envelope is usually made of glass, strong electrically and mechanically, and is designed to withstand atmospheric pressure with a large margin of safety. The tube during its processing is painstakingly baked and outgassed to maintain a very high vacuum of the order of  $10^{-7}$  cm. of mercury. The early tubes were partially gas filled and utilized for beam concentration, the space charge resulting from collisions of electrons with gas molecules. This so-called gas focusing is rather uncertain, since the gas pressure in any tube varies with life. If in a tube the focusing of the beam is critically dependent on pressure, the useful life of such a tube is short. Most of the modern cathode ray receiving tubes are of the high vacuum type where the concentration of the electron beam is accomplished by means of electric or magnetic fields produced between electrodes and poles. The vacuum treatment of the modern tubes is such that even at the end of the tube's life, that is, when the cathode

emission has fallen off, the vacuum is still sufficiently high so that collisions between electrons and molecules of the residual gas seldom occur.

The cathode is of a tubular form with a flat emitting surface covered with a preparation of barium oxide. Only the flat end, facing the fluorescent screen, is covered with the electron emitting material. A tungsten heater, non-inductively wound and insulated with a heat resisting material, is located inside of the tubular cathode.

The electron gun, or the device for concentrating, controlling and focusing of the electron beam, consists of a grid sleeve, and a first anode. Sometimes it includes another electrode, usually called screen grid, not essential for operation and not shown on the figure. The grid sleeve is of a tubular form with a disc parallel to the flat emitting surface of the cathode. A circular hole in the center of the disc is coaxial with the cathode sleeve. The first anode cylinder coaxial with the rest of the system is usually mounted by means of insulators on the grid sleeve. It carries diaphragms or aperture discs on the inside for stopping or limiting the beam angle and for limiting the penetration of electrostatic fields. The glass envelope of the "Kinescope" carries a black conductive coating on its inner side and has a sealed-in conductor leading to this coating. The conductive coating forms the last or the second anode. The final electron accelerating potential is applied between the cathode and the second anode.

The purpose of the first anode is to stop the beam similarly to an optical stop in a lens and to create an axially symmetric electrostatic field which would start the initially divergent electrons of the beams toward the axis. By adjusting the voltage on the first anode the fluorescent spot on the screen can be brought to a minimum diameter. The voltage on the first anode for best focus is usually about  $1/4$  or  $1/5$  of that on the second anode.

An electromagnetic system of focusing is shown on Fig. 3. A short first anode and the second anode are connected together to the source of the final accelerating potential and the concentrating field is produced by a multilayer solenoid coaxial with the tube and the gun.

The fluorescent screen is placed on the inner side of the front face of the tube. This face is usually as flat as mechanical strength permits. The material is usually either a sulphide or

a silicate of zinc and is deposited in a very thin translucent layer.

### OPERATION OF THE "KINESCOPE"

The operation of the tube is as follows: The electrostatic field created by the potential applied to the first anode penetrates the grid opening and draws the emitted electrons into a well defined beam. The grid is usually at a somewhat lower potential than the cathode and in this way limits the beam intensity. By

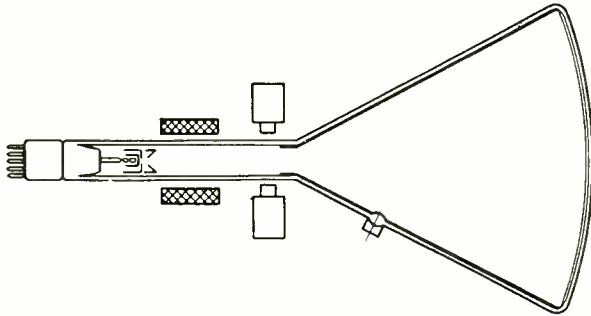

Fig. 3

applying a more negative potential to the grid the beam can be completely cut off. After entering the first anode, the beam passes through a masking diaphragm which cuts off some of the irregular peripheral portion of the beam. Then the beam enters the region of the field produced by the difference of potentials between the first and second anodes. In this field a strong focusing action takes place, which gives the electrons a radial component of velocity directed toward the axis of symmetry of the beam. The radial momentum acquired by the electrons is sufficient to bring them, after a flight through the equipotential space of the main body of the tube, to a focus at the screen.

Some of the electrons originally drawn from the cathode are cut off by the masking aperture. They return to the emf source through the first anode lead. The rest of the electrons strike the fluorescent screen. They excite the screen and dissipate most of their kinetic energy there. This kinetic energy has been acquired by the electrons through acceleration from the very small velocities of emission to that corresponding to the second anode voltage.

Some of the energy of the beam is transformed into light, some goes into heat raising the temperature of the glass, while the rest is spent in knocking out secondary electrons from the

screen material. These low velocity secondaries flow in a steady stream to the conductive coating of the second anode. An equilibrium condition is quickly established, the conductive coating acquiring the highest possible potential with respect to the cathode while the fluorescent screen slides a few score of volts below the potential of the coating. The difference of potentials between the fluorescent screen and the conductive coating is such that it draws the secondaries to the coating at exactly the same rate as the primaries are arriving to the screen.

Just as soon as the beam leaves the first anode it is subjected to the action of either magnetic or electric fields for the purpose of deflecting the beam in a predetermined manner. This deflection is scanning in television.

There are three ways of scanning, namely: first, by means of two electrostatic fields at right angles to each other; second, with two electromagnetic fields also at right angles to each other; and third, with an electrostatic and an electromagnetic field parallel to each other. It may be remembered at this point that the electrostatic field deflects electrons along the lines of force and that an electromagnetic field deflects them perpendicular to the lines of force.

The electrostatic deflecting plates are usually placed inside of the glass envelope while the electromagnetic deflecting coils are invariably outside the envelope.

### SCANNING REQUIREMENTS

Since most of the tube characteristics can be observed and measured only while actually scanning, we will take up the scanning means first. The purpose and principle of scanning have been treated at great length by many writers, so we will limit ourselves to the recollection of scanning requirements in a high definition television system.

In our organization we have made a thorough study of this subject and the following are some of the conclusions reached.\*

If we qualify and limit the ability to tell a desired story to specific conditions, the experience we have had with television allows us to make some interesting approximate generalizations. If we take as a standard the information and entertainment capabilities of sixteen-millimeter home movie film and equipment, we may estimate the television images in comparison.

\* See papers by E. W. Engstrom, I.R.E. Proc. Vol. 22, page 1241, Nov. 1934, and I.R.E. Proc. Vol. 23, page 295, April, 1935.

60	scanning lines	entirely inadequate
120	“	“ hardly passable
180	“	“ minimum acceptable
240	“	“ satisfactory
360	“	“ excellent
480	“	“ equivalent for practical conditions.

This comparison assumes advanced stages of development for each of the line structures.

We may say therefore that a number of scanning lines in the immediate vicinity of 360, say 340, will give a very good performance comparable with 16 mm home movie film.

In motion pictures the taking, or the camera frame frequency determines how well the system will reproduce objects in motion. This has been standardized at 24 frames per second. In television it is assumed that we shall use a frame frequency of 24 per second or greater. Since this is satisfactory for motion pictures, it is also satisfactory for television and this characteristic of frame frequency will, therefore, not be considered further.

In the reproduced image there is another effect of frame frequency. This is the effect of frame frequency on flicker. Motion picture projectors commonly used are of the intermittent type. The usual cycle of such a projector is that, at the end of each projection period, the projection light is cut off by a "light cutter", the film is then moved and stopped so that the succeeding frame registers with the picture aperture; the light cutter then opens, starting the next projection period. This is repeated for each frame—24 per second. Since projection at 24 light stoppages per second with illumination levels used in motion pictures causes too great a flicker effect, the light is also cut off at the middle of the projection period for each frame for a time equivalent to the period that it is cut off while the film is moved from one frame to the next. This results in projection at 24 frames per second with 48 equal and equally spaced light impulses. Such an arrangement provides a satisfactory condition as regards flicker. In television we also may have a reproduced image at 24 frames per second, but because of the manner in which the image is reconstructed, a continuous scanning process, it is not practicable further to break up the light impulses by means of a light chopper in a manner similar to that used in the projection of motion pictures. We, therefore, have for the usual systems of television a flicker frequency which corre-

sponds with the actual frame frequency (24 per second, for example). This is satisfactory at very low levels of illumination, but becomes increasingly objectionable as the illumination is increased.

It has been concluded that, in a television system, satisfactory flicker conditions exist if each frame consists of two groups of alternate lines and that there should be 24 or above of the complete double frames. This so-called interlaced scanning is equivalent to 48 or above frames per second as far as flicker is concerned.

At 48 equivalent frames and with a 60-cycle power system, the effects of hum or ripple travel across the reproduced image. The choice of 60 equivalent frames or 30 interlaced frames per second provides a complete solution to the visual requirements, i.e., motion, flicker and ripple.

#### ACCESSORY CIRCUITS

If we have to lay out a circuit to receive the television picture we have to provide: first, a suitable "Kinescope" with suitable power supply; second, a deflecting yoke for deflecting the beam vertically and horizontally at, say, the just-mentioned frame and line frequencies; third, for driving this yoke synchronously with the incoming signal, and fourth, an electric circuit to drive the grid of the "Kinescope" to provide the gradations of brightness on the screen.

The last item, of course, includes circuits for demodulating, amplifying, etc. of the incoming signal.

So far we have been discussing elementary generalities. Let us now consider somewhat in detail the question of the accessory circuits and of the arrangements required by the output device of a television receiver.

The first item is: a suitable "Kinescope" with a suitable power supply.

A typical set of characteristic curves of a "Kinescope" are given on Fig. 4. It is very similar to that of a four-electrode tube. The second anode current  $I_{p2}$  is shown as a function of grid bias; the current on the first or the auxiliary anode is also shown. But there are two quantities on the characteristic which do not appear on that of an ordinary vacuum tube. They are line width vs. grid voltage and total light vs. grid voltage.

The line width is measured by means of a microscope with a scale focused on an isolated scanning line, when a pattern is



scanned at normal scanning rates. The vertical deflection is increased until the adjacent lines separate by a centimeter or so. The total light is measured by means of a suitable illuminometer. The brightness units are rather confusing, just as all the light units. It is not hard to remember, however, that a perfectly diffusing area of 1 square foot and having brightness of one foot candle emits 1 lumen of luminous flux. One lumen of luminous flux from a flat surface is generated by a source whose intensity is  $1/\pi$  candle power.

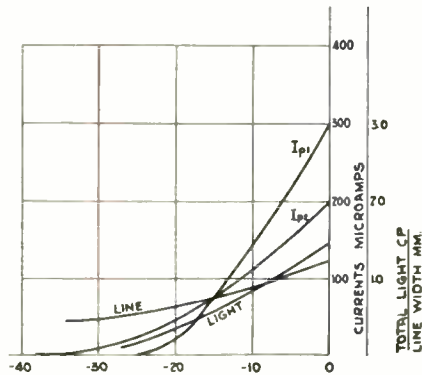

Fig. 4

The total light in most of the modern tubes is approximately proportional to the beam wattage or beam current at a constant beam voltage, the coefficient of proportionality being between 1 and 2 c.p. per watt. The tube, the characteristics of which are shown on Fig. 4, has a screen efficiency of 1.5 c.p. per watt.

Now let us see what kind of picture we can produce on this "Kinescope". Suppose it has a screen large enough to accommodate a 6" x 8" picture. For 340 lines it should have a line width of  $6/340 = .018$ ", or roughly .5 mm.

Experience, however, has taught us that the lines can be somewhat larger than this theoretical value because the intensity of the luminous spot falls rather rapidly as we go away from the center of it. A reasonable correction factor is about 1.6 times the theoretical value. This means that we may tolerate a line width up to .8 mm. From the characteristic curve we take the corresponding value of beam current: 86 microamperes at -14 volts on the grid. The cutoff we find to be -40 volts. This means that a grid swing of 26 volts peak to peak will drive this tube from black to maximum permissible high light.

From the same set of curves we find that the total light for this high light will be about .75 c.p. Now if the picture is 6" x 8" and we have an entirely white picture, we will get .75 c.p. of total light from 48 square inches. This amounts to 2.36 lumens from  $\frac{1}{3}$  of a square foot, equivalent to 7.1 foot candles. So the maximum brightness of the high lights in the received picture will be 7.1 foot candles. Now, remembering that the brightness of a picture in home movies is of the order of 10 to 20 foot candles, we may conclude that we will have a picture of a brightness comparable with that of home motion pictures.

The useful information which we obtained from the characteristic curve can be summarized as follows:

The "Kinescope" under consideration will produce a picture of detail corresponding to 340 scanning lines and 30 interlaced frames with approximately 7 foot candles in high light and a grid swing of 26 volts peak to peak. The power supply will have to provide 6000 and 1200 volts and have a sufficient regulation for 80 microamperes. The adjustable or automatic bias supply should go down to —40 volts.

#### DEFLECTING SYSTEM REQUIREMENTS

Four factors are important when considering a particular arrangement for deflecting or scanning. First, the system must require not more than a reasonable amount of power for a full size pattern; second, the luminous spot must maintain its size and shape when deflected to the edges of the pattern; third, the pattern must not deviate from its normal rectangular shape; and fourth, the system must be capable of giving a high enough ratio of the picture to return sweep. The properties corresponding to these requirements are:

Deflection sensitivity.

Freedom from defocusing of the luminous spot.

Freedom from distortion of the pattern.

High enough overall frequency response.

The above requirements apply to any system of deflection, but the mechanics of magnetic and electrostatic deflection differ greatly. Let us consider magnetic deflection.

The magnetic field for deflecting electron beams is produced by combinations of coils and poles which are often called the magnetic deflecting circuit. Since to supply power to such a

combination an electrical network or circuit is required, the latter also has been called the magnetic deflecting circuit. It sounds reasonable to call the whole combination "magnetic deflecting system and its component parts; magnetic driving circuit and magnetic deflecting yoke".

While the magnetic field in which we are interested is formed in air or vacuum rather, the magnetic deflecting yoke often contains iron for the purpose of confining the field and reducing reluctances of return paths, thereby reducing the total energy stored in the field for a given deflecting effect.

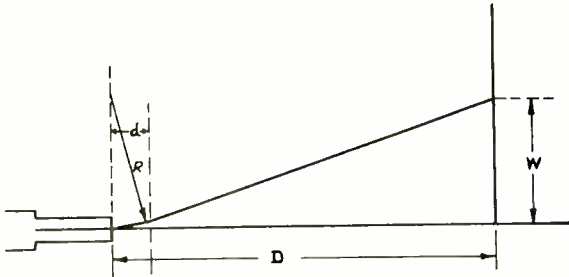

Fig. 5

A magnetic field gives an electron an acceleration at right angles to the direction in which it travels. Since it is always at right angles the electron cannot change its speed and can change only the direction in which it travels. The kinetic energy of an electron moving in a magnetic field is a constant quantity and therefore the radius of curvature " $R$ " of the orbit can be calculated from the law of conservation of energy. It comes out as

$$R = \frac{mv}{eH}$$

where  $e$ ,  $m$ ,  $v$  and  $H$  are charge, mass and velocity of the electron and  $H$  is the intensity of the magnetic field. Reduced to practical units this expression becomes:

$$R = 3.36 \frac{\sqrt{V}}{H}$$

where  $R$  is in cm.,  $V$  is in practical volts, and  $H$  is in Gauss or in Gilberts per cm. Referring to Fig. 5, let  $D$  be the gun screen

distance,  $d$  be the length of the magnetic field. The magnitude of the deflection  $W$  comes out as follows:

$$W = R + \frac{Dd - R^2}{\sqrt{R^2 - d^2}}$$

If  $d$  is small compared to  $D$  we get:  $W = Dd/R$

For a magnetic yoke of increasing length ( $d$ ), with the inductance kept at a constant value by corresponding reduction in the number of turns, the current required for a given deflection is proportional to the square root of the reciprocal of the length of the magnetic yoke. The power required for a given deflection and also the energy stored in the magnetic field comes out inversely proportional to the length of the deflecting yoke. This means that if we can deflect a given beam by means of two power tubes, doubling the length of the deflecting yoke will require the use of only one tube to accomplish the same result.

A measure of the sensitivity of a particular magnetic deflecting system is the amount of total energy  $\Sigma$  stored in the magnetic field for a given full deflection, from one edge of the tube to the opposite edge.

$$\Sigma = \frac{L_o I^2}{2}$$

Here  $\Sigma$  is in joules,  $L_o$  is in henries and  $I$  is in amperes. If the picture is repeated  $n$  times per second and after each picture sweep this energy is dissipated, then the output tube should be capable of delivering  $n\Sigma$  watts to the yoke. This value, however, is not as important as the product in voltamperes of the voltage across the yoke during picture sweep by the maximum current amplitude thru the yoke.

The ability of the power tube to supply a deflecting yoke has been treated in detail in one of the earlier papers (1932) by the author, and will not be repeated here.

#### DEFECTS OF THE SCANNING PATTERN

There are two main forms of defects of the scanning pattern on the screen of cathode ray tubes. The first is defocusing of the luminous spot, and the second is the distortion of the scanning pattern. By defocusing of the luminous spot is meant the change of the size of the spot when deflected. By distortion

of the scanning pattern is meant the deviation of the pattern from its normal rectangular shape.

The degree to which the above defects may be present in a particular deflecting system is determined primarily by the shapes and types of the deflecting fields. There are two more common defects caused more or less by the deflecting circuit as a whole. They are: non-uniform distribution of the scanning pattern or non-linearity of the sweep, and the crosstalk between the vertical and horizontal circuits. For the first of these, the wave shape of the magnetic driving circuit and the frequency response of the yoke are responsible. For the second, either the coupling between corresponding driving circuits or the coupling between the fields of the yoke may be the cause.

Both the static and the magnetic deflecting systems are subject to the defects enumerated above, and the work on improving both types has been in progress for several years. The early high definition systems in this country employed magnetic deflection both ways, early foreign systems showed preference for the electrostatic both ways. At present most of the systems used in this country utilize either a combination of static magnetic deflection or the all-magnetic systems.

The combined system provided only a partial solution, however. The main source of trouble in such a combination is the defocusing of the spot by the electrostatic field. A certain small amount of similar defocusing shows itself even in the best modern magnetic deflecting systems. The old magnetic systems had an exceedingly large amount of defocusing. All-magnetic systems seem best from the viewpoint of defocusing difficulties. Most of what follows refers to all-magnetic deflecting system.

#### DEFOCUSING OF THE LUMINOUS SPOT

Magnetic defocusing is caused by two factors: first, for a given non-uniform magnetic field it is a function of the diameter of the beam while it is under the action of the field, and second, for a given cathode ray tube it is a function of the non-uniformity of the field in the direction of deflection. The mechanism of defocusing will be better understood by considering Fig. 6. Take an electron beam of a circular cross-section with electrons moving parallel to each other. Such a beam before it is deflected will produce a luminous spot *B* on the screen. This spot will be of a circular shape. Now let us deflect the beam to one side of the screen by means of a magnetic field produced by electro-

magnets:  $C$  and  $C_1$ . Following the right-handed screw rule the beam will be so deflected that the spot will shift to  $D$ . The magnetic field produced by the two coaxial bar magnets will be of a barrel shape form and will be the densest in the middle. The cylindrical electron beam had initial direction toward the center

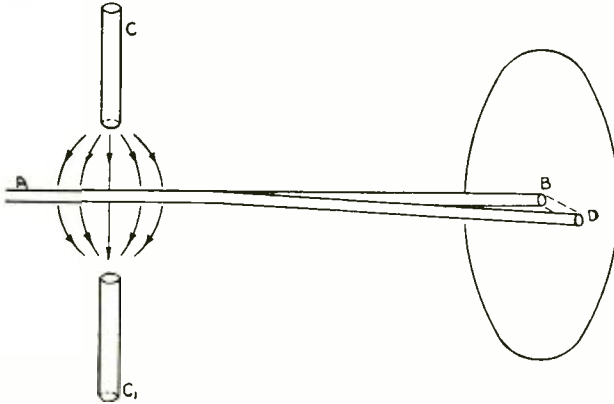

of this field, but when deflected it will miss the axis. The side of the beam which is closest to the axis will be deflected more. The side directly opposite will be deflected less. The spot will be compressed along the direction of deflection. It can be shown

Fig. 6

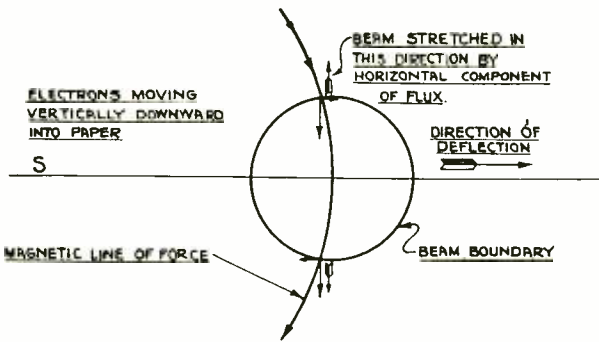

Fig. 7

mathematically that any non-uniform magnetic field possesses a certain curvature, which is a function of the non-uniformity.

Fig. 7 shows a beam of cylindrical shape being deflected away from the center of a barrel shape field. Away from the plane of symmetry of the field, the curvature of the field results in a component of the field parallel to the plane of symmetry. These components, however, have opposite directions on the opposite

sides of the plane of symmetry. In the case shown the upper and the lower parts of the beam will be stretched away from the plane of symmetry in opposite directions. This will change the shape of the spot from a circle to that of an ellipse with a major axis perpendicular to the direction of deflection. Therefore we may conclude that the non-uniformity of the field and the curvature of it both act to change the luminous spot into an ellipse with its major axis perpendicular to the direction of deflection. But this will hold only if the direction of deflection is away from the region of the field where it is most concentrated.

When a cylindrical beam is pulled into a field towards the region where it is more concentrated, the beam is stretched into an ellipse with its major axis parallel to the direction of deflection. We may look at the effects of non-uniform fields from another angle. A non-uniform field affects a cylindrical beam as a divergent cylindrical lens.

For deflection towards weaker regions of the field, the axis of this lens is parallel to the plane in which the direction of the deflection lies. For deflection toward stronger regions of the field, the axis is perpendicular to this plane, and the larger the beam diameter the larger the effect of a given field.

So far we considered only the cylindrical beams. In practice we always have converging beams, which are either focused, or underfocused, or overfocused. It can be shown by reasoning similar to that just given that if a field stretches an overfocused beam in a particular direction, a readjusting of the focusing field to give an underfocused condition will stretch the spot in a direction perpendicular to the former.

#### DISTORTION OF THE SCANNING PATTERN

By distortion of the scanning pattern is meant the deviation of the pattern from its normal rectangular shape. When all the four corners are pulled away farther than they should be, we get a pincushion pattern and when these corners are not pulled far enough we get a barrel pattern.

Distortion as well as defocusing is caused by the non-uniformity and the curvature of deflecting fields. A combination of two magnetic deflecting fields, each of which is of barrel shape distribution, causes a pincushion pattern. A combination of two pincushion fields produces a barrel shape pattern. The reason for these effects can be better understood by considering Fig. 8.

Fig. 8A shows how the components of two pincushion fields add together and give a comparatively small resultant for corner deflection and a barrel shape pattern. Similarly the components of two barrel shape fields add together as shown on Fig. 8B and give a comparatively large resultant and a pincushion pattern.



Fig. 8

### OVERALL FREQUENCY RESPONSE

To reproduce a saw tooth wave shape the magnetic deflecting yoke should be capable of responding to many harmonics of the saw tooth frequency. Other ways of obtaining the same result have been suggested, but so far have not proven sufficiently advantageous to warrant a treatment here. For an infinite ratio of picture to return sweep the co-efficients of successive harmonics are inversely proportional to the order of the harmonic. If the amplitude of the fundamental is 1, the second harmonic comes out as a half, and the third harmonic as a third, and the tenth as a tenth. Meaning that the tenth harmonic is of an amplitude equal to ten per cent of the fundamental. Now this is sort of high. Let us figure it out: 340 lines and thirty frames—this makes 10,200 lines or sweeps or cycles of the fundamental per second. This means that the tenth harmonic has a frequency of 102 kilocycles and contributes ten per cent to the wave. Fortunately we synchronize the picture every frame and every line. For positive synchronizing we have to take about 10 per cent of the time. This permits us to have, say, a ten to one ratio. Now for a nine to one ratio (which is easier to compute than the 10:1 case) of the saw tooth wave, if the amplitude of the fundamental is 1, the amplitude of the second harmonic comes out as .495, the third .300, the fourth .187, the fifth .131, and the tenth comes out negligible. So we may add to the requirements of a deflecting system that it must be capable of responding to a frequency band extending from the fundamental of the saw tooth frequency to its tenth harmonic.



## CROSS TALK

Frequently in a deflecting system, a serious cross talk takes place between the horizontal and vertical circuits. Usually it is the horizontal impulse which finds its way into the vertical deflecting circuit and produces wavy zigzag scanning lines instead of straight lines. It may be caused by coupling of some sort between the driving circuits. This kind of cross talk is usually eliminated by electrically isolating and shielding the respective circuits. Often, however, it takes place because of either electrostatic or magnetic coupling between the coils of the deflecting yoke. The type and degree of coupling is usually definitely connected with electric, magnetic and physical arrangements peculiar to this particular type. It cannot be treated, therefore, in general, and has to be studied individually with every particular type of deflecting system.

As a rule, however, the cross talk can be eliminated by so arranging the coils on the yoke that the undesired induced voltages and currents buck each other out. Sometimes it calls for connecting horizontal coils in parallel and vertical in series. In other cases, both should be connected in parallel, while in some, no cross talk is produced under any conditions.

## IRREGULAR DEFECTS

In our discussion of defects of the scanning pattern, we considered so far only the perfectly symmetrical yoke and a centrally located electron beam. If, however, for any reason either the beam is not centrally located with respect to the yoke, or the magnetic return legs of the yoke are not symmetrical, or the coils are not symmetrically located, the irregular defects of the scanning pattern result. If the deflecting field is sufficiently uniform, the position of the beam with respect to the yoke is not as critical as in the case of a non-uniform field.

Any non-symmetry in the yoke, however, ruins the uniformity of the field and immediately shows itself by producing defocusing in a part of the picture, stretching a corner or a side of the pattern and usually producing serious cross talk. The symptoms of the irregular defects are such that they are easily located and eliminated by tracing defective coils and by checking the geometry of the yoke and the cathode ray tube.

In conclusion let us consider a deflecting yoke of the type shown in Fig. 9. Two such yokes sufficiently spaced give a very

good pattern for a 340-line 30 interlaced frame picture. It is balanced to give a very uniform field along the directions of deflection. Along the beam it naturally gives a wall of flux, so to speak, and a wall of uniform height.

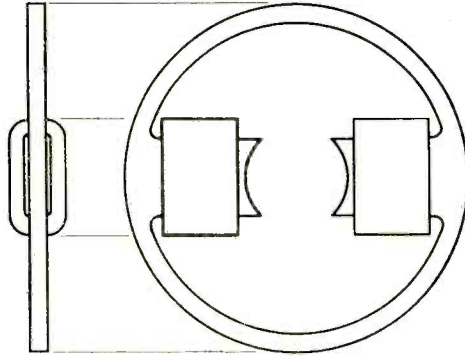

Fig. 9

# SCANNING SEQUENCE AND REPETITION RATE OF TELEVISION IMAGES

BY

R. D. KELL, A. V. BEDFORD, AND M. A. TRAINER

(RCA Manufacturing Company, Inc., Camden, New Jersey)

*Summary*—This paper considers factors which affect the apparent steadiness of television images: namely, line flicker, flicker of the image as a whole, alternating-current ripple in the deflecting circuits, alternating-current ripple in the video frequency signal, and various kinds of beating of the alternating-current ripple with the various scanning frequencies. It is concluded that an integer ratio between alternating-current ripple frequency and frame frequency is very desirable for progressive scanning and is almost imperative for interlaced scanning. Interlaced scanning with a frame frequency of thirty per second and a field frequency of sixty per second fulfills the requirements in regard to flicker and the relations to alternating-current ripple frequency for a sixty-cycle power source, and offers considerable net gain over other scanning procedures considered. The problems of both odd- and even-line methods of interlacing are discussed and the odd-line method is found preferable.

## INTRODUCTION

**A**FTER considerable experience with the experimental installation previously described,<sup>1</sup> it was concluded that the most objectionable features of the television image were flicker and other unsteadiness.

It is well known that the frequency band required to transmit a television picture is proportional to the product of the picture detail and the frame frequency. (The frame frequency is the number of times per second the picture area is completely scanned.) Since the available frequency band is limited, it is desirable to determine the picture repetition rate which makes the optimum use of the frequency band with regard to picture detail and freedom from flicker. This must be largely a matter of judgment where the psychological aspects are important. As will be seen the decision will be influenced by other factors such as motion picture standards, existing power system frequency, and scanning sequence.

Reprinted from Proceedings of the Institute of Radio Engineers.

## CATHRODE-RAY SCANNING

At present cathode-ray scanning gives the greatest promise for a television system. This involves for example the use of the iconoscope as a pickup device at the transmitter and the kinescope at the receiver.<sup>1</sup> Both devices are similar in that an electrostatically focused beam of electrons is deflected vertically by the magnetic field produced by a saw-tooth wave of current [Fig. 1(a)] and horizontally by either a magnetic or electrostatic field produced by a saw-tooth wave of voltage of a much higher fre-

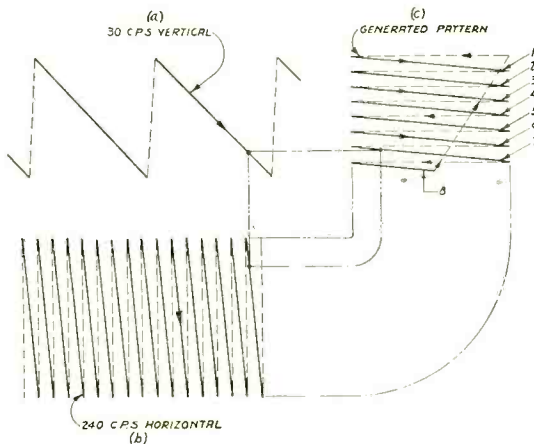

Fig. 1—Generation of a progressive scanning pattern.

quency [Fig. 1(b)]. The action of the two deflecting fields is to cause the light-sensitive screen of the iconoscope or the luminescent screen of the kinescope to be uniformly scanned by the electron beam as shown in Fig. 1(c). In this as well as the following figures, the line frequency is shown as approximately 200 cycles to facilitate illustrating, while in practice it is about 7000 cycles. The return path for each line is shown dotted.

## ALTERNATING-CURRENT POWER SUPPLY RIPPLE

Alternating-current power-operated receivers contain sixty-cycle and 120-cycle disturbances in the direct voltage supplies which operate the receiver. In sound reception this is called

<sup>1</sup> R. D. Kell, A. V. Bedford, and M. A. Trainer, "An experimental television system," *Proc. I.R.E.*, vol. 22, pp. 1246-1265; November, (1934); R. S. Holmes, W. L. Carlson, and W. A. Tolson, "An experimental television system," *Proc. I.R.E.*, vol. 22, pp. 1266-1285; November, (1934).

“hum” but in the present paper the term “alternating-current ripple” will be used since the term “hum” implies audibility.

Alternating-current ripple in cathode-ray television shows itself in several ways. When superimposed upon the deflection of the scanning beam it produces the wavy edges as shown in Fig. 2(a) in the case of the horizontal deflection, and causes the nonuniform spacing of the lines of the picture as shown in Fig. 2(b) in the case of the vertical deflection. When the ripple exists in the cathode-ray anode voltage supply, it alters the stiffness of the beam as regards deflection and thereby modulates the

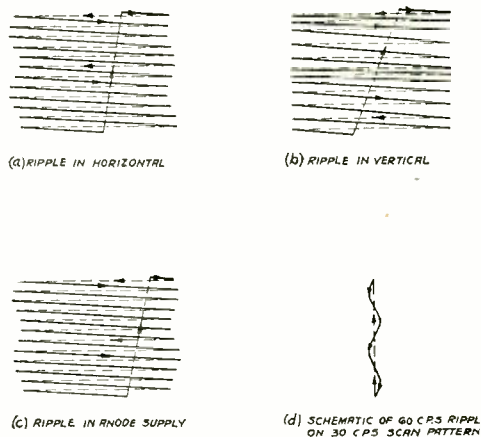
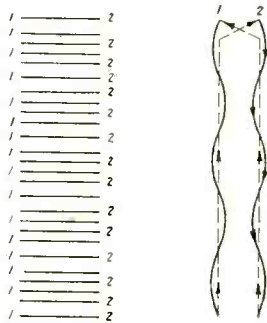

Fig. 2—Effect of sixty-cycle ripple on a thirty-cycle progressive scanning pattern.

deflecting influence of both the deflecting waves. This effect upon the horizontal deflection is shown in Fig. 2(c). It should be understood that these effects operate not only to distort the shape and density of the scanning pattern, but also cause the misplacement of the details of the picture. The presence of alternating-current ripple in the video frequency amplifier causes the pattern to vary alternately in brightness from top to bottom of the picture. (This effect is not shown in the figures.) Actually all of these effects occur simultaneously though for clearness they have been shown separately.

We now reach a very important point in regard to the psychological effect of alternating-current ripple; i.e., whether the distortion produced (ripple pattern) is stationary or moving with respect to the scanning pattern. In the case of the thirty-frame per second scanning as shown in Fig. 2, the ripple pat-

tern is stationary and hence is much less objectionable than if it were moving. That the ripple pattern is stationary is evident from a study of Fig. 2(d) and the fact that thirty is a whole number submultiple of sixty. However, in the case of a twenty-four frame per second picture with sixty-cycle ripple, the alternate frames have distortion of opposite phase (see Fig. 3). This is true since sixty divided by twenty-four is a whole number plus a half, which may be interpreted to mean that the ripple pattern passes over the scanning pattern twelve times per sec-



(a) SCHEMATIC OF 60 CPS RIPPLE ON 24 CPS PROGRESSIVE SCAN PATTERN. ALSO EFFECT UPON VERTICAL DISTRIBUTION.

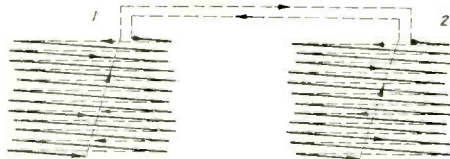

(b) ALTERNATE VERTICAL CYCLES FOR 24 CPS PROGRESSIVE SCAN PATTERN WITH 60 CPS RIPPLE ON THE HORIZONTAL DEFLECTION.

Fig. 3

ond (since twelve is one half of twenty-four). The figure shows clearly that two vertical scanning cycles are required to make a complete cycle of motion of the beam. This is one of the worst conditions possible, since any element of detail in the picture jumps from one position to another position near by at a frequency of twelve cycles. This causes fatigue of the eye in so far as the observer is able or attempts to follow the elements of detail in their shifting of position, and a loss of resolution or blurring of the picture in so far as the eye fails to follow the

shifting. The presence of sixty-cycle ripple in the picture signal also causes a twelve-cycle flicker of portions of the picture.

In case some picture repetition rate between twenty-four and thirty, say twenty-seven, is chosen, the "ripple pattern" will drift upward across the picture at the rate of about six cycles of ripple per second. At this rate, the eye would be able to follow the elements of picture detail so that no appreciable loss of resolution would be observed, but due to the propagation of the "ripple pattern" the picture would be given annoying effect of motion, similar to that experienced when viewing stationary

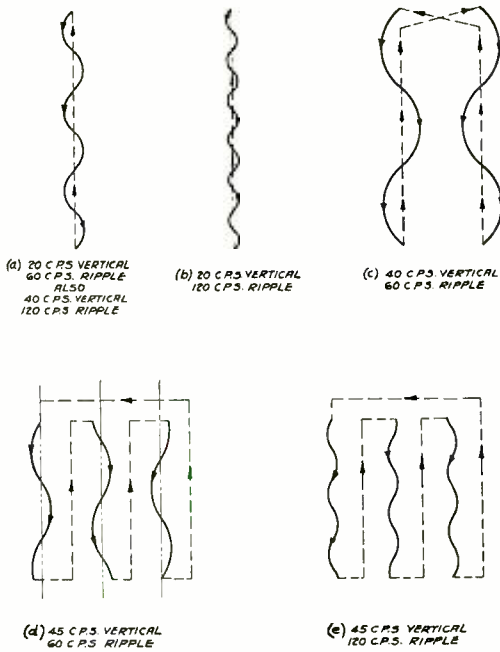

Fig. 4—Schematic representation of alternating-current ripple on various scanning patterns.

objects submerged in water having waves on its surface. Figs. 4(a) and (b) show schematically some standing ripple patterns for various scanning conditions, while (c), (d), and (e) show some conditions for moving ripple patterns that repeat in two or three vertical scanning cycles.

From the foregoing considerations and from tests, it seems desirable that the picture repetition rate be some integer sub-multiple of sixty, such as ten, fifteen, twenty, or thirty. So far as continuity of motion in the picture is concerned, it is prob-

able that fifteen or twenty would be high enough, although the motion picture standard is twenty-four per second. However, a much higher repetition rate is required in order to reduce picture flicker to a satisfactory level. From data previously presented about forty-eight pictures per second would be required even if no allowance is made for increase in picture brightness by future developments.<sup>2</sup>

Since sixty has no integer submultiple between thirty and sixty, it would seem that the adoption of a repetition rate of sixty per second is required for operation from a sixty-cycle power source. Increasing the picture repetition rate and hence the frequency band in the ratio of sixty to fifteen to eliminate flicker may be giving flicker elimination the advantage in the compromise with picture detail. Yet numerous tests have shown that thirty frames per second is distinctly unsatisfactory in regard to flicker.

#### ODD-LINE INTERLACED SCANNING

At least a partial solution of the problem has been provided by interlaced scanning, in which alternate lines are scanned in successive vertical deflection cycles. Such scanning procedure is old in the television art as produced by the scanning disk in which two or more spirals of apertures are used. In the case of two spirals the interlacing is obtained by locating the apertures on the disk radii such that the apertures of one spiral scan the even-numbered lines and the apertures of the second spiral scan the odd-numbered lines.

An interlaced scanning pattern must be obtained in cathode-ray television by electrical methods. The odd-line method, as the name implies, makes use of an odd number of horizontal scanning lines for each two vertical scanning cycles. For example, the condition now considered optimum for a video frequency band of 750 kilocycles is 243 lines in the complete picture, the frame frequency being thirty and the field frequency being sixty cycles. This makes the horizontal scanning frequency 7290 cycles and the lines per vertical deflection cycle  $121\frac{1}{2}$ . The half line left over at the end of each vertical cycle causes the alternate vertical deflection cycles to start 180 degrees apart with respect to the horizontal deflection cycle. Fig. 5 indicates how this will produce the interlaced effect. The lines 1, 3, 5,

<sup>2</sup> E. W. Engstrom, "A study of television image characteristics—Part II," *PROC. I.R.E.*, vol. 23, pp. 295-310; April, (1935).



etc., are scanned during odd vertical saw-tooth cycles, whereas lines 2, 4, 6, etc. are scanned during the even vertical saw-tooth cycles. The arrows in the figure indicate the path of the scanning beam. Geometric construction for any point  $p$  in the pattern is shown by the broken line. (The light solid lines show a variation in timing to be discussed later.)

Any one line is repeated only thirty times per second but no line flicker is perceptible because of the extremely small area occupied by a single line, and because of the small angle subtended at the eye by a single line. From data previously presented,<sup>2</sup> these factors are known to reduce flicker. Two or more

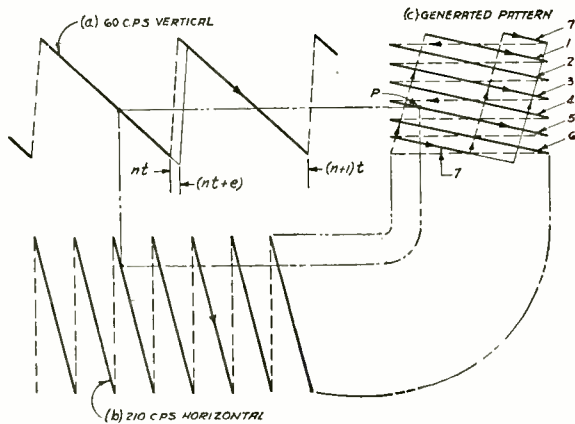

Fig. 5—Generation of interlaced scanning pattern by odd-line method.

alternate lines cannot co-operate to produce a thirty-cycle flicker by combining their area because if the eye includes more than one line, the intermediate lines will be unavoidably seen and the eye is subjected to the sixty-cycle alternating light effect as produced by the picture acting as a whole. One exception to this is possible but not probable and would occur when the subject matter of the transmitted picture chances to contain horizontal lines which agree in position with the scanning lines such as to cause alternate lines to be dark over an appreciable area of the screen. Tests with this method of scanning have proved very satisfactory from the point of view of flicker for any ordinary picture subject matter.

One slightly objectionable optical effect is noticeable in interlaced scanning pictures when objects in the scene move rapidly. If the motion is horizontal, the edges of the object appear to be jagged. This is due to the fact that a moving object

is transmitted as a rapidly changing series of "stills" and that each alternate "still" is composed of only one set of alternate lines and that each "still" is slightly displaced horizontally with respect to the one preceding. On the other hand the motion is actually portrayed more accurately by the thirty to sixty interlaced scanning than with thirty-frame progressive scanning, since the moving object is shown in sixty positions per second instead of thirty. This gain, however, is considered not to be of practical value.

When an object in the scene moves vertically, the apparent jagged edges of the object are not evidenced, but the entire

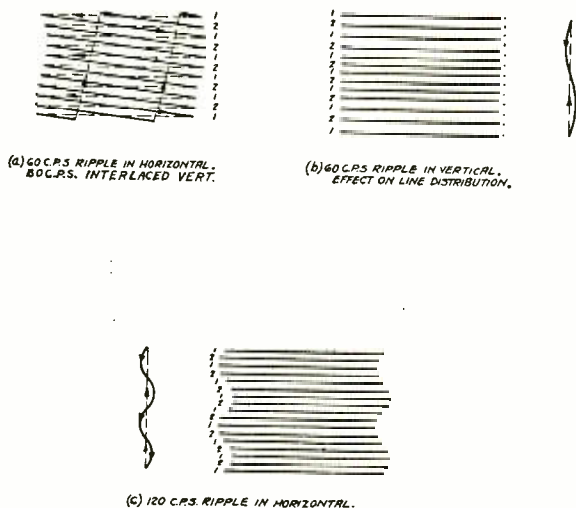

Fig. 6—Effect of ripple on thirty- to sixty-cycle interlaced pattern.

object may appear to be transmitted by a system having only half the total number of lines. This effect is complete and at its worst only if the motion is at the rate of one line pitch per one sixtieth of a second or an integer multiple thereof. This loss of detail in a moving object is largely offset by the well-known fact that moving objects require less resolution in order to be understood, and that the eye cannot resolve minute detail in moving objects.

The effects of sixty-cycle and 120-cycle ripple upon interlaced patterns is shown in Figs. 6, 7, and 8. In the case of thirty- to sixty-cycle interlaced scanning (Fig. 6) the effects are very much the same as for thirty-cycle progressive scanning. The lines are displaced according to the sine law hori-

zontally as shown in Figs. 6(a) and (c), and vertically as shown in Fig. 6(b). However, adjacent lines of the even and odd vertical deflections are all displaced similarly so that slight fixed distortion of the picture is the only ill effect. Such distortion may have a magnitude equal to several times the line pitch for a 243-line picture without being serious.

For a twenty-four- to forty-eight-cycle interlaced pattern, Fig. 7(a) shows that four vertical deflection cycles are required for a complete recurrence of sixty-cycle ripple, and Fig. 7(b)

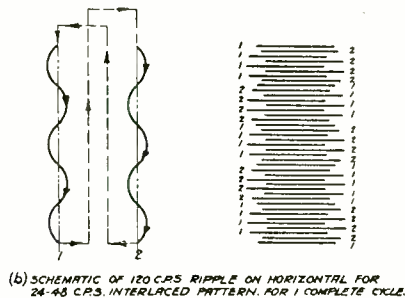
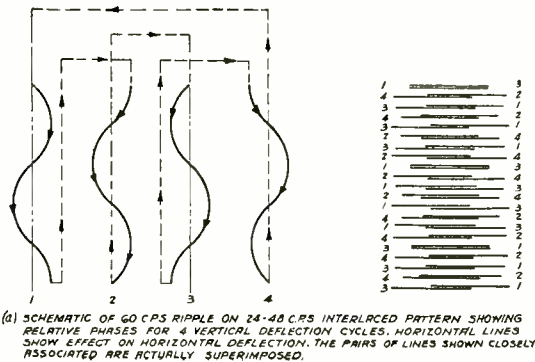
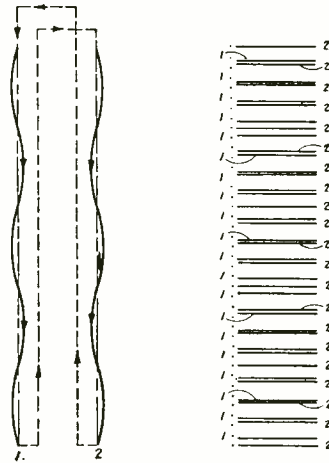

Fig. 7

shows that two are required for 120-cycle ripple. The horizontal lines in these figures are numbered to show to which deflection cycle they belong. (The return lines are omitted and the magnitude of the ripple effect is exaggerated to simplify illustration.) Fig. 8 shows the vertical displacement due to 120-cycle ripple. It is apparent that adjacent even and odd lines will be displaced in opposite directions, thereby causing serious loss of detail if the relative displacement has magnitudes comparable to the width of a picture element. (Such magnitudes of dis-

placement would be unobservable in the case of the thirty to sixty interlaced pattern due to the similarity of displacements of adjacent lines.) The effect of ripple on the twenty-four- to forty-eight-cycle patterns is further objectionable in that horizontal displacement of lines causes the objects in the transmitted scene to appear to have jagged edges. The vertical displacement causes severe "pairing" of the lines in certain portions of the picture thereby destroying the benefits of interlacing and causing these portions of the picture to appear particularly coarse in structure by contrast with other portions. No figure shows the vertical displacement for sixty-cycle ripple but the net effect is very similar to that shown for 120-cycle ripple.



SCHEMATIC OF 120 C.P.S. RIPPLE ON 24-48 C.P.S. INTERLACED PATTERN. EFFECT ON LINE DISTRIBUTION.

Fig. 8

The odd-line method of producing interlacing as described requires only uniform saw-tooth wave shape deflection in which the vertical and horizontal scanning frequencies bear to one another a fixed ratio which is a whole number plus one half. To maintain these simple relations, however, presents several problems, mostly arising from the fact that the alternate vertical deflecting cycles start at different times with regard to the horizontal deflections. These starting times are shown as  $t_0$  and  $(t_0 + 1/60)$  seconds in Figs. 9(a) and (b). The two waves shown are two different sections of the synchronizing wave, occurring alternately one sixtieth of a second apart. The "even vertical" synchronizing impulse occurs immediately following

a horizontal synchronizing impulse while the "odd vertical" starts about midway between two "horizontals." Both vertical impulses have sections removed in order to accommodate "horizontals" that occur during the "vertical" in order that horizontal synchronization may be maintained continuously.

In one workable system, the synchronizing impulses Figs. 9(a) and (b) are transmitted by the picture transmitter and

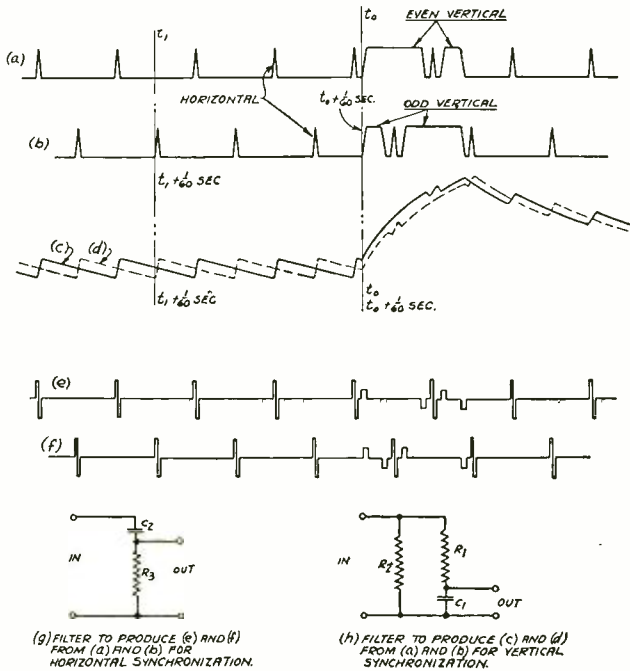

Fig. 9

separated from the picture signal in the receiver by virtue of their greater amplitude of transmission.<sup>1</sup> The impulses are then impressed upon a filter substantially as shown in Fig. 9(g) in order to obtain the impulses (e) and (f) for synchronization of the horizontal deflecting circuit. The function of the filter is primarily that of differentiation so that the output wave has magnitudes which depend upon the slopes of the input wave. The blocking oscillator for the horizontal deflecting circuit is not responsive to the small portion of the "vertical" impulse present in the wave (e) and (f) due to their timing as well as their reduced amplitude.

The impulses of Figs. 9(a) and (b) are also impressed upon the filter of Fig. 9(h) to obtain the alternate waves such as

Figs. 9(c) and (d) for the synchronization of the vertical deflecting circuit. This filter primarily integrates the impulses of the input wave as the output is the voltage across a condenser  $C_1$  charged through a resistor  $R_1$ . The "horizontal" impulses have amplitudes greatly reduced in comparison with the "vertical" impulses due to their shorter duration. However, a study of (c) and (d) shows that the "vertical" impulses differ considerably from one another in their amplitude corresponding to any short interval after  $t_0$  or  $(t_0 + 1/60)$  seconds on the increasing side of the peak. This difference, which is due to the dissymmetry of the "horizontals" with respect to the two "ver-

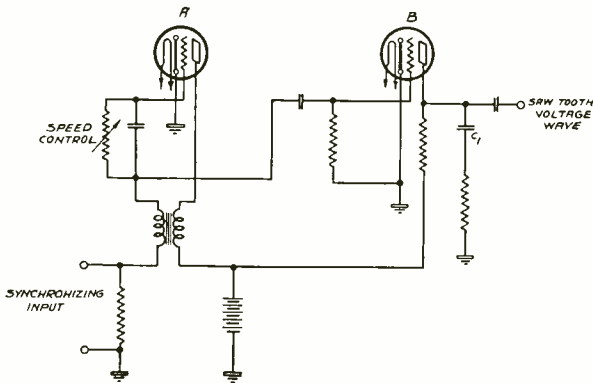

Fig. 10—Blocking oscillator and saw-tooth generator.

ticals," tends to cause the oscillator used in the vertical saw-tooth deflecting circuit and synchronized by (c) and (d), to operate at a nonuniform speed. It also tends to make the alternate even and odd saw-tooth strokes differ slightly in amplitude as will be evident from a study of the method of generation of the saw-tooth wave by the circuit of Fig. 10. The tube A and associated circuit comprise the blocking oscillator which generates impulses such as the wave of Fig. 11(g), which has an amplitude about fifty times as great as the synchronizing wave, Figs. 9(c) and (d). In the circuit it is apparent that the synchronizing wave, though intentionally impressed upon only the oscillator, is also impressed through the transformer winding upon the grid of the discharge tube B, along with the output of the oscillator. The amount of each discharge of the condenser  $C_1$  is dependent upon the amplitude, shape, and duration of the

impulse supplied to the grid of tube *B* during the discharge time. The difference in waves (c) and (d) of Fig. 9 causes these factors to differ slightly for the even and odd impulses, thereby causing the alternate discharges of condenser  $C_1$  to differ slightly in amplitude. The net effect of this is a slight vertical displacement of the horizontal lines of the odd vertical cycles with respect to those of the even cycles. (Further explanation of this phenomenon will be given below in connection with "even-line" interlacing.) The displacement will be so great as to destroy completely the benefits and appearance of interlacing if the difference in magnitude of alternate discharges differs by as much as 0.41 per cent. A lesser amount will cause the lines to be grouped in pairs.

Extremely accurate timing of the alternate vertical saw-tooth generating discharges is not directly necessary for sufficiently uniform spacing of the lines in interlaced scanning. In Fig. 5 the light solid lines show the change caused in the generated pattern when the even discharges begin at a time  $(nt+e)$  instead of time  $nt$  as would be required for perfect timing. As drawn, the interlacing is not impaired, the assumption being made that all discharges are identical in magnitude. Actually the delayed discharge would be slightly greater due to a slightly greater average voltage on the plate of the discharge tube during the discharge. (For a screen-grid type discharge tube, this discrepancy would be less.) However, indirectly nonuniform timing has a large effect upon the spacing of the lines since it alters the time relation of the synchronizing impulse to the discharge time and thereby changes the effectiveness of the synchronizing impulses as a contributor to the magnitude of the discharges.

Several methods have been developed which satisfactorily overcome the dissymmetry of the "integrated" synchronizing impulses. One method is to make the synchronizing impulses identical in the region of the even and odd vertical synchronizing impulses. This is accomplished by the arbitrary introduction at the transmitter of additional impulses similar to the horizontal synchronizing impulses. They are located midway between each two regular horizontal synchronizing impulses for an interval of a few line periods before and during the vertical synchronizing impulses, as shown in Figs. 11(a) and (b). The vertical synchronizing impulses are interrupted at half-line period intervals in order to accommodate the regular and the

additional horizontal synchronizing impulses. The first additional impulse "p" may be of different duration than the others in order to compensate partially the charge in the "integrating" condenser for the necessary dissymmetry preceding the region of additional impulses. The partially integrated waves of the even and odd vertical synchronizing waves are respectively shown at (c) and (d), Fig. 11. They are practically identical during the occurrence of the oscillator impulse (g).

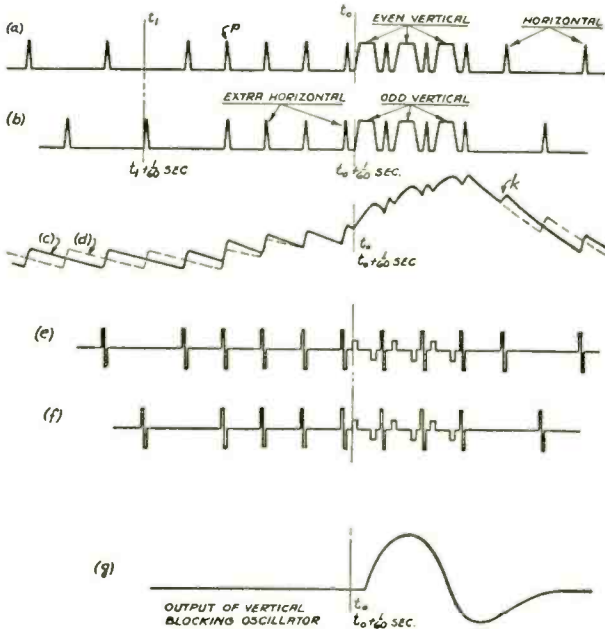

Fig. 11—Synchronizing waves for odd-line interlaced scanning.

Of course, the "extra horizontal" impulses pass through the horizontal impulse selecting filter the same as do the regular "horizontal" impulses, Figs. 11(e) and (f). However, due to their timing, the blocking oscillator of the horizontal deflecting circuit does not respond to them. Use of the modified synchronizing wave has resulted in better operation with less critical adjustment of the vertical deflection speed control and of the amount of impressed synchronizing signal.

Another method for overcoming the effect of dissymmetry of the synchronizing waves upon interlacing involves the use in the receiver of an additional vertical frequency blocking oscillator, which serves as a "buffer." This oscillator synchronizes



on the "integrated" synchronizing wave and in turn supplies synchronizing impulses having a higher degree of uniformity in amplitude to the blocking oscillator used to produce the saw tooth of voltage. However, the alteration of the synchronizing wave is the preferred solution, since it entails no additional receiver equipment.

Dissimilar vertical saw-tooth waves may also be caused by "cross talk" between the horizontal and vertical deflecting circuits in the receiver. This may be overcome satisfactorily by moderate shielding and the exercise of care in the location of parts.

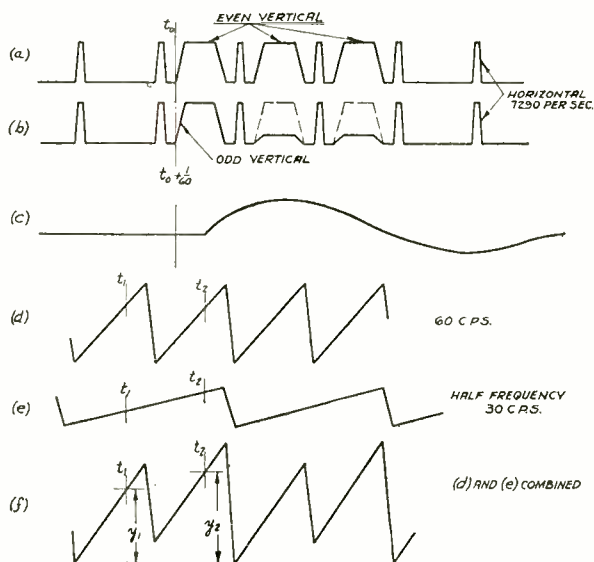

Fig. 12—Even-line interlacing.

### EVEN-LINE INTERLACED SCANNING

The even-line method of interlacing involves the utilization of the phenomenon which was just described as the greatest handicap of proper interlacing by the odd-line method, namely, dissimilar even and odd vertical saw-tooth generating discharges. For the sake of analysis a train of discharge impulses of sixty-cycle recurrence frequency, but having alternate impulses of unequal amplitudes, may be considered to consist of two separate trains of discharge impulses as follows, acting simultaneously: One uniform train of sixty-cycle impulses and one uniform train of thirty-cycle impulses having an amplitude equal to

the difference in the alternate discharges of the original train of impulses. These two trains respectively produce the saw-tooth waves of Figs. 12(d) and (e) which combined make the wave of Fig. 12(f).

For the purpose of illustration, the wave of Fig. 13(b) represents a horizontal deflecting saw-tooth wave of four times the frequency of the vertical wave. Fig. 13(c) represents the scanning pattern traced on the iconoscope or kinescope when deflected simultaneously by the vertical and horizontal waves of Fig.

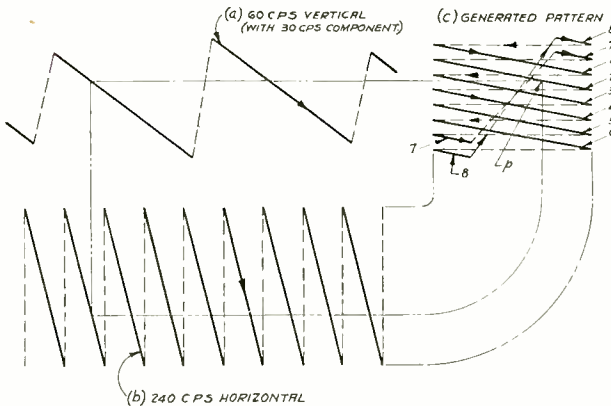

Fig. 13—Generation of interlaced scanning pattern by even-line method.

Figs. 12(a) and (b). The arrows on the lines show the direction of travel of the scanning beam. This pattern readily indicates that an interlaced effect will be obtained because the lines for adjacent vertical scanings are alternated in position. Also the fact that the similar lines for adjacent vertical scanings will not fall upon one another will be clear from Fig. 12(f) since  $y_1$  and  $y_2$  corresponding to  $t_1$  and  $t_2$ , respectively, are not equal when  $t_1, t_2$ , etc., represent the period of the wave of Fig. 12(d). If the amplitude of the wave of Fig. 12(e) is altered, ( $y_2 - y_1$ ) will be changed and the spacing between the "even" and "odd" lines will be altered. This leads to the major defect of this method of interlacing, namely, that the value of the difference between the amplitude of the alternate discharges is somewhat critical for perfect interlacing, which might necessitate the use of an additional control on the receiver.

Figs. 12(a) and (b) show the even and odd sections of the synchronizing wave used. The actual synchronization of the vertical oscillator is maintained by the first-occurring portion of the

wave, which is identical for the even and odd cycles. However, the impulse Fig. 12(c) generated by the oscillator occurs slightly later and includes part of the time in which the even and odd portions differ as shown by the dotted line Fig. 12(b). This synchronizing wave is used for two purposes, as follows: It is filtered to remove the horizontal impulses substantially as was described for the odd-line method of interlacing, and then impressed upon the vertical oscillator for synchronizing. The synchronizing wave (unfiltered) is also impressed upon the cathode circuit of the discharge tube, while the output of the oscillator is impressed upon the grid to cause the discharge tube to pass plate current intermittently and thereby generate the vertical saw-tooth wave. The plate conductivity of the discharge tube is a function of the cathode potential as well as the grid potential. Therefore, since the oscillator output wave Fig. 12(c) occurs partly during the interval in which wave portions of Figs. 12(a) and (b) are different, the alternate discharges will be different. The difference in area under the "even" and "odd" portions of the wave, which causes the inequality of the alternate discharges, needs to be only a fraction of one per cent of the area under the oscillator impulse as applied to the grid circuit of the discharge tube.

#### OTHER PROBLEMS ASSOCIATED WITH INTERLACED SCANNING

For a picture containing such a great number of lines, difficulty was experienced in the mechanical accuracy of construction of a synchronizing signal generator of the rotary type. An electrical synchronizing signal generator has been developed, which consists of special multivibrator and wave-shaping circuits synchronized with the sixty-cycle power supply. Further description of this signal generator is beyond the scope of this paper.

In order to use standard thirty-five-millimeter film for television subject material it was necessary to design the film projector in such a way that with the film running at twenty-four frames per second, it could be scanned at a rate of thirty complete frames per second or sixty exposures of the iconoscope plate per second as required for interlacing. By using a specially designed cam-driven oscillating mirror type projector having a very quick return, it is possible to maintain the image of the even frames stationary for substantially two-sixtieths of a second, or for two vertical scannings, and the odd frames stationary for sub-

stantially three-sixtieths of a second, or for three scannings. By this procedure two frames of film are projected in five-sixtieths or one-twelfth of a second, which gives the required twenty-four frames per second.

#### COMPLEX SCANNING PATTERNS

The use of more complex types of interlaced scanning has been suggested. One of these, known as "triple interlacing" has been used considerably in mechanical scanning in which a three-spiral disk was used. Triple interlacing has also been used in a laboratory installation of a cathode-ray system. In the latter case the interlacing was accomplished by a method using the same principle as the "odd-line" method described, the difference being that the horizontal scanning frequency was made a whole number plus one third (instead of one half) times the vertical saw-tooth frequency. In triple interlaced scanning, the screen may be considered to be divided into groups of lines, each group consisting of three adjacent lines numbered 1, 2, and 3. Then the scanning cycle would be, first, all lines numbered 1; second, all lines numbered 2; and third, all lines numbered 3. If triple interlacing is to be useful, the most promising vertical scanning frequency for cathode-ray use is sixty, which gives a picture repetition rate of twenty. At this low frequency the individual lines exhibit appreciable flicker and also the screen produces a disagreeable effect of moving or "crawling." This effect is due to the fact that if the eye moves over the screen vertically downward at a certain constant speed, it will rest on line 1 of group one, while it is being scanned, then on line 2, then line 3, then line 1 of the next group, etc., while each one is being scanned. Actually, if the attention of the eye is permitted to follow this progression, the screen will appear to become very coarse and to have only one third of the total number of lines. This effect, which renders triple interlacing very objectionable, is practically absent on the "double" interlaced screen, it being possible to observe the effect only by special effort of the observer. The marked difference between the double and triple interlaced pattern is due to the higher repetition rate of the individual lines and the larger ratio of the width of a line to the width of the group. (There are two lines in each group for double interlacing.) For quadruple or higher interlacing, it is believed that these ill effects would become more serious.

## CONCLUSION

In conclusion, the writers believe that double interlaced scanning with a frame frequency of thirty per second is the optimum known condition at the present time for alternating-current power supply sources of sixty cycles per second.

Since the minimum picture repetition rate for negligible flicker has been set at forty-eight pictures per second, it is interesting to compare the picture detail provided by progressive scanning at forty-eight pictures per second to that provided by interlaced scanning at thirty pictures per second, with a maximum video frequency of 750 kilocycles.

From the formula for equal horizontal and vertical detail,

$$a = \sqrt{2f/nRK}$$

where,

$a$  = the number of scanning lines

$f$  = maximum video frequency in cycles

$R$  = aspect ratio (= 4/3)

$n$  = frame repetition rate

$K = 0.64$

the number of lines,  $a$ , is 192 for progressive scanning and 243 for interlaced scanning.

The effective number of picture elements,  $e$ , may be obtained by the formula,  $e = a^2RK^2$ , in which  $K^2$  is a correcting factor required on account of the loss due to random details of the picture not coinciding with the scanning line as discussed by the writers in the paper previously cited. (The losses of picture elements due to scanning beam return time and synchronizing are neglected in this case for simplicity.) The effective number of picture elements is 20,200 for progressive scanning and 32,100 for interlaced scanning.

From the above it is seen that the progressive scanning provides only sixty-two per cent of the detail provided by "interlaced" scanning. One case in which thirty to sixty interlacing would not be optimum would be for receivers located in alternating-current power districts other than sixty cycles, receiving programs of a transmitter in a sixty-cycle area. In this case, the benefits of interlacing would be largely lost due to alternating-current ripple. (Extra precautions taken in shielding and filtering the power supply of receivers for such special conditions will reduce the ripple effects and might make the interlacing acceptable.) The example just given for transmitter and receiver

in differing power supply frequency areas would represent only a negligible portion of the probable installations except when considering relayed programs. Where transmitter and receivers are located in the same power supply districts as regards frequency, interlacing can always be satisfactorily obtained by proper choice of operating characteristics; i.e., for fifty-cycle power source, a frame frequency of twenty-five per second and a field frequency of fifty per second. (For a fifty-cycle source, operation at the standard movie speed of twenty-four frames per second would be satisfactory.)

In direct-current power districts it is at present necessary to use a converter with the alternating-current type of receiver. With the frequency of the converter adjusted within one or two cycles of the power supply at the transmitter, all of the advantages of interlacing are had. Interlacing also raises the minimum video frequency requirement in the ratio of two to one, since it increases the field frequency, thereby reducing the amplifier difficulties and cost at both transmitter and receiver.

#### ACKNOWLEDGMENT

The authors express appreciation to Mr. W. A. Tolson for assistance in the work pertaining to the relation of the frame frequency and the alternating-current power supply, and to Messrs. W. J. Poch and J. P. Smith for assistance in producing and testing the effect of various synchronizing wave shapes.

# AN URBAN FIELD STRENGTH SURVEY AT THIRTY AND ONE HUNDRED MEGACYCLES

BY

R. S. HOLMES AND A. H. TURNER

(RCA Manufacturing Company, Inc., Camden, New Jersey)

*Summary*—A description is given of the transmitter and receiver equipment used in making field strength surveys in the Camden-Philadelphia area for a low power transmitter whose antenna is 200 feet above the ground, at frequencies of thirty and one hundred megacycles.

Field strength contour maps for the area within approximately ten miles of the transmitter are given. From these maps the average field strength obtained at various distances from the transmitter was determined, and the attenuation of the signal was found to be proportional to the 1.84 power of the distance for thirty megacycles and the 2.5 power of the distance for one hundred megacycles for the region between one and ten miles from the transmitter.

Curves showing the variation from the average field strength of the signal along three routes radiating fifteen miles from the transmitter are given, and these variations are compared with the elevation profiles of the respective routes. It is shown that the signal is usually strongest on the brows of hills facing the transmitter.

Measurements were made in three representative residences, and from these data, curves showing the power required at the transmitter to furnish one hundred microvolts input to receivers with short indoor antennas located in houses at various distances up to ten miles from the transmitter were computed for the two frequencies.

**T**HIS paper describes a survey made in the Camden-Philadelphia area of the field strength from an ultra-high-frequency transmitter operated at thirty and at one hundred megacycles. The survey was made during the Summer of 1934.

## MEASURING EQUIPMENT AND PROCEDURE

The signal for the survey was radiated from an antenna located on the roof of an RCA Manufacturing Company building located at Front and Cooper Streets, in Camden. The ground elevation at this point is about ten feet above sea level, and the center of the antenna was approximately 200 feet above sea level. This antenna, constructed as shown on Fig. 1, was of the same general type as that described by Kell.<sup>1</sup> An iron and dur-aluminum pole, grounded to the metal roof, served as antenna,

<sup>1</sup> Kell, Bedford, and Trainer, "An experimental television system," *Proc. I.R.E.*, vol. 22, pp. 1260-1261; November, (1934).

Reprinted from Proceedings of the Institute of Radio Engineers.

support, and one side of the feeder line. The other side of the feeder line was spaced out from the pole, and was slidable through the standoff insulators, by means of the rope and pulley; this line could be raised and lowered to expose more or less of the top of the pole for radiation, for adjusting to the operating frequency.

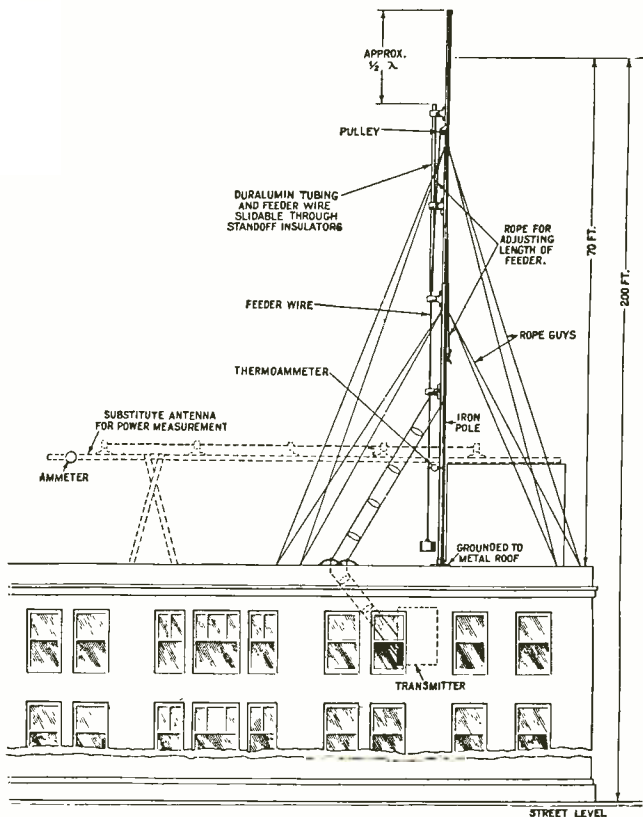

Fig. 1—Transmitting antenna arrangement.

In order to measure the antenna current, for computing the radiated power, a substitute antenna, located as shown in Fig. 1, was used. The horizontal substitute antenna was far enough from the roof so that the radiation resistance was not materially different from that of the vertical antenna. The current in the center of the vertical antenna was assumed to be the same as that in the substitute antenna when the feeder current was the same. The feeder current was maintained constant during all measurements at each frequency.



A further check of the radiated power was made by measuring the field intensity on the roof of a near-by brick tower at approximately the same elevation as the radiating portion of the vertical antenna. The distance between the transmitter and the receiver was only slightly more than twice the elevation of each above the ground, and was partly occupied by several buildings having lower roof elevations. Under these conditions reflection was probably negligible, and was neglected in the calculation of radiated power from these field intensity measurements. The receiver indicated twenty per cent more field intensity at one

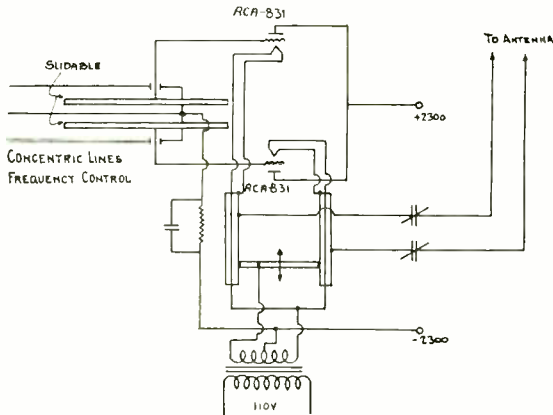

Fig. 2—Circuit of transmitter when operating at one hundred megacycles.

hundred megacycles, and two per cent more at thirty megacycles, than should be produced by the current measured in the horizontal antenna and assumed to be the same in the vertical antenna. The radiated power is assumed to be that calculated from the antenna current, and all the data in this paper have been adjusted to one kilowatt radiated power.

The transmitter consisted of a push-pull oscillator using RCA-831 tubes. No modulating means were provided. The circuit diagram of the transmitter for one-hundred-megacycle operation is shown in Fig. 2. A pair of open-ended concentric lines in the grid circuit were used for frequency stability. At one hundred megacycles the tube plates were closely bridged and the radio-frequency energy taken from the tuned filament circuit. At thirty megacycles the more conventional arrangement of tuned-grid—tuned-plate circuit was used.

The field strength was measured with a special battery of operated superheterodyne receiver having a tuning range of

thirty to one hundred megacycles, operated on a calibrated antenna. The circuit of the receiver is shown in Fig. 3.

A three-gang capacitor tuned the two radio-frequency circuits and the oscillator. The circuits were coupled so that the incoming signal and the oscillator voltage were both impressed on the grid of the first detector. From the detector the intermediate-frequency signal passed through the three-stage intermediate amplifier to the grid-leak detector and the audio amplifier. A gain control operated on the bias of the three intermediate amplifier tubes. The attenuation characteristic of this con-

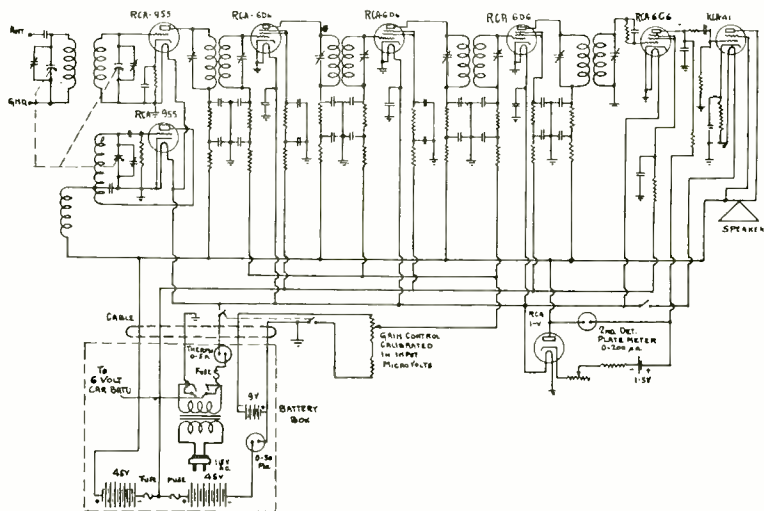

Fig. 3.—Circuit of field strength measuring receiver.

rol was determined at intermediate frequency. A microammeter in the plate circuit of the grid-leak detector indicated the change in plate current due to the signal, and its sensitivity was sufficient to indicate small changes in signal strength, since the steady component of plate current was balanced out of the meter by the bucking battery current.

The receiver was mounted in an automobile and connected to an antenna permanently mounted on the side of the car. The complete equipment was calibrated by subjecting it to a known field from a small transmitter, recording gain control dial settings for a given change in detector plate current against field strength in microvolts per meter for several different field strengths. The curve thus obtained was then extended to the limits of sensitivity of the receiver by applying the attenuation characteristic of the gain control, previously obtained. A sep-

arate calibration was made at each of the two frequencies, and rechecks were made at frequent intervals during the survey.

The survey was made by driving the car along roads fairly well distributed over the area within fifteen miles of the transmitter, and measuring the field strength at frequent intervals. It was found that a continuous check of the field strength could be made when the car was driven along at a slow rate of speed;

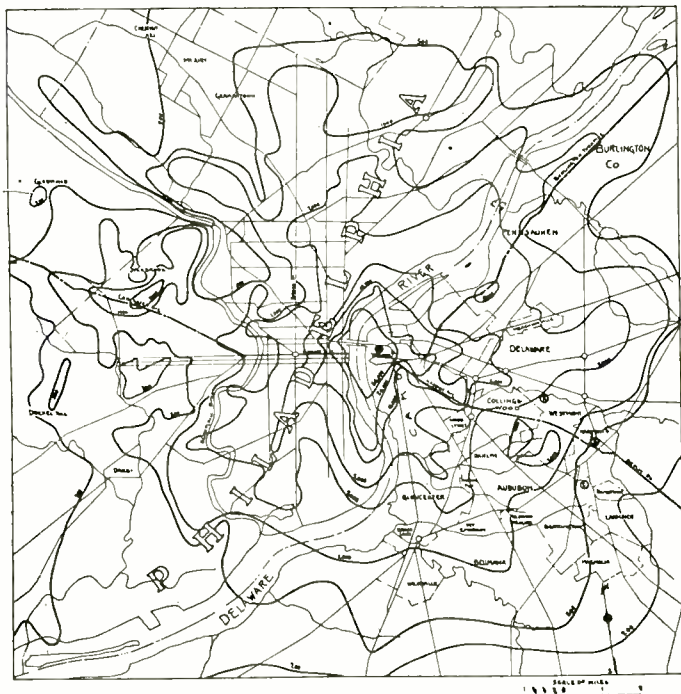

Fig. 4—Thirty-megacycle contour map. Contours of equal field intensities in microvolts per meter.

whenever the average reading changed materially it was recorded. The points were identified on the map by their distance from known landmarks, such as main intersections, etc. The standing wave pattern was very pronounced, particularly at one hundred megacycles, causing wide apparent variations in field strength even in very short distances, but by driving the car at a constant rate of about fifteen miles per hour it was found that these variations could be readily averaged out, so all of the recorded readings were average field strength, usually averaged over a distance of about one to two hundred feet. At each frequency about 2000 readings were taken.

In addition to the measurements made for the purpose of drawing the contour maps, measurements were made along three routes radiating more or less directly from the transmitter. These routes were chosen as being widely different in ground profile characteristics; one was fairly level ground, one gently rising, and the other rising more rapidly. The elevation data for these routes were obtained from The United States Geodetic Survey Maps (1898).

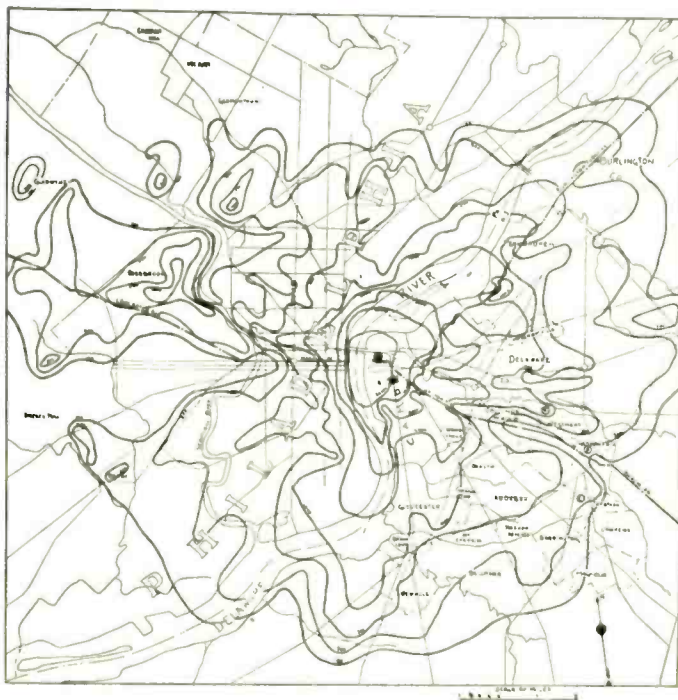

Fig. 5—One-hundred-megacycle contour map. Contours of equal field intensities in microvolts per meter.

In order better to tie the results of the survey to actual operating conditions for receivers in fixed locations, signal measurements were made at three representative residences. Measurements of actual input to the antenna post of the receiver with several different types of antenna at several locations in the house were made.

#### RESULTS OF THE SURVEY

Most of the measurements in this survey were made for the purpose of obtaining the field strength contours within a radius

of ten to fifteen miles from the transmitter. The points taken at each frequency were plotted on large scale maps and the contour lines for equal field strength were drawn. Fig. 4 is the map for thirty megacycles, and Fig. 5 for one hundred megacycles.

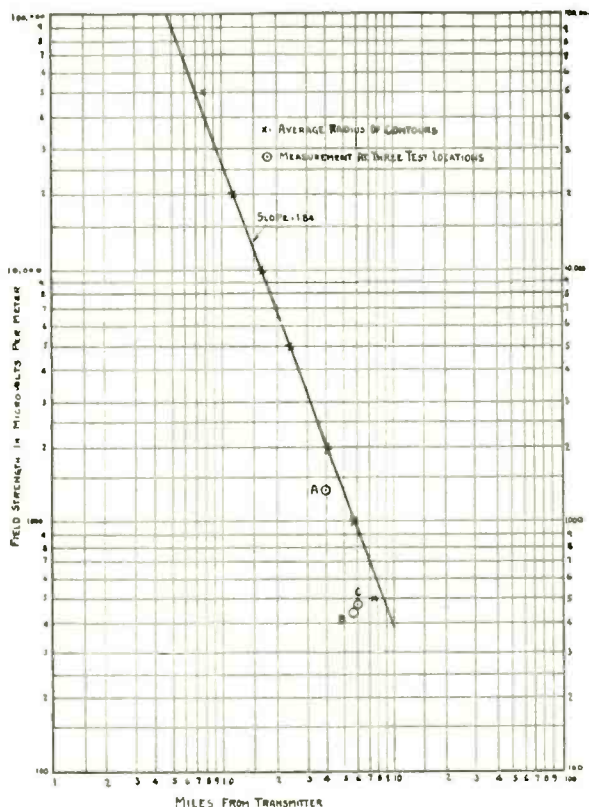

Fig. 6—Thirty-megacycle survey average.

In order to obtain more generalized results from these data, the area enclosed by each contour was measured and the average<sup>2</sup> radius determined. The average radii were used as the basis for plotting the curves in Figs. 6 and 7 showing the aver-

<sup>2</sup> The radius was determined from the relation  $r = \sqrt{A/\pi}$ , where  $A$  is the area of the contour. The  $r$ , of course, is the radius of a circle having this same area, which is the effective radius of the contour. The greater the deviation of the shape of the contours from circles, the greater the deviation of the effective radius as determined by the above relation from the true average radius. The contours under consideration are near enough to circles so that the error in calling effective radius average radius is small, and for simplicity this has been done in this paper.

age signal at the two frequencies as a function of distance from the transmitter. No effort has been made to determine the exact law governing the rate of attenuation. At distances between one and ten miles the curves are nearly straight on logarithmic paper, and have slopes of approximately 1.84 at thirty megacycles and 2.5 at one hundred megacycles. At distances

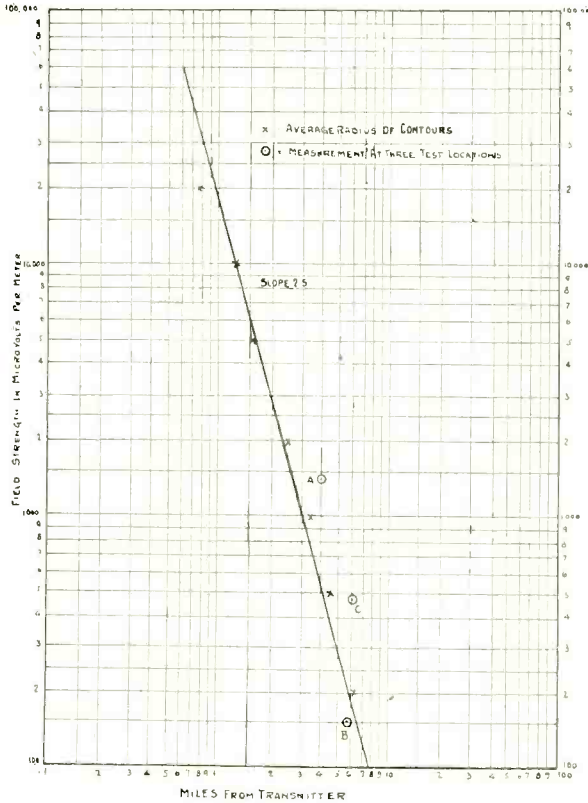

Fig. 7—One-hundred-megacycle survey average.

less than one mile, the attenuation is probably more nearly directly proportional to distance, as indicated by some points that were taken, but not plotted on the maps or curves, and beyond ten miles the curves probably have a greater slope.

Several interesting observations were made during the course of these measurements. The standing wave patterns were, in general, more severe in built-up sections than in the open country. When traveling on north and south streets in downtown Philadelphia the field strength usually increased very greatly

when passing an intersection where the signal could come directly up the street from the transmitter, instead of having

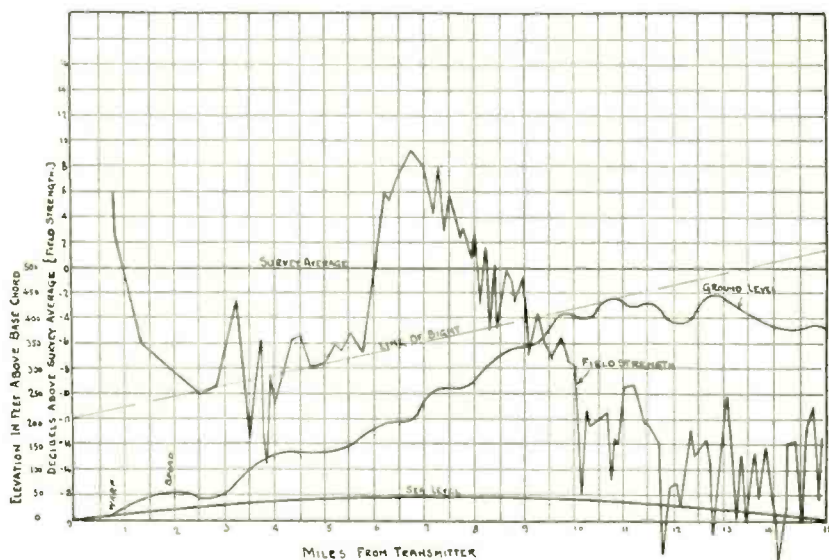

Fig. 8—Thirty-megacycle profile—Lancaster Ave.

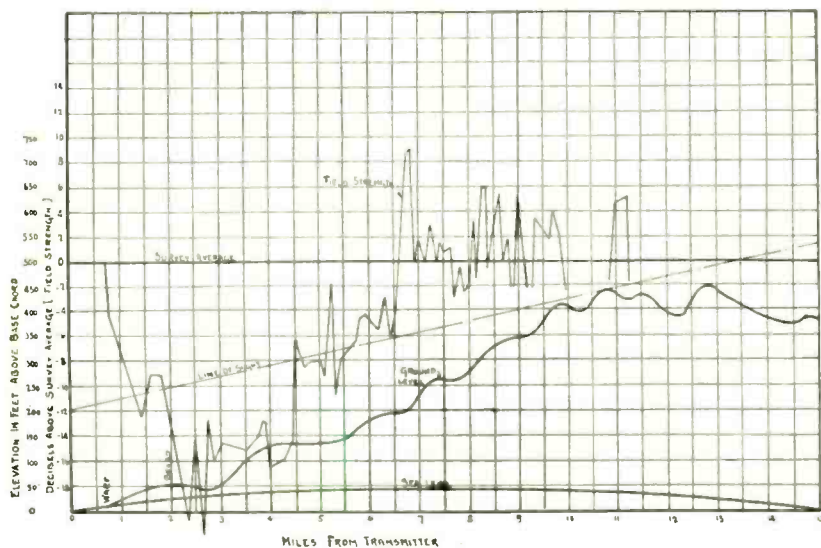

Fig. 9—One-hundred-megacycle profile—Lancaster Ave.

to go through and around buildings. The shielding effect of the thickly built-up downtown area of Philadelphia is very apparent on the contour maps, particularly at one hundred megacycles

where the signal practically disappears behind the buildings. The signal was attenuated less up and down the Delaware River

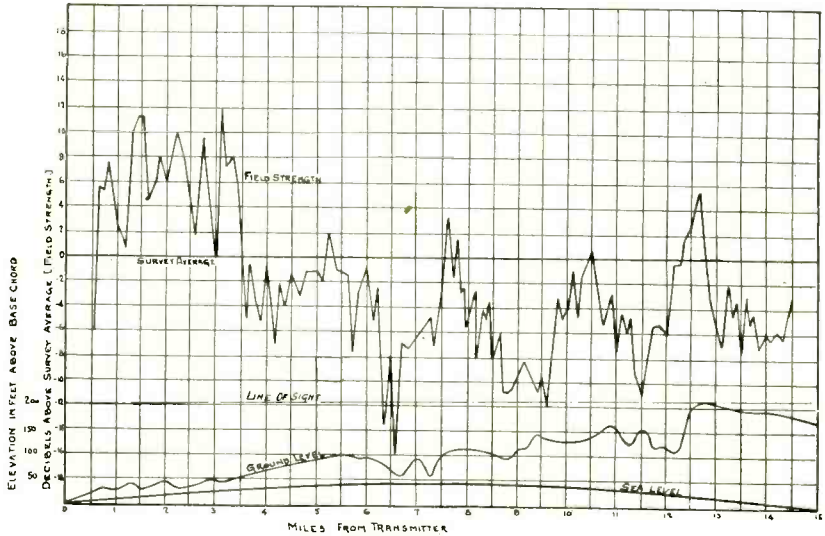

Fig. 10—Thirty-megacycle profile—Berlin Road.

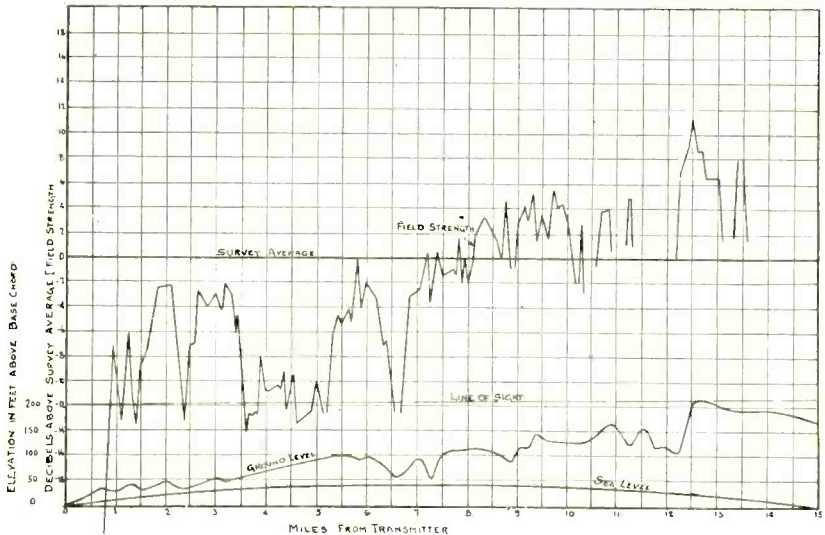

Fig. 11—One-hundred megacycle profile—Berlin Road.

because of the fewer buildings and other obstructions in these directions. The greatest field strength was usually obtained on the brows of hills facing the transmitter; beyond the brow of a



hill the field strength usually decreased, even though the elevation might continue to increase gradually.

In order to determine the relation of the ground profile to

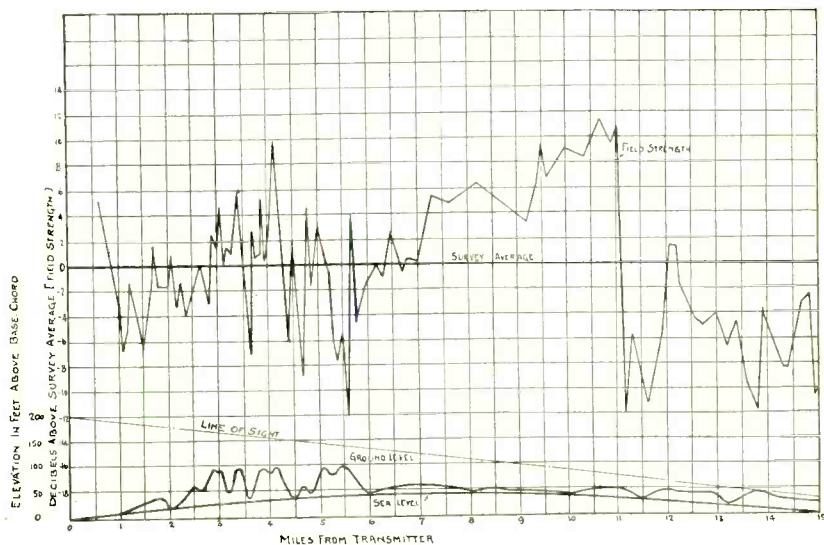

Fig. 12—Thirty-megacycle profile—Burlington Turnpike.

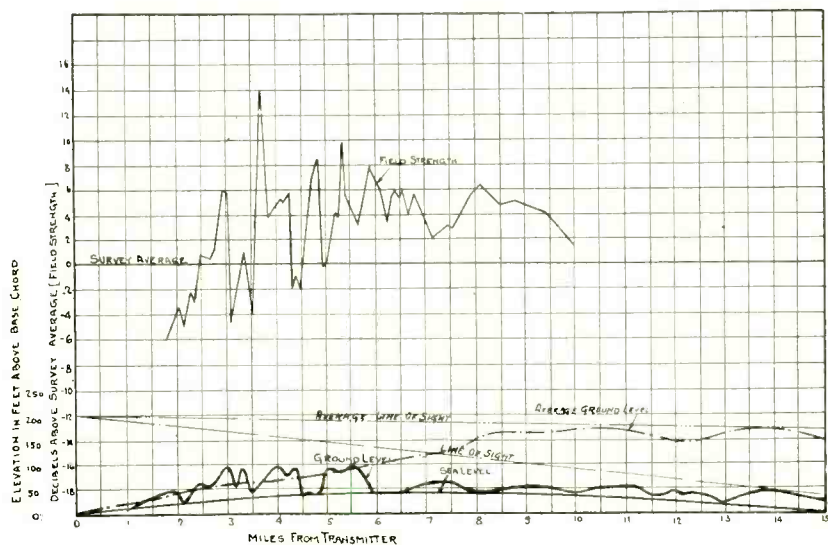

Fig. 13—One-hundred-megacycle profile—Burlington Turnpike and average profile around transmitter.

the field strength, three routes radiating more or less directly from the transmitter were selected and additional measurements

made along them. These routes are shown in dot-dash lines on the contour maps. One route was through Philadelphia on Market Street and out Lancaster Avenue. This route was chosen because of the hills it passed over on the far side of Philadelphia. Readings were taken very close together along this route, and plotted as variation from the survey average, in decibels, at the various distances from the transmitter. Figs. 8 and 9 are the curves obtained over this route at thirty and one hundred megacycles, respectively. In the same figures are plotted the ground elevation above a fifteen-mile chord. Some correspondence between the elevation and the field strength can be seen on these curves, most notably the high field strength at the brows of hills, but it shows that local conditions have a very large effect and at times completely mask the relation between elevation and field strength.

The second route selected was almost directly opposite the first, toward Berlin, New Jersey, and is most notable because of the steep hill about twelve and one-half miles from the transmitter. The curves for this route are shown in Figs. 10 and 11, and the increase in field strength at the brow of the hill is very noticeable at both thirty and one hundred megacycles.

The third route is along the Delaware River on the New Jersey side, out the Burlington Turnpike. This route is the most level of the three, and the signal remains the most constant along this route, as shown by Figs. 12 and 13. There is less built-up area along this route than either of the others, and this is also a factor in the reduction of field strength variations.

Fig. 13 also shows the average elevation of the ground in all directions from the transmitter. It is included for comparison with the other curves, and was obtained by plotting the average elevation along sixteen radii from the transmitter. The average ground level rises more or less uniformly to a distance of about ten miles from the transmitter and then levels off. Line of sight extends out to about ten miles, and remains approximately parallel to the ground to about fifteen miles from the transmitter.

After the field strength contour map data had been obtained it seemed desirable to measure the signals actually obtained in some representative locations in order to relate better the field strength measurements with actual receiver performance that might be expected in a home installation. Measurements were

made at three locations, two in Haddonfield and one in Collingswood, New Jersey, identified as A, B, and C on the maps. In each case the field strength was measured by driving the car along the street in front of the house, and into the driveway, and taking the average of the measurements thus obtained as the field strength outside the house. The receiver was then taken into the house and the actual microvolts on the antenna post measured for several different antennas in several different locations. Table I is a tabulation of the data thus obtained.

TABLE I

LOCATION A: A superior location, line of sight, four miles from transmitter, elevation 35 feet.

	30 mc	100 mc
Field strength outside of house	1336 $\mu$ v/m	1440 $\mu$ v/m
Receiver Location		
1st floor (living room)		
Short indoor antenna*	3400 $\mu$ v	770 $\mu$ v
Broadcast antenna	1570	264
Zeppelin antenna to roof	8300	1920
3rd floor (attic)		
Short indoor antenna	10800	1920

LOCATION B: An inferior location below line of sight, 5 1/2 miles from transmitter, elevation 50 feet.

	450 $\mu$ v/m	150 $\mu$ v/m
Field strength outside of house		
Receiver Location		
1st floor (living room)		
Short indoor antenna	1400 $\mu$ v	100 $\mu$ v
Broadcast antenna	1080	105
Zeppelin antenna to roof	600	180
2nd floor (attic)		
Short indoor antenna	3000	—

LOCATION C: A superior location, line of sight, six miles from transmitter, elevation 110 feet.

	480 $\mu$ v/m	480 $\mu$ v/m
Field strength outside of house		
Receiver Location		
1st floor (living room)		
Short indoor antenna	1800 $\mu$ v	240 $\mu$ v
Broadcast antenna	1080	550
Zeppelin antenna to roof	3000	1320
2nd floor (den)		
Short indoor antenna	2250	640
3rd floor (attic)		
Short indoor antenna	5650	1200

\* A wire twelve feet long for thirty megacycles; five feet long for one hundred megacycles.

The short antenna referred to in Table I has the length nearest to a half wavelength with which the greatest signal was obtained on the antenna post of the receiver. For thirty megacycles this length was twelve feet, and at one hundred megacycles, five feet. These lengths are not a half wavelength because of the effect of the receiver input circuit on antenna resonance, and bear a different ratio to a half wave length at the two frequencies because of the different characteristics of the receiver input circuit at the two frequencies.

The zeppelin antenna was the same at each location; a half wavelength vertical wire hung on the highest convenient point

on the roof of the house, usually the pole supporting the broadcast antenna, with a fifty-foot transmission line leading down to the receiver in the living room. The broadcast antenna was in each case the one used with a broadcast receiver and in no case was it an all-wave antenna or one designed for short-wave reception. No tuning was added to the antenna to increase the signal obtained. Where the measurements were made in rooms other than the attic, the receiver was placed in the position most suitable for the permanent installation of a radio receiver in that room, and it was not moved about in the room to find the location where the strongest signal was obtained.

The three locations are all approximately in the same direction from the transmitter. An examination of the thirty-megacycle contour map shows a general indentation in the contours in this direction, indicating that the general level of field strength was lower than in most other directions. Locations *A* and *C* were considered superior locations, but due to the general low signal the field strength measurements at these locations, plotted on Fig. 6, were below the survey average. Location *B* was considered an inferior location because it was below line of sight, and the field strength there fell further below the average. At one hundred megacycles the contours do not show the general indentation in this direction, and the field strength measurements at locations *A* and *C* lie above the survey average when plotted on Fig. 7, while that at location *B* is below, as would be expected. The difference between superior and inferior locations is much greater at one hundred megacycles than at thirty megacycles.

An interesting comparison of the effectiveness of transmission at thirty megacycles with that at one hundred megacycles under practical operating conditions can be made by applying the data given in Table I. The ratio ( $R$ ) between the signal (in microvolts) on the antenna post of the receiver inside the house and the field strength (in microvolts per meter) outside the house was computed for the condition of the short indoor antenna, with the receiver on the ground floor. The average ratio at thirty megacycles is 3.2 and at one hundred megacycles it is 0.6. This ratio includes the effect of attenuation through the walls, reflections from the metal parts of the house, etc., as well as the effective height of the antenna.

Absorption and reflections are a function of the building construction and are very erratic, so the ratio  $R$  would be ex-

pected to vary widely between different buildings and between different locations in the same building—the values of  $R$  derived from the measurements tabulated in Table I are therefore only an indication of what might be expected in locations similar to those in which the measurements were made.

The factor of effective height of the antenna, which is also included in the general ratio  $R$ , is less dependent upon the location, and is primarily a function of the physical length of the

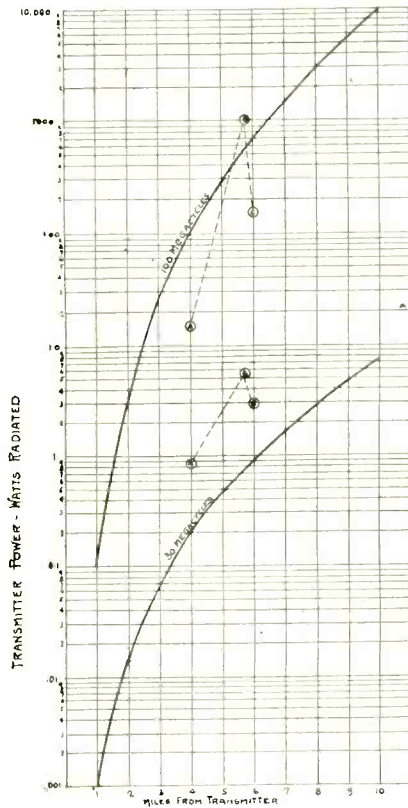

Fig. 14—Transmitter power required to deliver one hundred microvolts to the input of the receiver when using a short indoor antenna on the ground floor of a house at the indicated distance from the transmitter. Points A, B, C are for the three test locations of Table I. Antenna length for one hundred megacycles, five feet; for thirty megacycles, twelve feet.

antenna. The ratio of antenna lengths at thirty and one hundred megacycles is 12 to 5 or 2.4. This makes up a large portion of the difference in the ratios  $R$  obtained at the two frequencies, which is the ratio of 3.2 to 0.6 or 5.4.

Using the ratios ( $R$ ) derived in this manner and the curves of Figs. 6 and 7, the average transmitter power required to deliver one hundred microvolts to the antenna post of a receiver operated under the above conditions at various distances from the transmitter was computed. The results of these computations are plotted in Fig. 14. These curves give a practical indication of the increase in power required for a given service at one hundred megacycles over that required at thirty megacycles, taking into account the difference in the transmission characteristics of the two frequencies and also the effectiveness of the half wave length antennas, wall attenuations, etc., at the two frequencies. Points were also plotted on Fig. 14 showing the transmitter power required to deliver the one-hundred-microvolt signal to the receiver in the houses at locations *A*, *B*, and *C*, where measurements were actually made. The results presented apply only to the particular conditions under which the survey was made, and would be materially modified for other conditions. In particular, the transmitter location and the character of the surrounding territory will be a large factor in determining the service range. For a more practical installation the transmitter antenna might be elevated considerably above the 200 feet used for this survey. Increasing the transmitting antenna height would increase the service range, or, for a given service range, decrease the required transmitter power. It would also reduce somewhat the difference in power required at one hundred megacycles compared to that required at thirty megacycles, for a given coverage, since a greater portion of the transmission path would be through free space, where the attenuation at the two frequencies is nearly the same, and a smaller portion through and near obstacles which attenuate the higher frequency more than the lower frequency. These factors are recognized, but since the survey was made for only one transmitter antenna height, no data are presented to indicate their magnitude.

#### ACKNOWLEDGMENT

Mr. R. D. Kell and Mr. C. D. Kentner of the RCA Manufacturing Company, Inc., built and operated the transmitter used for this survey. Mr. H. C. Allen assisted in the work of making the field strength measurements.

# ULTRA HIGH FREQUENCY TRANSMISSION BETWEEN THE RCA BUILDING AND THE EMPIRE STATE BUILDING IN NEW YORK CITY

BY

P. S. CARTER AND G. S. WICKIZER

(RCA Communications, Inc., Rocky Point and Riverhead, L. I., N. Y.)

*Summary*—*Propagation between these two buildings at a frequency of 177 Mc has been studied with the object of providing a radio circuit with flat response over 3 Mc. It was found that the received signal arrived over several paths, some of which were due to reflection from ground and from nearby buildings. The effects on the indirect rays of horizontal and vertical directivity, and change in angle of polarization were observed. The theoretical response curve for an assumed combination of rays was compared with the curves obtained experimentally.*

THE propagation studies discussed in this paper were undertaken in connection with providing a radio circuit for the transmission of television images from the studios in the RCA Building to the transmitter in the Empire State Building. A relatively high carrier frequency was required to transmit both side bands at modulation frequencies up to 1.5 Mc, and to minimize man-made noises generated in electrical equipment. A frequency of 177 Mc was selected to avoid possible interference from the Empire State television and sound transmitters which will operate in the neighborhood of 50 Mc.

The two buildings are approximately 4600 feet apart, and are considerably higher than the buildings lying directly between them. Over this relatively short path, between high buildings, the signal at the receiver would be expected to consist of a direct and a number of reflected rays. The effect of this combination of rays on the radio circuit response curve was investigated in an effort to provide a flat response curve over a frequency band at least 3 Mc in width.

During this investigation, the receiving antenna was located in a small balcony outside of the 85th floor, on the north side of the Empire State Building. The transmitting antenna and transmitter were located first on top of an elevator shaft at the 14th floor level of the RCA Building, and later moved to a large balcony at the 67th floor.

Reprinted from Proceedings of the Institute of Radio Engineers.

The transmitter was a line controlled master oscillator, followed by a power amplifier stage. Frequency variation was accomplished by a micrometer adjustment on the oscillator line, and the power output was held constant by adjusting the output coupling for constant antenna meter reading.

The receiver was a double superheterodyne, equipped with heterodyne oscillator, followed by an audio measuring unit. Both diode current and heterodyne output were observed as a check on the receiver output. The receiving antenna was located

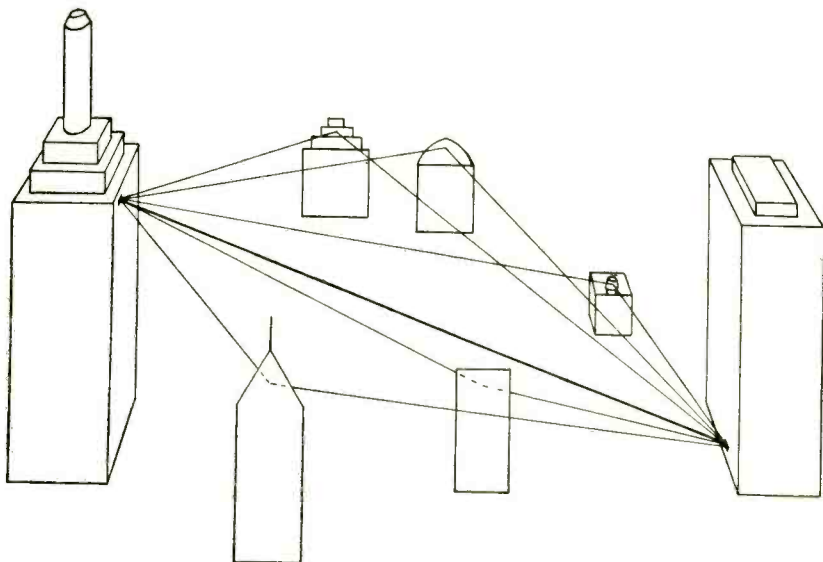

Fig. 1

a fraction of a wavelength from the building wall. At this small distance the phase change between direct and reflected waves is small for a frequency range of 3 or 4 per cent.

Fig. 1 is a sketch showing the direct path and some of the possible indirect paths when transmitting from the 14th floor of the RCA Building to the 85th floor of the Empire State Building. The actual conditions are very much more complex than shown here. Fig. 2 is a photograph looking toward the RCA Building taken from the 85th floor of the Empire State Building, while Fig. 3 is a photograph taken from the 14th floor of the RCA Building looking in the opposite direction. From an inspection of these pictures it is apparent that the signal at





Fig. 2



Fig. 3

the receiver might be made up of a large number of rays. This is possible because there exist surfaces on the various buildings, which lie at almost every conceivable angle. With the transmitter located at a relatively low level, the length of the path of the indirect ray lying in the vertical plane is not greatly different from that of the direct ray. However, reflected rays from objects lying off to the sides from the direct path may be of much greater length than the direct ray.

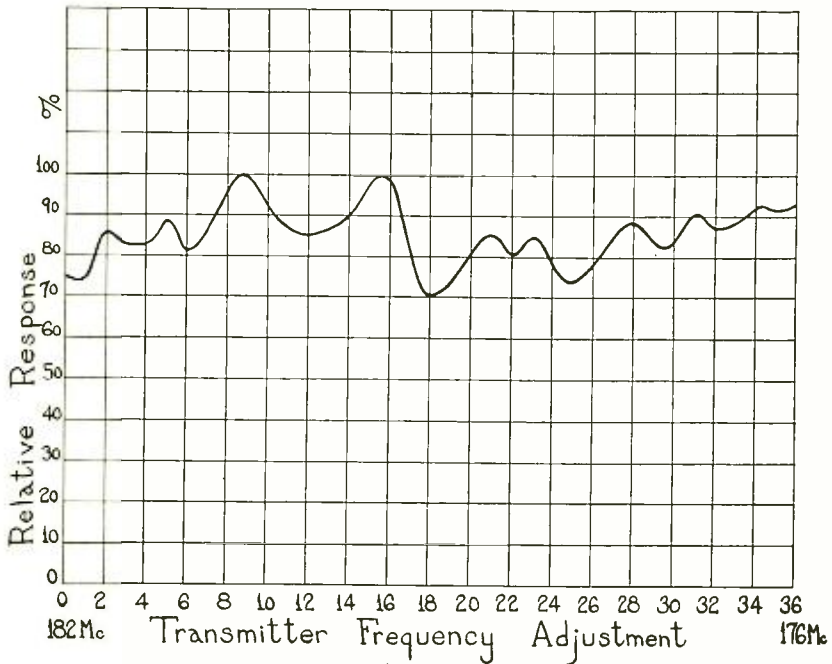

Fig. 4

Fig. 4 is a response curve when using simple half wave dipoles at both ends of the circuit. It was found necessary to install a copper sheet reflector behind the transmitting antenna, to eliminate reflections from the building wall, which was several wavelengths behind the antenna. With such an antenna system, the transmitted pattern is independent of reflecting surfaces behind the antenna. At first sight this curve appears difficult to interpret, there being no definite regularity to the maxima or minima. Let us for a moment consider the process of combination of the various rays making up the resulting received signal. A disturbance leaving the transmitting antenna at the time  $t$  will arrive at the receiving antenna at the time  $t+d/c$  where  $d$  is the

distance travelled and  $c$  the velocity of light. If we represent the electric field of the wave at the transmitter by  $E\epsilon^{j\omega t}$  then, at the receiver it will be represented by  $E\epsilon^{j\omega(t+d/c)}$  or, in other words, the phase lag in travelling the distance  $d$  is  $\omega d/c$ . Now, if we have two rays which travel distances differing by a distance  $X$  the phase angle difference  $\phi$  then becomes,—

$$\phi = \frac{\omega X}{c} + \alpha = \frac{2\pi f}{c} X + \alpha \text{ where } \alpha \text{ is the phase change due to reflection from any surface}$$

$$\text{and } d\phi = \frac{2\pi X}{c} df = \frac{2\pi X}{\lambda} \cdot \frac{df}{f} \text{ radians.}$$

Expressed otherwise, the change in phase angle  $d\phi$ , for a change in frequency  $df$ , is equal to the product of the path dif-

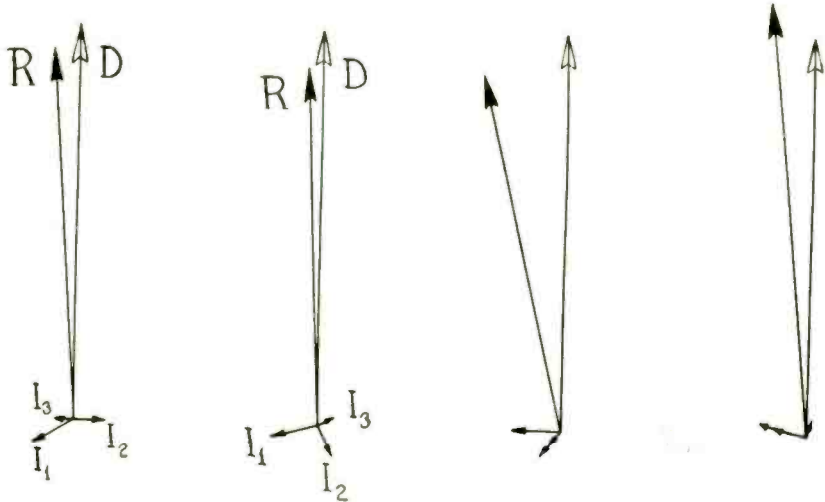
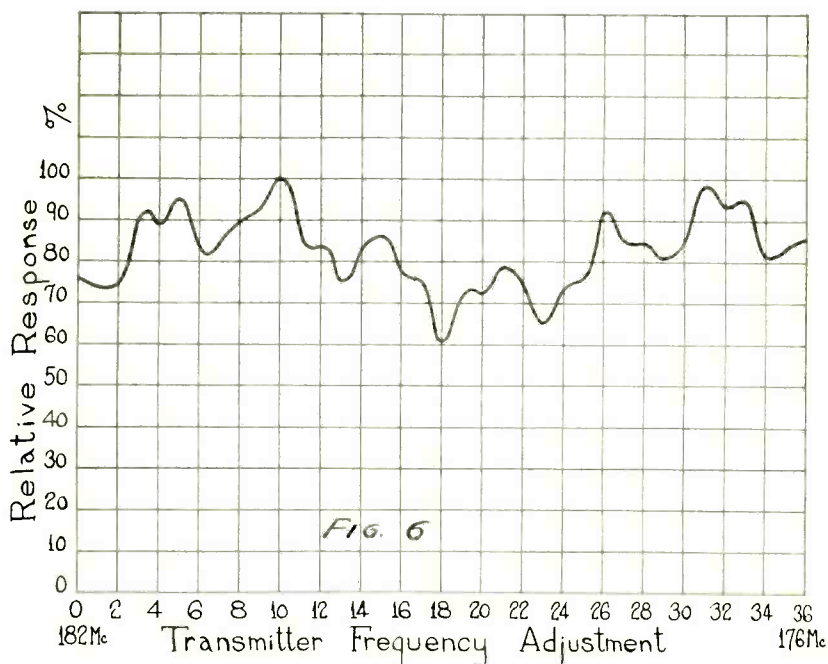

Fig. 5

ference expressed in terms of angle, multiplied by the ratio of the change in frequency to the frequency. For instance if we have a path difference of 10 wavelengths or 3600 degrees between two rays, a 1 per cent change in frequency will cause a phase change of approximately 36 degrees.

The signal strength resulting from the combination of a direct and several indirect rays is equal to the vector sum of a fixed vector and several other vectors rotating at angular velocities corresponding to the rate of change of phase with frequency given by the above relation.

Fig. 5 shows four combinations of a fixed vector of unit amplitude and three rotating vectors having amplitudes of  $\frac{1}{8}$ ,  $\frac{1}{12}$ , and  $\frac{1}{20}$ ; and angular velocities in the ratios of 3, 13 and 31. Between successive diagrams, the angle of the slowest rotating vector has been advanced 15 degrees which, for a 0.1 per cent change in frequency corresponds to a path difference of 41.7 wavelengths. The continuous curve of the resultant obtained from this process is shown in Fig. 6. Comparing this curve with Fig. 4, certain similarities will be noted which indicate that the experimental curve is the resultant of a direct and several indirect rays having considerable difference in length of path. With the particular conditions existing in these tests,



such differences in path would be expected only between rays arriving at relatively wide angles.

From the frequency range between successive maxima of this type of curve, the limits of variation in angle at which the indirect rays are arriving may be estimated. Theoretically an indirect ray having a given length of path might be reflected from any point on an ellipsoid having the transmitting and receiving antennas as foci. However, when the antennas have

reflectors behind them, the angles of the indirect rays with respect to the direct ray are limited to values less than 90 degrees. In a plane containing the two antenna wires, this angle is further limited, due to the fact that little radiation or reception is obtained at angles in the vicinity of 90 degrees to the direct ray.

Since the curve of Fig. 4 indicates indirect rays arriving at wide angles, the introduction of moderate directivity at either or both transmitter and receiver should materially reduce the rapid variations in the response characteristic. In order to study the effect of an increase in directivity in the horizontal plane, a transmitting antenna having a radiator one wavelength long,

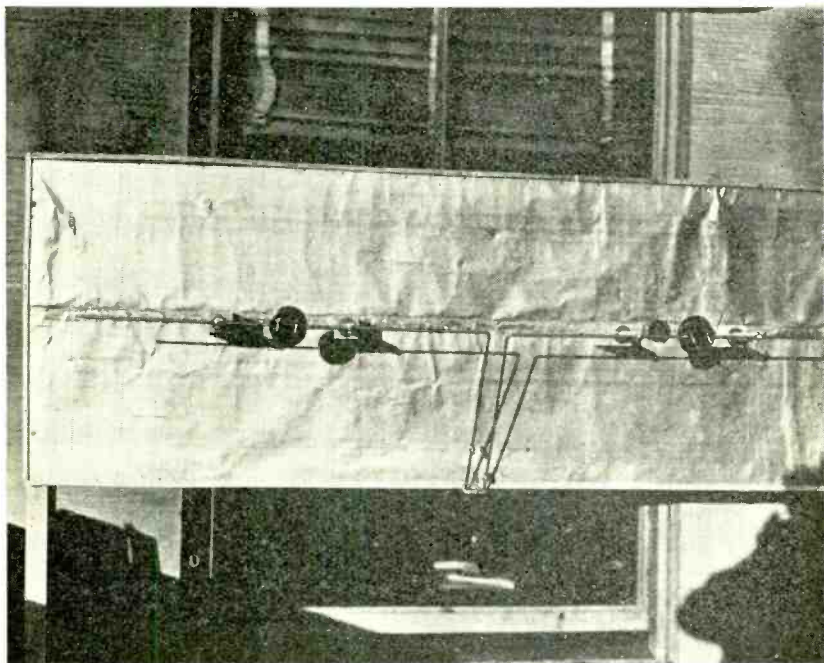
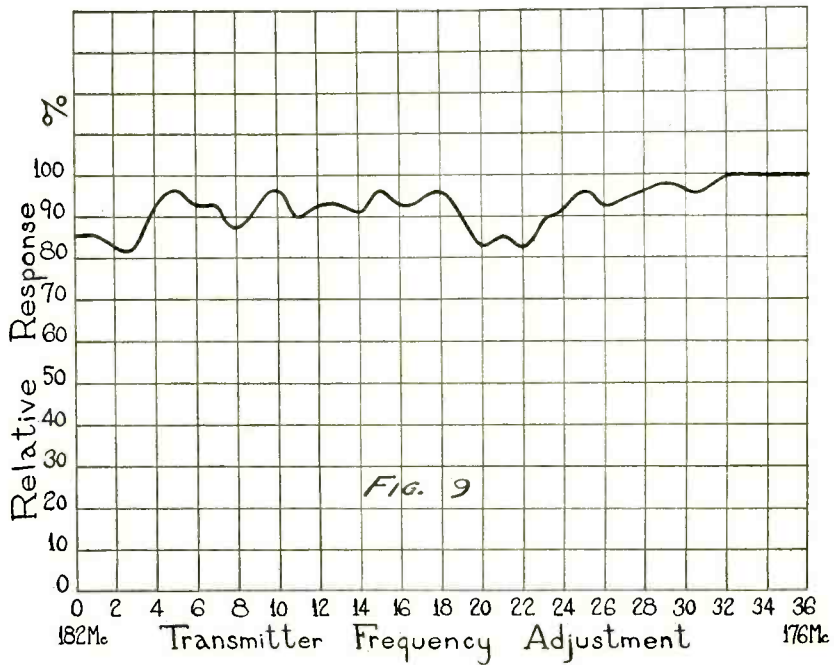
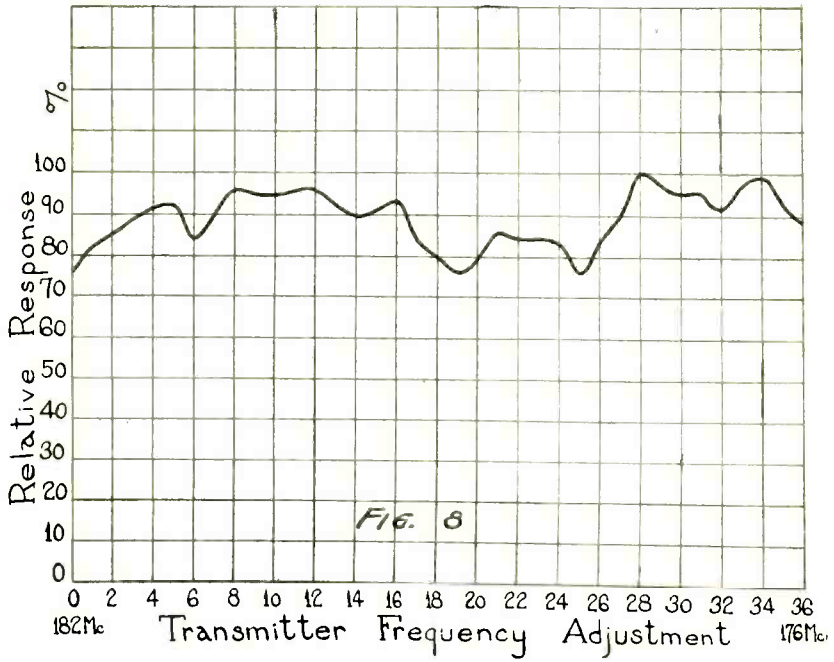

Fig. 7

fed at the center and located in front of a copper reflector, was set up as shown in Fig. 7. The response curve obtained with this antenna is shown in Fig. 8. It is apparent that the rapid variations have been considerably reduced, but there are certain frequency ranges where the variation in signal strength has been increased. From a study of vector diagrams such as previously described, it can be shown that although the removal of one or more indirect rays will usually give a general improvement over



a wide range of frequency, such a removal may cause wider variation over certain small frequency ranges.

To further reduce the strength of the indirect rays, a directive antenna arrangement was placed at the receiver. This consisted of two half wave dipoles lying end to end and separated by a distance of one and one half wavelengths between centers. Using this antenna and the directive transmitting antenna previously described, the curve shown in Fig. 9 was obtained. It will be noted that this curve shows considerably less variation than the curve of Fig. 8.

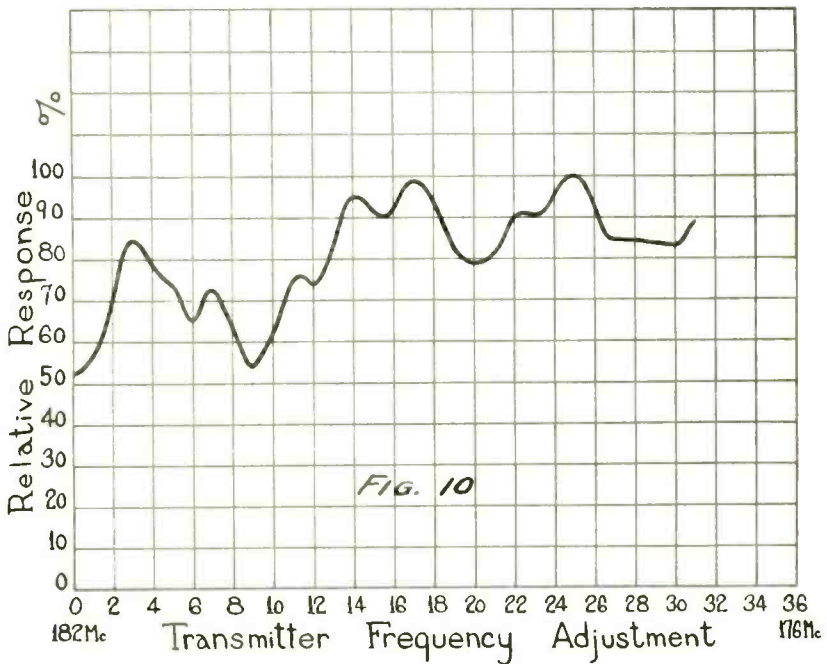

Since the reflections in these tests come from surfaces having all sorts of shapes and positions, we should expect a difference in the results with a change in the polarization. To investigate such a change, a half wave dipole was arranged vertically in front of a copper reflector, for transmission. For reception, a vertical half wave dipole was placed a few feet from the building. The results are shown in Fig. 10. This curve is of a different shape and has a much greater variation than the curve of Fig. 4 taken with the same antennas oriented to give horizontal polarization. This difference is probably due to

a number of factors, amongst which are some change in directivity, and changes in both phase and amplitude upon reflection. In general, the phase of a wave after reflection, when polarized in the plane of incidence, is opposite to the phase when polarized at right angles to the plane of incidence.

When the receiving and transmitting antennas are both at great heights above the intervening buildings, the geometry of the ray paths is considerably different than that where one antenna is at a relatively low altitude. The path lengths for indirect rays, lying in the vicinity of the vertical plane passing

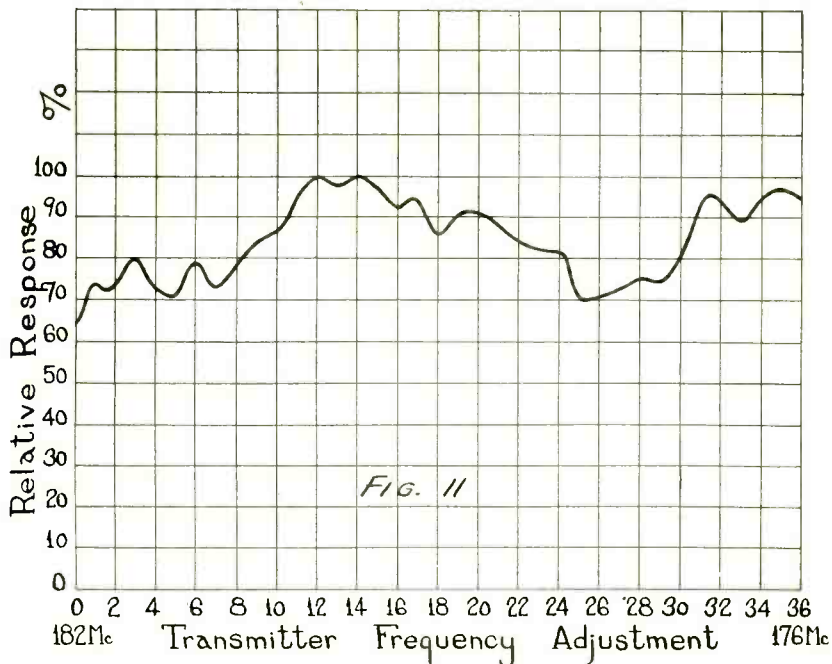

through the transmitter and receiver, are greatly increased and become a major factor in the determination of the resulting signal strength. Also, there is an increase in the number of surfaces having proper angles to reflect energy to the receiver, because of the fact that a large number of objects, which were formerly obscured by nearby buildings, are now brought into view from the transmitter location.

These effects were investigated by locating the transmitter on a balcony at the 67th floor of the RCA Building. When facing the Empire State Building at this height, one gets an impression



of practically all other buildings being down rather than off to the sides. This impression of height is conveyed by the photograph taken from the Empire State Building.

With the same horizontally polarized directive antennas referred to in connection with Fig. 7, the data shown in Fig. 11 were obtained. The receiving antenna was a single half wave dipole. It will be noted that the slower variation is of considerable magnitude, and corresponds to a path difference of approximately  $59 \lambda$  or about 328 feet. With the transmitter at a height of 900 ft., the receiver at a height of 1000 ft., and a distance

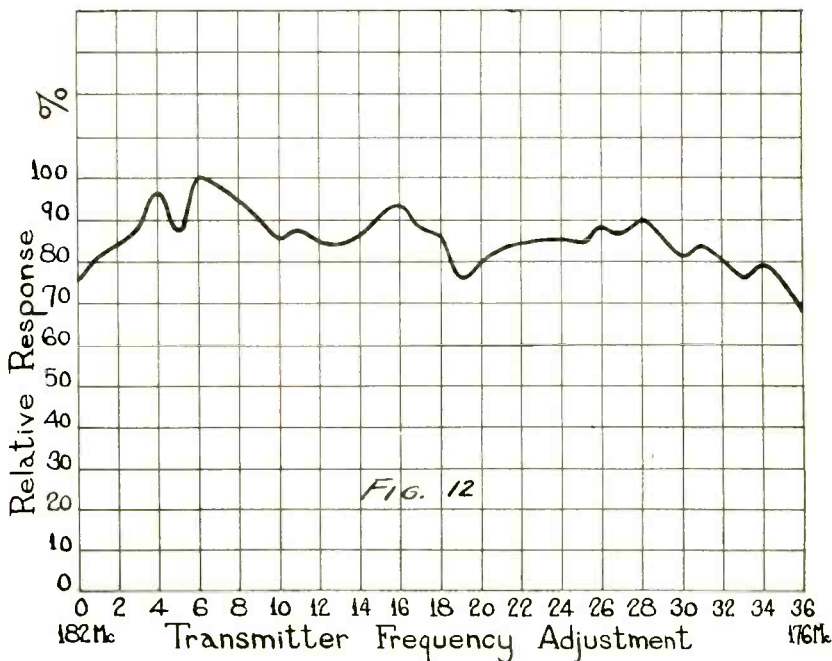

between buildings of 4600 ft., this path difference might naturally be assumed to be due to reflection from a horizontal surface at a height of about 100 ft. and located in the vicinity of 2200 ft. from the RCA Building. The angle of such a ray would be about 20.5 degrees to the horizon. If such an assumption is correct, a receiving antenna which has minimum pickup at this angle in the vertical plane should eliminate this variation in signal strength.

Accordingly an antenna consisting of two parallel horizontal dipoles spaced 1.43 wavelengths to give zero reception at an

angle of 20.5 degrees to the horizon was erected. Fig. 12 shows the curve resulting from the use of this antenna in conjunction with the same transmitting antenna used for Fig. 11. It is evident that the indirect ray which was assumed to be coming from a building roof lying in a line between the two buildings, has been entirely eliminated. However, the curve is still quite irregular due to side reflections.

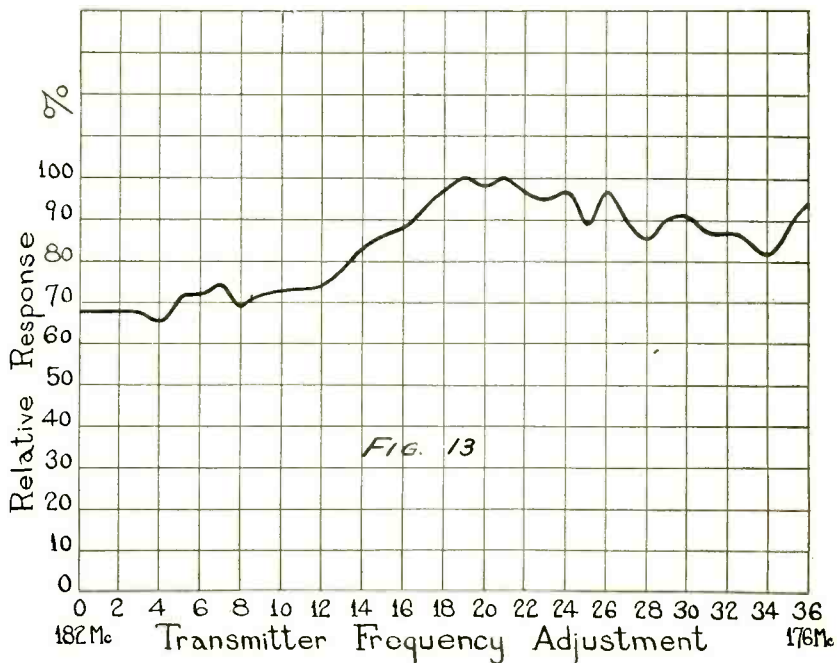

Horizontal directivity at both ends was also tried for this height. The rapid variations were fairly well smoothed out as can be seen from Fig. 13. If the proper vertical directivity had been included with the horizontal, the slow variation still remaining in this curve would no doubt have been eliminated.

It has already been mentioned that in general, the phase of a wave polarized perpendicular to the plane of incidence is reversed upon reflection, whereas the phase of a wave polarized in the plane of incidence undergoes no change. (The exception to this rule is when the angle of the ray to the reflecting surface is less than the critical or Brewster angle for a wave polarized in the plane of incidence.) If a wave is polarized at an angle of 45 degrees to a reflecting surface, i.e. having equal components

of electric force perpendicular and parallel to the plane of incidence, the direction of the electric vector after reflection is perpendicular to the direction before reflection. Now, if a receiving antenna is oriented the same as the transmitting antenna, the electric vector of the indirect ray will be at right angles to the receiving antenna conductor and can produce no current. The signal is then due to the direct ray only and consequently will not vary with frequency. A flat response characteristic would

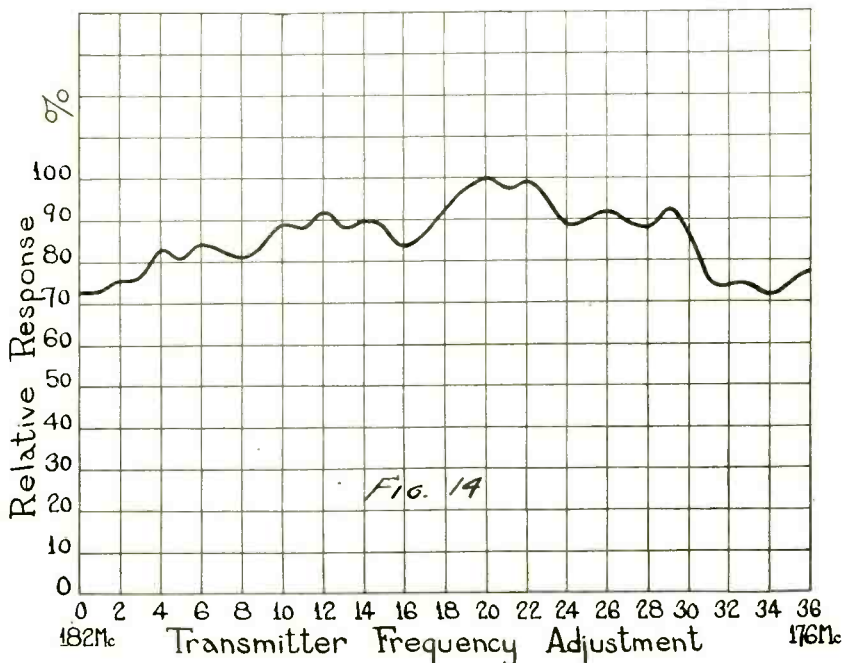

be expected if the transmitting and receiving antennas were half wave dipoles lying in a plane at 45 degrees to the horizon and all reflections took place from ideal horizontal or vertical plane surfaces.

The conditions encountered in this investigation fall far short of such ideal assumptions, as is evident from the curve of Fig. 14, which was taken with both transmitting and receiving antennas oriented at an angle of 45 degrees to the horizon.

The investigation which has been discussed, shows that, where the frequency band is a substantial percentage of the carrier frequency, variation in signal strength within the band may occur unless special precautions are taken to eliminate the

effects of indirect rays. A few indirect rays having amplitudes of the order of 10% or less of the amplitude of the direct ray, may cause considerable variation in the received signal.

The authors wish to acknowledge the valuable assistance given them by W. C. Resides, T. J. Buzalski, and other members of the Development Division of the National Broadcasting Company, and J. W. Conklin of RCA Communications, who designed the special transmitter.

# ELECTRON OPTICAL SYSTEM OF TWO CYLINDERS AS APPLIED TO CATHODE RAY TUBES\*

By

D. W. EPSTEIN

(RCA Manufacturing Co. Inc., Camden, N. J.)

*Summary*—The electron beam of a cathode ray tube is usually focused by means of an electron optical system of two coaxial cylinders. This paper presents a detailed treatment of such a focusing system and is divided into two parts.

Geometric electron optics of axially symmetric electro-static (e.s.) fields is presented in Part I. This part deals with (1) the analogy between light and electron optics, (2) motion of electrons in axially symmetric e.s. fields, (3) definition and determination of positions of cardinal points due to axially symmetric e.s. fields, (4) thick and thin lenses.

The lenses equivalent to the e.s. fields of two coaxial cylinders are discussed in Part II. This part deals with (1) positions of cardinal points due to two coaxial cylinders of various diameters and at various voltages, (2) use of such cardinal points, (3) experimental determination of positions of cardinal points, (4) spherical aberration of e.s. field due to two cylinders.

The results are applied to the cathode ray tube, throughout the discussion.

## INTRODUCTION

THE exacting demands on cathode ray tubes used for present day purposes require that the tube designer have a clear and detailed understanding of the operation of the tube. It is very convenient to treat the operation of a cathode ray tube in terms of geometric electron optics. In geometric electron optics use is made of the well known fact that the trajectory of an electron in electrostatic fields is similar to the trajectory of a ray of light in refractive media. Because of this similarity the concepts of geometric optics such as, lens, focal length, etc. may be transferred to electrostatic fields. From this point of view a cathode ray tube is nothing else than an axially symmetric optical system.

Figure 1 gives the cross-section thru the axis of a cathode ray tube. The whole electrostatic focusing system associated with the various electrodes may be considered as two axially

\* Presented to the Faculty of the Moore School of Electrical Engineering of the University of Pennsylvania in partial fulfillment of the requirements for the degree of Doctor of Philosophy.

Reprinted from Proceedings of the Institute of Radio Engineers.

symmetric electrostatic lenses: one existing close to the cathode and caused by the potentials on the cathode grid and first anode and the other existing near the end of the first anode and caused by the difference in potential between the first and second anodes.

The discussion in this paper will be limited to the second lens. For the purposes of this paper the first lens\* may be considered as concentrating the electrons emitted by the cathode into a small new source which serves as the object for the second lens. The second lens then images this object on the fluorescent screen producing the visible spot.

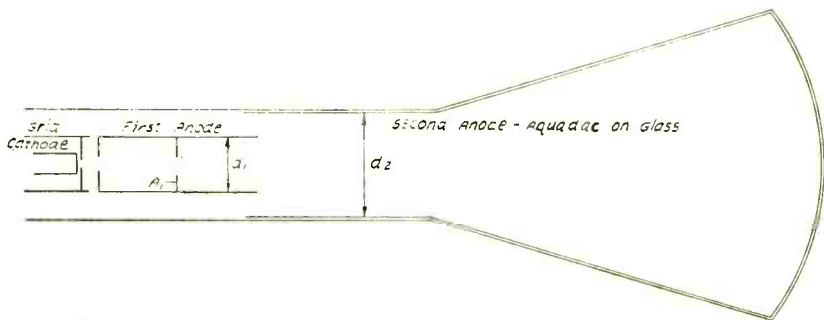

Fig. 1—Cathode Ray Tube

## PART I. ELECTRON OPTICS OF AXIALLY SYMMETRIC ELECTROSTATIC FIELDS\*

In the early part of the nineteenth century, Sir William Hamilton showed that a strict analogy exists between the path of a ray of light passing thru refracting media and the path of a particle passing thru conservative fields of force. The track of an electron moving thru electrostatic and magnetostatic fields is therefore similar to the track of a ray of light passing thru refracting media. Geometrical electron optics is the name given to the subject dealing with the paths of electrons in electrostatic and magnetostatic fields when considered from the point of view of geometrical optics.

\* For an analysis of the first lens see "Theory of Electron Gun" by I. G. Maloff and D. W. Epstein, I.R.E. vol. 22, Dec. 1934, pp. 1386-1411.

\* The theory of geometrical electron optics has been developed by H. Bush, Ann. d. Phys. 81, p. 976, 1926; Archiv. für. Elekt. XVIII, p. 583, 1927; J. Picht, Ann. d. Phys. 15, p. 926, 1932; W. Glaser, Zeits. f. Phys. 80, p. 451, 1933; Zeits. f. Phys. 81, p. 647, 1933; Zeits. f. Phys. 83, p. 104, 1933.

### Analogy of Electron and Light Optics

The principle of least time may be taken as the basis of geometrical optics. This principle states that the path of a ray of light from point  $A$  to point  $B$  is always such as to make the integral

$$\int_A^B \mu(v, x, y, z) ds$$

$ds =$  element of path  
 $\mu =$  index of refraction  
 $v =$  frequency

an extremal (usually a minimum) with respect to all neighboring paths for rays of the same frequency. The principle is usually stated as

$$\delta \int_A^B \mu(v, x, y, z) ds = 0 \quad (v = \text{constant}) \quad (1)$$

The principle of least action for electron velocities less than one-tenth the velocity of light states that an electron of total energy  $E$ , kinetic energy  $T$  and mass  $m$  moves thru an electrostatic field with potential energy  $V(x, y, z)$  in such a way as to make the action integral

$$S = \int_A^B 2 T dt = \int_A^B [2m (E - V)]^{1/2} ds$$

over the actual path between the two points  $A$  and  $B$  an extremal as compared with its value for all adjacent paths for the same value of  $E$ . As the integrand  $[2m (E - V)]^{1/2}$  is identical with the *absolute* value of the momentum  $p$  which the electron would assume at  $(x, y, z)$ , the principle may be stated as

$$\delta \int_A^B p(E, x, y, z) ds = 0 \quad (E = \text{constant}) \quad (2)$$

A comparison of equations (1) and (2) shows that the path of an electron in an electrostatic field may be identified with the rays of light in geometrical optics if the index of refraction is chosen to be

$$\mu = k'' [E - V]^{1/2} = k' p = kv \quad (3)$$

where  $k$  is a constant of proportionality and  $v$  is the speed of the electron. So the index of refraction at any point of an electro-

static field is proportional to the speed of the electron at the point. If, as is customarily done, the index of refraction is taken as a pure numeric then  $k$  must have the dimensions of  $\frac{1}{v}$ . The value assigned to  $k$  is of no importance since only the ratio of  $\mu$  at two different places is used, so that if  $\mu_1$ , and  $\mu_2$  are the indices of refraction at two different places, the relative index of refraction is

$$\frac{\mu_2}{\mu_1} = \frac{kv_2}{kv_1} = \frac{v_2}{v_1} \quad (4)$$

Since the potential function  $V(x, y, z)$  is a continuous scalar function of position it follows from equation (3) that the index of refraction of an electrostatic field is also a continuous function of position. Optically speaking, this means that an electrostatic field constitutes an isotropic, non-homogeneous medium for electrons (corresponding to a medium of uniformly variable density for light rays).

If a magnetostatic field be also present then the index of refraction is

$$\mu = k[v - \frac{e}{|v|m} (\bar{v} \cdot \bar{A})]^* \quad (5)$$

where  $(\bar{v} \cdot \bar{A})$  stands for the scalar product of the vectors  $\bar{v}$  and  $\bar{A}$ , where  $\bar{A}$  is vector potential defined by the relation

$$\bar{H} = \text{Curl } \bar{A}$$

Equation (5) shows that  $\mu$  is a function not only of position but also of direction. This shows that a magnetostatic field constitutes an anisotropic medium for electrons (corresponding to a crystalline medium for light).

Here, the interest lies in electrostatic fields only and therefore no more will be said of magnetostatic fields.

### *Axially Symmetric Focusing Systems*

Therefore certain forms of electrostatic fields will act as focusing systems or "lenses" for electron beams, just as certain

\* The Lagrangian function for an electron moving with the velocity  $v (< .1c)$  thru electrostatic and magnetostatic fields is



$$L = \frac{1}{2} m v^2 - V - e (\bar{v} \cdot \bar{A}).$$

From which it follows that

$$\int p ds = \int \frac{\partial L}{\partial v} ds = \int \left\{ m v - \frac{e}{|v|} (\bar{v} \cdot \bar{A}) \right\} ds$$

and hence equation (5).

forms of refracting media act as focusing systems for light beams. The forms of fields required will depend upon the type of focusing.

For many purposes, as in the cathode ray tube, the interest lies in an electron focusing system having axial symmetry. Most optical systems for light consist of a series of spherical refracting

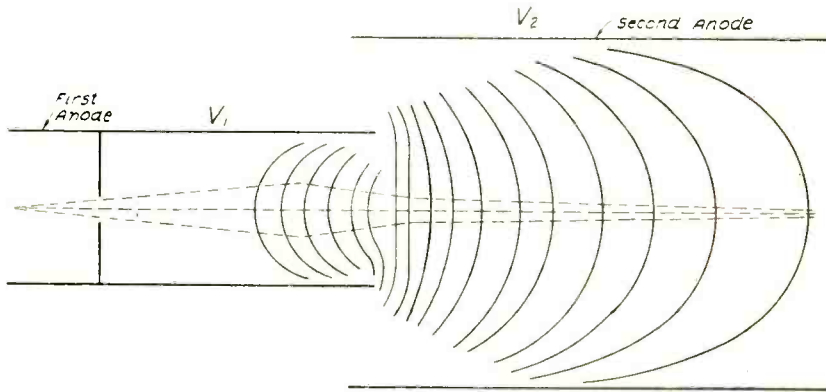

Fig. 2—Equipotential Line Plot of Two Cylinders

surfaces having a common axis of symmetry called the optic axis. In the case of light, however, the optical systems are usually such that the index of refraction changes abruptly as light passes from one to the other medium. In the case of electron optics, the index of refraction is a continuous function of position.

Figure 2 represents a cross-section thru the axis of an electron focusing system; the heavy lines represent two cylindrical, metallic electrodes at the potentials  $V_1$  and  $V_2$ , the light lines represent the equipotential surfaces in the space (vacuum) between the electrodes. From equation (3) it follows that each equipotential surface represents a surface of constant index of refraction. In Fig. 2 there are shown only a few of the equi-

potential surfaces, actually there are, of course, an infinite series of equipotential surfaces having a common axis. The electron focusing system of Fig. 2 may therefore be considered as a very large number of coaxial refracting surfaces.

To illustrate the focusing action of the electrostatic field consider the artificial case of a spherical surface separating two media of different indices of refraction. Let  $S$  of Fig. 3 be such a surface, and let  $R$  be its radius; further let the *e.s.* potential to the left of  $S$  be  $V_1$ , and to the right  $V_2$ . Now consider an electron moving in the direction  $PO$  with the velocity  $v_1$ . As it arrives

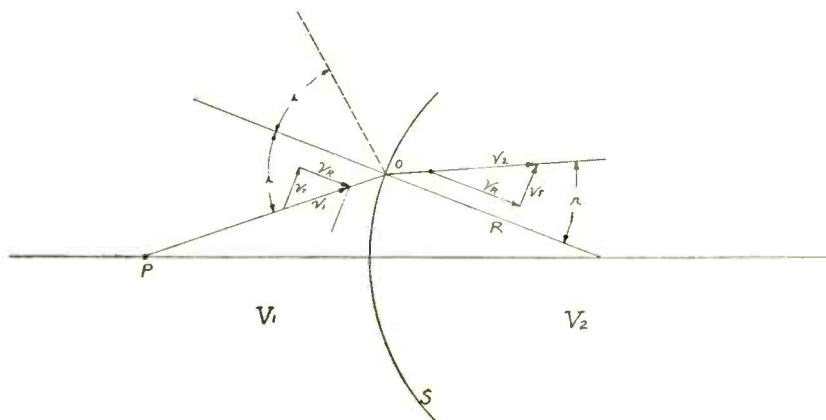

Fig. 3—Electron Refraction and Reflection at Spherical Surface.

at the surface a force normal to the surface in the direction of  $R$  will act on it, and when it has passed thru the surface its velocity will have changed to, say,  $v_2$ . The force being normal to the surface, only the component of initial velocity  $v_R$  normal to the surface will change; the tangential component of velocity  $v_T$  will be the same on both sides of the surface. From Fig. 2 it thus follows that

$$v_T = V_1 \sin i = v_2 \sin r$$

where  $i$  and  $r$  are the angles of incidence and refraction respectively. Hence

$$\frac{\sin i}{\sin r} = \frac{v_2}{v_1} = \mu \quad (\text{a constant}) \quad (6)$$

So if  $\frac{v_2}{v_1}$  be the index of refraction then equation (6) is the well known law of refraction.

It is instructive to express equation (6) in a different form. The work done by the field on the electron when it goes from the first to the second medium is  $e(V_2 - V_1)$ . Then from the law of conservation of energy it follows that

$$\frac{1}{2} m v_2^2 = \frac{1}{2} m v_1^2 + e (V_2 - V_1)$$

so

$$\mu = \frac{v_2}{v_1} = \sqrt{1 + \frac{e(V_2 - V_1)}{\frac{1}{2} m v_1^2}} \quad (7)$$

If further the initial velocity of the electron  $v_1$  is that corresponding to the voltage  $V_1$ , then  $\frac{1}{2} m v_1^2 = eV_1$ , and

$$\mu = \frac{v_2}{v_1} = \sqrt{1 + \frac{(V_2 - V_1)}{V_1}} = \sqrt{\frac{V_2}{V_1}} \quad (8)$$

If  $V_2 < V_1$ , then  $V_2 - V_1$  is negative and if in absolute magnitude it is larger than  $\frac{1}{2} m (v_1 \cos i)^2$ —the part of the kinetic energy of the electron corresponding to the normal component of its velocity—then the electron will be shot back from the surface with its normal velocity component reversed. The direction of the reflected electron makes with the normal to the surface the same angle  $i$  as that of the incident ray.

### *Potential of Axially Symmetric Electrostatic Fields*

To determine the potential distribution in space due to assigned potentials on axial symmetric electrodes it is necessary to solve the reduced Laplace equation

$$\frac{\partial^2 V}{\partial r^2} + \frac{1}{r} \frac{\partial V}{\partial r} + \frac{\partial^2 V}{\partial z^2} = 0 \quad (9)$$

subject to the boundary conditions that  $V$  assume the given values of potential on the electrodes. In general, it has not been found possible to obtain a simple analytical solution of equation (9) subject to the actually existing boundary conditions. However, the required solution of equation (9) subject to the existing boundary conditions is easily obtained experimentally. The equipotential line plot shown in Fig. 2 was thus obtained.\*

\* For a method of experimentally determining the potential distribution see E. D. McArthur, "Electronics," p. 192, June 1932.

Of great significance is the fact that the potential distribution in space is uniquely determined if the distribution of potential along the axis together with its even derivatives are known. This is shown as follows: let  $V(r, z)$  be the required solution of equation (3), then due to the axial symmetry one can expand  $V(r, z)$  into an infinite series containing only even powers of  $r$ , i.e.,

$$V(r, z) = V_0(z) + r^2 V_2(z) + r^4 V_4(z) \dots + r^{2n} V_{2n}(z) + \dots \quad (10)$$

Substituting (10) into (9) and equating the coefficients of equal powers of  $r$  to zero there results that

$$V(r, z) = V_0(z) - \frac{r^2}{2^2} V_0''(z) + \frac{r^4}{2^2 \cdot 4^2} V_0^{(4)}(z) + \dots \\ + \frac{(-1)^n r^{2n}}{2^2 \cdot 4^2 \dots (2n)^2} V_0^{2n}(z) + \dots \quad (11)$$

By setting  $r = 0$  in equation (11) note that  $V(0, z) = V_0(z)$  i.e.  $V_0(z)$  represents the distribution of potential along the axis. So if the function  $V_0(z)$  together with all its even derivatives are known, then the potential distribution off the axis can be found by means of equation (11).

### Equations of Motion of Electron

The equations of motion of an electron moving in a meridian plane are

$$m \frac{d^2 z}{dt^2} = e \frac{\partial V}{\partial z} \quad (12) \\ m \frac{d^2 r}{dt^2} = e \frac{\partial V}{\partial r}$$

In terms of the axial distribution of potential these equations become from equation (11)

$$m \frac{d^2 z}{dt^2} = e \left[ V_0'(z) - \frac{r^2}{2^2} V_0^{(3)}(z) + \dots \right. \\ \left. + \frac{(-1)^n r^{2n}}{2^2 \cdot 4^2 \dots (2n)^2} V_0^{(2n+1)}(z) + \dots \right]$$

$$m \frac{d^2r}{dt^2} = e \left[ -\frac{r}{z} V_0''(z) + \frac{r^3}{2^2 \cdot 4} V_0^{(4)}(z) + \dots \right. \\ \left. + \frac{(-1)^n r^{2n-1}}{2^2 \cdot 4^2 \dots (2n-1)^2 \cdot 2n} V_0^{(2n)}(z) + \dots \right] \quad (13)$$

**Energy Equation**

Adding the two equations (12) we have

$$m \left[ \frac{dz}{dt} d\left(\frac{dz}{dt}\right) + \frac{dr}{dt} d\left(\frac{dr}{dt}\right) \right] = e \left( \frac{\partial V}{\partial z} dz + \frac{\partial V}{\partial r} dr \right) = edV \quad (14)$$

Equation (14) is exact and its solution is

$$\frac{1}{2} m v^2 = \frac{1}{2} m \left[ \left(\frac{dz}{dt}\right)^2 + \left(\frac{dr}{dt}\right)^2 \right] = eV + C$$

If the velocity of the electron is zero when  $V = 0$  then  $C = 0$  and

$$\frac{1}{2} m v^2 = \frac{1}{2} m \left[ \left(\frac{dz}{dt}\right)^2 + \left(\frac{dr}{dt}\right)^2 \right] = eV \quad (15)$$

and

$$v = \sqrt{2 \frac{e}{m} V} = 5.95 \times 10^7 \sqrt{V \text{ volts}} \text{ cm/sec} \quad (16)$$

If  $v = v_0$  when  $V = 0$  then  $C = \frac{1}{2} m v_0^2$  and

$$\frac{1}{2} m (v^2 - v_0^2) = eV$$

If further the velocity  $v_0$  be given in equivalent volts then

$$\frac{1}{2} m v_0^2 = e \frac{V_0}{300} \text{ and}$$

$$v_0 = \sqrt{2 \frac{e}{m} \left(\frac{V + V_0}{300}\right)} = 5.95 \times 10^7 \sqrt{(V + V_0) \text{ volts}} \text{ cm/sec} \quad (17)$$

**Differential Equation of Trajectory of Electron**

It will now be shown that the trajectory of an electron traversing an axially symmetric electrostatic field described by the

potential function  $V(r, z)$  satisfies the following differential equation

$$\frac{d^2r}{dz^2} + \frac{\left[1 + \left(\frac{dr}{dz}\right)^2\right]}{2V} \frac{\partial V}{\partial z} \frac{dr}{dz} - \frac{\left[1 + \left(\frac{dr}{dz}\right)^2\right]}{2V} \frac{\partial V}{\partial r} = 0 \quad (18)$$

To show this note that

$$\frac{d^2r}{dt^2} = \frac{d}{dt} \left( \frac{dr}{dt} \right) = \frac{dz}{dt} \cdot \frac{d}{dz} \left( \frac{dr}{dz} \frac{dz}{dt} \right) = \left( \frac{dz}{dt} \right)^2 \frac{d^2r}{dz^2} + \frac{dr}{dz} \frac{dz}{dt} \frac{d}{dz} \left( \frac{dz}{dt} \right) \quad (19)$$

$$\frac{d^2z}{dt^2} = \frac{d}{dt} \left( \frac{dz}{dt} \right) = \frac{dz}{dt} \frac{d}{dz} \left( \frac{dz}{dt} \right) \quad (20)$$

and that (15) may be written as

$$\frac{1}{2} m \left( \frac{dz}{dt} \right)^2 \left[ 1 + \left( \frac{dr}{dz} \right)^2 \right] = eV \quad (21)$$

From equations (19), (20) and (21) it follows that

$$\frac{d^2r}{dt^2} + \frac{2 \frac{e}{m} V}{\left[ 1 + \left( \frac{dr}{dz} \right)^2 \right]} \frac{d^2r}{dz^2} + \frac{dr}{dz} \frac{d^2z}{dt^2} \quad (22)$$

Inserting into (22) the values of  $\frac{d^2r}{dt^2}$  and  $\frac{d^2z}{dt^2}$  as given by equations (12), there results equation (18).

It is of interest to note that  $\frac{e}{m}$  does not appear in equation (18), signifying that the trajectory is the same for *any* charged particle. Further, it is to be noted that equation (18) is homogeneous in  $V$  so that if the voltages on the electrodes are all increased by a constant factor the trajectory of the electron will remain unaltered. Equation (18) is also homogeneous in  $r, z$  so that if all dimensions are increased by a constant factor then the trajectory is also increased by the same factor.

*Paraxial Electrons*

An optical system is usually described in terms of paraxial or first order imagery. Actual imagery departs from paraxial imagery. Such departures are described as aberrations.

The focusing action of an electrostatic field is similarly described to a first approximation by considering only paraxial electrons. Paraxial electrons are characterized by the fact that in calculating their paths it is assumed that their distances from the axis,  $r$ , and their inclination towards the axis,  $\frac{dr}{dz}$ , are so small that the second and higher powers of  $r$  and  $\frac{dr}{dz}$  are negligible.

For the case of paraxial electrons equations (11), (13) and (15) become

$$V(r, z) = V_0(z) \quad (11)p$$

$$m \frac{d^2 r}{dt^2} = -e \frac{r}{z} V_0''(z) \quad (13)p$$

$$m \frac{d^2 z}{dt^2} = e V_0'(z)$$

$$\frac{1}{2} m v^2 = \frac{1}{2} m \left( \frac{dz}{dt} \right)^2 = e V_0(z) \quad (15)p$$

and that the differential equation for the trajectory traversed by a paraxial electron becomes from equation (18)

$$\frac{d^2 r}{dz^2} + \frac{V_0' dr}{2V_0 dz} + \frac{V_0''}{4V_0} r = 0 \quad (18)p$$

The letter  $p$  after the equation number is to indicate that the equations so lettered are valid for paraxial electrons only.

Equation (18) $p$  (or equations (13) $p$ ) may be taken as the fundamental equation of the electron optics of axially symmetric electrostatic fields.

## THE TWO FUNDAMENTAL TRAJECTORIES

Multiplying equation (18)*p* by  $\sqrt{V}$  there results the self-adjoint\* equation\*\*

$$L(r) = \sqrt{V} \frac{d^2 r}{dz^2} + \frac{V'}{2\sqrt{V}} \frac{dr}{dz} + \frac{V''}{4\sqrt{V}} r =$$

$$\frac{d}{dz} \left( \sqrt{V} \frac{dr}{dz} \right) + \frac{V''}{4\sqrt{V}} r = 0 \quad (23)p$$

Let  $r_1(z)$  and  $r_2(z)$  be two independent solutions of (18)*p* representing the trajectories of two electrons then

$$r_2 L(r_1) - r_1 L(r_2) = \frac{d}{dz} \left\{ \sqrt{V} \left( r_2 \frac{dr_1}{dz} - r_1 \frac{dr_2}{dz} \right) \right\} = 0 \quad (24)p$$

Integrating this equation between the limit  $a$  and  $b$  there results that\*\*\*

$$\int_a^b \left\{ r_2 L(r_1) - r_1 L(r_2) \right\} dz = \left[ \sqrt{V} \left( r_2 \frac{dr_1}{dz} - r_1 \frac{dr_2}{dz} \right) \right]_a^b = 0$$

substituting the limits,

$$\sqrt{V}(b) \left\{ r_2(b) r_1'(b) - r_1(b) r_2'(b) \right\} =$$

$$\sqrt{V}(a) \left\{ r_2(a) r_1'(a) - r_1(a) r_2'(a) \right\} \quad (25)p$$

In particular let  $r_1(z)$ ,  $r_2(z)$ ,  $r_1'(z)$  and  $r_2'(z)$  assume the following values at  $a$  and  $b$

$$\begin{array}{ll} r_1(a) = h_1 & r_1(b) = 0 \\ r_1'(a) = 0 & r_1'(b) = \tan \beta_2 \\ r_2(a) = 0 & r_2(b) = -h_2 \\ r_2'(a) = \tan \beta_1 & r_2'(b) = 0 \end{array} \quad (26)b$$

\*. See "Ordinary Differential Equations," E. L. Ince, page 215.

\*\* For the remainder of this paper  $V$  stands for the axial distribution of potential.

\*\*\* This discussion is limited to e.s. fields having finite extension i.e.  $V = V(z)$  for  $\alpha \leq z \leq \beta$  and  $V = \text{constant}$  for  $\alpha \geq z \geq \beta$  and further  $a \leq \alpha$  and  $b \geq \beta$ .



then equation (25)*p* reduces to

$$\sqrt{V(b)} h_2 \tan \beta_2 = \sqrt{V(a)} h_1 \tan \beta_1 \tag{27}p$$

The two trajectories  $r_1(z)$  and  $r_2(z)$  satisfying equations (26)*p* will be called the two fundamental trajectories. Figure 4 shows two fundamental trajectories. Any two independent trajectories may be taken as the fundamental pair, this particular pair is chosen because by means of this pair the usual optical

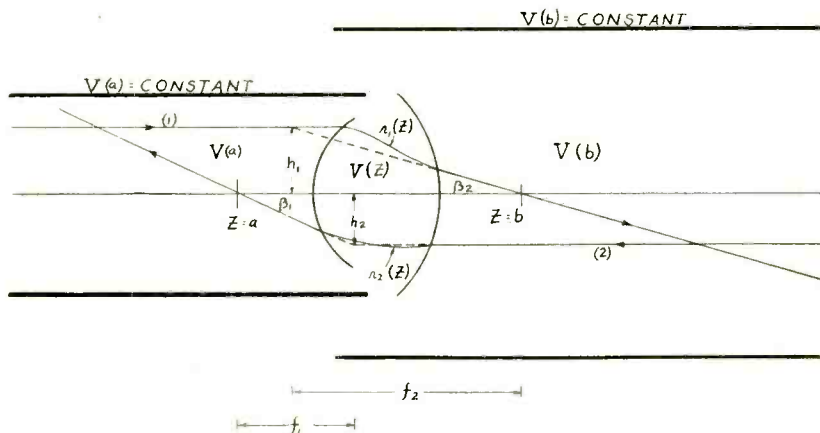

Fig. 4—Two Fundamental Trajectories.

relations are easily obtained. Thus equation (27)*p* corresponds to Lagrange's Law

$$\mu_2 h_2 \tan \beta_2 = \mu_1 h_1 \tan \beta_1$$

Let  $f_1$  and  $f_2$  be the focal lengths of the focusing system then (see Fig. 4)

$$f_1 = -\frac{h_2}{\tan \beta_1} \text{ and } f_2 = \frac{h_1}{\tan \beta_2} \tag{28}p$$

by definition. Inserting (28)*p* into (27)*p* there results that

$$\frac{f_2}{f_1} = -\sqrt{\frac{V(b)}{V(a)}} \tag{29}p$$

Equation (29)*p* corresponds to the well known optical relation that the ratio of the focal lengths of a system is equal to the ratio of the indices of refraction on the two sides of the system.

Further let

$$X_1 = \frac{h_1}{\tan \beta_1} \text{ and } X_2 = \frac{-h_2}{\tan \beta_2} \quad (30)_p$$

then from (30)<sub>p</sub> and (28)<sub>p</sub> it follows that

$$X_1 X_2 = f_1 f_2 \quad (31)_p$$

$X_1$  is the distance between an object and the first focal point and  $X_2$  is the distance between the image and the second focal point,

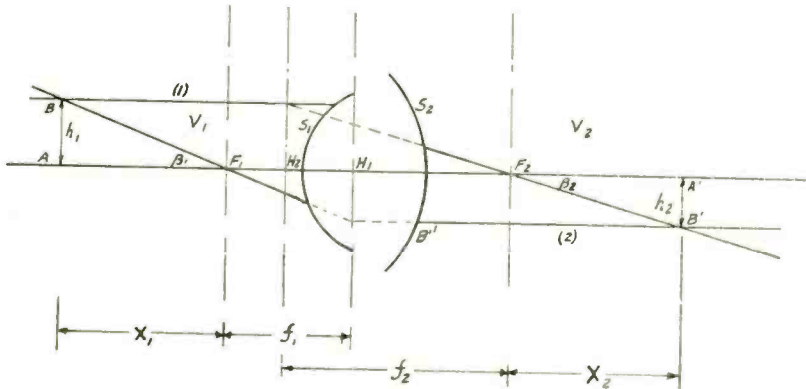

Fig. 5—Location of Cardinal Points.

if  $h_1$  is the height of the object and  $h_2$  is the height of the image. The magnification is from (28)<sub>p</sub> and (30)<sub>p</sub>

$$m = \frac{h_2}{h_1} = -\frac{f_1}{X_1} = -\frac{X_2}{f_2} \quad (32)_p$$

The points  $F_1$ ,  $F_2$ ,  $H_1$  and  $H_2$  shown in Fig. 5 constitute the set of cardinal points of the focusing system.  $F_1$  and  $F_2$  are the first and second focal points and  $H_1$  and  $H_2$  are known as the first and second principal points, respectively.

#### EQUIVALENT LENS OF AXIALLY SYMMETRIC FIELD

By determining the two fundamental trajectories  $r_1(z)$  and  $r_2(z)$  one is enabled to determine the location of the cardinal points of the focusing system, i.e., the location of the focal and principal points. A knowledge of the location of these cardinal points is sufficient for the determination of the paraxial focusing action of the field. It is therefore permissible to replace the

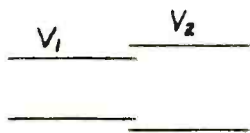

(a)

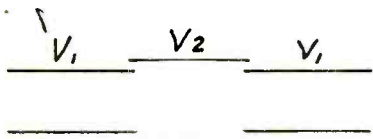
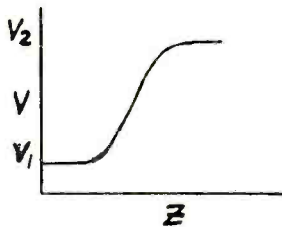

(b)

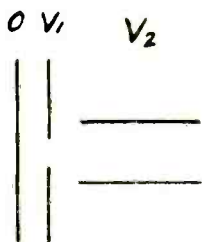
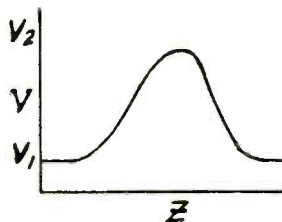

(c)

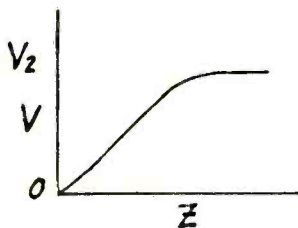

(d)

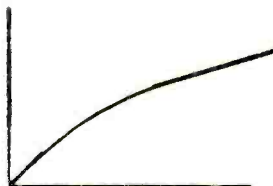

Fig. 6—Types of Electrostatic Lenses.

electrostatic field by the set of cardinal points. This set of cardinal points constitutes a lens, which may be called the equivalent lens of the field.

It is thus seen that an electrostatic field having axial symmetry will bring a paraxial electron beam to a focus. Fields possessing axial symmetry may be produced by applying various voltages to electrodes having geometric axial symmetry, such as coaxial cylinders, cones, disks with apertures, etc. Figure 6 gives the axial cross-sections of several focusing electrode combinations, together with the distribution of potential along the axis.

#### DETERMINATION OF CARDINAL POINTS

It is now appropriate to consider in some detail how to evaluate the focusing action of an axially symmetric electrostatic field, i.e., how to find the cardinal points of the equivalent lens. Referring to Fig. 5 let  $S_1$  and  $S_2$  be two equipotential surfaces such that the space to the left of  $S_1$  is equipotential and is at potential  $V_1$  and the space to the right of  $S_2$  is equipotential and at the potential  $V_2$ . The potential in the region between  $S_1$  and  $S_2$  varies continuously, in some such manner as indicated in Fig. 2. Then the paraxial electron (1) moving parallel to the axis in the equipotential space to the left of  $S_1$  will, after passing thru the focusing system move in a direction inclined at an angle to the axis and will pass thru the axial point  $F_2$ . All paraxial electrons moving parallel to the axis in the object space\* will pass thru  $F_2$ . The point  $F_2$  is known as the second focal point. The plane passing thru the second focal point and perpendicular to the axis of symmetry is known as the second focal plane.

The plane perpendicular to the axis and passing thru the point of intersection of the original and final directions of motion of the electron (1) is known as the second principal plane. The point of intersection  $H_2$  between the second principal plane and the axis is known as the second principal point. The distance  $H_2F_2$  denoted by  $f_2$  is known as the second focal length.

Similarly, the paraxial electron (2) moving parallel to the axis in the image space will after passing thru the focusing system move in a direction inclined to the axis, and will pass thru the point  $F_1$  in the object space.  $F_1$  is known as the first focal point.  $F_1$  may also be considered as that axial point in the

\* The region to the left of the plane  $H_1$  is the object space and the region to the right of  $H_2$  is the image space.

object space from which all electrons, after passing thru the focusing system, are parallel to the axis in the image space.

The plane perpendicular to the axis of symmetry and passing thru the first focal point is known as the first focal plane. The plane perpendicular to the axis and passing thru the point of intersection of the original and final directions of motion of the electron (2), is known as the first principal plane. The point of intersection,  $H_1$ , of the first principal plane and the axis is known as the first principal point.

It is to be noted that in Fig. 5 the principal planes are crossed, that is, the object and image spaces overlap. This is a characteristic of lenses having indices of refraction different on the two sides. As any two electrode electrostatic lens will have the indices of refraction (i.e., the speeds of the electrons) different on the two sides of the lens, it follows that any two electrode electrostatic lens will have its principal planes crossed.

#### USE OF CARDINAL POINTS

Having the cardinal points of the lens one may now obtain either graphically or by means of equations (31) $p$  and (32) $p$  the position and magnification of a given object. Thus in Fig. 5 let  $A B$  be an object from which electrons issue (to make it more concrete let the object  $A B$  be an aperture thru which electrons are passing). Then a paraxial electron coming from  $B$  and moving parallel to the axis will after passing thru the lens go in the direction  $F_2 B'$ . A paraxial electron issuing from  $B$  in the direction  $B F_1$  will after passing thru the lens go in the direction  $B'' B'$ . Similarly, for every point of the object  $A B$ , and so the inverted image  $A' B'$  is obtained. The ratio  $A' B'/A B$  gives the magnification. The electron image of  $A B$  becomes visible if a fluorescent screen be placed in the plane of  $A' B'$ .

Instead of obtaining the position and magnification of the object graphically one can, more simply, obtain them with the aid of equations (31) $p$  and (32) $p$ . Thus, since the values of  $X_1$ ,  $f_1$  and  $f_2$  are known,  $X_2$  the distance between the second principal plane and the image is calculated from equation (31)  $p$  as

$$X_2 = \frac{f_1 f_2}{X_1}$$

and the magnification  $m$  is by (32)  $p$

$$m = -\frac{f_1}{X} = -\frac{X_2}{f_2}$$

Similarly, if the position and size of the image are known, then equations (31) $p$  and (32) $p$  determine the position and size of the object.

### TYPES OF ELECTROSTATIC LENSES

For purposes of identification several different types of electrostatic lenses may be distinguished. By a unipotential lens shall be meant one for which the potential (or the index of refraction) on the two sides of the lens is the same. Whereas if the potential on the two sides of the lens is different, the lens will be called a bipotential lens. It is to be noted that all two electrode lenses are bipotential. (See Fig. 6(a) and (b))

There is a third type of lens which is of importance in the field of cathode ray tubes; this is the immersion lens. This lens is characterized by the fact that the object is immersed in the lens. This is the lens existing at the cathode of most cathode ray tubes.\* (See Fig. 6(c))

A fourth type of lens which is mentioned but which is of little interest here is the so-called aperture lens—see Fig. 6d. The only reason it is here mentioned is that it is the only electrostatic lens of those mentioned that can be made convergent or divergent. The unipotential, bipotential and immersion lenses are always *convergent*.

### THIN LENS

In general all lenses are “thick lenses.” A knowledge of the positions of the focal and principal points is sufficient for the determination of the focusing action of a “thick lens.” To compute the positions of the cardinal points it is necessary to determine the fundamental trajectories. The calculation of the fundamental trajectories is accomplished by the integration of equation (18) $p$ .

A considerable simplification is effected by considering a lens as “thin.” A thin lens is one having negligible thickness along the axis of symmetry and is characterized by the fact that the two principal planes are assumed to coincide with (say, center of) the lens. The paraxial focusing action of a thin lens may therefore be completely determined as soon as the location of the lens and one of the focal lengths say  $f_1$  is known, for by equation (29) $p$ ,  $f_2$  also becomes known.

\* See Fig. 11 of “Theory of Electron Gun,” l.c.

Since for only a lens of zero thickness will the two principal planes coincide with the lens, a practical thin lens will only approximately have the characteristics of the ideal thin lens.

For a thin lens the electrostatic field is confined to such a narrow range of  $z$  that the electron is in the field for such a short time that  $r$  remains sensibly unchanged during the time the electron is in the field. Thus let  $r = r_0$  be the value of  $r$  when the electron is in the field, so equation (18) $p$  becomes

$$\frac{d^2r}{dz^2} + \frac{V'}{2V} \frac{dr}{dz} + \frac{V''}{4V} r_0 = 0 \tag{18}'p$$

Let

$$\frac{\sqrt{V}}{r_0} \frac{dr}{dz} = P$$

then equation (18)' $p$  becomes

$$\frac{dP}{dz} + \frac{V''}{4\sqrt{V}} = 0$$

Let the electrostatic field be confined within the narrow range  $a \leq z \leq b$  then integrating between these limits

$$P_b - P_a + \int_a^b \frac{V''}{4\sqrt{V}} dz = 0$$

Now consider an electron in the object space  $z \leq a$  moving parallel to the axis at the distance  $r_0$  from the axis then at  $a \frac{dr}{dz} = 0$  and so  $P_a = 0$ . At  $b$  the electron issues from the lens still at the distance  $r_0$  but with the slope  $\frac{dr}{dz} = -r'(b)$  so that

$$P_b = -\frac{\sqrt{V_b}}{r_0} r'(b) = -\frac{\sqrt{V(b)}}{f_2}$$

since  $\frac{1}{f_2} = \frac{r'(b)}{r_0}$  by definition,

$$\text{so } \frac{1}{f_2} = \frac{1}{4\sqrt{V(b)}} \cdot \int_a^b \frac{V''}{\sqrt{V}} dz \tag{33}p$$

From equations (33)*p* and (29)*p* it follows that

$$\frac{I}{f_1} = -\frac{1}{4\sqrt{V}(a)} \int_a^b \frac{V''}{\sqrt{V}} dz \quad (34)p$$

By partial integration it may be deduced that

$$\int_a^b \frac{V''}{\sqrt{V}} dz = \frac{1}{2} \int_a^b \frac{(V')^2}{\sqrt{V}^3} dz$$

So equations (33)*p* and (34)*p* become

$$\frac{I}{f_2} = \frac{1}{8\sqrt{V}(b)} \int_a^b \frac{(V')^2}{\sqrt{V}^3} dz \quad (35)p$$

$$\frac{I}{f_1} = -\frac{1}{8\sqrt{V}(a)} \int_a^b \frac{(V')^2}{\sqrt{V}^3} dz \quad (36)p$$

## PART II. OPTICS OF TWO OVERLAPPING COAXIAL CYLINDERS

The electron beam of a cathode ray tube used for present day purposes is usually focused by means of two slightly overlapping coaxial cylinders. Such a focusing system is shown in Fig. 2. As was shown in Part I, one may, for paraxial purposes, replace this focusing system by its four cardinal points constituting the equivalent thick lens.

In order to determine the fundamental trajectories, it is necessary to solve equations (13)*p* or (18)*p*. An exact solution of these equations is obtainable only for simple expressions for  $V(z)$ . The distribution of potential along the axis due to two coaxial cylinders of various diameters is not represented by these simple expressions. If an analytical expression for  $V$  is available, then equation (18)*p* may be integrated in the form of an infinite series.

There is no analytical expression for  $V(z)$  available in the case of two long coaxial cylinders of different diameters. However,  $V(z)$  may be obtained experimentally. But before equation (18)*p* is ready for solution, it is necessary to know

$$V'(z) \left( = \frac{dV}{dz} \right) \text{ and } V''(z) \left( = \frac{d^2V}{d \cdot z^2} \right)$$

These may be obtained by graphical or numerical differentiation



of  $V(z)$ . With  $V(z)$ ,  $V'$  and  $V''$  known equation (13) $p$  or (18) $p$  may be integrated by any step by step method of approximation.

If  $V(r,z)$ , such as shown in Fig. 2, is determined experimentally then one may measure the radii of curvature of the equipotential surfaces along the axis and obtain a relation between  $V'$  and  $V''$  which one may use as a check on the graphical or numerical differentiation. The relation between the radii of curvature  $\rho$  along the axis and  $V'$  and  $V''$  is\*

$$\rho = \frac{2V'(z)}{V''(z)}$$

### ELECTROSTATIC FIELD OF TWO CYLINDERS

Consider the bipotential lens (Fig. 2) due to two long metallic cylinders of diameters  $d_1$  and  $d_2$ , and charged to potential  $V_1$  and  $V_2$ .\*\*

If one of the diameters, say  $d_1$ , is chosen as the unit of length (in both the  $r$  and  $z$  directions) then a given ratio of cylinder diameters,  $d_2/d_1$  always represents the same configuration of electrodes, i.e., two cylinders, one having a diameter of unit length and the other having a diameter of  $d_2/d_1$  units of length. This unit shall be designated as the g.d. (gun diameter).

A given ratio of diameters,  $d_2/d_1$ , will for given voltages  $V_2$  and  $V_1$  always produce the same distribution of potential. Thus Fig. 2 represents the potential distribution for any  $d_1$  and  $d_2$  for which  $d_1$  is taken as the unit of length and  $d_2/d_1$  is that given in Fig. 2. The use of the g.d. as the unit of length greatly simplifies the presentation of information. Thus the two fundamental trajectories and the accompanying cardinal points determined for given cylinder diameters  $d_2$  and  $d_1$  are also the fundamental trajectories for all cylinder diameters  $d_2'$  and  $d_1'$  for which

$$\frac{d_2'}{d_1'} = \frac{d_2}{d_1}$$

The differential equation (18) for the trajectory of an electron remains unchanged if one replaces  $V$  by  $kV$  where  $k$  is a constant. Hence the trajectory of an electron will remain unaltered if the voltages on the electrodes are all multiplied by the

\* See Appendix II of "Theory of Electron Gun," l.c.

\*\* The potential of the Cathode is here taken as the reference of potential.

same factor. The two fundamental trajectories and the accompanying cardinal points depend, therefore, not on  $V_1$  or  $V_2$  but on  $\frac{V_2}{V_1}$ . So that if the cardinal points are determined for given potentials  $V_1$  and  $V_2$  they remain the same for any  $V_1' V_2'$  so long as  $\frac{V_2'}{V_1'} = \frac{V_2}{V_1}$ . Hence a given voltage ratio and a given diameter ratio uniquely determine the positions of the cardinal points of the electrostatic field if the g.d. be used as the unit of length.

From the fact that the potential function is relative, it follows that a given equipotential plot such as that shown in Fig. 2 is independent of  $V_1$  or  $V_2$  but depends solely upon  $V_1-V_2$ . So that a given equipotential plot may be used for the determination of the fundamental trajectories for any voltage ratio  $V_2/V_1$ .

Hence the important result that a given axial distribution of potential (such as shown in Fig. 2) determined for two cylinders of diameters  $d_1$  and  $d_2$  and charged to potentials  $V_1$  and  $V_2$  enables one to determine the positions of the cardinal points of an electrostatic lens made up of two cylinders of diameters  $d_2'$  and  $d_1'$

if  $\frac{d_2'}{d_1'} = \frac{d_2}{d_1}$  and with any voltages on the electrodes.

#### CARDINAL POINTS OF ELECTROSTATIC FIELD OF TWO CYLINDERS

Figure 7 shows the position\* of the cardinal points for a given voltage ratio and diameter ratio. From the equipotential line plots such as shown in Fig. 2, the fundamental trajectories are calculated and the positions of the cardinal points are determined for a series of values of voltage ratios and diameter ratios.

It is to be noted from Fig. 7 that (1) the principal planes are crossed—that is, the object and image space overlap—(2) the focal length of the image space  $f_2$  is greater than the focal length of the object space  $f_1$ ; (3) the principal planes are located inside the first anode (for  $V_1 < V_2$ ). These properties are inherent in a bipotential lens.

Figure 8 shows how the cardinal points vary with the voltage ratio for a diameter ratio 3.6. It is seen that the focal lengths decrease—i.e., the power of the lens increases—as the voltage ratio is increased. Figs. 9, 10 and 11 show the variation of posi-

\* It is convenient to locate the focal points,  $F_1$  and  $F_2$ , by their distances from the end of the gun. Starting with Fig. 7,  $F_1$  and  $F_2$  are therefore indicated as lengths.

tions of the cardinal points with voltage ratio for different diameter ratios. Figure 12 shows how the cardinal points vary with the diameter ratio for a given voltage ratio.

It should be clear that to a given voltage ratio and diameter ratio there corresponds but one set of cardinal points if the g.d. be chosen as the unit of length. It is worth noting that a given ratio of diameters determines the shape (curvature) and the distance between the refractive (equipotential) surfaces (see

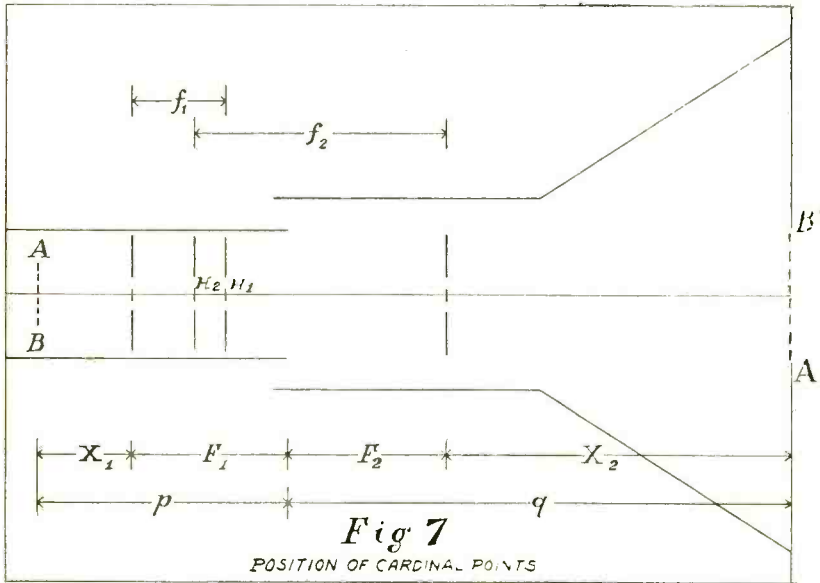

Fig. 7.—Position of Cardinal Points.

Fig. 2), while the voltage ratio determines the indices of refraction between the various surfaces.

The curves of Figs. 8, 9, 10, 11 and 12 show how the cardinal points vary when  $V_2/V_1$  and  $d_2/d_1$  are varied. From these curves one can determine how the cardinal points vary by varying only one of the variables  $V_1$ ,  $V_2$ ,  $d_1$ , and  $d_2$  and keeping the other three constant. Thus by increasing  $V_2$ , keeping  $V_1$ ,  $d_1$  and  $d_2$  constant,  $\frac{V_2}{V_1}$  increases and the focal lengths decrease; by increasing  $V_1$  the focal lengths are increased. By increasing  $d_2$ ,  $\frac{d_2}{d_1}$  increases and so the focal lengths are increased, and by increasing  $d_1$ ,  $\frac{d_2}{d_1}$  decreases and so decreases the focal lengths. It

must be carefully noted, however, that by increasing  $d_1$  the unit of length is increased.

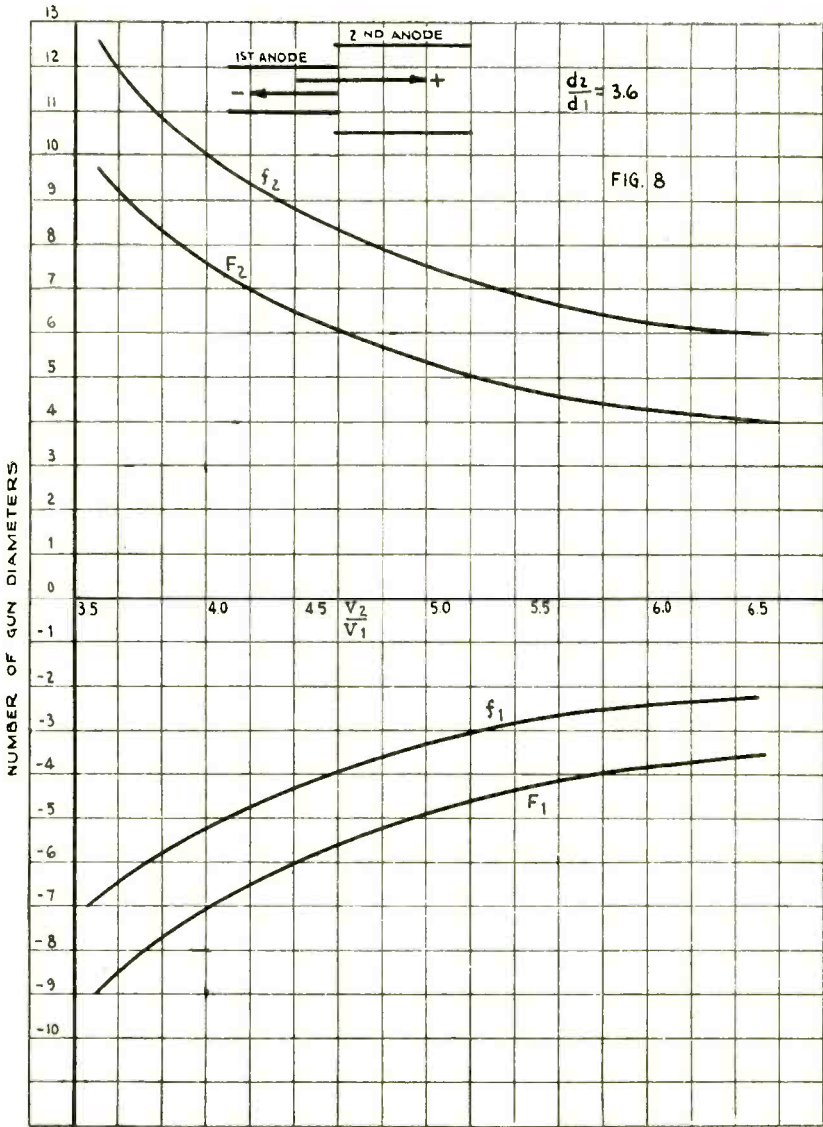

Fig. 8—Variation of Optical Constants with Voltage Ratio.

USE OF CURVES OF CARDINAL POINTS

As an example to illustrate the use of the curves of Figs. 9 to 12 consider the cathode ray tube shown in cross section in Fig. 1. Suppose it were found that in order to obtain the minimum spot on the screen with 1000 volts on the first anode it is

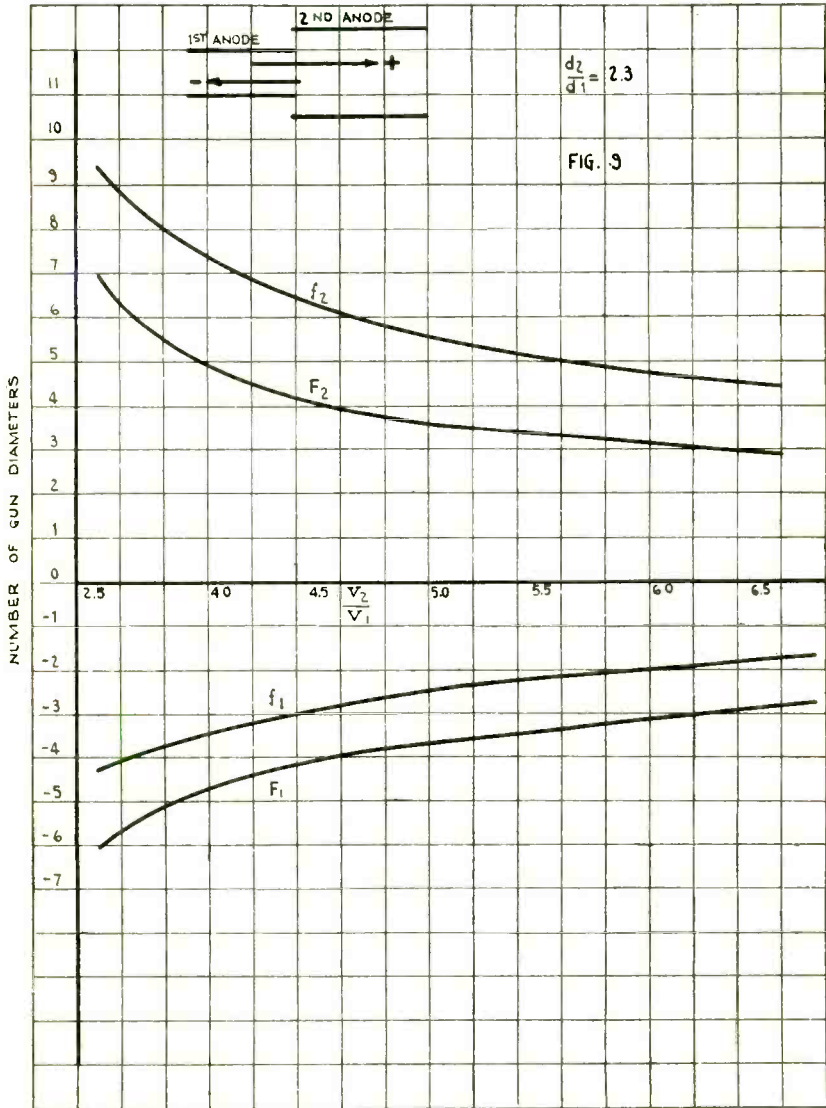

Fig. 9—Variation of Optical Constants with Voltage Ratio.

necessary to have 5000 volts on the second anode. Further let  $d_2 = 3.5$  cm and  $d_1 = 1.5$  cm. Then from Fig. 9 note that for

$$\frac{d_2}{d_1} = 2.3 \text{ and } \frac{V_2}{V_1} = 5,$$

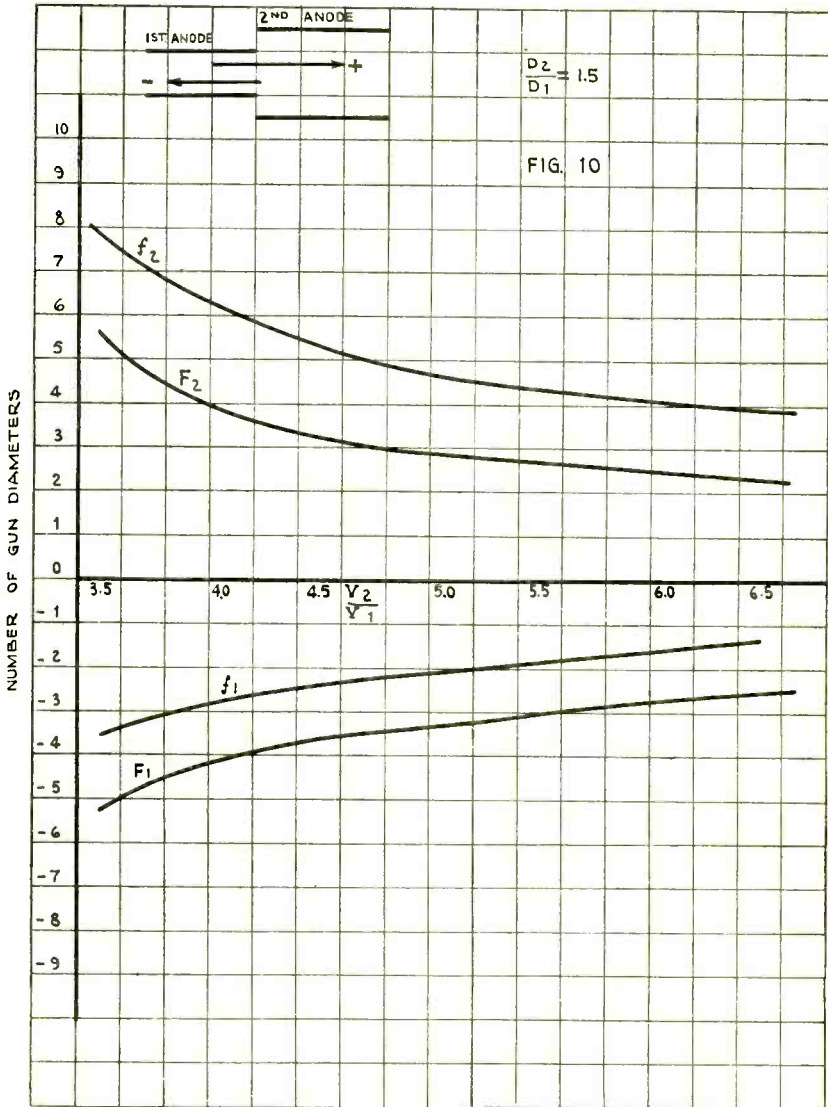

Fig. 10—Variation of Optical Constants with Voltage Ratio.

$$\begin{aligned}
 f_1 &= -2.5 \text{ g.d.} & F_1 &= -3.7 \text{ g.d.} \\
 f_2 &= +5.6 \text{ g.d.} & F_2 &= +3.5 \text{ g.d.}
 \end{aligned}$$

(It must be remembered that these cardinal points hold only for paraxial electrons—in order to use these cardinal points it is therefore necessary to have the aperture  $A_1$  sufficiently small so as to permit only paraxial electrons to enter the lens.)

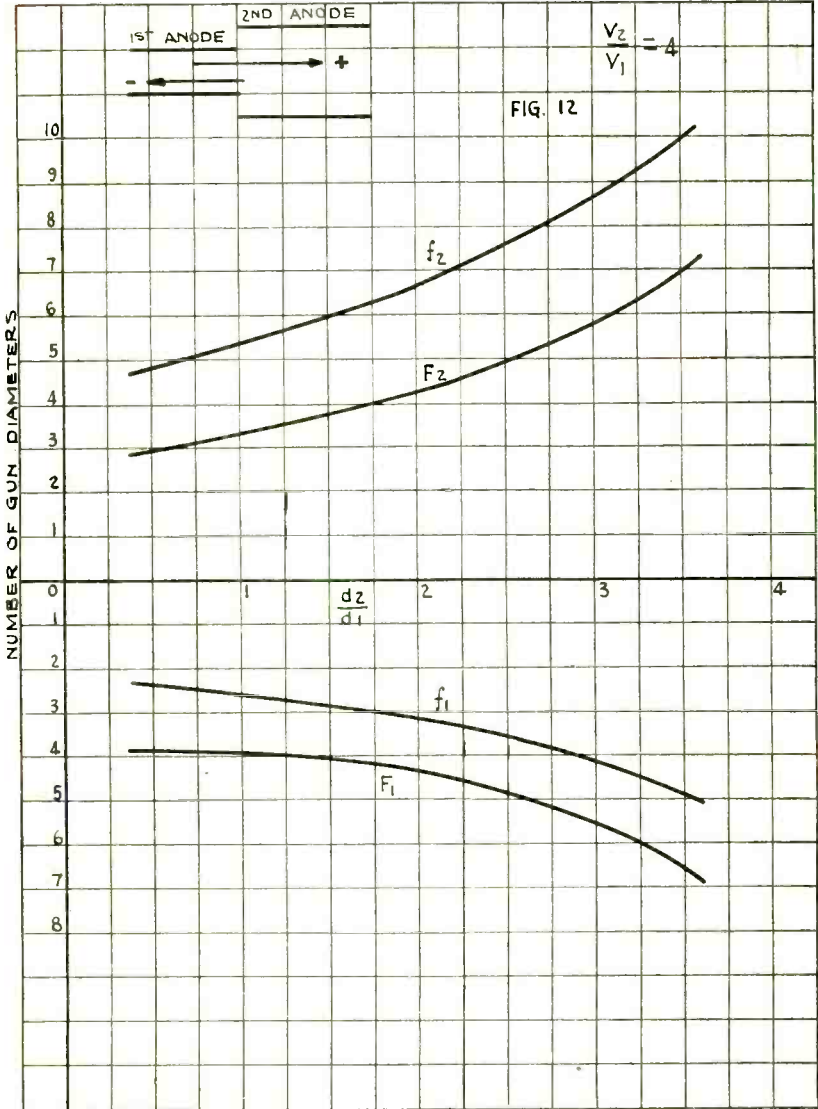

Fig. 11—Variation of Optical Constants with Voltage Ratio.

Let  $q$ , the distance between the screen and end of gun, be 15 *g.d.*, then

$$X_2 = q - F_2 = 15 - 3.5 = 11.5 \text{ g.d.}$$

So by equation (31) $p$

$$X_1 = \frac{f_1 f_2}{X_2} = \frac{-2.5 X (+5.6)}{+11.5} = -1.2 \text{ g.d.}$$

and  $p$ , the distance between object and end of gun is

$$p = X_1 + F_1 = -1.2 - 3.7 = -4.9 \text{ g.d.}$$

By means of equation (32) $p$  the magnification of the object is determined. Thus

$$m = -\frac{f_1}{X_1} = -\frac{2.5}{1.2} = -2.1$$

and if the size of the spot on the screen is measured to be 0.5 mm then the size of the object being imaged on the screen is  $\frac{.5}{2.1} = .24$  mm. So by knowing  $V_2/V_1$ ,  $d_2/d_1$ ,  $q$  and the size of the spot one can by means of the curves of Figs. 8 to 12 and equations (31) $p$  and (32) $p$  determine the position and the size of the object that is imagined on the screen.

A knowledge of the positions of the cardinal points permits one to give quantitative answers to the following questions: What will be the effect on the spot size of a given tube if

- (1) the length of the first anode is varied?
- (2) the diameter of the first anode is varied?
- (3) diameter of second anode is varied?
- (4) the ratio of voltages on the two anodes is varied?
- (5) the distance between the screen and gun end is varied?

It is to be noted, however, that in order to keep the object focused on the screen (minimum spot on the screen) it is necessary to vary at least two of these variables. Thus, if in the above example, the length of the first anode is changed, it will be necessary to change  $\frac{V_2}{V_1}$  or gun screen distance in order to keep the minimum spot on the screen.

The calculation of the effect of the various variables is therefore not straightforward but requires several trials. Thus, in order to use the curves of Figs. 8 to 12 to calculate the effect on the spot size if the length of the first anode is changed, while the



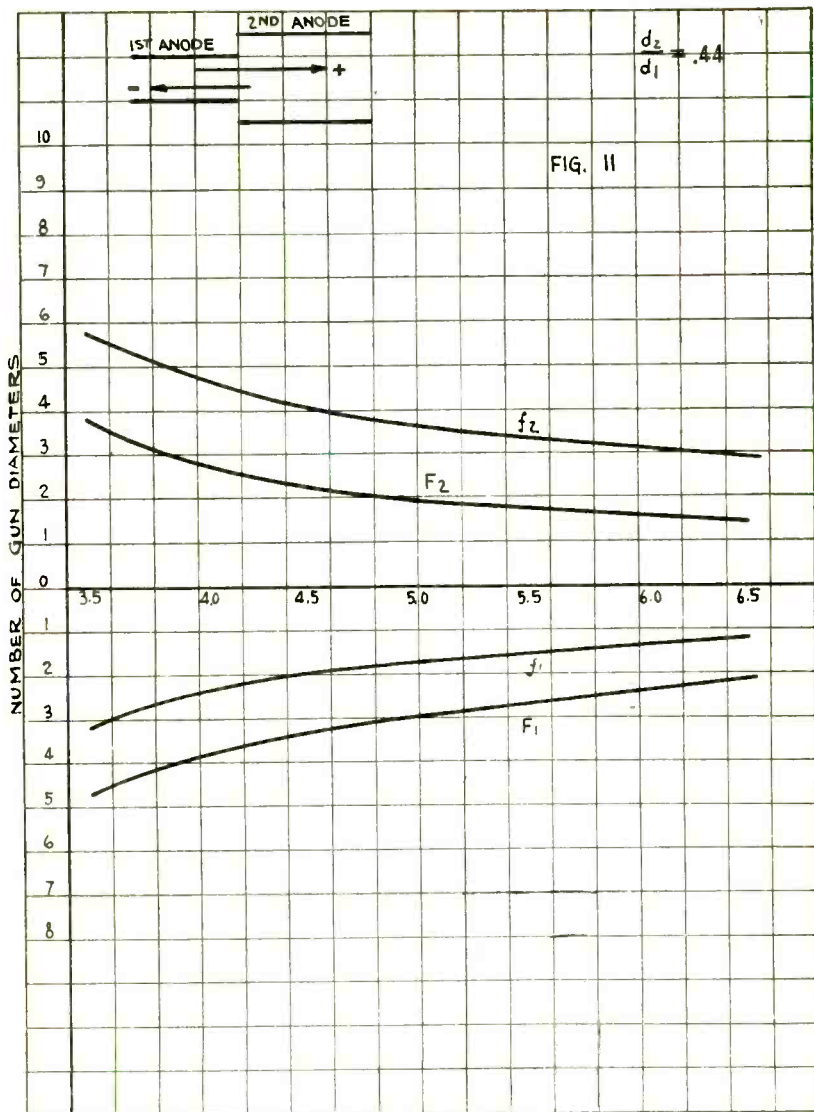

Fig. 12—Variation of Optical Constants with Diameter Ratio.

remaining dimensions in the tube remain unaltered, it is first necessary to know the voltage ratio for the new object distance at which the spot is focused. To get around this difficulty note that with a given ratio  $\frac{d_2}{d_1}$  and given  $q$ ,  $\frac{V_2}{V_1}$  can be calculated as a function of  $p$  and to each  $p$  (and the corresponding  $\frac{V_2}{V_1}$ ) a

magnification can be calculated so that the curves shown in Fig. 13 may be plotted. Figure 13 then gives the change in spot size and voltage ratio caused by a given change in object distance. The curves of Fig. 13 hold for a given image distance; similar curves can be calculated for other image distances.

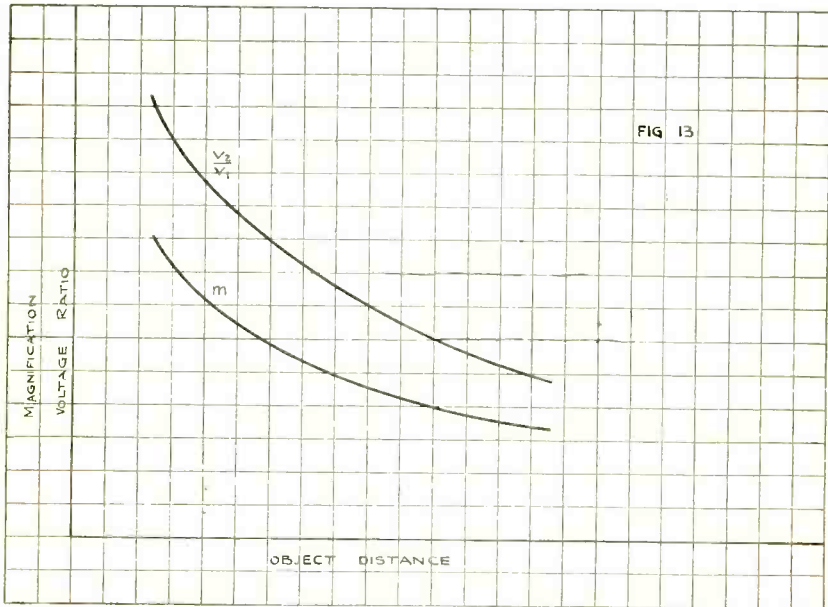

Fig. 13—Magnification and Voltage Ratio vs. Object Distance.

### THIN LENS

If the object and image are at large distances from the end of the gun then to a fair approximation the two principal planes may be assumed to coincide and to be located at the end of the gun. Under these circumstances, the following simple formulæ apply

$$\frac{\sqrt{V_a}}{p} + \frac{\sqrt{V_b}}{q} = \frac{\sqrt{V_a}}{f_1} = \frac{\sqrt{V_b}}{f_2} \quad (37)p$$

and

$$m = -\frac{q}{p} \sqrt{\frac{V_a}{V_b}} \quad (38)p$$

where  $p$  and  $q$  are the object and image distances measured from the end of the gun and  $f_1$  is the first focal length, which

may be calculated from the formula for the focal length of a thin lens given by equation (33)*p*. For this case it is not necessary to determine the fundamental trajectories.

A much better approximation is to consider the lens thin,—that is to assume that the two principal planes coincide—, but to assume the thin lens to be situated between the two principal planes of the thick lens. Here the above formulæ still apply if *p* and *q* are measured from the assumed position of the thin lens instead of from the end of the gun. For this case it is necessary to determine one fundamental trajectory. It is seen from Figs. 8-12 that this thin lens is situated about 1.5 g.d. inside the first anode.

### EXPERIMENTAL DETERMINATION OF CARDINAL POINTS

The position of the cardinal points may be determined experimentally if the magnification is known for two given positions of object and image. Thus in Fig. 7 let AB, representing a fine wire mesh of known dimensions, be the object. The object is "illuminated" with electrons originating at a cathode to the left of AB, and is imaged on a fluorescent screen. Let the distance between the mesh AB and end of gun be *p*, the distance between end of gun and fluorescent screen be *q*, and the magnification with which the mesh is imaged on the screen be *m*. Then from Fig. 7 and the relation for magnification

$$m = \frac{f_1}{X_1} = -\frac{X_2}{f_2} \quad (32) p$$

it follows that

$$p = X_1 + F_1 = \frac{f_1}{m} + F_1 \quad (39) p$$

$$q = X_2 + F_2 = mf_2 + F_2 \quad (40) p$$

Then if *p*<sub>1</sub>, *q*<sub>1</sub>, and *m*<sub>1</sub> correspond to one position of object and *p*<sub>2</sub>, *q*<sub>2</sub>, and *m*<sub>2</sub> correspond to another position of the object (for the same lens, i.e., the voltage ratio and diameter ratio being fixed), then it follows that

$$f_1 = m_1 m_2 \left( \frac{p_1 - p_2}{m_1 - m_2} \right) \quad (41) p$$

$$f_2 = \frac{q_1 - q_2}{m_2 - m_1} \quad (42)p$$

$$F_1 = \frac{m_1 p_1 - m_2 p_2}{m_1 - m_2} \quad (43)p$$

$$F_2 = \frac{m_2 q_1 - m_1 q_2}{m_2 - m_1} \quad (44)p$$

Equations (41)*p*-(44)*p* allow one to determine the positions of all the cardinal points provided the sets of conjugate quanti-



Fig. 14—Gun with Sliding Mesh.

ties  $p_1 q_1 m_1$  and  $p_2 q_2 m_2$  are known. An obvious method for determining these quantities is to use a tube having two independently moving parts—the object mesh and the fluorescent screen on which to image the mesh. It is very difficult, however, to build a tube with two independently moving parts which move over considerable distances.

It is relatively simple, however, to build a tube with one moving part and especially so if the moving part is the object mesh. Fig. 14 shows the cross section of a gun having a moving mesh. The mesh is welded onto an aperture cup which slides inside the gun by merely tilting the tube. The position of the mesh inside the gun is indicated by an index on the outside of the gun which is calibrated.

To determine the two sets of quantities  $p_1 q_1 m_1$  and  $p_2 q_2 m_2$  by means of a tube having only a moving object, one may proceed as follows. The gun is inserted inside a glass blank with the screen at a known distance, say  $q_1$ , from the end of the gun. The voltage ratios required to focus the mesh on the screen and the magnifications of the mesh are then noted for various known positions of the mesh. The results are then plotted as shown by the curves  $p_1$  and  $m_1$  of Fig. 15. The same gun is then inserted into a blank with the screen at a different distance, say

$q_2$ , from the end of the gun. The measurements are repeated with this blank and the results plotted as given by the curves  $m_2$  and  $p_2$  of Fig. 15.

The positions of the cardinal points may then be calculated by means of equations (41)  $p$ - (44)  $p$  and the four curves ( $p_1$ ) ( $m_1$ ) ( $p_2$ ) ( $m_2$ ) of Fig. 15. To do this it is necessary to choose the quantities  $m$  and  $p$  along a vertical line corresponding to a given voltage ratio.

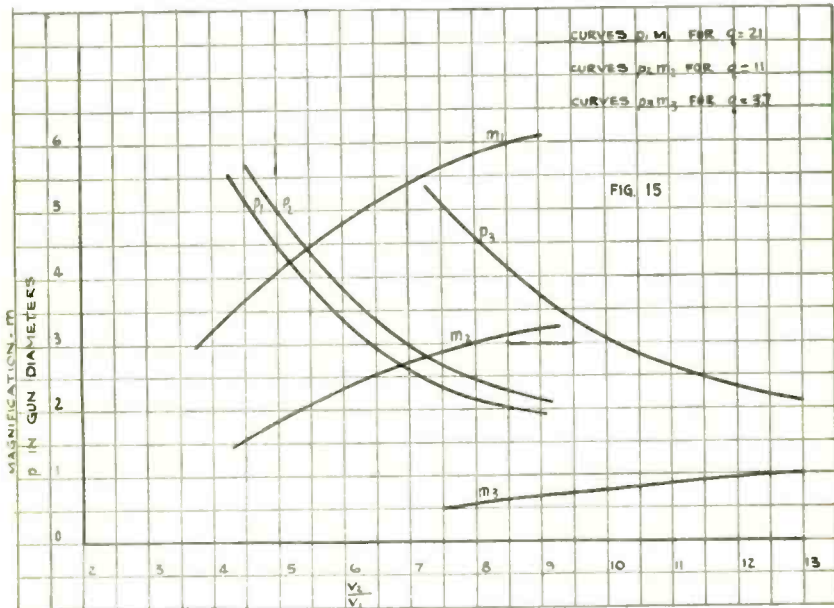

Fig. 15—Magnification and Object Distance vs. Voltage Ratio.

The curves of Fig. 15 were determined, by the method just described, for a lens corresponding to a diameter ratio of 1.5.

The accuracy of determining the positions of the cardinal points by means of equations (41)  $p$ - (44)  $p$  depends greatly upon the accuracy with which the quantities  $p_2 - p_1$ ,  $q_2 - q_1$ , and  $m_2 - m_1$  may be determined from the curves of Fig. 15. A glance at the curves will show that the accuracy of the quantity  $p_2 - p_1$  is rather poor, since it is the difference of two nearly equal quantities. The quantities  $q_2 - q_1$  and  $m_2 - m_1$  are quite accurate, however.

To avoid the use of the quantity  $p_2 - p_1$  one may, instead of using equations (41)  $p$  - (44)  $p$  proceed as follows. Determine

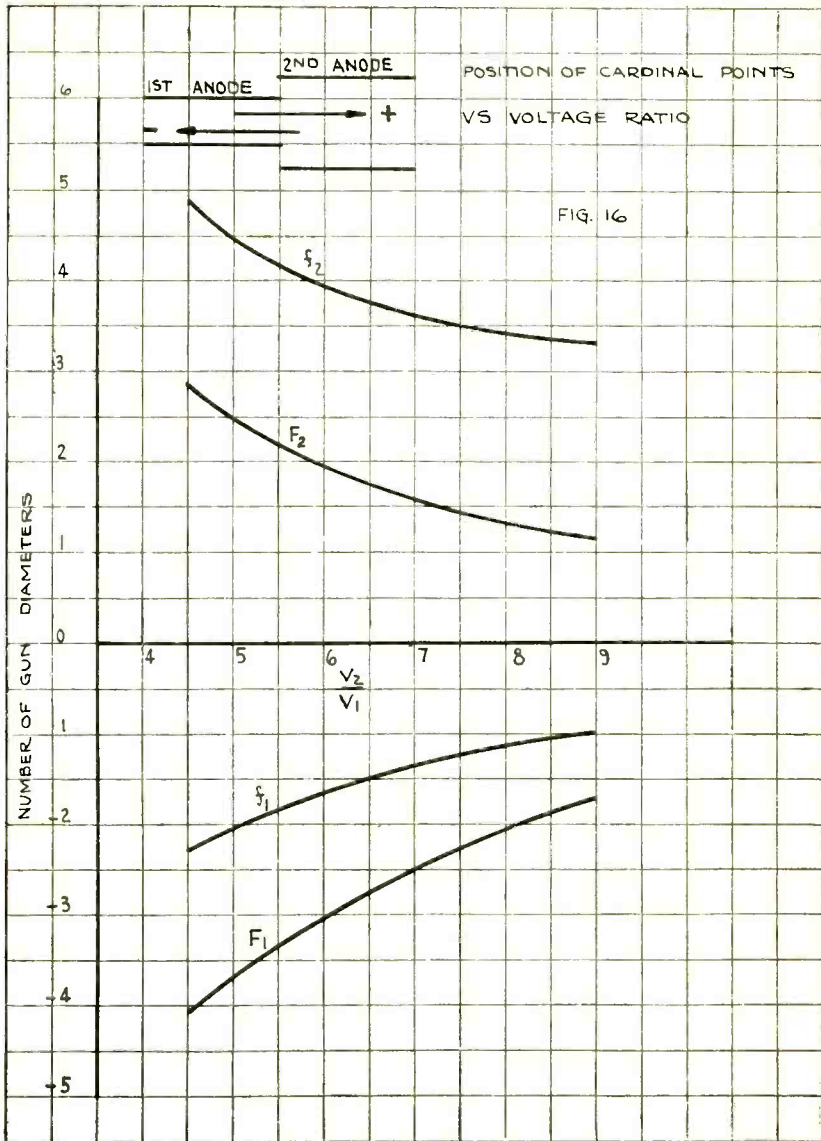

Fig. 16—Position of Cardinal Points vs. Voltage Ratio.

$f_2$  by means of

$$f_2 = \frac{q_1 - q_2}{m_2 - m_1} \tag{42} p$$

$f_1$  is then determined by the relation

$$f_1 = \frac{-1}{\frac{V_2}{V_1}} f_2$$

and the quantities  $F_1$  and  $F_2$  are determined by

$$F_1 = p_1 + \frac{f_1}{m_1} = p_2 + \frac{f_1}{m_2} \tag{45} p$$

$$F_2 = q_1 + m_1 f_2 = q_2 + m_2 f_2 \tag{46} p$$

wherein  $f_2$  and  $f_1$  are the values obtained by means of (42)*p* and (29)*p*.

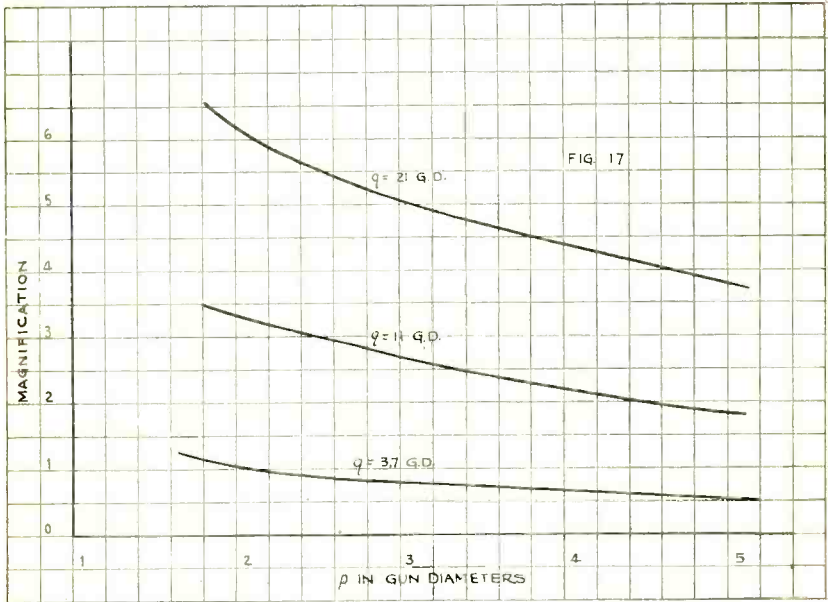

Fig. 17—Magnification vs. Object Distance.

The focal lengths and the positions of the focal points determined as described above are shown plotted in Fig. 16. In Table 1, the value of  $f_1$ ,  $f_2$ ,  $F_1$  and  $F_2$  determined from the experimental data are compared with the theoretical values taken from the curves of Fig. 10. The agreement is within experimental error.

The data as plotted in Fig. 15 is useful only for the determination of the positions of the cardinal points. The data has been replotted in Figs. 17 and 18 showing how the magnification and the focusing voltage ratio vary with the position of the object (or gun lengths) for three positions of the screen (or gun-screen distances). These curves are very useful as gun design information.

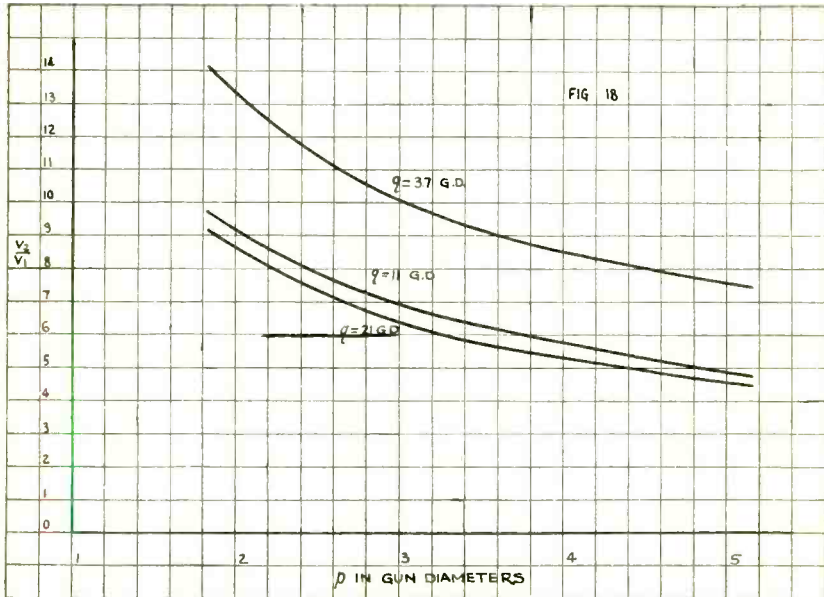

Fig. 18—Voltage Ratio vs. Object Distance.

### THIN LENS

The method described above determines the positions of all the cardinal points and therefore determines the thick lens equivalent to the focusing field. If the object and image are sufficiently distant from the lens we may to a fair approximation consider the lens as thin and situated between the two principal planes of the thick lens. The position and the focal lengths of the thin lens may be determined experimentally by simply noting the distance between object and image, magnification, and voltage ratio at which the object is focused on the screen.

Thus in Fig. 19 let  $L$  be the equivalent thin lens and let  $u$  and  $v$  be the object and image distances measured from the thin



lens. The following thin lens relations then apply

$$\frac{1}{u} + \frac{1}{v} \sqrt{\frac{V_2}{V_1}} = \frac{1}{f_1} \quad (47)_p$$

$$\frac{v}{u} = m \sqrt{\frac{V_2}{V_1}} \quad (48)_p$$

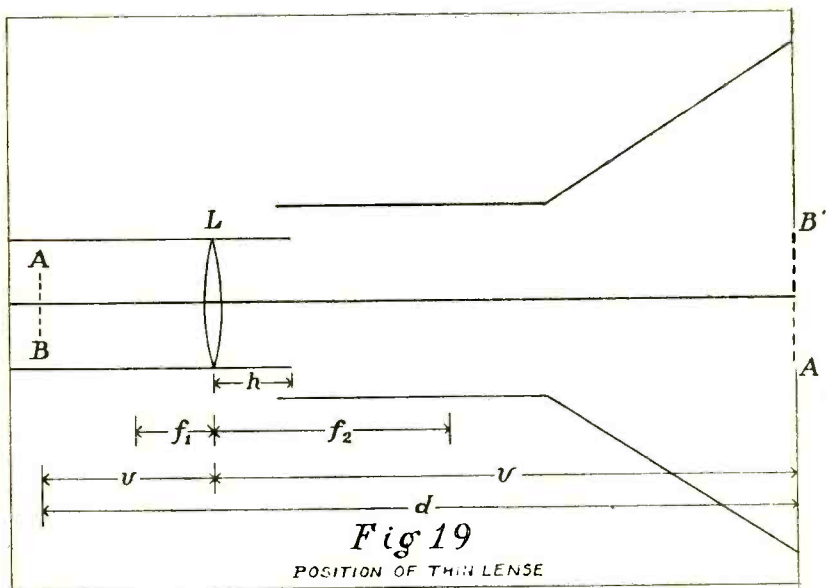

Fig. 19—Position of Thin Lens.

Besides these the following two relations also hold

$$u + v = d \quad (49)_p$$

$$\frac{f_2}{f_1} = - \sqrt{\frac{V_2}{V_1}} \quad (50)_p$$

where  $d$  is the distance between object and image.

It follows from equations (48)<sub>p</sub> and (49)<sub>p</sub> that

$$u = \frac{d}{1 + m \sqrt{\frac{V_2}{V_1}}} \quad (51)_p$$

TABLE 1

$\frac{V_2}{V_1}$	$f_2$		$f_1$		$F_2$		$F_1$	
	Experi- mental	Theo- retical	Experi- mental	Theo- retical	Experi- mental	Theo- retical	Experi- mental	Theo- retical
	4.5	4.9	5.1	-2.3	-2.4	2.9	3.2	-4.1
5.0	4.4	4.7	-2.0	-2.1	3.0	2.9	-3.7	-3.4
5.5	4.2	4.3	-1.8	-1.9	2.3	2.7	-3.3	-3.1
6.0	4.0	4.1	-1.7	-1.7	2.0	2.4	-3.0	-2.8
6.5	3.8	3.9	-1.5	-1.5	1.8	2.1	-2.7	-2.6

As  $u$  is the distance between object and lens, equation (51) $p$  permits one to determine the position of the lens. Substituting (51) $p$  and (49) $p$  into (47) $p$  there results that

$$f_1 = \frac{d}{1 + m\sqrt{\frac{V_2}{V_1}}} \frac{m}{m+1} = u \frac{m}{m+1} \quad (52)p$$

Equation (52) $p$  determines the first focal length; it is seen from equation (52) $p$  that for large magnifications

$$f_1 \cong u \quad (53)p$$

The second focal length is determined by equation (50) $p$ .

It is thus seen that to obtain the position of the thin lens and the two focal lengths  $f_1$  and  $f_2$  it is merely necessary to know (1)  $d$ , the distance between the object (mesh) and the image (screen), (2)  $m$ , the magnification of the object, and (3)  $V_2/V_1$  the voltage ratio required to focus the mesh on the screen.

Using the data of Fig. 15, the position and focal lengths of the thin lens were calculated by means of the above relations. Fig. 20 gives the position and the focal lengths as functions of the voltage ratio. Comparing Figs. 16 and 20, it is seen that the thin lens is situated between the two principal planes of the thick lens.

### DEFECTS OF ELECTRON FOCUSING SYSTEM

The defects may be roughly classified as:

- (1) Those associated with construction
- (2) Those associated with aberrations
- (3) Those associated with space charge or mutual repulsion between the electrons in the beam.

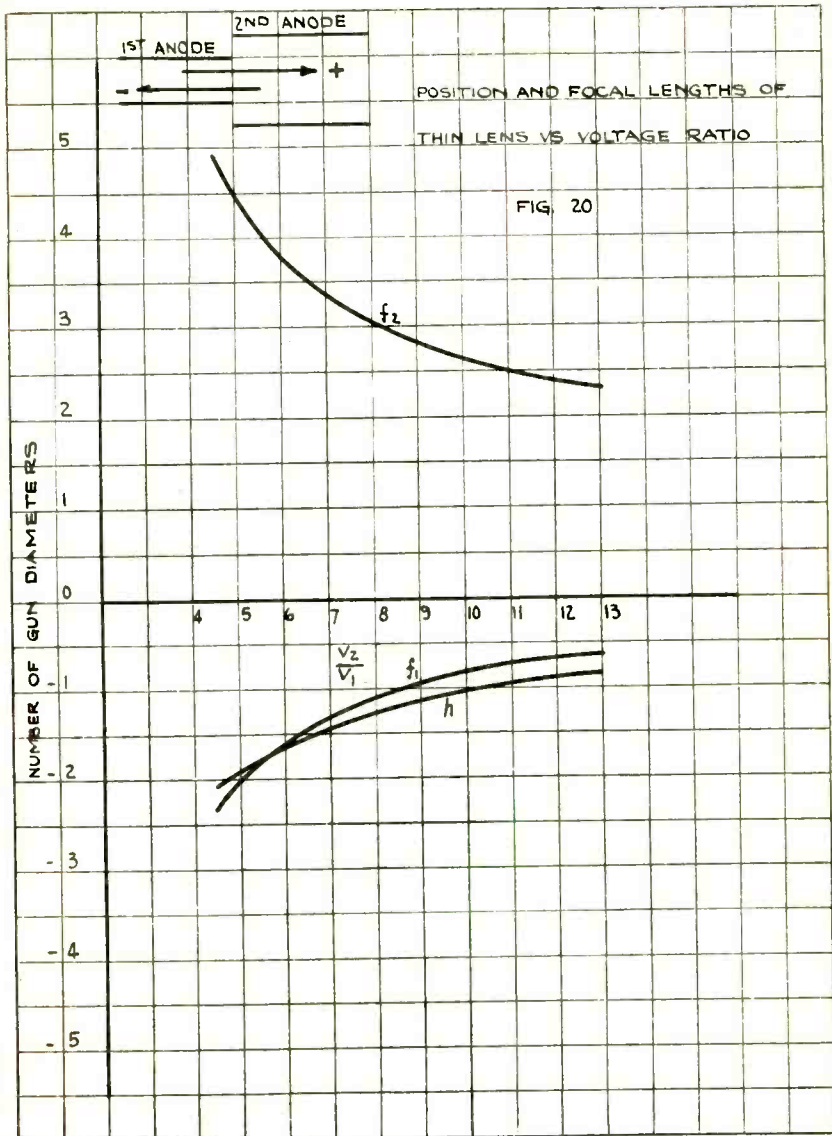

Fig. 20—Position and Focal Lengths of Thin Lens vs. Voltage Ratio.

The defects of the first class may be caused by

- (a) The two focusing cylinders not being coaxial
- (b) Cylinders being out of round
- (c) Cylinders and apertures not being coaxial, etc.

These defects may all be overcome by a more careful construc-

tion of the tube. In what follows it will be assumed that the tube is well constructed.

The defects due to space charge will not be discussed in this paper.

#### ABERRATION

In optics it is customary to speak of first, third, fifth, etc. order of imagery. Paraxial imagery being synonymous with first order imagery. Third order imagery is usually considered as first order imagery upon which are superimposed third order monochromatic aberrations. Similarly, with the fifth and higher orders of imagery. The number and complexity increase rather rapidly with the order of imagery, so that the usual treatment of the aberrations limits itself to the aberrations of the third order.

There are five monochromatic aberrations due to third order imagery. These are

- (1) Spherical aberration
- (2) Coma
- (3) Astigmatism
- (4) Curvature of the field
- (5) Distortion

Besides these monochromatic there are two chromatic aberrations. For these it is usual to assume paraxial imagery and to deduce the aberrations from the variation of the indices of refraction with the wavelength of light.

Similarly, one may speak of first and higher orders imagery in electron optics. Thus one may speak of the various orders of imagery according to the number of terms that one uses in the expansion for the potential [equation (11)]. For first order imagery (paraxial) only the first term was used, assuming that the radial force on an electron [equation (13) $p$ ] is proportional to its distance from the axis. For third order imagery the second term would be included, etc.

A first order or paraxial discussion of a focusing system is an approximate description of the imagery which is very useful for most purposes, but is not sufficiently complete to serve as a basis for the final design of a cathode ray tube. The assumptions underlying paraxial imagery are true only if the aperture of the lens and the size of the object are very small. To obtain the necessary current in the beam it is necessary to have quite a large aperture. Therefore, the imagery actually existing in

cathode ray tubes departs from paraxial. For a final design it is therefore necessary to know the aberrations of the focusing field.

The task of theoretically determining any of the monochromatic aberrations for a particular case is extremely difficult and of little use. The only practical method available for determining the aberrations in any particular case is the experimental. The chromatic aberrations are negligible in cathode ray tubes.

Of the five monochromatic aberrations enumerated above, it

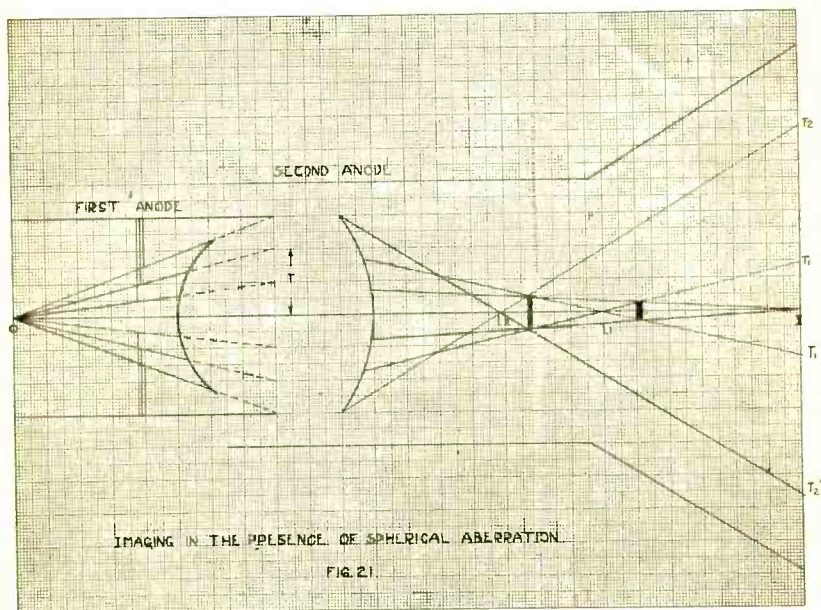

Fig. 21—Imaging in the Presence of Spherical Aberration.

is only the first three that affect the definition of the image points; the last two affect only the position of the image point. The size of the object of the final focusing field of a well designed cathode ray tube is about  $.1mm$ . If the gun is well lined up one may consider the small object to lie wholly on the axis. In this case, the electrostatic lens focusing the very small object will display spherical aberration only. If the gun is not well lined up, then the small object will lie off the axis and the lens will also display coma and astigmatism. Coma and astigmatism may be present even though no spherical aberration is present.

## SPHERICAL ABERRATION

In the case of a well designed and well constructed cathode ray tube, the only aberration (neglecting space charge) damaging the spot size is spherical aberration. It is, therefore, essential to determine the amount of spherical aberration present in various lenses, used in various manners. Third order imagery limits itself to small apertures. In the experimental determination of the spherical aberration, it is not necessary to limit oneself to the third order imagery.

In the presence of spherical aberration, all electrons coming from an object point on the axis do not recombine at one point on the axis—as paraxial theory predicts—but rather intersect the axis at various distances as shown in Fig. 21. In Fig. 21,  $I$  represents the paraxial image of  $O$ , and  $IL_1$ ,  $IL_2$  are defined as the longitudinal spherical aberrations and  $IT_1$ ,  $IT_2$  are defined as the transverse spherical aberration for the various apertures. The longitudinal spherical aberration is said to be positive if as in Fig. 22  $L_1$ , and  $L_2$  are to the left of  $I$  and negative if to the right of  $I$ . The transverse spherical aberration is said to be positive for electrons  $T_1$  and  $T_2$  and negative for  $T_1'$  and  $T_2'$ . The heavy vertical lines in the image space represent the disks of least confusion.

Let  $r$  be the distance between any electron and the axis at the end of the gun (see Fig. 21) and let  $L$  be the longitudinal spherical aberration for the electron of height  $r$  then

$$L = a_2 r^2 + a_4 r^4 + a_6 r^6 + \dots$$

That  $L$  is a function of only the even powers of  $r$  follows from the fact that  $L$  is the same for plus or minus  $r$ , i.e.,  $L$  is the same for an electron above or below the axis. Similarly if  $T$  represents the transverse spherical aberration then

$$T = a_1 r + a_3 r^3 + a_5 r^5 + \dots$$

since a change in the sign of  $r$  changes the sign of  $T$  only.

It is to be noted that the effect of spherical aberration is perfectly symmetrical, that is, the disks of least confusion, which represent the minima spots possible with the given amount of aberration, are perfectly symmetrical about the axis.

EXPERIMENTAL DETERMINATION OF TRANSVERSE  
SPHERICAL ABERRATION

The type of gun used in the determination of the transverse spherical aberration is shown in Fig. 22. Fig. 23(a) represents

the appearance of the spots on the screen when  $V_2 = V_1$ . If there were no spherical aberration all the spots would, on focusing, unite to form the small paraxial image spot. Fig. 23(b)

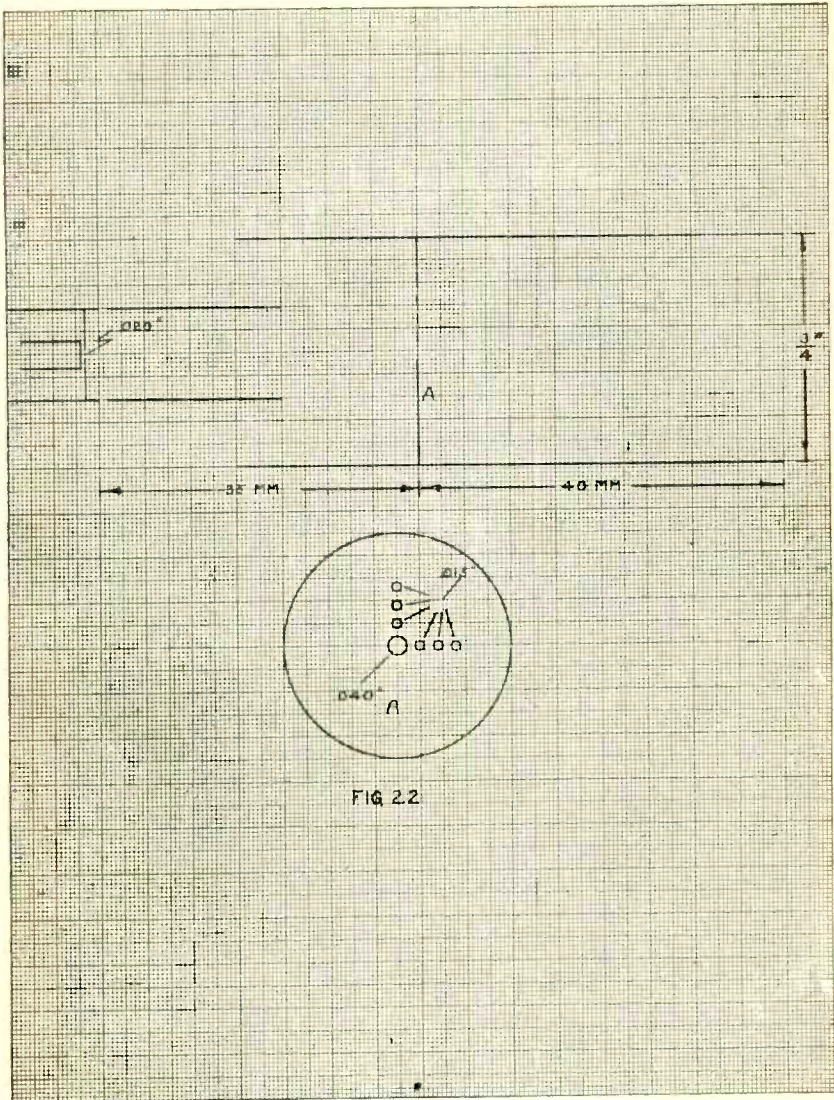

FIG. 22

Fig. 22—Gun Used for Determination of Spherical Aberration.

shows the appearance of the screen when the electrons issuing from the central .040" aperture are focused. In Fig. 23(b) it is seen that due to the spherical aberration the non-paraxial elec-

trons are already overfocused when the axial electrons (those passing through the central .040" aperture are just focused. The

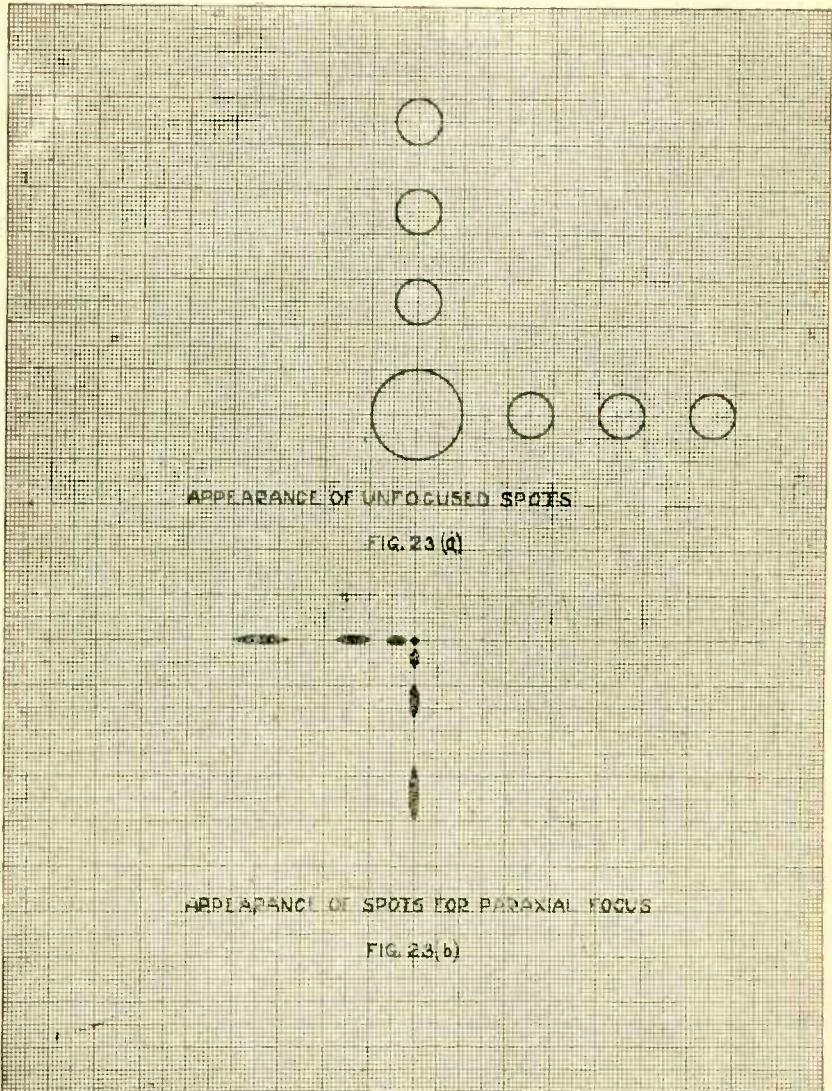

Fig. 23 (a)—Appearance of unfocused spots.

Fig. 23 (b)—Appearance of Spots for Paraxial Focus.

transverse spherical aberration is thus directly obtained from Fig. 23 (b).

Fig. 24 shows how the transverse spherical aberration for



the various image distances and diameter ratios varies with the width of the beam at the end of the gun. The curves of Fig. 24

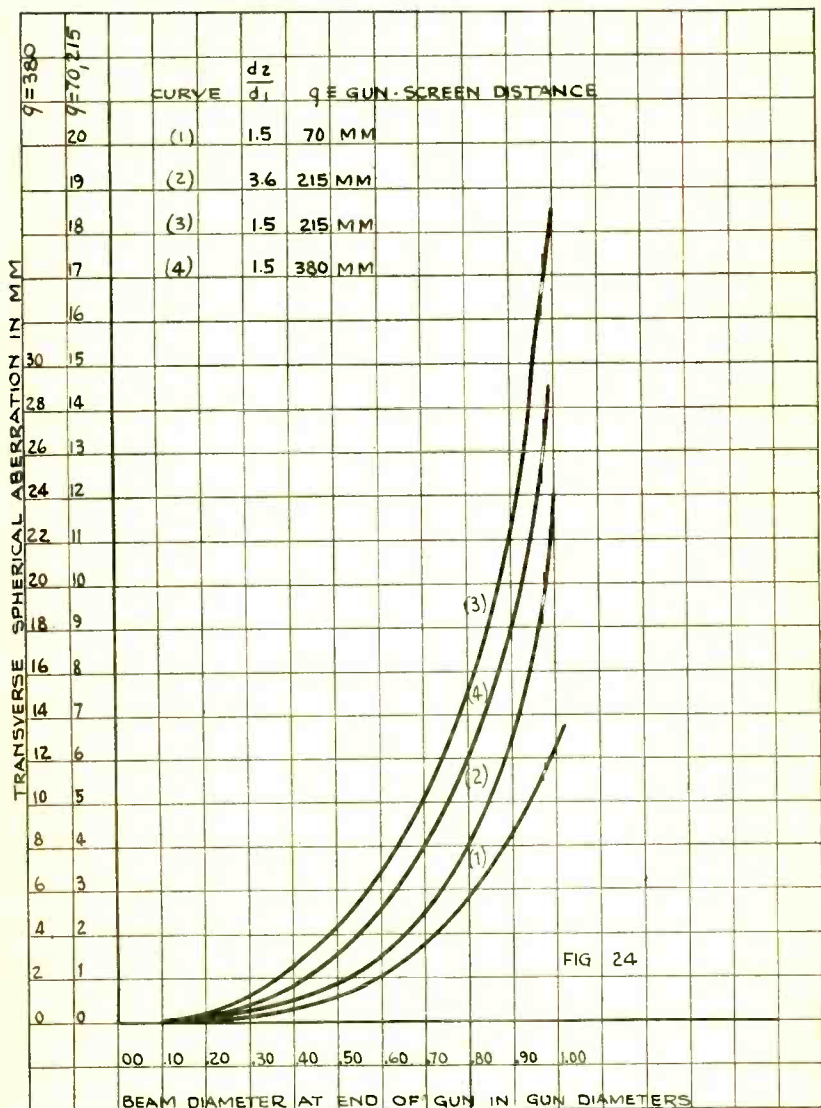

Fig. 24—Spherical Aberration vs. Beam Width.

may be fairly well represented by the first two terms of equation (2). The width of the beam at the end of the gun is obtained

from Fig. 23 (a) and from the given positions of aperture and screen.

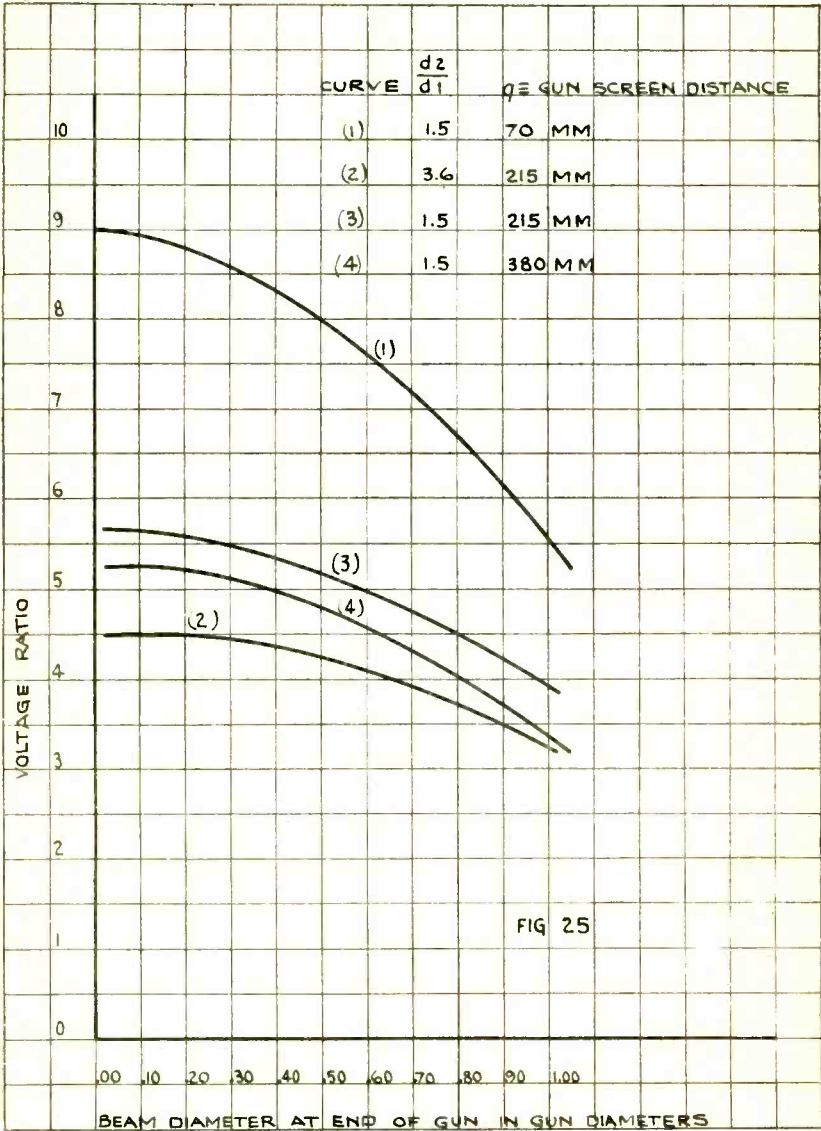

Fig. 25—Voltage Ratio vs. Beam Width.

As shown in Fig. 21 the plane containing the disk of least confusion occurs nearer the lens than that predicted by paraxial theory. If the focusing voltage ratio is set for the paraxial

image, then the disk of least confusion will occur between the end of the gun and the screen, in other words, the spot on the

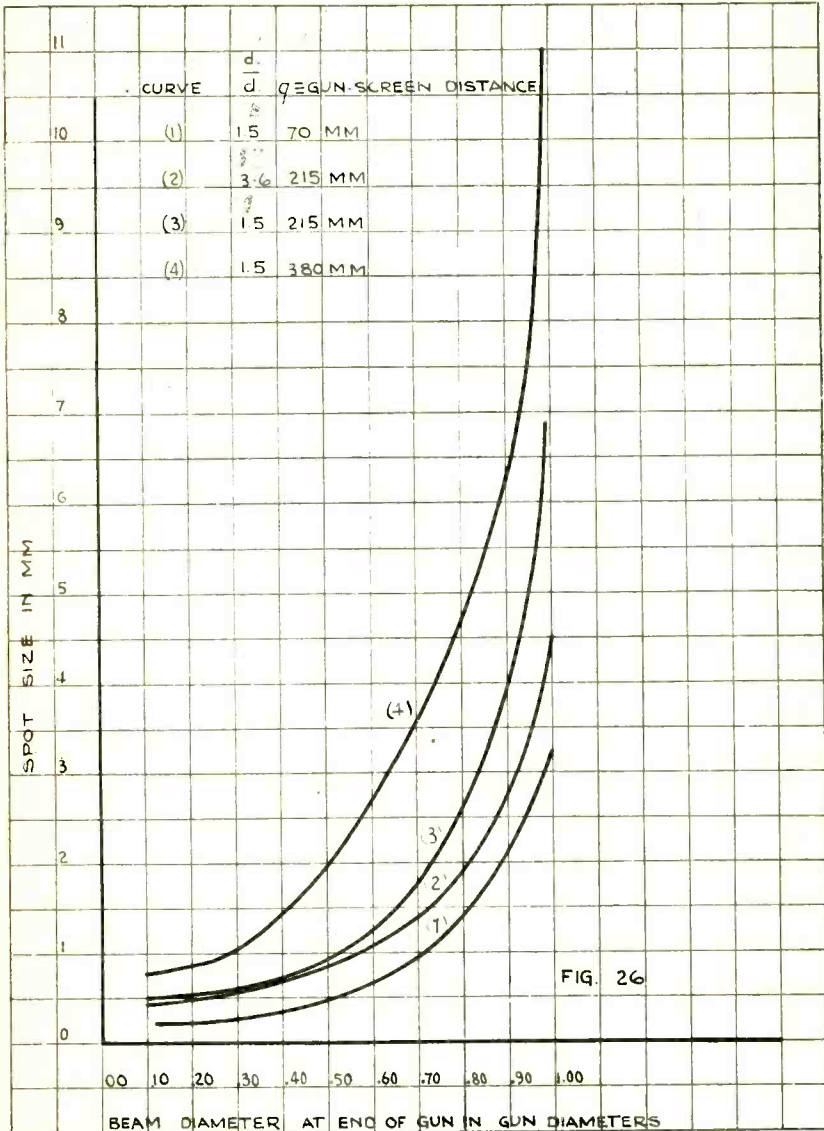

Fig. 26—Minimum Spot Size vs. Beam Width.

screen is overfocused. To focus the disk of least confusion on the screen, it will be necessary to lower the voltage ratio. Fig. 25 shows the variation of the voltage ratio required to focus the

disk of least confusion for various beam widths. The voltage ratio required to focus the disk of least confusion and the size of the disk were determined by simultaneously focusing to a minimum spot the beams passing thru the central .040" aperture and two or more of the other apertures, considering the center of the central spot (spot formed by beam thru .040" aperture) as the center of the disk of least confusion.

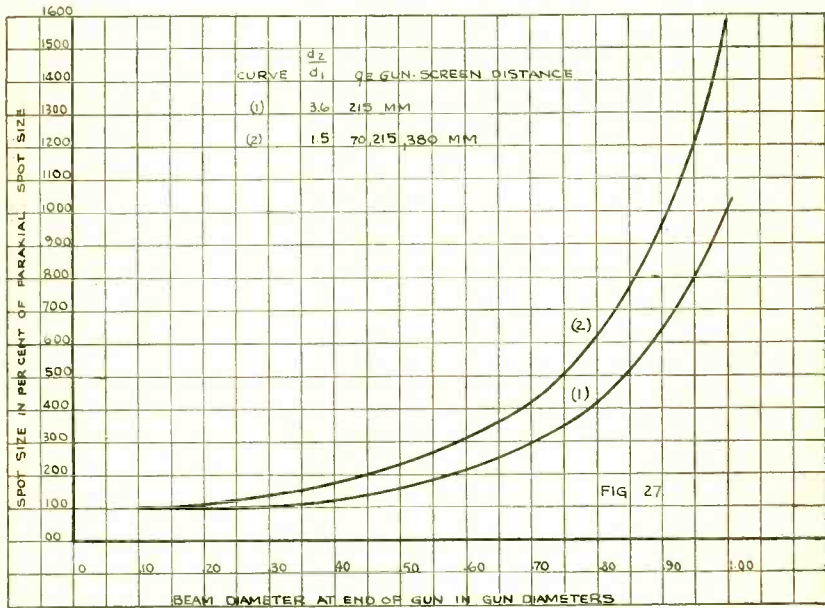

Fig. 27—Minimum Spot Size vs. Beam Width.

The size of the disk of least confusion represents the minimum spot obtainable. Fig. 26 shows the variation of the size of the disk of least confusion with the ratio of the beam diameter at the end of the gun to gun diameter.

Fig. 27 shows the same curves given in Fig. 26 plotted in terms of the paraxial image size. Fig. 27 shows the very interesting result that the disk of least confusion, measured in terms of the paraxial size of the image, is independent of the image distance, i.e. of the type of tube.





