

# RCA

PRICE FIFTY CENTS



## RECEIVING TUBE MANUAL



**RADIO CORPORATION of AMERICA**  
TUBE DEPARTMENT

HARRISON, N. J.

TECHNICAL SERIES RC 16

# CONTENTS

	PAGE
<b>ELECTRONS, ELECTRODES, AND ELECTRON TUBES</b> . . . . .	3
Electrons, Cathodes, Generic Tube Types, Diodes, Triodes, Pentodes, Beam Power Tubes, Multi-Electrode and Multi-Unit Types, Kinescopes	
<b>ELECTRON TUBE CHARACTERISTICS</b> . . . . .	11
<b>ELECTRON TUBE APPLICATIONS</b> . . . . .	13
Amplification, Rectification, Detection, Automatic Volume Control, Tuning Indication with Electron-Ray Tubes, Oscillation, Frequency Conversion, Automatic Frequency Control	
<b>ELECTRON TUBE INSTALLATION</b> . . . . .	47
Filament and Heater Supply, Heater-to-Cathode Connection, Plate Voltage Supply, Grid Voltage Supply, Screen Voltage Supply, Shielding, Dress of Circuit Leads, Filters, Output-Coupling Devices, High- Voltage Considerations for Kinescopes, Kinescope Safety Considerations	
<b>INTERPRETATION OF TUBE DATA</b> . . . . .	58
<b>RECEIVING TUBE CLASSIFICATION CHART</b> . . . . .	62
<b>TUBE TYPES—Technical Data</b> . . . . .	65
<b>ELECTRON TUBE TESTING</b> . . . . .	242
<b>RESISTANCE-COUPLED AMPLIFIERS</b> . . . . .	246
<b>CIRCUITS</b> . . . . .	263
<b>OUTLINES</b> . . . . .	284
<b>INDEX</b> . . . . .	301
<b>RECENTLY ADDED TUBE TYPES</b> . . . . .	305
<b>READING LIST</b> . . . . .	320

## Key to Socket Connection Diagrams

### *Bottom Views*

BC = Base Sleeve	G = Grid	K = Cathode
BS = Base Shell	H = Heater	NC = No. Connection
C = External Conductive Coating	HL = Heater Tap for Panel Lamp	P = Plate (Anode)
DJ = Deflecting Electrode	HM = Heater Mid-Tap	RC = Ray-Control Electrode
ES = External Shield	IC = Internal Connection—Do Not Use	S = Shell
F = Filament	IS = Internal Shield	TA = Target
FM = Filament Mid-Tap		U = Unit
		● = Gas-Type Tube

*Alphabetical Subscripts B,D,HP,HX,P, and T indicate, respectively, beam unit, diode unit, heptode unit, hexode unit, pentode unit, and triode unit in multi-unit types.*

# RCA Receiving Tube MANUAL

THIS MANUAL like its preceding editions has been prepared to assist those who work or experiment with electron tubes and circuits. It will be found valuable by engineers, radio servicemen, technicians, experimenters, students, radio amateurs, and all others technically interested in electron tubes.

The material in this edition has been augmented and revised to keep abreast of the technological advances in electronic fields. Many tube types widely used in the design of new electronic equipment prior to the war are now chiefly of renewal interest; in their place, new advanced types including the miniatures are being used. Consequently, in the Tube Types Section, the presentation on the older types has been limited to essential basic data while detailed information has been given on the newer more important types.

---

In addition to the tube types covered in this Manual, the TUBE DEPARTMENT of RADIO CORPORATION OF AMERICA offers a complete line of electron tubes including:

## **CATHODE-RAY TUBES**

*Special-Purpose  
Kinescopes and  
Oscillograph Types*

## **TELEVISION CAMERA TUBES**

*Iconoscopes, Monoscopes,  
and Image Orthicons*

## **PHOTOTUBES**

*Single-Unit, Twin-Unit,  
and Multiplier Types*

## **POWER TUBES**

*Transmitting and  
Industrial Types*

## **THYRATRONS & IGNITRONS**

## **SPECIAL TYPES**

*Acorn Types, Lighthouse  
Types, Pencil Types,  
Vacuum-Gauge Tubes,  
and Specialized-  
Application Types*

---

For Sales Information  
on RCA Tubes, write to  
*Sales Division*

For Technical Information  
on RCA Tubes, write to  
*Commercial Engineering*

TUBE DEPARTMENT  
RADIO CORPORATION OF AMERICA  
Harrison, N. J.

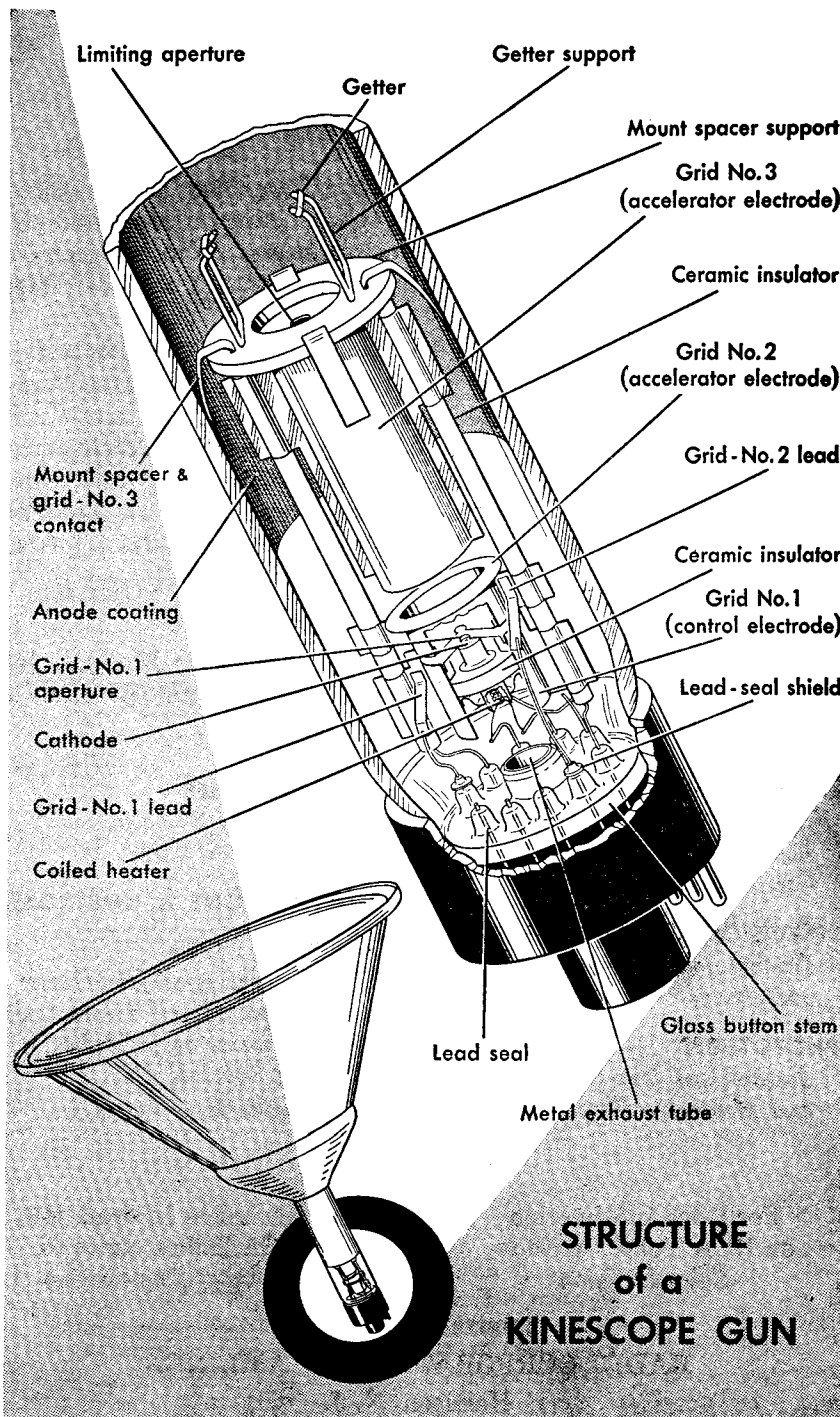

Limiting aperture

Getter support

Getter

Mount spacer support

Grid No. 3  
(accelerator electrode)

Ceramic insulator

Grid No. 2  
(accelerator electrode)

Grid - No. 2 lead

Ceramic insulator

Grid No. 1  
(control electrode)

Lead - seal shield

Glass button stem

Mount spacer &  
grid - No. 3  
contact

Anode coating

Grid - No. 1  
aperture

Cathode

Grid - No. 1 lead

Coiled heater

Lead seal

Metal exhaust tube

**STRUCTURE  
of a  
KINESCOPE GUN**

# RCA Receiving Tube MANUAL

## Electrons, Electrodes, and Electron Tubes

The electron tube is a marvelous device. It makes possible the performing of operations, amazing in conception, with a precision and a certainty that are astounding. It is an exceedingly sensitive and accurate instrument—the product of coordinated efforts of engineers and craftsmen. Its construction requires materials from every corner of the earth. Its use is world-wide. Its future possibilities, even in the light of present-day accomplishments, are but dimly foreseen; for each development opens new fields of design and application.

The importance of the electron tube lies in its ability to control almost instantly the flight of the millions of electrons supplied by the cathode. It accomplishes this with a minimum of control energy. Because it is almost instantaneous in its action, the electron tube can operate efficiently and accurately at electrical frequencies much higher than those attainable with rotating machines.

### ELECTRONS

All matter exists in the solid, liquid, or gaseous state. These three forms consist entirely of minute divisions known as molecules. Molecules are assumed to be composed of atoms. According to a present accepted theory, atoms have a nucleus which is a positive charge of electricity. Around this nucleus revolve tiny charges of negative electricity known as **electrons**. Scientists have estimated that these invisible bits of electricity weigh only 1/30-billion, billion, billion, billionths of an ounce, and that they may travel at speeds of thousands of miles per second.

Electron movement may be accelerated by the addition of energy. Heat is one form of energy which can be conveniently used to speed up the electron. For example, if the temperature of a metal is gradually raised, the electrons in the metal gain velocity. When the metal becomes hot enough to glow, some electrons may acquire sufficient speed to break away from the surface of the metal. This action, which is accelerated when the metal is heated in a vacuum, is utilized in most electron tubes to produce the necessary electron supply.

An electron tube consists of a cathode, which supplies electrons, and one or more additional electrodes, which control and collect these electrons, mounted in an evacuated envelope. The envelope may be a glass bulb or a metal shell.

### CATHODES

A cathode is an essential part of an electron tube because it supplies the electrons necessary for tube operation. When energy in some form is applied to the cathode, electrons are released. Heat is the form of energy generally used. The method of heating the cathode may be used to distinguish between the different forms of cathodes. For example, a directly heated cathode, or filament-cathode, is a wire heated by the passage of an electric current. An indirectly heated cathode, or heater-cathode, consists of a filament, or heater, enclosed in a metal sleeve. The sleeve carries the electron-emitting material on its outside surface and is heated by radiation and conduction from the heater.

A filament, or directly heated cathode, may be further classified by identifying the filament or electron-emitting material. The materials in regular use are tungsten, thoriated tungsten, and metals which have been coated with alkaline-earth oxides. Tungsten filaments are made from the pure metal. Since they must operate at high temperatures (a dazzling white) to emit sufficient electrons, a relatively large amount of filament power is required. Thoriated-tungsten filaments are made from tungsten impregnated with thoria. Due to the presence of thorium, these filaments liberate electrons at a more moderate temperature of about 1700°C (a bright yellow) and are, therefore, much more economical of filament power than are pure tungsten filaments. Alkaline earths are usually applied as a coating on a nickel-alloy wire or ribbon. This coating, which is dried in a relatively thick layer on the filament, requires only a very low temperature of about 700-750°C (a dull red) to produce a copious supply of electrons. Coated filaments operate very efficiently and require relatively little filament power. However, each of these cathode materials has special advantages which determine the choice for a particular application.

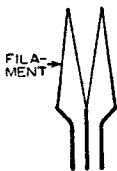

Fig. 1

Directly heated filament-cathodes require comparatively little heating power. They are used in almost all of the tube types designed for battery operation because it is, of course, desirable to impose as small a drain as possible on the batteries. Examples of battery-operated filament types are the 1A7-GT, 1R5, 1U4, 3V4, and 31. AC-operated types having directly heated filament-cathodes include the 2A3 and 5Y3-GT.

An indirectly heated cathode, or heater-cathode, consists of a thin metal sleeve coated with electron-emitting material. Within the sleeve is a heater which is insulated from the sleeve. The heater is made of tungsten or tungsten-alloy wire and is used only for the purpose of heating the cathode sleeve and sleeve coating to an electron-emitting temperature. Useful emission does not take place from the heater wire.

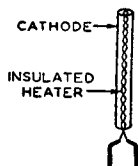

Fig. 2

The heater-cathode construction is well adapted for use in electron tubes intended for operation from ac power lines and from storage batteries. The use of separate parts for emitter and heater functions, the electrical insulation of the heater from the emitter, and the shielding effect of the sleeve may all be utilized in the design of the tube to minimize the introduction of hum from the ac heater supply and to minimize electrical interference which might enter the tube circuit through the heater-supply line. From the viewpoint of circuit design, the heater-cathode construction offers advantages in connection flexibility due to the electrical separation of the heater from the cathode. Another advantage of the heater-cathode construction is that it makes practical the design of a rectifier tube with close spacing between its cathode and plate, and of an amplifier tube with close spacing between its cathode and grid. In a close-spaced rectifier tube the voltage drop in the tube is low and the regulation is, therefore, improved. In an amplifier tube, the close spacing increases the gain obtainable from the tube. Because of the advantages of the heater-cathode construction, almost all present-day receiving tubes designed for ac operation have heater-cathodes.

## GENERIC TUBE TYPES

Electrons are of no value in an electron tube unless they can be put to work. A tube is, therefore, designed with the parts necessary to utilize electrons as well as to produce them. These parts consist of a cathode and one or more supplementary electrodes. The electrodes are enclosed in an evacuated envelope with the necessary connections brought out through air-tight seals. The air is removed from the envelope to allow free movement of the electrons and to prevent injury to the emitting surface of the cathode. When the cathode is heated, electrons leave

the cathode surface and form an invisible cloud in the space around it. Any positive electric potential within the evacuated envelope will offer a strong attraction to the electrons (unlike electric charges attract; like charges repel).

## DIODES

The simplest form of electron tube contains two electrodes, a cathode and an anode (plate) and is often called a diode, the family name for a two-electrode tube. In a diode, the positive potential is supplied between the plate terminal and a cathode terminal. Under the influence of the positive plate potential, electrons flow from the cathode to the plate and return through the external plate-battery circuit to the cathode, thus completing the circuit. This flow of electrons is known as the plate current, and may be measured by a sensitive current meter.

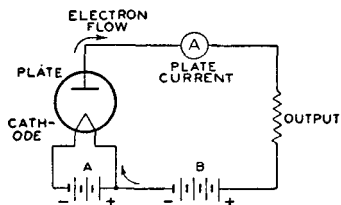

Fig. 3

If a negative potential is applied to the plate, the free electrons in the space surrounding the cathode will be forced back to the cathode and no plate current will flow. Thus, electrons can flow from the cathode to the plate but not from the plate to the cathode. If an alternating voltage is applied to the plate, the plate is alternately made positive and negative. Plate current flows only during the time when the plate is positive. Hence the current through the tube flows in one direction and is said to be rectified. See Fig. 4. Diode rectifiers are used in ac receivers to convert ac to dc voltage for the electrodes of the other tubes in the receiver. Rectifier tubes may have one plate and one cathode. The 1-v and 35W4 are of this form and are called **half-wave rectifiers**, since current can flow only during one-half of the alternating-current cycle. When two plates and one or more cathodes are used in the same tube, current may be obtained on both halves of the ac cycle. The 6X4, 5Y3-GT, and 5U4-G are examples of this type and are called **full-wave rectifiers**.

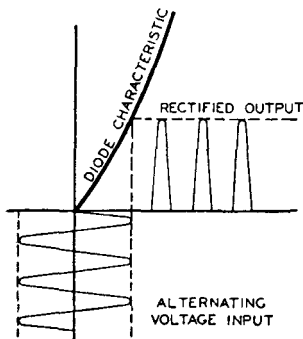

Fig. 4

Not all of the electrons emitted by the cathode reach the plate. Some return to the cathode while others remain in the space between the cathode and plate for a brief period to produce an effect known as **space-charge**. This charge has a repelling action on other electrons which leave the cathode surface and impedes their passage to the plate. The extent of this action and the amount of space-charge depend on the cathode temperature and the plate potential. The higher the plate potential, the less is the tendency for electrons to remain in the space-charge region and repel others. This effect may be noted by applying increasingly higher plate voltages to a tube operating at a fixed heater or filament voltage. Under these conditions, the maximum number of available electrons is fixed, but increasingly higher plate voltages will succeed in attracting a greater proportion of the free electrons.

Beyond a certain plate voltage, however, additional plate voltage has little effect in increasing the plate current. The reason is that all of the electrons emitted by the cathode are already being drawn to the plate. This maximum current is called **saturation current** (see Fig. 5) and because it is an indication of the total number of electrons emitted, it is also known as the **emission current**, or, simply,

**emission.** Tubes are sometimes tested by the measurement of their emission current but it is generally not advisable to measure the full value of emission because this value would be sufficiently large to cause change in the tube's characteristics or even to damage the tube. Consequently, while the test value of emission current is somewhat larger than the maximum current which will be required from the cathode in the use of the tube, it is ordinarily less than the full emission current. The emission test, therefore, is used to indicate whether the cathode can supply a sufficient number of electrons for satisfactory operation of the tube.

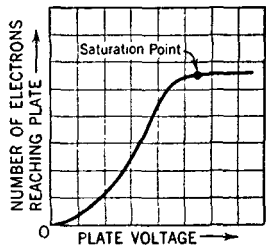

Fig. 5

If space charge were not present to repel electrons coming from the cathode, it follows that the same plate current could be produced at a lower plate voltage. One way to make the effect of space charge small is to make the distance between plate and cathode small. This method is used in rectifier types, such as the 5V4-G and the 25Z6-GT, having heater-cathodes. In these types the radial distance between cathode and plate is only about two hundredths of an inch. Another method of reducing space-charge effect is utilized in the mercury-vapor rectifier tubes, such as the 83. This tube contains a small amount of mercury, which is partially vaporized when the tube is operated. The mercury vapor consists of mercury atoms permeating the space inside the bulb. These atoms are bombarded by the electrons on their way to the plate. If the electrons are moving at a sufficiently high speed, the collisions will tear off electrons from the mercury atoms. When this happens, the mercury atom is said to be "ionized," that is, it has lost one or more electrons and, therefore, is charged positive. Ionization, in the case of mercury vapor, is made evident by a bluish-green glow between the cathode and plate. When ionization due to bombardment of mercury atoms by electrons leaving the cathode occurs, the space-charge is neutralized by the positive mercury ions so that increased numbers of electrons are made available. A mercury-vapor rectifier has a small voltage drop between cathode and plate (about 15 volts). This drop is practically independent of current requirements up to the limit of emission of electrons from the cathode, but is dependent to some degree on bulb temperature.

An ionic-heated-cathode rectifier tube is another type which depends for its operation on gas ionization. The 0Z4 and 0Z4-G are tubes in this classification. They are of the full-wave design and contain two anodes and a coated cathode sealed in a bulb under a reduced pressure of inert gas. The cathode in each of these types becomes hot during tube operation but the heating effect is caused by bombardment of the cathode by the ions from within the tube rather than by heater or filament current from an external source. The internal structure of the tube is designed so that when sufficient voltage is applied to the tube, ionization of the gas occurs between the anode which is instantaneously positive and the cathode. Under normal operating voltages, ionization does not take place between the anode that is negative and the cathode. This, of course, satisfies the requirements for rectification. The initial small flow of current through the tube is sufficient to raise the cathode temperature quickly to incandescence whereupon the cathode emits electrons. The voltage drop in such tubes is slightly higher than that of the usual hot-cathode gas rectifiers because energy is taken from the ionization discharge to keep the cathode at operating temperature. Proper operation of these rectifiers requires a minimum flow of load current at all times in order to maintain the cathode at the temperature required to supply sufficient emission.

## TRIODES

When a third electrode, called the grid, is placed between the cathode and plate, the tube is known as a triode, the family name for a three-electrode tube.



The grid usually is a winding of wire extending the length of the cathode. The spaces between turns are comparatively large so that the passage of electrons from cathode to plate is practically unobstructed by the turns of the grid. The purpose of the grid is to control the flow of plate current. When a tube is used as an amplifier, a negative dc voltage is usually applied to the grid. Under this condition the grid does not draw appreciable current.

The number of electrons attracted to the plate depends on the combined effect of the grid and plate polarities. When the plate is positive, as is normal, and the dc grid voltage is made more and more negative, the plate is less able to attract electrons to it and plate current decreases. When the grid is made less and less negative (more and more positive), the plate more readily attracts electrons to it and plate current increases. Hence, when the voltage on the grid is varied in accordance with a signal, the plate current varies with the signal. Because a small voltage applied to the grid can control a comparatively large amount of plate current, the signal is amplified by the tube. Typical three-electrode tube types are the 6C4, 6J5, and 2A3.

The grid, plate, and cathode of a triode form an electrostatic system, each electrode acting as one plate of a small capacitor. The capacitances are those existing between grid and plate, plate and cathode, and grid and cathode. These capacitances are known as **interelectrode capacitances**. Generally, the capacitance between grid and plate is of the most importance. In high-gain radio-frequency amplifier circuits, this capacitance may act to produce undesired coupling between the **input circuit**, the circuit between grid and cathode, and the **output circuit**, the circuit between plate and cathode. This coupling is undesirable in an amplifier because it may cause instability and unsatisfactory performance.

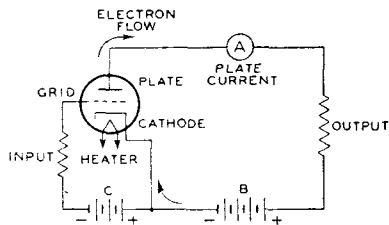

Fig. 6

## TETRODES

The capacitance between grid and plate can be made small by mounting an additional electrode, called the screen (grid No. 2), in the tube. With the addition of the screen, the tube has four electrodes and is, accordingly, called a tetrode. The screen is mounted between the grid and the plate and acts as an electrostatic shield between them, thus reducing the grid-to-plate capacitance. The effectiveness of this shielding action is increased by connecting a bypass capacitor between screen and cathode. By means of the screen and this bypass capacitor, the grid-plate capacitance of a tetrode is made very small. In practice, the grid-plate capacitance is reduced from several micromicrofarads ( $\mu\mu\text{f}$ ) for a triode to 0.01  $\mu\mu\text{f}$  or less for a screen-grid tube.

The screen has another desirable effect in that it makes plate current practically independent of plate voltage over a certain range. The screen is operated at a positive voltage and, therefore, attracts electrons from the cathode. But because of the comparatively large space between wires of the screen, most of the electrons drawn to the screen pass through it to the plate. Hence the screen supplies an electrostatic force pulling electrons from the cathode to the plate. At the same

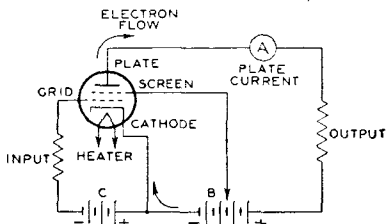

Fig. 7

time the screen shields the electrons between cathode and screen from the plate so that the plate exerts very little electrostatic force on electrons near the cathode. So long as the plate voltage is higher than the screen voltage, plate current in a screen-grid tube depends to a great degree on the screen voltage and very little on the plate voltage. The fact that plate current in a screen-grid tube is largely independent of plate voltage makes it possible to obtain much higher amplification with a tetrode than with a triode. The low grid-plate capacitance makes it possible to obtain this high amplification without plate-to-grid feedback and resultant instability. Representative screen-grid types are the 32 and 24-A.

## PENTODES

In all electron tubes, electrons striking the plate may, if moving at sufficient speed, dislodge other electrons. In two- and three-electrode types, these dislodged electrons usually do not cause trouble because no positive electrode other than the plate itself is present to attract them. These electrons, therefore, are drawn back to the plate. Emission caused by bombardment of an electrode by electrons from the cathode is called **secondary emission** because the effect is secondary to the original cathode emission. In the case of screen-grid tubes, the proximity of the positive screen to the plate offers a strong attraction to these secondary electrons and particularly so if the plate voltage swings lower than the screen voltage. This effect lowers the plate current and limits the permissible plate-voltage swing for tetrodes.

The plate-current limitation is removed when a fifth electrode is placed within the tube between the screen and plate. This fifth electrode is known as the **suppressor** (grid No. 3) and is usually connected to the cathode. Because of its nega-

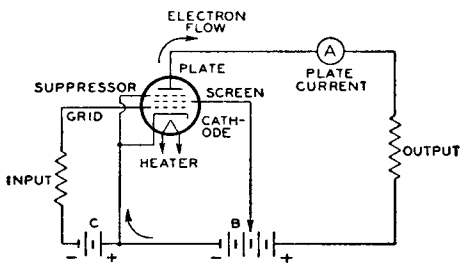

Fig. 8

tive potential with respect to the plate, the suppressor retards the flight of secondary electrons and diverts them back to the plate where they cannot cause trouble. The family name for a five-electrode tube is "pentode". In power-output pentodes, the suppressor makes possible higher power output with lower grid-driving voltage; in radio-frequency amplifier pentodes the suppressor makes possible high voltage amplification at moderate values of plate voltage. These desirable features are due to the fact that the plate-voltage swing can be made very large. In fact, the plate voltage may be as low as, or lower than, the screen voltage without serious loss in signal-gain capability. Representative pentodes used for power amplification are the 3V4 and 6K6-GT; representative pentodes used for voltage amplification are the 1U4, 6SJ7, 12SK7, and 6BA6.

## BEAM POWER TUBES

A **beam power tube** is a tetrode or pentode in which directed electron beams are used to increase substantially the power-handling capability of the tube. Such a tube contains a cathode, a control-grid, a screen, a plate, and, optionally, a sup-

pressor grid. When a beam power tube is designed without an actual suppressor, the electrodes are so spaced that secondary emission from the plate is suppressed by space-charge effects between screen and plate. The space charge is produced by the slowing up of electrons traveling from a high-potential screen to a lower-potential plate. In this low-velocity region, the space charge produced is sufficient to repel secondary electrons emitted from the plate and to cause them to return to the plate. Beam power tubes of this design employ beam-confining electrodes at cathode potential to assist in producing the desired beam effects and to prevent stray electrons from the plate from returning to the screen outside of the beam. A feature of a beam power tube is its low screen current. The screen and the grid are spiral wires wound so that each turn of the screen is shaded from the cathode by a grid turn. This alignment of the screen and grid causes the electrons to travel in sheets between the turns of the screen so that very few of them strike the screen. Because of the effective suppressor action provided by space charge and because of the low current drawn by the screen, the beam power tube has the advantages of high power output, high power sensitivity, and high efficiency.

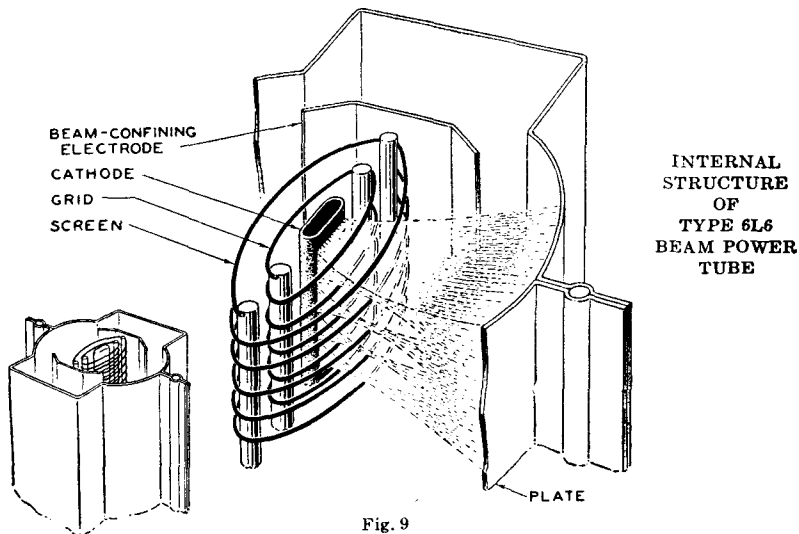

Fig. 9

Fig. 9 shows the structure of a beam power tube employing space-charge suppression and illustrates how the electrons are confined to beams. The beam condition illustrated is that for a plate potential less than the screen potential. The high-density space-charge region is indicated by the heavily dashed lines in the beam. Note that the edges of the beam-confining electrodes coincide with the dashed portion of the beam. In this way the space-charge potential region is extended beyond the beam boundaries and stray secondary electrons are prevented from returning to the screen outside of the beam. The space-charge effect may also be obtained by use of an actual suppressor grid. Examples of beam power tubes are 6L6, 6V6-GT, and 50C5.

## MULTI-ELECTRODE and MULTI-UNIT TUBES

Early in the history of tube development and application, tubes were designed for general service; that is, a single tube type—a triode—was used as a radio-frequency amplifier, an intermediate-frequency amplifier, an audio-frequency amplifier, an oscillator, or a detector. Obviously, with this diversity of application, one tube did not meet all requirements to the best advantage.

Later and present trends of tube design are the development of "specialty" types. These types are intended either to give optimum performance in a particular application or to combine in one bulb functions which formerly required two or more tubes. The first class of tubes includes such examples of specialty types as the 6F6, 12SK7, 6L7, and 6K8. Types of this class generally require more than three electrodes to obtain the desired special characteristics and may be broadly classed as multi-electrode types. The 6L7 is an especially interesting type in this class. This tube has an unusually large number of electrodes, namely seven, exclusive of the heater. Plate current in the tube is varied at two different frequencies at the same time. The tube is designed primarily for use as a mixer in superheterodyne receivers. In this use, the tube mixes the signal frequency with the oscillator frequency to give an intermediate-frequency output.

Tubes of the multi-electrode class often present interesting possibilities of application besides the one for which they are primarily designed. The 6L7, for instance, can also be used as a variable-gain audio amplifier in volume-expander and compressor application. The 6F6, besides its use as a power-output pentode, can also be connected as a triode and used as a driver for a pair of 6L6's.

The second class includes multi-unit tubes such as the twin-diode triodes 6BF6 and 6SQ7, as well as the twin-diode pentodes 1F7-G and 12C8 and the twin class A and class B types 12AU7 and 6N7, respectively. In this class also is included the multi-unit type 117N7-GT. This tube combines in one bulb a diode for use as a power rectifier and a power-output pentode. Related to multi-unit tubes are the electron-ray types 6U5, 6E5, and 6AB5/6N5. These combine a triode amplifier with a fluorescent target. Full-wave rectifiers are also multi-unit types.

A third class of tubes combines features of each of the other two classes. Typical of this third class are the pentagrid-converter types 1R5, 6BE6, and 6SA7. These tubes are similar to the multi-electrode types in that they have seven electrodes, all of which affect the electron stream; and they are similar to the multi-unit tubes in that they perform simultaneously the double function of oscillator and mixer in superheterodyne receivers.

### KINESCOPES

The kinescope is a multi-electrode tube used principally in television receivers for picture display. It consists essentially of an electron gun, a glass or metal-and-glass envelope and face-plate combination, and a fluorescent screen.

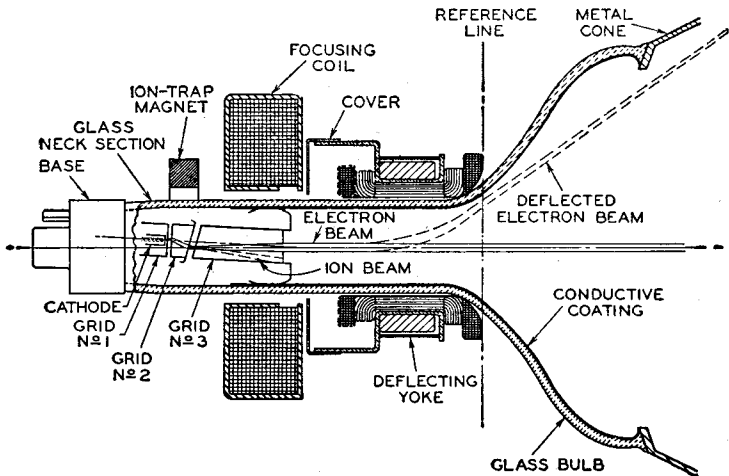

Fig. 10

The electron gun includes a cathode for the production of free electrons, an electron "lens" system for accelerating the electrons and forming or focusing them into a very narrow beam, and, optionally, a device for "trapping" unwanted ions out of the electron beam.

Deflection of the beam is accomplished either electrostatically by means of deflecting electrodes within the envelope of the tube, or electromagnetically by means of a deflecting yoke placed on the neck of the tube. Fig. 10 shows the structure of the gun section of a kinescope and illustrates how the electron beam is formed, how the ions are separated from the electron beam by means of the tilted-gun and ion-trap-magnet arrangement, and how the beam is deflected by means of an electromagnetic deflecting yoke.

The screen is a white-fluorescing phosphor (No. 4) of either the silicate or the sulfide type. The spectral distribution of the energy emitted by the silicate type is shown by the curve in the TUBE TYPES SECTION under type 5TP4, and that for the sulfide type in the same section under type 12LP4-A. The persistence of the phosphorescence exhibited by either type of the phosphor No. 4 is such that its brightness does not exceed 7 per cent of the peak value in 33 milliseconds after excitation is removed.

Complete classification of tubes by services and filament or heater voltages is given on the chart at the beginning of the TUBE TYPES SECTION.

## Electron Tube Characteristics

The term "characteristics" is used to identify the distinguishing electrical features and values of an electron tube. These values may be shown in curve form or they may be tabulated. When given in curve form, they are called characteristic curves and may be used for the determination of tube performance and the calculation of additional tube factors.

Tube characteristics are obtained from electrical measurements of a tube in various circuits under certain definite conditions of voltages. Characteristics may be further described by denoting the conditions of measurements. For example Static Characteristics are the values obtained with different dc potentials applied, to the tube electrodes, while Dynamic Characteristics are the values obtained with an ac voltage on the control grid under various conditions of dc potentials on the electrodes. The dynamic characteristics, therefore, are indicative of the performance capabilities of a tube under actual working conditions.

Static characteristics may be shown by plate characteristics curves and transfer (mutual) characteristics curves. These curves present the same information, but in two different forms to increase its usefulness. The plate characteristic curve

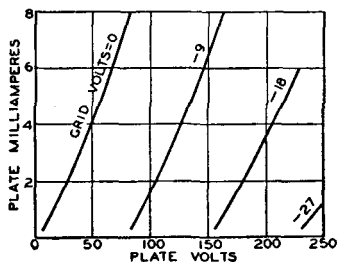

Fig. 11

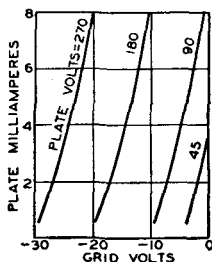

Fig. 12

is obtained by varying plate voltage and measuring plate current for different control-grid bias voltages, while the transfer-characteristic curve is obtained by varying control-grid bias voltage and measuring plate current for different plate voltages. A plate-characteristic family of curves is illustrated by Fig. 11. Fig. 12 gives the transfer characteristic family of curves for the same tube.

**Dynamic characteristics** include amplification factor, plate resistance, control-grid—plate transconductance and certain detector characteristics, and may be shown in curve form for variations in tube operating conditions.

The **amplification factor**, or  $\mu$ , is the ratio of the change in plate voltage to a change in control-electrode voltage in the opposite direction, under the condition that the plate current remains unchanged, and that all other electrode voltages are maintained constant. For example, if, when the plate voltage is made 1 volt more positive, the grid voltage must be made 0.1 volt more negative to hold plate current unchanged, the amplification factor is 1 divided by 0.1, or 10. In other words, a small voltage variation in the grid circuit of a tube has the same effect on the plate current as a large plate-voltage change—the latter equal to the product of the grid-voltage change and amplification factor. The  $\mu$  of a tube is useful for calculating stage gain. This use is discussed in the **ELECTRON TUBE APPLICATIONS SECTION**.

**Plate resistance** ( $r_p$ ) of a radio tube is the resistance of the path between cathode and plate to the flow of alternating current. It is the quotient of a small change in plate voltage divided by the corresponding change in plate current and is expressed in ohms, the unit of resistance. Thus, if a change of 0.1 milliamper (0.0001 ampere) is produced by a plate voltage variation of 1 volt, the plate resistance is 1 divided by 0.0001, or 10000 ohms.

**Control-grid—plate transconductance**, or simply **transconductance** ( $g_m$ ), is a factor which combines in one term the amplification factor and the plate resistance, and is the quotient of the first divided by the second. This term is also known as mutual conductance. Transconductance may be more strictly defined as the quotient of a small change in plate current (amperes) divided by the small change in the control-grid voltage producing it, under the condition that all other voltages remain unchanged. Thus, if a grid-voltage change of 0.5 volt causes a plate-current change of 1 milliamper (0.001 ampere), with all other voltages constant, the transconductance is 0.001 divided by 0.5, or 0.002 mho. A "mho" is the unit of conductance and was named by spelling ohm backwards. For convenience, a millionth of a mho, or a micromho ( $\mu\text{mho}$ ), is used to express transconductance. Thus, in the example, 0.002 mho is 2000 micromhos.

**Conversion transconductance** ( $g_c$ ) is a characteristic associated with the mixer (first detector) function of tubes and may be defined as the quotient of the intermediate-frequency (if) current in the primary of the if transformer divided by the applied radio-frequency (rf) voltage producing it; or more precisely, it is the limiting value of this quotient as the rf voltage and if current approach zero. When the performance of a frequency converter is determined, conversion transconductance is used in the same way as control-grid—plate transconductance is used in single-frequency amplifier computations.

The **plate efficiency** of a power amplifier tube is the ratio of the ac power output to the product of the average dc plate voltage and dc plate current at full signal, or

$$\text{Plate efficiency (\%)} = \frac{\text{power output watts}}{\text{average dc plate volts} \times \text{average dc plate amperes}} \times 100$$

The **power sensitivity** of a tube is the ratio of the power output to the square of the input signal voltage (rms) and is expressed in mhos as follows:

$$\text{Power sensitivity (mhos)} = \frac{\text{power output watts}}{(\text{input signal volts, rms})^2}$$

The **input capacitance** of an electron tube is the capacitance between the input electrode and all other electrodes, except the output electrode, connected together. When input capacitance measurements are made, it is usual practice to ground the output electrode and to connect such elements as the heater and shields together with the other electrodes.

The **output capacitance** of an electron tube is the capacitance between the output electrode and all other electrodes, except the input electrode, connected together. When output capacitance measurements are made, it is usual practice to ground the input electrode and to connect such elements as the heater and shields together with the other electrodes.

## Electron Tube Applications

The diversified applications of an electron receiving tube have, within the scope of this section, been treated under eight headings. These are: Amplification, Rectification, Detection, Automatic Volume Control, Tuning Indication with Electron-Ray Tubes, Oscillation, Frequency Conversion, and Automatic Frequency Control. Although these operations may take place at either radio or audio frequencies and may involve the use of different circuits and different supplemental parts, the general considerations of each kind of operation are basic.

### AMPLIFICATION

The amplifying action of an electron tube was mentioned under **Triodes** in the section on **ELECTRONS, ELECTRODES, and ELECTRON TUBES**.

This action can be utilized in electronic circuits in a number of ways, depending upon the results desired. Four classes of amplifier service recognized by engineers are covered by definitions standardized by the Institute of Radio Engineers. This classification depends primarily on the fraction of input cycle during which plate current is expected to flow under rated full-load conditions. The classes are class A, class AB, class B, and class C. The term, cutoff bias, used in these definitions is the value of grid bias at which plate current is some very small value.

**Class A Amplifier.** A class A amplifier is an amplifier in which the grid bias and alternating grid voltages are such that plate current in a specific tube flows at all times.

**Class AB Amplifier.** A class AB amplifier is an amplifier in which the grid bias and alternating grid voltages are such that plate current in a specific tube flows for appreciably more than half but less than the entire electrical cycle.

**Class B Amplifier.** A class B amplifier is an amplifier in which the grid bias is approximately equal to the cutoff value so that the plate current is approximately zero when no exciting grid voltage is applied, and so that plate current in a specific tube flows for approximately one-half of each cycle when an alternating grid voltage is applied.

**Class C Amplifier.** A class C amplifier is an amplifier in which the grid bias is appreciably greater than the cutoff value so that the plate current in each tube is zero when no alternating grid voltage is applied, and so that plate current flows in a specific tube for appreciably less than one-half of each cycle when an alternating grid voltage is applied.

**NOTE:**—To denote that grid current does not flow during any part of the input cycle, the suffix 1 may be added to the letter or letters of the class identification. The suffix 2 may be used to denote that grid current flows during some part of the cycle.

For radio-frequency amplifiers which operate into a selective tuned circuit, as in radio transmitter applications, or under requirements where distortion is not an

important factor, any of the above classes of amplifiers may be used, either with a single tube or a push-pull stage. For audio-frequency amplifiers in which distortion is an important factor, only class A amplifiers permit single-tube operation. In this case, operating conditions are usually chosen so that distortion is kept below the conventional 5% for triodes and the conventional 7 to 10% for tetrodes or pentodes. Distortion can be reduced below these figures by means of special circuit arrangements such as that discussed under **inverse feedback**. With class A amplifiers, reduced distortion with improved power performance can be obtained by using a push-pull stage for audio service. With class AB and class B amplifiers, a balanced amplifier stage using two tubes is required for audio service.

As a **class A voltage amplifier**, an electron tube is used to reproduce grid voltage variations across an impedance or a resistance in the plate circuit. These variations are essentially of the same form as the input signal voltage impressed on the grid, but of increased amplitude. This is accomplished by operating the tube at a suitable grid bias so that the applied grid-input voltage produces plate-current variations proportional to the signal swings. Since the voltage variation obtained in the plate circuit is much larger than that required to swing the grid, amplification of the signal is obtained. Fig. 13 gives a graphical illustration of this method of amplification and shows, by means of the grid-voltage vs. plate-current characteristics curve, the effect of an input signal (S) applied to the grid of a tube. O is the resulting amplified plate-current variation.

The plate current flowing through the load resistance (R) of Fig. 14 causes a voltage drop which varies directly with the plate current. The ratio of this voltage variation produced in the load resistance to the input signal voltage is the voltage

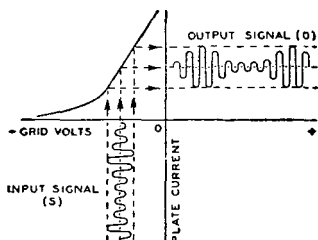

Fig. 13

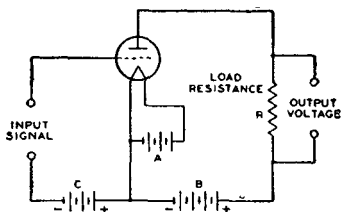

Fig. 14

amplification, or **gain**, provided by the tube. The voltage amplification due to the tube is expressed by the following convenient formulas:

$$\text{Voltage amplification} = \frac{\text{amplification factor} \times \text{load resistance}}{\text{load resistance} + \text{plate resistance}}, \text{ or}$$

$$\frac{\text{transconductance in micromhos} \times \text{plate resistance} \times \text{load resistance}}{1000000 \times (\text{plate resistance} + \text{load resistance})}$$

From the first formula, it can be seen that the gain actually obtainable from the tube is less than the tube's amplification factor but that the gain approaches the amplification factor when the load resistance is large compared to the tube's plate resistance. Fig. 15 shows graphically how the gain approaches the mu of the tube as load resistance is increased. From the curve it can be seen that to obtain high gain in a voltage amplifier, a high value of load resistance should be used.

In a **resistance-coupled amplifier**, the load resistance of the tube is approximately equal to the resistance of the plate resistor in parallel with the grid resistor of the following stage. Hence, to obtain a large value of load resistance, it is necessary to use a plate resistor and a grid resistor of large resistance. However, the plate resistor should not be too large because the flow of plate current through the plate resistor produces a voltage drop which reduces the plate voltage applied to the tube. If the plate resistor is too large, this drop will be too large, the plate voltage on the



tube will be too small, and the voltage output of the tube will be too small. Also, the grid resistor of the following stage should not be too large, the actual maximum value being dependent on the particular tube type. This precaution is necessary because all tubes contain minute amounts of residual gas which cause a minute flow of current through the grid resistor. If the grid resistor is too large, the positive bias developed by the flow of this current through the resistor decreases the normal negative bias and produces an increase in the plate current. This increased current may over-heat the tube and cause liberation of more gas which, in turn, will cause further decrease in bias. The action is cumulative and results in a runaway condition which can destroy the tube. A higher value of grid resistance is permissible when cathode bias is used than when fixed bias is used. When cathode bias is used, a loss in bias due to grid-emission effects is nearly completely offset by an increase in bias due to the voltage drop across the cathode resistor. The recommended values of plate resistor and grid resistor for the tube types used in resistance-coupled circuits, and the values of gain obtainable, are shown in the RESISTANCE-COUPLED AMPLIFIER SECTION.

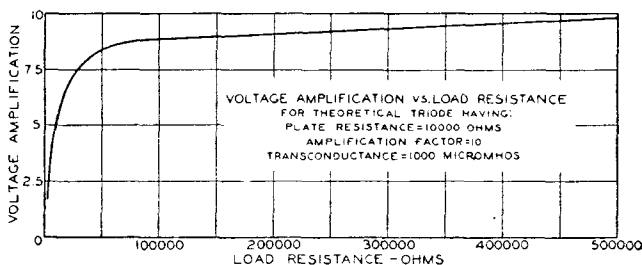

Fig. 15

The **input impedance** of an electron tube, that is, the impedance between grid and cathode is made up of (1) a reactive component due to the capacitance between grid and cathode, (2) a resistive component resulting from the time of transit of electrons between cathode and grid, and (3) a resistive component developed by the part of the cathode lead inductance which is common to both the input and output circuits. Components (2) and (3) are dependent on the frequency of the incoming signal. The input impedance is very high at audio frequencies when a tube is operated with its grid biased negative. Hence, in a class A<sub>1</sub> or class AB<sub>1</sub> transformer-coupled audio amplifier, the loading imposed by the grid on the input transformer is negligible. The secondary impedance of a class A<sub>1</sub> or class AB<sub>1</sub> input transformer can, therefore, be made very high since the choice is not limited by the input impedance of the tube; however, transformer design considerations may limit the choice. At the higher radio frequencies, the input impedance may become very low even when the grid is negative, due to the finite time of passage of electrons between cathode and grid and to the appreciable lead reactance. This impedance drops very rapidly as the frequency is raised and increases input-circuit loading. In fact, the input impedance may become low enough at very high radio frequencies to affect appreciably the gain and selectivity of a preceding stage. Tubes such as the "acorn" types and the high-frequency miniatures have been developed to have low input capacitances, low electron transit time, and low lead inductance so that their input impedance is high even at the ultra-high radio frequencies. **Input admittance** is the reciprocal of input impedance.

A **remote-cutoff amplifier** tube is a modified construction of a pentode or a tetrode type and is designed to reduce modulation-distortion and cross-modulation in radio-frequency stages. **Cross-modulation** is the effect produced in a radio receiver by an interfering station "riding through" on the carrier of the station to which the receiver is tuned. **Modulation-distortion** is a distortion of the modulated

carrier and appears as audio-frequency distortion in the output. This effect is produced by a radio-frequency amplifier stage operating on an excessively curved characteristic when the grid bias has been increased to reduce volume. The offending stage for cross-modulation is usually the first radio-frequency amplifier, while

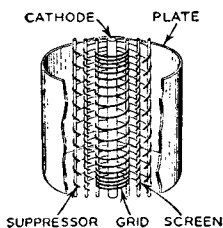

Fig. 16

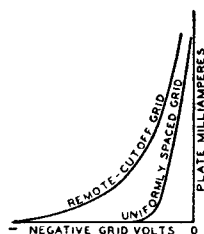

Fig. 17

for modulation-distortion, the cause is usually the last intermediate-frequency stage. The characteristics of remote-cutoff types are such as to enable them to handle both large and small input signals with minimum distortion over a wide range.

Fig. 16 illustrates the construction of the control grid in such a tube. The remote-cutoff action is due to the structure of the grid which provides a variation in amplification factor with change in grid bias. The grid is wound with open spacing at the middle and with close spacing at the ends. When weak signals and low grid bias are applied to the tube, the effect of the non-uniform turn spacing of the grid on cathode emission and tube characteristics is essentially the same as for uniform spacing. As the grid bias is made more negative to handle larger input signals, the electron flow from the sections of the cathode enclosed by the ends of the grid is cut off. The plate current and other tube characteristics are then dependent on the electron flow through the open section of the grid. This action changes the gain of the tube so that large signals may be handled with minimum distortion due to cross-modulation and modulation-distortion. Fig. 17 shows a typical plate-current vs. grid-voltage curve for a remote-cutoff type compared with the curve for a type having a uniformly spaced grid. It will be noted that while the curves are similar at small grid-bias voltages, the plate current of the remote-cutoff tube drops quite slowly with large values of bias voltage. This slow change makes it possible for the tube to handle large signals satisfactorily. Since remote-cutoff types can accommodate large and small signals, they are particularly suitable for use in sets having automatic volume control. Remote-cutoff tubes also are known as variable-mu types. The 6SK7 is a representative remote-cutoff type.

As a class A power amplifier, an electron tube is used in the output stage of a radio receiver to supply a relatively large amount of power to the loudspeaker. For this application, large power output is of more importance than high voltage amplification; therefore, gain possibilities are sacrificed in the design of power tubes to obtain power-handling capability. Triodes, pentodes, and beam power tubes designed for power amplifier service have certain inherent features for each structure. Power tubes of the triode type for class A service are characterized by low power sensitivity, low plate-power efficiency, and low distortion. Power tubes of the pentode type are characterized by high power sensitivity, high plate-power efficiency and, usually, somewhat higher distortion than class A triodes. Beam power tubes such as the 6L6 have still higher power sensitivity and efficiency and have higher power-output capability than triode or conventional pentode types.

A class A power amplifier is used also as a driver to supply power to a class AB<sub>2</sub> or a class B stage. It is usually advisable to use a triode, rather than a pentode, in a driver stage because of the lower plate impedance of the triode.

Power tubes connected in either parallel or push-pull may be employed as class A amplifiers to obtain increased output. The parallel connection (Fig. 18) provides twice the output of a single tube with the same value of grid-signal voltage. With this connection, the effective transconductance of the stage is doubled, and the effective plate resistance and the load resistance required are halved as compared with single-tube values. The push-pull connection (Fig. 19), although it requires twice the grid-signal voltage, has, in addition to providing increased power, other important advantages over single-tube operation. Distortion caused by even-order harmonics and hum caused by plate-voltage-supply fluctuations are either eliminated or decidedly reduced through cancellation. Since distortion for push-pull operation is less than for single-tube operation, appreciably more than twice single-tube output can be obtained by decreasing the load resistance for the stage to a value approaching the load resistance for a single tube. For either parallel or push-pull class A operation of two tubes, all electrode currents are doubled while all dc electrode voltages remain the same as for single-tube operation. If a cathode resistor is used, its value should be about one-half that for a single tube. Should oscillations occur with either type of connection, they can often be eliminated by connecting a non-inductive resistor of approximately 100 ohms in series with each grid at the socket terminal.

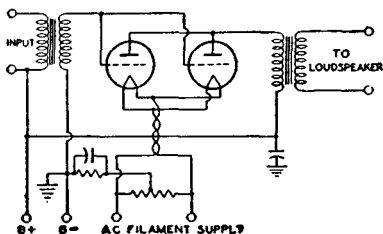

Fig. 18

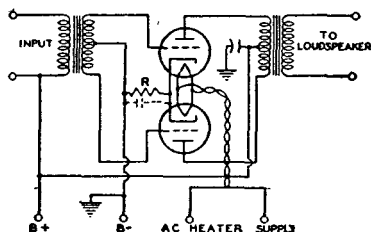

Fig. 19

Operation of power tubes so that the grids run positive is inadvisable except under conditions such as those discussed in this section for class AB and class B amplifiers.

Calculation of the power output of a triode used as a class A amplifier with either an output transformer or a choke having low dc resistance can be made without serious error from the plate family of curves by assuming a resistance load. The proper plate current, grid bias, optimum load resistance, and the per cent second-harmonic distortion can also be determined. The calculations are made graphically and are illustrated in Fig. 20 for given conditions. The procedure is as follows: (1) Locate the zero-signal bias point P by determining the zero-signal bias  $E_{c0}$  from the formula:

$$\text{Zero-signal bias } (E_{c0}) = -(0.68 \times E_b) / \mu$$

where  $E_b$  is the chosen value in volts of dc plate voltage at which the tube is to be operated, and  $\mu$  is the amplification factor of the tube. This quantity is shown as negative to indicate that a negative bias is used. (2) Locate on the plate family the value of zero-signal plate current,  $I_{00}$ , corresponding to point P. (3) Locate  $2I_{00}$ , which is twice the value of  $I_{00}$  and corresponds to the value of the maximum-signal plate current  $I_{max}$ . (4) Locate the point X on the dc bias curve at zero volts,  $E_c = 0$ , corresponding to the value of  $I_{max}$ . (5) Draw a straight line XY through X and P.

Line XY is known as the load resistance line. Its slope corresponds to the value of the load resistance. The load resistance in ohms is equal to  $(E_{max} - E_{min})$  divided by  $(I_{max} - I_{min})$ , where E is in volts and I is in amperes.

It should be noted that in the case of filament types of tubes, the calculations are given on the basis of a dc-operated filament. When, however, the filament is ac-operated, the calculated value of dc bias should be increased by approximately one-half the filament voltage rating of the tube.

The value of zero-signal plate current  $I_0$  should be used to determine the plate dissipation, an important factor influencing tube life. In a class A amplifier under no-signal conditions, the plate dissipation is equal to the power input, i.e., the product of the dc plate voltage  $E_0$  and the zero-signal dc plate current  $I_0$ . If it is found that the plate-dissipation rating of the tube is exceeded with the zero-signal bias  $E_0$  calculated above, it will be necessary to increase the bias by a sufficient amount so that the actual plate dissipation does not exceed the rating before proceeding further with the remaining calculations.

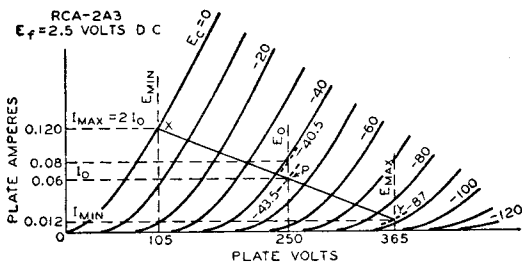

Fig. 20

For power output calculations, it is assumed that the peak alternating grid voltage is sufficient (1) to swing the grid from the zero-signal bias value  $E_{c0}$  to zero bias ( $E_c = 0$ ) on the positive swing and (2) to swing the grid to a value twice the zero-signal bias value on the negative swing. During the negative swing, the plate voltage and plate current reach values of  $E_{max}$  and  $I_{min}$ ; during the positive swing, they reach values of  $E_{min}$  and  $I_{max}$ . Since power is the product of voltage and current, the power output as shown by a wattmeter is given by

$$\text{Power output} = \frac{(I_{max} - I_{min}) (E_{max} - E_{min})}{8}$$

where  $E$  is in volts,  $I$  is in amperes, and power output is in watts.

In the output of power amplifier triodes, some distortion is present. This distortion is due predominantly to second harmonics in single-tube amplifiers. The percentage of second-harmonic distortion may be calculated by the following formula:

$$\% \text{ 2nd-harmonic distortion} = \frac{\frac{I_{max} + I_{min}}{2} - I_0}{I_{max} - I_{min}} \times 100$$

where  $I_0$  is the zero-signal plate current in amperes. In case the distortion is excessive, the load resistance should be increased or decreased slightly and the calculations repeated.

**Example:** Determine the load resistance, power output, and distortion of a triode having an amplification factor of 4.2, a plate-dissipation rating of 15 watts, and plate characteristics curves as shown in Fig. 20. The tube is to be operated at 250 volts on the plate.

**Procedure:** For a first approximation, determine the operating point  $P$  from the zero-signal bias formula,  $E_{c0} = -(0.68 \times 250) / 4.2 = -40.5$  volts. From the curve for this voltage, it is found that the zero-signal plate current  $I_0$  at a plate voltage of 250 volts is 0.08 ampere and, therefore, the plate-dissipation rating is exceeded

( $0.08 \times 250 = 20$  watts). Consequently, it is necessary to reduce the zero-signal plate current to 0.06 ampere at 250 volts. The grid bias is now seen to be  $-43.5$  volts. Note that the curve was taken with a dc filament supply; if the filament is to be operated on an ac supply, the bias must be increased by about one-half the filament voltage, or to  $-45$  volts, and the circuit returns made to the mid-point of the filament circuit.

Point X can now be determined. Point X is at the intersection of the dc bias curve at zero volts with  $I_{max}$ , where  $I_{max} = 2I_o = 2 \times 0.06 = 0.12$  ampere. Line XY is drawn through points P and X.  $E_{max}$ ,  $E_{min}$ , and  $I_{min}$  are then found from the curves. Substituting these values in the power output formula, we obtain

$$\text{Power output} = \frac{(0.12 - 0.012)(365 - 105)}{8} = 3.52 \text{ watts}$$

The resistance represented by load line XY is

$$\frac{(365 - 105)}{(0.12 - 0.012)} = 2410 \text{ ohms}$$

If now the values from the curves are substituted in the distortion formula, we obtain

$$\% \text{ 2nd-harmonic distortion} = \frac{0.12 + 0.012}{2} - 0.06 \div \frac{0.12 - 0.012}{2} \times 100 = 5.5\%$$

It is customary to select the load resistance so that the distortion does not exceed five per cent. When the method shown is used to determine the slope of the load resistance line, the second-harmonic distortion generally does not exceed five per cent. In the example, however, the distortion is excessive and it is desirable, therefore, to use a slightly higher load resistance. A load resistance of 2500 ohms will give a distortion of about 4.9 per cent. The power output is reduced only slightly to 3.5 watts.

Operating conditions for **triodes in push-pull** depend on the type of operation desired. Under class A conditions, distortion, power output, and efficiency are all relatively low. The operating bias can be anywhere between that specified for single-tube operation and that equal to one-half the grid-bias voltage required to produce plate-current cutoff at a plate voltage of  $1.4E_o$ , where  $E_o$  is the operating plate voltage. Higher bias than this value requires higher grid-signal voltage and results in class AB<sub>1</sub> operation which is discussed later.

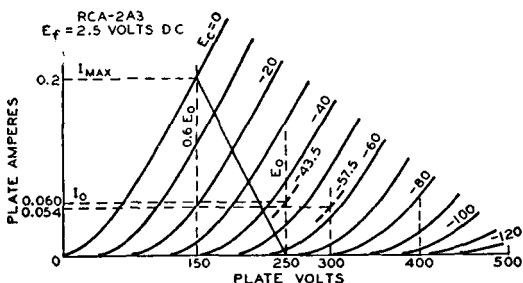

Fig. 21

The method for calculating power output for **triodes in push-pull class A operation** is as follows: Erect a vertical line at  $0.6E_o$  (see Fig. 21), intersecting the  $E_c = 0$  curve at the point  $I_{max}$ . Then,  $I_{max}$  is determined from the curve for use in the formula

$$\text{Power output} = (I_{max} \times E_o)/5$$

If  $I_{max}$  is expressed in amperes and  $E_o$  in volts, power output is in watts.

The method for determining the proper load resistance for triodes in push-pull is as follows: Draw a load line through  $I_{\max}$  on the zero-bias curve and through the  $E_o$  point on the zero-current axis. Four times the resistance represented by this load line is the plate-to-plate load for two triodes in a class A push-pull amplifier. Expressed as a formula,

$$\text{Plate-to-plate load } (R_{pp}) = 4 \times (E_o - 0.6E_o) / I_{\max}$$

$E_o$  is expressed in volts,  $I_{\max}$  in amperes, and  $R_{pp}$  in ohms.

**Example:** Assume that the plate voltage ( $E_o$ ) is to be 300 volts, and the plate dissipation rating of the tube is 15 watts. Then, for class A operation, the operating bias can be equal to, but not more than, one-half the grid bias for cutoff with a plate voltage of  $1.4 \times 300 = 420$  volts. (Since cutoff bias is approximately -115 volts at a plate voltage of 420 volts, one-half of this value is -57.5 volts bias.) At this bias, the plate current is found from the plate family to be 0.054 ampere and, therefore, the plate dissipation is  $0.054 \times 300$  or 16.2 watts. Since -57.5 volts is the limit of bias for class A operation of these tubes at a plate voltage of 300 volts, the dissipation cannot be reduced by increasing the bias and it, therefore, becomes necessary to reduce the plate voltage.

If the plate voltage is reduced to 250 volts, the bias will be found to be -43.5 volts. For this value, the plate current is 0.06 ampere, and the plate dissipation is 15 watts. Then, following the method for calculating power output, erect a vertical line at  $0.6E_o = 150$  volts. The intersection of the line with the curve  $E_c = 0$  is  $I_{\max}$  or 0.2 ampere. When this value is substituted in the power formula, the power output is  $(0.2 \times 250) / 5 = 10$  watts. The load resistance is determined from the load formula: Plate-to-plate load ( $R_{pp}$ ) =  $4(250 - 150) / 0.2 = 2000$  ohms.

Power output for a pentode or a beam power tube as a class A amplifier can be calculated in much the same way as for triodes. The calculations can be made graphically from a special plate family of curves, as illustrated in Fig. 22.

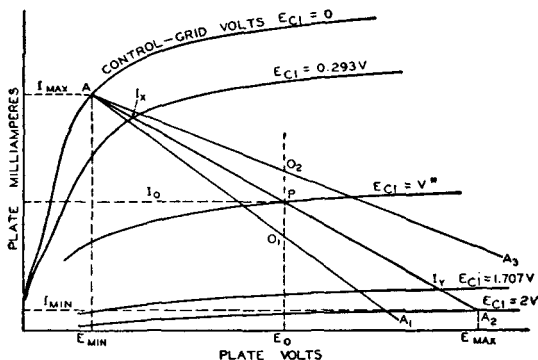

\*V is the Negative Control-Grid Bias Voltage at the Operating Point

Fig. 22

From a point A just above the knee of the zero-bias curve, draw arbitrarily selected load lines to intersect the zero-plate-current axis. These lines should be on both sides of the operating point P whose position is determined by the desired operating plate voltage  $E_o$ , and one-half the maximum-signal plate current. Along any load line, say  $AA_1$ , measure the distance  $AO_1$ . On the same line, lay off an equal distance  $O_1A_1$ . For optimum operation, the change in bias from A to  $O_1$  should be nearly equal to the change in bias from  $O_1$  to  $A_1$ . If this condition can not be met with one line, as is the case for the line first chosen, then, another should be

chosen. When the most satisfactory line has been selected, its resistance may be determined by the following formula:

$$\text{Load resistance (R}_p) = \frac{E_{\max} - E_{\min}}{I_{\max} - I_{\min}}$$

The value of  $R_p$  may then be substituted in the following formula for calculating power output.

$$\text{Power output} = \frac{[I_{\max} - I_{\min} + 1.41 (I_x - I_y)]^2 R_p}{32}$$

In both of these formulas,  $I$  is in amperes,  $E$  is in volts,  $R_p$  is in ohms, and power output is in watts.  $I_x$  and  $I_y$  are the current values on the load line at bias voltages of  $E_{c1} = V - 0.707V = 0.293V$  and  $E_{c1} = V + 0.707V = 1.707V$ , respectively.

Calculations for distortion may be made by means of the following formulas. The terms used have already been defined.

$$\% \text{ 2nd-harmonic distortion} = \frac{I_{\max} + I_{\min} - 2 I_0}{I_{\max} - I_{\min} + 1.41 (I_x - I_y)} \times 100$$

$$\% \text{ 3rd-harmonic distortion} = \frac{I_{\max} - I_{\min} - 1.41 (I_x - I_y)}{I_{\max} - I_{\min} + 1.41 (I_x - I_y)} \times 100$$

$$\% \text{ total (2nd and 3rd) harmonic distortion} = \sqrt{(\%2\text{nd})^2 + (\%3\text{rd})^2}$$

The conversion curves given in Fig. 23 apply to electron tubes in general but are particularly useful for power tubes. These curves can be used for calculating approximate operating conditions for a plate voltage which is not included in the published data on operating conditions. For instance, suppose it is desired to operate two 6L6's in class  $A_1$  push-pull, fixed bias, with a plate voltage of 200 volts. The nearest published operating conditions for this class of service are for a plate voltage of 250 volts. The operating conditions for the new plate voltage can be determined as follows: First compute the ratio of the new plate voltage to the plate voltage of the published data. In the example, this ratio is  $200/250 = 0.8$ . This figure is the Voltage Conversion Factor,  $F_e$ . Multiply by this factor the published values for 250-volt operation in order to obtain the new values of grid bias and screen voltage. This gives a grid bias of  $-16 \times 0.8 = -12.8$  volts, and a screen voltage of  $250 \times 0.8 = 200$  volts for the new conditions.

To obtain the rest of the new conditions, multiply the published values by factors shown on the chart as corresponding to the voltage conversion factor of 0.8. In this chart,

$F_i$  applies to plate current and to screen current,

$F_p$  applies to power output

$F_r$  applies to load resistance and plate resistance,

$F_{gm}$  applies to transconductance.

Thus, to find the power output for the new conditions, determine the value of  $F_p$  for a

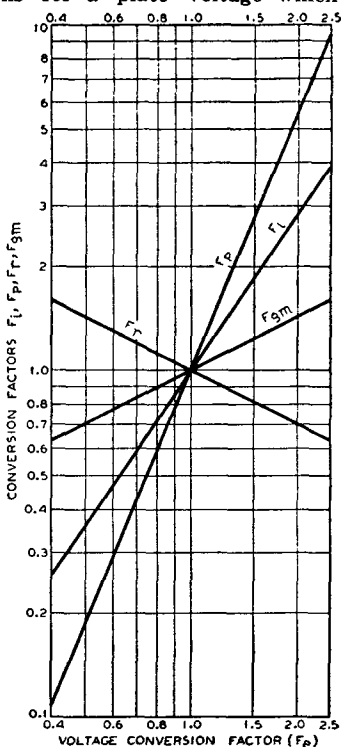

Fig. 23

voltage conversion factor of 0.8. The chart shows that this value of  $F_p$  is 0.6. Multiplying the published value of power output by 0.6, the power output for the new conditions is  $14.5 \times 0.6 = 8.7$  watts.

A class AB power amplifier employs two tubes connected in push-pull with a higher negative grid bias than is used in a class A stage. With this higher negative bias, the plate and screen voltages can usually be made higher than for class A because the increased negative bias holds plate current within the limit of the tube's plate-dissipation rating. As a result of these higher voltages, more power output can be obtained from class AB operation.

Class AB amplifiers are subdivided into class AB<sub>1</sub> and class AB<sub>2</sub>. In class AB<sub>1</sub> there is no flow of grid current. That is, the peak signal voltage applied to each grid is not greater than the negative grid-bias voltage. The grids therefore are not driven to a positive potential and do not draw grid current. In class AB<sub>2</sub>, the peak signal voltage is greater than the bias so that the grids are driven positive and draw grid current.

Because of the flow of grid current in a class AB<sub>2</sub> stage there is a loss of power in the grid circuit. The sum of this loss and the loss in the input transformer is the total driving power required by the grid circuit. The driver stage should be capable of a power output considerably larger than this required power in order that distortion introduced in the grid circuit be kept low. The input transformer used in a class AB<sub>2</sub> amplifier usually has a step-down turns ratio.

Because of the large fluctuations of plate current in a class AB<sub>2</sub> stage, it is important that the plate power supply should have good regulation. Otherwise the fluctuations in plate current cause fluctuations in the voltage output of the power supply, with the result that power output is decreased and distortion is increased. To obtain satisfactory regulation it is usually advisable to use a low-drop rectifier, such as the 5V4-G, with a choke-input filter. In all cases, the resistance of the filter choke and power transformers should be as low as possible.

In class AB<sub>1</sub> push-pull amplifier service using triodes, the operating conditions may be determined graphically by means of the plate family if  $E_o$ , the desired operating plate voltage, is given. In this service, the dynamic load line does not pass through the operating point P as in the case of the single-tube amplifier, but through the point D in Fig. 24. Its position is not affected by the operating grid bias provided the plate-to-plate load resistance remains constant. Under these conditions, grid bias has only a small effect on the power output. Grid bias cannot be neglected, however, since it is used to find the zero-signal plate current and, from it, the zero-signal plate dissipation. Since the grid bias is higher in class AB<sub>1</sub> than in class A service for the same plate voltage, this "overbiased" condition permits the use of a higher signal voltage without grid current being drawn and, therefore, higher power output is obtained than in class A service.

In general, for any load line through point D, Fig. 24, the plate-to-plate load resistance in ohms of a push-pull amplifier is  $R_{pp} = 4E_o/I'$ , where  $I'$  is the plate current value in amperes at which the load line as projected intersects the plate current axis and  $E_o$  is in volts. This is another form of the formula, given under push-pull class A amplifiers,  $R_{pp} = 4(E_o - 0.6E_o)/I_{max}$ , but is more general. Power output =  $(I_{max}/\sqrt{2})^2 \times R_{pp}/4$ , where  $I_{max}$  is the peak plate current at zero grid volts for the load chosen. This formula simplified is  $(I_{max})^2 \times R_{pp}/8$ . The maximum-signal average plate current is  $2I_{max}/\pi$  or  $0.636 I_{max}$ ; the maximum-signal average power input is  $0.636 I_{max} E_o$ .

It is desirable to simplify these formulas for a first approximation. This simplification can be made if it is assumed that the peak plate current,  $I_{max}$ , occurs at the point of the zero-bias curve corresponding approximately to  $0.6E_o$ . The simplified formulas are:



$$\text{Power output (for two tubes)} = (I_{\max} \times E_o)/5$$

$$\text{Plate-to-plate load resistance } (R_{pp}) = 1.6E_o/I_{\max}$$

where  $E_o$  is in volts,  $I_{\max}$  is in amperes,  $R_{pp}$  is in ohms, and power output is in watts.

It may be found during subsequent calculations that the distortion or the plate dissipation is excessive for this approximation; in that case, a different load resistance must be selected using the first approximation as a guide and the process repeated to obtain satisfactory operating conditions.

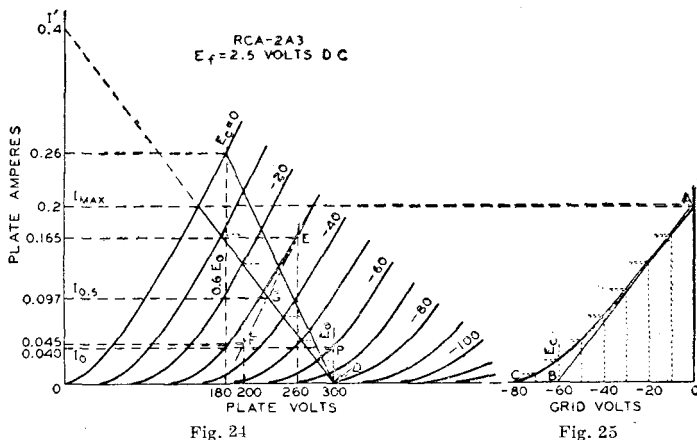

Fig. 24

Fig. 25

**Example:** Fig. 24 illustrates the application of the method to a pair of 2A3's operated at  $E_o = 300$  volts. The tubes have a plate-dissipation rating each of 15 watts. The method is to erect a vertical line at  $0.6E_o$ , or at 180 volts, which intersects the  $E_c = 0$  curve at the point  $I_{\max} = 0.26$  ampere. Using the simplified formulas, we obtain

$$\text{Plate-to-plate load resistance } (R_{pp}) = (1.6 \times 300)/0.26 = 1845 \text{ ohms}$$

$$\text{Power output} = (0.26 \times 300)/5 = 15.6 \text{ watts}$$

At this point, it is well to determine the plate dissipation and to compare it with the maximum rated value. From the average plate current formula ( $0.636 I_{\max}$ ) mentioned previously, the maximum-signal average plate current is 0.166 ampere. The product of this current and the operating plate voltage is 49.8 watts, the average input to the two tubes. From this value, subtract the power output of 15.6 watts to obtain the total dissipation for both tubes which is 34.2 watts. Half of this value, 17 watts, is in excess of the 15-watt rating of the tube and it is necessary, therefore, to assume another and higher load resistance so that the plate-dissipation rating will not be exceeded.

It will be found that at an operating plate voltage of 300 volts, the 2A3's require a plate-to-plate load resistance of 3000 ohms. From the formula for  $R_{pp}$ , the value of  $I'$  is found to be 0.4 ampere. The load line for the 3000-ohm load resistance is then represented by a straight line from the point  $I' = 0.4$  ampere on the plate-current ordinate to the point  $E_o = 300$  volts on the plate-voltage abscissa. At the intersection of the load line with the zero-bias curve, the peak plate current,  $I_{\max}$ , can be read at 0.2 ampere. Then

$$\text{Power output} = (I_{\max}/\sqrt{2})^2 R_{pp}/4 = (0.2/1.41)^2 \cdot 3000/4 = 15 \text{ watts}$$

Proceeding as in the first approximation, we find that the maximum-signal average plate current,  $0.636 I_{\max}$ , is 0.127 ampere, and the maximum-signal average power input is 38.1 watts. This input minus the power output is  $38.1 - 15 = 23.1$  watts.

This is the dissipation for two tubes; the value per tube is 11.6 watts, a value well within the rating of this tube type.

The operating bias and the zero-signal plate current may now be found by use of a curve which is derived from the plate family and the load line. Fig. 25 is a curve of instantaneous values of plate current and dc grid-bias voltages taken from Fig. 24. Values of grid bias are read from each of the grid-bias curves of Fig. 24 along the load line and are transferred to Fig. 25 to produce the curved line from A to C. A tangent to this curve, starting at A, is drawn to intersect the grid-voltage abscissa. The point of intersection, B, is the operating grid bias for fixed-bias operation. In the example, the bias is  $-60$  volts. Refer back to the plate family at the operating conditions of plate volts =  $300$  and grid bias =  $-60$  volts; the zero-signal plate current per tube is seen to be  $0.04$  ampere. This procedure locates the operating point for each tube at P. The plate current must be doubled, of course, to obtain the zero-signal plate current for both tubes. Under maximum-signal conditions, the signal voltage swings from zero-signal bias voltage to zero bias for each tube on alternate half cycles. Hence, in the example, the peak af signal voltage per tube is  $60$  volts, or the grid-to-grid value is  $120$  volts.

As in the case of the push-pull class A amplifier, the second-harmonic distortion in a class AB<sub>1</sub> amplifier using triodes is very small and is largely cancelled by virtue of the push-pull connection. Third-harmonic distortion, however, which may be larger than permissible, can be found by means of composite characteristic curves. A complete family of curves can be plotted, but for the present purpose only the one corresponding to a grid bias of one-half the peak grid-voltage swing is needed. In the example, the peak grid voltage per tube is  $60$  volts, and the half value is  $30$  volts. The composite curve, since it is nearly a straight line, can be constructed with only two points (see Fig. 24). These two points are obtained from deviations above and below the operating grid and plate voltages. In order to find the curve for a bias of  $-30$  volts, we have assumed a deviation of  $30$  volts from the operating grid voltage of  $-60$  volts. Next assume a deviation from the operating plate voltage of, say,  $40$  volts. Then at  $300 - 40 = 260$  volts, erect a vertical line to intersect the  $(-60) - (-30) = -30$ -volt bias curve and read the plate current at this intersection which is  $0.167$  ampere; likewise, at the intersection of a vertical line at  $300 + 40 = 340$  volts and the  $(-60) + (-30) = -90$ -volt bias curve, read the plate current. In this example, the plate current is estimated to be  $0.002$  ampere. The difference of  $0.165$  ampere between these two currents determines the point E on the  $300 - 40 = 260$ -volt vertical. Similarly, another point F on the same composite curve is found by assuming the same grid-bias deviation but a larger plate-voltage deviation, say,  $100$  volts. We now have points at  $260$  volts and  $0.165$  ampere (E), and at  $200$  volts and  $0.45$  ampere (F). A straight line through these points is the composite curve for a bias of  $-30$  volts, shown as a long-short dash line in Fig. 24. At the intersection of the composite curve and the load line, G, the instantaneous composite plate current at the point of one-half the peak signal swing is determined. This current value, designated  $I_{0.5}$  and the peak plate current,  $I_{\max}$ , are used in the following formula to find peak value of the third-harmonic component of the plate current.

$$I_{h_3} = (2I_{0.5} - I_{\max})/3$$

In the example, where  $I_{0.5}$  is  $0.097$  ampere and  $I_{\max}$  is  $0.2$  ampere,  $I_{h_3} = (2 \times 0.097 - 0.2)/3 = (0.194 - 0.2)/3 = -0.006/3 = -0.002$  ampere. (The fact that  $I_{h_3}$  is negative indicates that the phase relation of the fundamental (first-harmonic) and third-harmonic components of the plate current is such as to result in a slightly peaked wave form.  $I_{h_3}$  is positive in some cases, indicating a flattening of the wave form.)

The peak value of the fundamental or first-harmonic component of the plate current

$$I_{h1} = 2/3 (I_{max} + I_{0.5})$$

In the example:  $I_{h1} = 2/3 (0.2 + 0.097) = 0.198$  ampere. Then, the percentage of third-harmonic distortion is  $(I_{h3}/I_{h1}) 100 = (0.002/0.198)100 = 1\%$  approx.

A class  $AB_2$  amplifier employs two tubes connected in push-pull as in the case of class  $AB_1$  amplifiers. It differs in that it is biased so that plate current flows somewhat more than half the electrical cycle but less than the full cycle, the peak signal voltage is greater than the dc bias voltage, grid current is drawn, and consequently, power is consumed in the grid circuit. These conditions permit obtaining high power output without excessive plate dissipation.

The sum of the power used in the grid circuit and the losses in the input transformer is the total driving power required by the grid circuit. The driver stage should be capable of a power output considerably larger than this required power in order that distortion introduced in the grid circuit be kept low. In addition, the internal impedance of the driver stage as reflected into or as effective in the grid circuit of the power stage should always be as low as possible in order that distortion may be kept low. The input transformer used in a class  $AB_2$  stage usually has a step-down ratio adjusted for this condition.

Load resistance, plate dissipation, power output, and distortion determinations are similar to those for class  $AB_1$ . These quantities are interdependent with peak grid-voltage swing and driving power; a satisfactory set of operating conditions involves a series of approximations. The load resistance and signal swing are limited by the permissible grid current and power, and the distortion. With either a high load resistance or excessive signal swing, the plate-dissipation rating will be exceeded, distortion will be high, and the driving power will be unnecessarily high.

A class B amplifier employs two tubes connected in push-pull, so biased that plate current is almost zero when no signal voltage is applied to the grids. Because of this new value of no-signal plate current, class B amplification has the same advantage as class  $AB_2$ , i.e., large power output can be obtained without excessive plate dissipation. The difference between class B and class  $AB_2$  is that, in class B, plate current is cut off for a larger portion of the negative grid swing, and the signal swing is even larger than in class  $AB_2$  operation.

Because a class B amplifier is usually operated at zero or low bias, each grid is at a positive potential during all or most of the positive half-cycle of its signal swing and consequently draws considerable grid current. There is, therefore, a loss of power in the grid circuit. This condition imposes the same requirement in the driver stage as in a class  $AB_2$  stage, that is, the driver should be capable of delivering considerably more power output than the power required for the class B grid circuit in order that distortion be low. Likewise, the interstage transformer between the driver and class B stage usually has a step-down turns ratio.

Determination of load resistance, plate dissipation, power output, and distortion is similar to that for a class  $AB_2$  stage.

Power amplifier tubes designed for class A operation can be used in class  $AB_2$  and class B service under suitable operating conditions. There are several tube types designed especially for class B service. The characteristic common to all of these types is a high amplification factor. With a high amplification factor, plate current is small even when the grid bias is zero. These tubes, therefore, can be operated in class B service at a bias of zero volts so that no bias supply is required. A number of class B amplifier tubes consist of two triode units mounted in one tube. The two units can be connected in push-pull so that only one tube is required for a class B stage. Examples of twin triodes used in class B service are the 6N7, 6A6, and 1G6-GT.

An inverse-feedback circuit, sometimes called a degenerative circuit, is one

in which a portion of the output voltage of a tube is applied to the input of the same or a preceding tube in opposite phase to the signal applied to the tube. Two important advantages of feedback are: (1) reduced distortion from each stage included in the feedback circuit and (2) reduction in the variations in gain due to changes in line voltage, possible differences between tubes of the same type, or variations in the values of circuit constants included in the feedback circuit.

Inverse feedback is used in audio amplifiers to reduce distortion in the output stage where the load impedance on the tube is a loudspeaker. Because the impedance of a loudspeaker is not constant for all audio frequencies, the load impedance on the output tube varies with frequency. When the output tube is a pentode or beam power tube having high plate resistance, this variation in plate load impedance can, if not corrected, produce considerable frequency distortion. Such frequency distortion can be reduced by means of inverse feedback. Inverse feedback circuits are of the **constant-voltage** type and the **constant-current** type.

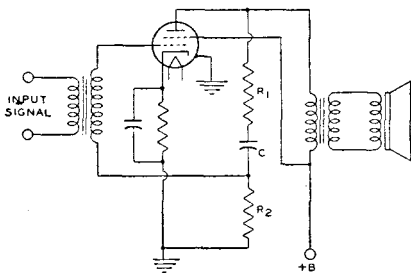

Fig. 26

The application of the **constant-voltage** type of inverse feedback to a power output stage using a single beam power tube is illustrated by Fig. 26. In this circuit,  $R_1$ ,  $R_2$ , and  $C$  are connected across the output of the 6L6 as a voltage divider. The secondary of the grid-input transformer is returned to a point on this voltage divider. Capacitor  $C$  blocks the dc plate voltage from the grid. However, a portion of the tube's af output voltage, approximately equal

to the output voltage multiplied by the fraction  $R_2/(R_1 + R_2)$ , is applied to the grid. A decrease in distortion results which is explained in the curves of Fig. 27.

Consider first the amplifier without the use of inverse feedback. Suppose that when a signal voltage  $e_s$  is applied to the grid the af plate current  $i'_p$  has an irregularity in its positive half-cycle. This irregularity represents a departure from the waveform of the input signal and is, therefore, distortion. For this plate-current waveform, the af plate voltage has a waveform shown by  $e'_p$ . The plate-voltage waveform is inverted compared to the plate-current waveform because a plate-current increase produces an increase in the drop across the plate load. The voltage at the plate is the difference between the drop across the load and the supply voltage; thus, when plate current goes up, plate voltage goes down; when plate current goes down, plate voltage goes up.

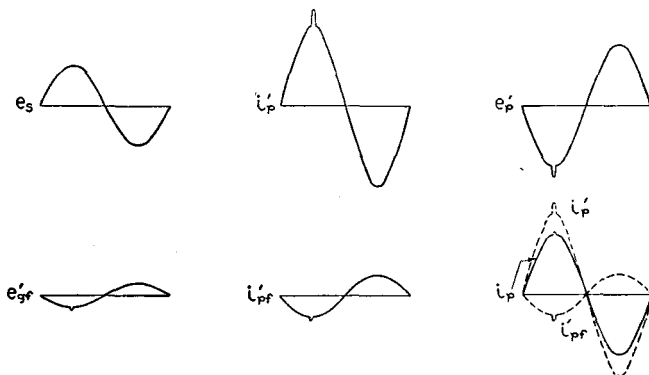

Fig. 27

Now suppose that inverse feedback is applied to the amplifier. The voltage fed back to the grid has the same waveform and phase as the plate voltage, but is smaller in magnitude. Hence, with a plate voltage of waveform shown by  $e'_p$ , the feedback voltage appearing on the grid is as shown by  $e'_{gr}$ . This voltage applied to the grid produces a component of plate current  $i'_{pf}$ . It is evident that the irregularity in the waveform of this component of plate current would act to cancel the original irregularity and thus reduce distortion.

After the correction of distortion has been applied by inverse feedback, the relations are as shown in the curve for  $i_p$ . The dotted curve shown by  $i'_{pf}$  is the component of plate current due to the feedback voltage on the grid. The dotted curve shown by  $i'_p$  is the component of plate current due to the signal voltage on the grid. The algebraic sum of these two components gives the resultant plate current shown by the solid curve of  $i_p$ . Since  $i'_p$  is the plate current that would flow without inverse feedback, it can be seen that the application of inverse feedback has reduced the irregularity in the output current. In this manner inverse feedback acts to correct any component of plate current that does not correspond to the input signal voltage, and thus reduces distortion.

From the curve for  $i_p$ , it can be seen that, besides reducing distortion, inverse feedback also reduces the amplitude of the output current. Consequently, when inverse feedback is applied to an amplifier there is a decrease in power output as well as a decrease in distortion. However, by increasing the signal voltage, it is practical to bring the power output back to its full value. Hence, the application of inverse feedback to an amplifier requires that more driving voltage be applied to obtain full power output but this output is obtained with less distortion.

Inverse feedback may also be applied to resistance-coupled stages as shown in Fig. 28. The circuit is conventional except that a feedback resistor,  $R_3$ , is connected between the plate of tubes  $T_1$  and  $T_2$ . The output signal voltage of  $T_1$  and a portion of the output signal voltage of  $T_2$  appears across  $R_2$ . Because the distortion generated in the plate circuit of  $T_2$  is applied to its grid out of phase with the input signal, the distortion in the output of  $T_2$  is comparatively low. With sufficient inverse feedback of the constant-voltage type in a power-output stage, it is not necessary to employ a network of resistance and capacitance in the output circuit to reduce response at high audio frequencies. Inverse-feedback circuits can also be applied to push-pull class A and class AB<sub>1</sub> amplifiers. When the circuit in Fig. 26 is used in push-pull, the input transformer must have a separate secondary for each grid. Inverse feedback is not recommended for use in amplifiers drawing grid power because of the resistance introduced in the grid circuit.

**Constant-current** inverse feedback is usually obtained by omitting the bypass capacitor across a cathode resistor. This method decreases the gain and the distortion but increases the plate resistance of the tube. When the plate resistance of an output tube is increased, the output voltage rises at the resonant frequency of the loudspeaker and accentuates hang-over effects.

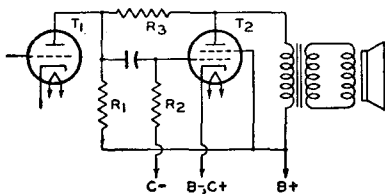

Fig. 28

Inverse feedback is not generally applied to a triode power amplifier, such as the 2A3, because the variation in speaker impedance with frequency does not produce much distortion in a triode stage having low plate resistance. It is sometimes applied in a pentode stage but is not always convenient. As has been shown, when inverse feedback is used in an amplifier, the driving voltage must be increased in order to give full power output.

When inverse feedback is used with a pentode, the total driving voltage required for full power output may be inconveniently large. Because a beam power tube gives full power output on a comparatively small driving voltage, inverse feedback is especially applicable to beam power tubes. By means of inverse feedback, the high efficiency and high power output of beam power tubes can be combined with freedom from the effects of varying speaker impedance.

Another important application of inverse feedback is in the **cathode follower** circuit, an example of which is given in Fig. 29. In this application, there is no load resistance in the plate circuit; the output is taken from the load resistance in the cathode circuit. The voltage amplification of a cathode follower may be expressed by the following convenient formulas.

*For a triode:*

$$\text{Voltage amplification} = \frac{\text{amplification factor} \times \text{load resistance}}{\text{plate resistance} + \text{load resistance} \times (\text{amplification factor} + 1)}$$

*For a pentode:*

$$\text{Voltage amplification} = \frac{\text{transconductance} \times \text{load resistance}}{1 + (\text{transconductance} \times \text{load resistance})}$$

Resistance values are in ohms; transconductance values are in mhos. From these formulas it can be seen that the voltage amplification is always less than unity.

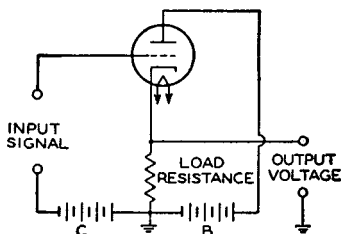

Fig. 29

In addition to having a wide frequency response, the cathode follower has the features of high input impedance and low output impedance. These features permit the cathode follower to be used to match a high-impedance source to a low-impedance load. Typical applications would be the connection of a high-impedance crystal phonograph pickup to a low-impedance transmission line, or the connection of a wide-band, high-impedance, video signal source to a low-impedance transmission line. In audio applications, however, the use of an unbypassed cathode resistor, as required by a cathode-follower stage, is not recommended unless the signal level of the stage is fairly high and the gain of the succeeding stages is moderate.

Selection of a suitable tube and its operating conditions for use in a cathode-follower circuit having a specified output impedance can be made, in most practical cases, by the use of the following formula to determine the required tube transconductance.

$$\text{Required transconductance (micromhos)} = \frac{1,000,000}{\text{output impedance (ohms)}}$$

Once the required transconductance is obtained, a suitable tube and its operating conditions may be determined from the TECHNICAL DATA SECTION. The conversion curves given in Fig. 23 may be used for calculating operating conditions for values of transconductance not included in the tabulated data. After the operating conditions have been determined, the value of the required cathode load resistance may be calculated from the following formula.

*For triode:*

$$\text{Cathode load resistance} = \frac{\text{output impedance} \times \text{plate resistance}}{\text{plate resistance} - \text{output impedance} (1 + \text{amplification factor})}$$

*For pentode:*

$$\text{Cathode load resistance} = \frac{\text{output impedance}}{1 - (\text{transconductance} \times \text{output impedance})}$$

Resistance and impedance values are in ohms; transconductance values are in mhos.

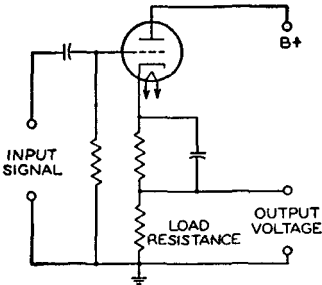

Fig. 30

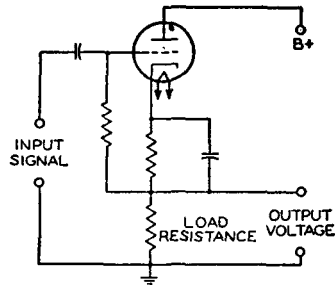

Fig. 31

If the value of the cathode load resistance calculated to give the required output impedance does not give the required operating bias, the basic cathode-follower circuit can be modified in a number of ways. Two of the more common modifications are given in Figs. 30 and 31. In Fig. 30 the bias is increased by adding a bypassed resistance between the cathode and the unbypassed load resistance and returning the grid to the low end of the load resistance. In Fig. 31 the bias is reduced by adding a bypassed resistance between the cathode and the unbypassed load resistance but, in this case, the grid is returned to the junction of the two cathode resistors so that the bias voltage is only the dc voltage drop across the added resistance. The size of the bypass capacitor should be large enough so that it presents negligible reactance at the lowest frequency to be handled. In both cases the B-supply should be increased to make up for the voltage taken for biasing. Example: Select a suitable tube and determine the operating conditions and circuit components for a cathode-follower circuit having an output impedance that will match a 500-ohm transmission line. Procedure: First, determine the approximate transconductance required.

$$\text{Required transconductance} = \frac{1,000,000}{500} = 2000 \text{ micromhos}$$

A survey of the tubes that have a transconductance in this order of magnitude shows that type 12AX7 is among the tubes to be considered. Referring to the characteristics given in the technical data section for one triode unit of high- $\mu$  twin triode 12AX7, we find that for a plate voltage of 250 volts and a bias of -2 volts, the transconductance is 1600 micromhos, the plate resistance is 62500 ohms, the amplification factor is 100, and the plate current is 0.0012 ampere. When these values are used in the expression for determining the cathode load resistance, we obtain

$$\text{Cathode load resistance} = \frac{500 \times 62500}{62500 - 500 (100 + 1)} = 2600 \text{ ohms}$$

The voltage across this resistor when the plate current of 0.0012 ampere flows is  $2600 \times 0.0012 = 3.12$  volts. Since the required bias voltage is only -2 volts, the circuit arrangement given in Fig. 31 is employed. The bias is furnished by a resistance that will have a voltage drop of 2 volts when it carries a current of 0.0012 ampere. The required bias resistance, therefore, is  $2/0.0012 = 1670$  ohms. If 60

cycles per second is the lowest frequency to be passed, 20 microfarads is a suitable value for the bypass capacitor. The B-supply, of course, is increased by the voltage drop across the cathode resistance which, in this example, is approximately 5 volts. The B-supply, therefore, is  $250 + 5 = 255$  volts.

Since it is desirable to eliminate, if possible, the bias resistor and bypass capacitor, it is worthwhile to try other tubes and other operating conditions to obtain a value of cathode load resistance which will also provide the required bias. If the triode section of twin diode—high- $\mu$  triode 6AT6 is operated under the conditions given in the technical data section with a plate voltage of 100 volts and a bias of -1 volt, it will have an amplification factor of 70, a plate resistance of 54000 ohms, a transconductance of 1300 micromhos, and a plate current of 0.0008 ampere.

Then,

$$\text{Cathode load resistance} = \frac{500 \times 54000}{54000 - 500(70 + 1)} = 1460 \text{ ohms}$$

The bias voltage obtained across this resistance is  $1460 \times 0.0008 = 1.17$  volts. Since this value is for all practical purposes close enough to the required bias, no additional bias resistance will be required and the grid may be returned directly to ground. There is no need to adjust the B-supply voltage to make up for the drop in the cathode resistor. The voltage amplification for the cathode-follower circuit utilizing the triode section of type 6AT6 is

$$\text{Voltage amplification} = \frac{70 \times 1460}{54000 - 1460(70 + 1)} = 0.65$$

For applications in which the cathode follower is used to isolate two circuits—for example, when it is used between a circuit being tested and the input stage of an oscilloscope or a vacuum-tube voltmeter—voltage output and not impedance matching is the primary consideration. In such applications it is desirable to use a relatively high value of cathode load resistance, such as 50,000 ohms, in order to get the maximum voltage output. In order to obtain proper bias, a circuit such as that of Fig. 31 should be used. With a high value of cathode resistance, the voltage amplification will approximate unity.

A **corrective filter** can be used to improve the frequency characteristic of an output stage using a beam power tube or a pentode when inverse feedback is not applicable. The filter consists of a resistor and a capacitor connected in series across the primary of the output transformer. Connected in this way, the filter is in parallel with the plate load impedance reflected from the voice-coil by the output transformer. The magnitude of this reflected impedance increases with increasing frequency in the middle and upper audio range. The impedance of the filter, however, decreases with increasing frequency. It follows that by use of the proper values for the resistance and the capacitance in the filter, the effective load impedance on the output tubes can be made practically constant for all frequencies in the middle and upper audio range. The result is an improvement in the frequency characteristic of the output stage.

The resistance to be used in the filter for a push-pull stage is 1.3 times the recommended plate-to-plate load resistance; or, for a single-tube stage, is 1.3 times the recommended plate load resistance. The capacitance in the filter should have a value such that the voltage gain of the output stage at a frequency of 1000 cycles or higher is equal to the voltage gain at 400 cycles. A method of determining the proper value of capacitance for the filter is to make two measurements of the output voltage across the primary of the output transformer: first, when a 400-cycle signal is applied to the input, and second, when a 1000-cycle signal of the same voltage as the 400-cycle signal is applied to the input. The correct value of capacitance is the one which gives equal output voltages for the two signal inputs. In practice, this value is usually found to be in the order of 0.05  $\mu\text{f}$ .



A volume expander can be used in a phonograph amplifier to make more natural the reproduction of music which has a very large volume range. For instance, in the music of a symphony orchestra, the sound intensity of the loud passages is very much higher than that of the soft passages. When this music is recorded, it is not feasible to make the ratio of maximum amplitude to minimum amplitude as large on the record as it is in the original music. The recording process is therefore monitored so that the volume range of the original is compressed on the record. To compensate for this compression, a volume-expander amplifier has a variable gain which is greater for a high-amplitude signal than for a low-amplitude signal. The volume expander, therefore, amplifies loud passages more than soft passages and thus can restore to the music reproduced from the record the volume range of the original.

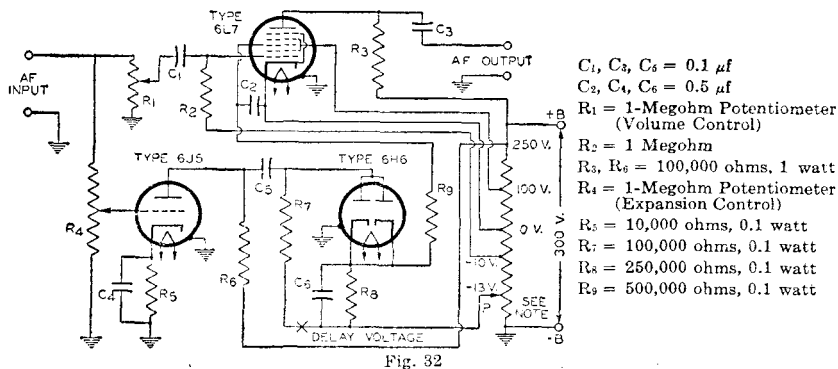

A volume expander circuit is shown in Fig. 32. In this circuit, the gain of the 6L7 as an audio amplifier can be varied by changing the bias on grid No. 3. When the bias on grid No. 3 is made less negative, the gain of the 6L7 increases. The signal to be amplified is applied to grid No. 1 of the 6L7 and is amplified by the 6L7. The signal is also applied to the grid of the 6J5, is amplified by the 6J5, and is rectified by the 6H6. The rectified voltage developed across  $R_8$ , the load resistor of the 6H6, is applied as a positive bias voltage to grid No. 3 of the 6L7. Then, when the amplitude of the signal input increases, the voltage across  $R_8$  increases, and the bias on grid No. 3 of the 6L7 is made less negative. Because this reduction in bias increases the gain of the 6L7, the gain of the amplifier increases with increase in signal amplitude and thus produces volume expansion of the signal. The voltage gain of the expander varies from 5 to 20.

Grid No. 1 of the 6L7 is a variable-mu grid and, therefore, will produce distortion if the input signal voltage is too large. For that reason, the signal input to the 6L7 should not exceed a peak value of 1 volt. This value is of the same order as the voltage obtainable from a magnetic phonograph pick-up. The no-signal bias voltage on grid No. 3 is controlled by adjustment of contact P. This contact should be adjusted initially to give a no-signal plate current of 0.15 milliamperes in the 6L7. No further adjustment of contact P is required if the same 6L7 is always used. If it is desired to delay volume expansion until the signal input reaches a certain amplitude, the delay voltage can be inserted as a negative bias on the 6H6 plates at the point marked X in the diagram. All terminal points on the power-supply voltage divider should be adequately bypassed.

A phase inverter is a circuit used to provide resistance coupling between the output of a single-tube stage and the input of a push-pull stage. The necessity for a phase inverter arises because the signal-voltage inputs to the grids of a push-pull stage must be 180 degrees out of phase and approximately equal in amplitude

with respect to each other. Thus, when the signal voltage input to a push-pull stage swings the control grid of one tube in a positive direction, it should swing the other grid in a negative direction by a similar amount. With transformer coupling between stages, the out-of-phase input voltage to the push-pull stage is supplied by means of the center-tapped secondary. With resistance coupling, the out-of-phase input voltage is obtained by means of the inverter action of a tube.

Fig. 33 shows a push-pull power amplifier, resistance-coupled by means of a phase-inverter circuit to a single-stage triode  $T_1$ . Phase inversion in this circuit is provided by triode  $T_2$ . The output voltage of  $T_1$  is applied to the grid of  $T_3$ . A portion of the output voltage of  $T_1$  is also applied through the resistors  $R_3$  and  $R_5$  to the grid of  $T_2$ . The output voltage of  $T_2$  is applied to the grid of  $T_4$ . When the

output voltage of  $T_1$  swings in the positive direction, the plate current of  $T_2$  increases. This action increases the voltage drop across the plate resistor  $R_2$  and swings the plate of  $T_2$  in the negative direction. Thus, when the output voltage of  $T_1$  swings positive, the output voltage of  $T_2$  swings negative and is, therefore,  $180^\circ$  out of phase with the output voltage of  $T_1$ . In order to obtain equal voltages at  $E_a$  and  $E_b$ ,  $(R_3 + R_5) / R_5$  should equal the voltage gain of  $T_2$ . Under the conditions

where a twin-type tube or two tubes having the same characteristics are used at  $T_1$  and  $T_2$ ,  $R_4$  should be equal to the sum of  $R_3$  and  $R_5$ . The ratio of  $R_3 + R_5$  to  $R_5$  should be the same as the voltage gain ratio of  $T_2$  in order to apply the correct value of signal voltage to  $T_2$ . The value of  $R_5$  is, therefore, equal to  $R_4$  divided by the voltage gain of  $T_2$ ;  $R_3$  is equal to  $R_4$  minus  $R_5$ . Values of  $R_1$ ,  $R_2$ ,  $R_3$  plus  $R_5$ , and  $R_4$  may be taken from the chart in the RESISTANCE-COUPLED AMPLIFIER SECTION. In the practical application of this circuit, it is convenient to use a twin-triode tube combining  $T_1$  and  $T_2$ . A phase-inverter circuit using a 12SC7 is shown in the CIRCUIT SECTION.

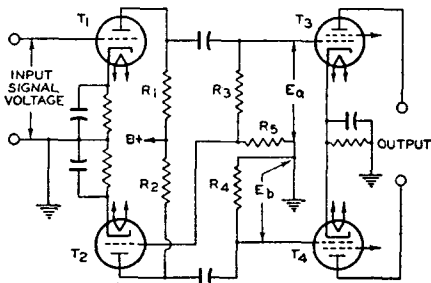

Fig. 33

An amplifier may also be used as a limiter. One use of a limiter is in receivers designed for the reception of frequency-modulated signals. The limiter in FM receivers has the function of eliminating amplitude variations from the input to the detector. Because in an FM system, amplitude variations are primarily the result of noise disturbances, the use of a limiter prevents such disturbances from being reproduced in the audio output. The limiter usually follows the last if stage where it can minimize the effects of disturbances coming in on the rf carrier and those produced locally.

The limiter is essentially an if voltage amplifier designed for saturated operation. Saturated operation means that an increase in signal voltage above a certain value produces very little increase in plate current. A signal voltage which is never less than sufficient to cause saturation of the limiter, even on weak signals, is supplied to the limiter input by the preceding stages. Any change in amplitude, therefore, such as might be produced by noise voltage fluctuation, is not reproduced in the limiter output. The limiting action, of course, does not interfere with the reproduction of frequency variations. Plate-current saturation of the limiter may be obtained by the use of grid-resistor-and-capacitor bias with plate and screen voltages which are low compared with customary if-amplifier operating conditions. As a result of these design features, the limiter is able to maintain its output voltage at a constant amplitude over a wide range of input-signal voltage variations. The output of the limiter is frequency-modulated if voltage, the mean frequency

of which is that of the if amplifier. This voltage is impressed on the input of the detector.

The reception of FM signals without serious distortion requires that the response of the receiver be such that satisfactory amplification of the signal is provided over the entire range of frequency deviation from the mean frequency. Since the frequency at any instant depends on the modulation at that instant, it follows that excessive attenuation toward the edges of the band, in the rf or if stages, will cause distortion. This means that, in a high-fidelity receiver, the amplifiers must be capable of amplifying, for the maximum permissible frequency deviation of 75 kilocycles, a band 150 kilocycles wide. Suitable tubes for this purpose are the 6BA6 and 6BJ6.

## RECTIFICATION

The rectifying action of a diode finds an important application in supplying a receiver with dc power from an ac line. A typical arrangement for this application includes a rectifier tube, a filter, and a voltage divider. The rectifying action of the tube is explained briefly under **Diodes**, in the **ELECTRONS, ELECTRODES, AND ELECTRON TUBE SECTION**. The function of a filter is to smooth out the ripple of the tube output, as indicated in Fig. 34. The action of the filter is explained in **ELECTRON TUBE INSTALLATION SECTION** under **Filters**. The voltage divider is used to cut down the output voltage to the values required by the plates, screens, and grids of the tubes in the receiver.

A half-wave rectifier and a full-wave rectifier circuit are shown in Fig. 35. In the half-wave circuit, current flows through the rectifier tube to the filter on every other half-cycle of the ac input voltage when the plate is positive with respect to the cathode. In the full-wave circuit, current flows to the filter on every half-cycle, through plate No. 1 on one half-cycle when plate No. 1 is positive with respect to the cathode, and through plate No. 2 on the next half-cycle when plate No. 2 is positive with respect to the cathode. Because the current flow to the filter is more uniform in the full-wave circuit than in the half-wave circuit, the output of the full-wave circuit requires less filtering. Rectifier operating information and circuits are given under each rectifier tube type and in the **CIRCUIT SECTION**, respectively.

**Parallel operation** of rectifier tubes furnishes an output current greater than that obtainable with the use of one tube. For example, when two full-wave rectifier tubes are connected in parallel, the plates of each tube are connected together and each tube acts as a half-wave rectifier. The allowable voltage and load conditions per tube are the same as for full-wave service but the total load-handling capability of the complete rectifier

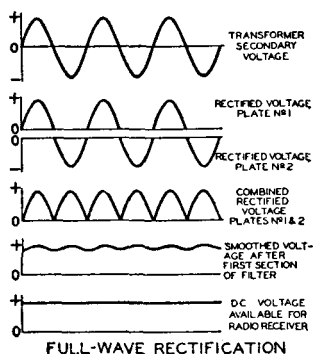

Fig. 34

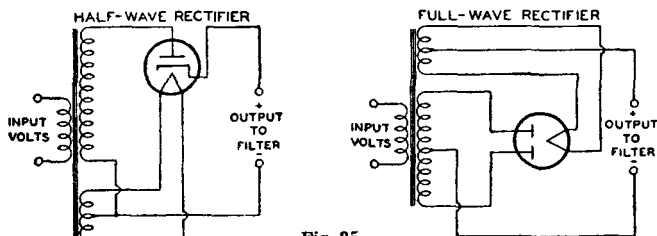

Fig. 35

is approximately doubled. When mercury-vapor rectifier tubes are connected in parallel, a stabilizing resistor of 50 to 100 ohms should be connected in series with each plate lead in order that each tube will carry an equal share of the load. The value of the resistor to be used will depend on the amount of plate current that passes through the rectifier. Low plate current requires a high value; high plate current, a low value. When the plates of mercury-vapor rectifier tubes are connected in parallel, the corresponding filament leads should be similarly connected. Otherwise, the tube drops will be considerably unbalanced and larger stabilizing resistors will be required. Two or more vacuum rectifier tubes can also be connected in parallel to give correspondingly higher output current and, as a result of paralleling their internal resistances, give somewhat increased voltage output. With vacuum types, stabilizing resistors may or may not be necessary depending on the tube type and the circuit.

A voltage-doubler circuit of simple form is shown in Fig. 36. The circuit derives its name from the fact that its dc voltage output can be as high as twice the peak value of ac input. Basically, a voltage doubler is a rectifier circuit arranged so that the output voltages of two half-wave rectifiers are in series.

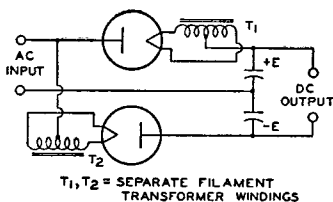

Fig. 36

The action of a voltage doubler is briefly as follows. On the positive half-cycle of the ac input, that is, when the upper side of the ac input line is positive with respect to the lower side, the upper diode passes current and feeds a positive charge into the upper capacitor. As positive charge accumulates on the upper plate of the capacitor, a positive voltage builds up across the capacitor. On the next half-cycle of

the ac input, when the upper side of the line is negative with respect to the lower side, the lower diode passes current so that a negative voltage builds up across the lower capacitor. As long as no current is drawn at the output terminals from the capacitor, each capacitor can charge up to a voltage of magnitude  $E$ , the peak value of the ac input. It can be seen from the diagram that with a voltage of  $+E$  on one capacitor and  $-E$  on the other, the total voltage across the capacitors is  $2E$ . Thus the voltage doubler supplies a no-load dc output voltage twice as large as the peak ac input voltage. When current is drawn at the output terminals by the load, the output voltage drops below  $2E$  by an amount that depends on the magnitude of the load current and the capacitance of the capacitors. The arrangement shown in Fig. 36 is called a full-wave voltage doubler because each rectifier passes current to the load on each half of the ac input cycle.

Two rectifier types especially designed for use as voltage doublers are the 25Z6-GT and 117Z6-GT. These tubes combine two separate diodes in one tube. As voltage doublers, the tubes are used in "transformerless" receivers. In these receivers, the heaters of all tubes in the set are connected in series with a voltage-dropping resistor across the line. The connections for the heater supply and the voltage-doubling circuit are shown in Figs. 37 and 38.

With the full-wave voltage-doubler circuit in Fig. 37, it will be noted that the dc load circuit can not be connected to ground or to one side of the ac supply line. This presents certain disadvantages when the heaters of all the tubes in the set are connected in series with a resistance across the ac line. Such a circuit arrangement may cause hum because of the high ac potential between the heaters and cathodes of the tubes. The circuit in Fig. 38 overcomes this difficulty by making one side of the ac line common with the negative side of the dc load circuit. In this circuit, one half of the tube is used to charge a capacitor which, on the following half cycle, discharges in series with the line voltage through the other half of the tube. This circuit is called a half-wave voltage doubler because rectified current

flows to the load only on alternate halves of the ac input cycle. The voltage regulation of this arrangement is somewhat poorer than that of the full-wave voltage doubler.

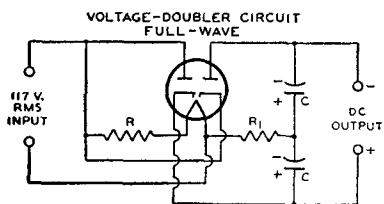

Fig. 37

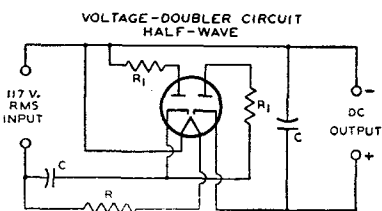

Fig. 38

R = HEATERS OF OTHER TUBES IN SERIES WITH VOLTAGE-DROPPING RESISTOR  
 $R_1$  = PROTECTIVE RESISTOR

### DETECTION

When speech or music is transmitted from a radio station, the station radiates a radio-frequency (rf) wave which is of either of two general types. In one type, the wave is said to be amplitude modulated when its frequency remains constant and the amplitude is varied. In the other type, the wave is said to be frequency modulated when its amplitude remains essentially constant but its frequency is varied. In either case, the varying component is modulated in accordance with the audio frequencies (af) of the speech or music being transmitted.

The function of the receiver is to reproduce the original af modulating wave from the modulated rf wave. The receiver stage in which this function is performed is called the demodulator or detector stage.

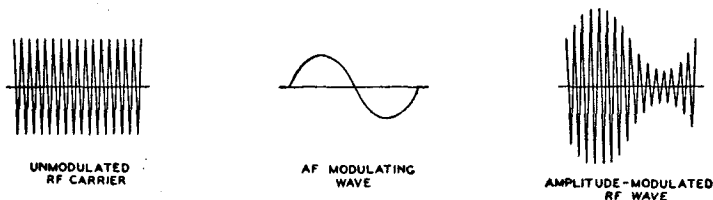

Fig. 39

The effect of amplitude modulation on the waveform of the rf wave is shown in Fig. 39. There are three different basic circuits used for the detection of amplitude-modulated waves: the diode detector, the grid-bias detector, and the grid-resistor detector. These circuits are alike in that they eliminate, either partially or completely, alternate half-cycles of the rf wave. With alternate half-cycles removed, the audio variations of the other half-cycles can be amplified to drive headphones or a loudspeaker.

A diode-detector circuit is shown in Fig. 40. The action of this circuit when a modulated rf wave is applied is illustrated by Fig. 41. The rf voltage applied to the circuit is shown in light line; the output voltage across capacitor C is shown in heavy line. Between points (a) and (b) on the first positive half-cycle of the applied rf voltage, capacitor C charges up to the peak value of the rf voltage. Then as the applied rf voltage falls away from its peak value, the capacitor holds the cathode at a potential more positive than the voltage applied to the anode. The capacitor thus temporarily cuts off current through the diode. While the

diode current is cut off, the capacitor discharges from (b) to (c) through the diode load resistor R. When the rf voltage on the anode rises high enough to exceed the potential at which the capacitor holds the cathode, current flows again and

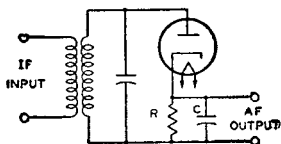

Fig. 40

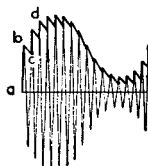

Fig. 41

the capacitor charges up to the peak value of the second positive half-cycle at (d). In this way, the voltage across the capacitor follows the peak value of the applied rf voltage and reproduces the af modulation. The curve for voltage across the capacitor, as drawn in Fig. 41, is somewhat jagged. However, this jaggedness, which represents an rf component in the voltage across the capacitor, is exaggerated in the drawing. In an actual circuit the rf component of the voltage across the capacitor is negligible. Hence, when the voltage across the capacitor is amplified, the output of the amplifier reproduces the speech or music originating at the transmitting station.

Another way to describe the action of a diode detector is to consider the circuit as a half-wave rectifier. When the rf signal on the plate swings positive, the tube conducts and the rectified current flows through the load resistance R. Because the dc output voltage of a rectifier depends on the voltage of the ac input, the dc voltage across C varies in accordance with the amplitude of the rf carrier and thus reproduces the af signal. Capacitor C should be large enough to smooth out rf or if variations but should not be so large as to affect the audio variations. Two diodes can be connected in a circuit similar to a full-wave rectifier to give full-wave detection. However, in practice, the advantages of this connection generally do not justify the extra circuit complication.

The diode method of detection has the advantage over other methods in that it produces less distortion. The reason is that the dynamic characteristics of a diode can be made more linear than that of other detectors. A diode has the disadvantages that it does not amplify the signal, and that it draws current from the input circuit and therefore reduces the selectivity of the input circuit. However, because the diode method of detection produces less distortion and because it permits the use of simple avc circuits without the necessity for an additional voltage supply, the diode method of detection is most widely used in broadcast receivers.

A typical diode-detector circuit using a twin-diode triode tube is shown in Fig. 42. Both diodes are connected together.  $R_1$  is the diode load resistor. A portion of the af voltage developed across this resistor is applied to the triode grid through the volume control  $R_3$ . In a typical circuit, resistor  $R_1$  may be tapped so that five-sixths of the total af voltage across  $R_1$  is applied to the volume control. This tapped connection reduces the af voltage output of the detector circuit slightly but it reduces audio distortion and improves the rf filtering. DC bias for the triode section is provided by the cathode-bias resistor  $R_2$  and the audio bypass capacitor  $C_3$ . The function of capacitor  $C_2$  is to block the dc bias of the cathode from the grid. The function of capacitor  $C_4$  is to bypass any rf voltage on the grid to cathode. A twin-diode pentode may also be used in this circuit. With a pentode, the af output should be resistance-coupled rather than transformer-coupled.

Another diode-detector circuit, called a diode-biased circuit, is shown in Fig. 43. In this circuit, the triode grid is connected directly to a tap on the diode load resistor. When an rf signal voltage is applied to the diode, the dc voltage at the tap supplies bias to the triode grid. When the rf signal is modulated, the

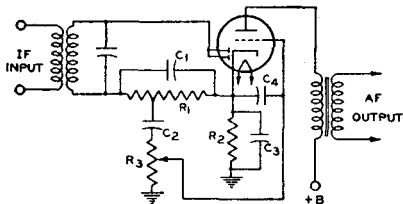

Fig. 42

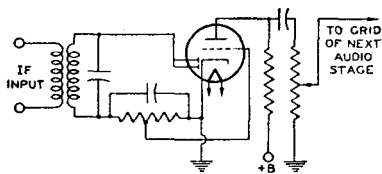

Fig. 43

af voltage at the tap is applied to the grid and is amplified by the triode. The advantage of this circuit over the self-biased arrangement shown in Fig. 42 is that the diode-biased circuit does not employ a capacitor between the grid and the diode load resistor, and consequently does not produce as much distortion of a signal having a high percentage of modulation.

However, there are restrictions on the use of the diode-biased circuit. Because the bias voltage on the triode depends on the average amplitude of the rf voltage applied to the diode, the average amplitude of the voltage applied to the diode should be constant for all values of signal strength at the antenna. Otherwise there will be different values of bias on the triode grid for different signal strengths and the triode will produce distortion. Since there is no bias applied to the diode-biased triode when no rf voltage is applied to the diode, sufficient resistance should be included in the plate circuit of the triode to limit its zero-bias plate current to a safe value. These restrictions mean, in practice, that the receiver should have a separate-channel avc system. With such an avc system, the average amplitude of the signal voltage applied to the diode can be held within very close limits for all values of signal strength at the antenna. The tube used in a diode-biased circuit should be one which operates at a fairly large value of bias voltage. The variations in bias voltage are then a small percentage of the total bias and hence produce small distortion. Tubes taking a fairly large bias voltage are types such as the 6BF6 or 6ST7 having a medium-mu triode. Tube types having a high-mu triode or a pentode should not be used in a diode-biased circuit.

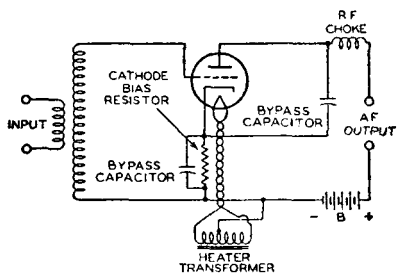

Fig. 41

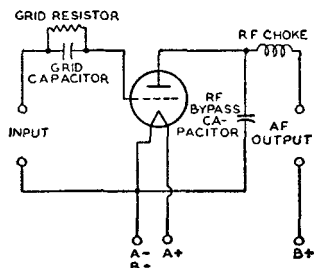

Fig. 45

A **grid-bias detector** circuit is shown in Fig. 44. In this circuit, the grid is biased almost to cutoff, i.e., operated so that the plate current with zero signal is practically zero. The bias voltage can be obtained from a cathode-bias resistor, a C-battery, or a bleeder tap. Because of the high negative bias, only the positive half-cycles of the rf signal are amplified by the tube. The signal is, therefore, detected in the plate circuit. The advantages of this method of detection are that it amplifies the signal, besides detecting it, and that it does not draw current from the input circuit and therefore does not lower the selectivity of the input circuit.

The **grid-resistor-and-capacitor method**, illustrated by Fig. 45, is somewhat more sensitive than the grid-bias method and gives its best results on weak signals. In this circuit, there is no negative dc bias voltage applied to the grid. Hence, on the positive half-cycles of the rf signal, current flows from grid to cathode. The grid and cathode thus act as a diode detector, with the grid resistor as the diode load resistor and the grid capacitor as the rf bypass capacitor. The voltage across the capacitor then reproduces the af modulation in the same manner as has been explained for the diode detector. This voltage appears between the grid and cathode and is therefore amplified in the plate circuit. The output voltage thus reproduces the original af signal.

In this detector circuit, the use of a high-resistance grid resistor increases selectivity and sensitivity. However, improved af response and stability are obtained with lower values of grid-resistor resistance. This detector circuit has the advantage that it amplifies the signal but has the disadvantage that it draws current from the input circuit and therefore lowers the selectivity of the input circuit.

The effect of **frequency modulation** on the waveform of the rf wave is shown in Fig. 46. In this type of transmission, the frequency of the rf wave deviates from

a mean value, at an af rate depending on the modulation, by an amount that is determined in the transmitter and is proportional to the amplitude of the af modulation signal. For this type of modulation, a detector is required to discriminate between deviations above and below the mean frequency and to translate those deviations into a voltage whose amplitude varies at audio frequencies. Since the deviations occur at an audio frequency, the process is one of demodulation, and the degree of frequency deviation determines the amplitude of the demodulated (af) voltage.

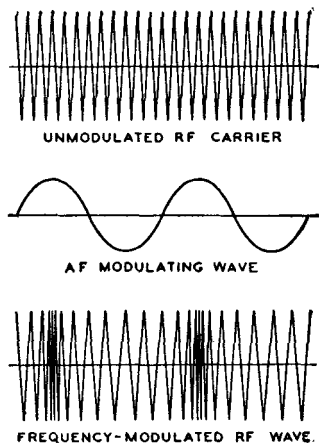

Fig. 46

A simple circuit for converting frequency variations to amplitude variations is a circuit which is tuned so that the mean radio frequency is on one slope of its resonance characteristic, as at A of Fig. 47. With modulation, the frequency swings between B and C, and the voltage developed across the circuit varies at the modulating rate. In order that no distortion will be introduced in this circuit, the frequency swing must be restricted to the portion of the slope which is effectively straight. Since this portion is very short, the voltage developed is low. Because of these limitations, this circuit is not commonly used but it serves to illustrate the principle.

The faults of the simple circuit are overcome in a push-pull arrangement, sometimes called a **discriminator circuit**, such as that shown in Fig. 48. Because



of the phase relationships between the primary and each half of the secondary of the input transformer (each half of the secondary is connected in series with the

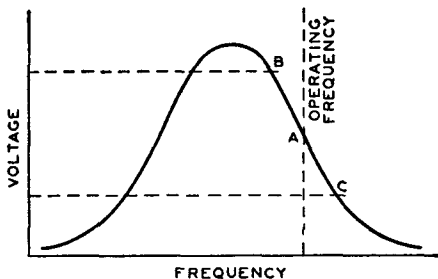

Fig. 47

primary through capacitor  $C_2$ ), the rf voltages applied to the diodes become unequal as the rf signal swings from the resonant frequency in each direction. Since the swing occurs at audio frequencies (determined by the af modulation), the voltage developed across the diode load resistors,  $R_1$  and  $R_2$  connected in series, varies at

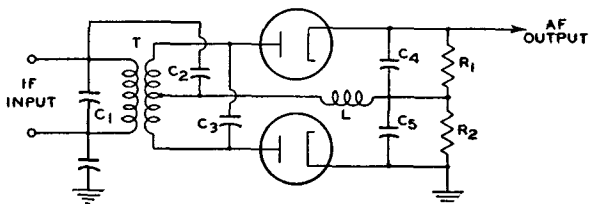

Fig. 48

audio frequencies. The output voltage depends on the difference in amplitude of the voltages developed across  $R_1$  and  $R_2$ . These voltages are equal and of opposite sign when the rf carrier is not modulated and the output is, therefore, zero. When modulation is applied, the output voltage varies as indicated in Fig. 49.

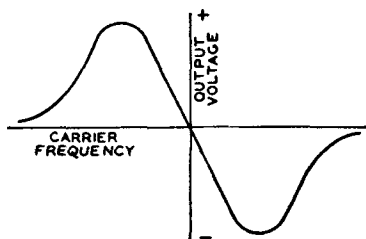

Fig. 49

Because this type of FM detector is sensitive to amplitude variations in the rf carrier, a limiter stage is frequently used to remove most of the amplitude modulation from the carrier. (See Limiters under Amplification.)

Another form of detector for frequency-modulated waves is called a **ratio detector**. This FM detector, unlike the previous one which responds to a difference in voltage, responds only to changes in the ratio of the voltage across the two diodes (Fig. 50) and is, therefore, insensitive to changes in the differences in the voltages due to amplitude modulation of the rf carrier.

The basic ratio detector is given in Fig. 50. The plate load for the final intermediate-frequency-amplifier stage is the parallel resonant circuit consisting of  $C_1$  and the primary transformer T. The tuning and coupling of the transformer is practically the same as in the previous circuit and, therefore, the rf voltages applied to the diodes depend upon how much the rf signal swings from the resonant frequency in each direction. At this point the similarity ends.

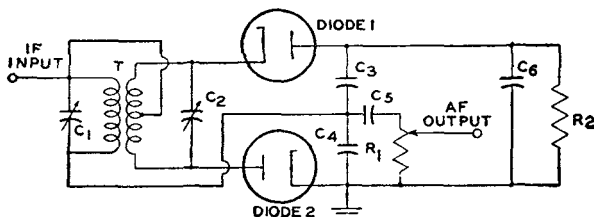

Fig. 50

Diode 1,  $R_2$ , and diode 2 complete a series circuit fed by the secondary of the transformer T. The two diodes are connected in series so that they conduct on the same rf half-cycle. The rectified current through  $R_2$  causes a negative voltage to appear at the plate of diode 1. Because  $C_6$  is large, this negative voltage at the plate of diode 1 remains constant even at the lowest audio frequencies to be reproduced. The rectified voltage across  $C_3$  is proportional to the voltage across diode 1, and the rectified voltage across  $C_4$  is proportional to the voltage across diode 2. Since the voltages across the two diodes differ according to the instantaneous frequency of the carrier, the voltages across  $C_3$  and  $C_4$  differ proportionately, the voltage across  $C_3$  being the larger of the two voltages at carrier frequencies below the intermediate frequency and the smaller at frequencies above the intermediate frequency. These voltages across  $C_3$  and  $C_4$  are additive and their sum is fixed by the constant voltage across  $C_6$ . Therefore, while the ratio of these voltages varies at an audio rate, their sum is always constant. The voltage across  $C_4$  varies at an audio rate when a frequency-modulated rf carrier is applied to the ratio detector; this audio voltage is extracted and fed to the audio amplifier. For a complete circuit utilizing this type of detector, refer to the CIRCUIT SECTION.

### AUTOMATIC VOLUME CONTROL

The chief purposes of automatic volume control in a receiver are to prevent fluctuations in loudspeaker volume when the signal at the antenna is fading in and out, and to prevent an unpleasant blast of loud volume when the set is tuned from

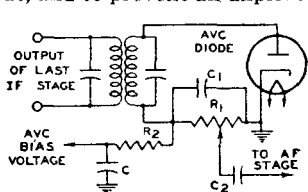

Fig. 51

a weak signal, for which the volume control has been turned up high, to a strong signal. To accomplish these purposes, an automatic volume control circuit regulates the receiver's rf and if gain so that this gain is less for a strong signal than for a weak signal. In this way, when the signal strength at the antenna changes, the avc circuit reduces the resultant change in the voltage output of the last if stage and consequently reduces the change in the speaker's output volume.

The avc circuit reduces the rf and if gain for a strong signal usually by increasing the negative bias of the rf, if, and frequency-mixer stages when the signal increases. A simple avc circuit is shown in Fig. 51. On each positive half-cycle of the signal voltage, when the diode plate is positive with respect to the cathode, the diode passes current. Because of the flow of diode current through  $R_1$ , there is a

voltage drop across  $R_1$  which makes the left end of  $R_1$  negative with respect to ground. This voltage drop across  $R_1$  is applied, through the filter  $R_2$  and  $C$ , as negative bias on the grids of the preceding stages. Then, when the signal strength at the antenna increases, the signal applied to the avc diode increases, the voltage drop across  $R_1$  increases, the negative bias voltage applied to the rf and if stages increases, and the gain of the rf and if stages is decreased. Thus the increase in signal strength at the antenna does not produce as much increase in the output of the last if stage as it would produce without avc. When the signal strength at the antenna decreases from a previous steady value, the avc circuit acts, of course, in the reverse direction, applying less negative bias, permitting the rf and if gain to increase, and thus reducing the decrease in the signal output of the last if stage. In this way, when the signal strength at the antenna changes, the avc circuit acts to prevent change in the output of the last if stage, and thus acts to prevent change in loudspeaker volume.

The filter,  $C$  and  $R_2$ , prevents the avc voltage from varying at audio frequency. The filter is necessary because the voltage drop across  $R_1$  varies with the modulation of the carrier being received. If avc voltage were taken directly from  $R_1$  without filtering, the audio variations in avc voltage would vary the receiver's gain so as to smooth out the modulation of the carrier. To avoid this effect, the avc voltage is taken from the capacitor  $C$ . Because of the resistance  $R_2$  in series with  $C$ , the capacitor  $C$  can charge and discharge at only a comparatively slow rate. The avc voltage therefore cannot vary at frequencies as high as the audio range but can vary at frequencies high enough to compensate for most fading. Thus the filter permits the avc circuit to smooth out variations in signal due to fading, but prevents the circuit from smoothing out audio modulation.

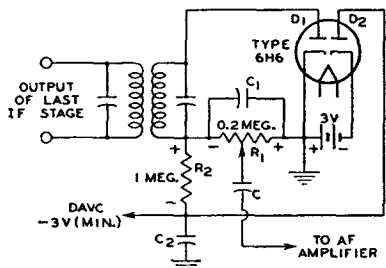

Fig. 52

It will be seen that an avc circuit and a diode-detector circuit are much alike. It is therefore convenient in a receiver to combine the detector and the avc diode in a single stage. Examples of how these functions are combined in receivers are shown in **CIRCUIT SECTION**.

It will be seen that an avc circuit and a diode-detector circuit are much alike. It is therefore convenient in a receiver to combine the detector and the avc diode in a single stage. Examples of how these functions are combined in receivers are shown in **CIRCUIT SECTION**.

In the circuit shown in Fig. 51, a certain amount of avc negative bias is applied to the preceding stages on a weak signal. Since it may be desirable to maintain the receiver's rf and if gain at the maximum possible value for a weak signal, avc circuits are designed in some cases to apply no avc bias until the signal strength exceeds a certain value. These avc circuits are known as delayed avc, or, dave circuits. A dave circuit is shown in Fig. 52. In this circuit, the diode section  $D_1$  of the 6H6 acts as detector and avc diode.  $R_1$  is the diode load resistor and  $R_2$  and  $C_2$  are the avc filter. Because the cathode of diode  $D_2$  is returned through a fixed supply of  $-3$  volts to the cathode of  $D_1$ , a dc current flows through  $R_1$  and  $R_2$  in series with  $D_2$ . The voltage drop caused by this current places the avc lead at approximately  $-3$  volts (less the negligible drop through  $D_2$ ). When the average amplitude of the rectified signal developed across  $R_1$  does not exceed 3 volts, the avc lead remains at  $-3$  volts. Hence, for signals not strong enough to develop 3 volts across  $R_1$ , the bias applied to the controlled tubes stays constant at a value giving high sensitivity. However, when the average amplitude of rectified signal voltage across  $R_1$  exceeds 3 volts, the plate of diode  $D_2$  becomes more negative than the cathode of  $D_2$  and current flow in diode  $D_2$  ceases. The potential of the avc lead is then controlled by the voltage developed across  $R_1$ . Therefore, with further increase in signal strength, the avc circuit applies an increasing avc bias voltage to the controlled stages. In this way, the circuit regulates the receiver's

gain for strong signals, but permits the gain to stay constant at a maximum value for weak signals.

It can be seen in Fig. 52 that a portion of the -3 volts delay voltage is applied to the plate of the detector diode  $D_1$ , this portion being approximately equal to  $R_1/(R_1 + R_2)$  times -3 volts. Hence, with the circuit constants as shown, the detector plate is made negative with respect to its cathode by approximately one-half volt. However, this voltage does not interfere with detection because it is not large enough to prevent current flow in the tube.

### TUNING INDICATION WITH ELECTRON-RAY TUBES

Electron-ray tubes are designed to indicate visually by means of a fluorescent target the effects of a change in controlling voltage. One application of them is as tuning indicators in radio receivers. Types such as the 6U5, 6E5, and the 6AB5/6N5

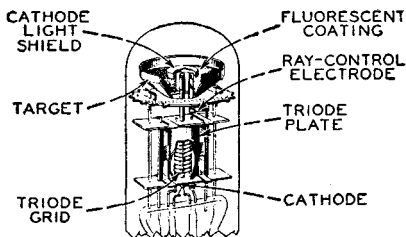

Fig. 53

contain two main parts: (1) a triode which operates as a dc amplifier and (2) an electron-ray indicator which is located in the bulb as shown in Fig. 53. The target is operated at a positive voltage and therefore attracts electrons from the cathode. When the electrons strike the target they produce a glow on the fluorescent coating of the target. Under these conditions, the target appears as a ring of light.

A ray-control electrode is mounted between the cathode and target. When the potential of this electrode is less positive than the target, electrons flowing to the target are repelled by the electrostatic field of the electrode, and do not reach that portion of the target behind the electrode. Because the target does not glow where it is shielded from electrons, the control electrode casts a shadow on the glowing target. The extent of this shadow varies from approximately  $100^\circ$  of the target when the control electrode is much more negative than the target to  $0^\circ$  when the control electrode is at approximately the same potential as the target.

In the application of the electron-ray tube, the potential of the control electrode is determined by the voltage on the grid of the triode section, as can be seen in Fig. 54. The flow of the triode plate current through resistor  $R$  produces a voltage drop which determines the potential of the control electrode. When the voltage of the triode grid changes in the positive direction, plate current increases, the potential of the control electrode goes down because of the increased drop across  $R$ , and the shadow angle widens. When the potential of the triode grid changes in the negative direction, the shadow angle narrows.

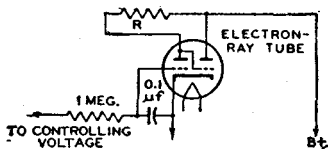

Fig. 54

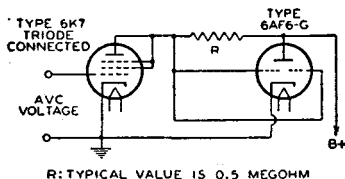
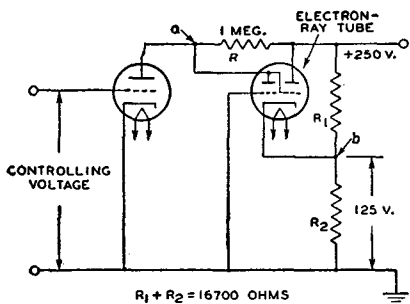

Fig. 55

Another type of indicator tube is the 6AF6-G. This tube contains only an indicator unit but employs two ray-control electrodes mounted on opposite sides

of the cathode and connected to individual base pins. It employs an external dc amplifier. See Fig. 55. Thus, two symmetrically opposite shadow angles may be obtained by connecting the two ray-control electrodes together; or, two unlike patterns may be obtained by individual connection of each ray-control electrode to its respective amplifier.

In radio receivers, avc voltage is applied to the grid of the dc amplifier. Since avc voltage is at maximum when the set is tuned to give maximum response to a station, the shadow angle is at minimum when the receiver is tuned to resonance with the desired station.



The sensitivity indication of electron-ray tubes can be increased by using a separate dc amplifier to control the action of the ray-control electrode in the tuning indicator tube. This arrangement increases the maximum shadow angle from the usual  $100^\circ$  to approximately  $180^\circ$ . A circuit for obtaining wide-angle tuning is shown in Fig. 56.

The choice between electron-ray tubes depends on the avc characteristic of the receiver. The 6E5 contains a sharp-cutoff triode which closes the shadow angle on a comparatively low value of avc voltage. The 6AB5/6N5 and 6U5 each have a remote-cutoff triode which closes the shadow on a larger value of avc voltage than the 6E5. The 6AF6-G may be used in conjunction with dc amplifier tubes having either remote- or sharp-cutoff characteristics.

## OSCILLATION

As an oscillator, an electron tube can be employed to generate a continuously alternating voltage. In present-day radio broadcast receivers, this application is limited practically to superheterodyne receivers for supplying the heterodyning frequency. Several circuits (represented in Figs. 57 and 58) may be utilized, but they all depend on feeding more energy from the plate circuit to the grid circuit than is required to equal the power loss in the grid circuit. Feedback may be

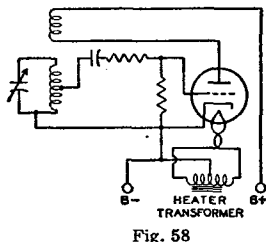
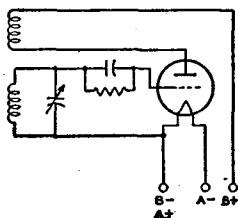

produced by electrostatic or electromagnetic coupling between the grid and plate circuits. When sufficient energy is fed back to more than compensate for the loss in the grid circuit, the tube will oscillate. The action consists of regular surges of power between the plate and the grid circuit at a frequency dependent on the circuit constants of inductance and capacitance. By proper choice of these values, the frequency may be adjusted over a very wide range.

The **relaxation oscillator** is an oscillator with a non-sinusoidal output. It differs from the preceding type in that the oscillations are obtained by abruptly

releasing energy previously stored in the electric field of a capacitor. A **multivibrator** is a special type of relaxation oscillator used in television receivers and other electronic applications. A multivibrator may be considered as a two-stage resistance-coupled amplifier in which the output of each tube is coupled into the input of the other tube in order to sustain oscillations.

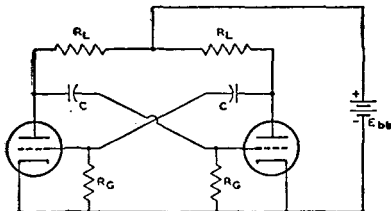

Fig. 59

Fig. 59 is a basic multivibrator circuit of the free-running type. In this circuit, oscillations are maintained by the alternate shifting of conduction from one tube to the other. The cycle starts with one tube usually at zero bias and the other at cutoff or beyond. Each tube introduces a 180° phase shift so that the energy fed back has the phase relation necessary to sustain oscillation. The frequency of oscillation is determined primarily by the constants of the resistance-capacitance coupling circuits.

### FREQUENCY CONVERSION

Frequency conversion is used in superheterodyne receivers to change the frequency of the rf signal to an intermediate frequency. To perform this change in frequency, a frequency-converting device consisting of an oscillator and a frequency

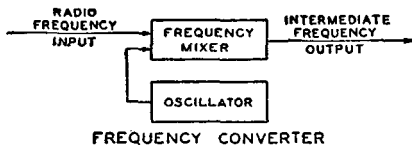

Fig. 60

mixer is employed. In such a device, shown diagrammatically in Fig. 60, two voltages of different frequency, the rf signal voltage and the voltage generated by the oscillator, are applied to the input of the frequency mixer. These voltages beat, or heterodyne, within the mixer tube to produce a plate current having, in addition to the frequencies of the input voltages, numerous sum and difference frequencies. The output circuit of the mixer stage is provided with a tuned circuit which is adjusted to select only one beat frequency, i.e., the frequency equal to the difference between the signal frequency and the oscillator frequency. The selected output frequency is known as the intermediate frequency, or if. The output frequency of the mixer tube is kept constant for all values of signal frequency by tuning the oscillator to the proper frequency.

Important advantages gained in a receiver by the conversion of signal frequency to a fixed intermediate frequency are high selectivity with few tuning stages and a high, as well as stable, overall gain for the receiver.

Several methods of frequency conversion for superheterodyne receivers are of interest. These methods are alike in that they employ a frequency-mixer tube in which plate current is varied at a combination frequency of the signal frequency and the oscillator frequency. These variations in plate current produce across the tuned plate load a voltage of the desired intermediate frequency. The methods differ in the types of tubes employed and in the means of supplying input voltages to the mixer tube.

A method widely used before the availability of tubes especially designed for frequency-conversion service and currently used in many FM, television, and standard broadcast receivers, employs as mixer tube either a triode, a tetrode, or a pentode, in which oscillator voltage and signal voltage are applied to the same grid. In this method, coupling between the oscillator and mixer circuits is obtained by means of inductance or capacitance.

A second method employs a tube having an oscillator and frequency mixer combined in the same envelope. In one form of such a tube, coupling between the two units is obtained by means of the electron stream within the tube. One arrangement of the electrodes for this type is shown in Fig. 61. Since five grids are used, the tube is called a pentagrid converter. Grids No. 1, No. 2, and the cathode are connected to an external circuit to act as a triode oscillator. Grid No. 1 is the grid of the oscillator and grid No. 2 is the anode. These and the cathode can be considered as a composite cathode which supplies to the rest of the tube an electron stream that varies at the oscillator frequency. This varying electron stream is further controlled by the rf signal voltage on grid No. 4. Thus, the variations in plate current are due to the combination of the oscillator and the signal frequencies. The purpose of grids No. 3 and No. 5, which are connected together within the tube, is to accelerate the electron stream and to shield grid No. 4 electrostatically from the other electrodes. The 6A8 is an example of a pentagrid-converter type.

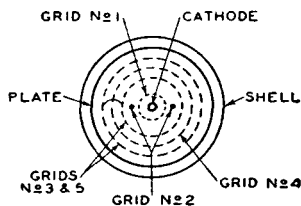

Fig. 61

Pentagrid-converter tubes of this design are good frequency-converting devices at medium frequencies but their performance is better at the lower frequencies than at the high ones. This is because the output of the oscillator drops off as the frequency is raised and because certain undesirable effects produced by interaction between oscillator and signal sections of the tube increase with frequency. To minimize these effects, several of the pentagrid-converter tubes are designed so that no electrode functions alone as the oscillator anode. In these tubes, grid No. 1 func-

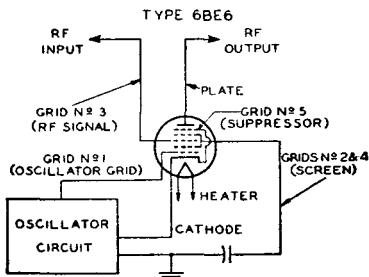

Fig. 62

tions as the oscillator grid, and grid No. 2 is connected within the tube to the screen (grid No. 4). The combined two grids Nos. 2 and 4 shield the signal grid (grid No. 3) and act as the composite anode of the oscillator triode. Grid No. 5 acts as the suppressor. Converter tubes of this type are designed so that the space charge around the cathode is unaffected by electrons from the signal grid. Further-

more, the electrostatic field of the signal grid also has little effect on the space charge. The result is that rf voltage on the signal grid produces little effect on the cathode current. There is, therefore, little detuning of the oscillator by avc bias because changes in avc bias produce little change in oscillator transconductance or in the input capacitance of grid No. 1. Examples of the pentagrid converters discussed in this paragraph are the single-ended types 1R5 and 6BE6. A schematic diagram illustrating the use of the 6BE6 with self-excitation is given in Fig. 62; the 6BE6 may also be used with separate excitation. A complete circuit is shown in the CIRCUIT SECTION.

Another method of frequency conversion utilizes a separate oscillator having its grid connected to the No. 1 grid of a mixer hexode. A tube utilizing this construction is the 6K8 and a top view of its electrode arrangement is shown in Fig. 63. The cathode, triode grid No. 1, and triode plate form the oscillator unit of the tube.

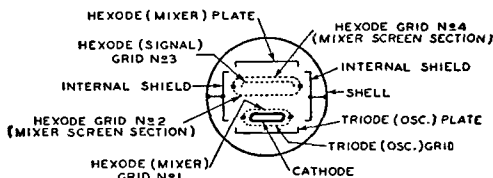

Fig. 63

The cathode, hexode mixer grid (grid No. 1), hexode double-screen (grids Nos. 2 and 4), hexode mixer grid (grid No. 3), and hexode plate constitute the mixer unit. The internal shields are connected to the shell of the tube and act as a suppressor for the hexode unit. The action of the 6K8 in converting a radio-

frequency signal to an intermediate frequency depends on (1) the generation of a local frequency by the triode unit, (2) the transferring of this frequency to the hexode grid No. 1, and (3) the mixing in the hexode unit of this frequency with that of the rf signal applied to the hexode grid No. 3. The 6K8 is not critical to changes in oscillator-plate voltage or signal-grid bias and, therefore, finds important use in all-wave receivers to minimize frequency-shift effects at the higher frequencies.

A further method of frequency conversion employs a tube called a pentagrid mixer. This type has two independent control grids and is used with a separate oscillator tube. RF signal voltage is applied to one of the control grids and oscillator voltage is applied to the other. It follows, therefore, that the variations in plate current are due to the combination of the oscillator and signal frequencies. The arrangement of electrodes in a pentagrid-mixer tube is shown in Fig. 64. The tube contains a heater cathode, five grids, and a plate. Grids Nos. 1 and 3 are control grids. The rf signal voltage is applied to grid No. 1. This grid has a remote-cutoff characteristic and is suited for control by avc bias voltage. The oscillator voltage is applied to grid No. 3. This grid has a sharp-cutoff characteristic and produces a comparatively large effect on plate current for a small amount of oscillator voltage. Grids Nos. 2 and 4 are connected together within the tube. They accelerate the electron stream and shield grid No. 3 electrostatically from the other electrodes. Grid No. 5, connected within the tube to the cathode, functions similarly to the suppressor in a pentode. The 6L7 and 6L7-G are pentagrid-mixer tubes.

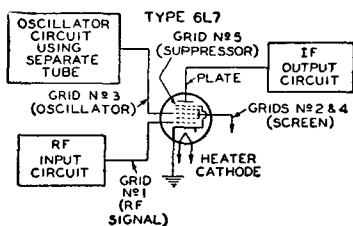

Fig. 64

## AUTOMATIC FREQUENCY CONTROL

An automatic frequency control (afc) circuit provides a means of correcting automatically the intermediate frequency of a superheterodyne receiver if, for any



reason, it drifts from the frequency to which the if stages are tuned. This correction is made by adjusting the frequency of the oscillator. Such a circuit will automatically compensate for slight changes in rf carrier or oscillator frequency as well as for inaccurate manual or push-button tuning.

An afc system requires two sections: a frequency detector and a variable reactance. The detector section may be essentially the same as the FM detector illustrated in Fig. 48 and discussed under **Detection**. In the afc system, however, the output is a dc control voltage, the magnitude of which is proportional to the amount of frequency shift. This dc control voltage is used to control the grid bias of an electron tube which comprises the variable reactance section (Fig. 65). The

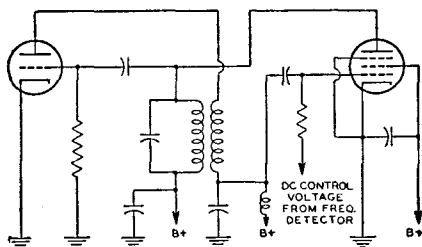

Fig. 65

plate current of the reactance tube is shunted across the oscillator tank circuit. Because the plate current and plate voltage of the reactance tube are almost  $90^\circ$  out of phase, the control tube affects the tank circuit in the same manner as a reactance. The grid bias of the tube determines the magnitude of the effective reactance and, consequently, a control of this grid bias can be used to control the oscillator frequency.

## Electron Tube Installation

The installation of electron tubes requires care if high-quality performance is to be obtained from the associated circuits. Installation suggestions and precautions which are generally common to all types of tubes are covered in this section. Careful observance of these suggestions will do much to help the experimenter and electronic technician obtain the full performance capabilities of radio tubes and circuits. Additional pertinent information is given under each tube type and in the **CIRCUIT SECTION**.

### FILAMENT AND HEATER POWER SUPPLY

The design of electron tubes allows for some variation in the voltage and current supplied to the filament or heater, but most satisfactory results are obtained from operation at the rated values. When the voltage is low, the temperature of the cathode is below normal, with the result that electron emission is limited. This may cause unsatisfactory operation and reduced tube life. On the other hand, high cathode voltage causes rapid evaporation of cathode material and shortens tube life. To insure proper tube operation, the filament or heater voltage should be checked at the socket terminals by means of an accurate voltmeter while the receiver is in operation. In the case of series operation of heaters or filaments, correct adjustment can be checked by means of an ammeter in the heater or filament circuit.

The filament or heater voltage supply may be a direct-current source (a battery or a dc power line) or an alternating-current power line, depending on the type of service and type of tube. Frequently, a resistor (either variable or fixed) is used with a dc supply to permit compensation for battery voltage variations or to adjust the tube voltage at the socket terminals to the correct value. Ordinarily, a step-down transformer is used with an ac supply to provide the proper filament or heater voltage. Receivers intended for operation on both dc and ac power lines have the heaters connected in series with a suitable resistor and supplied directly from the power line.

**DC filament or heater operation** should be considered on the basis of the source of power. In the case of the battery supply for the 1.4-volt filament tubes, it is unnecessary to use a voltage-dropping resistor in series with the filament and a single dry-cell; the filaments of these tubes are designed to operate satisfactorily over the range of voltage variations that normally occur during the life of a dry-cell. Likewise, no series resistor is required when the 1.25-volt filament subminiatures are operated from a single 1.5-volt flashlight-type dry-cell, when the 2-volt filament type tubes are operated from a single storage cell, or when the 6.3-volt series are operated from a 6-volt storage battery. In the case of dry-battery supply for 2-volt filament tubes, a variable resistor in series with the filament and the battery is required to compensate for battery variations. Turning the set on and off by means of the rheostat is advised to prevent over-voltage conditions after an off-period, for the voltage of dry-cells rises during off-periods. In the case of storage-battery supply, air-cell-battery supply, or dc power supply, a non-adjustable resistor of suitable value may be used. It is well to check initial operating conditions, and thus the resistor value, by means of a voltmeter or ammeter.

The filament or heater resistor required when filaments and/or heaters are operated in parallel can be determined easily by a simple formula derived from Ohm's law.

$$\text{Required resistance (ohms)} = \frac{\text{supply volts} - \text{rated volts of tube type}}{\text{total rated filament current (amperes)}}$$

Thus, if a receiver using three 32's, two 30's, and two 31's is to be operated from dry batteries, the series resistor is equal to 3 volts (the voltage from two dry-cells in series) minus 2 volts (voltage rating for these tubes) divided by 0.56 ampere (the sum of  $5 \times 0.060$  ampere +  $2 \times 0.130$  ampere), i.e., approximately 1.8 ohms. Since this resistor should be variable to allow adjustment for battery depreciation, it is advisable to obtain the next larger commercial size, although any value between 2 and 3 ohms will be quite satisfactory. Where much power is dissipated in the resistor, the wattage rating should be sufficiently large to prevent overheating. The power dissipation in watts is equal to the voltage drop in the resistor multiplied by the total filament current in amperes. Thus, for the example above  $1 \times 0.56 = 0.56$  watt. In this case, the value is so small that any commercial rheostat with suitable resistance will be adequate.

For the case where the heaters and/or filaments of several tubes are operated in series, the resistor value is calculated by the following formula, also derived from Ohm's law.

$$\text{Required resistance (ohms)} = \frac{\text{supply volts} - \text{total rated volts of tubes}}{\text{rated amperes of tubes}}$$

Thus, if a receiver having one 6SA7, one 6SK7, one 6SF7, one 25L6-GT, and one 25Z6-GT is to be operated from a 117-volt power line, the series resistor is equal to 117 volts (the supply voltage) minus 68.9 volts (the sum of  $3 \times 6.3$  volts +  $2 \times 25$  volts) divided by 0.3 ampere (current rating of these tubes), i.e., approximately 160 ohms. The wattage dissipation in the resistor will be 117 volts minus 68.9 volts times 0.3 ampere, or approximately 14.4 watts. A resistor having a wattage rating in excess of this value should be chosen.

It will be noted in the example for series operation that all tubes have the same current rating. If it is desired to connect in series tubes having different heater- or filament-current ratings, each tube of the lower rating should have a shunt resistor placed across its heater or filament terminals to pass the excess current. The value of this shunt resistor can be calculated from the following formula, where tube A is the tube in the series connection having the highest heater-current rating and tube B is any tube having a heater-current rating lower than tube A.

$$\text{Heater shunt resistance (ohms), tube B} = \frac{\text{heater volts, tube B}}{\text{rated heater amperes, tube A} - \text{rated heater amperes, tube B}}$$

For example, if a 6N7 having a 6.3-volt, 0.8-ampere heater is to be operated in a series-heater circuit employing several 6.3-volt tubes having heater ratings of 0.3 ampere, the required shunt resistance for each of the latter types would be

$$\text{Heater shunt resistance} = \frac{6.3}{0.8 - 0.3}, \text{ or } 12.6 \text{ ohms}$$

The value of a series voltage-dropping resistor for a sequence of tubes having one or more shunt resistors should be calculated on the basis of the tube having the highest heater-current rating.

When the series-heater connection is used in ac/dc receivers, it is usually advisable to arrange the heaters in the circuit so that the tubes most sensitive to hum disturbances are at or near the ground potential of the circuit. This arrangement reduces the amount of ac voltage between the heaters and cathodes of these tubes and minimizes the hum output of the receiver. The order of heater connection, by tube function, from chassis to the rectifier-cathode side of the ac line is shown in Fig. 66.

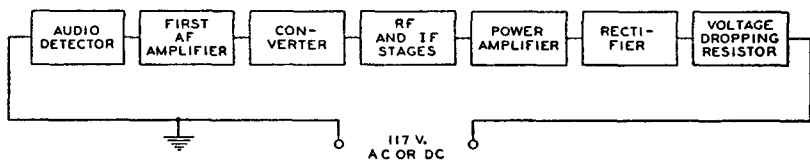

Fig. 66

**AC filament or heater operation** should be considered on the basis of either a parallel or a series arrangement of filaments and/or heaters. In the case of the parallel arrangement, a step-down transformer is employed. Precautions should be taken to see that the line voltage is the same as that for which the primary of the transformer is designed. The line voltage may be determined by measurement with an ac voltmeter (0-150 volts).

If the line voltage measures in excess of that for which the transformer is designed, a resistor should be placed in series with the primary to reduce the line voltage to the rated value of the transformer primary. Unless this is done, the excess input voltage will cause proportionally excessive voltage to be applied to the tubes. Any electron tube may be damaged or made inoperative by excessive operating voltages.

If the line voltage is consistently below that for which the primary of the transformer is designed, it may be necessary to install a booster transformer between the ac outlet and the transformer primary. Before such a transformer is installed, the ac line fluctuations should be very carefully noted. Some radio sets are equipped with a line-voltage switch which permits adjustment of the power transformer primary to the line voltage. When this switch is properly adjusted, the series-resistor or booster-transformer method of controlling line voltage is seldom required.

In the case of the series arrangements of filaments and/or heaters, a voltage-dropping resistance in series with the heaters and the supply line is usually required. This resistance should be of such value that, for normal line voltage, tubes will operate at their rated heater or filament current. The method for calculating the resistor value is given above.

When the filaments of battery-type tubes are connected in series, the total filament current is the sum of the current due to the filament supply and the plate and screen (cathode) currents returning to B (-) through the tube filaments. Consequently, in a series filament string it is necessary to add shunt resistors across each filament section to bypass this cathode current in order to maintain the filament voltage at its rated value.

## HEATER-TO-CATHODE CONNECTION

The cathodes of heater-type tubes, when operated from ac, should be connected to the mid-tap on the heater supply winding, to the mid-tap of a 50-ohm (approximate) resistor shunted across the winding, or to one end of the heater supply winding depending on circuit requirements. If none of these methods is used, it is important to keep the heater-cathode voltage within the ratings given in the TUBE TYPES SECTION.

Hum from ac-operated heater tubes used in high-gain audio amplifiers may frequently be reduced to a negligible value by employing a 15- to 40-volt bias between the heater and cathode elements of the tubes. The bias should be connected so that the tube cathode is negative with respect to its heater. Such bias can be obtained from either B batteries or a well-filtered rectifier. If the regular plate-supply rectifier of the amplifier is employed as the bias voltage source, it is good practice to add an additional filter stage in the bias voltage circuit to insure a hum-free bias source.

If a large resistor is used between heater and cathode, it should be bypassed by a suitable filter network or objectionable hum may develop. The hum is due to the fact that even a minute pulsating leakage current flowing between the heater and cathode will develop a small voltage across any resistance in the circuit. This hum voltage is amplified by succeeding stages. When a series-heater arrangement is used, the cathode circuits should be connected either directly or through biasing resistors to the negative side of the dc plate supply, which is furnished either by the dc power line or by the ac power line through a rectifier.

## PLATE VOLTAGE SUPPLY

The plate voltage for electron tubes is obtained from batteries, rectifiers, direct-current power lines, and small local generators. Auto radios have brought about the commercial development of a number of devices for obtaining a high-voltage dc supply either from the car storage-battery or from a generator driven by the car engine.

The maximum plate-voltage value for any tube type should not be exceeded if most satisfactory performance is to be obtained. Plate voltage should not be applied to a tube unless the corresponding recommended voltage is also supplied to the grid.

It is recommended that the primary circuit of the power transformer be fused to protect the rectifier tube(s), the power transformer, filter capacitor, and chokes in case a rectifier tube fails.

## GRID VOLTAGE SUPPLY

The recommended grid voltages for different operating conditions have been carefully determined to give the most satisfactory performance. Grid voltage may

be obtained from a fixed source such as a separate C-battery or a tap on the voltage divider of the high-voltage dc supply, from the voltage drop across a resistor in the cathode circuit, or from the voltage drop across a resistor in the grid circuit. The first method is called "fixed bias;" the second is called "cathode bias" or "self bias;" the third is called "grid-resistor bias" and is sometimes incorrectly referred to in receiving-tube practice as "zero-bias operation." In any case, the object is to make the grid negative with respect to the cathode by the specified voltage. When a C-battery is used, the negative terminal is connected to the grid return and the positive terminal is connected to the negative filament socket terminal, or to the cathode terminal if the tube is of the heater-cathode type. If the filament is supplied with alternating current, this connection is usually made to the center-tap of a low resistance (20-50 ohms) shunted across the filament terminals. This method reduces hum disturbances caused by the ac supply. If bias voltages are obtained from the voltage divider of a high-voltage dc supply, the grid return is connected to a more negative tap than the cathode.

The cathode-biasing method utilizes the voltage drop produced by the cathode current flowing through a resistor connected between the cathode and the negative terminal of the B-supply. See Fig. 67. The cathode current is, of course, equal to

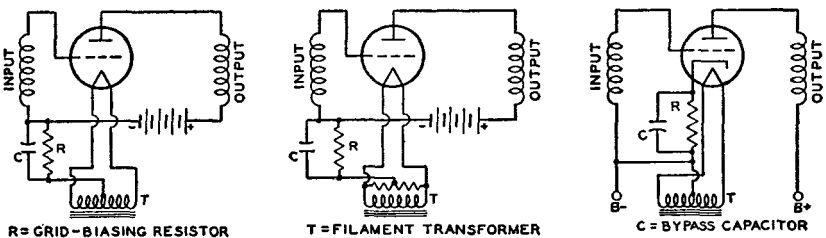

Fig. 67

the plate current in the case of a triode, or to the sum of the plate and screen currents in the case of a tetrode, pentode, or beam power tube. Since the voltage drop along the resistance is increasingly negative with respect to the cathode, the required negative grid-bias voltage can be obtained by connecting the grid return to the negative end of the resistance.

The value of the resistance for cathode-biasing a single tube can be determined from the following formula:

$$\text{Resistance (ohms)} = \frac{\text{desired grid-bias voltage} \times 1000}{\text{rated cathode current in milliamperes}}$$

Thus, the resistance required to produce 9 volts bias for a triode which operates at 3 milliamperes plate current is  $9 \times 1000/3 = 3000$  ohms. If the cathode current of more than one tube passes through the resistor, or if the tube or tubes employ more than three electrodes, the total current determines the size of the resistor.

Bypassing of the cathode-bias resistor depends on circuit-design requirements. In rf circuits the cathode resistor should be bypassed. In af circuits the use of an unbypassed resistor will reduce distortion by introducing degeneration into the circuit. However, the use of an unbypassed resistor decreases power sensitivity. When bypassing is used, it is important that the bypass capacitor be sufficiently large to have negligible reactance at the lowest frequency to be amplified. In the case of power-output tubes of high transconductance such as the beam power tubes, it may be necessary to shunt the bias resistor with a small mica capacitor (approximately 0.001  $\mu\text{f}$ ) in order to prevent oscillations. The usual af bypass may or may not be used, depending on whether or not degeneration is desired. In tubes having

high values of transconductance, such as the 6BA6, 12AW6, and 6AC7, input capacitance and input conductance change appreciably with plate current. When such a tube having a separate suppressor connection is used as an rf amplifier, these changes may be minimized by leaving a portion of the cathode-bias resistor unbypassed. In order to minimize feedback when this method is used, the external grid-plate (wiring) capacitances should be kept to a minimum, the screen should be bypassed to ac ground, and the suppressor should be connected to ac ground. The use of a cathode resistor to obtain bias voltage is not recommended for audio amplifiers in which there is appreciable shift of electrode currents with the application of a signal. In such amplifiers, a separate fixed supply is recommended.

The **grid-resistor biasing** method is also a self-bias method because it utilizes the voltage drop across the grid resistor produced by small amounts of grid current flowing in the grid-cathode circuit. This current is due to (1) an electromotive potential difference between the materials comprising the grid and cathode and (2) grid rectification when the grid is driven positive. A large value of grid resistor is required in order to limit this current to a very small value and to avoid undesirable loading effects on the preceding stage. Examples of this method of bias are given in circuits 16-1 and 16-4 in the **CIRCUIT SECTION**. In both of these circuits, the audio amplifier type 1U5 or 12AV6 has a 10-megohm resistor between the grid and the negative filament or cathode to furnish the required bias which is usually less than 1 volt. This method of biasing is used principally in the early voltage amplifier stages (usually employing high- $\mu$  triodes) of audio amplifier circuits, where the tube dissipation will not be excessive under zero-signal conditions.

A grid resistor is also used in many oscillator circuits for obtaining the required bias. In these circuits, the grid voltage is relatively constant and its magnitude is usually in the order of 5 volts or more. Consequently, the bias voltage is obtained only through grid rectification. A relatively low value of resistor, 0.1 megohm or less, is used. Oscillator circuits employing this method of bias are given in circuits 16-1 and 16-4 in the **CIRCUIT SECTION**.

**Grid-bias variation** for the rf and if amplifier stages is a convenient and frequently used method for controlling receiver volume. The variable voltage supplied to the grid may be obtained: (1) from a variable cathode resistor as shown in Figs. 68 and 69; (2) from a bleeder circuit by means of a potentiometer as shown in Fig. 70; or (3) from a bleeder circuit in which the bleeder current is varied by a tube used for automatic volume control. The latter circuit is shown in Fig. 51.

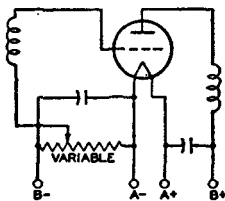

Fig. 68

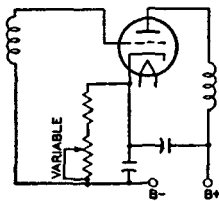

Fig. 69

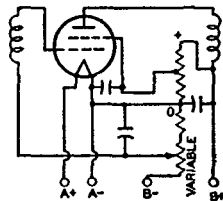

Fig. 70

In all cases it is important that the control be arranged so that at no time will the bias be less than the recommended minimum grid-bias voltage for the particular tubes used. This requirement can be met by providing a fixed stop on the potentiometer, by connecting a fixed resistance in series with the variable resistance, or by connecting a fixed cathode resistance in series with the variable resistance used for regulation. Where receiver gain is controlled by grid-bias variation, it is advisable to have the control voltages extend over a wide range in order to minimize cross-modulation

and modulation-distortion. A remote-cutoff type of tube should, therefore, be used in the controlled stages.

## SCREEN VOLTAGE SUPPLY

The positive voltage for the screen (grid No. 2) of screen-grid tubes may be obtained from a tap on a voltage divider, from a potentiometer, or from a series resistor connected to a high-voltage source, depending on the structure of the particular tube type and its application. The screen voltage for tetrodes should be obtained from a voltage divider or a potentiometer rather than through a series resistor from a high-voltage source because of the characteristic screen-current variations of tetrodes. Fig. 71 shows a tetrode with its screen voltage obtained from a potentiometer. When pentodes or beam power tubes are operated under conditions where a large shift of plate and screen currents does not take place with the application of the signal, the screen voltage may be obtained through a series resistor from a high-voltage source. This method of supply is possible because of the high uniformity of the screen-current characteristic in pentodes and beam power tubes. Because the screen voltage rises with increase in bias and resulting decrease in screen current, the cutoff characteristic of a pentode is extended by this method of supply. The method is sometimes used to increase the range of signals

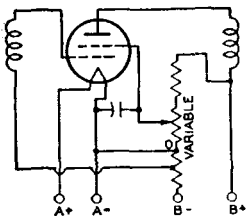

Fig. 71

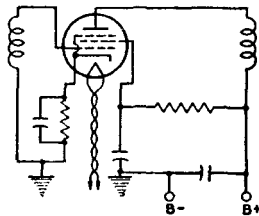

Fig. 72

which can be handled by a pentode. When used in resistance-coupled amplifier circuits employing pentodes in combination with the cathode-biasing method, it minimizes the need for circuit adjustments. Fig. 72 shows a pentode with its screen voltage supplied through a series resistor.

When power pentodes and beam power tubes are operated under conditions such that there is a large change in plate and screen currents with the application of signal, the series-resistor method of obtaining screen voltage should not be used. A change in screen current appears as a change in the voltage drop across the series resistor in the screen circuit; the result is a change in the power output and an increase in distortion. The screen voltage should be obtained from a point in the plate-voltage-supply filter system having the correct voltage, or from a separate source.

It is important to note that the plate voltage of tetrodes, pentodes, and beam power tubes should be applied before or simultaneously with the screen voltage. Otherwise, with voltage on the screen only, the screen current may rise high enough to cause excessive screen dissipation.

**Screen-voltage variation** for the rf amplifier stages has sometimes been used for volume control in older-type receivers. Reduced screen voltage lowers the transconductance of the tube and results in reduced gain per stage. The voltage variation is obtained by means of a potentiometer shunted across the screen voltage supply. See Fig. 71. When the screen voltage is varied, it is essential that the screen voltage never exceed the rating of the tube. This requirement can be met by providing a fixed stop on the potentiometer.

## SHIELDING

In high-frequency stages having high gain, the output circuit of each stage must be shielded from the input circuit of that stage. Each high-frequency stage also must be shielded from the other high-frequency stages. Unless shielding is employed, undesired feedback may occur and may produce many harmful effects on receiver performance. To prevent this feedback, it is a desirable practice to shield separately each unit of the high-frequency stages. For instance, in a superheterodyne receiver, each if and rf coil may be mounted in a separate shield can. Baffle plates may be mounted on the ganged tuning capacitor to shield each section of the capacitor from the other sections. The oscillator coil may be especially well shielded by being mounted under the chassis. The shielding precautions required in a receiver depend on the design of the receiver and the layout of the parts. In all receivers having high-gain high-frequency stages, it is necessary to shield separately each tube in high-frequency stages. When metal tubes, and in particular the single-ended types, are used, complete shielding of each tube is provided by the metal shell which is grounded through its grounding pin at the socket terminal. The grounding connection should be short and heavy. Many modern tubes of glass construction have internal shields connected usually to the cathode and where present are indicated in the socket diagram.

## DRESS OF CIRCUIT LEADS

At high frequencies such as are encountered in FM and television receivers, lead dress, that is, the location and arrangement of the leads used for connections in the receiver, is very important. Because even a short lead provides a large impedance at high frequencies, it is necessary to keep all high-frequency leads as short as possible. This precaution is especially important for ground connections and for all connections to bypass capacitors and hf filter capacitors. The ground connections of plate and screen bypass capacitors of each tube should be kept short and made directly to cathode ground.

Particular care should be taken with the lead dress of the input and output circuits of an hf stage so that the possibility of stray coupling is minimized. Unshielded leads connected to shielded components should be dressed close to the chassis. As the frequency increases, the need for paying careful attention to lead dress becomes increasingly important.

In high-gain audio amplifiers, these same precautions should be taken to minimize the possibility of self-oscillation.

## FILTERS

Feedback effects also are caused in radio receivers by coupling between stages through common voltage-supply circuits. Filters find an important use in minimizing such effects. They should be placed in voltage-supply leads to each tube in

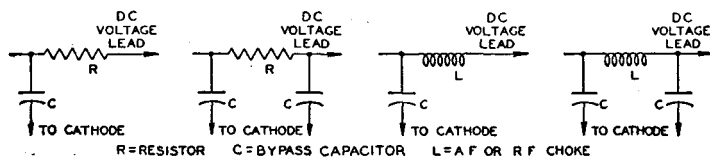

Fig. 73

order to return the signal current through a low-impedance path direct to the tube cathode rather than by way of the voltage-supply circuit. Fig. 73 illustrates several forms of filter circuits. Capacitor C forms the low-impedance path, while



the choke or resistor assists in diverting the signal through the capacitor by offering a high-impedance to the power-supply circuit.

The choice between a resistor and a choke depends chiefly upon the permissible dc voltage drop through the filter. In circuits where the current is small (a few milliamperes), resistors are practical; where the current is large or regulation important, chokes are more suitable.

The minimum practical size of the capacitors may be estimated in most cases by the following rule: The impedance of the capacitor at the lowest frequency amplified should not be more than one-fifth of the impedance of the filter choke or resistor at that frequency. Better results will be obtained in special cases if the ratio is not more than one-tenth. Radio-frequency circuits, particularly at high frequencies, require high-quality capacitors. Mica capacitors are preferable. Where stage shields are employed, filters should be placed within the shield.

Another important application of filters is to smooth the output of a rectifier tube. See **Rectification**. A smoothing filter usually consists of capacitors and iron-core chokes. In any filter-design problem, the load impedance must be considered as an integral part of the filter because the load is an important factor in filter performance. Smoothing effect is obtained from the chokes because they are in series with the load and offer a high impedance to the ripple voltage. Smoothing effect is obtained from the capacitors because they are in parallel with the load and store energy on the voltage peaks; this energy is released on the voltage dips and serves to maintain the voltage at the load substantially constant. Smoothing filters are classified as choke-input or capacitor-input according to whether a choke or capacitor is placed next to the rectifier tube. See Fig. 74.

The **CIRCUIT SECTION** gives a number of examples of rectifier circuits with recommended filter constants.

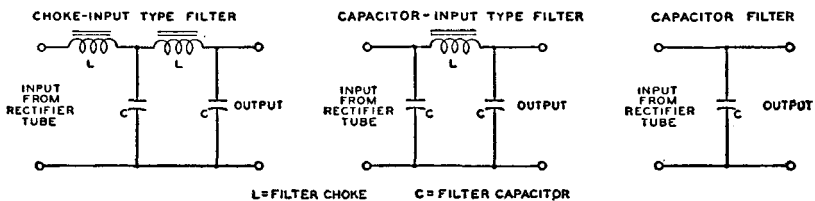

Fig. 74

If an input capacitor is used, consideration must be given to the instantaneous peak value of the ac input voltage. This peak value is about 1.4 times the rms value as measured by an ac voltmeter. Filter capacitors, therefore, especially the input capacitor, should have a rating high enough to withstand the instantaneous peak value if breakdown is to be avoided. When the input-choke method is used, the available dc output voltage will be somewhat lower than with the input-capacitor method for a given ac plate voltage. However, improved regulation together with lower peak current will be obtained.

Mercury-vapor and gas-filled rectifier tubes occasionally produce a form of local interference in radio receivers through direct radiation or through the power line. This interference is generally identified in the receiver as a broadly tunable 120-cycle buzz (100 cycles for 50-cycle supply line, etc.). It is usually caused by the formation of a steep wave front when plate current within the tube begins to flow on the positive half of each cycle of the ac supply voltage. There are several ways of eliminating this type of interference. One is to shield the tube. Another is to insert an rf choke having an inductance of one millihenry or more between each plate and transformer winding and to connect high-voltage, rf bypass capaci-

tors between the outside ends of the transformer winding and the center tap. See Fig. 75. The rf chokes should be placed within the shielding of the tube. The rf bypass capacitors should have a voltage rating high enough to withstand the peak voltage of each half of the secondary, which is approximately 1.4 times the

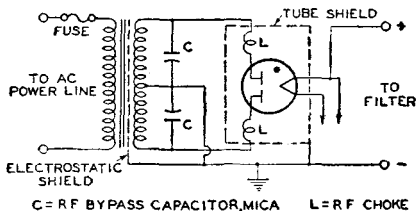

Fig. 75

rms value. Transformers having electrostatic shielding between primary and secondary are not likely to transmit rf disturbances to the line. Often the interference may be eliminated simply by making the plate leads of the rectifier extremely short. In general, the particular method of interference elimination must be selected by experiment for each installation.

## OUTPUT-COUPLING DEVICES

An output-coupling device is used in the plate circuit of a power output tube to keep the comparatively high dc plate current from the winding of an electromagnetic speaker and, also, to transfer power efficiently from the output stage to a loudspeaker of either the electromagnetic or dynamic type.

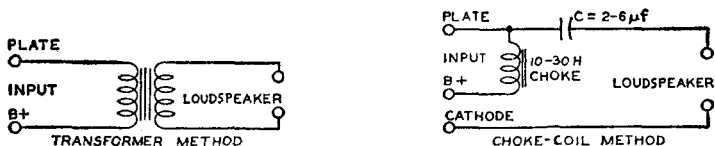

Fig. 76

Output-coupling devices are of two types, (1) choke-capacitor and (2) transformer. The choke-capacitor type includes an iron-core choke with an inductance of not less than 10 henrys which is placed in series with the plate and B-supply. The choke offers a very low resistance to the dc plate current component of the signal voltage but opposes the flow of the fluctuating component. A bypass capacitor of 2 to 6  $\mu\text{f}$  supplies a path to the speaker winding for the signal voltage. The transformer type is constructed with two separate windings, a primary and a secondary wound on an iron core. This construction permits designing each winding to meet the requirements of its position in the circuit. Typical arrangements of each type of coupling device are shown in Fig. 76. Examples of transformers for push-pull stages are shown in several of the circuits given in the CIRCUIT SECTION.

## HIGH-VOLTAGE CONSIDERATIONS FOR KINESCOPES

Like other high-voltage devices, kinescopes require that certain precautions be observed to minimize the possibility of failure caused by humidity, dust, and corona.

**Humidity Considerations.** When humidity is high, a continuous film of moisture may form on the glass bulb immediately surrounding the anode cavity cap of all-glass kinescopes or on the glass part of the cone of metal kinescopes. This film may permit sparking to take place over the glass surface to the

external conductive coating or to the metal cone. Such sparking may introduce noise into the receiver. To prevent such a possibility, the uncoated bulb surface around the cap and the glass part of the cone of metal kinescopes should be kept clean and dry.

**Dust Considerations.** The accumulation of dust on the uncoated area of the bulb around the anode cap of all-glass kinescopes or on the glass part of the cone or insulating supports for metal kinescopes will decrease the insulating qualities of these parts. The dust usually consists of fibrous materials and may contain soluble salts. The fibers absorb and retain moisture; the soluble salts provide electrical leakage paths that increase in conductivity as the humidity increases. The resulting high leakage currents may overload the high-voltage power supply. It is recommended, therefore, that the uncoated bulb surface of all-glass kinescopes and the coated glass surface and insulating supports for metal kinescopes be kept clean and free from dust or other contamination such as finger-prints. The coated glass surface of the metal kinescopes may be cleaned with a soapless detergent, such as Dreft, then rinsed with clean water, and immediately dried.

**Corona Considerations.** A high-voltage system may be subject to corona, especially when the humidity is high, unless suitable precautions are taken. Corona, which is an electrical discharge appearing on the surface of a conductor when the voltage gradient exceeds the breakdown value of air, causes deterioration of organic insulating materials through formation of ozone, and induces arc-over at points and sharp edges. Sharp points or other irregularities on any part of the high-voltage system may increase the possibility of corona and should be avoided. In the metal-cone kinescopes, the metal lip at the maximum diameter has rounded edges to prevent corona. Adequate spacing between the lip and any grounded element in the receiver, or between the small end of the metal cone and any grounded element, should be provided to preclude the possibility of corona. Such spacing should not be less than 1 inch of air. Similarly, an air space of 1 inch, or equivalent, should be provided around the body of the metal cone. As a further precaution to prevent corona, the deflecting-yoke surface on the end adjacent to the cone should present a smooth electrical surface with respect to the small end of the metal cone or the anode terminal of all-glass tubes. For metal kinescopes, the end of the yoke should not touch the glass part of the cone above the Reference Line (see Kinescope Outline Drawings in OUTLINES SECTION), but can follow the glass contour, departing gradually from it. For all-glass kinescopes, the yoke should touch the bulb cone near the Reference Line, and should follow the cone contour, departing gradually from it.

## KINESCOPE SAFETY CONSIDERATIONS

**Tube Handling.** Breakage of kinescopes, which contain a high vacuum, may result in injury from flying glass. Do not strike or scratch the tube or subject it to more than moderate pressure when installing it in or removing it from electronic equipment.

**High-Voltage Precautions.** In the use of kinescopes, it should always be remembered that high voltages may appear at normally low-potential points in the circuit because of capacitor breakdown or incorrect circuit connections. Therefore, before any part of the circuit is touched the power-supply switch should be turned off, the power plug disconnected, and both terminals of any capacitors grounded.

**X-Ray Radiation Precautions.** All types of picture tubes may be operated at voltages (if ratings permit) up to 16 kilovolts without producing harmful x-ray radiation and without danger of personal injury on prolonged exposure at close range. Above 16 kilovolts, special x-ray shielding precautions may be necessary.

# Interpretation of Tube Data

The tube data given in the following TUBE TYPES SECTION include ratings, typical operation values, characteristics, and characteristic curves.

The values for grid-bias voltages, electrode voltages, and electrode supply voltages are given with reference to a specified datum point as follows: For types having filaments heated with dc, the negative filament terminal is taken as the datum point to which other electrode voltages are referred. For types having filaments heated with ac, the mid-point (i.e., the center tap on the filament-transformer secondary, or the mid-point on a resistor shunting the filament) is taken as the datum point. For types having unipotential cathodes indirectly heated, the cathode is taken as the datum point.

Electrode voltage and current ratings are in general self-explanatory, but a brief explanation of other ratings will aid in the understanding and interpretation of tube data.

**Plate dissipation** is the power dissipated in the form of heat by the plate as a result of electron bombardment. It is the difference between the power supplied to the plate of the tube and the power delivered by the tube to the load.

**Grid-No. 2 (Screen) Input** is the power applied to the grid-No. 2 electrode and consists essentially of the power dissipated in the form of heat by grid No. 2 as a result of electron bombardment. With tetrodes and pentodes, the power dissipated in the screen circuit is added to the power in the plate circuit to obtain the total B-supply input power.

**Peak heater-cathode voltage** is the highest instantaneous value of voltage that a tube can safely stand between its heater and cathode. This rating is applied to tubes having a separate cathode terminal and used in applications where excessive voltage may be introduced between heater and cathode.

**Maximum peak inverse plate voltage** is the highest instantaneous plate voltage which the tube can withstand recurrently in the direction opposite to that in which it is designed to pass current. For mercury-vapor tubes and gas-filled tubes, it is the safe top value to prevent arc-back in the tube operating within the specified temperature range. Referring to Fig. 77, when plate A of a full-wave rectifier tube is positive, current flows from A to C, but not from B to C, because B is negative. At the instant plate A is positive, the filament is positive (at high voltage) with respect to plate B. The voltage between the positive filament and the negative plate B is in inverse relation to that causing current flow. The peak value of this voltage is limited by the resistance and nature of the path between plate B and filament. The maximum value of this voltage at which there is no danger of breakdown of the tube is known as maximum peak inverse voltage. The relations between peak inverse voltage, rms value of ac input voltage, and dc output voltage depend largely on the individual characteristics of the rectifier circuit and the power supply. The presence of line surges or any other transient, or wave-form distortion may raise the actual peak voltage to a value higher than that calculated for sine-wave voltages. Therefore, the actual inverse voltage, and not the calculated value, should be such as not to exceed the rated maximum peak inverse voltage for the rectifier tube. A calibrated cathode-ray

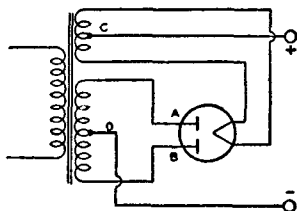

Fig. 77

oscillograph or a peak-indicating electronic voltmeter is useful in determining the actual peak inverse voltage. In single-phase, full-wave circuits with sine-wave input and with no capacitor across the output, the peak inverse voltage on a rectifier tube is approximately 1.4 times the rms value of the plate voltage applied to the tube. In single-phase, half-wave circuits with sine-wave input and with capacitor input to the filter, the peak inverse voltage may be as high as 2.8 times the rms value of the applied plate voltage. In polyphase circuits, mathematical determination of peak inverse voltage requires the use of vectors.

**Maximum peak plate current** is the highest instantaneous plate current that a tube can safely carry recurrently in the direction of normal current flow. The safe value of this peak current in hot-cathode types of rectifier tubes is a function of the electron emission available and the duration of the pulsating current flow from the rectifier tube in each half-cycle.

The value of peak plate current in a given rectifier circuit is largely determined by filter constants. If a large choke is used at the filter input, the peak plate current is not much greater than the load current; but if a large capacitor is used at the filter input, the peak current may be many times the load current. In order to determine accurately the peak plate current in any rectifier circuit, measure it with a peak-indicating meter or use an oscillograph.

**Maximum dc output current** is the highest average plate current which can be handled continuously by a rectifier tube. Its value for any rectifier tube type is based on the permissible plate dissipation of that type. Under operating conditions involving a rapidly repeating duty cycle (steady load), the average plate current may be measured with a dc meter.

**Typical Operation Values.** Values for typical operation are given for many types in the TUBE TYPES SECTION. These values should not be confused with ratings, because a tube can be used under any suitable conditions within its maximum ratings, according to the application.

The power output value for any operating condition is an approximate tube output—that is, plate input minus plate loss. Circuit losses must be subtracted from tube output in order to determine the useful output.

**Characteristics** are covered in the ELECTRON TUBE CHARACTERISTICS SECTION and such data should be interpreted in accordance with the definitions given in that section. **Characteristic curves** represent the characteristics of an average tube. Individual tubes, like any manufactured product, may have characteristics that range above or below the values given in the characteristic curves.

Although some curves are extended well beyond the maximum ratings of the tube, this extension has been made only for convenience in calculations. Do NOT operate a tube outside of its maximum ratings.

All tubes in this Manual are rated according to the "design-center system" as given in RMA Standard M8-210. This standard takes into account the normal voltage variations of the various power-supply sources used for modern radio receivers. The Standard M8-210, used with permission of the Engineering Department of the Radio Manufacturers Association, follows:

It shall be standard to interpret the ratings on receiving types of tubes according to the following conditions:

1. **CATHODE**—The heater or filament voltage is given as a normal value unless otherwise stated. This means that transformers or resistances in the heater or filament circuit should be designed to operate the heater or filament at rated value for full-load operating conditions under average supply-voltage conditions. A

reasonable amount of leeway is incorporated in the cathode design so that moderate fluctuations of heater or filament voltage downward will not cause marked falling off in response; also moderate voltage fluctuations upward will not reduce the life of the cathode to an unsatisfactory degree.

**A. 1.4-Volt Battery Tube Types**—The filament power supply may be obtained from dry-cell batteries, from storage batteries, or from a power line. With dry-cell battery supply, the filament may be connected either directly across a battery rated at a terminal potential of 1.5 volts, or in series with the filaments of similar tubes across a power supply consisting of dry cells in series. In either case, the voltage across each 1.4-volt section of filament should not exceed 1.6 volts. With power-line or storage-battery supply, the filament may be operated in series with the filaments of similar tubes. For such operation, design adjustments should be made so that, with tubes of rated characteristics, operating with all electrode voltages applied and on a normal line voltage of 117 volts or on a normal storage-battery voltage of 2.0 volts per cell (without a charger) or 2.2 volts per cell (with a charger), the voltage drop across each 1.4-volt section of filament will be maintained within a range of 1.25 to 1.4 volts with a nominal center of 1.3 volts. In order to meet the recommended conditions for operating filaments in series from dry-battery, storage-battery, or power-line sources it may be necessary to use shunting resistors across the individual 1.4-volt sections of filament.

**B. 2.0-Volt Battery Tube Types**—The 2.0-volt line of tubes is designed to be operated with 2.0 volts across the filament. In all cases the operating voltage range should be maintained within the limits of 1.8 volts to 2.2 volts.

**2. POSITIVE POTENTIAL ELECTRODES**—The power sources for the operation of radio equipment are subject to variations in their terminal potential. Consequently, the maximum ratings shown on the tube-type data sheets have been established for certain Design Center Voltages which experience has shown to be representative. The Design Center Voltages to be used for the various power supplies together with other rating considerations are as given below:

**A. AC or DC Power Line Service in U.S.A.** The design center voltage for this type of power supply is 117 volts. The maximum ratings of plate voltages, screen-supply voltages, dissipations, and rectifier output currents are design maximums and should not be exceeded in equipment operated at a line voltage of 117 volts.

**B. Storage-Battery Service**—When storage-battery equipment is operated without a charger, it should be designed so that the published maximum values of plate voltages, screen-supply voltages, dissipations, and rectifier output currents are never exceeded for a terminal potential at the battery source of 2.0 volts per cell. When storage-battery equipment is operated with a charger, it should be designed so that 90% of the same maximum values is never exceeded for a terminal potential at the battery source of 2.2 volts.

**C. "B"-Battery Service**—The design center voltage for "B" batteries is the normal voltage rating of the battery block, such as 45 volts, 90 volts, etc. Equipment should be designed so that under no condition of battery voltage will the plate voltages, the screen-supply voltages, or dissipations ever exceed the recommended respective maximum values shown in the data for each tube type by more than 10%.

#### **D. Other Considerations**—

**a. Class A<sub>1</sub> Amplifiers**—The maximum plate dissipation occurs at the "Zero-Signal" condition. The maximum screen dissipation usually occurs at the condition where the peak-input signal voltage is equal to the bias voltage.

**b. Class B Amplifiers**—The maximum plate dissipation theoretically occurs at approximately 63% of the "Maximum-Signal" condition, but practically may occur at any signal voltage value.

c. **Converters**—The maximum plate dissipation occurs at the "Zero-Signal" condition and the frequency at which the oscillator-developed bias is a minimum. The screen dissipation for any reasonable variation in signal voltage must never exceed the rated value by more than 10%.

d. **Screen Ratings**—When the screen voltage is supplied through a series voltage-dropping resistor, the maximum screen voltage rating may be exceeded, provided the maximum screen dissipation rating is not exceeded at any signal condition, and the maximum screen voltage rating is not exceeded at the maximum-signal condition. Provided these conditions are fulfilled, the screen-supply voltage may be as high as, but not above, the maximum plate voltage rating.

**3. TYPICAL OPERATION**—For many receiving tubes, the data show typical operating conditions in particular services. These typical operating values are given to show concisely some guiding information for the use of each type. They are not to be considered as ratings, because the tube can be used under any suitable conditions within its rating limitations.

# RCA Receiving Tube Classification Chart

RCA receiving tubes are classified in the following chart according to function and filament or heater voltage. Types having similar electrical characteristics

## A—Kinescopes

KINESCOPIES			3—5	7	9	10	12	16 (Metal)	19 (Metal)
Directly Viewed	Approx. Bulb Diameter (Inches)								
	Focusing Method	Deflection Method							
	electrostatic	electrostatic	3KP4	7JP4					
electrostatic	magnetic		7DP4	9AP4			12AP4		
magnetic	magnetic					10BP4-A	12LP4-A	16AP4-A 16CP4-B	19AP4-B
Projection	electrostatic	magnetic	5TP4						

## B—Rectifiers, Detectors, Power and Voltage Amplifiers, Converters and Mixers, Electron-Ray Tubes

Types having similar characteristics and the same filament or heater voltage are bracketed.

Filament or Heater Volts			1.25—1.4			2.0—5.0			6.3—117.0		
			Sub-miniature	Miniature	Other	Octal	Other	Miniature	Octal	Other	
<b>RECTIFIERS (For rectifiers with amplifier units, see POWER AMPLIFIERS).</b>											
Half-Wave	vacuum	Peak Inverse Volts									
		Below 1500						35W4 45Z3 117Z3	6W4-GT 25W4-GT [352A-GT 3523-GT] 4X25-GT 117Z4-GT	1-w 12Z3 35Y4 35Z3	
Full-Wave	vacuum	Above 1500		1V2 1X2A 1B3-GT							81
		Below 1500			{5Y3-C 5A2A 5Z4 6Y3-GT 5Y4-C 80}			{6X4 6X5, 6X5-GT}	6AX5-GT 6Z55-G 84/624	7Y4 7Z4	
	mercury-vapor	Above 1500			{5V4-C 5W4 83-V 5T4 5U4-G 5Z3 5X4-G}						
	gas	Below 1500			Cold-Cathode Types 0Y4, 0Z4, 0Z4-G		82 83				
Diodes	vacuum	Below 1500							{2526 2526-GT 2525} 50Y6-GT 50Y7-GT 117Z6-GT	50X6	
<b>DIODE DETECTORS (For diode detectors with amplifier units, see VOLTAGE AMPLIFIERS and also POWER AMPLIFIERS).</b>											
One Diode			1A3								
Two Diodes						6AL5 12AL5			{6H6 6H6-GT 12B6		
<b>POWER AMPLIFIERS with and without Rectifiers, Diode Detector, and Voltage Amplifiers.</b>											
Triodes	low- $\mu$	single unit					2A3 31 49 45 46 71-A		6AS7-G 6B4-C		6A3 50
		single unit							6AC5-GT		
	high- $\mu$	single unit				{1J6-GT 19}	53		{6N7 6N7-GT 6A6}		
	high- $\mu$	twin unit			1G6-GT				6AQ7-GT 6Z7-G		79
direct-coupled arrangement									6N6-C		6B5
Beam Tubes	single unit				{105-GT 90S-GT 115-GT 3LF4*			6AS5 {35B3 35C3 50B3 50C3}	6AU5-GT 6BC6-G [6L6 6B06-GT 6CD6-G 6LA-G 6V6 3 25L6 {6V6-GT} 6Y6-G {25L6-GT 35L6-GT 19BC6-G 50C6-G 50L6-GT}	7A5 14A5 7C5 14C5	35A5 50A5
	with rectifier								32L7-GT 70L7-GT {117L7/M7-GT 117P7-GT 117N7-GT}		
Pentodes	single unit		1AC5	{154 35P4* 304* 3V4*}	1A5-GT 1CS-GT 1LA4 1LB4	1G5-G	{1F4 1F3-C} 2A5 33 47 59	{6AX6 6AR5	6CG-G 6AC7 {6F6 6F6-G 6F6-GT 42 {6K6-GT 41 {25A6 43}	7B5 7AD7 38 89	
	with medium- $\mu$ triode								6AD7-G		
	with diode and triode				1D6-GT						
	with rectifier										12A7
twin unit											1E7-GT



# RCA RECEIVING TUBE MANUAL

are grouped in brackets. For more complete data on these types, refer to the **TUBE TYPES SECTION**. When choosing a tube type, refer to information on *Preferred Types* and the listing of *Types Not Recommended for New Equipment Design* on the inside back cover.

		1.25—1.4			2.0—5.0		6.3—117.0			
		Sub-miniature	Miniature	Other	Octal	Other	Miniature	Octal	Other	
<b>CONVERTERS &amp; MIXERS</b> (For other types used as Mixers, see <b>VOLTAGE AMPLIFIERS</b> .)										
Converters	pentagrid	1E8	1R5	1A7-GT 1LA6 1LC6	{1C7-G {1D7-G	1C6 1A6 2A7	{6BE6 {2BE6 12BA7 {6BA7	{6A7 {6A7-GT {6A8, 6A8-G {6A8-CT, 6D8-C	{6A7 7B8 7Q7 14Q7	
	triode-hexode							{6K8, 6K8-G} 12K8		
	triode-heptode							6J8-G	7S7 7J7 14J7	
	octode								7A8	
Mixers	pentagrid							{6L7, 6L7-G}		
<b>ELECTRON-RAY TUBES</b>										
Single	with remote-cutoff triode								6AB5/6N5 6U5	
	with sharp-cutoff triode					2E5			6E5	
Twin	without triode							6AF6-G		
Triple	with triode							6AL7-GT		
<b>VOLTAGE AMPLIFIERS with and without Diode Detectors; TRIODE, TETRODE, AND PENTODE DETECTORS, OSCILLATORS.</b>										
Triodes	medium- $\mu$	single unit			1G4-GT 1LE3 26	{1H4-G 30} 27 56	6C4 654	{6J5, 6J5-GT} {6C5, 6C5-GT} 12J5-GT {6L5-G 6P5-GT}	7A4 14A4 76 37	
		with rf pentode							6F7	
		with power pentode							6AD7-G	
		with pentode and diode			1D8-GT 3A8-GT*					
		with two diodes				{1H6-G 1B5/25S} 55		{6BF6 6R7, 6R7-GT} 6SR7, 6ST7 12SR7	7E6 14E6 85	
	twin unit					6J6 19J6 12AU7*	{6PB-G, 6SN7-GT} 12SN7-GT 6CB-G 12A7H-GT	7AF7 14AF7 7F8 14F8 7N7 14N7		
	high- $\mu$	single unit					6AB4	{6F5, 6F5-GT} 12F5-GT {6SF5, 6SF5-GT} 25AC5-GT	7B4	
		with diode			1H5-GT 1LH4					
		with two diodes				2A6	12AT6 {6AT6 6AQ6} 6Q7, 6Q7-G 6C7-GT, 6S27 12AV6 {6AV6 6B6-G 6B7-GT} 12S27-GT {12S27-GT}	12O7-GT 6T7-G	7B6 14B6 7C6 75	
		with three diodes					6T8, 19T8	68H-GT, 1258-GT		
twin unit						12AT7* 12AX7*	68C7, 125C7 6SL7-GT, 12SL7-GT	7E7 14E7 7K7 7X7		
Tetrodes	remote-cutoff					35				
sharp-cutoff					24-A 32			36		
Pentodes	remote-cutoff	single unit	1T4	1LG5 1P5-GT	{1D5-CP 1A4-P} 34 58		{6BD6 6SK7, 6SK7-GT} {6K7, 6K7-G} {12BD6 12SK7, 12SK7-GT} 6K7-GT {6BA6 6C7, 6C7-G} 12K7-GT {12BA6 12SC7} {6U7-G 6S7} 6B7 6S7 {6S7-G}	78 7A7 14A7 7H7 14H7 7AH7 7B7 39/44		
		with triode							6F7	
		with diode						6SF7, 12SF7		
	sharp-cutoff	with two diodes				2B7		12C8 {68B 6B7}	7E7 14E7 7R7 14R7	
		single unit	1AD5	1LA 1U4	1LC5 1LH5 1N5-GT	{1E5-CP 1B4-P} 57	{6AC5, 6AK5} {6BC5, 6CB6} 12AW6 6AN6 6SH6 {6AU6 13AU6}	{6S7, 6S7-GT} {12S7, 12S7-GT} {12S7-GT, 12J7-GT} {6A7 6A7-GT} {12S7-GT, 12J7-GT}	7AC7 7C7 7C7 14C7 7L7 7V7 7W7	
		with diode	1T6	1S5 1U5	1LD5			6SH7 {6J7, 6J7-G, 6J7-GT} 6C6, 6W7-G	77	
with two diodes				1F7-G 1F6						

\* Filament arranged for either 1.4 or 2.8-volt operation. \* Heater arranged for either 6.3- or 12.6-volt operation.

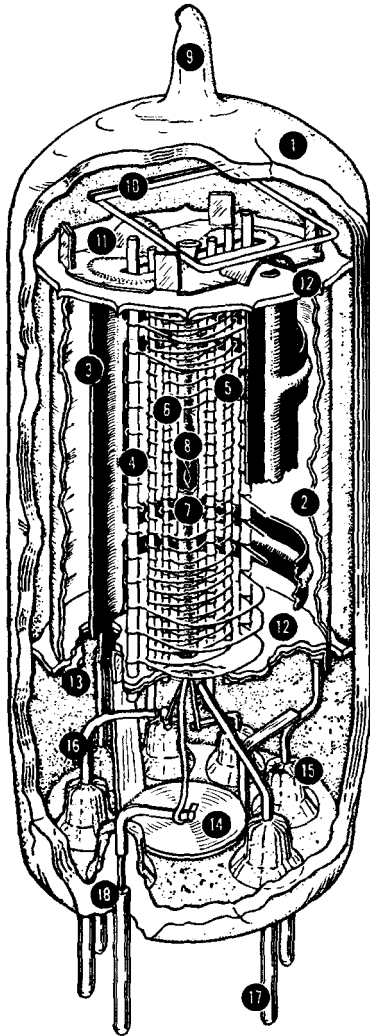

2½ times actual size

- 1 – Glass Envelope
- 2 – Internal Shield
- 3 – Plate
- 4 – Grid No. 3 (Suppressor)
- 5 – Grid No. 2 (Screen)
- 6 – Grid No. 1 (Control Grid)
- 7 – Cathode
- 8 – Heater
- 9 – Exhaust Tip
- 10 – Getter
- 11 – Spacer Shield Header
- 12 – Insulating Spacer
- 13 – Spacer Shield
- 14 – Inter-Pin Shield
- 15 – Glass Button-Stem Seal
- 16 – Lead Wire
- 17 – Base Pin
- 18 – Glass-to-Metal Seal

## Structure of a Miniature Tube

# RCA Tube Types

This section contains technical descriptions of RCA tubes used in standard broadcast, FM, and television receivers. It includes data on current types, as well as information on those RCA discontinued types in which there may still be some interest as to characteristics.

In choosing tube types for the design of new electronic equipment, the designer is referred to the inside back cover for information regarding the availability of the latest RCA Preferred Types List and for a listing of RCA Tube Types Not Recommended for New Equipment Design.

Tube types are listed in this section according to the numerical-alphabetical sequence of their type designations. For Key to Socket Connection Diagrams, see inside front cover.

## DETECTOR AMPLIFIER TRIODE

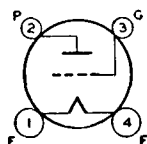

Storage-battery triode used as detector or amplifier. Outline 36, OUTLINES SECTION. Operating conditions as grid-resistor detector are: plate volts, 45 *max*; grid resistor, 2 to 3 megohms; grid capacitor, 250  $\mu\text{f}$ ; grid return to (+) filament. As biased detector, type 01-A has plate volts of 135 *max*; bias of approximately -13.5 volts. As amplifier, it has plate volts of 135 *max*; bias of -9 volts. Filament volts, 5; amperes, 0.25. This is a DISCONTINUED type listed for reference only.

**01-A**

## HALF-WAVE GAS RECTIFIER

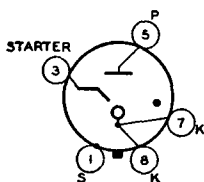

Metal type used primarily in vibrator-type B-supply units of automobile receivers. Utilizes a starter electrode and an ionically heated cathode. Starter anode permits operation of OY4 directly from 117-volt ac line. Outline 3, OUTLINES SECTION. Tube requires octal socket. Pins 7 and 8 must be tied together at socket. RF filter circuits placed close to socket terminals are required to reduce rectifier noise. Ratings as

**OY4**

half-wave rectifier with capacitor-input filter: peak inverse anode volts, 300 *max*; peak anode ma., 500 *max*; dc output ma., 75 *max*, 40 *min*; series anode resistance (117-volt line operation), 50 *min* ohms; tube voltage drop (approx.), 12 volts; minimum ac starting voltage when starter anode is connected to anode through a 10-megohm resistor bypassed with a 0.002- $\mu\text{f}$  capacitor, 100 volts rms. This type is used principally for renewal purposes.

## FULL-WAVE GAS RECTIFIER

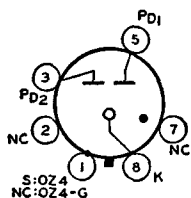

Metal type OZ4 and glass octal type OZ4-G are used in vibrator-type, B-supply units. Both have ionically heated cathodes, require octal sockets, and may be mounted in any position. OZ4 Outline 2, OUTLINES SECTION. OZ4-G dimensions: maximum overall length, 2-5/8 inches; maximum diameter, 1-1/16 inches; T-7 bulb; dwarf-shell octal 5-pin base. Base of OZ4-G has no pin No. 2. Shell of OZ4 and external shield of OZ4-G should be grounded. Filters may be necessary to eliminate objectionable noise. These types are used principally for renewal purposes.

**OZ4**  
**OZ4-G**

## FULL-WAVE RECTIFIER

### Maximum Ratings:

PEAK STARTING SUPPLY VOLTAGE PER PLATE.....	300 min	volts
PEAK PLATE-TO-PLATE VOLTAGE.....	1000 max	volts
PEAK PLATE CURRENT.....	200 max	ma
DC OUTPUT CURRENT.....	{ 75 max	ma
	{ 30 min	ma
DC OUTPUT VOLTAGE.....	300 max	volts
AVERAGE DYNAMIC TUBE VOLTAGE DROP.....	24	volts

## HF DIODE

# 1A3

Miniature type used as detector tube in portable FM receivers and in portable high-frequency measuring equipment. Outline 12, OUTLINES SECTION. Tube requires miniature seven-contact socket. Heater volts (ac/dc), 1.4; amperes, 0.15.

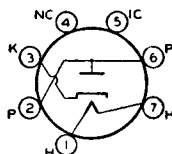

### Maximum Ratings:

PEAK INVERSE PLATE VOLTAGE.....	330 max	volts
PEAK PLATE CURRENT.....	5 max	ma
DC OUTPUT CURRENT.....	0.5 max	ma
PEAK HEATER-CATHODE VOLTAGE.....	140 max	volts

## HALF-WAVE RECTIFIER

### Typical Operation (With Capacitor-Input Filter):

AC Plate-Supply Voltage (rms).....	117	volts
Filter-Input Capacitor.....	2	μf
Minimum Total Effective Plate-Supply Impedance.....	0	ohms

## REMOTE-CUTOFF PENTODE

# 1A4-P

Glass type used in battery-operated receivers as rf or if amplifier. For ratings and operating data, refer to type 1D5-GP. Outline 34, OUTLINES SECTION. Tube requires four-contact socket. Filament volts (dc), 2.0; amperes, 0.06. This type is used principally for renewal purposes.

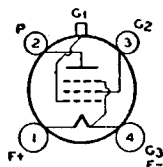

## POWER PENTODE

# 1A5-GT

Glass octal type used in output stage of battery-operated receivers. Outline 22, OUTLINES SECTION. Tube requires octal socket and may be mounted in any position. For filament considerations, refer to 1U4.

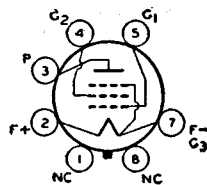

FILAMENT VOLTAGE (DC).....	1.4	volts
FILAMENT CURRENT.....	0.05	ampere

### Maximum Ratings:

PLATE VOLTAGE.....	110 max	volts
GRID-NO.2 (SCREEN) VOLTAGE.....	110 max	volts
TOTAL ZERO-SIGNAL CATHODE CURRENT.....	6 max	ma

## CLASS A<sub>1</sub> AMPLIFIER

### Typical Operation:

Plate Voltage.....	85	90	volts
Grid-No.2 Voltage.....	85	90	volts
Grid-No.1 (Control-Grid) Voltage.....	-4.5	-4.5	volts
Peak AF Grid-No.1 Voltage.....	4.5	4.5	volts
Zero-Signal Plate Current.....	3.5	4.0	ma
Maximum-Signal Plate Current.....	3.5	4.0	ma
Zero-Signal Grid-No.2 Current.....	0.7	0.8	ma
Maximum-Signal Grid-No.2 Current.....	1.0	1.1	ma
Plate Resistance (Approx.).....	0.3	0.3	megohm
Transconductance.....	800	850	μmhos
Load Resistance.....	25000	25000	ohms
Total Harmonic Distortion.....	10	7	per cent
Maximum-Signal Power Output.....	100	115	mw

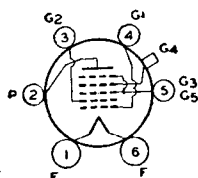

### PENTAGRID CONVERTER

Glass type used in battery-operated receivers. Type 1A6 is identical electrically with type 1D7-G, except for interelectrode capacitances. Outline 34, OUTLINES SECTION. Tube requires six-contact socket. Filament volts (dc), 2.0; amperes, 0.06. This type is used principally for renewal purposes.

## 1A6

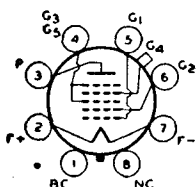

### PENTAGRID CONVERTER

Glass octal type used in superheterodyne circuits having battery power supplies. Outline 23, OUTLINES SECTION. Tube requires octal socket and may be mounted in any position. For filament considerations, refer to 1U4.

## 1A7-GT

FILAMENT VOLTAGE (DC).....	1.4	volts
FILAMENT CURRENT.....	0.05	ampere

### CONVERTER SERVICE

#### Maximum Ratings:

PLATE VOLTAGE.....	110 max	volts
GRIDS-NO.3-AND-NO.5 (SCREEN) VOLTAGE.....	60 max	volts
GRIDS-NO.3-AND-NO.5 SUPPLY VOLTAGE.....	110 max	volts
GRID-NO.2 (ANODE-GRID) VOLTAGE.....	110 max	volts
TOTAL ZERO-SIGNAL CATHODE CURRENT.....	6 max	ma

#### Typical Operation:

Plate Voltage.....	90	volts
Grids-No.3-and-No.5 Voltage*.....	45	volts
Grid-No.2 Voltage.....	90	volts
Grid-No.4 (Control-Grid) Voltage**.....	0	volts
Grid-No.1 (Oscillator-Grid) Resistor.....	0.2	megohm
Plate Resistance.....	0.6	megohm
Conversion Transconductance.....	250	μmhos
Conversion Transconductance with grid-No.4 bias of ~3 volts (Approx.).....	20	μmhos
Plate Current.....	0.6	ma
Grids-No.3-and-No.5 Current.....	0.7	ma
Grid-No.2 Current.....	1.2	ma
Grid-No.1 Current.....	0.035	ma
Total Cathode Current.....	2.5	ma

\*Obtained preferably by using a bypassed 45000- to 75000-ohm voltage-dropping resistor in series with the 90-volt supply.

\*\* A resistance of at least 1.0 megohm should be in the grid return to negative filament pin.

## POWER PENTODE

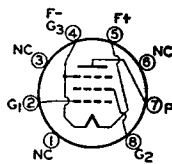

# 1AC5

Subminiature type used in output stage of small, compact, battery-operated receivers for the standard AM broadcast band. It is capable of moderate power output with a very small input

voltage. The 1AC5 and the other RCA subminiature types 1AD5, 1E8, and 1T6 comprise a complete tube complement for lightweight portable radio receivers having extremely low battery drain.

FILAMENT VOLTAGE (DC) .....	1.25	volts
FILAMENT CURRENT .....	0.04	ampere

<b>Maximum Ratings:</b>		<b>CLASS A<sub>1</sub> AMPLIFIER</b>	
PLATE VOLTAGE .....	67.5 max	volts	
GRID-NO.2 (SCREEN) VOLTAGE .....	67.5 max	volts	
TOTAL CATHODE CURRENT .....	4.0 max	ma	

**Typical Operation:**

Plate Voltage .....	30	45	67.5	volts
Grid-No.2 Voltage .....	30	45	67.5	volts
Grid-No.1 (Control-Grid) Voltage .....	-2	-3	-4.5	volts
Peak AF Grid-No.1 Voltage .....	2	3	4.5	volts
Zero-Signal Plate Current .....	0.5	1.0	2.0	ma
Zero-Signal Grid-No.2 Current .....	0.1	0.2	0.4	ma
Plate Resistance .....	0.2	0.17	0.15	megohm
Transconductance .....	450	600	750	μmhos
Load Resistance .....	50000	40000	25000	ohms
Total Harmonic Distortion .....	10	10	10	per cent
Maximum-Signal Power Output .....	5	15	50	mw

## INSTALLATION AND APPLICATION

Type 1AC5 requires a subminiature eight-contact socket and may be mounted in any position. Do not attempt to solder the base pins to any circuit element because the heat of the soldering operation may crack the glass seal. Although the base pins are sturdy, they can be bent. It is essential, therefore, that the pins be

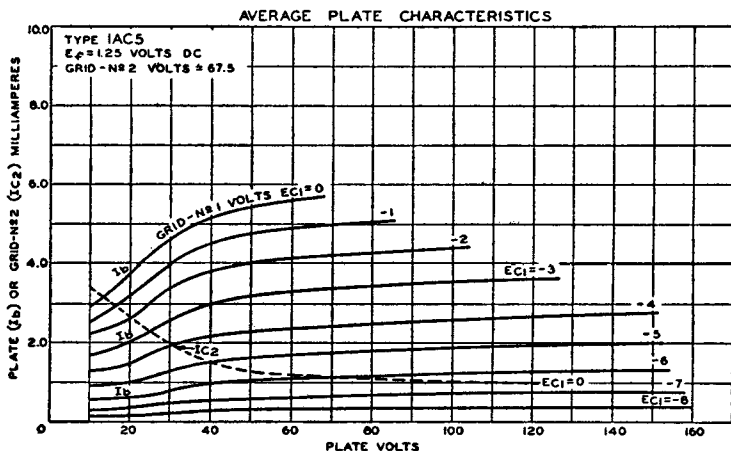

92CM-7247T

straight before they are inserted into the socket. Insertion will be facilitated if pins 1 and 8 are first aligned with their respective socket holes and the tube then gently pressed into the socket. Outline 8, OUTLINES SECTION.

The filament of the 1AC5 may be connected directly across a dry-cell battery rated at a terminal potential of 1.5 volts. In no case should the voltage across the filament ever exceed 1.6 volts. For additional filament considerations, refer to ELECTRON TUBE INSTALLATION SECTION.

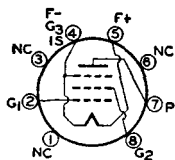

## SHARP-CUTOFF PENTODE

Subminiature type used as rf or if amplifier in stages not controlled by avc in small, compact, battery-operated receivers for the standard AM broadcast band. Because of internal shield-

# 1AD5

ing feature, an external bulb shield is not needed, but socket shielding is essential if minimum grid-No.1-to-plate capacitance is to be obtained. The 1AD5 and the other RCA subminiature types 1AC5, 1E8, and 1T6 comprise a complete tube complement for lightweight portable radio receivers having extremely low battery drain. Outline 8, OUTLINES SECTION. Tube requires subminiature eight-contact socket and may be mounted in any position. For installation and application considerations, refer to type 1AC5.

FILAMENT VOLTAGE (DC).....	1.25	volts
FILAMENT CURRENT.....	0.04	ampere
DIRECT INTERELECTRODE CAPACITANCES (No external shields):		
Grid No.1 to Plate.....	0.010 max	$\mu\text{f}$
Input.....	1.8	$\mu\text{f}$
Output.....	2.8	$\mu\text{f}$

### Maximum Ratings:

### CLASS A<sub>1</sub> AMPLIFIER

PLATE VOLTAGE.....	67.5 max	volts
GRID-NO.2 (SCREEN) VOLTAGE.....	67.5 max	volts
TOTAL CATHODE CURRENT.....	4.0 max	ma

### Typical Operation:

Plate Voltage.....	30	45	67.5	volts
Grid-No.2 Voltage.....	30	45	67.5	volts
Grid-No.1 (Control-Grid) Voltage.....	0	0	0	volts
Plate Resistance (Approx.).....	0.7	0.7	0.7	megohm
Transconductance.....	430	580	735	$\mu\text{mbos}$
Grid-No.1 Bias (Approx.) for plate current of 10 $\mu\text{a}$ .....	-3	-4	-6	volts
Plate Current.....	0.45	0.9	1.85	ma
Grid-No.2 Current.....	0.16	0.35	0.75	ma

AVERAGE PLATE CHARACTERISTICS

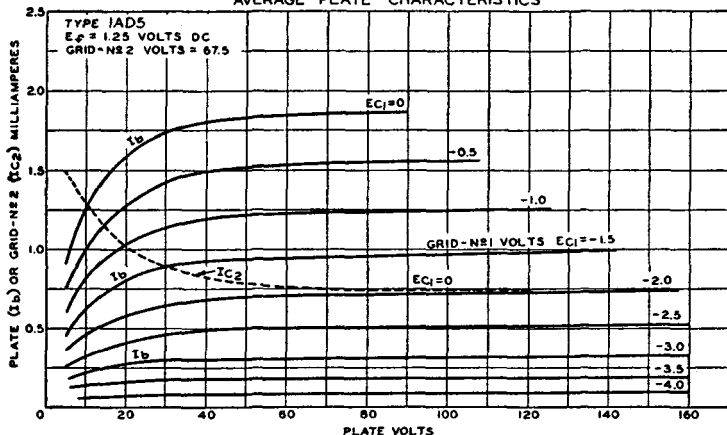

92CM-7252T

### HALF-WAVE VACUUM RECTIFIER

## 1B3-GT

Glass octal type used in high-voltage, low-current applications such as the rectifier in a high-voltage, rf-operated power supply or as a rectifier of high-voltage pulses produced in television

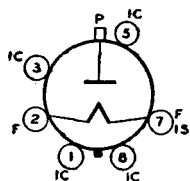

scanning systems. When used as an rf rectifier, one 1B3-GT in a half-wave circuit is capable of delivering a maximum dc output voltage of about 15000 volts. In a voltage-doubler circuit, two tubes will give about 30000 volts; and in a voltage-tripler circuit, three 1B3-GT's will deliver 45000 volts approximately.

FILAMENT VOLTAGE (AC) .....	1.25	volts
FILAMENT CURRENT .....	0.2	ampere
DIRECT INTERELECTRODE CAPACITANCE (No external shield):		
Plate to Filament (Approx.) .....	1.5	$\mu\mu\text{f}$

Maximum Ratings:		
HALF-WAVE RECTIFIER		
PEAK INVERSE PLATE VOLTAGE .....	30000 max	volts
PEAK PLATE CURRENT .....	17 max	ma
AVERAGE PLATE CURRENT .....	2 max	ma
FREQUENCY OF SUPPLY VOLTAGE .....	300 max	Kc

### INSTALLATION AND APPLICATION

Type 1B3-GT requires an octal socket and may be mounted in any position. Plate connection is cap at top of bulb. Internal connections are made to pins 1, 3, 5, and 8. These pins may be connected to pin 7, otherwise, they should not be used. Outline 29, OUTLINES SECTION.

When the filament is to be operated on rf, it is recommended that the filament be connected first to a dc or low-frequency ac supply of 1.25 volts. The color temperature of the filament corresponding to this voltage may then be checked visually by observing in a darkened room the reflection of the incandescent filament upon the upper surface of the internal shield. A visual comparison of this color temperature with that obtained with the filament operated from an rf voltage provides a convenient means for adjusting the amount of rf excitation to produce 1.25 volts (rms) at the filament terminals. The filament must never, under any conditions of operation, be allowed to reach a temperature higher than that caused by operating the filament on dc or low-frequency ac at a voltage of 1.5 volts. Operation at higher temperatures, even momentarily during circuit adjustments, is certain to cause impaired performance of the tube even though the filament still lights.

The filament transformer, whether it is of the iron-core or the air-core type, must have sufficient insulation to withstand the maximum peak inverse plate voltage encountered in the installation.

The high voltages at which the 1B3-GT is operated are very dangerous. Great care should be taken to prevent coming in contact with these high voltages. In those circuits where the filament circuit is not grounded, the filament circuit operates at dc potentials which can cause fatal shock. Extreme precautions must be taken when the filament voltage is measured. These precautions must include safeguards which definitely eliminate all hazards to personnel.

When used in television receivers and other equipment operating at 16000 volts or above, the 1B3-GT will produce X-rays which can constitute a health hazard unless the tube is adequately shielded.



**SHARP-CUTOFF PENTODE**

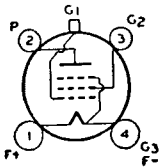

Glass type used as rf amplifier or detector in battery-operated receivers. Outline 34, OUTLINES SECTION. Tube requires four-contact socket. For typical operating conditions and maximum ratings as a class A<sub>1</sub> amplifier, refer to type 1E5-GP. Filament volts (dc), 2.0; amperes, 0.06. This type is used principally for renewal purposes.

**1B4-P**

**TWIN DIODE—MEDIUM-MU TRIODE**

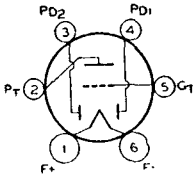

Glass type used as combined detector, amplifier, and avc tube in battery-operated receivers. Outline 32, OUTLINES SECTION. Tube requires six-contact socket. Filament volts (dc), 2.0; amperes, 0.06. Typical operation as class A<sub>1</sub> amplifier: plate volts, 135 max; grid volts, -3; plate ma., 0.8; plate resistance 35000, ohms; amplification factor, 20; transconductance, 575 μmhos. This type is used principally for renewal purposes.

**1B5/25S**

**PENTAGRID CONVERTER**

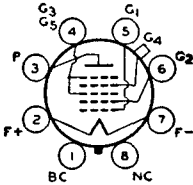

Glass octal type used in superheterodyne circuits having battery power supply. Outline 23, OUTLINES SECTION. Filament volts (dc), 1.4; amperes, 0.1. This is a DISCONTINUED type listed for reference only. The 1B7-GT may be replaced by the 1A7-GT if circuit adjustment is made for lower filament current of type 1A7-GT.

**1B7-GT**

**POWER PENTODE**

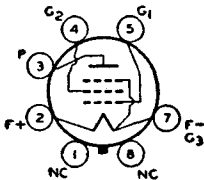

Glass octal type used in output stage of battery-operated receivers. Outline 22, OUTLINES SECTION. Tube requires octal socket and may be mounted in any position. For filament considerations, refer to 1U4. Type 1C5-GT is used principally for renewal purposes.

**1C5-GT**

FILAMENT VOLTAGE (DC).....	1.4	volts
FILAMENT CURRENT.....	0.1	ampere

**Maximum Ratings:**

**CLASS A<sub>1</sub> AMPLIFIER**

PLATE VOLTAGE.....	110 max	volts
GRID-NO.2(SCREEN) VOLTAGE.....	110 max	volts
TOTAL ZERO-SIGNAL CATHODE CURRENT.....	12 max	ma

**Typical Operation:**

Plate Voltage.....	83	90	volts
Grid-No.2 Voltage.....	83	90	volts
Grid-No.1 (Control-Grid) Voltage.....	-7.0	-7.5	volts
Peak AF Grid-No.1 Voltage.....	7.0	7.5	volts
Zero-Signal Plate Current.....	7.0	7.5	ma
Maximum-Signal Plate Current.....	7.3	7.8	ma
Zero-Signal Grid-No.2 Current.....	1.6	1.6	ma
Maximum-Signal Grid-No.2 Current.....	3.5	3.5	ma
Plate Resistance (Approx.).....	110000	115000	ohms
Transconductance.....	1500	1550	μmhos
Load Resistance.....	9000	8000	ohms
Total Harmonic Distortion.....	10	10	per cent
Maximum-Signal Power Output.....	200	240	mw

1C6

PENTAGRID CONVERTER

Glass type used in battery-operated receivers. Similar electrically to type 1C7-G except for interelectrode capacitances. Outline 34, OUTLINES SECTION. Tube requires six-contact socket. Filament volts (dc), 2.0; amperes, 0.12. For general discussion of pentagrid types, refer to Frequency Conversion in ELECTRON TUBE APPLICATIONS SECTION. This type is used principally for renewal purposes.

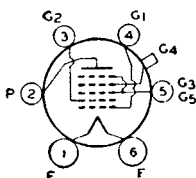

1C7-G

PENTAGRID CONVERTER

Glass octal type used in battery-operated receivers. Outline 33, OUTLINES SECTION. Tube requires octal socket. Filament volts (dc), 2.0; amperes, 0.12. Typical operation as converter: plate volts, 180 *max*; grids-No.3-and-No.5 (screen) volts, 67.5 *max*; grid-No.2 (anode grid) supply volts, 180 (applied through 20000-ohm dropping resistor bypassed by 0.01- $\mu$ f capacitor); grid-No.4 (control-grid) volts, -3;

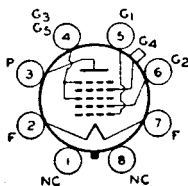

grid-No.1 (oscillator-grid) resistor, 50000 ohms; plate ma., 1.5; grids-No.3-and-No.5 ma., 2; grid-No.2 ma., 4; grid-No.1 ma., 0.2. This type is used principally for renewal purposes.

REMOTE-CUTOFF PENTODE

Glass octal type used in battery-operated receivers as rf or if amplifier. Outline 33, OUTLINES SECTION. Tube requires octal socket. Filament volts (dc), 2.0; amperes, 0.06. Typical operation as class A<sub>1</sub> amplifier: plate volts, 180 *max*; grid-No.2 (screen) volts, 67.5 *max*; grid-No.1 volts, -3 *min*; plate ma., 2.3; grid-No.2 ma., 0.8; plate resistance (approx.), 1.0 megohm; transconductance, 750  $\mu$ mhos. This type is used principally for renewal purposes.

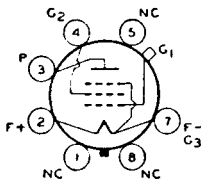

1D5-GP

REMOTE-CUTOFF TETRODE

Glass octal type used in battery-operated receivers as rf or if amplifier. Outline 33, OUTLINES SECTION. Filament volts (dc), 2.0; amperes, 0.06. This is a DISCONTINUED type listed for reference only. It can be replaced by type 1D5-GP.

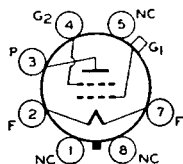

1D5-GT

PENTAGRID CONVERTER

Glass octal type used in battery-operated receivers. Outline 33, OUTLINES SECTION. Tube requires octal socket. Filament volts (dc), 2.0; amperes, 0.06. Typical operation as converter: plate volts, grids-No.3-and-No.5 volts, grid-No.2 supply volts, grid-No.4 volts, and grid-No.1 resistor are same as for type 1C7-G; plate ma., 1.3; grids-No.3-and-No.5 ma., 2.4; grid-No.2 ma., 2.3; grid-No.1 ma., 0.2. This type is used principally for renewal purposes.

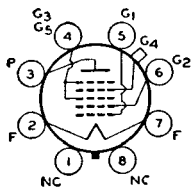

1D7-G

DIODE—TRIODE—POWER PENTODE

Glass octal type used in compact battery-operated receivers. Diode unit is used as detector or avc tube, triode as first audio amplifier, and pentode as power output tube. Outline 20, OUTLINES SECTION. Tube requires octal socket. Filament volts (dc), 1.4; amperes, 0.1. Maximum plate volts of triode as well as maximum plate and grid-No.2 volts of pentode, 110.

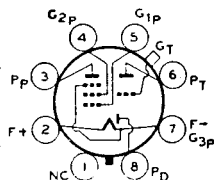

1D8-GT

## CLASS A<sub>1</sub> AMPLIFIER

### Typical Operation (Pentode Unit):

Plate Voltage.....	45	67.5	90	volts
Grid-No.2 (Screen) Voltage.....	45	67.5	90	volts
Grid-No.1 (Control-Grid) Voltage.....	-4.5	-6	-9	volts
Plate Current.....	1.6	3.8	5	ma
Grid-No.2 Current.....	0.3	0.8	1.0	ma
Transconductance.....	650	875	925	$\mu$ mhos
Load Resistance.....	20000	16000	12000	ohms
Total Harmonic Distortion.....	10	10	10	per cent
Power Output.....	35	100	200	mw

### Typical Operation (Triode Unit):

Plate Voltage.....	45	67.5	90	volts
Grid Voltage.....	0	0	0	volts
Amplification Factor.....	25	25	25	
Plate Resistance (Approx.).....	77000	55500	43500	ohms
Transconductance.....	325	450	575	$\mu$ mhos
Plate Current.....	0.3	0.6	1.1	ma

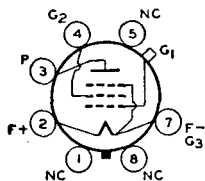

### SHARP-CUTOFF PENTODE

Glass octal type used as rf amplifier or detector in battery-operated receivers. Outline 33, OUTLINES SECTION. Tube requires octal socket. Filament volts (dc), 2.0; amperes, 0.06. Typical operation as class A<sub>1</sub> amplifier: plate volts, 180 *ma*; grid-No.2 (screen) volts, 67.5 *ma*; grid-No.1 volts, -3; plate *ma.*, 1.7; grid-No.2 *ma.*, 0.6; plate resistance, 1.5 megohms; transconductance, 650  $\mu$ mhos; grid volts for plate-current cutoff (approx.), -8. This type is used principally for renewal purposes.

## 1E5-GP

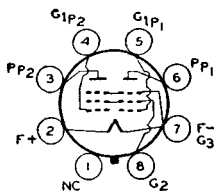

### TWIN POWER PENTODE

Glass octal type used in push-pull output stage of battery-operated receivers. Outline 22, OUTLINES SECTION. Tube requires octal socket. Filament volts (dc), 2.0; amperes, 0.24. Typical operation as push-pull class A<sub>1</sub> amplifier: plate and grid-No.2 volts, 135 *ma*; grid-No.1 volts, -7.5; plate *ma.*, 10.5; grid-No.2 *ma.*, 3.5; output watts, 0.575. The two units are used in the same manner as two separate tubes in conventional push-pull audio-frequency amplifier circuits. This type is used principally for renewal purposes.

## 1E7-GT

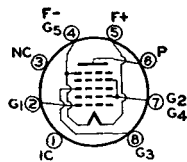

### PENTAGRID CONVERTER

Subminiature type used in small, compact, battery-operated receivers for the standard AM broadcast band. The 1E8 and the other RCA subminiature types 1AC5, 1AD5, and 1T6

## 1E8

comprise a complete tube complement for lightweight portable radio receivers having extremely low battery drain. Outline 8, OUTLINES SECTION. Tube requires subminiature eight-contact socket and may be mounted in any position. For general discussion of pentagrid types, see Frequency Conversion in ELECTRON TUBE APPLICATIONS SECTION. For installation and application considerations, refer to type 1AC5.

# RCA RECEIVING TUBE MANUAL

FILAMENT VOLTAGE (DC) .....	1.25	volts
FILAMENT CURRENT .....	0.04	ampere
<b>DIRECT INTERELECTRODE CAPACITANCES (No external shield):</b>		
Grid No.3 to All Other Electrodes (RF Input) .....	6.0	$\mu\mu\text{f}$
Plate to All Other Electrodes (Mixer Input) .....	5.0	$\mu\mu\text{f}$
Grid No.1 to All Other Electrodes (Oscillator Input) .....	2.4	$\mu\mu\text{f}$
Grid No.3 to Plate .....	0.4 max	$\mu\mu\text{f}$
Grid No.3 to Grid No.1 .....	0.2 max	$\mu\mu\text{f}$

## CONVERTER SERVICE

<b>Maximum Ratings:</b>		
PLATE VOLTAGE .....	67.5 max	volts
GRIDS-NO.2 AND NO.4 (SCREEN) VOLTAGE .....	45 max	volts
GRIDS-NO.2 AND NO.4 SUPPLY VOLTAGE .....	67.5 max	volts
TOTAL CATHODE CURRENT .....	4.0 max	ma

### Characteristics (Separate Excitation): #

Plate Voltage .....	30	45	67.5	volts
Grids-No.2 and No.4 Supply Voltage .....	30	45	67.5	volts
Grids-No.2 and No.4 Resistor .....	10000	15000	20000	ohms
Grid-No.3 (Control-Grid) Voltage .....	0	0	0	volts
Grid-No.1 (Oscillator-Grid) Resistor .....	0.1	0.1	0.1	megohm
Plate Resistance (Approx.) .....	0.3	0.4	0.4	megohm
Conversion Transconductance .....	115	140	150	$\mu\text{mhos}$
Grid-No.3 Voltage for Conversion Transconductance of 5 $\mu\text{mhos}$ (Approx.) .....	-7	-8	-9	volts
Plate Current .....	0.3	0.6	1.0	ma
Grids-No.2 and No.4 Current .....	0.8	1.1	1.5	ma
Grid-No.1 Current .....	30	50	70	$\mu\text{a}$
Total Cathode Current .....	1.1	1.7	2.5	ma

NOTE: The transconductance between grid No.1 and grids No.2 and No.4 connected to plate (not oscillating) is approximately 730  $\mu\text{mhos}$  under the following conditions: signal applied to grid No.1 at zero bias; grids No.2 and No.4 and plate at 30 volts; and grid-No.3 grounded. Under the same conditions, the total cathode current is 3 milliamperes and the amplification factor is 3.9.

#The characteristics shown under separate excitation approximate those obtained in a self-excited oscillator operating with zero bias.

**OPERATION CHARACTERISTICS WITH SEPARATE OSCILLATOR EXCITATION**

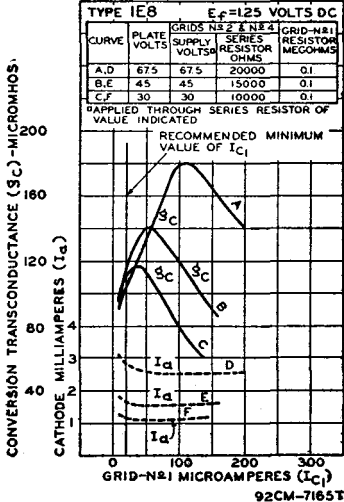

**OPERATION CHARACTERISTICS WITH SEPARATE OSCILLATOR EXCITATION**

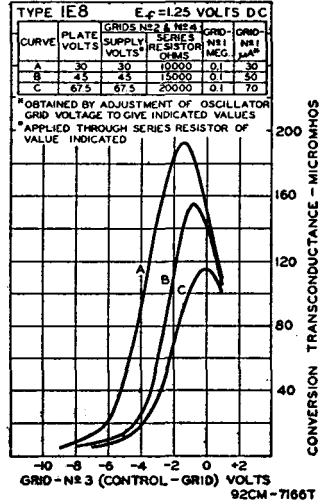

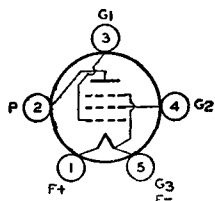

### POWER PENTODE

Glass type used in output stage of battery-operated receivers. Outline 36, **OUTLINES SECTION**. Tube requires five-contact socket. Filament volts (dc), 2.0; amperes, 0.12. Type 1F4 is similar electrically to type 1F5-G. This type is used principally for renewal purposes.

## 1F4

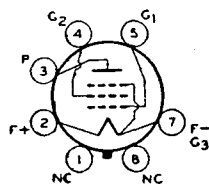

### POWER PENTODE

Glass octal type used in output stage of battery-operated receivers. Outline 35, **OUTLINES SECTION**. Tube requires octal socket. Filament volts (dc), 2.0; amperes, 0.12. Typical operation as class A<sub>1</sub> amplifier: plate and grid-No.2 (screen) volts, 135 (180 *max*); grid-No.1 volts, -4.5; plate ma., 8; grid-No.2 ma., 2.4; cathode resistor, 432 ohms; output watts, 0.31. This type is used principally for renewal purposes.

## 1F5-G

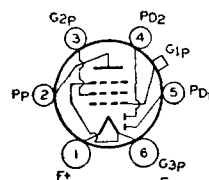

### TWIN DIODE— SHARP-CUTOFF PENTODE

Glass type used as combined detector, amplifier, and avc tube in battery-operated receivers. Outline 34, **OUTLINES SECTION**. Tube requires six-contact socket. Filament volts (dc), 2.0; amperes, 0.06. This type is similar electrically to type 1F7-G, except for interelectrode capacitances. Typical operation of pentode unit as class A<sub>1</sub> amplifier: plate volts,

## 1F6

180 *max*; grid-No.2 (screen) volts, 67.5 *max*; grid-No.1 volts, -1.5; plate ma., 2.2; grid-No.2 ma., 0.7. This type is used principally for renewal purposes.

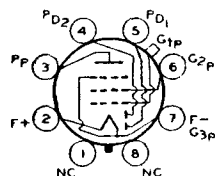

### TWIN DIODE— SHARP-CUTOFF PENTODE

Glass octal type used as combined detector, amplifier, and avc tube in battery-operated receivers. Outline 33, **OUTLINES SECTION**. Tube requires octal socket. Filament volts (dc), 2.0; amperes, 0.06. Similar electrically to type 1F6 except for interelectrode capacitances. This type is used principally for renewal purposes.

## 1F7-G

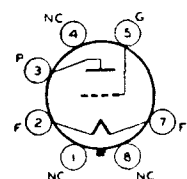

### MEDIUM-MU TRIODE

Glass octal type used in battery-operated receivers as detector or voltage amplifier. Outline 22, **OUTLINES SECTION**. Tube requires octal socket. Filament volts (dc), 1.4; amperes, 0.05. Typical operation and characteristics as class A<sub>1</sub> amplifier: plate volts, 90 (110 *max*); grid volts, -6; plate ma., 2.3; plate resistance, 10700 ohms; amplification factor, 8.8; transconductance, 825  $\mu$ mhos. This type has been used as a driver for type 1G6-GT.

## 1G4-GT

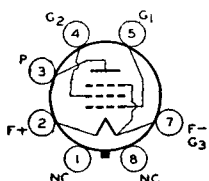

### POWER PENTODE

Glass octal type used in output stage of battery-operated receivers. Outline 35, **OUTLINES SECTION**. Tube requires octal socket. Filament volts (dc), 2.0; amperes, 0.12. Typical operation as class A<sub>1</sub> amplifier: plate and grid-No.2 (screen) volts, 135 *max*; grid-No.1 volts, -13.5; plate ma., 9.7; output watts, 0.55. This type is used principally for renewal purposes.

## 1G5-G

**HIGH-MU TWIN POWER TRIODE**

**1G6-GT**

Glass octal type used in output stage of battery-operated receivers. Outline 22, OUTLINES SECTION. Tube requires octal socket. Filament volts (dc), 1.4; amperes, 0.1. Typical operation as class B amplifier: plate volts, 90 (110 *max*); dc grid volts, 0; peak af grid-to-grid volts, 48; effective grid-circuit impedance per unit, 2530 ohms; plate ma. (zero signal), 2; plate ma. (maximum signal), 11; peak grid ma. per unit, 6; output watts (approx.), 0.35.

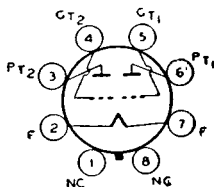

**MEDIUM-MU TRIODE**

**1H4-G**

Glass octal type used as detector or voltage amplifier in battery-operated receivers. Outline 31, OUTLINES SECTION. Tube requires octal socket. Filament volts (dc), 2.0; amperes, 0.06. Typical operation as class A<sub>1</sub> amplifier: plate volts, 180 *max*; grid volts, -13.5; amplification factor, 9.3; plate resistance, 10300 ohms; transconductance, 900  $\mu$ hos; plate ma., 3.1. For grid-bias detection, plate volts up to 180 *max*

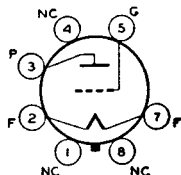

may be used and grid bias adjusted so that zero-signal plate ma. is about 0.2. This type is used principally for renewal purposes.

**DIODE—HIGH-MU TRIODE**

**1H5-GT**

Glass octal type used as combined detector and amplifier in battery-operated receivers. Outline 23, OUTLINES SECTION. Tube requires octal socket. Filament volts (dc), 1.4; amperes, 0.05. Characteristics of triode unit as class A<sub>1</sub> amplifier: plate volts, 90 (110 *max*); grid volts, 0; plate ma., 0.15; plate resistance, 240000 ohms; amplification factor, 65; transconductance, 275  $\mu$ hos. Diode is located at negative end of filament.

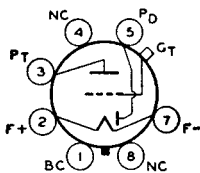

**TWIN DIODE—MEDIUM-MU TRIODE**

**1H6-G**

Glass octal type used as combined detector, amplifier, and avc tube in battery-operated receivers. Outline 31, OUTLINES SECTION. Tube requires octal socket. Filament volts (dc), 2.0; amperes, 0.06. Type 1H6-G is similar electrically to type 1B5/25S. This type is used principally for renewal purposes.

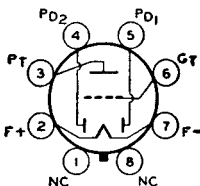

**POWER PENTODE**

**1J5-G**

Glass octal type used in output stage of battery-operated receivers. Outline 35, OUTLINES SECTION. Tube requires octal socket. Filament volts (dc), 2.0; amperes, 0.12. Typical operation as class A<sub>1</sub> amplifier: plate and grid-No.2 (screen) volts, 135 *max*; grid-No.1 volts, -16.5; plate ma., 7.0; grid-No.2 ma., 2.0; plate resistance, 105000 ohms; load resistance, 13500 ohms; output watts, 0.45. This is a DISCONTINUED type listed for reference only.

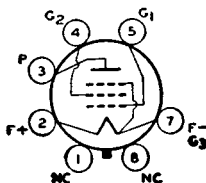

**HIGH-MU TWIN POWER TRIODE**

**1J6-G**  
**1J6-GT**

Glass octal types used in output stage of battery-operated receivers. Type 1J6-G, Outline 31; type 1J6-GT, Outline 26, OUTLINES SECTION. Tubes require octal socket. Filament volts (dc), 2.0; amperes, 0.24. Typical operation as class B power amplifier: plate volts, 135 *max*; peak plate ma. per plate, 50 *max*; grid volts, 0; zero-signal plate ma. per plate, 5; effective plate-to-plate load resistance, 10000

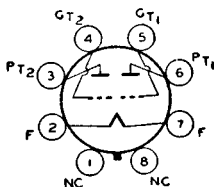

ohms; average input watts, 0.17; output watts, 2.1. Type 1J6-G is a DISCONTINUED type listed for reference only; type 1J6-GT is used principally for renewal purposes.

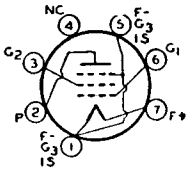

## SHARP-CUTOFF PENTODE

# 1L4

Miniature type used as rf or if amplifier in portable, battery-operated receivers particularly those not utilizing avc. Outline 12, OUTLINES SECTION. Tube requires miniature seven-contact socket and may be mounted in any position. Internal shield eliminates need for external bulb shield, but shielding the socket is essential if minimum grid-No.1-to-plate capacitance is required. For typical operation as a resistance-coupled amplifier, refer to Chart 1, RESISTANCE-COUPLED AMPLIFIER SECTION. For filament considerations, refer to type 1U4.

FILAMENT VOLTAGE (DC) .....	1.4	volts
FILAMENT CURRENT .....	0.05	ampere
DIRECT INTERELECTRODE CAPACITANCES (No external shield):		
Grid No.1 to Plate .....	0.01 <i>max</i>	$\mu\text{f}$
Input .....	3.6	$\mu\text{f}$
Output .....	7.5	$\mu\text{f}$

### CLASS A<sub>1</sub> AMPLIFIER

#### Maximum Ratings:

PLATE VOLTAGE .....	110 <i>max</i>	volts
GRID-NO.2 (SCREEN) VOLTAGE .....	90 <i>max</i>	volts
GRID-NO.3 SUPPLY VOLTAGE .....	110 <i>max</i>	volts
GRID-NO.1 (CONTROL-GRID) VOLTAGE, Positive Bias Value .....	0 <i>max</i>	volts
TOTAL CATHODE CURRENT .....	6.5 <i>max</i>	ma

#### Typical Operation:

Plate Voltage .....	90	90	volts
Grid-No.2 Voltage .....	67.5	90	volts
Grid-No.1 Voltage .....	0	0	volts
Plate Resistance .....	0.6	0.26	megohm
Transconductance .....	925	1025	$\mu\text{mhos}$
Grid-No. 1 Bias for plate current of 10 $\mu\text{a}$ .....	-6	-10	volts
Plate Current .....	2.9	4.5	ma
Grid-No. 2 Current .....	1.2	2.0	ma

AVERAGE PLATE CHARACTERISTICS

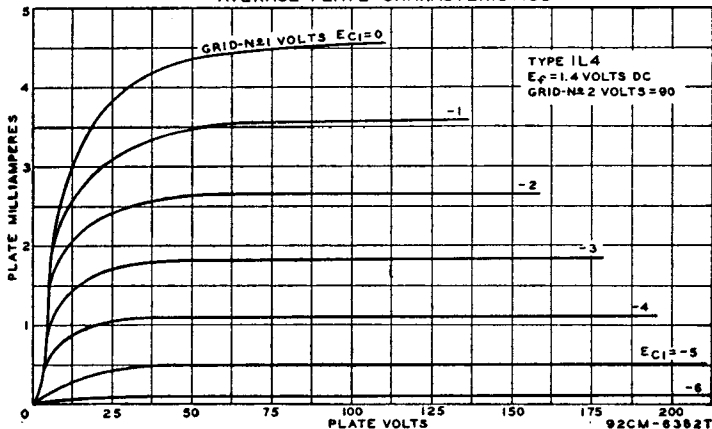

1LA4

POWER PENTODE

Glass lock-in type used in output stage of battery-operated receivers. Outline 14, OUTLINES SECTION. Tube requires lock-in socket. Filament volts (dc), 1.4; amperes, 0.05. For electrical characteristics and typical operation, refer to glass-octal type 1A5-GT.

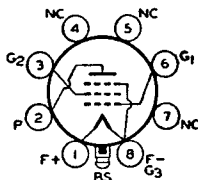

1LA6

PENTAGRID CONVERTER

Glass lock-in type used in battery-operated receivers. Outline 14, OUTLINES SECTION. Tube requires lock-in socket. Filament volts (dc), 1.4; amperes, 0.05. Typical operation as converter is the same as for type 1A7-GT except that the maximum grid-No.2 volts is 65, the maximum total cathode ma. is 4.0, the plate resistance is 0.75 megohm, and the conversion transconductance for a grid-No.4 (control-grid) bias of -3 volts is 10  $\mu$ mhos.

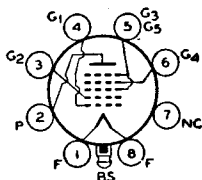

1LB4

POWER PENTODE

Glass lock-in type used in output stage of battery-operated receivers. Outline 14, OUTLINES SECTION. Tube requires lock-in socket. Filament volts (dc), 1.4; amperes, 0.05. For electrical characteristics, refer to pentode unit of glass-octal type 1D8-GT.

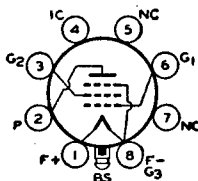

1LC5

SHARP-CUTOFF PENTODE

Glass lock-in type used as rf or if amplifier in battery-operated receivers. Outline 14, OUTLINES SECTION. Tube requires lock-in socket. Filament volts (dc), 1.4; amperes, 0.05. Typical operation as class A<sub>1</sub> amplifier: plate volts, 90 (110 max); grid-No.2 (screen) volts, 45 max; grid-No.1 volts, 0; plate resistance (approx.), greater than 1 megohm; transconductance, 775  $\mu$ mhos; plate ma., 1.15; grid-No.2 ma., 0.3.

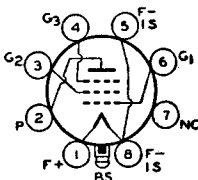

1LC6

PENTAGRID CONVERTER

Glass lock-in type used in battery-operated receivers. Outline 14, OUTLINES SECTION. Tube requires lock-in socket. Filament volts (dc), 1.4; amperes, 0.05. Typical operation as converter: plate volts, 90 (110 max); grids-No.3-and-No.5 volts, 35 (45 max); grid-No.2 volts, 45; grid-No.1 volts, 0; plate resistance, 0.65 megohm; plate ma., 0.75; grids-No.3-and-No.5 ma., 0.70; grid-No.2 ma., 1.4; total cathode ma., 2.9; conversion transconductance (zero bias), 275  $\mu$ mhos.

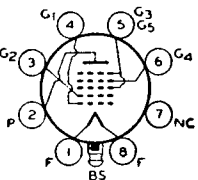

1LD5

DIODE—SHARP-CUTOFF PENTODE

Glass lock-in type used as combined detector and af voltage amplifier in battery-operated receivers. Outline 14, OUTLINES SECTION. Tube requires lock-in socket. Filament volts (dc), 1.4; amperes, 0.05. Characteristics of pentode unit: plate volts, 90 (110 max); grid-No.2 volts, 45; grid-No.1 volts, 0; plate ma., 0.6; grid-No.2 ma., 0.1; plate resistance, 0.75 megohm; transconductance, 575  $\mu$ mhos.

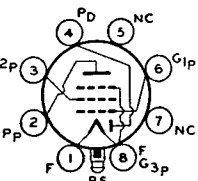



**MEDIUM-MU TRIODE**

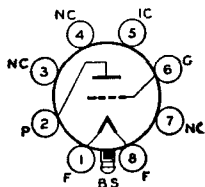

Glass lock-in type used as detector or voltage amplifier in battery-operated receivers. Outline 14, OUTLINES SECTION. Tube requires lock-in socket. Filament volts (dc), 1.4; amperes, 0.05. Typical operation as class A<sub>1</sub> amplifier: plate volts, 90 (110 max); grid volts, -3; plate ma., 1.4; plate resistance, 19000 ohms; transconductance, 760 μmhos; amplification factor, 14.5.

**1LE3**

**REMOTE-CUTOFF PENTODE**

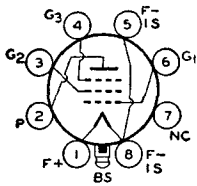

Lock-in type used as rf or if amplifier in battery-operated receivers. Outline 14, OUTLINES SECTION. Tube requires lock-in socket. Filament volts (dc), 1.4; amperes, 0.05. Typical operation and maximum ratings as class A<sub>1</sub> amplifier: plate volts, 90 (110 max); grid-No.2 volts, 45 (110 max); grid-No.1 volts, 0; plate resistance (approx.), greater than 1 megohm; transconductance, 800 μmhos; plate ma., 1.7; grid-No.2 ma., 0.4; grid-No.1 voltage for transconductance of 10 μmhos, -10 volts.

**1LG5**

**DIODE—HIGH-MU TRIODE**

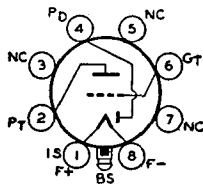

Glass lock-in type used as combined detector and amplifier in battery-operated receivers. Outline 14, OUTLINES SECTION. Tube requires lock-in socket. Filament volts (dc), 1.4; amperes, 0.05. For electrical characteristics, refer to glass-octal type 1H5-GT.

**1LH4**

**SHARP-CUTOFF PENTODE**

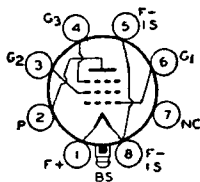

Glass lock-in type used as rf or if amplifier in battery-operated receivers. Outline 14, OUTLINES SECTION. Tube requires lock-in socket. Filament volts (dc), 1.4; amperes, 0.05. Typical operation as class A<sub>1</sub> amplifier: plate and grid-No.2 (screen) volts, 90 (110 max); grid-No.1 volts, 0; plate ma., 1.6; grid-No.2 ma., 0.35; plate resistance (approx.), 1.1 megohms; transconductance, 800 μmhos.

**1LN5**

**SHARP-CUTOFF PENTODE**

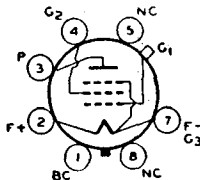

Glass octal type used as rf or if amplifier in battery-operated receivers. Outline 23, OUTLINES SECTION. Tube requires octal socket and may be mounted in any position. When used

**1N5-GT**

in avc circuits, the 1N5-GT should be only partially controlled to avoid excessive reduction in receiver sensitivity with large signal input.

FILAMENT VOLTAGE (DC).....	1.4	volt
FILAMENT CURRENT.....	0.05	ampere
DIRECT INTERELECTRODE CAPACITANCES:*		
Grid No.1 to Plate.....	0.007 max	μf
Input.....	8	μf
Output.....	10	μf

\* With external shield connected to negative filament terminal.

**Typical Operation:**
**CLASS A<sub>1</sub> AMPLIFIER**

Plate Voltage (110 volts <i>max.</i> )	90	volts
Grid-No.2 (Screen) Voltage (1.0 volts <i>max.</i> )	90	volts
Grid-No.1 Voltage	0	volts
Plate Resistance (Approx.)	1.5	megohms
Transconductance	750	$\mu$ mos
Grid-No.1 Bias (Approx.) for transconductance of 5 $\mu$ mos	-4	volts
Plate Current	1.2	ma
Grid-No.2 Current	0.3	ma

### DIODE—POWER PENTODE

Glass octal type used as combined detector and power output tube in battery-operated receivers. Filament volts (dc), 1.4; amperes, 0.05. Typical operation of pentode unit as class A<sub>1</sub> amplifier: plate and grid-No.2 (screen) volts, 90 (110 *max.*); grid-No.1 volts, -4.5; plate ma., 3.1; grid-No.2 ma. (zero-signal), 0.6; plate resistance (approx.), 0.3 megohm; transconductance, 800  $\mu$ mos; load resistance, 25000 ohms; output watts, 0.1. This is a **DISCONTINUED** type listed for reference only.

## 1N6-G

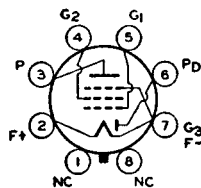

### REMOTE-CUTOFF PENTODE

Glass octal type used as rf or if amplifier in battery-operated receivers. Outline 23, **OUTLINES SECTION**. Tube requires octal socket. Filament volts (dc), 1.4; amperes, 0.05. Typical operation as class A<sub>1</sub> amplifier: plate volts, 90 (110 *max.*); grid-No.2 (screen) volts, 90 (110 *max.*); grid-No.1 volts, 0; plate resistance (approx.), 0.8 megohm; transconductance, 750  $\mu$ mos; transconductance (approx.) with -12 volts on grid-No.1, 10  $\mu$ mos; plate ma., 2.3; grid-No.2 ma., 0.7.

## 1P5-GT

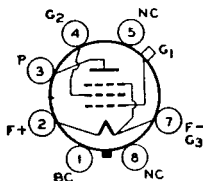

### BEAM POWER AMPLIFIER

Glass octal type used in the output stage of battery-operated receivers. Outline 22, **OUTLINES SECTION**. Tube requires octal socket. Filament volts (dc), 1.4; amperes, 0.1. For electrical characteristics and ratings, refer to type 3Q5-GT with parallel filament arrangement. This type is used principally for renewal purposes.

## 1Q5-GT

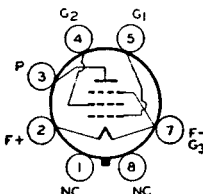

### PENTAGRID CONVERTER

Miniature type used in lightweight, portable, compact, battery-operated receivers. Outline 12, **OUTLINES SECTION**. Tube requires miniature seven-contact socket and may be mounted in

## 1R5

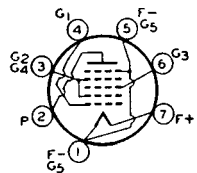

any position. For general discussion of pentagrid types, see **Frequency Conversion** in **ELECTRON TUBE APPLICATIONS SECTION**. For filament considerations, refer to type 1U4.

FILAMENT VOLTAGE (DC)	1.4	volts
FILAMENT CURRENT	0.05	ampere
<b>DIRECT INTERELECTRODE CAPACITANCES (No external shield):</b>		
Grid No.3 to All Other Electrodes (RF Input)	7.0	$\mu$ mf
Plate to All Other Electrodes (Mixer Output)	7.5	$\mu$ mf
Grid No.1 to All Other Electrodes (Osc. Input)	3.8	$\mu$ mf
Grid No.3 to Plate	0.4 <i>max</i>	$\mu$ mf
Grid No.3 to Grid No.1	0.2 <i>max</i>	$\mu$ mf
Grid No.1 to Plate	0.1 <i>max</i>	$\mu$ mf

## CONVERTER SERVICE

### Maximum Ratings:

PLATE VOLTAGE .....		90 <i>max</i>	volts
GRIDS-NO.2-AND-NO.4 (SCREEN) VOLTAGE .....		67.5 <i>max</i>	volts
GRIDS-NO.2-AND-NO.4 SUPPLY VOLTAGE .....		90 <i>max</i>	volts
GRID-NO.3 (CONTROL-GRID) VOLTAGE, Positive Bias Value .....		0 <i>max</i>	volts
TOTAL ZERO-SIGNAL CATHODE CURRENT .....		5.5 <i>max</i>	ma

### Typical Operation:

Plate Voltage .....	45	67.5	90	90		volts
Grids-No.2-and-No.4 Voltage .....	45	67.5	45	67.5		volts
Grid-No.3 Voltage .....	0	0	0	0		volts
Grid-No.1 Resistor .....	0.1	0.1	0.1	0.1		megohm
Plate Resistance (Approx.) .....	0.6	0.5	0.8	0.6		megohm
Conversion Transconductance .....	235	280	250	300		$\mu$ mhos
Grid-No.3 Bias for conversion trans- conductance of approx. 5 $\mu$ mhos .....	-9	-14	-9	-14		volts
Plate Current .....	0.7	1.4	0.8	1.6		ma
Grids-No.2-and-No.4 Current .....	1.9	3.2	1.9	3.2		ma
Grid-No.1 Current .....	0.15	0.25	0.15	0.25		ma
Total Cathode Current .....	2.75	5	2.75	5		ma

**NOTE:** The transconductance between grid No.1 and grids No.2 and No.4 tied to plate (not oscillating) is approximately 1400  $\mu$ mhos under the following conditions: grids No.1 and No.3 at 0 volts; grids No.2 and No.4 and plate at 67.5 volts.

**OPERATION CHARACTERISTICS**

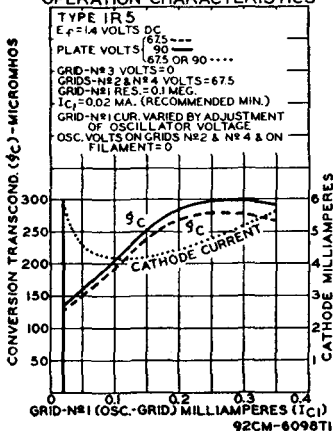

**OPERATION CHARACTERISTICS**

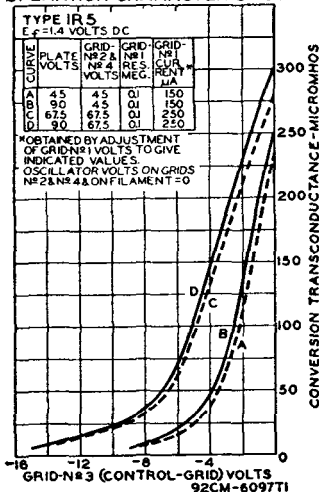

## POWER PENTODE

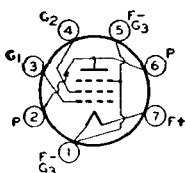

Miniature type used in output stage of lightweight, compact, portable, battery-operated equipment. Types 1S4 and 3S4 are identical except for filament arrangement. Outline 12, OUTLINES SECTION. Type 1S4 requires miniature seven-contact socket and may be mounted in any position. For ratings, typical operation, and curves, refer to type 3S4 with parallel filament arrangement. For filament considerations, refer to type 1U4 and ELECTRON TUBE INSTALLATION SECTION. Filament volts (dc), 1.4; amperes, 0.1. This type is used principally for renewal purposes.

# 1S4

DIODE—

SHARP-CUTOFF PENTODE

1S5

Miniature type used in light-weight, compact, portable, battery-operated receivers as combined detector and af voltage amplifier. Outline 12,

OUTLINES SECTION. Filament volts (dc), 1.4; amperes, 0.05. Tube requires miniature seven-contact socket and may be mounted in any position. For electrical characteristics, curves, and application, refer to type 1U5.

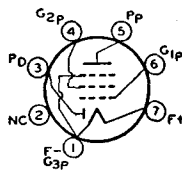

REMOTE-CUTOFF PENTODE

1T4

Miniature type used in light-weight, compact, portable, battery-operated receivers as rf or if amplifier. Because of internal shielding feature, an external bulb shield is not needed,

but socket shielding is essential if minimum grid-No.1-to-plate capacitance is to be obtained. Outline 12, OUTLINES SECTION. Tube requires miniature seven-contact socket and may be mounted in any position. For curve of average plate characteristics, see next page. For filament considerations, refer to type 1U4.

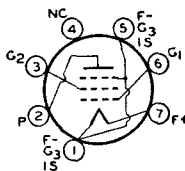

FILAMENT VOLTAGE (DC) .....	1.4	volts
FILAMENT CURRENT .....	0.05	ampere
DIRECT INTERELECTRODE CAPACITANCES:*		
Grid No.1 to Plate .....	0.01 max	$\mu\text{f}$
Input .....	3.6	$\mu\text{f}$
Output .....	7.5	$\mu\text{f}$

\* With close-fitting shield connected to negative filament terminal.

Maximum Ratings:

CLASS A<sub>1</sub> AMPLIFIER

PLATE VOLTAGE .....	90 max	volts
GRID-NO.2 (SCREEN) VOLTAGE .....	67.5 max	volts
GRID-NO.2 SUPPLY VOLTAGE .....	90 max	volts
GRID-NO.1 (CONTROL-GRID) VOLTAGE, Positive Bias Value .....	0 max	volts
TOTAL CATHODE CURRENT .....	5.5 max	ma

Typical Operation:

Plate Voltage .....	45	67.5	90	90	volts
Grid-No.2 Voltage .....	45	67.5	45	67.5	volts
Grid-No.1 Voltage .....	0	0	0	0	volts
Plate Resistance (Approx.) .....	0.35	0.25	0.8	0.5	megohm
Transconductance .....	700	875	750	900	$\mu\text{mhos}$
Grid-No.1 Bias for transconductance of 10 $\mu\text{mhos}$ .....	-10	-16	-10	-16	volts
Plate Current .....	1.7	3.4	1.8	3.5	ma
Grid-No.2 Current .....	0.7	1.5	0.65	1.4	ma

BEAM POWER AMPLIFIER

Glass octal type used in output stage of battery-operated receivers. Outline 22, OUTLINES SECTION. Tube requires octal socket. Filament volts (dc), 1.4; amperes, 0.05. For filament considerations, refer to type 1U4. Typical operation as class A<sub>1</sub> amplifier with fixed bias: plate and grid-No.2 (screen) volts, 90 (110 max); grid-No.1 volts, -6; peak af grid-No.1 volts, 6; plate ma. (maximum or zero-signal),

6.5; grid-No.2 ma. (zero-signal), 0.8; grid-No.2 ma. (maximum signal), 1.5; plate resistance, 0.25 megohm; transconductance, 1160  $\mu\text{mhos}$ ; load resistance, 14000 ohms; total harmonic distortion, 7.5 per cent; output watts, 0.17.

1T5-GT

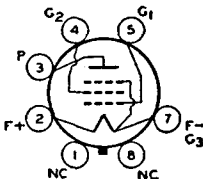

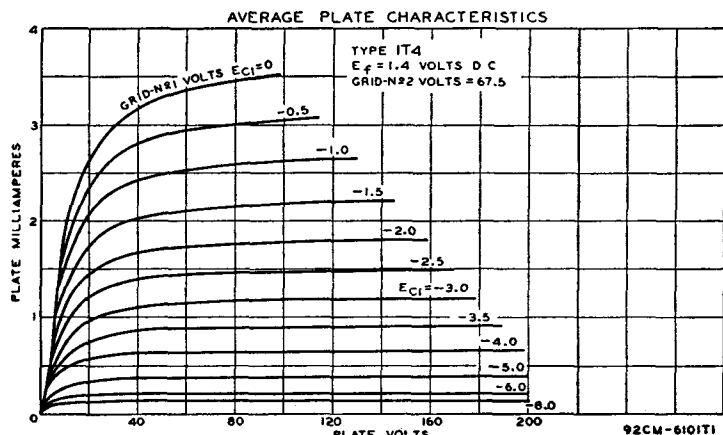

## DIODE—SHARP-CUTOFF PENTODE

# 1T6

Subminiature type used as combined detector and audio amplifier in small, compact, battery-operated receivers for the standard AM broadcast band. The 1T6 and the other RCA

subminiature types 1AC5, 1AD5, and 1E8 comprise a complete tube complement for lightweight portable radio receivers having extremely low battery drain. Outline 8, **OUTLINES SECTION**. Tube requires subminiature eight-contact socket and may be mounted in any position. For installation and application considerations, refer to type 1AC5.

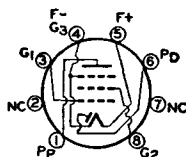

FILAMENT VOLTAGE (DC).....	1.25	volts
FILAMENT CURRENT.....	0.04	ampere

### PENTODE UNIT AS CLASS A<sub>1</sub> AMPLIFIER

**Maximum Ratings:**

PLATE VOLTAGE.....	67.5 max	volts
GRID-NO.2 (SCREEN) VOLTAGE.....	67.5 max	volts
TOTAL CATHODE CURRENT.....	2.0 max	ma

**Typical Operation:**

Plate Voltage.....	30	45	67.5	volts
Grid-No.2 (Screen) Voltage.....	30	45	67.5	volts
Grid-No.1 (Control-Grid) Voltage.....	0	0	0	volts
Plate Resistance (Approx.).....	0.5	0.5	0.4	megohm
Transconductance.....	330	475	600	μmhos
Plate Current.....	0.33	0.75	1.6	ma
Grid-No.2 Current.....	0.10	0.21	0.4	ma

### DIODE UNIT

<b>Maximum Rating:</b>		
PLATE CURRENT.....	0.25 max	ma

Diode unit is located at negative end of filament and is independent of the pentode unit except for the common filament.

AVERAGE PLATE CHARACTERISTICS

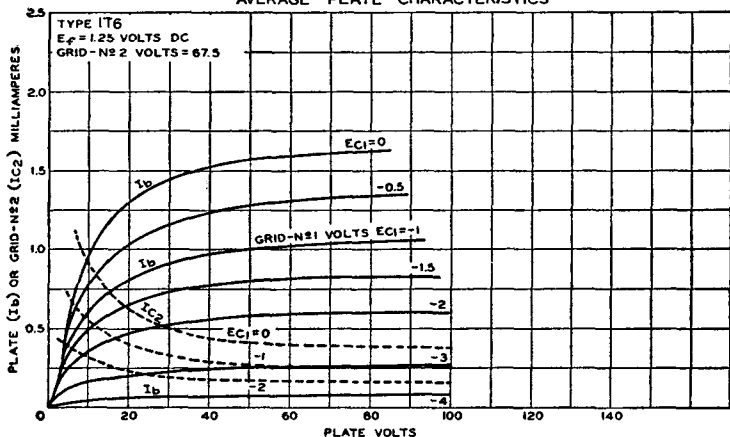

92CM-72587

## 1U4

### SHARP-CUTOFF PENTODE

Miniature type used as rf or if amplifier in stages not controlled by avc in lightweight, compact, portable, battery-operated equipment. Because the screen can be operated at the same

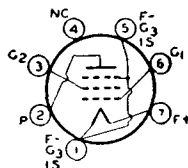

voltage as the plate, a voltage-dropping resistor is not needed. For typical operation as a resistance-coupled amplifier, refer to Chart 3, RESISTANCE-COUPLED AMPLIFIER SECTION.

FILAMENT VOLTAGE (DC) .....	1.4	volts
FILAMENT CURRENT .....	0.05	ampere
DIRECT INTERELECTRODE CAPACITANCES:*		
Grid No.1 to Plate .....	0.01 max	μf
Input .....	8.6	μf
Output .....	7.5	μf

\* External shield connected to negative filament terminal.

### CLASS A<sub>1</sub> AMPLIFIER

**Maximum Ratings:**

PLATE VOLTAGE .....	110 max	volts
GRID-NO.2 (SCREEN) VOLTAGE .....	110 max	volts
GRID-NO.1 (CONTROL-GRID) VOLTAGE:		
Negative bias value .....	80 max	volts
Positive bias value .....	0 max	volts
TOTAL CATHODE CURRENT .....	6 max	ma

**Typical Operation:**

Plate Voltage .....	90	volts
Grid-No.2 Voltage .....	90	volts
Grid-No.1 Voltage .....	0	volts
Plate Resistance (Approx.) .....	1.0	megohm
Transconductance .....	900	μmhos
Grid-No.1 Bias for transconductance of 10 μmhos .....	-4	volts
Plate Current .....	1.6	ma
Grid-No.2 Current .....	0.5	ma

## INSTALLATION AND APPLICATION

Type 1U4 requires a miniature seven-contact socket and may be mounted in any position. Outline 12, OUTLINES SECTION.

The filament power supply may be obtained from dry-cell batteries, from storage batteries, or from a power line. With dry-cell battery supply, the filament may be connected either directly across a battery rated at a terminal potential of 1.5 volts, or in series with the filaments of similar tubes across a power supply consisting of dry cells in series. In either case, the voltage across the filament should not exceed 1.6 volts.

With power-line or storage-battery supply, the filament may be operated in series with the filament of other tubes of the same filament-current rating. For such operation, design adjustments should be made so that, with tubes of rated characteristics, operating with all electrode voltages applied and on a normal line voltage of 117 volts or on a normal storage-battery voltage of 2.0 volts per cell (without a charger) or 2.2 volts per cell (with a charger), the voltage drop across the filament will be maintained within a range of 1.25 to 1.4 volts with a center of 1.3 volts.

In order to meet the recommended conditions for operating filaments in series from dry-battery, storage-battery, or power-line sources, it may be necessary to use shunting resistors across the individual 1.4-volt sections of filament. Refer to ELECTRON TUBE INSTALLATION SECTION for additional filament considerations.

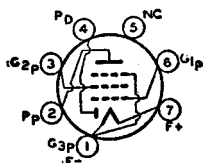
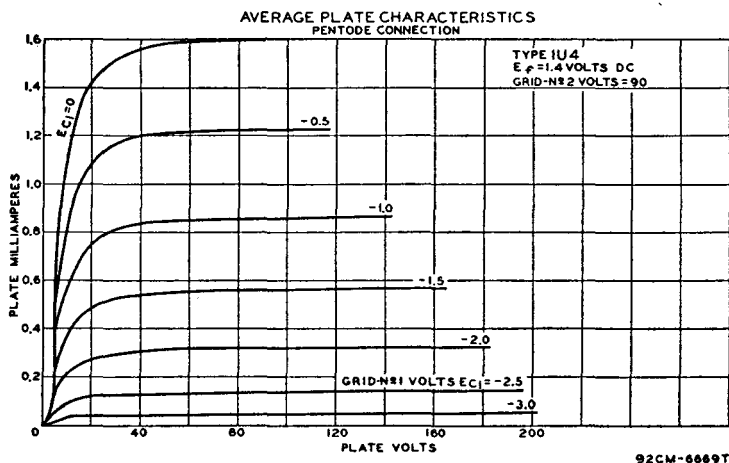

### DIODE—SHARP-CUTOFF PENTODE

Miniature type used in light-weight, compact, portable, battery-operated receivers as combined detector and af voltage amplifier. The 1U5 is similar to the 1S5 but utilizes an im-

# 1U5

proved structure which greatly reduces any tendency toward microphonic effects. In addition, the diode unit is effectively shielded from the pentode unit to prevent "play-through." Outline 12, OUTLINES SECTION. Tube requires miniature seven-contact socket and may be mounted in any position. For typical operation as a resistance-coupled amplifier, refer to Chart 2, RESISTANCE-COUPLED AMPLIFIER SECTION. For filament consideration, refer to type 1U4.

FILAMENT VOLTAGE (DC) .....	1.4	volts
FILAMENT CURRENT .....	0.05	ampere

### PENTODE UNIT AS CLASS A<sub>1</sub> AMPLIFIER

**Maximum Ratings:**

PLATE VOLTAGE .....	90 max	volts
GRID-NO.2 (SCREEN) VOLTAGE .....	90 max	volts
GRID-NO.1 (CONTROL-GRID) VOLTAGE:		
Negative bias value .....	50 max	volts
Positive bias value .....	0 max	volts
TOTAL CATHODE CURRENT .....	8 max	ma

**Characteristics:**

Plate Voltage .....	67.5	volts
Grid-No.2 Voltage .....	67.5	volts
Grid-No.1 Voltage .....	0	volts
Plate Resistance .....	0.6	megohm
Transconductance .....	625	μmhos
Grid-No.1 Bias for plate current of 10 μa .....	-5	volts
Plate Current .....	1.6	ma
Grid-No.2 Current .....	0.4	ma

### DIODE UNIT

**Maximum Rating:**

PLATE CURRENT .....	0.25 max	ma
---------------------	----------	----

Diode unit is located at negative end of filament and is independent of the pentode except for the common filament.

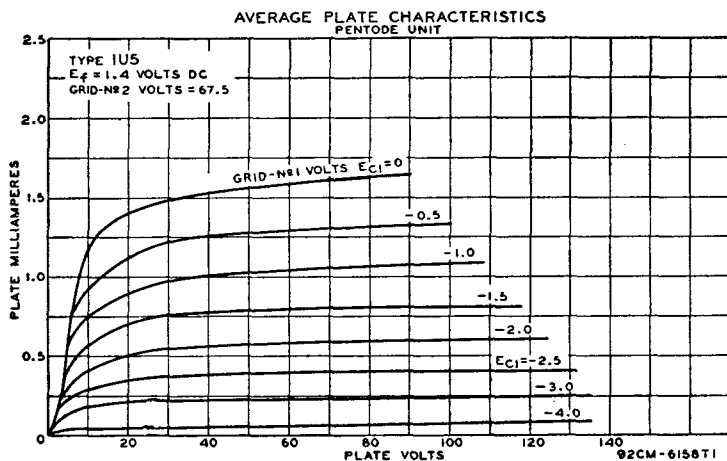



## HALF-WAVE VACUUM RECTIFIER

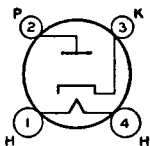

Glass type used in ac/dc or automobile receivers. Outline 32, OUTLINES SECTION. Tube requires four-contact socket. For heater considerations, refer to type 6AT6. Heater volts (ac/dc), 6.3; amperes, 0.3. Maximum ratings as half-wave rectifier: peak inverse plate volts, 1000; peak plate ma., 270; peak heater-cathode volts, 500; dc output ma., 45. This type is used principally for renewal purposes.

1-v

## HALF-WAVE VACUUM RECTIFIER

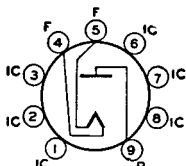

Miniature type used in high-voltage, low-current applications such as the rectifier in high-voltage, pulse-operated voltage-doubling power supplies for kinescopes. The very low power

1V2

required by the filament permits the use of a rectifier transformer having small size and light weight.

FILAMENT VOLTAGE (AC).....	0.625	volt
FILAMENT CURRENT.....	0.3	ampere
DIRECT INTERELECTRODE CAPACITANCE (No external shield):		
Plate to Filament (Approx.).....	0.8	μf

### HALF-WAVE RECTIFIER Pulsed Rectifier Service

**Maximum Ratings:**

PEAK INVERSE PLATE VOLTAGE.....	7500 max	volts
PEAK PLATE CURRENT.....	10 max	ma
AVERAGE PLATE CURRENT.....	0.5 max	ma

## INSTALLATION AND APPLICATION

Type 1V2 requires a noval nine-contact socket and may be mounted in any position. The socket should be made of material having low leakage and should have adequate insulation between its filament and plate terminals to withstand the maximum peak inverse plate voltage. To provide the required insulation in noval nine-contact sockets designed with a cylindrical center shield, it is necessary to remove the center shield. In addition, it is recommended that the socket clips for pins 1, 6, and 7 be removed to reduce the possibility of arc-over and minimize leakage. Outline 13, OUTLINES SECTION.

The filament is of the coated type and is designed for operation at 0.625 volt. The filament windings on the pulse transformer should be adjusted to provide the rated voltage under average line-voltage conditions. When the filament voltage is measured, it is recommended that an rms voltmeter of the thermal type be used. The meter and its leads must be insulated to withstand 15000 volts and the stray capacitances to ground should be minimized.

The high voltages at which the 1V2 is operated are very dangerous. Great care should be taken to prevent coming in contact with these high voltages. Particular care against fatal shock should be taken in measuring the filament voltage in those circuits where the filament is not grounded. Precautions must include safeguards which definitely eliminate all hazards to personnel.

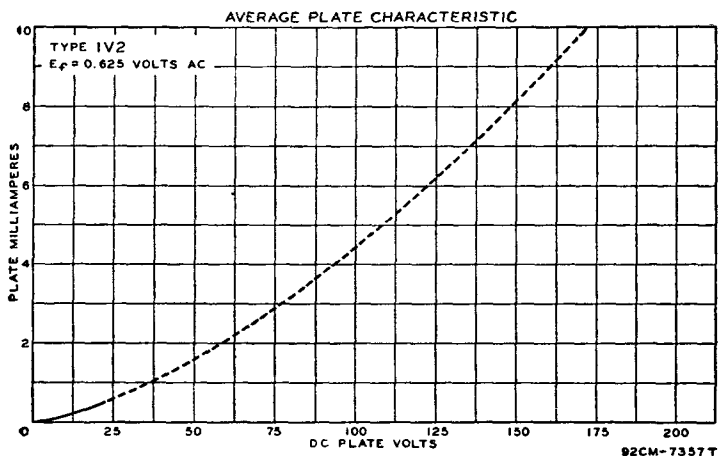

## 1X2-A

### HALF-WAVE VACUUM RECTIFIER

Miniature type used in high-voltage, low-current applications such as the rectifier in a high-voltage, rf-operated power supply, or as a rectifier of high-voltage pulses produced in television scanning systems. Outline 18, OUTLINES SECTION. Tube requires noval nine-contact socket and may be mounted in any position. Plate connection is cap at top of bulb. Pins 3 and 7 may be used as tie points for filament dropping resistor and high-voltage filter resistor, or may be connected to the filament. These pins should *not* be connected to low-potential circuits. For other filament and high-voltage considerations, refer to type 1B3-GT.

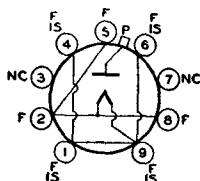

FILAMENT VOLTAGE (AC) ..... 1.25 volts  
 FILAMENT CURRENT ..... 0.2 ampere  
 DIRECT INTERELECTRODE CAPACITANCE (NO EXTERNAL SHIELD):  
     Plate to Filament (Approx.) ..... 1.0  $\mu$ f

#### Maximum Ratings:

HALF-WAVE RECTIFIER		
PEAK INVERSE PLATE VOLTAGE .....	18000 max	volts
PEAK PLATE CURRENT .....	10 max	ma
AVERAGE PLATE CURRENT .....	1 max	ma
FREQUENCY OF SUPPLY VOLTAGE .....	300 max	Kc

## 2A3

### POWER TRIODE

Glass type used in output stage of radio receivers and amplifiers. As a class A<sub>1</sub> power amplifier, the 2A3 is usable either singly or in push-pull combination.

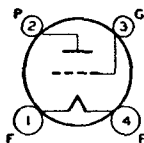

FILAMENT VOLTAGE (AC/DC) .....	2.5	volts
FILAMENT CURRENT .....	2.5	amperes
DIRECT INTERELECTRODE CAPACITANCES (Approx.):		
Grid to Plate .....	16.5	$\mu$ f
Input .....	7.5	$\mu$ f
Output .....	5.5	$\mu$ f

# RCA RECEIVING TUBE MANUAL

<b>Maximum Ratings:</b>		<b>CLASS A<sub>1</sub> AMPLIFIER</b>	
PLATE VOLTAGE.....	300 <i>max</i>	volts	
PLATE DISSIPATION.....	15 <i>max</i>	watts	

<b>Typical Operation:</b>			
Plate Voltage.....	250	volts	
Grid Voltage#.....	-45	volts	
Plate Current.....	60	ma	
Amplification Factor.....	4.2		
Plate Resistance.....	800	ohms	
Transconductance.....	5250	μmhos	
Load Resistance.....	2500	ohms	
Second Harmonic Distortion.....	5	per cent	
Power Output.....	3.5	watts	

<b>Maximum Ratings:</b>		<b>PUSH-PULL CLASS AB<sub>1</sub> AMPLIFIER</b>	
PLATE VOLTAGE.....	300 <i>max</i>	volts	
PLATE DISSIPATION.....	15 <i>max</i>	watts	

<b>Typical Operation (Values Are For Two Tubes):</b>			
	<i>Fixed Bias</i>	<i>Cathode Bias</i>	
Plate Voltage.....	300	300	volts
Grid Voltage*#.....	-62	-	volts
Cathode-Bias Resistor.....	-	780	ohms
Peak AF Grid-to-Grid Voltage.....	124	156	volts
Zero-Signal Plate Current.....	80	80	ma
Maximum-Signal Plate Current.....	147	100	ma
Effective Load Resistance (Plate-to-plate).....	3000	5000	ohms
Total Harmonic Distortion.....	2.5	5.0	per cent
Power Output.....	15	10	watts

\* Grid voltage referred to mid-point of ac-operated filament.

# When a single 2A3 is operated cathode-biased, the cathode-biasing resistor value should be 750 ohms.

## INSTALLATION AND APPLICATION

Type 2A3 requires a four-contact socket and may be mounted in any position. Outline 41, OUTLINES SECTION. It is especially important that this tube, like other power-handling tubes, should be adequately ventilated.

The values recommended for push-pull operation are different from the conventional ones usually given on the basis of characteristics for a single tube. The values shown for Push-Pull Class AB<sub>1</sub> operation cover operation with fixed bias and with cathode bias, and have been determined on the basis of no grid current flow during the most positive swing of the input signal and of cancellation of second-harmonic distortion by virtue of the push-pull circuit. The cathode resistor should preferably be shunted by a suitable filter network to minimize grid-bias variations produced by current surges in the cathode resistor.

When 2A3's are operated in push-pull, it is desirable to provide means for adjusting independently the bias on each tube. This requirement is a result of the very high transconductance of these tubes—5250 micromhos. This very high value makes the 2A3 somewhat critical as to grid-bias voltage, since a very small bias-voltage change produces a very large change in plate current. It is obvious, therefore, that the difference in plate current between two tubes may be sufficient to unbalance the system seriously. To avoid this possibility, simple methods of independent cathode-bias adjustment may be used, such as (1) input transformer with two independent secondary windings, or (2) filament transformer with two independent filament windings. With either of these methods, each tube can be biased separately so as to obtain circuit balance.

Any conventional type of **input coupling** may be used provided the resistance added to the grid circuit by this device is not too high. *Transformers or impedances are recommended.* When cathode bias is used, the dc resistance in the grid circuit should not exceed 0.5 megohm. With fixed bias, however, the dc resistance should not exceed 50000 ohms.

**GAS TRIODE**

**2A4-G**

Glass octal type used in relay-control equipment such as motor-controlled tuning mechanisms of radio receivers. It is a grid-controlled gaseous-discharge tube. Outline 31, OUTLINES SECTION. Tube requires octal socket and may be mounted in any position. Filament volts (ac/dc), 2.5; amperes, 2.5. Filament voltage should be applied for 2 seconds before start of

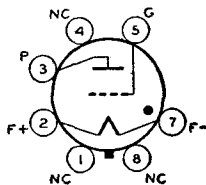

tube conduction. Characteristics: peak inverse anode volts, 200 *max*; peak forward anode volts, 200 *max*; peak volts between any two electrodes, 250 *max*; peak anode amperes, 1.25 *max*; average anode amperes (over any 45-second period), 0.10 *max*; anode voltage drop, 15 volts. This type is used principally for renewal purposes.

**POWER PENTODE**

**2A5**

Glass type used in output stage of ac-operated receivers. Outline 36, OUTLINES SECTION. Tube requires six-contact socket. Except for its heater rating (2.5 volts ac/dc; 1.75 amperes), the 2A5 has electrical characteristics identical with type 6F6. This type is used principally for renewal purposes.

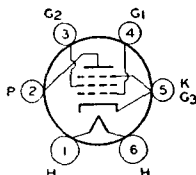

**TWIN DIODE—HIGH-MU TRIODE**

**2A6**

Glass type used in ac-operated receivers chiefly as a combined detector, amplifier, and avc tube. Outline 34, OUTLINES SECTION. Tube requires six-contact socket. Except for its heater rating (2.5 volts ac/dc; 0.8 ampere), and within its 250-volt maximum plate rating, the 2A6 has electrical characteristics identical with type 6SQ7. This type is used principally for renewal purposes.

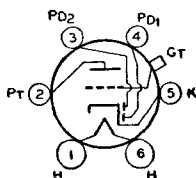

**PENTAGRID CONVERTER**

**2A7**

Glass type used in ac-operated receivers. Outline 34, OUTLINES SECTION. Tube requires small seven-contact (0.75-inch, pin-circle diameter) socket. Except for its heater rating (2.5 volts ac/dc; 0.8 ampere) and its interelectrode capacitances, the 2A7 has electrical characteristics identical with type 6A8. Complete shielding of this tube is generally necessary. This type is used principally for renewal purposes.

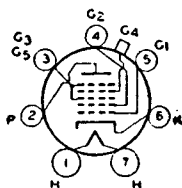

**TWIN DIODE—  
REMOTE-CUTOFF PENTODE**

**2B7**

Glass type used as combined detector, avc tube, and amplifier. Outline 34, OUTLINES SECTION. Tube requires small seven-contact (0.75-inch, pin-circle diameter) socket. Except for its heater rating (2.5 volts ac/dc; 0.8 ampere) and its interelectrode capacitances, the 2B7 has electrical characteristics identical with type 6B8-G. This type is used principally for renewal purposes.

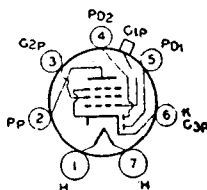

**ELECTRON-RAY TUBE**

**2E5**

Glass type used to indicate visually by means of a fluorescent target the effects of a change in a controlling voltage. It is used as a convenient means of indicating accurate radio receiver tuning. Outline 32, OUTLINES SECTION. Tube requires six-contact socket. Except for its heater rating (2.5 volts ac/dc; 0.8 ampere), the 2E5 has electrical characteristics identical with type 6E5. This type is used principally for renewal purposes.

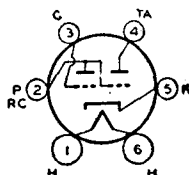

## DIODE—TRIODE—PENTODE

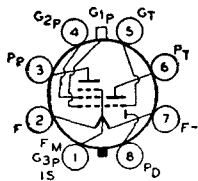

## 3A8-GT

Glass octal type used as combined detector, af amplifier, and rf amplifier in battery-operated receivers. Filament has mid-tap so that tube may be used with either 1.4- or 2.8-volt dc filament supplies. Filament volts 1.4 (parallel), 2.8 (series); amperes 0.1 (parallel), 0.05 (series). Typical operation of triode unit as class A<sub>1</sub> amplifier: plate volts, 90 (110 max); grid volts, 0;

amplification factor, 65; plate resistance, 0.2 megohm; transconductance, 325  $\mu$ mhos; plate ma., 0.2. Typical operation of pentode unit as class A<sub>1</sub> amplifier: plate volts, 90 (110 max); grid-No.2 volts, 90 (110 max); grid-No.1 volts, 0; plate resistance, 0.8 megohm; transconductance, 750  $\mu$ mhos; plate ma., 1.5; grid-No.2 ma., 0.5. This type is used principally for renewal purposes.

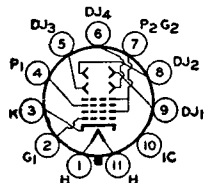

## KINESCOPE

## 3KP4

Directly viewed picture tube used in compact, low-cost television receivers. Employs a white fluorescent screen having medium persistence and high efficiency. It utilizes electrostatic focus

and deflection to provide a rectangular picture with rounded corners about  $2\frac{1}{2}$  x  $1\frac{1}{8}$  inches. Maximum diameter is  $3\text{-}1/16$  inches; maximum overall length is  $11\frac{3}{4}$  inches. Tube requires magnal eleven-contact socket and may be mounted in any position. For installation and handling considerations, refer to ELECTRON TUBE INSTALLATION SECTION. This type is used principally for renewal purposes.

HEATER VOLTAGE (AC/DC) .....	6.3	volts
HEATER CURRENT .....	0.6	ampere

### Maximum Ratings:

ANODE-NO.2 AND GRID-NO.2 VOLTAGE .....	2500 max	volts
ANODE-NO.1 VOLTAGE .....	1000 max	volts
GRID-NO.1 VOLTAGE:		
Negative bias value .....	200 max	volts
Positive bias value .....	0 max	volts
Positive peak value .....	2 max	volts
PEAK VOLTAGE BETWEEN ANODE NO.2 AND ANY DEFLECTING ELECTRODE ..	500 max	volts
PEAK HEATER-CATHODE VOLTAGE:		
Heater negative with respect to cathode .....	125 max	volts
Heater positive with respect to cathode .....	125 max	volts

### Typical Operation:

Anode-No.2 Voltage* .....	2000	volts
Anode-No.1 Voltage for Focus* .....	320 to 600	volts
Grid-No.1 Voltage for Visual Cutoff of Undelected Focused Spot ..	-38 to -90	volts
Deflection Factors #:		
DJ1 and DJ2 .....	100 to 136	volts dc/in
DJ3 and DJ4 .....	76 to 104	volts dc/in

### Maximum Circuit Values:

Grid-No.1 Circuit Resistance .....	1.5 max	megohms
Resistance in any Deflecting Electrode Circuit .....	5 max	megohms

\* Brilliance and definition decrease with decreasing anode-No.2 voltage.

° With the combined grid-No.1-bias voltage and video-signal voltage adjusted for a highlight brightness of 2 foot-lamberts on a  $2\frac{1}{2}$ " x  $1\frac{1}{8}$ " picture area.

# Deflecting electrodes DJ1 and DJ2 are nearer the screen; deflecting electrodes DJ3 and DJ4 are nearer the base. When DJ1 is positive with respect to DJ2, the spot is deflected toward pin 4; when DJ3 is positive with respect to DJ4, the spot is deflected toward pin 1.

**BEAM POWER AMPLIFIER**

**3LF4**

Glass lock-in type used in output stage of ac/dc/battery portable receivers. Outline 14, OUTLINES SECTION. Tube requires lock-in socket. Filament volts (dc) 1.4 (parallel), 2.8 (series); amperes 0.1 (parallel), 0.05 (series). For electrical characteristics, refer to glass-octal type 3Q5-GT.

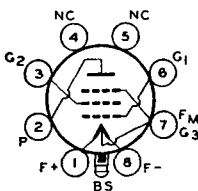

**POWER PENTODE**

**3Q4**

Miniature type used in output stage of lightweight, compact, portable, battery-operated equipment. Outline 12, OUTLINES SECTION. Except for terminal connections, types 3Q4 and

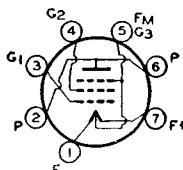

3V4 are identical. Refer to type 3V4 for ratings, typical operation, curves, and installation considerations.

**BEAM POWER AMPLIFIER**

**3Q5-GT**

Glass octal type used in output stage of ac/dc/battery portable receivers. Outline 22, OUTLINES SECTION. Tube requires octal socket and may be mounted in any position. For

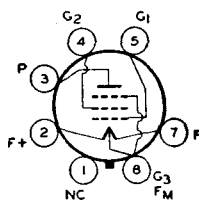

series filament arrangement, filament voltage is applied between pins 2 and 7. For parallel filament arrangement, filament voltage is applied between pin 8 and pins 2 and 7 connected together. For additional filament considerations, refer to type 3V4 and ELECTRON TUBE INSTALLATION SECTION.

Filament Arrangement	Series	Parallel	
FILAMENT VOLTAGE (DC)	2.8	1.4	volts
FILAMENT CURRENT	0.05	0.1	ampere

**CLASS A<sub>1</sub> AMPLIFIER**

**Maximum Ratings:**

	Series	Parallel	
PLATE VOLTAGE	110 max	110 max	volts
GRID-NO. 2 (SCREEN) VOLTAGE	110 max	110 max	volts
TOTAL ZERO-SIGNAL CATHODE CURRENT	6 max	12 max	ma

**Typical Operation:**

	Series		Parallel			
Plate Voltage	90	110	85	90	110	volts
Grid-No. 2 Voltage	90	110	85	90	110	volts
Grid-No. 1 Voltage*	-4.5	-6.6	-5	-4.5	-6.6	volts
Peak AF Grid-No. 1 Voltage	4.5	5.1	5	4.5	5.4	volts
Plate Current	8.0	8.5	7.0	9.5	10	ma
Grid-No. 2 Current (Approx.)	1.0	1.1	0.8	1.3	1.4	ma
Plate Resistance (Approx.)	0.08	0.11	0.07	0.09	0.1	megohm
Transconductance	2000	2000	1950	2200	2200	μmhos
Load Resistance	8000	8000	9000	8000	8000	ohms
Total Harmonic Distortion	8.5	8.5	5.5	6.0	6.0	per cent
Maximum-Signal Power Output	230	330	250	270	400	mw

\*The grid-No.1-circuit resistance should not exceed 1.0 megohm for either cathode- or fixed-bias operation.

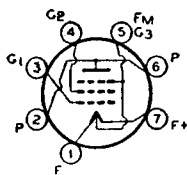

## POWER PENTODE

# 3S4

Miniature type used in output stage of lightweight, compact, portable, battery-operated equipment. Outline 12, OUTLINES SECTION. Tube requires miniature seven-contact socket

and may be mounted in any position. Types 3S4 and 1S4 are identical except for filament arrangement. Type 3S4 features a filament mid-tap so that tube may be used either with a 1.4-volt battery supply or in series with other miniature tubes having 0.050-ampere filaments. For filament considerations, refer to type 3V4 and ELECTRON TUBE INSTALLATION SECTION.

<b>Filament Arrangement</b>	<i>Series</i>	<i>Parallel</i>	
FILAMENT VOLTAGE (DC).....	2.8	1.4	volts
FILAMENT CURRENT.....	0.05	0.1	ampere

### CLASS A<sub>1</sub> AMPLIFIER

Maximum Ratings:

	<i>Series</i>	<i>Parallel</i>	
PLATE VOLTAGE.....	90	90 max	volts
GRID-NO. 2 (SCREEN) VOLTAGE.....	67.5	67.5 max	volts
TOTAL CATHODE CURRENT.....	6.0 #	12 max	ma

# For each 1.4-volt filament section.

Typical Operation:

	<i>Series</i>	<i>Parallel</i>	
Plate Voltage.....	67.5	90	volts
Grid-No. 2 Voltage.....	67.5	67.5	volts
Grid-No. 1 (Control-Grid) Voltage.....	-7	-7	volts
Peak AF Grid-No. 1 Voltage.....	7	7	volts
Zero-Signal Plate Current.....	6.0	6.1	ma
Zero-Signal Grid-No. 2 Current.....	1.2	1.1	ma
Plate Resistance.....	0.1	0.1	megohm
Transconductance.....	1400	1425	μmhos
Load Resistance.....	5000	8000	ohms
Total Harmonic Distortion.....	12	13	per cent
Maximum-Signal Power Output.....	160	235	mw

AVERAGE PLATE CHARACTERISTICS

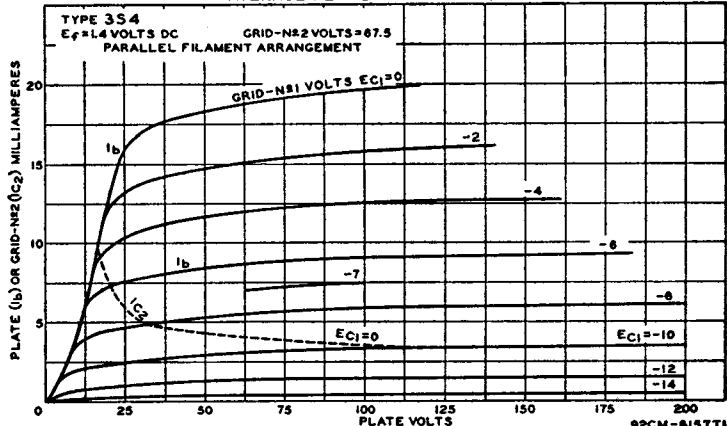

POWER PENTODE

3V4

Miniature type used in output stage of lightweight, compact, portable, battery-operated equipment. Except for terminal connections, types 3V4 and 3Q4 are identical. Both feature

filament mid-tap so that tubes may be used either with a 1.4-volt battery supply or in series with other miniature tubes having 0.050-ampere filaments.

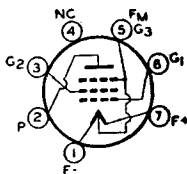

Filament Arrangement	Series	Parallel	
FILAMENT VOLTAGE (DC)	2.8	1.4	volts
FILAMENT CURRENT	0.05	0.1	ampere
DIRECT INTERELECTRODE CAPACITANCES (Approx. With no external shield):			
Grid No. 1 to Plate	0.2		$\mu\text{f}$
Input	5.5		$\mu\text{f}$
Output	3.8		$\mu\text{f}$

Maximum Ratings:	CLASS A <sub>1</sub> AMPLIFIER		
	Series	Parallel	
PLATE VOLTAGE	90 max	90 max	volts
GRID-NO. 2 (SCREEN) VOLTAGE	90 max	90 max	volts
TOTAL CATHODE CURRENT	6 # max	12 max	ma

# For each 1.4-volt filament section.

Typical Operation:	Series	Parallel		
Plate Voltage	90	85	90	volts
Grid-No. 2 Voltage	90	85	90	volts
Grid-No. 1 (Control-Grid) Voltage	-4.5	-5	-4.5	volts
Peak AF Grid-No. 1 Voltage	4.5	5	4.5	volts
Zero-Signal Plate Current	7.7	6.9	9.5	ma
Zero-Signal Grid-No. 2 Current	1.7	1.5	2.1	ma
Plate Resistance (Approx.)	0.12	0.12	0.1	megohm
Transconductance	2000	1975	2150	$\mu\text{mbos}$
Load Resistance	10000	10000	10000	ohms
Total Harmonic Distortion	7	10	7	per cent
Maximum-Signal Power Output	240	250	270	mW

INSTALLATION AND APPLICATION

Type 3V4 requires miniature seven-contact socket and may be mounted in any position. Outline 12, OUTLINES SECTION.

The filament power supply may be obtained from dry-cell batteries, from storage batteries, or from a power line. With dry-cell battery supply, the filament may be connected either directly across a battery rated at a terminal potential of 1.5 volts, or in series with the filaments of similar tubes across a power supply consisting of dry cells in series. In any case, the voltage across each 1.4-volt section of filament should not exceed 1.6 volts.

With power-line or storage-battery supply, the filament may be operated in series with the filaments of other tubes of the same filament-current rating. For such operation, design adjustments should be made so that, with tubes of rated characteristics operating with all electrode voltages applied and on a normal line voltage of 117 volts or on a normal storage-battery voltage of 2.0 volts per cell (without a charger) or 2.2 volts per cell (with a charger), the voltage drop across each 1.4-volt section of filament will be maintained within a range of 1.25 to 1.4 volts with a center of 1.3 volts.

For series operation of the sections, a shunting resistor must be connected across the section between the F- and F<sub>m</sub>, the filament mid-tap, to bypass any cathode current in this section which is in excess of the rated maximum per section.



When other tubes in a series-filament arrangement contribute to the filament current of the 3V4, an additional shunting resistor may be required across the entire filament (F- to F+).

For series filament arrangement, filament voltage is applied between pins No.1 and No.7. For parallel filament arrangement, filament voltage is applied between pin No.5 and pins No.1 and No.7 connected together. Refer to ELECTRON TUBE INSTALLATION SECTION for additional filament considerations.

In series filament arrangement, the grid-No.1 voltage is referred to F-. In parallel filament arrangement, the grid-No.1 voltage is referred to F<sub>M</sub>, the filament mid-tap.

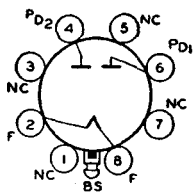
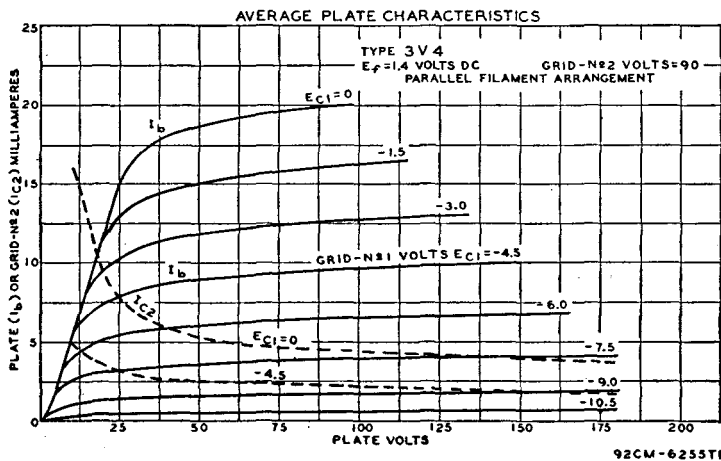

### FULL-WAVE VACUUM RECTIFIER

Lock-in type used in power supply of radio equipment having moderate dc requirements. Outline 19, OUTLINES SECTION. Tube requires lock-in socket. Filament volts, 5; amperes, 2. For maximum ratings, typical operation, and curves, refer to glass-octal type 5Y3-GT.

## 5A4Z4

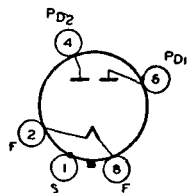

### FULL-WAVE VACUUM RECTIFIER

Metal type used in power supply of radio equipment having large dc requirements. Outline 7, OUTLINES SECTION. Tube requires octal socket. Vertical tube mounting is preferred but horizontal mounting is permissible if pins 2 and 8 are in vertical plane. Filament volts (ac), 5.0; amperes, 2.0. This type is used principally for renewal purposes.

## 5T4

**Maximum Ratings:**

	<b>FULL-WAVE RECTIFIER</b>	
PEAK INVERSE PLATE VOLTAGE.....	1550 max	volts
PEAK PLATE CURRENT.....	675 max	ma
DC OUTPUT CURRENT.....	225 max	ma

### Typical Operation:

<i>Filter Input</i>	<i>Capacitor</i>	<i>Choke</i>	
AC Plate-to-Plate Supply Voltage (rms) .....	900	1100	volts
Filter-Input Capacitor .....	4	—	$\mu$ f
Total Effective Plate-Supply Impedance Per Plate† .....	150	—	ohms
Filter-Input Choke .....	—	10	henries
DC Output Current .....	225	225	ma
DC Output Voltage at Input to Filter (Approx.):			
At half-load current (112.5 ma.) .....	530	465	volts
At full-load current (225 ma.) .....	480	450	volts
Voltage Regulation (Approx.):			
Half-load to full-load current .....	50	15	volts

† When a filter-input capacitor larger than 40  $\mu$ f is used, it may be necessary to use more plate-supply impedance than the value shown in order to limit the peak plate current to the rated value.

## PROJECTION KINESCOPE

# 5TP4

Projection-type kinescope used in television receivers having a reflective optical system. Features high-efficiency, metal-backed white fluorescent screen utilizing phosphor No.4 of the

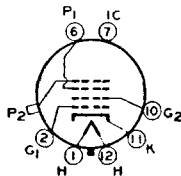

silicate type. Highlight brightness of the projected picture is about 15 foot-lamberts when the 5TP4 is operated at 27 kilovolts. Utilizes electrostatic focusing and magnetic deflection. Has deflection angle of about 50°.

HEATER VOLTAGE (AC/DC) .....	6.3	volts
HEATER CURRENT .....	0.6	ampere
DIRECT INTERELECTRODE CAPACITANCES:		
Grid No.1 to All Other Electrodes .....	8	$\mu$ f
Cathode to All Other Electrodes .....	5	$\mu$ f
External Conductive Coating to Anode No. 2 .....	{ 500 max 100 min	{ $\mu$ f $\mu$ f

### Maximum Ratings:

ANODE-NO.2 Voltage .....	27000 max	volts
ANODE-NO.1 Voltage .....	6000 max	volts
GRID-NO.2 Voltage .....	350 max	volts
GRID-NO.1 VOLTAGE:		
Negative bias value .....	150 max	volts
Positive bias value .....	0 max	volts
Positive peak value .....	2 max	volts
PEAK HEATER-CATHODE VOLTAGE:		
Heater negative with respect to cathode:		
During equipment warm-up period not exceeding 15 seconds .....	410 max	volts
After equipment warm-up period .....	175 max	volts
Heater positive with respect to cathode .....	10 max	volts

### Typical Operation:

Anode-No.2 Voltage* .....	27000	volts
Anode-No.1 Voltage Range for Focus when Anode-No.2 Current is 200 $\mu$ a .....	4320 to 5400	volts
Grid-No.2 Voltage .....	200	volts
Grid-No.1 Voltage for Visual Cutoff of undeflected focused spot .....	-42 to -98	volts
Anode-No.2 Current .....	200	$\mu$ a
Maximum Anode-No.1 Current .....	55	$\mu$ a
Grid-No.2 Current Range .....	-15 to +15	$\mu$ a

### Maximum Circuit Value:

Grid-No.1-Circuit Resistance .....	1.5 max	megohms
------------------------------------	---------	---------

\* Brilliance and definition decrease with decreasing anode voltages. In general, anode-No. 2 voltage should not be less than 20000 volts.

## INSTALLATION AND APPLICATION

The base pins of the 5TP4 fit the duodecal seven-contact socket. In order to provide the maximum socket insulation for high-voltage pins 6 and 7, the socket contacts for pins 3, 4, 5, 8, and 9 should be removed. The socket should be made of high-grade, arc-resistant insulating material and should preferably be designed with baffles. The tube should be supported by a metal holder at the large end of the tube. The 5TP4 may be operated in any position. Outline 44, OUTLINES SECTION.

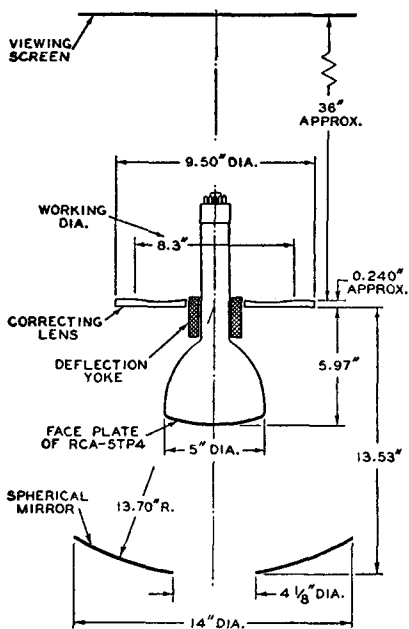

A typical reflective optical system for use with the 5TP4 is illustrated in the accompanying sketch. It consists of a spherical collecting mirror and a correcting lens located at the center of curvature of the mirror. The illustration also shows the location of the face plate of the 5TP4 and the location of the viewing screen with respect to the mirror and the correcting lens.

The neck external conductive coating must be grounded. Connection to the coating may be made by a flexible band around the base end of the coating, or by a soft brush contact attached to the bottom of the yoke. Unless the coating is grounded, it may assume the potential of anode No.2 and thus break down the yoke insulation.

The coating serves to prevent corona between the neck (which has an internal coating at anode-No.2 potential) and the yoke. Corona would act to damage the yoke insulation and to produce breakdown in the glass of the neck. It is important that the yoke insulation be adequate for operation of the yoke against the external grounded coating.

The bulb insulating (moisture-repellent) coating serves to prevent formation of a continuous film of moisture over the glass surface when humidity is high. Such a film, when a high-voltage gradient is present, is conducive to the formation of corona and tends to produce sparking over the glass surface. Care must be taken not to scratch the insulating coating, nor to wash or wipe it with any liquid likely to soften or dissolve lacquers.

Grid No. 2 is incorporated in the design of the 5TP4 to prevent interaction between the fields produced by grid No.1 and anode No.1. However, grid No.2 may also be used to compensate for the normal variation to be expected in the grid-No.1 voltage for cutoff in individual tubes. By adjusting the voltage applied to grid No.2 with due consideration to its maximum rated value, it is possible to fix the grid-No.1 bias at a desired value, and obtain almost the same maximum anode current for individual tubes having different cutoff voltages. Adjusting grid-No.1 cutoff in this way not only makes grid drive more uniform, but also reduces variations in anode-No.1 current. Since grid-No.2 draws at most only a negligible leakage current, its voltage may be obtained from a potentiometer inserted in the anode-No.1 voltage divider.

The high voltage at which the 5PT4 is operated is very dangerous. Great care should be taken in the design of apparatus to prevent the operator from coming in contact with the high voltages. Precautions include the enclosing of high-potential terminals and the use of inter-locking switches to break the primary circuit of the power supply when access to the equipment is required. To minimize the danger of these high voltages, it is recommended that the high-voltage supply for the 5TP4 be one in which the peak current even under short-circuit conditions is well below the value dangerous to life.

For additional installation and handling considerations, refer to ELECTRON TUBE INSTALLATION SECTION.

Occasionally, after a tube has been transported, fine loose particles inside the tube may get on the anode-No.1 surface. When voltage is applied, there will be a momentary spark which fuses or removes the particles, so that no further sparking occurs. Such sparking causes no harm to the tube provided the maximum energy dissipated in the spark is kept small by use of a suitable high-voltage power supply as recommended above.

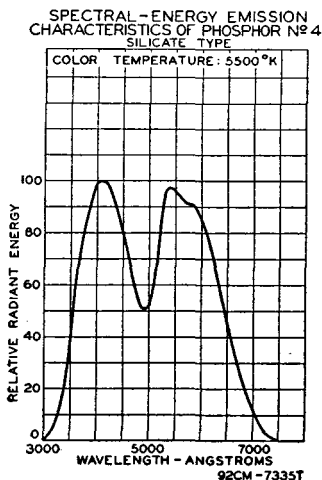

## FULL-WAVE VACUUM RECTIFIER

### 5U4-G

Glass octal type used in power supply of radio equipment having high dc requirements. Outline 40, OUT-LINES SECTION. Tube requires octal socket. Vertical mounting is preferred

but horizontal mounting is permissible if pins 1 and 4 are in vertical plane. The coated filament is designed to operate from the ac line through a step-down transformer. The voltage at the filament terminals should be 5.0 volts under operating conditions at an average line voltage of 117 volts. It is especially important that this tube, like other power-handling tubes, should be adequately ventilated. For discussion of Rating Chart and Operation Characteristics, refer to type 6AX5-GT.

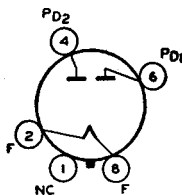

FILAMENT VOLTAGE (AC) .....	5.0	volts
FILAMENT CURRENT .....	3.0	amperes

# RCA RECEIVING TUBE MANUAL

## Maximum Ratings:

### FULL-WAVE RECTIFIER

PEAK INVERSE PLATE VOLTAGE.....	1550 <i>max</i>	volts
PEAK PLATE CURRENT PER PLATE.....	675 <i>max</i>	ma
HOT-SWITCHING TRANSIENT PLATE CURRENT for duration of 0.2 second maximum.....	2.35 <i>max</i>	amperes
AC PLATE SUPPLY VOLTAGE PER PLATE (RMS).....	See Rating Chart	
DC OUTPUT CURRENT PER PLATE (RMS).....	See Rating Chart	

### Typical Operation with Capacitor Input to Filter:

AC Plate-to-Plate Supply Voltage (rms).....	900	1100	volts
Filter Input Capacitor*.....	10	10	$\mu$ f
Effective Plate-Supply Impedance Per Plate.....	170	230	ohms
DC Output Voltage at Input to Filter (Approx.):			
At half-load current of { 112.5 ma.....	510	-	volts
78 ma.....	-	660	volts
At full-load current of { 225 ma.....	430	-	volts
156 ma.....	-	590	volts
Voltage Regulation (Approx.):			
Half-load to full-load current.....	80	70	volts

### Typical Operation with Choke Input to Filter:

AC Plate-to-Plate Supply Voltage (rms).....	900	1100	volts
Filter Input Choke.....	10#	10##	henries
DC Output Voltage at Input to Filter (Approx.):			
At half-load current of { 135 ma.....	365	-	volts
112.5 ma.....	-	460	volts
At full-load current of { 270 ma.....	345	-	volts
225 ma.....	-	440	volts
Voltage Regulation (Approx.):			
Half-load to full-load current.....	20	20	volts

\* Higher values of capacitance than indicated may be used but the effective plate-supply impedance may have to be increased to prevent exceeding the maximum rating for hot-switching transient plate current.

# This value is adequate to maintain optimum regulation in the region to the right of line L=10H on curve OPERATION CHARACTERISTICS with Choke Input to Filter, provided the load current is not less than 35 ma. For load currents less than 35 ma, a larger value of inductance is required for optimum regulation.

## This value is adequate to maintain optimum regulation in the region to the right of line L=10H on curve OPERATION CHARACTERISTICS with Choke Input to Filter, provided the load current is not less than 45 ma. For load currents less than 45 ma, a larger value of inductance is required for optimum regulation.

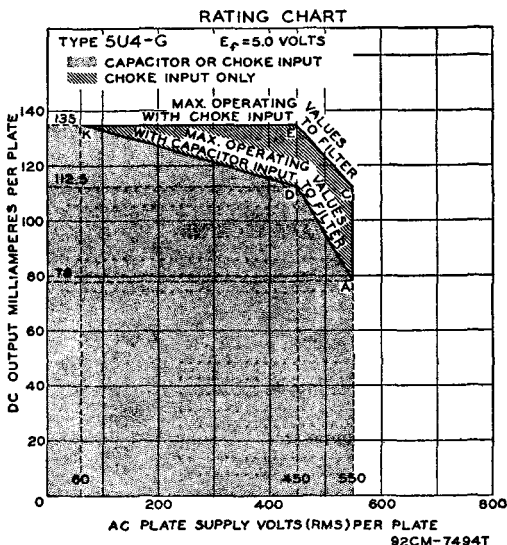

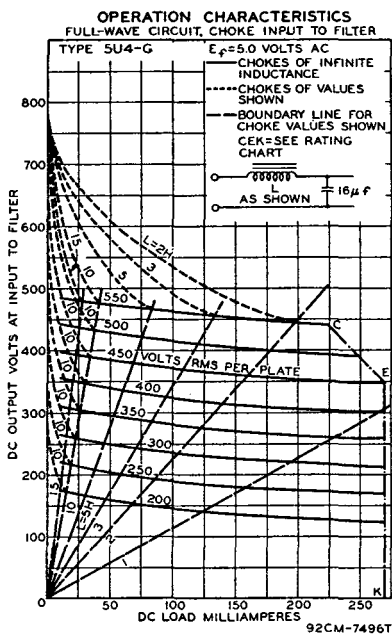
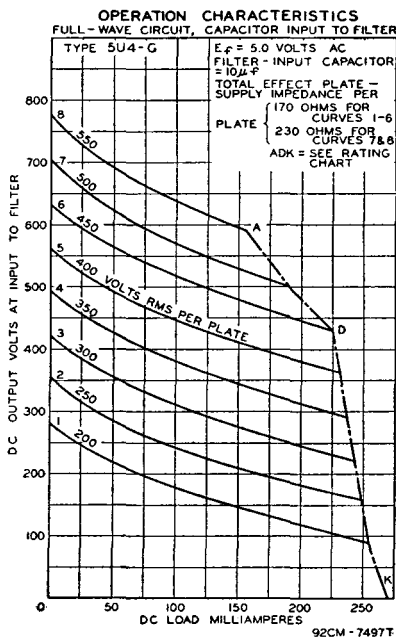

## 5V4-G

### FULL-WAVE VACUUM RECTIFIER

Glass octal type used in power supply of radio equipment having high dc requirements. Outline 35, OUT-LINESSECTION. Tuberequires octal socket and may be mounted in any

position. The heater is designed to operate from the ac line through a step-down transformer. The voltage at the heater terminals should be 5.0 volts under operating conditions at an average line voltage of 117 volts. It is especially important that this tube, like other power-handling tubes, should be adequately ventilated.

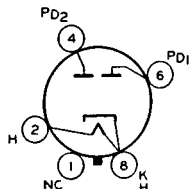

HEATER VOLTAGE (AC) .....	5.0	volts
HEATER CURRENT .....	2.0	amperes

#### Maximum Ratings:

#### FULL-WAVE RECTIFIER

PEAK INVERSE PLATE VOLTAGE .....	1400 max	volts
PEAK PLATE CURRENT .....	525 max	ma
DC OUTPUT CURRENT .....	175 max	ma

#### Typical Operation:

	Capacitor	Choke	
AC Plate-to-Plate Supply Voltage (rms) .....	750	1000	volts
Filter-Input Capacitor .....	8	-	$\mu f$
Total Effective Plate-Supply Impedance per Plate* .....	100	-	ohms
Min. Filter-Input Choke .....	-	4	henries
DC Output Current .....	175	175	ma
DC Output Voltage at Input to Filter (Approx.):			
At half-load current (87.5 ma.) .....	455	425	volts
At full-load current (175 ma.) .....	415	415	volts
Voltage Regulation (Approx.):			
Half-load to full-load current .....	40	10	volts

\* When a filter-input capacitor larger than  $40\mu f$  is used, it may be necessary to use more plate-supply impedance than the value shown to limit the peak plate current to the rated value.

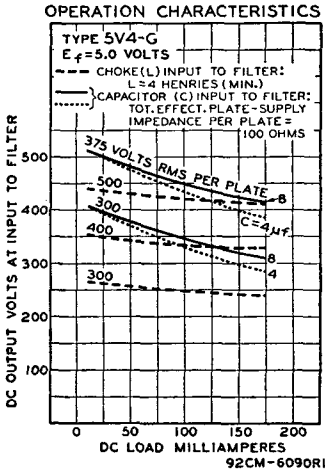

**FULL-WAVE VACUUM RECTIFIER**

Metal type 5W4 and glass-octal type 5W4-GT are used in power supply of radio equipment having low dc requirements. Outlines 6 and 25, respectively, OUTLINES SECTION. Both types require octal socket. Filament volts (ac), 5.0; amperes, 2.0. Maximum ratings: peak inverse plate volts, 1400 *max.*; peak plate ma., 300 *max.*; dc output ma., 100 *max.* The 5W4-GT is a **DISCONTINUED** type listed for reference only. Type 5W4 is used principally for renewal purposes.

**5W4**  
**5W4-GT**

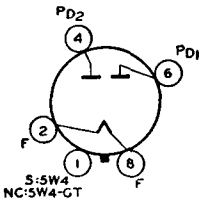

**FULL-WAVE VACUUM RECTIFIER**

Glass octal type used in power supply of radio equipment having large dc requirements. Outline 40, OUTLINES SECTION. Filament volts, 5.0; amperes, 3.0. Except for basing arrangement, this type is identical with type 5U4-G. Type 5X4-G is used principally for renewal purposes.

**5X4-G**

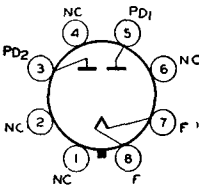

**FULL-WAVE VACUUM RECTIFIER**

Glass octal types used in power supply of radio equipment having moderate dc requirements. Type 5Y3-G, Outline 35; type 5Y3-GT, Outline 25, OUTLINES SECTION. Tubes require

**5Y3-G**  
**5Y3-GT**

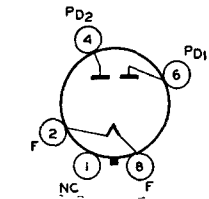

octal socket. Vertical tube mounting is preferred, but horizontal operation is permissible if pins 2 and 8 are in horizontal plane. It is especially important that these tubes, like other power-handling tubes, should be adequately ventilated. Type 5Y3-G is used principally for renewal purposes. For discussion of Rating Chart and Operation Characteristics, refer to type 6AX5-GT.

FILAMENT VOLTAGE (AC).....	5.0	volts
FILAMENT CURRENT.....	2.0	amperes

# RCA RECEIVING TUBE MANUAL

## Maximum Ratings:

## FULL-WAVE RECTIFIER

PEAK INVERSE PLATE VOLTAGE.....	1400 max	volts
PEAK PLATE CURRENT PER PLATE.....	400 max	ma
<b>HOT-SWITCHING TRANSIENT PLATE CURRENT</b>		
For duration of 0.2 second maximum.....	2.2 max	amperes
AC PLATE SUPPLY VOLTAGE PER PLATE (RMS).....	<i>See Rating Chart</i>	
DC OUTPUT CURRENT PER PLATE (RMS).....	<i>See Rating Chart</i>	

### Typical Operation with Capacitor Input to Filter:

AC Plate-to-Plate Supply Voltage (rms).....	700	1000	volts
Filter Input Capacitor*.....	10	10	$\mu$ f
Effective Plate-Supply Impedance Per Plate.....	50	140	ohms
<b>DC Output Voltage at Input to Filter (Approx.):</b>			
At half-load current of { 62.5 ma .....	390	-	volts
{ 42 ma .....	-	610	volts
At full-load current of { 125 ma .....	350	-	volts
{ 84 ma .....	-	560	volts
<b>Voltage Regulation (Approx.):</b>			
Half-load to full-load current.....	40	50	volts

### Typical Operation with Choke Input to Filter:

AC Plate-to-Plate Supply Voltage (rms).....	700	1000	volts
Filter Input Choke.....	10#	10##	henries
<b>DC Output Voltage at Input to Filter (Approx.):</b>			
At half-load current of { 75 ma .....	270	-	volts
{ 62.5 ma .....	-	405	volts
At full-load current of { 150 ma .....	245	-	volts
{ 125 ma .....	-	390	volts
<b>Voltage Regulation (Approx.):</b>			
Half-load to full-load current.....	25	15	volts

\* Higher values of capacitance than indicated may be used but the effective plate supply impedance may have to be increased to prevent exceeding the maximum rating for hot-switching transient plate current.

# This value is adequate to maintain optimum regulation in the region to the right of line L=10H on curve OPERATION CHARACTERISTICS with Choke Input to Filter, provided the load current is not less than 35 ma. For load currents less than 35 ma, a larger value of inductance is required for optimum regulation.

## This value is adequate to maintain optimum regulation in the region to the right of line L=10H on curve OPERATION CHARACTERISTICS with Choke Input to Filter, provided the load current is not less than 50 ma. For load currents less than 50 ma, a larger value of inductance is required for optimum regulation.

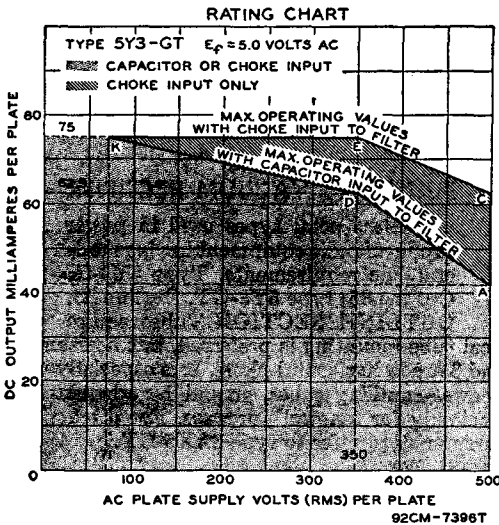



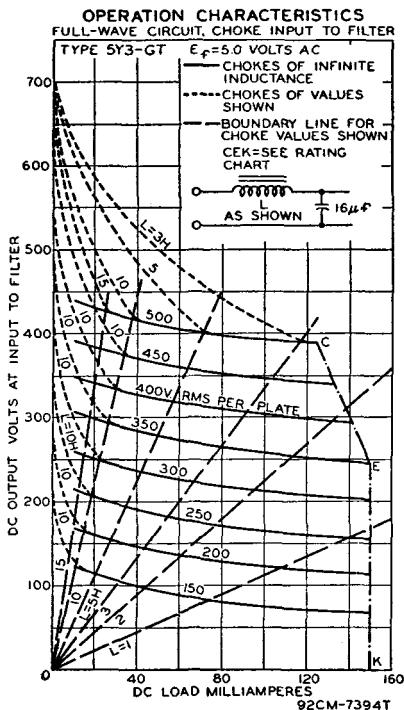
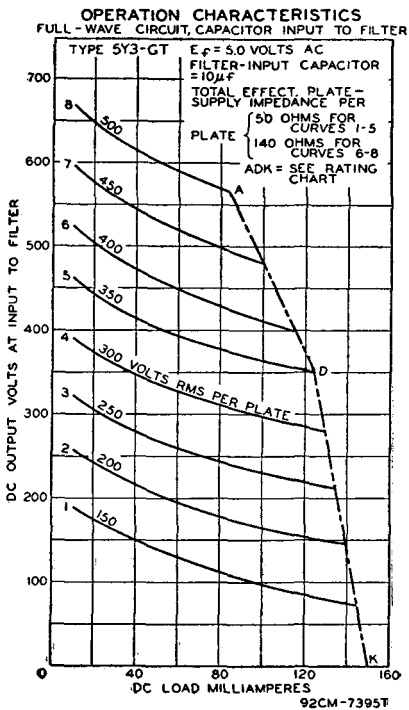

## FULL-WAVE VACUUM RECTIFIER

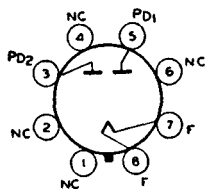

Glass octal type used in power supply of radio equipment having moderate dc requirements. Outline 35, OUTLINES SECTION. Tube requires octal socket. Vertical tube mounting is preferred, but horizontal mounting is permissible if pins 2 and 7 are in horizontal plane. Filament volts (ac), 5.0; amperes, 2.0. For maximum ratings, typical operation, and curves, refer to type 5Y3-GT. Type 5Y4-G is used principally for renewal purposes.

# 5Y4-G

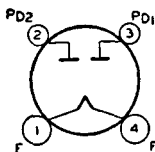

## FULL-WAVE VACUUM RECTIFIER

Glass type used in power supply of radio equipment having large dc requirements. Outline 41, OUTLINES SECTION. Tube requires four-contact socket. Vertical mounting is preferred

# 5Z3

but horizontal mounting is permissible if pins 1 and 4 are in horizontal plane. Filament volts (ac), 5.0; amperes, 3.0. For maximum ratings, typical operation, and curves, refer to type 5U4-G.

**FULL-WAVE VACUUM RECTIFIER**

**5Z4**

Metal type used in power supply of radio equipment having moderate dc requirements. Outline 6, OUTLINES SECTION. Tube requires octal socket and may be mounted in any position. Heater volts (ac), 5.0; amperes, 2.0. Maximum ratings: peak inverse plate volts, 1400 *max*; peak plate ma. per plate, 375 *max*. Typical operation as full-wave rectifier with capacitor-input filter: ac plate-to-plate supply

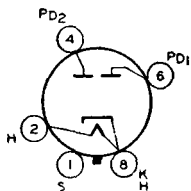

volts (rms), 700; total effective plate-supply impedance per plate, 50 ohms; dc output ma., 125. Typical operation with choke-input filter: ac plate-to-plate supply volts, 1000; minimum filter-input choke, 5 henries; dc output ma., 125.

**POWER TRIODE**

**6A3**

Glass type used in output stage of radio receivers. Outline 41, OUTLINES SECTION. Tube requires four-contact socket. Filament volts (ac/dc), 6.3; amperes, 1.0. This type is identical electrically with type 6B4-G. The 6A3 is used principally for renewal purposes.

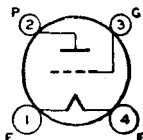

**POWER PENTODE**

**6A4/LA**

Glass type used in output stage of automobile receivers. Outline 36, OUTLINES SECTION. Tube requires five-contact socket. Filament volts (ac/dc), 6.3; amperes, 0.3. Typical operation: plate and grid-No. 2 volts, 180 *max*; grid-No. 1 volts, -12; plate ma., 22; grid-No. 2 ma., 3.9; plate resistance, 45500 ohms approx.; transconductance, 2200  $\mu$ mhos; load resistance, 8000 ohms; cathode-bias resistor, 465 ohms; output watts, 1.4. This is a DISCONTINUED type listed for reference only.

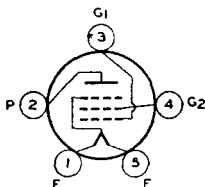

**HIGH-MU TWIN POWER TRIODE**

**6A6**

Glass type used in output stage of ac-operated receivers as a class B power amplifier or with units in parallel as a class A<sub>1</sub> amplifier to drive a 6A6 as class B amplifier. Outline 36, OUTLINES SECTION. Tube requires medium seven-contact (0.855-inch, pin-circle diameter) socket. Filament volts (ac/dc), 6.3; amperes, 0.8. This type is electrically identical with type 6N7. The 6A6 is used principally for renewal purposes.

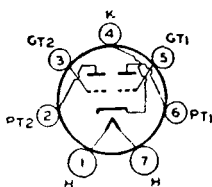

**PENTAGRID CONVERTER**

**6A7**

**6A7S**

Glass types used in superheterodyne circuits. Outline 34, OUTLINES SECTION. These types require the small seven-contact (0.75-inch, pin-circle diameter) socket. Except for interelectrode capacitances, the 6A7 is identical electrically with type 6A8. Type 6A7S, now DISCONTINUED, has the external shield connected to cathode. In general, its electrical characteristics are similar to those of the 6A7, but

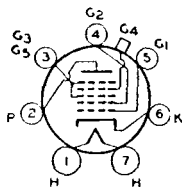

the two types are usually not directly interchangeable. Type 6A7 is used principally for renewal purposes.

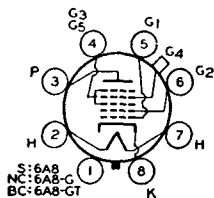

**PENTAGRID CONVERTER**

**6A8  
6A8-G  
6A8-GT**

Metal type 6A8 and glass-octal types 6A8-G and 6A8-GT used in superheterodyne circuits. Type 6A8, Outline 4; type 6A8-G, Outline 33; type 6A8-GT, Outline 23, **OUTLINES SECTION**. Type 6A8-G is used principally for renewal purposes.

All require octal socket. For general discussion of pentagrid types, see **Frequency Conversion in ELECTRON TUBE APPLICATIONS SECTION**. For heater and cathode considerations, refer to type 6AV6.

HEATER VOLTAGE (AC/DC).....	6.3	volts
HEATER CURRENT.....	0.3	ampere

**Maximum Ratings:**

**CONVERTER SERVICE**

PLATE VOLTAGE.....	300 max	volts
GRIDS-NO. 3-AND-NO. 5 (SCREEN) VOLTAGE.....	100 max	volts
GRIDS-NO. 3-AND-NO. 5 SUPPLY VOLTAGE.....	300 max	volts
GRID-NO. 2 (ANODE-GRID) VOLTAGE.....	200 max	volts
GRID-NO. 2 SUPPLY VOLTAGE.....	300 max	volts
GRID-NO. 4 (CONTROL-GRID) VOLTAGE, Positive Bias Value.....	0 max	volts
PLATE DISSIPATION.....	1.0 max	watt
GRIDS-NO.3-AND-NO.5 INPUT.....	0.3 max	watt
GRID-NO.2 INPUT.....	0.75 max	watt
TOTAL CATHODE CURRENT.....	14 max	ma
PEAK HEATER-CATHODE VOLTAGE:		
Heater negative with respect to cathode.....	90 max	volts
Heater positive with respect to cathode.....	90 max	volts

**Typical Operation:**

Plate Voltage.....	100	250	volts
Grids-No. 3-and-No. 5 Voltage.....	50	100	volts
Grid-No. 2 Voltage.....	100	-	volts
Grid-No. 2 Supply Voltage.....	-	250*	volts
Grid-No. 4 Voltage.....	-1.5	-3	volts
Grid-No. 1 (Oscillator-Grid) Resistor.....	50000	50000	ohms
Plate Resistance (Approx.).....	0.6	0.36	megohm
Conversion Transconductance.....	360	550	μmhos
Conversion Transconductance (Approx.) with control-grid bias of -20 volts.....	3	-	μmhos
Conversion Transconductance (Approx.) with control-grid bias of -35 volts.....	-	6	μmhos
Plate Current.....	1.1	3.5	ma
Grids-No. 3-and-No. 5 Current.....	1.3	2.7	ma
Grid-No. 2 Current.....	2	4	ma
Grid-No. 1 Current.....	0.25	0.4	ma
Total Cathode Current.....	4.6	10.6	ma

\* Grid-No. 2 supply voltages in excess of 200 volts require use of 20000-ohm voltage-dropping resistor bypassed by 0.1-μf capacitor.

**HIGH-MU TRIODE**

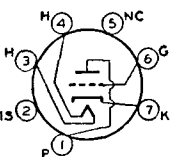

Miniature type used as grounded-grid amplifier, frequency converter, or oscillator at frequencies up to about 300 megacycles per second particularly in television and FM receivers. Outline 12, **OUTLINES SECTION**. Tube requires miniature seven-contact socket and may be mounted in any position. For maximum ratings, characteristics, and curves, refer to type 12AT7. For heater and cathode considerations, refer to type 6AV6.

**6AB4**

HEATER VOLTAGE (AC/DC).....	6.3	volts
HEATER CURRENT.....	0.15	ampere
<b>DIRECT INTERELECTRODE CAPACITANCES (No external shield):</b>		

*Grounded-Cathode Operation*

Grid to Plate.....	1.5	μf
Input.....	2.2	μf
Output.....	0.5	μf
Heater to Cathode.....	2.9	μf

**DIRECT INTERELECTRODE CAPACITANCES (No external shield):**

Plate to Cathode .....	0.24	<i>Grounded-Grid Operation</i> $\mu\text{f}$
Input .....	5.0	$\mu\text{f}$
Output .....	1.7	$\mu\text{f}$

**Maximum Ratings: CLASS A<sub>1</sub> AMPLIFIER**

PLATE VOLTAGE .....	300 <i>max</i>	volts
PLATE DISSIPATION .....	2.5 <i>max</i>	watts
GRID VOLTAGE, Negative Bias Value .....	-50 <i>max</i>	volts
<b>PEAK HEATER-CATHODE VOLTAGE:</b>		
Heater negative with respect to cathode .....	90 <i>max</i>	volts
Heater positive with respect to cathode .....	90 <i>max</i>	volts

**Characteristics:**

Plate Voltage .....	100	250	volts
Internal Shield .....	Connected to ground		
Cathode Resistor .....	270	200	ohms
Amplification Factor .....	60	60	
Plate Resistance (Approx.) .....	15500	10900	ohms
Transconductance .....	4000	5500	$\mu\text{mhos}$
Grid Bias (Approx.) for plate current of 10 $\mu\text{a}$ .....	-5	-12	volts
Plate Current .....	3.7	10	ma

## ELECTRON-RAY TUBE

Glass type used to indicate visually by means of a fluorescent target the effects of a change in a controlling voltage. It is used as a convenient means of indicating accurate radio-receiver tuning. Outline 30, OUTLINES SECTION. Tube requires six-contact socket. For heater and cathode considerations, refer to type 6AV6. Heater volts (ac/dc), 6.3; amperes, 0.15. Ratings: plate-supply volts, 180 *max*; target volts, 180 *max*, 125 *min*.

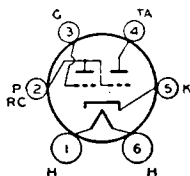

# 6AB5/ 6N5

## REMOTE-CUTOFF PENTODE

Metal type used in rf and if stages of picture amplifier of television receivers particularly those employing automatic-gain control. Outline 3, OUTLINES SECTION. Tube requires octal socket. Heater volts (ac/dc), 6.3; amperes, 0.45. Maximum ratings as class A<sub>1</sub> amplifier: plate and grid-No. 2 supply volts, 300 *max*; grid-No. 2 volts, 200 *max*; plate dissipation, 3.75 *max* watts; grid-No.2 input, 0.7 *max*

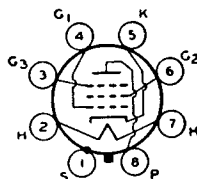

watt. Typical operation: plate and grid-No.2 supply volts, 300; grid-No.3 volts, 0; grid-No.2 series resistor, 30000 ohms; grid-No.1 volts, -3; plate resistance (approx.), 0.7 megohm; transconductance, 5000  $\mu\text{mhos}$ ; grid-No.1 volts for transconductance of 50  $\mu\text{mhos}$ , -15; plate ma., 12.5; grid-No.2 ma., 3.2.

# 6AB7

## HIGH-MU POWER TRIODE

Glass octal type used in single-ended or push-pull audio-frequency power amplifiers of the direct-coupled type in which a driver tube develops positive grid bias for the 6AC5-GT output stage. Outline 22, OUTLINES SECTION. Tube requires octal socket. Heater volts (ac/dc), 6.3; amperes, 0.4. Maximum ratings: plate volts, 250 *max*; peak plate ma. (per tube), 110 *max*; average plate dissipation, 10 *max* watts. This type is used principally for renewal purposes.

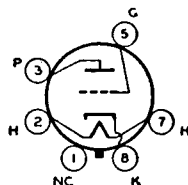

# 6AC5-GT

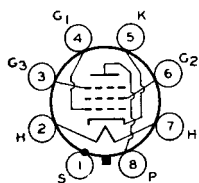

**SHARP-CUTOFF PENTODE**

**6AC7**

Metal type used in rf and if stages of picture amplifier and the first stages of the video amplifier of television receivers. It is also used as a mixer or oscillator tube in low-frequency applications. Outline 3, OUTLINES SECTION. Tube requires octal socket. When tube is used as a high-gain audio amplifier, heater should be operated from a battery source. For other heater considerations, refer to type 6AQ5.

HEATER VOLTAGE (AC/DC) .....	6.3	volts
HEATER CURRENT .....	0.45	ampere
DIRECT INTERELECTRODE CAPACITANCES (Shell connected to cathode):		
Grid No.1 to Plate .....	0.015 max	$\mu\mu\text{f}$
Input .....	11	$\mu\mu\text{f}$
Output .....	5	$\mu\mu\text{f}$

**Maximum Ratings:**

**CLASS A<sub>1</sub> AMPLIFIER**

PLATE VOLTAGE .....	300 max	volts
GRID-NO.2 (SCREEN) VOLTAGE .....	150 max	volts
GRID-NO.2 SUPPLY VOLTAGE .....	300 max	volts
PLATE DISSIPATION .....	3 max	watts
GRID-NO.2 INPUT .....	0.4 max	watt
PEAK HEATER-CATHODE VOLTAGE:		
Heater negative with respect to cathode .....	90 max	volts
Heater positive with respect to cathode .....	90 max	volts

**Typical Operation:**

**Condition I\* Condition II\*\***

Plate Voltage .....	300	300	volts
Grid-No. 3 Voltage .....	0	0	volts
Grid-No. 2 Supply Voltage .....	150	300 #	volts
Grid-No. 2 Series Resistor .....	-	60000	ohms
Min. Cathode-Bias Resistor .....	160	160	ohms
Plate Resistance (Approx.) .....	1	1	megohm
Transconductance .....	9000	9000	$\mu\text{mhos}$
Plate Current .....	10	10	ma
Grid-No. 2 Current .....	2.5	2.5	ma

\* With fixed grid-No.2 supply.

\*\* With series grid-No. 2 resistor.

# Grid-No.2 supply voltages in excess of 150 volts require use of a series dropping resistor to limit the voltage at grid No. 2 to 150 volts when the plate current is at its normal value of 10 milliamperes.

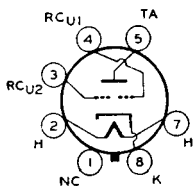

**ELECTRON-RAY TUBE**

**6AD6-G**

Glass octal type used to indicate visually, by means of two shadows on the fluorescent target, the effects of changes in the controlling voltages. It is a twin-indicator type and is used as a convenient means of indicating accurate radio-receiver tuning. Heater volts (ac/dc), 6.3; amperes, 0.15. Maximum target volts, 150. This is a DISCONTINUED type listed for reference only.

**TRIODE—POWER PENTODE**

**6AD7-G**

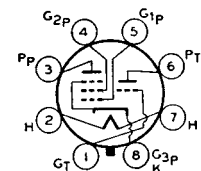

Glass octal type used in a push-pull amplifier circuit in conjunction with type 6F6-G. Triode unit serves as phase inverter. Outline 35, OUTLINES SECTION. Tube requires octal socket. Heater-volts (ac/dc), 6.3; amperes, 0.85. For typical operation of pentode unit, refer to type 6F6-G. Maximum ratings of pentode unit as class A<sub>1</sub> or push-pull class AB<sub>1</sub> amplifier: plate volts, 375 max; grid-No. 2 volts, 285 max; plate

dissipation, 8.5 max watts; grid-No.2 input, 2.7 max watts. Maximum ratings of triode unit as class A<sub>1</sub> amplifier: plate volts, 285 max; plate dissipation, 1.0 max watt.

## LOW-MU TRIODE

### 6AE5-GT

Glass octal type used as class A<sub>1</sub> amplifier in ac/dc radio receivers. Outline 22, OUTLINES SECTION. Heater volts (ac/dc), 6.3; amperes, 0.3. Maximum ratings as class A<sub>1</sub> amplifier: plate volts, 300 *max*; plate dissipation, 2.5 *max* watts. This is a DISCONTINUED type listed for reference only.

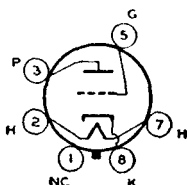

## TWIN-PLATE CONTROL TUBE

### 6AE6-G

Glass octal type used as a control tube for twin-indicator type electron-ray tubes. Outline 31, OUTLINES SECTION. Contains two triodes with different cutoff characteristics. If avc voltage is applied to the common control grid in suitable circuit, one triode section operates on weak signals while the other operates on strong signals. Heater voltage (ac/dc), 6.3; amperes, 0.15. This is a DISCONTINUED type listed for reference only.

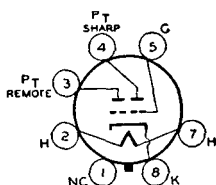

## TWIN-INPUT TRIODE

### 6AE7-GT

Glass octal type used as a voltage amplifier or as a driver for two type 6AC5-GT tubes in dynamic-coupled, push-pull amplifiers. In the latter service, type 6AE7-GT replaces two tubes ordinarily required as drivers. Outline 22, OUTLINES SECTION. Heater volts (ac/dc), 6.3; amperes, 0.5. This is a DISCONTINUED type listed for reference only.

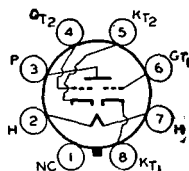

## ELECTRON-RAY TUBE

### 6AF6-G

Glass octal type used to indicate visually, by means of two shadows on the fluorescent target, the effects of changes in the controlling voltages. It is a twin-indicator type and is used as a convenient means of indicating accurate radio-receiver tuning. Outline 11, OUTLINES SECTION. Tube requires octal socket. Heater volts (ac/dc), 6.3; amperes, 0.15. Ratings: target volts, 250 *max*, 125 *min*; ray-control-electrode volts, 250 *max*; peak heater-cathode volts, 90 *max*. Typical operation: target volts, 250; target ma., 2.2; series resistor, 1 megohm; ray-control electrode volts (approx. for 0° shadow angle), 160; ray-control electrode volts (approx. for 90° shadow angle), 0.

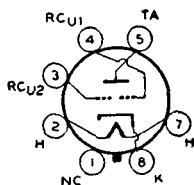

## SHARP-CUTOFF PENTODE

### 6AG5

Miniature type used in compact radio equipment as an rf or if amplifier up to 400 megacycles per second. Outline 12, OUTLINES SECTION. Tube requires miniature seven-contact socket and may be mounted in any position. The two cathode leads facilitate isolation of the input and output circuits thus helping to minimize degeneration. For heater and cathode considerations, refer to type 6AV6.

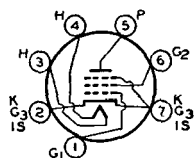

HEATER VOLTAGE (AC/DC).....	6.3	volts
HEATER CURRENT.....	0.3	ampere
DIRECT INTERELECTRODE CAPACITANCES (No external shield):		
Grid No. 1 to Plate.....	0.080 <i>max</i>	$\mu\text{f}$
Input.....	6.5	$\mu\text{f}$
Output.....	1.8	$\mu\text{f}$

# RCA RECEIVING TUBE MANUAL

## Maximum Ratings:

### CLASS A<sub>1</sub> AMPLIFIER

PLATE VOLTAGE.....	300 <i>max</i>	volts
GRID-NO. 2 (SCREEN) VOLTAGE.....	150 <i>max</i>	volts
PLATE DISSIPATION.....	2 <i>max</i>	watts
GRID-NO. 2 INPUT.....	0.5 <i>max</i>	watt
<b>PEAK HEATER-CATHODE VOLTAGE:</b>		
Heater negative with respect to cathode.....	90 <i>max</i>	volts
Heater positive with respect to cathode.....	90 <i>max</i>	volts

## Typical Operation:

Plate Voltage.....	100	125	250	volts
Grid-No. 2 Voltage.....	100	125	150	volts
Cathode-Bias Resistor.....	180	100	180	ohms
Plate Resistance (Approx.).....	0.6	0.5	0.8	megohm
Transconductance.....	4500	5100	5000	$\mu$ mhos
Grid-No.1 Bias for plate current of 10 $\mu$ a.....	-5	-6	-8	volts
Plate Current.....	4.5	7.2	6.5	ma
Grid-No. 2 Current.....	1.4	2.1	2	ma

## Maximum Ratings (Triode Connection):\*

PLATE VOLTAGE.....	300 <i>max</i>	volts
PLATE DISSIPATION.....	2.5 <i>max</i>	watts

## Typical Operation (Triode Connection):\*

Plate Voltage.....	180	250	volts
Cathode-Bias Resistor.....	330	320	ohms
Plate Resistance.....	8000	10000	ohms
Amplification Factor.....	45	42	
Transconductance.....	5700	3800	$\mu$ mhos
Plate Current.....	7.0	5.5	ma

\*Grid No. 2 tied to plate.

AVERAGE PLATE CHARACTERISTICS  
PENTODE CONNECTION

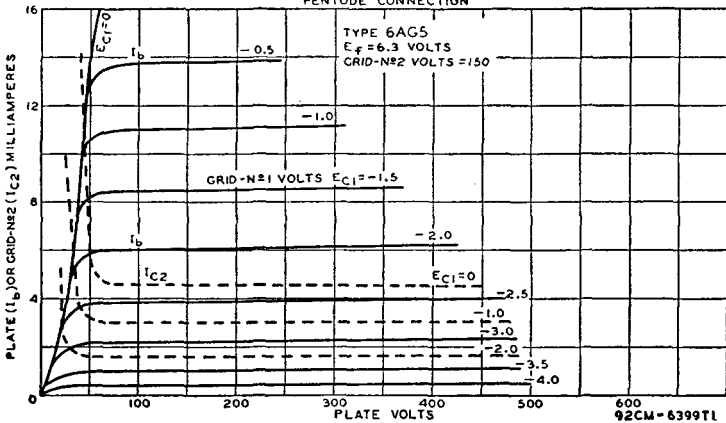

## POWER PENTODE

Metal type used in output stage of video amplifier of television receivers. Outline 6, OUTLINES SECTION. Tube requires octal socket. Heater volts (ac/dc), 6.3; amperes, 0.65. Maximum ratings as class A<sub>1</sub> video voltage amplifier: plate volts, 300 *max*; grid-No. 2 volts, 300 *max*; plate dissipation, 9.0 *max* watts; grid-No. 2 input, 1.5 *max* watts. Typical operation as a class A<sub>1</sub> amplifier: plate volts, 300; grid-No. 2

# 6AG7

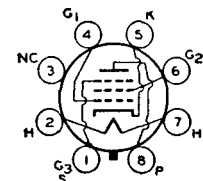

volts, 150; grid-No. 1 volts, -3; peak af grid-No. 1 volts, 3; zero-signal plate ma., 30; maximum-signal plate ma., 30.5; zero-signal grid-No. 2 ma., 7; maximum-signal grid-No. 2 ma., 9; plate resistance, 130000 ohms; transconductance, 11000  $\mu$ mhos; load resistance, 10000 ohms; total harmonic distortion, 7 per cent; maximum-signal output watts, 3.

# 6AH6

## SHARP-CUTOFF PENTODE

Miniature type used in the intermediate-frequency stages of the picture amplifier and the first stages of the video amplifier of television receivers. Outline 12, OUTLINES SECTION.

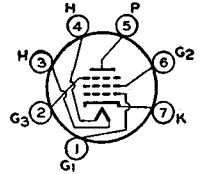

Tube requires miniature seven-contact socket and may be mounted in any position. For heater and cathode considerations, refer to type 6AQ5.

HEATER VOLTAGE (AC/DC).....	6.3	volts
HEATER CURRENT.....	0.45	ampere
DIRECT INTERELECTRODE CAPACITANCES (No external shield):		
Grid No.1 to Plate.....	0.030 max	$\mu\text{f}$
Input.....	10	$\mu\text{f}$
Output.....	2	$\mu\text{f}$

### CLASS A<sub>1</sub> AMPLIFIER

PLATE VOLTAGE.....	300 max	volts
GRID-NO.2 (SCREEN) VOLTAGE.....	150 max	volts
PLATE DISSIPATION.....	3.2 max	watts
GRID-NO.2 INPUT.....	0.4 max	watt
TOTAL CATHODE CURRENT.....	13 max	ma
PEAK HEATER-CATHODE VOLTAGE:		
Heater negative with respect to cathode.....	90 max	volts
Heater positive with respect to cathode.....	90 max	volts

### Typical Operation and Characteristics:

	Triode* Connection	Pentode Connection	
Plate Voltage.....	150	300	volts
Grid-No.3 (Suppressor).....	-	Connected to cathode at socket	
Grid-No.2 Voltage.....	-	150	volts
Cathode Resistor.....	160	160	ohms
Amplification Factor.....	40	-	
Plate Resistance (Approx.).....	3600	50000	ohms
Transconductance.....	11000	9000	$\mu\text{mhos}$
Grid-No.1 Bias (Approx.) for plate current of 10 $\mu\text{a}$ .....	-7	-7	volts
Plate Current.....	12.5	10	ma
Grid-No.2 Current.....	-	2.5	ma

\* Grid No.2 and Grid No.3 tied to plate.

# 6AK5

## SHARP-CUTOFF PENTODE

Miniature type used as an rf or if amplifier especially in high-frequency wide-band applications. It is useful as an amplifier at frequencies up to 400 megacycles per second. Outline 9,

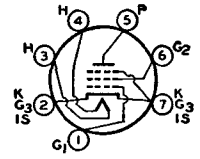

OUTLINES SECTION. Tube requires miniature seven-contact socket and may be mounted in any position. For heater and cathode considerations, refer to type 6AV6.

HEATER VOLTAGE (AC/DC).....	6.3	volts
HEATER CURRENT.....	0.175	ampere
DIRECT INTERELECTRODE CAPACITANCES (Approx. With external shield):		
Grid No.1 to Plate.....	0.02 max	$\mu\text{f}$
Input.....	4.0	$\mu\text{f}$
Output.....	2.8	$\mu\text{f}$

### CLASS A<sub>1</sub> AMPLIFIER

PLATE VOLTAGE.....	180 max	volts
GRID-NO.2 (SCREEN) VOLTAGE.....	140 max	volts
PLATE DISSIPATION.....	1.7 max	watts
GRID-NO.2 INPUT.....	0.5 max	watt
CATHODE CURRENT.....	18 max	ma
PEAK HEATER-CATHODE VOLTAGE:		
Heater negative with respect to cathode.....	90 max	volts
Heater positive with respect to cathode.....	90 max	volts



# RCA RECEIVING TUBE MANUAL

## Typical Operation and Characteristics:

Plate Voltage.....	120	180	volts
Grid-No.2 Voltage.....	120	120	volts
Cathode-Bias Resistor*.....	180	200	ohms
Plate Resistance (Approx.).....	0.3	0.5	megohm
Transconductance.....	5000	5100	$\mu$ mhos
Grid-No.1 Bias for plate current of 10 $\mu$ a.....	-8.5	-8.5	volts
Plate Current.....	7.5	7.7	ma
Grid-No.2 Current.....	2.5	2.4	ma

\* Fixed-bias operation is not recommended.

AVERAGE PLATE CHARACTERISTICS  
PENTODE CONNECTION

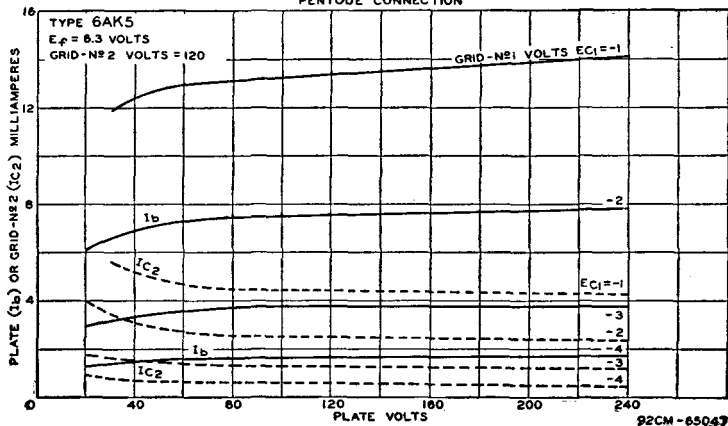

## POWER PENTODE

Miniature type used in compact equipment as a power amplifier. Outline 12, OUTLINES SECTION. Tube requires miniature seven-contact socket and may be mounted in any position. For heater and cathode considerations, refer to type 6AV6.

# 6AK6

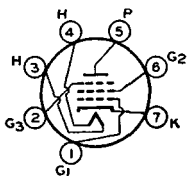

HEATER VOLTAGE (AC/DC).....	6.3	volts
HEATER CURRENT.....	0.15	ampere
DIRECT INTERELECTRODE CAPACITANCES (Approx. With no external shield):		
Grid No. 1 to Plate.....	0.12	$\mu$ f
Input.....	3.6	$\mu$ f
Output.....	4.2	$\mu$ f

## CLASS A<sub>1</sub> AMPLIFIER

### Maximum Ratings:

	Triode# Connection	Pentode Connection	
PLATE VOLTAGE.....	300 max	300 max	volts
GRID NO. 2 (SCREEN) VOLTAGE.....	-	300 max	volts
PLATE DISSIPATION.....	3.5 max	2.75 max	watts
GRID-NO.2 INPUT.....	-	0.75 max	watt
PEAK HEATER-CATHODE VOLTAGE:			
Heater negative with respect to cathode.....	90 max	90 max	volts
Heater positive with respect to cathode.....	90 max	90 max	volts

### Typical Operation:

	Triode# Connection	Pentode Connection	
Plate Voltage.....	180	180	volts
Grid No. 3 (Suppressor).....	-	Connected to cathode at socket	
Grid-No. 2 Voltage.....	-	180	volts
Grid-No. 1 Voltage†.....	-12	-9	volts
Peak AF Grid-No. 1 Voltage.....	12	9	volts
Zero-Signal Plate Current.....	12	15	ma
Zero-Signal Grid-No. 2 Current.....	-	2.5	ma
Plate Resistance.....	0.0044	0.2	megohm
Amplification Factor.....	9.3	-	
Transconductance.....	2100	2300	μmhos
Load Resistance.....	12000	10000	ohms
Total Harmonic Distortion.....	5	10	per cent
Maximum-Signal Power Output.....	0.26	1.1	watts

# Grid No. 2 and grid No. 3 tied to plate.

† The dc resistance in the grid-No.1 circuit under maximum rated conditions should not exceed 0.5 megohm for cathode-bias operation and 0.1 megohm for fixed-bias operation.

AVERAGE PLATE CHARACTERISTICS  
PENTODE CONNECTION

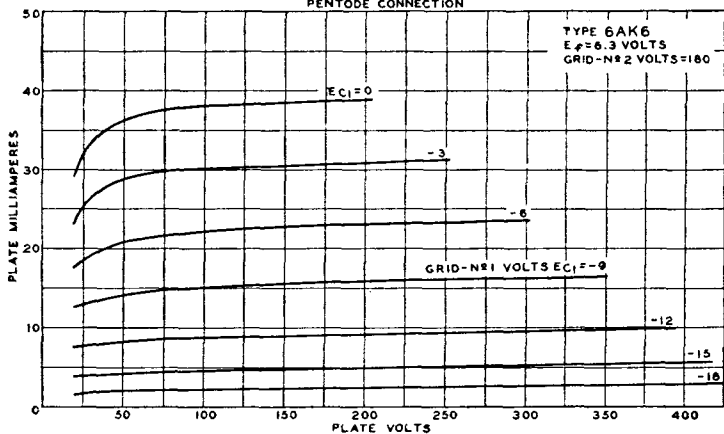

### TWIN DIODE

## 6AL5

Miniature, high-perveance type used as detector in FM and television circuits. It is especially useful as a ratio detector in ac-operated FM receivers. Each diode can be used in-

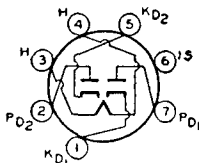

dependently of the other or combined in parallel or full-wave arrangement. Resonant frequency of each unit is approximately 700 megacycles per second. Outline 9, OUTLINES SECTION. Tube requires miniature seven-contact socket and may be mounted in any position. For heater and cathode considerations, refer to type 6AV6.

HEATER VOLTAGE (AC/DC).....	6.3	volts
HEATER CURRENT.....	0.3	ampere
DIRECT INTERELECTRODE CAPACITANCES:		
Plate No. 1 to Cathode No. 1, Heater, and Internal Shield*.....	3.2	μf
Plate No. 2 to Cathode No. 2, Heater, and Internal Shield**.....	3.2	μf
Cathode No. 1 to Plate No. 1, Heater, and Internal Shield <sup>o</sup> .....	3.6	μf
Cathode No. 2 to Plate No. 2, Heater, and Internal Shield <sup>oo</sup> .....	3.6	μf
Plate No. 1 to Plate No. 2†.....	0.026 max	μf

\* With close-fitting external shield connected to Cathode No. 1.

\*\* With close-fitting external shield connected to Cathode No. 2.

<sup>o</sup> With close-fitting external shield connected to Plate No. 1.

<sup>oo</sup> With close-fitting external shield connected to Plate No. 2.

† With close-fitting external shield connected to ground.

## HALF-WAVE RECTIFIER

### Maximum Ratings:

PEAK INVERSE PLATE VOLTAGE.....	330 <i>max</i>	volts
PEAK PLATE CURRENT PER PLATE.....	54 <i>max</i>	ma
DC OUTPUT CURRENT PER PLATE.....	9 <i>max</i>	ma
PEAK HEATER-CATHODE VOLTAGE:	330 <i>max</i>	volts
Heater negative with respect to cathode.....	330 <i>max</i>	volts
Heater positive with respect to cathode.....	330 <i>max</i>	volts

### Typical Operation:

AC Plate Voltage per Plate (rms).....	117	volts
Min. Total Effective Plate-Supply Impedance.....	300	ohms

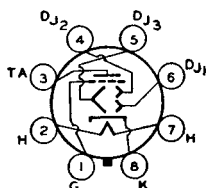

## ELECTRON-RAY TUBE

# 6AL7-GT

Glass octal type used to indicate visually on a pair of rectangular fluorescent patterns the effects of changes in voltages applied to its grid and three deflecting electrodes. It is especially useful in meeting the requirements for accurate tuning in FM receivers. Outline 17, **OUTLINES SECTION**. Tube requires octal socket and may be mounted in any position.

HEATER VOLTAGE (AC/DC).....	6.3	volts
HEATER CURRENT.....	0.15	ampere

## INDICATOR SERVICE

### Maximum Ratings:

TARGET VOLTAGE.....	{ 365 <i>max</i>	volts
	{ 220 <i>min</i>	volts
PEAK HEATER-CATHODE VOLTAGE:		
Heater negative with respect to cathode.....	90 <i>max</i>	volts
Heater positive with respect to cathode.....	90 <i>max</i>	volts

### Typical Operation:

Target Voltage.....	315	volts
Deflecting-Electrode-No.1 Voltage.....	0	volts
Deflecting-Electrode-No.2 Voltage.....	0	volts
Deflecting-Electrode-No.3 Voltage.....	0	volts
Cathode Resistor (Approx.).....	3300	ohms
Deflection Sensitivity (Approx.)#.....	1	mm/volt
Grid Voltage for Fluorescence Cutoff (Approx.)*.....	-6	volts

#For first millimeter of unbalance in FM application.

\*The grid should be connected to the cathode when not used for fluorescence control.

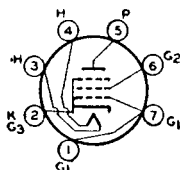

## BEAM POWER AMPLIFIER

# 6AQ5

Miniature type used as output amplifier primarily in automobile receivers and in ac-operated receivers. Within its maximum ratings, the performance of the 6AQ5 is equivalent to that of larger types 6V6 and 6V6-GT.

For typical circuits employing type 6AQ5, both singly and in push-pull, refer to **CIRCUIT SECTION**.

# RCA RECEIVING TUBE MANUAL

HEATER VOLTAGE (AC/DC) .....	6.3	volts
HEATER CURRENT .....	0.45	ampere
DIRECT INTERELECTRODE CAPACITANCES:*		
Grid No. 1 to Plate .....	0.35	μf
Input .....	7.6	μf
Output .....	6.0	μf

\* No external shield. Approximate values.

## CLASS A<sub>1</sub> AND CLASS AB<sub>1</sub> PUSH-PULL AMPLIFIER

### Maximum Ratings:

PLATE VOLTAGE .....	250 max	volts
GRID-NO. 2 VOLTAGE .....	250 max	volts
PLATE DISSIPATION .....	12 max	watts
GRID-NO.2 INPUT .....	2 max	watts
PEAK HEATER-CATHODE VOLTAGE:		
Heater negative with respect to cathode .....	90 max	volts
Heater positive with respect to cathode .....	90 max	volts

### Typical Operation:

Same as for type 6V6-GT within the limitations of the maximum ratings.

## INSTALLATION AND APPLICATION

Type 6AQ5 requires a miniature seven-contact socket and may be mounted in any position. Outline 15, OUTLINES SECTION.

When the heater is operated on ac with a transformer, the winding of the transformer which supplies the heater circuit should operate the heater at the recommended value for full-load operating conditions at average line voltage. Under any condition of operation, the heater voltage should not be allowed to vary more than 10% from the rated value. When the 6AQ5 is used in automobile receivers, the heater terminals should be connected directly across the 6-volt battery.

Use of type 6AQ5 in a series string arrangement should be limited to tubes with the same heater-current rating. If it is necessary to use the 6AQ5 in series with tubes having different heater ratings, shunt resistors are required. Refer to ELECTRON TUBE INSTALLATION SECTION for additional heater considerations.

The cathode of the 6AQ5 should preferably be connected directly to the electrical mid-point of the heater circuit when the heater voltage is supplied from a transformer. When the 6AQ5 is operated in receivers employing a 6-volt storage battery for the heater supply, its cathode circuit is tied in either directly or through bias resistors to the negative side of the dc plate supply which is furnished either by the dc power line or the ac line through a rectifier. Under any circumstances, the heater-cathode voltage should be kept within ratings. If the use of a large resistor is necessary in some circuit designs, it should be bypassed by a suitable filter network or objectionable hum may develop.

In all services, precautions should be taken to insure that the dissipation rating is not exceeded with expected line-voltage variations, especially in the cases of fixed-bias operation. When the push-pull connection is used, fixed-bias values up to 10% of each typical screen voltage can be used without increasing distortion.

The type of input coupling used in class A<sub>1</sub> and class AB<sub>1</sub> service should not introduce too much resistance in the grid-No.1 circuit. Transformer- or impedance-coupling devices are recommended. When the grid-No.1 circuit has a resistance not higher than 0.1 megohm, fixed bias may be used; for higher values, cathode bias is required. With cathode bias, the grid-No.1 circuit may have a resistance as high as, but not greater than, 0.5 megohm.

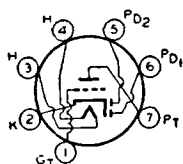
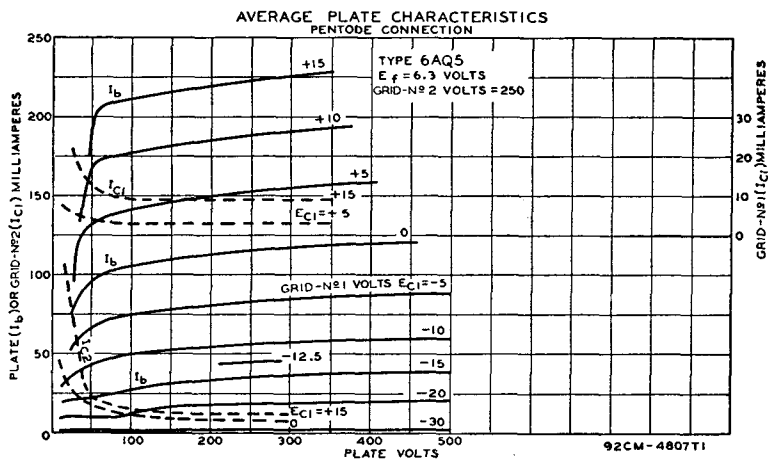

## TWIN DIODE—HIGH-MU TRIODE

Miniature type used as a combined detector, amplifier, and avc tube in compact radio receivers. This type is similar to metal type 6Q7 in many of its electrical characteristics. Outline 12,

# 6AQ6

**OUTLINES SECTION.** Tube requires miniature seven-contact socket and may be mounted in any position. For typical operation as resistance-coupled amplifier, refer to Chart 7, **RESISTANCE-COUPLED AMPLIFIER SECTION.** For heater considerations, refer to type 6AV6.

HEATER VOLTAGE (AC/DC) .....	6.3	volts
HEATER CURRENT .....	0.15	ampere
DIRECT INTERELECTRODE CAPACITANCES (Triode Unit): <sup>a</sup>		
Grid to Plate .....	1.8	μf
Input .....	1.7	μf
Output .....	1.5	μf

<sup>a</sup> With close-fitting shield connected to cathode.

### TRIODE UNIT AS CLASS A<sub>1</sub> AMPLIFIER

**Maximum Ratings:**

PLATE VOLTAGE .....	300 <i>max</i>	volts
PEAK HEATER-CATHODE VOLTAGE:		
Heater negative with respect to cathode .....	90 <i>max</i>	volts
Heater positive with respect to cathode .....	90 <i>max</i>	volts

**Characteristics:**

Plate Voltage .....	100	250	volts
Grid Voltage .....	-1	-3	volts
Amplification Factor .....	70	70	
Plate Resistance .....	61000	58000	ohms
Transconductance .....	1150	1200	μmbhos
Plate Current .....	0.8	1.0	ma

### DIODE UNITS

Two diode plates are placed around a cathode, the sleeve of which is common to the triode unit. Diode biasing of the triode unit of the 6AQ6 is not suitable. For diode operation curves, refer to type 6SQ7.

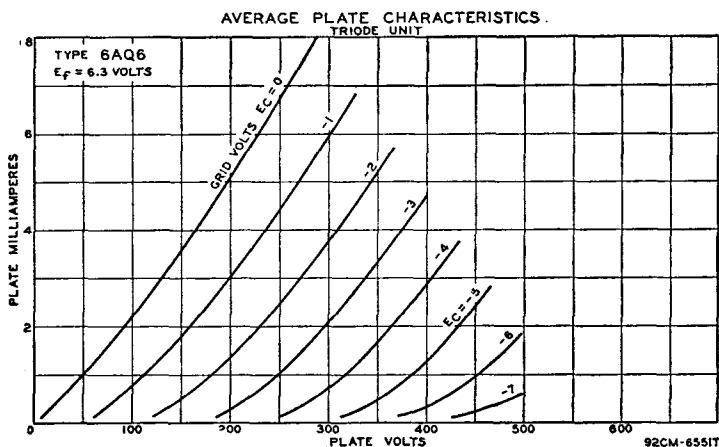

## TWIN DIODE—HIGH-MU TRIODE

### 6AQ7-GT

Glass octal type used as FM detector and audio amplifier in circuits which require diode and triode units with separate cathodes. Outline 22, OUTLINES SECTION. Tube requires

octal socket. Heater volts (ac/dc), 6.3; amperes, 0.3. Ratings and characteristics of triode unit as class A<sub>1</sub> amplifier: plate volts, 250 *max*; grid volts, -2; amplification factor, 70; plate resistance (approx.), 44000 ohms; transconductance, 1600  $\mu$ mhos; plate ma., 2.3. For typical operation as a resistance-coupled amplifier, refer to Chart 7, RESISTANCE-COUPLED AMPLIFIER SECTION.

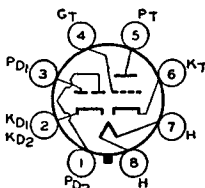

## POWER PENTODE

### 6AR5

Miniature type used as output tube primarily in automobile receivers and ac-operated receivers. Outline 15, OUTLINES SECTION. Tube requires miniature seven-contact socket and

may be mounted in any position. For heater and cathode considerations, refer to miniature type 6AQ5. Within its maximum ratings, type 6AR5 is equivalent in performance to glass-octal type 6K6-GT. Refer to type 6K6-GT for characteristic curves.

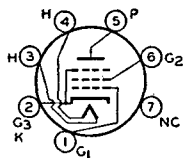

HEATER VOLTAGE (AC/DC) .....	6.3	volts
HEATER CURRENT .....	0.4	ampere

#### Maximum Ratings:

#### CLASS A<sub>1</sub> AMPLIFIER

PLATE VOLTAGE .....	250 <i>max</i>	volts
GRID-NO.2 (SCREEN) VOLTAGE .....	250 <i>max</i>	volts
PLATE DISSIPATION .....	8.5 <i>max</i>	watts
GRID-NO.2 INPUT .....	2.5 <i>max</i>	watts
<b>PEAK HEATER-CATHODE VOLTAGE:</b>		
Heater negative with respect to cathode .....	90 <i>max</i>	volts
Heater positive with respect to cathode .....	90 <i>max</i>	volts

# RCA RECEIVING TUBE MANUAL

### Typical Operation and Characteristics:

Plate Voltage.....	250	250	volts
Grid-No.2 Voltage.....	250	250	volts
Grid-No.1 (Control-Grid) Voltage.....	-16.5	-18	volts
Peak AF Grid-No.1 Voltage.....	16.5	18	volts
Zero-Signal Plate Current.....	34	32	ma
Maximum-Signal Plate Current.....	36	33	ma
Zero-Signal Grid-No.2 Current.....	5.7	5.5	ma
Maximum-Signal Grid-No.2 Current.....	10	10	ma
Plate Resistance (Approx.).....	65000	68000	ohms
Transconductance.....	2400	2300	$\mu$ mhos
Load Resistance.....	7000	7600	ohms
Total Harmonic Distortion.....	7	11	per cent
Maximum-Signal Power Output.....	3.2	3.4	watts

### Maximum Circuit Values (For maximum rated conditions):

Grid-No.1-Circuit Resistance	Fixed Bias.....	0.1 max	megohm
	Cathode Bias.....	0.5 max	megohm

## BEAM POWER AMPLIFIER

Miniature type used as output amplifier primarily in automobile and in ac-operated receivers. Outline 15, OUTLINES SECTION. Tube requires miniature seven-contact socket and may be mounted in any position.

# 6AS5

For heater and cathode considerations, refer to type 6AQ5. For curves, refer to type 35C5.

HEATER VOLTAGE (AC/DC).....	6.3	volts
HEATER CURRENT.....	0.8	ampere
DIRECT INTERELECTRODE CAPACITANCES (Approx.):*		
Grid No.1 to Plate.....	0.6	$\mu$ f
Input.....	12	$\mu$ f
Output.....	6.2	$\mu$ f

\* With no external shield.

### Maximum Ratings:

### CLASS A<sub>1</sub> AMPLIFIER

PLATE VOLTAGE.....	150 max	volts
GRID-NO.2 (SCREEN) VOLTAGE.....	117 max	volts
PLATE DISSIPATION.....	5.5 max	watts
GRID-NO.2 INPUT.....	1.0 max	watt
PEAK HEATER-CATHODE VOLTAGE:		
Heater negative with respect to cathode.....	90 max	volts
Heater positive with respect to cathode.....	90 max	volts
BULB TEMPERATURE (At hottest point on bulb surface).....	250 max	°C

### Typical Operation:

Plate Voltage.....	150	volts
Grid-No.2 Voltage.....	110	volts
Grid-No.1 (Control-Grid) Voltage.....	-8.5	volts
Peak AF Grid-No.1 Voltage.....	8.5	volts
Zero-Signal Plate Current.....	35	ma
Maximum-Signal Plate Current.....	36	ma
Zero-Signal Grid-No.2 Current (Approx.).....	2	ma
Maximum-Signal Grid-No.2 Current (Approx.).....	6.5	ma
Transconductance.....	5600	$\mu$ mhos
Load Resistance.....	4500	ohms
Total Harmonic Distortion.....	10	per cent
Maximum-Signal Power Output.....	2.2	watts

### Maximum Circuit Values (For maximum rated conditions):

Grid-No.1-Circuit Resistance	Fixed Bias.....	0.1 max	megohm
	Cathode Bias.....	0.5 max	megohm

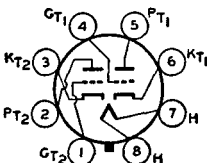

## LOW-MU TWIN POWER TRIODE

Glass octal type used as a regulator tube in dc power-supply units, as a booster tube in the scanning circuit of television receivers, and as a push-pull class A output tube in high-fidel-

# 6AS7-G

ity audio amplifiers. Outline 40, OUTLINES SECTION. Tube requires octal socket and may be mounted in any position. It is especially important that this tube, like other power-handling tubes, should be adequately ventilated. For an audio amplifier circuit employing this tube, refer to the CIRCUIT SECTION. An operation characteristic curve for the 6AS7-G in this amplifier circuit, is given on the next page.

HEATER VOLTAGE (AC/DC).....	6.3	volts
HEATER CURRENT.....	2.5	amperes
DIRECT INTERELECTRODE CAPACITANCES (Approx.):		
Grid to Plate.....	10.5	$\mu\text{f}$
Input.....	6.8	$\mu\text{f}$
Output.....	2.3	$\mu\text{f}$
Heater to Cathode.....	6.7	$\mu\text{f}$
Grid to Grid.....	0.70	$\mu\text{f}$
Plate to Plate.....	1.65	$\mu\text{f}$

### Maximum Ratings:

### DC AMPLIFIER (Each Unit)

PLATE VOLTAGE.....	250 <i>max</i>	volts
PLATE CURRENT.....	125 <i>max</i>	ma
PLATE DISSIPATION.....	13 <i>max</i>	watts
PEAK HEATER-CATHODE VOLTAGE:		
Heater negative with respect to cathode.....	300 <i>max</i>	volts
Heater positive with respect to cathode.....	300 <i>max</i>	volts

### Characteristics:

Plate-Supply Voltage.....	135	volts
Cathode-Bias Resistor*.....	250	ohms
Amplification Factor.....	2.0	
Plate Resistance.....	280	ohms
Transconductance.....	7000	$\mu\text{mhos}$
Plate Current.....	125	ma

### Maximum Circuit Value (For maximum rated conditions):

Grid-Circuit Resistance for Cathode-Bias Operation*.....	1.0	megohm
--	-----	--------

### Maximum Ratings:

### BOOSTER SCANNING SERVICE (Each Unit)

PEAK NEGATIVE-PULSE PLATE VOLTAGE.....	1700 <i>max</i>	volts
DC PLATE CURRENT.....	125 <i>max</i>	ma
PLATE DISSIPATION.....	13 <i>max</i>	watts
PEAK HEATER-CATHODE VOLTAGE:		
Heater negative with respect to cathode.....	300 <i>max</i>	volts
Heater positive with respect to cathode.....	300 <i>max</i>	volts

### Maximum Circuit Value (For maximum rated conditions):

Grid-Circuit Resistance for Cathode-Bias Operation*.....	1.0	megohm
--	-----	--------

\* Operation with fixed bias is not recommended.

AVERAGE PLATE CHARACTERISTICS  
EACH TRIODE UNIT

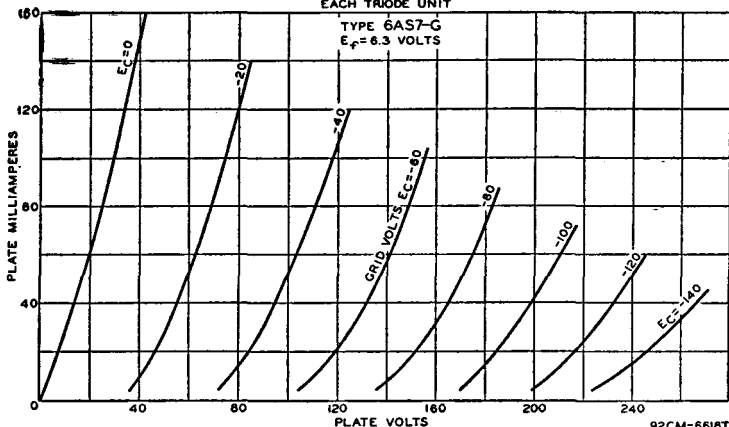

92CM-6618T



## OPERATION CHARACTERISTICS CLASS A<sub>1</sub> PUSH-PULL CIRCUIT (16-12) IN CIRCUIT SECTION

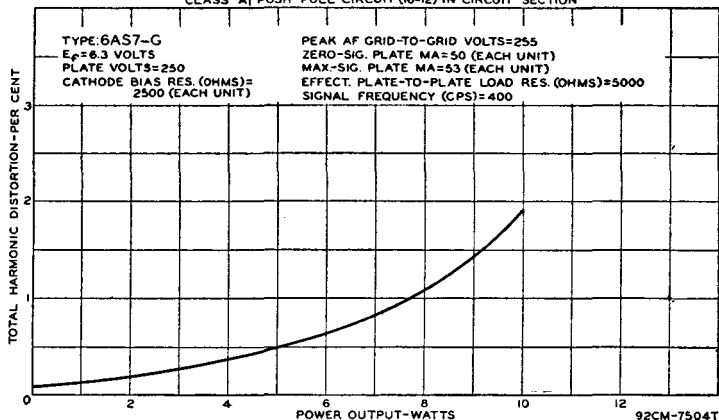

TYPE 6AS7-G  
E<sub>f</sub>=6.3 VOLTS  
PLATE VOLTS=250  
CATHODE BIAS RES. (OHMS)=  
2500 (EACH UNIT)

PEAK AF GRID-TO-GRID VOLTS=255  
ZERO-SIG. PLATE MA=50 (EACH UNIT)  
MAX-SIG. PLATE MA=53 (EACH UNIT)  
EFFECT. PLATE-TO-PLATE LOAD RES. (OHMS)=5000  
SIGNAL FREQUENCY (CPS)=400

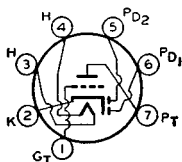

### TWIN DIODE—HIGH-MU TRIODE

Miniature type used as a combined detector, amplifier, and avc tube in automobile and ac-operated radio receivers. Outline 12, OUTLINES SECTION. Tube requires miniature

# 6AT6

seven-contact socket and may be mounted in any position. For typical operation as resistance-coupled amplifier, refer to Chart 7, RESISTANCE-COUPLED AMPLIFIER SECTION. For heater considerations, refer to type 6AV6.

HEATER VOLTAGE (AC/DC) .....	6.3	volts
HEATER CURRENT .....	0.3	ampere
DIRECT INTERELECTRODE CAPACITANCES (No external shield):		
Triode Grid to Plate .....	2.0	μf
Triode Input .....	2.2	μf
Triode Output .....	0.8	μf
Diode Plate No.2 to Triode Grid .....	0.04 max	μf

#### Maximum Ratings:

#### TRIODE UNIT AS CLASS A<sub>1</sub> AMPLIFIER

PLATE VOLTAGE .....	300 max	volts
PLATE DISSIPATION .....	0.5 max	watt
GRID VOLTAGE, Positive Bias Value .....	0 max	volts
PEAK HEATER-CATHODE VOLTAGE:		
Heater negative with respect to cathode .....	90 max	volts
Heater positive with respect to cathode .....	90 max	volts

#### Characteristics:

Plate Voltage .....	100	250	volts
Grid Voltage .....	-1	-3	volts
Amplification Factor .....	70	70	
Plate Resistance .....	54000	58000	ohms
Transconductance .....	1300	1200	μmhos
Plate Current .....	0.8	1.0	ma

#### DIODE UNITS

#### Maximum Rating:

PLATE CURRENT (EACH UNIT) .....	1.0 max	ma
---------------------------------	---------	----

The two diode plates are placed around a cathode, the sleeve of which is common to the triode unit. Each diode plate has its own base pin. For diode operation curves, refer to type 6SQ7.

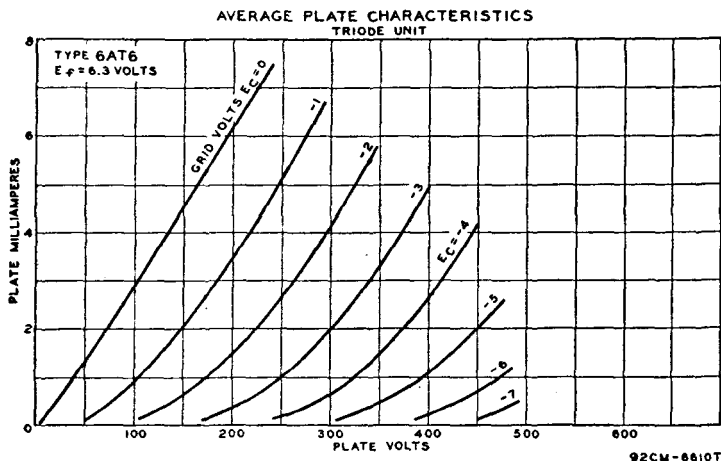

## BEAM POWER AMPLIFIER

### 6AU5-GT

Glass octal type used as horizontal deflection amplifier in low-cost, high-efficiency deflection circuits of television receivers employing either transformer coupling or direct coupling to

the deflecting yoke. Outline 21, OUTLINES SECTION. Tube requires octal socket and may be mounted in any position.

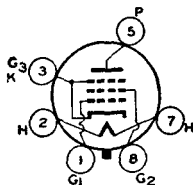

HEATER VOLTAGE (AC/DC).....	6.3	volts
HEATER CURRENT.....	1.25	amperes
DIRECT INTERELECTRODE CAPACITANCES (No external shield):		
Grid No.1 to Plate.....	0.5	$\mu\text{f}$
Input.....	11.3	$\mu\text{f}$
Output.....	7.0	$\mu\text{f}$
TRANSCONDUCTANCE#.....	6000	$\mu\text{mhos}$
MU-FACTOR, Grid No.2 to Grid No.1†.....	5.9	
# For plate volts, 115; grid-No.2 volts, 175; grid-No.1 volts, -20.		
† For plate volts, 100; grid-No.2 volts, 100; grid-No.1 volts, -4.5.		

## HORIZONTAL DEFLECTION AMPLIFIER

*For operation in a 525-line, 30-frame system.*

### Maximum Ratings:

DC PLATE VOLTAGE.....	450 <i>max</i>	volts
PEAK POSITIVE-PULSE PLATE VOLTAGE*.....	5000 <i>max</i>	volts
PEAK NEGATIVE-PULSE PLATE VOLTAGE*.....	-1000 <i>max</i>	volts
DC GRID-NO.2 (SCREEN) VOLTAGE <sup>o</sup> .....	200 <i>max</i>	volts
DC GRID-NO.1 (CONTROL-GRID) VOLTAGE.....	-50 <i>max</i>	volts
PEAK NEGATIVE-PULSE GRID-NO.1 VOLTAGE.....	-100 <i>max</i>	volts
DC PLATE CURRENT.....	100 <i>max</i>	ma
PLATE DISSIPATION.....	10 <i>max</i>	watts
GRID-NO.2 INPUT.....	2.5 <i>max</i>	watts
PEAK HEATER-CATHODE VOLTAGE:		
Heater negative with respect to cathode.....	180 <i>max</i>	volts
Heater positive with respect to cathode.....	180 <i>max</i>	volts

\* The duration of the voltage pulse must not exceed 15% of one horizontal scanning cycle. In a 525-line, 30-frame system, 15% of one horizontal scanning cycle is 10 microseconds.

<sup>o</sup> Preferably obtained through a series dropping resistor of sufficient magnitude to limit the grid-No.2 input to the rated maximum value.

### AVERAGE PLATE CHARACTERISTICS

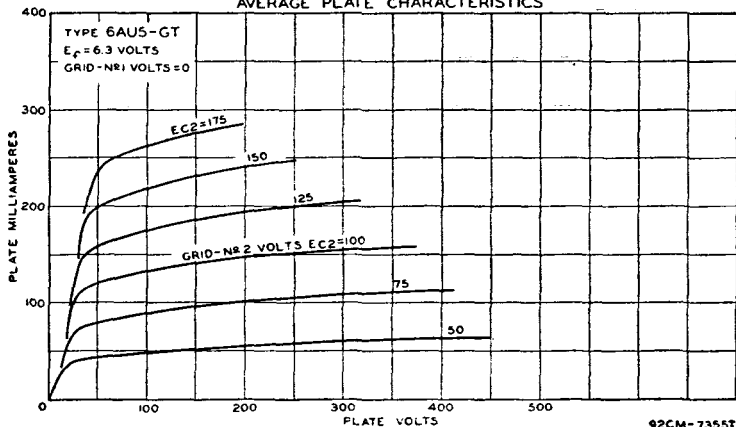

92CM-7355T

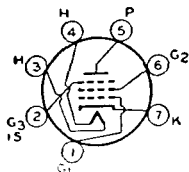

## SHARP-CUTOFF PENTODE

Miniature type used in compact radio equipment as an rf amplifier especially in high-frequency, wide-band applications. It is also used as a limiter tube in FM equipment. Outline 12,

# 6AU6

OUTLINES SECTION. Tube requires miniature seven-contact socket and may be mounted in any position. For a discussion of limiters, refer to ELECTRON TUBE APPLICATIONS SECTION. For typical operation as resistance-coupled amplifier, refer to Chart 8, RESISTANCE-COUPLED AMPLIFIER SECTION. For heater and cathode considerations, refer to type 6AV6.

HEATER VOLTAGE (AC/DC).....	6.3	volts
HEATER CURRENT.....	0.3	ampere
DIRECT INTERELECTRODE CAPACITANCES (No external shield):		
Grid No.1 to Plate.....	0.0035 max	μf
Input.....	5.5	μf
Output.....	5.0	μf

### CLASS A<sub>1</sub> AMPLIFIER

Maximum Ratings:	<i>Triode†</i> Connection	<i>Pentode</i> Connection	
PLATE VOLTAGE.....	250 max	300 max	volts
GRID-NO.2 (SCREEN) VOLTAGE.....	-	150 max	volts
GRID-NO.2 SUPPLY VOLTAGE.....	-	300 max	volts
PLATE DISSIPATION.....	3.2 max	3 max	watts
GRID-NO.2 INPUT.....	-	0.65 max	watt
GRID-NO.1 (CONTROL-GRID) VOLTAGE:			
Negative bias value.....	50 max	50 max	volts
Positive bias value.....	0 max	0 max	volts
PEAK HEATER-CATHODE VOLTAGE:			
Heater negative with respect to cathode.....	90 max	90 max	volts
Heater positive with respect to cathode.....	90 max	90 max	volts

#### Typical Operation (Pentode Connection):

Plate Voltage.....	100	250	300	volts
Grid No.3 (Suppressor).....	Connected to cathode at socket			
Grid-No.2 Voltage.....	100	125	150	volts
Cathode Resistor.....	150	100	68	ohms
Plate Resistance (Approx.).....	0.5	1.5	1.0	megohms
Transconductance.....	3900	4500	5200	μmhos
Grid-No.1 Bias for plate current of 10 μa.....	-4.2	-5.5	-6.5	volts
Plate Current.....	5.0	7.6	10.6	ma
Grid-No. 2 Current.....	2.1	3.0	4.8	ma

### Typical Operation (Triode Connection):†

Plate Voltage . . . . .	250	volts
Cathode Resistor . . . . .	330	ohms
Amplification Factor . . . . .	36	
Plate Resistance . . . . .	7500	ohms
Transconductance . . . . .	4800	$\mu$ mhos
Plate Current . . . . .	12.2	ma

† Grid No. 2 and grid No. 3 tied to plate.

**AVERAGE PLATE CHARACTERISTICS  
PENTODE CONNECTION**

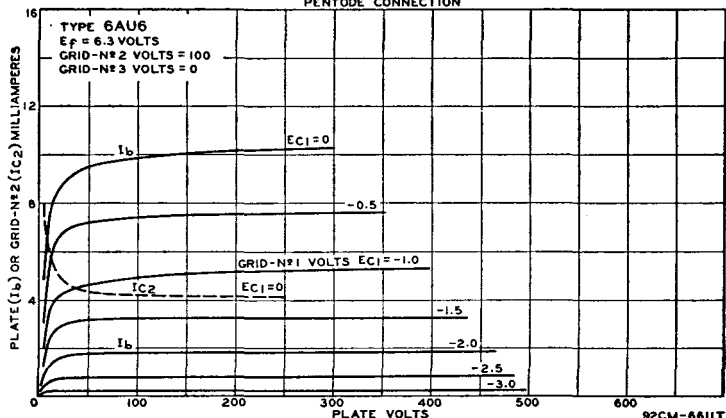

## 6AV6

### TWIN DIODE— HIGH-MU TRIODE

Miniature type used as combined detector, amplifier, and avc tube in automobile and ac-operated radio receivers. The 6AV6 may be substituted directly for the 6AT6 in applications

where the higher amplification of the 6AV6 is advantageous.

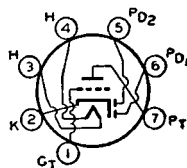

HEATER VOLTAGE (AC/DC) . . . . .	6.3	volts
HEATER CURRENT . . . . .	0.3	ampere
DIRECT INTERELECTRODE CAPACITANCES (No external shield):		
Triode Grid to Triode Plate . . . . .	2.0	$\mu$ fd
Triode Input . . . . .	2.2	$\mu$ fd
Triode Output . . . . .	0.8	$\mu$ fd
Diode No.2 Plate to Triode Grid . . . . .	0.04 max	$\mu$ fd

#### Maximum Ratings: TRIODE UNIT AS CLASS A<sub>1</sub> AMPLIFIER

PLATE VOLTAGE . . . . .	300 max	volts
GRID VOLTAGE, Positive Bias Value . . . . .	0 max	volts
PLATE DISSIPATION . . . . .	0.5 max	watt
PEAK HEATER-CATHODE VOLTAGE:		
Heater negative with respect to cathode . . . . .	90 max	volts
Heater positive with respect to cathode . . . . .	90 max	volts

#### Characteristics:

Plate Voltage . . . . .	100	250	volts
Grid Voltage . . . . .	-1	-2	volts
Amplification Factor . . . . .	100	100	
Plate Resistance . . . . .	80000	62500	ohms
Transconductance . . . . .	1250	1600	$\mu$ mhos
Plate Current . . . . .	0.50	1.2	ma

#### Maximum Rating:

PLATE CURRENT (Each Unit) . . . . .	1.0 max	ma
-------------------------------------	---------	----

The two diode plates are placed around a cathode, the sleeve of which is common to the triode unit. Each diode plate has its own base pin. Diode biasing of the triode unit is not recommended. For diode operation curves, refer to type 6SQ7.

## INSTALLATION AND APPLICATION

Type 6AV6 requires miniature seven-contact socket and may be mounted in any position. Outline 12, OUTLINES SECTION.

When the heater is operated on ac with a transformer, the winding of the transformer which supplies the heater circuit should operate the heater at the recommended value for full-load operating conditions at average line voltage. Under any condition of operation, the heater voltage should not be allowed to rise more than 10% above the rated value. When the 6AV6 is used in automobile receivers, the heater terminals should be connected directly across a 6-volt battery.

In receivers that employ a series-heater connection, the heater of the 6AV6 may be operated in series with the heater of other types having the same heater-current rating. The current in the heater circuit of the 6AV6 should be adjusted to the rated value for the normal supply voltage. Refer to ELECTRON TUBE INSTALLATION SECTION, *Filament and Heater Power Supply*, for a discussion of arrangement of heaters in series-heater or "string" connection.

The cathode of the 6AV6 when operated from a transformer, should preferably be connected directly to the electrical mid-point of the heater circuit. When operated in receivers employing a 6-volt storage battery for the heater supply, the cathode circuit is tied in either directly or through bias resistors to the negative side of the dc plate supply which is furnished either by the dc power line or the ac line through a rectifier. In circuits where the cathode is not connected directly to the heater, such as in a series-heater connection, the voltage difference between the heater and cathode should be kept within the tube ratings. If the use of a large resistor is necessary between the heater and cathode in some circuit designs, it should be bypassed by a suitable filter network or objectionable hum may develop.

The triode unit of the 6AV6 is recommended for use only in resistance-coupled circuits. Refer to the RESISTANCE-COUPLED AMPLIFIER SECTION, Chart 25 for typical operating conditions.

Grid bias for the triode unit of the 6AV6 may be obtained from a fixed source, such as a fixed-voltage tap on the dc power supply or from a cathode-bias resistor. It should not be obtained by the diode-biasing method because of the probability of plate-current cutoff, even with relatively small signal voltages applied to the diode circuit.

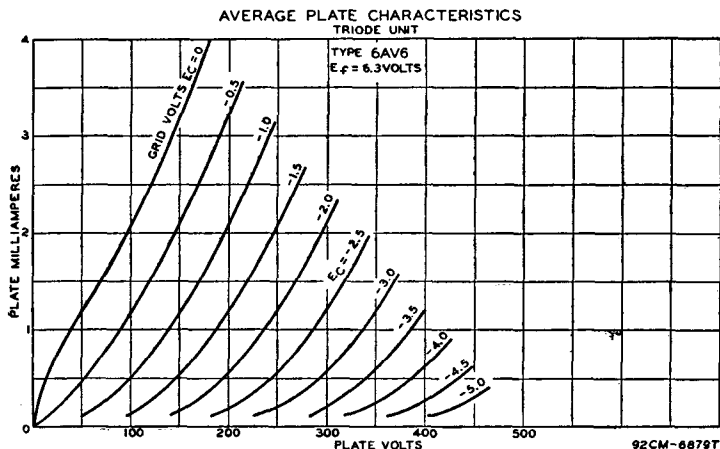

# 6AX5-GT

## FULL-WAVE VACUUM RECTIFIER

Glass octal type used in power supply of radio equipment having moderate dc requirements. The heater of this tube can be operated from the same transformer winding that supplies other 6.3-volt tubes in the receiver. In addition, because its heater-cathode construction gives the same heating time as that of other heater-cathode types in the receiver, use of the 6AX5-GT prevents excessive voltages from appearing across filter capacitors during warmup, and, as a result, permits the use of electrolytic filter capacitors having lower peak voltage ratings than required for a filament-type rectifier tube.

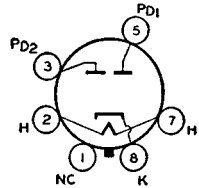

HEATER VOLTAGE (AC).....	6.3	volts
HEATER CURRENT.....	1.2	amperes

### FULL-WAVE RECTIFIER

#### Maximum Ratings:

PEAK INVERSE PLATE VOLTAGE.....	1250 max	volts
PEAK PLATE CURRENT PER PLATE.....	375 max	ma
HOT-SWITCHING TRANSIENT PLATE CURRENT		
For duration of 0.2 second maximum.....	2.6 max	amperes
AC PLATE SUPPLY VOLTAGE PER PLATE (RMS).....	See Rating Chart	
DC OUTPUT CURRENT PER PLATE (RMS).....	See Rating Chart	
PEAK HEATER-CATHODE VOLTAGE:		
Heater negative with respect to cathode.....	450 max	volts
Heater positive with respect to cathode.....	450 max	volts

#### Typical Operation with Capacitor Input to Filter:

AC Plate-to-Plate Supply Voltage (rms).....	700	900	volts
Filter Input Capacitor*.....	10	10	μf
Effective Plate-Supply Impedance Per Plate.....	50	105	ohms
DC Output Voltage at Input to Filter (Approx.):			
At half-load current of { 62.5 ma .....	395	-	volts
{ 40 ma .....	-	540	volts
At full-load current of { 125 ma .....	350	-	volts
{ 80 ma .....	-	490	volts
Voltage Regulation (Approx.):			
Half-load to full-load current.....	45	50	volts

#### Typical Operation with Choke Input to Filter:

AC Plate-to-Plate Supply Voltage (rms).....	700	900	volts
Filter Input Choke.....	10 #	10 # #	henries
DC Output Voltage at Input to Filter (Approx.):			
At half-load current of { 75 ma .....	270	-	volts
{ 62.5 ma .....	-	365	volts
At full-load current of { 150 ma .....	250	-	volts
{ 125 ma .....	-	350	volts
Voltage Regulation (Approx.):			
Half-load to full-load current.....	20	15	volts

\* Higher values of capacitance than indicated may be used but the effective plate-supply impedance may have to be increased to prevent exceeding the maximum rating for hot-switching transient plate current.

# This value is adequate to maintain optimum regulation in the region to the right of line L=10H on curve OPERATION CHARACTERISTICS With Choke Input to Filter, provided the load current is not less than 30 ma. For load currents less than 30 ma, a larger value of inductance is required for optimum regulation.

# # This value is adequate to maintain optimum regulation in the region to the right of line L=10H on curve OPERATION CHARACTERISTICS With Choke Input to Filter, provided the load current is not less than 35 ma. For load currents less than 35 ma, a larger value of inductance is required for optimum regulation.

INSTALLATION AND APPLICATION

Type 6AX5-GT requires an octal socket and may be mounted in any position. Outline 21, OUTLINES SECTION. It is especially important that this tube, like other power-handling tubes, should be adequately ventilated.

The *Rating Chart* presents graphically the relationships between maximum ac voltage input and maximum dc output current derived from the fundamental ratings for conditions of capacitor-input and choke-input filters. This graphical presentation provides for considerable latitude in choice of operating conditions.

The *Operation Characteristics* for a full-wave rectifier with capacitor-input filter, show by means of boundary line "ADK" the limiting current and voltage relationships presented in the Rating Chart.

The *Operation Characteristics* for a full-wave rectifier with choke-input filter not only show by means of boundary line "CEK" the limiting current and voltage relationships presented in the Rating Chart, but also give information as to the effect on regulation of various sizes of chokes. The solid-line curves show the dc voltage outputs which would be obtained if the filter chokes had infinite inductance. The long-dash lines radiating from the zero position are boundary lines for various sizes of chokes as indicated. The intersection of one of these lines with a solid-line curve indicates the point on the curve at which the choke no longer behaves as though it had infinite inductance. To the left of the choke boundary line, the regulation curves depart from the solid-line curves as shown by the representative short-dash regulation curves.

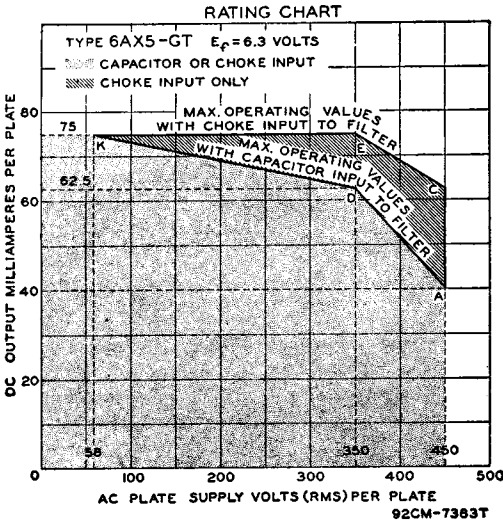

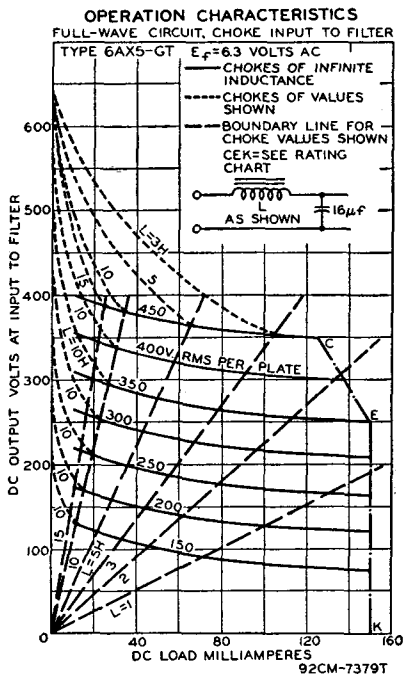
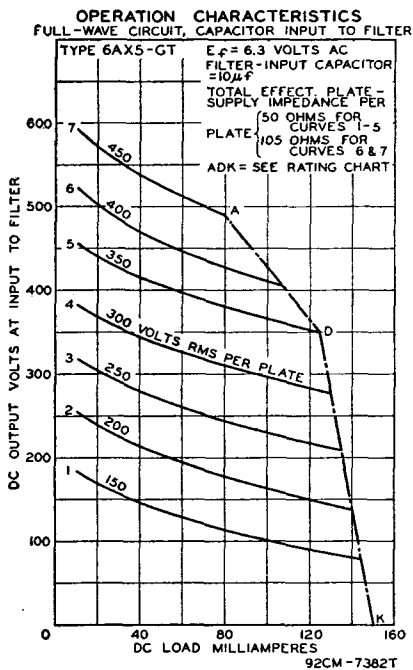

## 6B4-G

### POWER TRIODE

Glass octal type used in output stage of radio receivers and amplifiers. Outline 40, OUTLINES SECTION. Tube requires octal socket and may be mounted in any position. For installation and application information, and typical operation as a single-tube class A amplifier, refer to type 2A3.

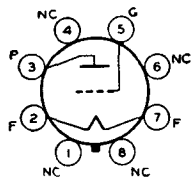

FILAMENT VOLTAGE (AC/DC).....	6.3	volts
FILAMENT CURRENT.....	1.0	ampere

### PUSH-PULL CLASS AB<sub>1</sub> AMPLIFIER

#### Maximum Ratings:

PLATE VOLTAGE.....	325 max	volts
PLATE DISSIPATION.....	15 max	watts

#### Typical Operation (Values are for Two Tubes):

	Fixed Bias	Cathode Bias	
Plate Voltage.....	325	325	volts
Grid Voltage*.....	-68	-	volts
Cathode-Bias Resistor.....	-	850	ohms
Plate Current.....	80	80	ma
Effective Load Resistance (Plate-to-plate).....	3000	5000	ohms
Total Harmonic Distortion.....	2.5	5	per cent
Power Output.....	15	10	watts

\* Grid voltage referred to mid-point of ac-operated filament.



**DIRECT-COUPLED POWER TRIODE**

Glass type used as class A<sub>1</sub> power amplifier. One triode, the driver, is directly connected within the tube to the second, or output, triode. Outline 36, OUTLINES SECTION. Tube requires six-contact socket. Heater volts (ac/dc), 6.3; amperes, 0.8. Characteristics of input and output triodes as class A<sub>1</sub> amplifier follow. Input triode: plate volts, 300 *max*; grid volts, 0; plate

**6B5**

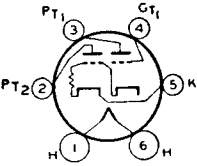

ma., 8. Output triode: plate volts, 300 *max*; plate ma., 45; plate resistance, 24000 ohms; load resistance, 7000 ohms; output watts, 4. This type is used principally for renewal purposes.

**TWIN-DIODE—HIGH-MU TRIODE**

Glass octal type used as combined detector, amplifier, and avc tube. Outline 33, OUTLINES SECTION. Tube requires octal socket. Heater volts (ac/dc), 6.3; amperes, 0.3. Within its triode maximum plate-voltage rating of 250 volts, this type is similar electrically to type 6SQ7 and curves under that type apply to the 6B6-G. This type is used principally for renewal purposes.

**6B6-G**

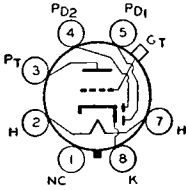

**TWIN-DIODE—  
REMOTE-CUTOFF PENTODE**

Glass types used as combined detector, amplifier, and avc tubes. Outline 34, OUTLINES SECTION. These types fit the small seven-contact (0.75-inch, pin-circle diameter) socket. Except for interelectrode capacitances, the electrical characteristics of the 6B7 are identical with those of type 6B8-G. Type 6B7 is used principally for renewal purposes. Type 6B7S,

**6B7**

**6B7S**

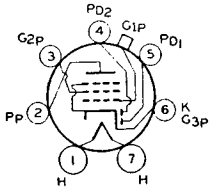

now DISCONTINUED, has the external shield connected to the cathode. In general, its electrical characteristics are similar to those of the 6B7, but the two types are usually not directly interchangeable.

**TWIN-DIODE—  
REMOTE-CUTOFF PENTODE**

Metal type 6B8 and glass octal type 6B8-G are used as combined detector, amplifier, and avc tubes. Outlines 4 and 33, respectively, OUTLINES SECTION. Type 6B8-G is used principally for renewal purposes. Tubes require octal socket. Type 6B8-G requires complete shielding of detector circuits. Heater volts (ac/dc), 6.3; amperes, 0.3. Maximum ratings of

**6B8  
6B8-G**

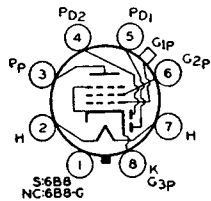

pentode unit as class A<sub>1</sub> amplifier: plate volts, 300 *max*; grid-No.2 (screen) volts, 125 *max*; grid-No.2 supply volts, 300 *max*; grid-No.1 volts, 0 *min*; plate dissipation, 3.0 *max* watts (6B8), 2.25 *max* watts (6B8-G); grid-No.2 input, 0.3 *max* watt. For typical operation as a resistance-coupled amplifier, refer to Chart 5, RESISTANCE-COUPLED AMPLIFIER SECTION.

**REMOTE-CUTOFF PENTODE**

Miniature type used as rf amplifier in standard broadcast and FM receivers, as well as in wide-band, high-frequency applications. This type is similar in performance to metal type

**6BA6**

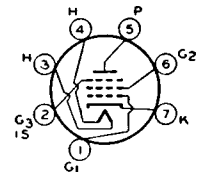

6SG7. The low value of grid-No.1-to-plate capacitance minimizes regenerative effects, while the high transconductance makes possible high signal-to-noise ratio.

# RCA RECEIVING TUBE MANUAL

HEATER VOLTAGE (AC/DC) .....	6.3	volts
HEATER CURRENT .....	0.3	ampere
DIRECT INTERELECTRODE CAPACITANCES (No external shield):		
Grid No.1 to Plate .....	0.0035 max	$\mu\mu\text{f}$
Input .....	5.5	$\mu\mu\text{f}$
Output .....	5.0	$\mu\mu\text{f}$

## Maximum Ratings:

### CLASS A<sub>1</sub> AMPLIFIER

PLATE VOLTAGE .....	300 max	volts
GRID-NO.2 (SCREEN) VOLTAGE .....	125 max	volts
GRID-NO.2 SUPPLY VOLTAGE .....	300 max	volts
PLATE DISSIPATION .....	3 max	watts
GRID-NO.2 INPUT .....	0.6 max	watt
GRID-NO.1 (CONTROL-GRID) VOLTAGE:		
Negative bias value .....	50 max	volts
Positive bias value .....	0 max	volts
PEAK HEATER-CATHODE VOLTAGE:		
Heater negative with respect to cathode .....	90 max	volts
Heater positive with respect to cathode .....	90 max	volts

## Typical Operation:

Plate Voltage .....	100	250	volts
Grid No.3 (Suppressor) .....	Connected to cathode at socket		
Grid-No.2 Voltage .....	100	100	volts
Cathode-Bias Resistor .....	68	68	ohms
Plate Resistance (Approx.) .....	0.25	1.0	megohm
Transconductance .....	4300	4400	$\mu\text{mhos}$
Grid-No.1 Bias (Approx.) for transconductance of 40 $\mu\text{mhos}$ .....	-20	-20	volts
Plate Current .....	10.8	11	ma
Grid-No.2 Current .....	4.4	4.2	ma

## INSTALLATION AND APPLICATION

Type 6BA6 requires miniature seven-contact socket and may be mounted in any position. Outline 12, OUTLINES SECTION. For heater and cathode considerations, refer to type 6AV6.

Control-grid bias variation will be found effective in changing the volume of the receiver. In order to obtain adequate volume control, an available grid-No.1-bias voltage of approximately 50 volts will be required. The exact value will depend upon the circuit design and operating conditions. This voltage may be obtained, depending on the receiver requirements, from a potentiometer across a fixed supply voltage, from a variable cathode-bias resistor, from the avc system, or from a combination of these methods.

The grid-No. 2 (screen) voltage may be obtained from a potentiometer or bleeder circuit across the B-supply source, or through a dropping resistor from the plate supply. The use of series resistors for obtaining satisfactory control of grid-No.2 voltage in the case of four-electrode tubes is usually impossible because of secondary-emission phenomena. In the 6BA6, however, because grid No.3 practically removes these effects, it is practical to obtain grid-No.2 voltage through a series-dropping resistor from the plate supply or from some high intermediate voltage, providing these sources do not exceed the plate-supply voltage. With this method, the grid-No.2-to-cathode voltage will fall off very little from minimum to maximum value of the resistor controlling cathode bias. In some cases, it may actually rise. This rise of grid-No.2-to-cathode voltage above the normal maximum value is allowable because both the grid-No.2 current and the plate current are reduced simultaneously by a sufficient amount to prevent damage to the tube. It should be recognized that, in general, the series-resistor method of obtaining grid-No.2 voltage from a higher voltage supply necessitates the use of the variable cathode-resistor method of controlling volume in order to prevent too high a voltage on grid No.2. When grid-No.2 and control-grid voltage are obtained in this manner, the remote "cutoff" advantage of the 6BA6 can be fully realized. However, it should be noted that the use of a resistor in the grid-No.2 circuit will have an effect on the change in plate resistance with variation in grid-No.3 (suppressor) voltage in case grid No.3 is utilized for control purposes.

Grid No. 3 (suppressor) may be connected directly to the cathode or it may be made negative with respect to the cathode. For the latter condition, the grid-No.3 voltage may be obtained from a potentiometer or bleeder circuit, or from the avc system.

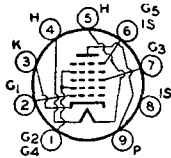
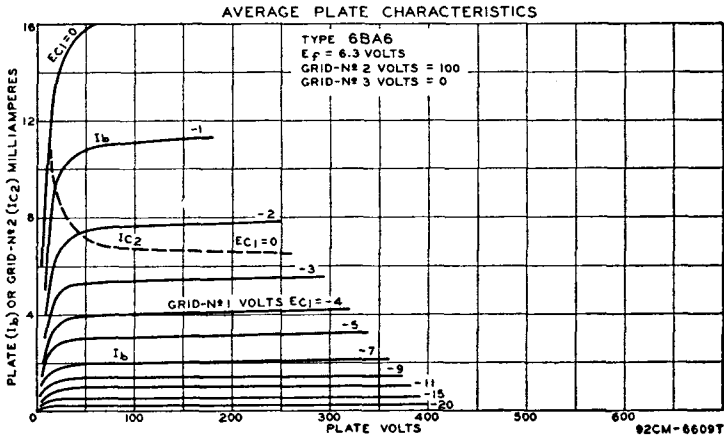

## PENTAGRID CONVERTER

Miniature type used as converter in superheterodyne circuits especially those for the FM broadcast band. Outline 16, OUTLINES SECTION. Tube requires noval nine-contact socket and

# 6BA7

may be mounted in any position. Its characteristics are similar to those of metal type 6SB7-Y. For heater and cathode considerations, refer to type 6AV6.

HEATER VOLTAGE (AC/DC) .....	6.3	volts
HEATER CURRENT .....	0.3	ampere

**DIRECT INTERELECTRODE CAPACITANCES (Without shield):**

Grid No.3 to All Other Electrodes (RF Input) .....	9.5	$\mu\mu\text{f}$
Plate to All Other Electrodes (Mixer Output) .....	8.3	$\mu\mu\text{f}$
Grid No.1 to All Other Electrodes (Oscillator Input) .....	6.7	$\mu\mu\text{f}$
Grid No.3 to Plate .....	0.19 <i>max</i>	$\mu\mu\text{f}$
Grid No.1 to Grid No.3 .....	0.1 <i>max</i>	$\mu\mu\text{f}$
Grid No.1 to Plate .....	0.05 <i>max</i>	$\mu\mu\text{f}$
Grid No.1 to All Other Electrodes Except Cathode .....	3.4	$\mu\mu\text{f}$
Grid No.1 to Cathode .....	3.3	$\mu\mu\text{f}$
Cathode to All Other Electrodes Except Grid No.1 .....	4.0	$\mu\mu\text{f}$

**Maximum Ratings:**

### CONVERTER SERVICE

PLATE VOLTAGE .....	300 <i>max</i>	volts
GRID-NO.5-AND-INTERNAL-SHIELD VOLTAGE▲ .....	0 <i>max</i>	volts
GRIDS-NO.2-AND-NO.4 VOLTAGE .....	100 <i>max</i>	volts
GRIDS-NO.2-AND-NO.4 SUPPLY VOLTAGE .....	300 <i>max</i>	volts
PLATE DISSIPATION .....	2.0 <i>max</i>	watts
GRIDS-NO.2-AND-NO.4 INPUT .....	1.5 <i>max</i>	watts
TOTAL CATHODE CURRENT .....	22 <i>max</i>	ma
<b>GRID-NO.3 VOLTAGE:</b>		
Negative bias value .....	100 <i>max</i>	volts
Positive bias value .....	0 <i>max</i>	volts
<b>PEAK HEATER-CATHODE VOLTAGE:</b>		
Heater negative with respect to cathode .....	90 <i>max</i>	volts
Heater positive with respect to cathode .....	90 <i>max</i>	volts

### Characteristics (Separate Excitation):\*

Plate Voltage .....	100	250	volts
Grid No.5 and Internal Shield▲ .....	Connected directly to ground		
Grids-No.2-and-No.4 (Screen) Voltage .....	100	100	volts
Grid-No.3 (Control-Grid) Voltage .....	-1.0	-1.0	volt
Grid-No.1 (Oscillator-Grid) Resistor .....	20000	20000	ohms
Plate Resistance (Approx.) .....	0.5	1.0	megohm
Conversion Transconductance .....	900	950	μmhos
Conversion Transconductance (Approx.)** .....	3.5	3.5	μmhos
Plate Current .....	3.6	3.8	ma
Grids-No.2-and-No.4 Current .....	10.2	10	ma
Grid-No.1 Current .....	0.35	0.35	ma
Total Cathode Current .....	14.2	14.2	ma

NOTE: The transconductance between grid No.1 and grids No.2 and No.4 connected to plate (not oscillating) is approximately 8000 μmhos under the following conditions: signal applied to grid No.1 at zero bias; grids No.2 and No.4 and plate at 100 volts; grid No.3 grounded. Under the same conditions, the plate current is 32 milliamperes, and the amplification factor is 16.5.

\*The characteristics shown with separate excitation correspond very closely with those obtained in a self-excited oscillator circuit operating with zero bias.

\*\*With grid-No.3 bias of -20 volts.

▲Internal Shield (pins No.6 and No.8) connected directly to ground.

NOTE ON CURVES: In the 6BA7 operation characteristics with self-excitation,  $E_k$  is the voltage across the oscillator-coil section between cathode and ground;  $E_g$  is the oscillator voltage between cathode and grid.

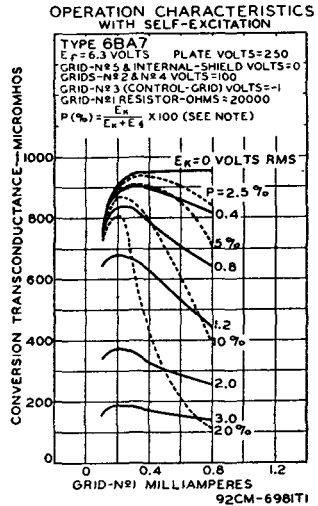
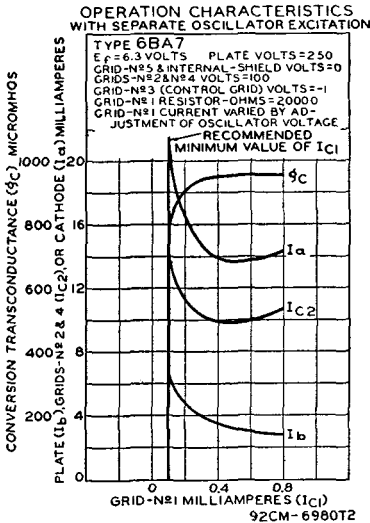

## 6BC5

### SHARP-CUTOFF PENTODE

Miniature type used in compact radio equipment as an rf or if amplifier at frequencies up to 400 megacycles per second. Outline 12, OUTLINES SECTION. Tube requires miniature

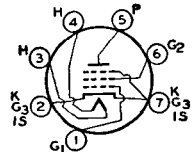

seven-contact socket and may be mounted in any position. Except for a slightly higher transconductance, this type is similar electrically to type 6AG5. Heater volts (ac/dc), 6.3; amperes, 0.3. For heater and cathode considerations, refer to type 6AV6.

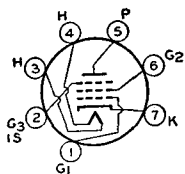

**REMOTE-CUTOFF PENTODE**

Miniature type used as rf or if amplifier in radio receivers. This type is similar in performance to metal type 6SK7. Outline 12, OUTLINES SECTION. Tube requires miniature seven-

**6BD6**

contact socket and may be mounted in any position. For heater considerations, refer to type 6AV6.

HEATER VOLTAGE (AC/DC).....	6.3	volts
HEATER CURRENT.....	0.3	ampere
DIRECT INTERELECTRODE CAPACITANCES (No external shield):		
Grid No.1 to Plate.....	0.005 <i>max</i>	$\mu\text{f}$
Input.....	4.3	$\mu\text{f}$
Output.....	5.0	$\mu\text{f}$

**CLASS A<sub>1</sub> AMPLIFIER**

**Maximum Ratings:**

PLATE VOLTAGE.....	300 <i>max</i>	volts
GRID-NO.2 (SCREEN) VOLTAGE.....	125 <i>max</i>	volts
PLATE DISSIPATION.....	3.0 <i>max</i>	watts
GRID-NO.2 INPUT.....	0.65 <i>max</i>	watt
TOTAL CATHODE CURRENT.....	14 <i>max</i>	ma
PEAK HEATER-CATHODE VOLTAGE:		
Heater negative with respect to cathode.....	90 <i>max</i>	volts
Heater positive with respect to cathode.....	90 <i>max</i>	volts

**Typical Operation:**

Plate Voltage.....	100	125	250	volts
Grid-No.2 Voltage.....	100	125	100	volts
Grid-No.1 (Control-Grid) Voltage.....	-1	-3	-3	volts
Plate Resistance (Approx.).....	0.15	0.18	0.8	megohm
Transconductance.....	2550	2350	2000	$\mu\text{mhos}$
Grid-No.1 Bias (Approx.) for				
transconductance of 10 $\mu\text{mhos}$ .....	-35	-45	-35	volts
Plate Current.....	13	13	9	ma
Grid-No.2 Current.....	5	5	3	ma

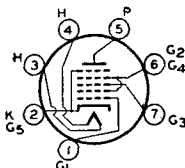

**PENTAGRID CONVERTER**

Miniature type used as converter in superheterodyne circuits in both the standard broadcast and FM bands. The 6BE6 is similar in performance to metal type 6SA7. For general discussion of pentagrid types, see Frequency Conversion in ELECTRON TUBE APPLICATION SECTION.

**6BE6**

of pentagrid types, see Frequency Conversion in ELECTRON TUBE APPLICATION SECTION.

HEATER VOLTAGE (AC/DC).....	6.3	volts
HEATER CURRENT.....	0.3	ampere
DIRECT INTERELECTRODE CAPACITANCES (No external shield):		
Grid No.3 to All Other Electrodes (RF Input).....	7.0	$\mu\text{f}$
Plate to All Other Electrodes (Mixer Output).....	8.0	$\mu\text{f}$
Grid No.1 to All Other Electrodes (Osc. Input).....	5.5	$\mu\text{f}$
Grid No.3 to Plate.....	0.30 <i>max</i>	$\mu\text{f}$
Grid No.1 to Grid No.3.....	0.15 <i>max</i>	$\mu\text{f}$
Grid No.1 to Plate.....	0.1 <i>max</i>	$\mu\text{f}$
Grid No.1 to All Other Electrodes Except Cathode.....	2.7	$\mu\text{f}$
Grid No.1 to Cathode.....	2.8	$\mu\text{f}$
Cathode to All Other Electrodes Except Grid No.1.....	15	$\mu\text{f}$

**Maximum Ratings:**
**CONVERTER SERVICE**

PLATE VOLTAGE.....	300 max	volts
GRIDS-NO.2-AND-NO.4 VOLTAGE.....	100 max	volts
GRIDS-NO.2-AND-NO.4 SUPPLY VOLTAGE.....	300 max	volts
PLATE DISSIPATION.....	1.0 max	watt
GRIDS-NO.2-AND-NO.4 INPUT.....	1.0 max	watt
TOTAL CATHODE CURRENT.....	14 max	ma
<b>GRID-NO.3 VOLTAGE:</b>		
Negative bias value.....	50 max	volts
Positive bias value.....	0 max	volts
<b>PEAK HEATER-CATHODE VOLTAGE:</b>		
Heater negative with respect to cathode.....	90 max	volts
Heater positive with respect to cathode.....	90 max	volts

**Typical Operation (Separate Excitation):\***

Plate Voltage.....	100	250	volts
Grids-No.2-and-No.4 (Screen) Voltage.....	100	100	volts
Grid-No.3 (Control-Grid) Voltage.....	-1.5	-1.5	volts
Grid-No.1 (Oscillator-Grid) Resistor.....	20000	20000	ohms
Plate Resistance (Approx.).....	0.4	1.0	megohm
Conversion Transconductance.....	455	475	μmhos
Grid-No. 3 Voltage for conversion transconductance of 10 μmhos	-30	-30	volts
Plate Current.....	2.6	2.9	ma
Grids-No.2-and-No.4 Current.....	7.0	6.8	ma
Grid-No.1 Current.....	0.5	0.5	ma
Total Cathode Current.....	10.1	10.2	ma

Note: The transconductance between grid No.1 and grids No.2 and No.4 connected to plate (not oscillating) is approximately 7250 μmhos under the following conditions: grids No.1 and No.3 at 0 volts; grids No.2 and No.4 and plate at 100 volts. Under the same conditions, the plate current is 25 ma., and the amplification factor is 20.

\* The characteristics shown with separate excitation correspond very closely with those obtained in a self-excited oscillator circuit operating with zero bias.

## INSTALLATION AND APPLICATION

Type 6BE6 requires miniature seven-contact socket and may be mounted in any position. Outline 12, OUTLINES SECTION. For heater and cathode considerations, refer to type 6AV6.

Because of the special structural arrangement of the 6BE6, a change in signal-grid voltage produces little change in cathode current. Consequently, an rf voltage

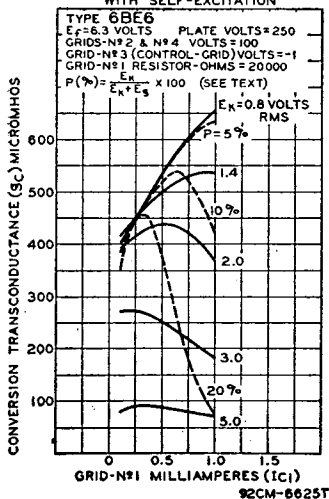
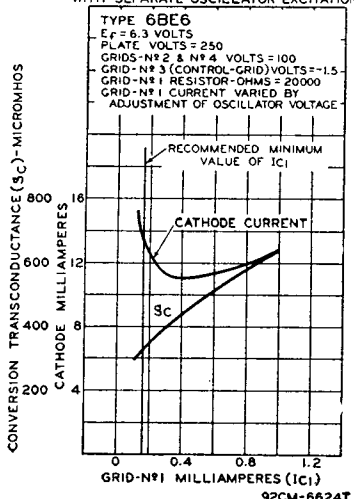
**OPERATION CHARACTERISTICS WITH SELF-EXCITATION**

**OPERATION CHARACTERISTICS WITH SEPARATE OSCILLATOR EXCITATION**

on the signal grid produces little modulation of the electron current flowing in the cathode circuit. This feature is important because it is desirable that the impedance in the cathode circuit should produce little degeneration or regeneration of the signal-frequency input and intermediate-frequency output. Another important feature is that, because signal-grid voltage has very little effect on the space charge near the cathode, changes in avc bias produce little change in oscillator transconductance and in the input capacitance of grid No.1. There is, therefore, little detuning of the oscillator by avc bias.

A typical self-excited oscillator circuit employing the 6BE6 is given in the **CIRCUIT SECTION**.

In the 6BE6 operation characteristics curves with self-excitation,  $E_k$  is the voltage across the oscillator-coil section between cathode and ground;  $E_g$  is the oscillator voltage between cathode and grid.

## TWIN DIODE— MEDIUM-MU TRIODE

# 6BF6

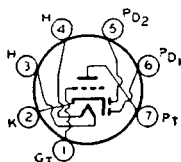

Miniature type used in compact radio equipment as combined detector, amplifier, and avc tube. The triode unit is particularly useful as a driver for impedance- or transformer-coupled

output stages in automobile receivers. It is equivalent in performance to metal type 6SR7. Outline 12, **OUTLINES SECTION**. Tube requires miniature seven-contact socket and may be mounted in any position. For typical operation as a resistance-coupled amplifier, refer to Chart 9, **RESISTANCE-COUPLED AMPLIFIER SECTION**. For heater and cathode considerations, refer to type 6AV6.

HEATER VOLTAGE (AC/DC) .....	6.3	volts
HEATER CURRENT .....	0.3	ampere
<b>DIRECT INTERELECTRODE CAPACITANCES (Triode Unit):</b>		
Grid to Plate .....	2.0	$\mu\mu\text{f}$
Grid to Cathode .....	1.8	$\mu\mu\text{f}$
Plate to Cathode .....	1.4	$\mu\mu\text{f}$

\* With external shield connected to cathode.

### TRIODE UNIT AS CLASS A<sub>1</sub> AMPLIFIER

<b>Maximum Ratings:</b>		
PLATE VOLTAGE .....	300 <i>max</i>	volts
PLATE DISSIPATION .....	2.5 <i>max</i>	watts
<b>PEAK HEATER-CATHODE VOLTAGE:</b>		
Heater negative with respect to cathode .....	90 <i>max</i>	volts
Heater positive with respect to cathode .....	90 <i>max</i>	volts

### Typical Operation (With Transformer Coupling):

Plate Voltage .....	250	volts
Grid Voltage .....	-9	volts
Amplification Factor .....	16	
Plate Resistance .....	8500	ohms
Transconductance .....	1900	$\mu\text{mhos}$
Plate Current .....	9.5	ma
Load Resistance .....	10000	ohms
Total Harmonic Distortion .....	6.5	per cent
Power Output .....	300	mw

### DIODE UNITS

The two diode plates and the triode unit have a common cathode. Diode biasing of the triode unit of the 6BF6 is not suitable. For diode operation curves, refer to type 6SQ7.

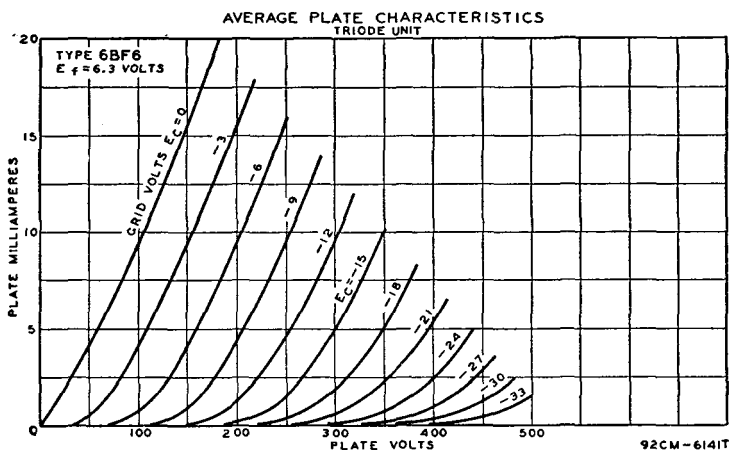

## 6BG6-G

### BEAM POWER AMPLIFIER

Glass octal type used as output amplifier in horizontal-deflection circuits of television equipment and other applications where high pulse voltages occur during short duty cycles. Out-

line 42, OUTLINES SECTION. Tube requires octal socket. Vertical tube mounting is preferred but horizontal operation is permissible if pins No.2 and 7 are in vertical plane.

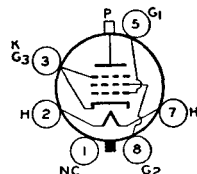

HEATER VOLTAGE (AC/DC).....	6.3	volts
HEATER CURRENT.....	0.9	ampere
DIRECT INTERELECTRODE CAPACITANCES (No external shield):		
Grid No.1 to Plate.....	0.65	max $\mu\text{f}$
Input.....	11	$\mu\text{f}$
Output.....	6.5	$\mu\text{f}$
TRANSCONDUCTANCE <sup>o</sup> .....	6000	$\mu\text{mhos}$
MU-FACTOR, Grid No.2 to Grid No.1 <sup>oo</sup> .....	8	

<sup>o</sup> For plate volts, 250; grid-No.2 volts, 250; grid-No.1 volts, -15.

<sup>oo</sup> For plate volts, 250; grid-No.2 volts, 250; grid-No.1 volts, -20.

### HORIZONTAL DEFLECTION AMPLIFIER

*For operation in a 525-line, 30-frame system*

#### Maximum Ratings:

DC PLATE VOLTAGE.....	700	max	volts
PEAK POSITIVE PULSE PLATE VOLTAGE*.....	6000	max	volts
PEAK NEGATIVE PULSE PLATE VOLTAGE*.....	-1500	max	volts
DC GRID-NO.2 (SCREEN) VOLTAGE†.....	350	max	volts
DC GRID-NO.1 (CONTROL-GRID) VOLTAGE.....	-50	max	volts
PEAK NEGATIVE PULSE GRID-NO.1 VOLTAGE*.....	-400	max	volts
DC PLATE CURRENT.....	100	max	ma
PLATE DISSIPATION.....	20	max	watts
GRID-NO.2 INPUT.....	3.2	max	watts
PEAK HEATER-CATHODE VOLTAGE:			
Heater negative with respect to cathode.....	135	max	volts
Heater positive with respect to cathode.....	135	max	volts

#### Maximum Circuit Value:

GRID-NO.1 CIRCUIT RESISTANCE.....	1.0	max	megohm
-----------------------------------	-----	-----	--------

\* The duration of the voltage pulse must not exceed 15% of one horizontal scanning cycle. In a 525-line, 30-frame system, 15% of one horizontal scanning cycle is 10 microseconds.

† Preferably obtained through a series dropping resistor of sufficient magnitude to limit the grid-No.2 input to the rated maximum value.



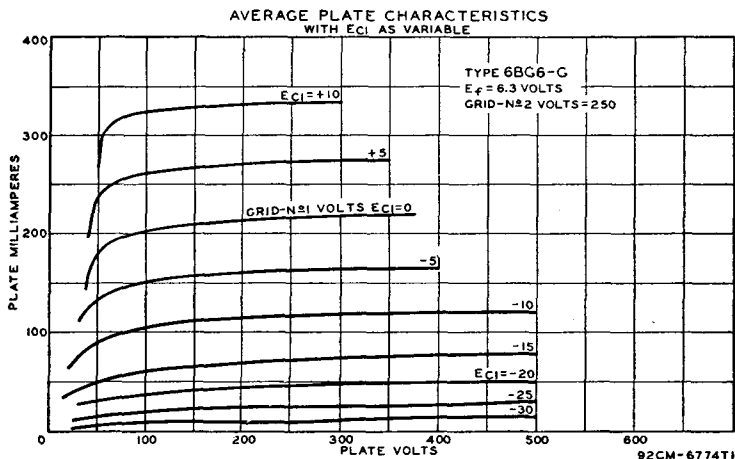

## SHARP-CUTOFF PENTODE

Miniature type used as rf amplifier particularly in ac/dc receivers and in mobile equipment where low heater-current drain is important. It is particularly useful in high-frequency, wide-band applications. Outline 12, OUTLINES SECTION. Tube requires miniature seven-contact socket and may be mounted in any position. For heater and cathode considerations, refer to type 6AV6.

# 6BH6

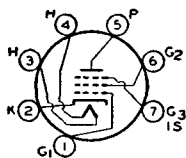

requires miniature seven-contact socket and may be mounted in any position. For heater and cathode considerations, refer to type 6AV6.

HEATER VOLTAGE (AC/DC).....	6.3	volts
HEATER CURRENT.....	0.15	ampere
DIRECT INTERELECTRODE CAPACITANCES (No external shield):		
Grid No.1 to Plate.....	0.0035	max $\mu$ f
Input.....	5.4	$\mu$ f
Output.....	4.4	$\mu$ f

### Maximum Ratings:

### CLASS A<sub>1</sub> AMPLIFIER

PLATE VOLTAGE.....	300	max volts
GRID-NO.2 (SCREEN) VOLTAGE.....	150	max volts
GRID-NO.2 SUPPLY VOLTAGE.....	300	max volts
PLATE DISSIPATION.....	3	max watts
GRID-NO.2 INPUT.....	0.5	max watt
GRID-NO.1 (CONTROL-GRID) VOLTAGE:		
Negative bias value.....	50	max volts
Positive bias value.....	0	max volts
PEAK HEATER-CATHODE VOLTAGE:		
Heater negative with respect to cathode.....	90	max volts
Heater positive with respect to cathode.....	90	max volts

### Typical Operation and Characteristics:

Plate Voltage.....	100	250	volts
Grid-No.3 (Suppressor).....	Connected to cathode at socket		
Grid-No.2 Voltage.....	100	150	volts
Grid-No.1 Voltage.....	-1	-1	volt
Plate Resistance (Approx.).....	0.7	1.4	megohms
Transconductance.....	3400	4600	$\mu$ hos
Grid-No.1 Bias for plate current of 10 $\mu$ a.....	-5	-7.7	volts
Plate Current.....	3.6	7.4	ma
Grid-No.2 Current.....	1.4	2.9	ma

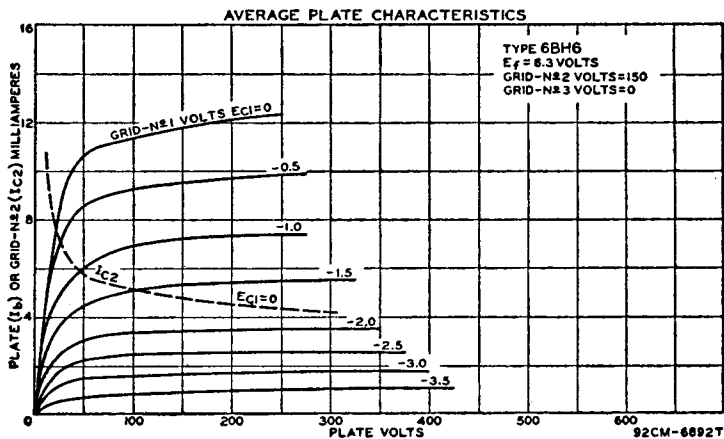

## 6BJ6

### REMOTE-CUTOFF PENTODE

Miniature type used as rf amplifier in high-frequency and wide-band applications. Features high transconductance and low grid-to-plate capacitance. Outline 12, OUTLINES SEC-

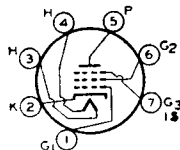

TION. Tube requires miniature seven-contact socket and may be mounted in any position. For heater and cathode considerations, refer to type 6AV6.

HEATER VOLTAGE (AC/DC) .....	6.3	volts
HEATER CURRENT .....	0.15	ampere
DIRECT INTERELECTRODE CAPACITANCES (No external shield):		
Grid No.1 to Plate .....	0.0035 max	$\mu\text{f}$
Input .....	4.5	$\mu\text{f}$
Output .....	5.5	$\mu\text{f}$

#### Maximum Ratings:

#### CLASS A<sub>1</sub> AMPLIFIER

PLATE VOLTAGE .....	300 max	volts
GRID-NO.2 (SCREEN) VOLTAGE .....	125 max	volts
GRID-NO.2 SUPPLY VOLTAGE .....	300 max	volts
PLATE DISSIPATION .....	3 max	watts
GRID-NO.2 INPUT .....	0.6 max	watt
GRID-NO.1 (CONTROL-GRID) VOLTAGE:		
Negative bias value .....	50 max	volts
Positive bias value .....	0 max	volts
PEAK HEATER-CATHODE VOLTAGE:		
Heater negative with respect to cathode .....	90 max	volts
Heater positive with respect to cathode .....	90 max	volts

#### Typical Operation:

Plate Voltage .....	100	250	volts
Grid No.3 (Suppressor) .....	Connected to cathode at socket		
Grid-No.2 Voltage .....	100	100	volts
Grid-No.1 Voltage .....	-1.0	-1.0	volt
Plate Resistance (Approx.) .....	0.25	1.3	megohms
Transconductance .....	3650	3600	$\mu\text{mhos}$
Grid-No.1 Bias (Approx.) for transconductance of 15 $\mu\text{mhos}$ ...	-20	-20	volts
Plate Current .....	9.0	9.2	ma
Grid-No.2 Current .....	3.5	3.3	ma

**AVERAGE PLATE CHARACTERISTICS  
PENTODE CONNECTION**

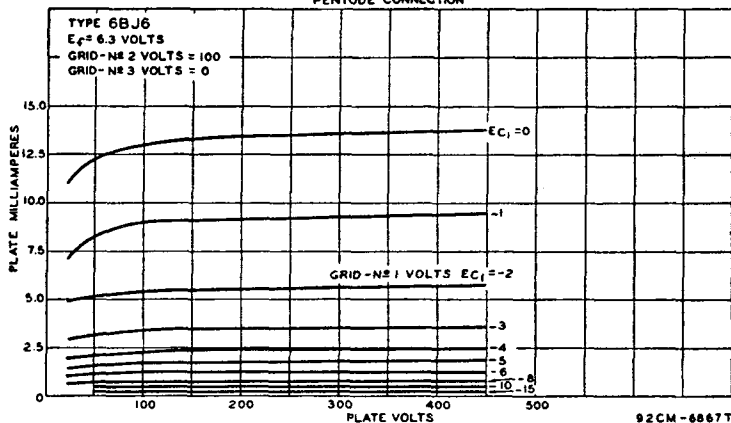

92CM-68677

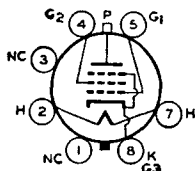

## BEAM POWER AMPLIFIER

Glass octal type used as horizontal deflection amplifier in television receivers employing either transformer coupling or direct coupling to the deflecting yoke. Outline 28, **OUTLINES**

# 6BQ6-GT

**SECTION.** Tube requires octal socket and may be mounted in any position.

HEATER VOLTAGE (AC/DC) .....	6.3	volts
HEATER CURRENT .....	1.2	amperes
DIRECT INTERELECTRODE CAPACITANCES (No external shield):		
Grid No.1 to Plate .....	0.95	$\mu\mu\text{f}$
Input .....	14	$\mu\mu\text{f}$
Output .....	9.5	$\mu\mu\text{f}$
TRANSCONDUCTANCE* .....	5500	$\mu\text{mhos}$
MU-FACTOR, Grid No.2 to Grid No.1* .....	4.5	

\* For plate volts, 250; grid-No.2, volts, 150; grid-No.1 volts, -22.5; plate ma, 55, grid-No.2 ma, 2.1.

## HORIZONTAL DEFLECTION AMPLIFIER

*For operation in a 525-line, 30-frame system*

**Maximum Ratings:**

DC PLATE VOLTAGE .....	550 max	volts
PEAK POSITIVE-PULSE PLATE VOLTAGE# .....	5000 max	volts
DC GRID-NO.2 (SCREEN) VOLTAGE .....	200 max	volts
DC GRID-NO.1 (CONTROL-GRID) VOLTAGE .....	-50 max	volts
PEAK NEGATIVE-PULSE GRID-NO.1 VOLTAGE# .....	-135 max	volts
DC PLATE CURRENT .....	100 max	ma
PLATE DISSIPATION† .....	10 max	watts
GRID-NO.2 INPUT .....	2.5 max	watts
PEAK HEATER-CATHODE VOLTAGE:		
Heater negative with respect to cathode .....	180 max	volts
Heater positive with respect to cathode .....	180 max	volts

**Maximum Circuit Values:**

GRID-NO.1 CIRCUIT RESISTANCE .....	0.5 max	megohm
------------------------------------	---------	--------

#The duration of the voltage pulse must not exceed 15% of one horizontal scanning cycle. In a 525-line, 30-frame system, 15% of one horizontal scanning cycle is 10 microseconds.

†In the event of loss of excitation, a plate dissipation up to 30 watts for a duration not exceeding three minutes will not result in permanent damage to the tube. A cathode resistor of suitable value should be used to limit the no-signal plate dissipation to 30 watts.

## MEDIUM-MU TWIN TRIODE

For technical data, see page 305.

# 6BQ7

HF TRIODE

6C4

Miniature type used in compact radio equipment as a local oscillator in FM and other high-frequency circuits. It may also be used as a class C rf amplifier. In such service, it delivers

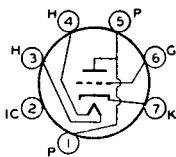

a power output of 5.5 watts at moderate frequencies, and 2.5 watts at 150 megacycles per second. Outline 12, OUTLINES SECTION. Tube requires miniature seven-contact socket and may be mounted in any position. For typical operation as a resistance-coupled amplifier, refer to Chart 10, RESISTANCE-COUPLED AMPLIFIER SECTION. For curve of average plate characteristics, see next page. For heater and cathode considerations, refer to type 6AV6.

HEATER VOLTAGE (AC/DC).....	6.3	volts
HEATER CURRENT.....	0.15	ampere
DIRECT INTERELECTRODE CAPACITANCES (No external shield):		
Grid to Plate.....	1.6	$\mu\mu\text{f}$
Input.....	1.8	$\mu\mu\text{f}$
Output.....	1.3	$\mu\mu\text{f}$

Maximum Ratings: CLASS A<sub>1</sub> AMPLIFIER

PLATE VOLTAGE.....	300 <i>max</i>	volts
PLATE DISSIPATION.....	3.5 <i>max</i>	watts
PEAK HEATER-CATHODE VOLTAGE:		
Heater negative with respect to cathode.....	90 <i>max</i>	volts
Heater positive with respect to cathode.....	90 <i>max</i>	volts

Characteristics:

Plate Voltage.....	100	250	volts
Grid Voltage*.....	0	-8.5	volts
Amplification Factor.....	19.5	17	
Plate Resistance.....	6250	7700	ohms
Transconductance.....	3100	2200	$\mu\text{mhos}$
Plate Current.....	11.8	10.5	ma

\*The type of input coupling used should not introduce too much resistance in the grid circuit. Transformer- or impedance-coupling devices are recommended. Under maximum rated conditions, the resistance in the grid circuit should not exceed 0.25 megohm with fixed bias, or 1.0 megohm with cathode bias.

RF POWER AMPLIFIER AND OSCILLATOR—Class C Telegraphy

Maximum Ratings:		
DC PLATE VOLTAGE.....	300 <i>max</i>	volts
DC GRID VOLTAGE.....	-50 <i>max</i>	volts
DC PLATE CURRENT.....	25 <i>max</i>	ma
DC GRID CURRENT.....	8 <i>max</i>	ma
PLATE DISSIPATION.....	5 <i>max</i>	watts

Typical Operation (At Moderate Frequencies):

DC Plate Voltage.....	300	volts
DC Grid Voltage.....	-27	volts
DC Plate Current.....	25	ma
DC Grid Current (Approx.).....	7	ma
Driving Power (Approx.).....	0.35	watt
Power Output (Approx.).....	5.5	watts

MEDIUM-MU TRIODE

6C5  
6C5-GT

Metal type 6C5 and glass-octal type 6C5-GT used as audio amplifier and oscillator. They are also used as detectors of grid-resistor-and-capacitor type or grid-bias type. Outlines 3 and 24, respectively, OUTLINES SECTION. Tubes require octal socket and may be mounted in any position. Heater volts (ac/dc), 6.3; amperes, 0.3. Maximum ratings as class A<sub>1</sub> amplifier:

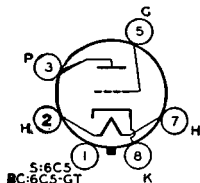
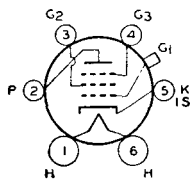

plate volts, 300 *max*; plate dissipation, 2.5 *max* watts; grid volts, 0 *max*. Typical operation: plate volts,

250; grid volts, -8 (grid-circuit resistance should not exceed 1.0 megohm); amplification factor, 20; plate resistance, 10000 ohms; transconductance, 2000  $\mu$ mhos; plate ma., 8. For typical operation as a resistance-coupled amplifier, refer to Chart 11, RESISTANCE-COUPLED AMPLIFIER SECTION.



### SHARP-CUTOFF PENTODE

Glass type used as biased detector and as a high-gain amplifier in radio equipment. Outline 38, OUTLINES SECTION. Tube requires six-contact socket. Heater volts (ac/dc), 6.3; amperes, 0.3. For ratings and typical operation data, refer to type 6J7. This type is used principally for renewal purposes.

## 6C6

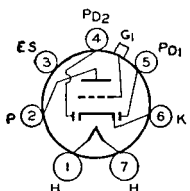

### TWIN DIODE— MEDIUM-MU TRIODE

Glass type used as combined detector, amplifier, and avc tube. Outline 34, OUTLINES SECTION. Heater volts (ac/dc), 6.3; amperes, 0.3. This type is similar to, but not interchangeable with, type 85. The 6C7 is a DISCONTINUED type listed for reference only.

## 6C7

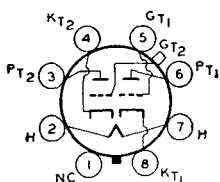

### MEDIUM-MU TWIN TRIODE

Glass octal type used as a voltage amplifier and phase inverter in radio equipment. Outline 33, OUTLINES SECTION. When this type is used in a high-gain amplifier, hum may be reduced or eliminated by grounding pin No. 7 or by grounding the arm of a 100-to-500-ohm potentiometer across the heater terminals. Tube requires octal socket. Heater volts (ac/dc), 6.3;

## 6C8-G

amperes, 0.3. Maximum ratings for each triode unit as class A<sub>1</sub> amplifier: plate volts, 250 max; grid volts, 0 min; plate dissipation, 1.0 max watt. Typical operation: plate volts, 250; grid volts, -4.5; plate ma., 3.2; plate resistance, 22500 ohms; amplification factor, 36; transconductance, 1600  $\mu$ mhos. For typical operation as a resistance-coupled amplifier, refer to Chart 12, RESISTANCE-COUPLED AMPLIFIER SECTION. This type is used principally for renewal purposes.

AVERAGE PLATE CHARACTERISTICS

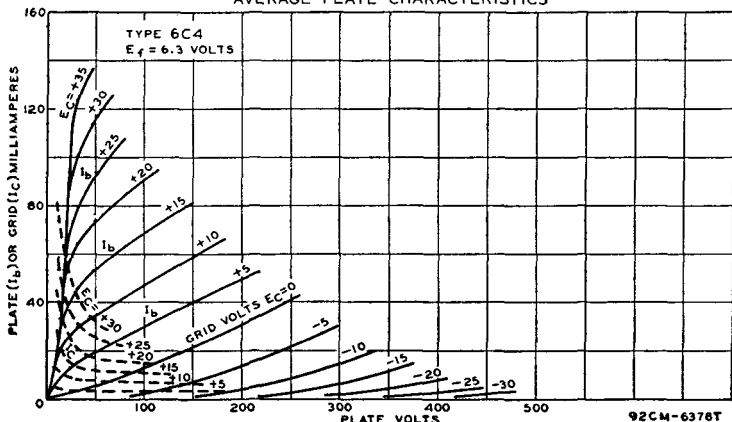

# 6CB6

## SHARP-CUTOFF PENTODE

Miniature type used in television receivers as an intermediate-frequency amplifier at frequencies up to about 45 megacycles per second and as an rf amplifier in vhf television tuners. Tube

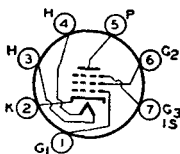

features very high transconductance combined with low interelectrode capacitance values, and is provided with separate base pins for grid No.3 and the cathode to permit the use of an unbypassed cathode resistor to minimize the effects of regeneration. Outline 12, OUTLINES SECTION. Tube requires miniature seven-contact socket and may be mounted in any position. For heater and cathode considerations, refer to type 6AV6.

HEATER VOLTS (AC/DC).....	6.3	volts
HEATER CURRENT.....	0.3	ampere
DIRECT INTERELECTRODE CAPACITANCES (No external shield):		
Grid No.1 to Plate.....	0.020 max	$\mu\mu\text{f}$
Input.....	6.3	$\mu\mu\text{f}$
Output.....	1.9	$\mu\mu\text{f}$

### Maximum Ratings:

### CLASS A<sub>1</sub> AMPLIFIER

PLATE VOLTAGE.....	300 max	volts
GRID-NO.2 (SCREEN) VOLTAGE.....	150 max	volts
PLATE DISSIPATION.....	2.0 max	watts
GRID-NO.2 INPUT.....	0.5 max	watt
PEAK HEATER-CATHODE VOLTAGE:		
Heater negative with respect to cathode.....	90 max	volts
Heater positive with respect to cathode.....	90 max	volts

### Typical Operation and Characteristics:

Plate Voltage.....	200	volts
Grid-No.3 (Suppressor).....	Connected to cathode at socket	
Grid-No.2 Voltage.....	150	volts
Cathode-Bias Resistor.....	180	ohms
Plate Resistance (Approx.).....	0.6	megohm
Transconductance.....	6200	$\mu\text{mhos}$
Grid-No.1 Bias (Approx.) for plate current of 10 $\mu\text{a}$ .....	-8	volts
Plate Current.....	9.5	ma
Grid-No.2 Current.....	2.8	ma

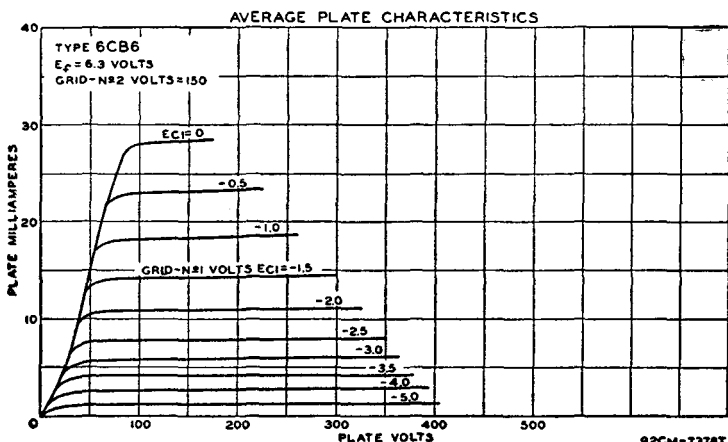

92CM-7378T

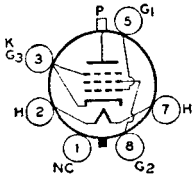

**BEAM POWER AMPLIFIER**

**6CD6-G**

Glass octal type used as horizontal deflection amplifier in high-efficiency deflection circuits of television receivers employing either transformer coupling or direct coupling to the deflection yoke. Outline 42, OUTLINES SECTION. Tube requires octal socket. Vertical tube mounting is preferred but horizontal operation is permissible if pins No.2 and 7 are in vertical plane.

HEATER VOLTAGE (AC/DC).....	6.3	volts
HEATER CURRENT.....	2.5	amperes
DIRECT INTERELECTRODE CAPACITANCES (No external shield):		
Grid No.1 to Plate.....	1.0 <i>max</i>	$\mu$ f
Input.....	26	$\mu$ f
Output.....	10	$\mu$ f
TRANSCONDUCTANCE <sup>o</sup> .....	7500	$\mu$ mhos
MU-FACTOR, Grid No.2 to Grid No.1 <sup>o</sup> .....	3.8	

<sup>o</sup> For plate volts, 175; grid-No.2 volts, 175; grid-No.1 volts, -30.

**HORIZONTAL DEFLECTION AMPLIFIER**

*For operation in a 525-line, 30-frame system*

**Maximum Ratings:**

DC PLATE VOLTAGE.....	700 <i>max</i>	volts
PEAK POSITIVE-PULSE PLATE VOLTAGE*.....	6000 <i>max</i>	volts
PEAK NEGATIVE-PULSE PLATE VOLTAGE*.....	-1500 <i>max</i>	volts
DC GRID-NO.2 (SCREEN) VOLTAGE.....	175 <i>max</i>	volts
DC GRID-NO.1 (CONTROL-GRID) VOLTAGE.....	-50 <i>max</i>	volts
PEAK NEGATIVE-PULSE GRID-NO.1 VOLTAGE*.....	-150 <i>max</i>	volts
DC PLATE CURRENT.....	170 <i>max</i>	ma
PLATE DISSIPATION.....	15 <i>max</i>	watts
GRID-NO.2 INPUT.....	3 <i>max</i>	watts
PEAK HEATER-CATHODE VOLTAGE:		
Heater negative with respect to cathode.....	135 <i>max</i>	volts
Heater positive with respect to cathode.....	135 <i>max</i>	volts
BULB TEMPERATURE (At hottest point).....	210 <i>max</i>	$^{\circ}$ C

\* The duration of the voltage pulse must not exceed 15% of one horizontal scanning cycle. In a 525-line, 30-frame system, 15% of one horizontal scanning cycle is 10 microseconds.

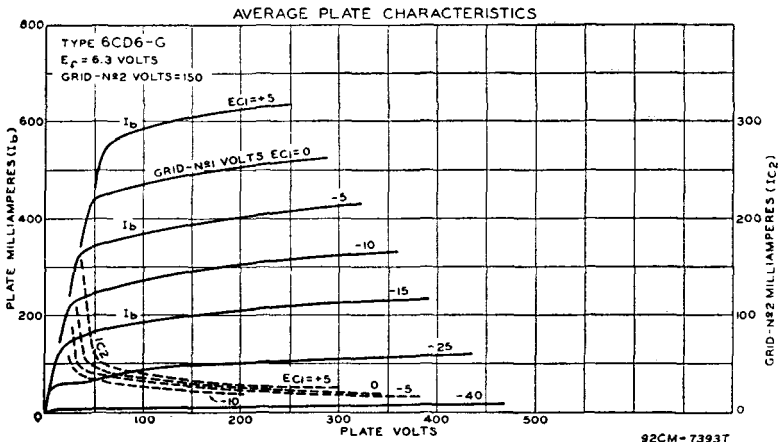

## REMOTE-CUTOFF PENTODE

### 6D6

Glass type used in rf and if stages of radio receivers employing avc. Outline 38, OUTLINES SECTION. Tube requires six-contact socket. Except for interelectrode capacitances, this type is identical electrically with type 6U7-G. Refer to type 6SK7 for general application information. Heater volts (ac/dc), 6.3; amperes, 0.3. This type is used principally for renewal purposes.

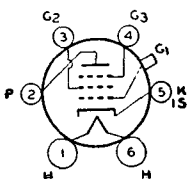

## SHARP-CUTOFF PENTODE

### 6D7

Glass type used as detector or amplifier in radio receivers. Outline 38, OUTLINES SECTION. Heater volts (ac/dc), 6.3; amperes, 0.3. For electrical characteristics, refer to type 6J7. This is a DISCONTINUED type listed for reference only.

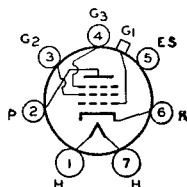

## PENTAGRID CONVERTER

### 6D8-G

Glass octal type used in superheterodyne circuits. Outline 33, OUTLINES SECTION. Tube requires octal socket. Heater volts (ac/dc), 6.3; amperes, 0.15. Except for interelectrode capacitances and heater rating, the 6D8-G is similar electrically to type 6A8-G. The 6D8-G is used principally for renewal purposes.

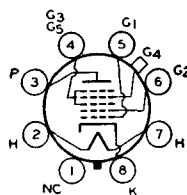

## ELECTRON-RAY TUBE

### 6E5

Glass type used to indicate visually by means of a fluorescent target the effects of a change in a controlling voltage. It is used as a convenient means of indicating accurate radio-receiver tuning. Outline 30, OUTLINES SECTION. Tube requires six-contact socket. Heater volts (ac/dc), 6.3; amperes, 0.3. For additional considerations, refer to **Tuning Indication with Electron-Ray Tubes** in ELECTRON TUBE APPLICATIONS SECTION.

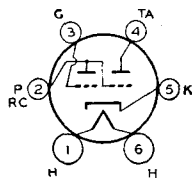

## TUNING INDICATOR

### Maximum Ratings:

PLATE-SUPPLY VOLTAGE.....	250 max	volts
TARGET VOLTAGE.....	{ 250 max	volts
	{ 125 min	volts

### Typical Operation:

Plate and Target Supply.....	200	250	volts
Series Triode-Plate Resistor.....	1	1	megohm
Target Current*†.....	3	4	ma
Triode-Plate Current*.....	0.19	0.24	ma
Triode-Grid Voltage (Approx.):			
For shadow angle of 0°.....	-6.5	-8.0	volts
For shadow angle of 90°.....	0	0	volts

\* For zero triode-grid voltage. † Subject to wide variations.

## TWIN POWER TRIODE

### 6E6

Glass type used as class A<sub>1</sub> amplifier in either push-pull or parallel circuits. Outline 36, OUTLINES SECTION. Heater volts (ac/dc), 6.3; amperes, 0.6. With plate volts of 250 and grid volts of -27.5, characteristics for each unit are: plate ma., 18; plate resistance, 3500 ohms; transconductance, 1700 μmhos; amplification factor, 6. With plate-to-plate load resistance

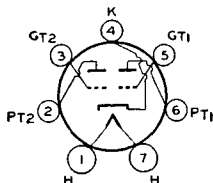

of 14000 ohms, output watts for two tubes is 1.6. This is a DISCONTINUED type listed for reference only.



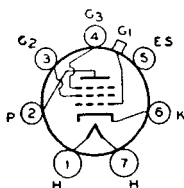

## REMOTE-CUTOFF PENTODE

Glass type used in rf and if stages of radio receivers employing avc. Outline 38, OUTLINES SECTION. Except for interelectrode capacitances, this type is identical electrically with type 6U7-G. Heater volts (ac/dc), 6.3; amperes, 0.3. This is a DISCONTINUED type listed for reference only.

# 6E7

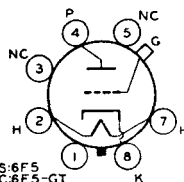

## HIGH-MU TRIODE

Metal type 6F5 and glass-octal type 6F5-GT used in resistance-coupled amplifier circuits. Outlines 4 and 20, respectively, OUTLINES SECTION.

# 6F5 6F5-GT

Tubes require octal socket and may be mounted in any position. For typical operation as a resistance-coupled amplifier, refer to Chart 18, RESISTANCE-COUPLED AMPLIFIER SECTION. For heater and cathode considerations, refer to type 6AV6.

HEATER VOLTAGE (AC/DC).....	6.3	volts
HEATER CURRENT.....	0.3	ampere

Characteristics:	CLASS A <sub>1</sub> AMPLIFIER		
Plate Voltage (300 volts max).....	100	250	volts
Grid Voltage.....	-1	-2	volts
Amplification Factor.....	100	100	
Plate Resistance.....	85000	66000	ohms
Transconductance.....	1150	1500	μmhos
Plate Current.....	0.4	0.9	ma

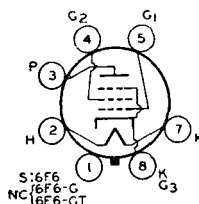

## POWER PENTODE

Metal type 6F6 and glass-octal types 6F6-G and 6F6-GT are used in the audio output stage of ac receivers. They are capable of large power output with relatively small input voltage.

# 6F6 6F6-G 6F6-GT

Outlines 6, 35, and 26, respectively, OUTLINES SECTION. Tubes require octal socket and may be mounted in any position. It is especially important that these tubes, like other power-handling tubes, should be adequately ventilated.

HEATER VOLTAGE (AC/DC).....	6.3	volts
HEATER CURRENT.....	0.7	ampere

Maximum Ratings:	SINGLE-TUBE CLASS A <sub>1</sub> AMPLIFIER		
PLATE VOLTAGE.....	375 max		volts
GRID-NO. 2 (SCREEN) VOLTAGE.....	285 max		volts
PLATE DISSIPATION.....	11 max		watts
GRID-NO. 2 INPUT.....	3.75 max		watts
PEAK HEATER-CATHODE VOLTAGE:			
Heater negative with respect to cathode.....	90 max		volts
Heater positive with respect to cathode.....	90 max		volts

**Typical Operation:**

	<i>Fixed Bias</i>		<i>Cathode Bias</i>		
Plate Voltage.....	250	285	250	285	volts
Grid-No.2 Voltage.....	250	285	250	285	volts
Grid-No.1 (Control-Grid) Voltage .	-16.5	-20	-	-	volts
Cathode Resistor.....	-	-	410	440	ohms
Peak AF Grid-No.1 Voltage.....	16.5	20	16.5	20	volts
Zero-Signal Plate Current.....	34	38	34	38	ma
Maximum-Signal Plate Current...	36	40	35	38	ma
Zero-Signal Grid-No.2 Current....	6.5	7	6.5	7	ma
Maximum-Signal Grid-No.2.....					
Current.....	10.5	13	9.7	12	ma
Plate Resistance (Approx.).....	80000	78000	-	-	ohms
Transconductance.....	2500	2550	-	-	μmhos
Load Resistance.....	7000	7000	7000	7000	ohms
Total Harmonic Distortion.....	8	9	8.5	9	per cent
Maximum-Signal Power Output...	3.2	4.8	3.1	4.5	watts

### PUSH-PULL CLASS A<sub>1</sub> AMPLIFIER

**Maximum Ratings:**

 (Same as for single-tube class A<sub>1</sub> amplifier)

**Typical Operation (Values are for two tubes):**

	<i>Fixed Bias</i>	<i>Cathode Bias</i>	
Plate Voltage.....	315	315	volts
Grid-No.2 Voltage.....	285	285	volts
Grid-No.1 (Control-Grid) Voltage.....	-24	-	volts
Cathode Resistor.....	-	320	ohms
Peak AF Grid-No.1-to-Grid-No.1 Voltage.....	48	58	volts
Zero-Signal Plate Current.....	62	62	ma
Maximum-Signal Plate Current.....	80	73	ma
Zero-Signal Grid-No.2 Current.....	12	12	ma
Maximum-Signal Grid-No.2 Current.....	19.5	18	ma
Effective Load Resistance (Plate-to-plate).....	10000	10000	ohms
Total Harmonic Distortion.....	4	3	per cent
Maximum-Signal Power Output.....	11	10.5	watts

### TRIODE— REMOTE-CUTOFF PENTODE

# 6F7

Glass type adaptable to circuit design in several ways. Except for common cathode, the triode and pentode units are independent of each other. Outline 34, OUTLINES SECTION. Heater volts (ac/dc), 6.3; amperes, 0.3. This type is used principally for renewal purposes.

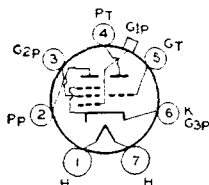

### CLASS A<sub>1</sub> AMPLIFIER

**Maximum Ratings:**

	<i>Triode Unit</i>	<i>Pentode Unit</i>	
PLATE VOLTAGE.....	100 max	250 max	volts
PLATE-SUPPLY VOLTAGE.....	250 max	250 max	volts
GRID-NO.2 (SCREEN) VOLTAGE.....	-	100 max	volts
GRID-NO.1 (CONTROL-GRID) VOLTAGE.....	-3 min	-3 min	volts
PEAK HEATER-CATHODE VOLTAGE:			
Heater negative with respect to cathode.....	90 max	90 max	volts
Heater positive with respect to cathode.....	90 max	90 max	volts

**Typical Operation and Characteristics:**

	<i>Triode Unit</i>		<i>Pentode Unit</i>		
Plate Voltage.....	100	100	250	250	volts
Grid-No.2 Voltage.....	-	100	100	100	volts
Grid-No.1 Voltage.....	-3	-3	-3	-3	volts
Amplification Factor.....	8	-	-	-	
Plate Resistance.....	0.016	0.29	0.85	0.85	megohm
Transconductance.....	500	1050	1100	1100	μmhos
Transconductance at -35-volts bias.....	-	9	10	10	μmhos
Plate Current.....	3.5	6.3	6.5	6.5	ma
Grid-No.2 Current.....	-	1.6	1.5	1.5	ma

## MEDIUM-MU TWIN TRIODE

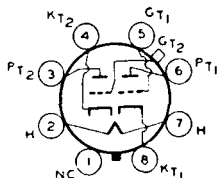

Glass octal type used as voltage amplifier or phase inverter in radio equipment. Except for common heater each triode is independent of the other. Outline 33, OUTLINES SECTION. Tube requires octal socket. Except for the heater rating of 6.3 volts (ac/dc) and 0.6 ampere and interelectrode capacitances, each triode unit is identical electrically with type 6J5. For typical operation as a resistance-coupled amplifier, refer to Chart 13, RESISTANCE-COUPLED AMPLIFIER SECTION.

## 6F8-G

## POWER PENTODE

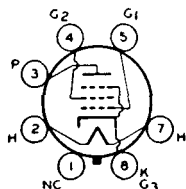

Glass octal type used in output stage of radio receivers where moderate power output is required. This type is economical because of its low plate-power requirements and low heater current. Outline 31, OUTLINES SECTION. Tube requires octal socket. Except for interelectrode capacitances and a plate resistance of 175000 ohms, this type is electrically identical with type 6AK6. Heater volts (ac/dc), 6.3; amperes, 0.15.

## 6G6-G

## TWIN DIODE

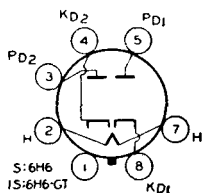

Metal type 6H6 and glass-octal type 6H6-GT are used as detectors, low-voltage rectifiers, and avc tubes. Except for the common heater, the two diode units are independent of

each other. For diode detector considerations, refer to ELECTRON TUBE APPLICATIONS SECTION.

## 6H6 6H6-GT

HEATER VOLTAGE (AC/DC).....	6.3	volts
HEATER CURRENT.....	0.3	ampere
DIRECT INTERELECTRODE CAPACITANCES:†		

	6H6	6H6-GT	
Plate No.1 to Cathode No.1.....	3.0	3.0	μf
Plate No.2 to Cathode No.2.....	3.4	4.0	μf
Plate No.1 to Plate No.2.....	0.1 max	0.1 max	μf

† With shell or external and internal shields connected to cathode.

### Maximum Ratings: RECTIFIER OR DOUBLER

PEAK INVERSE PLATE VOLTAGE.....	420 max	volts
PEAK PLATE CURRENT PER PLATE.....	48 max	ma
DC OUTPUT CURRENT PER PLATE.....	8 max	ma
PEAK HEATER-CATHODE VOLTAGE.....	330 max	volts

### Typical Operation (As Half-Wave Rectifier):\*

AC Plate Voltage per Plate (rms).....	117	150	volts
Min. Total Effective Plate-Supply Impedance per Plate°.....	15	40	ohms
DC Output Current per Plate.....	8	8	ma

### Typical Operation (As Voltage Doubler):

	Half-Wave	Full-Wave	
AC Plate Voltage per Plate (rms).....	117	117	volts
Min. Total Effective Plate-Supply Impedance per Plate°.....	30	15	ohms
DC Output Current.....	8	8	ma

\* In half-wave service, the two units may be used separately or in parallel.

° When a filter-input capacitor larger than 40 μf is used, it may be necessary to use more plate-supply impedance than the value shown to limit the peak plate current to the rated value.

INSTALLATION AND APPLICATION

Types 6H6 and 6H6-GT require an octal socket and may be mounted in any position. Outlines 1 and 22 respectively, OUTLINES SECTION. For heater and cathode considerations, refer to type 6AV6.

For detection, the diodes may be utilized in a full-wave circuit or in a half-wave circuit. In the latter case, one plate only, or the two plates in parallel, may be employed. For the same signal voltage, the use of the half-wave arrangement will provide approximately twice the rectified voltage as compared with the full-wave arrangement.

For automatic-volume control, the 6H6 and 6H6-GT may be used in circuits similar to those employed for any of the twin-diode types of tubes. The only difference is that the 6H6 and 6H6-GT are more adaptable because each diode has its own separate cathode.

Since the diodes by themselves do not provide any amplification, it is usually necessary to provide gain by means of a supplementary tube. Types such as the 6J5, 6SJ7, and 6AU6 are very suitable for this purpose. Their use in combination with the 6H6 or 6H6-GT is similar to that of the amplifier sections of twin-diode triode or pentode types.

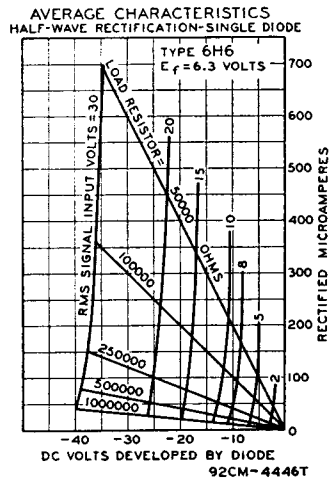

MEDIUM-MU TRIODE

Metal type 6J5 and glass-octal type 6J5-GT used as detectors, amplifiers, or oscillators in radio equipment. These types feature high transconductance together with comparatively

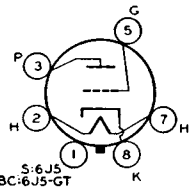

high amplification factor. Outlines 3 and 24, respectively, OUTLINES SECTION. Tubes require octal socket and may be mounted in any position. For heater and cathode considerations, refer to type 6AV6. For typical operation as a resistance-coupled amplifier, refer to Chart 13, RESISTANCE-COUPLED AMPLIFIER SECTION.

HEATER VOLTAGE (AC/DC).....	6.3	volts	
HEATER CURRENT.....	0.3	ampere	
DIRECT INTERELECTRODE CAPACITANCES (Approx.):			
Grid to Plate.....	6J5* 3.4	6J5-GT** 3.8	$\mu\mu\text{f}$
Input.....	3.4	4.2	$\mu\mu\text{f}$
Output.....	3.6	5.0	$\mu\mu\text{f}$

\* Shell connected to cathode.      \*\* Close-fitting shield connected to cathode.

Maximum Ratings: CLASS A<sub>1</sub> AMPLIFIER

PLATE VOLTAGE.....	300 max	volts
GRID VOLTAGE, Positive Bias Value.....	0 max	volts
PLATE DISSIPATION.....	2.5 max	watts
PEAK HEATER-CATHODE VOLTAGE:		
Heater negative with respect to cathode.....	90 max	volts
Heater positive with respect to cathode.....	90 max	volts
CATHODE CURRENT.....	20 max	ma

# RCA RECEIVING TUBE MANUAL

## Typical Operation:

Plate Voltage.....	90	250	volts
Grid Voltage†.....	0	-8	volts
Amplification Factor.....	20	20	
Plate Resistance.....	6700	7700	ohms
Transconductance.....	3000	2600	μmhos
Grid Bias (Approx.) for plate current of 10 μa.....	-7	-18	volts
Plate Current.....	10	9	ma

† Under maximum rated conditions, the dc resistance in the grid circuit should not exceed 1.0 megohm.

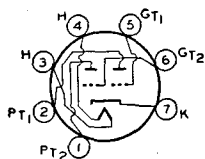
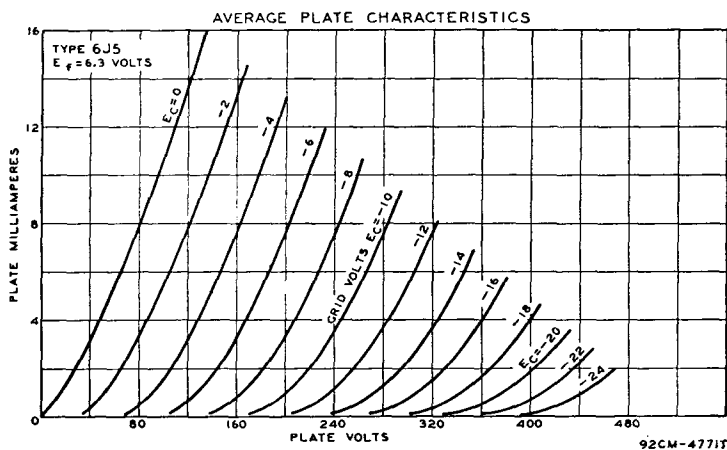

## MEDIUM-MU TWIN TRIODE

# 6J6

Miniature type used as an rf power amplifier and oscillator or as an af amplifier. With a push-pull arrangement of the grids and with the plates in parallel, it is also used as a mixer at

frequencies as high as 600 megacycles per second. Outline 12, **OUTLINES SECTION**. Tube requires miniature seven-contact socket and may be mounted in any position. For heater and cathode considerations, refer to type 6AQ5.

HEATER VOLTAGE (AC/DC).....	6.3	volts
HEATER CURRENT.....	0.45	ampere
DIRECT INTERELECTRODE CAPACITANCES: *		
Grid to Plate.....	1.6	μf
Input.....	2.2	μf
Output.....	0.4	μf

\* No external shield. Approximate values for each unit.

### Maximum Ratings:

### CLASS A<sub>1</sub> AF AMPLIFIER

PLATE VOLTAGE.....	300 max	volts
PLATE DISSIPATION (PER UNIT).....	1.5 max	watts
PEAK HEATER-CATHODE VOLTAGE:		
Heater negative with respect to cathode.....	100 max	volts
Heater positive with respect to cathode.....	100 max	volts

### Typical Operation (Each Unit):

Plate Voltage.....	100	volts
Cathode-Bias Resistor**.....	50†	ohms
Amplification Factor.....	38	
Plate Resistance.....	7100	ohms
Transconductance.....	5300	μmhos
Plate Current.....	8.5	ma

\*\* Under maximum rated conditions, the resistance in the grid circuit should not exceed 0.5 megohm with cathode bias. Operation with fixed bias is not recommended.

† Value is for both units operating at the specified conditions.

### RF POWER AMPLIFIER AND OSCILLATOR—Class C Telegraphy

*Values are for both units, unless otherwise specified.*

#### Maximum Ratings:

DC PLATE VOLTAGE.....	300 max	volts
DC GRID VOLTAGE.....	-40 max	volts
DC PLATE CURRENT (PER UNIT).....	15 max	ma
DC GRID CURRENT (PER UNIT).....	8 max	ma
DC PLATE INPUT (PER UNIT).....	4.5 max	watts
PLATE DISSIPATION (PER UNIT).....	1.5 max	watts
<b>PEAK HEATER-CATHODE VOLTAGE:</b>		
Heater negative with respect to cathode.....	100 max	volts
Heater positive with respect to cathode.....	100 max	volts

#### Typical Operation:‡

DC Plate Voltage.....	150	volts
DC Grid Voltage°.....	-10	volts
DC Plate Current.....	30	ma
DC Grid Current (Approx.).....	16	ma
Driving Power (Approx.).....	0.35	watt
Power Output (Approx.).....	3.5	watts

‡ At moderate frequencies in push-pull. Key-down conditions without modulation. At 250 Mc, approximately 1.0 watt can be obtained when the 6J6 is used as a push-pull oscillator with a plate voltage of 150 volts, with maximum rated plate dissipation, and with a grid resistor of 2000 ohms common to both units.

° Obtained by grid resistor (625 ohms), cathode resistor (220 ohms), or fixed supply.

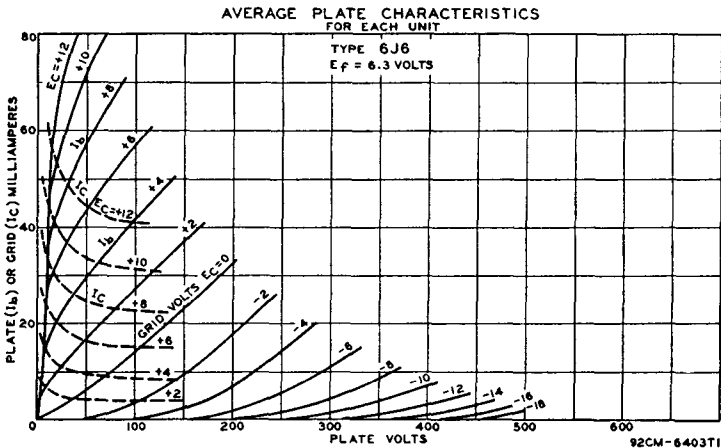

**SHARP-CUTOFF PENTODE**

**6J7**  
**6J7-G**  
**6J7-GT**

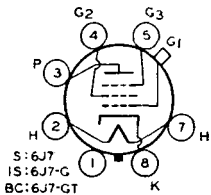

Metal type 6J7 and glass-octal types 6J7-G and 6J7-GT are used as biased detectors or high-gain audio amplifiers in radio receivers. Outlines 4, 33, and 23, respectively. **OUTLINES**

**SECTION.** Type 6J7-G is used principally for renewal purposes. All types require octal socket and may be mounted in any position. For typical operation as resistance-coupled amplifiers, refer to Charts 11 and 14, **RESISTANCE-COUPLED AMPLIFIER SECTION.** For heater and cathode considerations, refer to type 6AV6.

HEATER VOLTAGE (AC/DC) .....	6.3	volts
HEATER CURRENT .....	0.3	ampere

**Maximum Ratings: CLASS A<sub>1</sub> AMPLIFIER (Pentode Connection)**

PLATE VOLTAGE .....	300 <i>max</i>	volts
GRID-NO.2 (SCREEN) VOLTAGE .....	125 <i>max</i>	volts
GRID-NO.2 SUPPLY VOLTAGE .....	300 <i>max</i>	volts
GRID-NO.1 (CONTROL-GRID) VOLTAGE, Positive Bias Value .....	0 <i>max</i>	volts
PLATE DISSIPATION .....	0.75 <i>max</i>	watt
GRID-NO.2 INPUT .....	0.10 <i>max</i>	watt
<b>PEAK HEATER-CATHODE VOLTAGE:</b>		
Heater negative with respect to cathode .....	90 <i>max</i>	volts
Heater positive with respect to cathode .....	90 <i>max</i>	volts

**Typical Operation:**

Plate Voltage .....	100	250	volts
Grid No.3 (Suppressor) .....	Connected to cathode at socket		
Grid-No.2 Voltage .....	100	100	volts
Grid-No.1 Voltage* .....	-3	-3	volts
Plate Resistance .....	1.0	+	megohm
Transconductance .....	1185	1225	μmhos
Grid-No.1 Bias (Approx.) for cathode-current cutoff .....	-7	-7	volts
Plate Current .....	2	2	ma
Grid-No.2 Current .....	0.5	0.5	ma

**Maximum Ratings: CLASS A<sub>1</sub> AMPLIFIER (Triode Connection)<sup>o</sup>**

PLATE VOLTAGE .....	250 <i>max</i>	volts
GRID-NO.1 VOLTAGE, Positive Bias Value .....	0 <i>max</i>	volts
PLATE AND GRID-NO.2 DISSIPATION (TOTAL) .....	1.75 <i>max</i>	watts

**Typical Operation:**

Plate Voltage .....	180	250	volts
Grid-No.1 Voltage* .....	-5.3	-8	volts
Amplification Factor .....	20	20	
Plate Resistance .....	11000	10500	ohms
Transconductance .....	1800	1900	μmhos
Plate Current .....	5.3	6.5	ma

\* DC resistance in grid circuit should not exceed 1.0 megohm.

+ Greater than 1.0 megohm.

<sup>o</sup> Grids No.2 and No.3 connected to plate.

**TRIODE—HEPTODE CONVERTER**

**6J8-G**

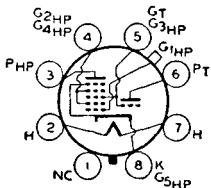

Glass octal type used as a combined triode oscillator and heptode mixer in radio receivers. Outline 33, **OUTLINES SECTION.** Tube requires octal socket. Heater volts (ac/dc), 6.3; amperes, 0.3. Typical operation—Heptode unit: plate volts, 250 (300 *max*); grids-No.2-and-No.4 volts, 100 *max*; grid-No.1 volts, -3; plate resistance, 4 megohms; conversion transconductance, 290 μmhos; plate ma., 1.3; grids-No.2-and-No.4 ma., 3.5. Triode unit: plate volts, 250 *max* (applied through 20000-ohm dropping resistor); grid resistor, 50000 ohms; plate ma., 5.3. This type is used principally for renewal purposes.

**HIGH-MU TRIODE**

Glass octal type used as voltage amplifier in radio equipment. Outline 23, OUTLINES SECTION. Tube requires octal socket. Heater volts (ac/dc), 6.3; amperes, 0.3. Characteristics as class A<sub>1</sub> amplifier: plate volts, 250 *max*; grid volts, -3; amplification factor, 70; plate resistance, 50000 ohms; transconductance, 1400  $\mu$ mhos; plate ma., 1.1. This type is used principally for renewal purposes.

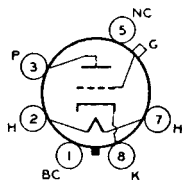

**6K5-GT**

**POWER PENTODE**

Glass octal type used in output stage of radio receivers. It is capable of delivering moderate power output with relatively small input voltage. Tube may be used singly or in push-pull.

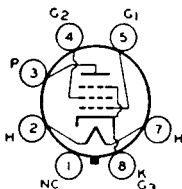

**6K6-GT**

HEATER VOLTAGE (AC/DC).....	6.3	volts
HEATER CURRENT.....	0.4	ampere
DIRECT INTERELECTRODE CAPACITANCES (Approx. With no external shield):		
Grid No.1 to Plate.....	0.5	$\mu$ f
Input.....	5.5	$\mu$ f
Output.....	6.0	$\mu$ f

**Maximum Ratings: SINGLE-TUBE CLASS A<sub>1</sub> AMPLIFIER**

PLATE VOLTAGE.....	315 <i>max</i>	volts
GRID-NO.2 (SCREEN) VOLTAGE.....	285 <i>max</i>	volts
PLATE DISSIPATION.....	8.5 <i>max</i>	watts
GRID-NO.2 INPUT.....	2.8 <i>max</i>	watts
GRID-NO.1 (CONTROL-GRID) VOLTAGE, Positive Bias Value.....	0 <i>max</i>	volts
PEAK HEATER-CATHODE VOLTAGE:		
Heater negative with respect to cathode.....	90 <i>max</i>	volts
Heater positive with respect to cathode.....	90 <i>max</i>	volts

**Typical Operation:**

Plate Voltage.....	100	250	315	volts
Grid-No.2 Voltage.....	100	250	250	volts
Grid-No.1 (Control-Grid) Voltage.....	-7	-18	-21	volts
Peak AF Grid-No.1 Voltage.....	7	18	21	volts
Zero-Signal Plate Current.....	9.5	32	25.5	ma
Maximum-Signal Plate Current.....	9.5	33	28	ma
Zero-Signal Grid-No.2 Current.....	1.6	5.5	4.0	ma
Maximum-Signal Grid-No.2 Current.....	3	10	9	ma
Plate Resistance (Approx.).....	104000	90000	110000	ohms
Transconductance.....	1500	2300	2100	$\mu$ mhos
Load Resistance.....	12000	7600	9000	ohms
Total Harmonic Distortion.....	11	11	15	per cent
Maximum-Signal Power Output.....	0.35	3.4	4.5	watts

**Maximum Ratings: PUSH-PULL CLASS A<sub>1</sub> AMPLIFIER**

(Same as for Single-Tube Class A<sub>1</sub> Amplifier.)

Typical Operation (Values are for two tubes):	Fixed Bias	Cathode Bias	
Plate Voltage.....	285	285	volts
Grid-No.2 Voltage.....	285	285	volts
Grid-No.1 (Control-Grid) Voltage.....	-25.5	-	volts
Cathode Resistor.....	-	400	ohms
Peak AF Grid-No.1-to-Grid-No.1 Voltage.....	51	51	volts
Zero-Signal Plate Current.....	55	55	ma
Maximum-Signal Plate Current.....	72	61	ma
Zero-Signal Grid-No.2 Current.....	9	9	ma
Maximum-Signal Grid-No.2 Current.....	17	13	ma
Effective Load Resistance (Plate-to-plate).....	12000	12000	ohms
Total Harmonic Distortion.....	6	4	per cent
Maximum-Signal Power Output.....	10.5	9.8	watts



## INSTALLATION AND APPLICATION

Tube requires octal socket and may be mounted in any position. Outline 22, **OUTLINES SECTION**. It is especially important that this tube, like other power-handling tubes, should be adequately ventilated.

Any conventional type of input coupling may be used provided the resistance added to the grid-No.1 circuit by this device is not too high. Transformer- or impedance-coupling devices are recommended. When the grid-No.1 circuit has a resistance not higher than 0.1 megohm, fixed bias may be used; for higher values, cathode bias is required. With cathode bias, the grid-No.1 circuit may have a resistance as high as but not higher than 0.5 megohm, provided the heater voltage does not rise more than 10% above the rated value under any condition of operation.

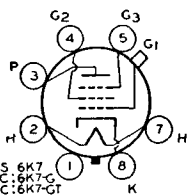
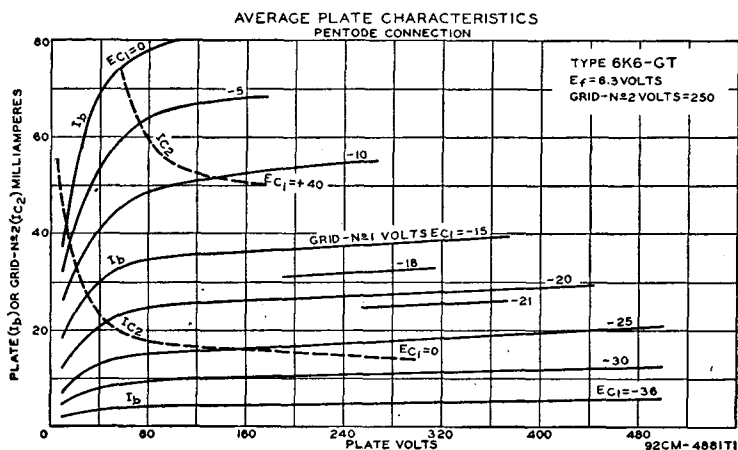

### REMOTE-CUTOFF PENTODE

Metal type 6K7 and glass-octal types 6K7-G and 6K7-GT used in rf and if stages of radio receivers, particularly in those employing avc. Outlines 4, 33, and 23, respectively, **OUT-**

**LINES SECTION**. Type 6K7-G is used principally for renewal purposes. These tubes require octal socket and may be mounted in any position. For electrode voltage supplies and application, refer to type 6SK7. For heater and cathode considerations, refer to type 6AV6.

# 6K7 6K7-G 6K7-GT

HEATER VOLTAGE (AC/DC) .....	6.3	volts
HEATER CURRENT .....	0.3	ampere

**Maximum Ratings:**

#### CLASS A<sub>1</sub> AMPLIFIER

PLATE VOLTAGE .....	300 max	volts
GRID-NO.2 (SCREEN) VOLTAGE .....	125 max	volts
GRID-NO.2 SUPPLY VOLTAGE .....	300 max	volts
GRID-NO.1 (CONTROL-GRID) VOLTAGE, Positive Bias Value .....	0 max	volts
PLATE DISSIPATION .....	2.75 max	watts
GRID-NO.2 INPUT .....	0.35 max	watt
<b>PEAK HEATER-CATHODE VOLTAGE:</b>		
Heater negative with respect to cathode .....	90 max	volts
Heater positive with respect to cathode .....	90 max	volts

### Typical Operation:

Plate Voltage	100	250	250	volts
Grid No.3 (Suppressor)	Connected to cathode at socket			
Grid-No.2 Voltage	100	100	125	volts
Grid-No.1 Voltage	-1	-3	-3	volts
Plate Resistance (Approx.)	0.15	0.8	0.6	megohm
Transconductance	1650	1450	1650	$\mu$ mhos
Grid-No.1 Bias for transconductance of approx. 2 $\mu$ mhos	-38.5	-42.5	-52.5	volts
Plate Current	9.5	7.0	10.5	ma
Grid-No.2 Current	2.7	1.7	2.6	ma

## 6K8 6K8-G 6K8-GT

### TRIODE-HEXODE CONVERTER

Metal type 6K8 and glass-octal types 6K8-G and 6K8-GT used as combined triode oscillator and hexode mixer in radio receivers. Type 6K8, Outline 5, type 6K8-G, Outline 33,

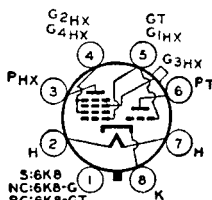

OUTLINES SECTION. Type 6K8-G is used principally for renewal purposes. Type 6K8-GT is a DISCONTINUED type listed for reference only. Tubes require octal socket and may be mounted in any position. For heater and cathode considerations, refer to type 6AV6. For application, refer to Frequency Conversion in ELECTRON TUBE APPLICATIONS SECTION.

HEATER VOLTAGE (AC/DC)	6.3	volts
HEATER CURRENT	0.3	ampere

### CONVERTER SERVICE

#### Maximum Ratings:

HEXODE PLATE VOLTAGE	300 max	volts
HEXODE GRIDS-NO.2-AND-NO.4 (SCREEN) VOLTAGE	150 max	volts
HEXODE GRIDS-NO.2-AND-NO.4 SUPPLY VOLTAGE	300 max	volts
HEXODE GRID-NO.3 (CONTROL-GRID) VOLTAGE, Positive Bias Value	0 max	volts
TRIODE PLATE VOLTAGE	125 max	volts
HEXODE PLATE DISSIPATION	0.75 max	watt
HEXODE GRIDS-NO.2-AND-NO.4 INPUT	0.7 max	watt
TRIODE PLATE DISSIPATION	0.75 max	watt
TOTAL CATHODE CURRENT	16 max	ma
PEAK HEATER-CATHODE VOLTAGE:		
Heater negative with respect to cathode	90 max	volts
Heater positive with respect to cathode	90 max	volts

### Typical Operation:

Hexode Plate Voltage	100	250	volts
Hexode Grids-No.2-and-No.4 Voltage	100	100	volts
Hexode Grid-No.3 Voltage	-3	-3	volts
Triode Plate Voltage	100	100	volts
Triode Grid Resistor	50000	50000	ohms
Hexode Plate Resistance (Approx.)	0.4	0.6	megohm
Conversion Transconductance	325	350	$\mu$ mhos
Hexode Grid-No.3 Voltage (Approx.) for conversion transconductance of 2 $\mu$ mhos	-30	-30	volts
Hexode Plate Current	2.3	2.5	ma
Hexode Grids-No.2-and-No.4 Current	6.2	6.0	ma
Triode Plate Current	3.8	3.8	ma
Triode Grid and Hexode Grid-No.1 Current	0.15	0.15	ma
Total Cathode Current	12.5	12.5	ma

The transconductance of the triode section, not oscillating, of the 6K8 is approximately 3000  $\mu$ mhos when the triode plate voltage is 100 volts, and the triode grid voltage is 0 volts.

### MEDIUM-MU TRIODE

## 6L5-G

Glass octal type used as detector, amplifier, or oscillator in radio receivers. Outline 31, OUTLINES SECTION. Heater volts (ac/dc), 6.3; amperes, 0.15. Typical operation and characteristics: plate volts, 250 max; grid volts, -9; plate ma., 8; plate resistance, 9000 ohms; amplification factor, 17; transconductance, 1900  $\mu$ mhos; grid-bias volts for cathode-current cutoff, -20.

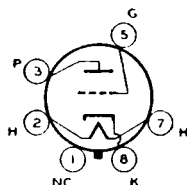

As a class A<sub>1</sub> amplifier, the 6L5-G may be operated in resistance-coupled circuits as shown in Chart 15, RESISTANCE-COUPLED AMPLIFIER SECTION. This type is used principally for renewal purposes.

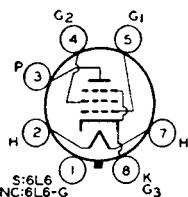

## BEAM POWER AMPLIFIER

# 6L6 6L6-G

Metal type 6L6 and glass-octal type 6L6-G are used in output stage of radio receivers and amplifiers, especially those designed to have ample reserve of power-delivering ability.

These types provide high power output, sensitivity, and high efficiency. Power output at all levels has low third and negligible higher-order harmonics. For discussion of beam power amplifier considerations, refer to **ELECTRONS, ELECTRODES, AND ELECTRON TUBES SECTION**.

HEATER VOLTAGE (AC/DC).....		6.3	volts
HEATER CURRENT.....		0.9	ampere
DIRECT INTERELECTRODE CAPACITANCES (Approx.):			
Grid No.1 to Plate.....	6L6	6L6-G	
Input.....	0.4	0.9	$\mu\mu\text{f}$
Output.....	10	11.5	$\mu\mu\text{f}$
	12	9.5	$\mu\mu\text{f}$

### Maximum Ratings: SINGLE-TUBE CLASS A<sub>1</sub> AMPLIFIER

PLATE VOLTAGE.....	360	<i>max</i>	volts
GRID-NO.2 (SCREEN) VOLTAGE.....	270	<i>max</i>	volts
PLATE DISSIPATION.....	19	<i>max</i>	watts
GRID-NO.2 INPUT.....	2.5	<i>max</i>	watts
PEAK HEATER-CATHODE VOLTAGE:			
Heater negative with respect to cathode.....	180	<i>max</i>	volts
Heater positive with respect to cathode.....	180	<i>max</i>	volts

### Typical Operation:

	<i>Fixed Bias</i>		<i>Cathode Bias</i>	
Plate Voltage.....	250	350	250	300
Grid-No.2 Voltage.....	250	250	250	200
Grid-No.1 (Control-Grid) Voltage.....	-14	-18	-	-
Cathode Resistor.....	-	-	170	220
Peak AF Grid-No.1 Voltage.....	14	18	14	12.5
Zero-Signal Plate Current.....	72	54	75	51
Maximum-Signal Plate Current.....	79	66	78	54.5
Zero-Signal Grid-No.2 Current.....	5	2.5	5.4	3
Maximum-Signal Grid-No.2 Current.....	7.3	7	7.2	4.6
Plate Resistance.....	22500	33000	-	-
Transconductance.....	6000	5200	-	-
Load Resistance.....	2500	4200	2500	4500
Total Harmonic Distortion.....	10	15	10	11
Maximum-Signal Power Output.....	6.5	10.8	6.5	6.5

### SINGLE-TUBE CLASS A<sub>1</sub> AMPLIFIER (Triode Connection)†

#### Maximum Ratings:

PLATE VOLTAGE.....	275	<i>max</i>	volts
PLATE AND GRID-NO.2 DISSIPATION (TOTAL).....	12.5	<i>max</i>	watts
PEAK HEATER-CATHODE VOLTAGE:			
Heater negative with respect to cathode.....	180	<i>max</i>	volts
Heater positive with respect to cathode.....	180	<i>max</i>	volts

#### Typical Operation:

	<i>Fixed Bias</i>		<i>Cathode Bias</i>	
Plate Voltage.....	250		250	volts
Grid-No.1 (Control-Grid) Voltage.....	-20		-	volts
Cathode Resistor.....	-		490	ohms
Peak AF Grid-No.1 Voltage.....	20		20	volts
Zero-Signal Plate Current.....	40		40	ma
Maximum-Signal Plate Current.....	44		42	ma
Plate Resistance.....	1700		-	ohms
Amplification Factor.....	8		-	-
Transconductance.....	4700		-	$\mu\text{mbos}$
Load Resistance.....	5000		6000	ohms
Total Harmonic Distortion.....	5		6	per cent
Maximum-Signal Power Output.....	1.4		1.3	watts

† Grid No.2 connected to plate.

## Maximum Ratings: PUSH-PULL CLASS A<sub>1</sub> AMPLIFIER

(Same as for single-tube class A<sub>1</sub> amplifier)

### Typical Operation (Values are for two tubes)

	<i>Fixed Bias</i>		<i>Cathode Bias</i>	
Plate Voltage	250	270	270	volts
Grid-No.2 Voltage	250	270	270	volts
Grid-No.1 (Control-Grid) Voltage	-16	-17.5	-	volts
Cathode Resistor	-	-	125	ohms
Peak AF Grid-No.1-to-Grid-No.1 Voltage	32	35	40	volts
Zero-Signal Plate Current	120	134	134	ma
Maximum-Signal Plate Current	140	155	145	ma
Zero-Signal Grid-No.2 Current	10	11	11	ma
Maximum-Signal Grid-No.2 Current	16	17	17	ma
Plate Resistance	24500	23500	-	ohms
Transconductance	5500	5700	-	μmhos
Effective Load Resistance (Plate-to-plate)	5000	5000	5000	ohms
Total Harmonic Distortion	2	2	2	per cent
Maximum-Signal Power Output	14.5	17.5	18.5	watts

## Maximum Ratings: PUSH-PULL CLASS AB<sub>1</sub> AMPLIFIER

(Same as for single-tube class A<sub>1</sub> amplifier)

### Typical Operation (Values are for two tubes):

	<i>Fixed Bias</i>		<i>Cathode Bias</i>	
Plate Voltage	360	360	360	volts
Grid-No.2 Voltage	270	270	270	volts
Grid-No.1 (Control-Grid) Voltage	-22.5	-22.5	-	volts
Cathode Resistor	-	-	250	ohms
Peak AF Grid-No.1-to-Grid-No.1 Voltage	45	45	57	volts
Zero-Signal Plate Current	88	88	88	ma
Maximum-Signal Plate Current	132	140	100	ma
Zero-Signal Grid-No.2 Current	5	5	5	ma
Maximum-Signal Grid-No.2 Current	15	11	17	ma
Effective Load Resistance (Plate-to-plate)	6600	3800	9000	ohms
Total Harmonic Distortion	2	2	4	per cent
Maximum-Signal Power Output	26.5	18	24.5	watts

## Maximum Ratings: PUSH-PULL CLASS AB<sub>2</sub> AMPLIFIER

(Same as for single-tube class A<sub>1</sub> amplifier)

### Typical Operation (Values are for two tubes):

	<i>Fixed Bias</i>		
Plate Voltage	360	360	volts
Grid-No.2 Voltage	225	270	volts
Grid-No.1 (Control-Grid) Voltage	-18	-22.5	volts
Peak AF Grid-No.1-to-Grid-No.1 Voltage	52	72	volts
Zero-Signal Plate Current	78	88	ma
Maximum-Signal Plate Current	142	205	ma
Zero-Signal Grid-No.2 Current	3.5	5	ma
Maximum-Signal Grid-No.2 Current	11	16	ma
Effective Load Resistance (Plate-to-plate)	6000	3800	ohms
Peak Grid-Input Power	140	270	mw
Total Harmonic Distortion	2	2	per cent
Maximum-Signal Power Output	31	47	watts

## INSTALLATION AND APPLICATION

Types 6L6 and 6L6-G require an octal socket and may be mounted in any position. Outlines 7 and 40, respectively, OUTLINES SECTION. It is especially important that these tubes, like other power-handling tubes, should be adequately ventilated.

The heater is designed to operate at 6.3 volts. The transformer supplying this voltage should be designed to operate the heater at this recommended value for full-load operating conditions at average line voltage. Under the maximum screen- and plate-dissipation conditions, the heater voltage should never fluctuate so that it exceeds 7.0 volts. For cathode connection, refer to type 6AQ5.

In all services, precautions should be taken to insure that the dissipation rating is not exceeded with expected line-voltage variations, especially in the cases of fixed-bias operation. When the push-pull connection is used, fixed-bias values up to 10% of each typical grid-No.2 voltage can be used without increasing distortion.

As class  $A_1$  power amplifiers, the 6L6 and 6L6-G may be operated as shown in the tabulated data. The values cover cathode- and fixed-bias operation for both types where used as beam power tubes as well as where they are connected as triodes and have been determined on the basis that no grid current flows during any part of the input-signal swing. The second harmonics can easily be eliminated by the use of push-pull circuits. In single-tube amplifiers with resistance-coupled input, the second harmonics can be minimized by generating out-of-phase second harmonics in the pre-amplifier.

As push-pull class  $AB_1$  power amplifiers, the 6L6 and 6L6-G may be operated as shown in the tabulated data. The values shown cover cathode- and fixed-bias operation and have been determined on the basis that no grid current flows during any part of the input-signal swing.

The type of input coupling used in class  $A_1$  and class  $AB_1$  service should not introduce too much resistance in the grid-No.1 circuit. Transformer- or impedance-coupling devices are recommended. When the grid-No.1 circuit has a resistance not higher than 0.1 megohm, fixed bias may be used; for higher values, cathode bias is required. With cathode bias the grid-No.1 circuit may have a resistance as high as, but not higher than, 0.5 megohm provided the heater voltage is not allowed to rise more than 10% above the rated value under any condition of operation.

As push-pull class  $AB_2$  power amplifiers, the 6L6 and the 6L6-G may be operated as shown in the tabulated data. The values cover operation with fixed bias and have been determined on the basis that some grid current flows during the most positive swing of the input signal.

Refer to **CIRCUIT SECTION** for circuits employing the 6L6 or 6L6-G, and to the **ELECTRON TUBE APPLICATIONS SECTION** for discussion of inverse-feedback arrangements.

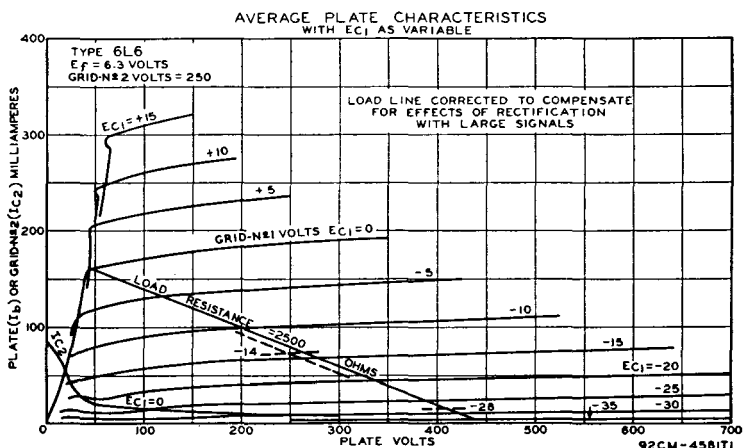

### PENTAGRID MIXER

Metal type 6L7 and glass-octal type 6L7-G are used as mixers in superheterodyne circuits having a separate oscillator stage as well as in other applications where dual control is desirable in a single stage. The two separate control grids are shielded from each other and the coupling effects between oscillator and signal circuits are very small. For additional information, refer to **Frequency Conversion**, **ELECTRON TUBE APPLICATIONS SECTION**. Outlines 4 and 33, respectively, **OUTLINES SECTION**. Type 6L7-G is used principally for renewal purposes. Heater

## 6L7 6L7-G

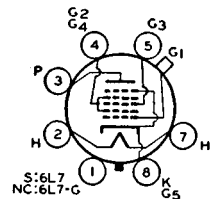

tion, refer to **Frequency Conversion**, **ELECTRON TUBE APPLICATIONS SECTION**. Outlines 4 and 33, respectively, **OUTLINES SECTION**. Type 6L7-G is used principally for renewal purposes. Heater

volts (ac/dc), 6.3; amperes, 0.3. Maximum ratings as mixer: plate volts, 300; grids-No.2-and-No.4 volts, 150; plate dissipation, 1.0 watt; grids-No.2-and-No.4 input, 1.5 watts. Typical operation as mixer (values recommended for all-wave receivers): plate volts, 250; grids-No.2-and-No.4 volts, 150; grid-No.1 (signal-grid) volts, -6 *min*; grid-No.3 (oscillator-grid) volts\*, -15; peak oscillator volts applied to grid-No.3, 18 *min*; plate ma, 3.3; grids-No.2-and-No.4 ma, 9.2; plate resistance, greater than 1 meg-ohm; conversion transconductance, 350  $\mu$ mhos; grid-No.1 volts for 5  $\mu$ mhos conversion transconductance, -45.

\* The dc resistance in the grid-No.3 circuit should be limited to 50000 ohms.

## 6N6-G

### DIRECT-COUPLED POWER TRIODE

Glass octal type used as class A<sub>1</sub> power amplifier. Outline 35, OUTLINES SECTION. Heater volts (ac/dc), 6.3; amperes, 0.8. For electrical characteristics, refer to type 6B5. Type 6N6-G is used principally for renewal purposes.

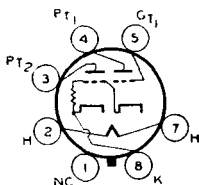

## 6N7 6N7-GT

### HIGH-MU TWIN POWER TRIODE

Metal type 6N7 and glass-octal type 6N7-GT used in output stage of radio receivers as class B power amplifier or with units in parallel as a class A<sub>1</sub> amplifier to drive a 6N7 or 6N7-GT

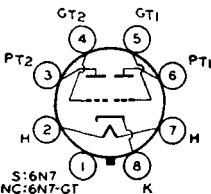

as a class B amplifier. Outlines 6 and 22, respectively, OUTLINES SECTION. Tubes require octal socket and may be mounted in any position. For typical operation as a resistance-coupled amplifier, refer to Chart 6, RESISTANCE-COUPLED AMPLIFIER SECTION. For class B amplifier considerations, refer to ELECTRON TUBE APPLICATIONS SECTION.

HEATER VOLTAGE (AC/DC).....	6.3	volts
HEATER CURRENT.....	0.8	ampere

### CLASS B POWER AMPLIFIER

Values are for both units, unless otherwise specified.

#### Maximum Ratings:

PLATE VOLTAGE.....	300 <i>max</i>	volts
PEAK PLATE CURRENT (Each Unit).....	125 <i>max</i>	ma
AVERAGE PLATE DISSIPATION (Each Unit).....	5.5 <i>max</i>	watts
PEAK HEATER-CATHODE VOLTAGE:		
Heater negative with respect to cathode.....	90 <i>max</i>	volts
Heater positive with respect to cathode.....	90 <i>max</i>	volts

#### Typical Operation:

Plate-Supply Impedance.....	0	1000	ohms
Effective Grid-Circuit Impedance.....	0	516**	ohms
Plate Voltage.....	300	300	volts
Grid Voltage.....	0	0	volts
Peak AF Grid-to-Grid Voltage.....	58	82	volts
Zero-Signal DC Plate Current.....	35	35	ma
Maximum-Signal DC Plate Current.....	70	70	ma
Peak-Grid Current (Each Unit).....	20	22	ma
Effective Load Resistance (Plate-to-plate).....	8000	8000	ohms
Total Harmonic Distortion.....	4	8	per cent
Third Harmonic Distortion.....	3.5	7.5	per cent
Fifth Harmonic Distortion.....	1.5	2.5	per cent
Maximum-Signal Power Output.....	10	10	watts

\*\* At 400 cycles per second for class B stage in which the effective resistance per grid circuit is 500 ohms, and the leakage reactance of the coupling transformer is 50 millihenries. The driver stage should be capable of supplying the grids of the class B stage with the specified values at low distortion.

### CLASS A<sub>1</sub> AMPLIFIER

Both grids connected together at socket; likewise, both plates.

#### Maximum Ratings:

PLATE VOLTAGE.....	300 <i>max</i>	volts
PLATE DISSIPATION (per plate).....	1.0 <i>max</i>	watt

**PEAK HEATER-CATHODE VOLTAGE:**

Heater negative with respect to cathode.....	<i>90 max</i>	volts
Heater positive with respect to cathode.....	<i>90 max</i>	volts

**Typical Operation:**

Plate Voltage.....	250	300	volts
Grid Voltage.....	-5	-6	volts
Amplification Factor.....	35	35	
Plate Resistance.....	11300	11000	ohms
Transconductance.....	3100	3200	$\mu$ mhos
Plate Current.....	6	7	ma

Plate Load—Depends largely on the design factors of the class B amplifier. In general, the load will be between 20000 and 40000 ohms.

Power Output—Under maximum voltage conditions, upwards of 400 milliwatts can be obtained.

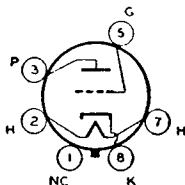

### MEDIUM-MU TRIODE

Glass octal type used as detector, amplifier, or oscillator in radio receivers. Outline 22, OUTLINES SECTION. Tube requires octal socket. Heater volts (ac/dc), 6.3; amperes, 0.3. Except for interelectrode capacitances, this type is identical electrically with type 76. Type 6P5-GT is used principally for renewal purposes.

## 6P5-GT

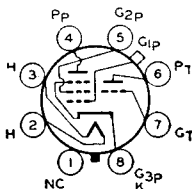

### TRIODE—PENTODE

Glass octal type used as an amplifier. Outline 33, OUTLINES SECTION. Heater volts (ac/dc), 6.3; amperes, 0.3. Except for interelectrode capacitances, this type is identical electrically with type 6P7. Type 6P7-G is a DISCONTINUED type listed for reference only.

## 6P7-G

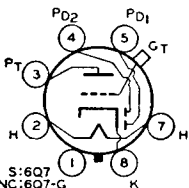

### TWIN DIODE—HIGH-MU TRIODE

Metal type 6Q7 and glass-octal types 6Q7-G and 6Q7-GT used as a combined detector, amplifier, and avc tube in radio receivers. Outlines 4, 33, and 23, respectively, OUTLINES

## 6Q7 6Q7-G 6Q7-GT

SECTION. Type 6Q7-G is used principally for renewal purposes. Tubes require octal socket and may be mounted in any position. Heater volts (ac/dc), 6.3; amperes, 0.3. For heater and cathode considerations, refer to type 6AV6. These types are similar electrically in most respects to types 6SQ7 and 6AT6. Maximum ratings and typical operation of the triode unit as a class A<sub>1</sub> amplifier are the same as those for type 6AT6 except that with a plate voltage of 100 volts, the transconductance is 1200  $\mu$ mhos and the plate resistance 58000 ohms. The triode unit is recommended for use only in resistance-coupled circuits; refer to Chart 7, RESISTANCE-COUPLED AMPLIFIER SECTION. For triode-unit, grid-bias considerations, refer to type 6AV6. For diode curves, refer to type 6SQ7.

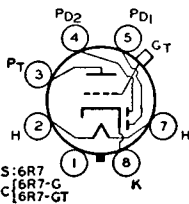

### TWIN DIODE—MEDIUM-MU TRIODE

Metal type 6R7 and glass-octal types 6R7-G and 6R7-GT used as combined detector, amplifier, and avc tubes. Outlines 4, 33, and 20, respectively, OUTLINES SECTION. Tubes require octal sockets. Within their maximum ratings, these types are identical electrically with type 6BF6 except for capacitances. Maximum ratings of triode unit as class A<sub>1</sub> amplifier:

## 6R7 6R7-G 6R7-GT

plate volts, 250 *max*; plate dissipation, 2.5 *max* watts. For typical operation as a resistance-coupled amplifier, refer to Chart 9, RESISTANCE-COUPLED AMPLIFIER SECTION. Type 6R7-G is a DISCONTINUED type listed for reference only.

MEDIUM-MU TRIODE

6S4

Miniature type having high permeance used as vertical deflection amplifier in television receivers. Outline 16, OUTLINES SECTION. Tube requires noval nine-contact socket and may be

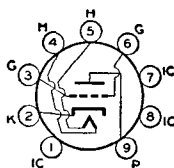

mounted in any position. For heater and cathode considerations, refer to type 6AQ5.

HEATER VOLTAGE (AC/DC).....	6.3	volts
HEATER CURRENT.....	0.6	ampere

Characteristics: CLASS A<sub>1</sub> AMPLIFIER

Plate Voltage.....	250	volts
Grid Voltage.....	-8	volts
Amplification Factor.....	16	
Plate Resistance (Approx.).....	3600	ohms
Transconductance.....	4500	μmhos
Plate Current.....	26	ma

VERTICAL DEFLECTION AMPLIFIER

For operation in a 525-line, 30-frame system

Maximum Ratings:

DC PLATE VOLTAGE.....	500 max	volts
PEAK POSITIVE-PULSE PLATE VOLTAGE <sup>o</sup> .....	2000 max	volts
DC GRID VOLTAGE.....	-50 max	volts
PEAK NEGATIVE-PULSE GRID VOLTAGE.....	-200 max	volts
DC CATHODE CURRENT.....	30 max	ma
PLATE DISSIPATION.....	7.5 max	watts
PEAK HEATER-CATHODE VOLTAGE:		
Heater negative with respect to cathode.....	200 max	volts
Heater positive with respect to cathode.....	200 max	volts

Circuit Values:

Grid-Circuit Resistance.....	2.2 max	megohms
Cathode-Bias Resistance#.....	220 min	ohms

<sup>o</sup> The duration of the voltage pulse must not exceed 15% of one scanning cycle. In a 525-line, 30-frame system, 15% of one scanning cycle is 2.5 milliseconds.

# Indicated minimum value of this resistor is required to protect the tube in the event of temporary failure of excitation and resultant loss in developed bias.

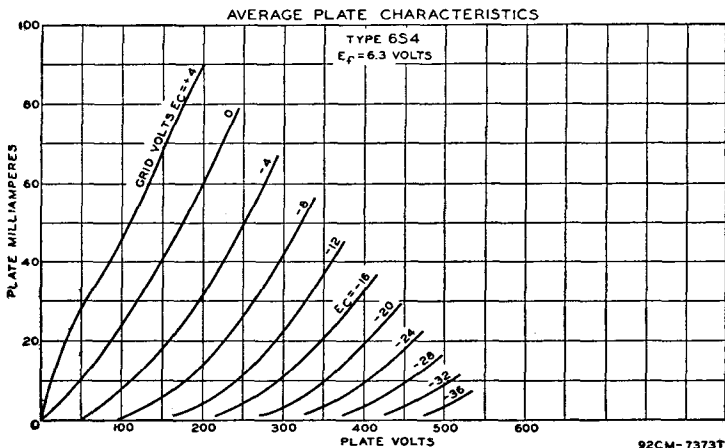



## REMOTE-CUTOFF PENTODE

Metal type 6S7 and glass-octal type 6S7-G are used in rf and if stages of automobile receivers employing avc. Outlines 5 and 33, respectively, **OUTLINES SECTION**. Type 6S7-G is used principally for renewal purposes. Tubes require octal socket and may be mounted in any position. Heater volts, 6.3; amperes, 0.15. Typical operation and maximum ratings

# 6S7 6S7-G

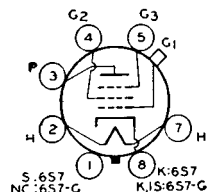

S. 6S7  
NC: 6S7-G  
K: 6S7  
KIS: 6S7-G

as Class A<sub>1</sub> amplifier: plate volts, 250 (300 *max*); grid-No.2 volts, 100 *max*; grid-No.1 volts, -3 (0 *min*); grid No.3 connected to cathode at socket; plate ma., 8.5; grid-No.2 ma., 2; plate resistance, 1.0 megohm; transconductance, 1750  $\mu$ hos; grid-No.1 volts for transconductance of 10  $\mu$ hos, -38.5. Plate dissipation, 2.25 *max* watts; grid-No.2 input, 0.25 *max* watt. For typical operation as a resistance-coupled amplifier, refer to Chart 16, **RESISTANCE-COUPLED AMPLIFIER SECTION**.

## TRIPLE DIODE—HIGH-MU TRIODE

Glass octal type used as audio amplifier, AM detector, and FM detector in AM/FM receivers. Diode unit No.2 is used for AM detection, and diode units No.1 and No.3 are used

# 6S8-GT

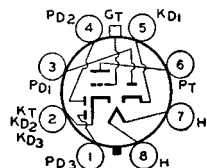

for FM detection. The grid of the high-mu triode is brought out to a top cap. Outline 27, **OUTLINES SECTION**. Tube may be mounted in any position. For heater and cathode considerations, refer to type 6AV6. For typical operation of triode unit as a resistance-coupled amplifier, refer to Chart 4, **RESISTANCE-COUPLED AMPLIFIER SECTION**.

HEATER VOLTAGE (AC/DC) .....	6.3	volts
HEATER CURRENT .....	0.3	ampere
<b>DIRECT INTERELECTRODE CAPACITANCES (With external shield):</b>		
Triode Grid to Triode Plate .....	1.2	$\mu$ f
Triode Input .....	2.0	$\mu$ f
Triode Output .....	5.0	$\mu$ f
Triode Grid to any Diode Plate .....	0.005 <i>max</i>	$\mu$ f
Diode Plate to Cathode (Approx. for each unit) .....	1.0	$\mu$ f

### Maximum Ratings: TRIODE UNIT AS CLASS A<sub>1</sub> AMPLIFIER

TRIODE PLATE VOLTAGE .....	300 <i>max</i>	volts
TRIODE PLATE DISSIPATION .....	0.5 <i>max</i>	watt
<b>PEAK HEATER-CATHODE VOLTAGE:</b>		
Heater negative with respect to cathode .....	90 <i>max</i>	volts
Heater positive with respect to cathode .....	90 <i>max</i>	volts

### Characteristics:

Plate Voltage .....	50	100	250	volts
Grid Voltage .....	-	-1	-2	volts
Grid Resistor .....	10	0	0	megohms
Amplification Factor .....	85	100	100	
Plate Resistance .....	285000	110000	91000	ohms
Transconductance .....	300	900	1100	$\mu$ hos
Plate Current .....	0.07	0.4	0.9	ma

### Maximum Rating: DIODE UNITS

PLATE CURRENT (EACH UNIT) .....	1.0 <i>max</i>	ma
---------------------------------	----------------	----

Diode units No.2 and No.3 and the triode unit have a common cathode. Diode unit No.1 has a separate cathode. For diode operation curves, refer to type 6SQ7.

PENTAGRID CONVERTER

6SA7

Metal type 6SA7 and glass-octal type 6SA7-GT used as converter in superheterodyne circuits. They are similar in performance to type 6BE6. For general discussion of pentagrid types, see Frequency Conversion in ELECTRON TUBE APPLICATIONS SECTION. Both tubes have excellent frequency stability.

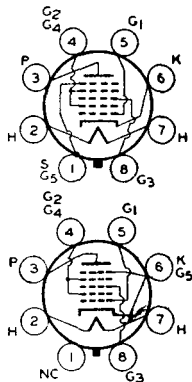

6SA7-GT

HEATER VOLTAGE (AC/DC) . . . . .	6.3	volts
HEATER CURRENT . . . . .	0.3	ampere

DIRECT INTERELECTRODE CAPACITANCES:

	6SA7	6SA7-GT	
Grid No.3 to All Other Electrodes (RF Input) . . . . .	9.5*	11**	$\mu\mu\text{f}$
Plate to All Other Electrodes (Mixer Output) . . . . .	9.5*	11**	$\mu\mu\text{f}$
Grid No.1 to All Other Electrodes (Osc. Input) . . . . .	7*	8**	$\mu\mu\text{f}$
Grid No.2 to Plate . . . . .	0.13 max*	0.5 max**	$\mu\mu\text{f}$
Grid No.3 to Grid No.1 . . . . .	0.15 max*	0.4 max**	$\mu\mu\text{f}$
Grid No.1 to Plate . . . . .	0.06 max*	0.2 max**	$\mu\mu\text{f}$
Grid No.1 to Shell, Grid No.5, and All Other Electrodes except Cathode . . . . .	4.4	-	$\mu\mu\text{f}$
Grid No.1 to All Other Electrodes except Cathode and Grid No.5 . . . . .	-	5	$\mu\mu\text{f}$
Grid No.1 to Cathode . . . . .	2.6	-	$\mu\mu\text{f}$
Grid No.1 to Cathode and Grid No.5 . . . . .	-	3	$\mu\mu\text{f}$
Cathode to Shell, Grid No.5, and All Other Electrodes except Grid No.1 . . . . .	5	-	$\mu\mu\text{f}$
Cathode and Grid No.5 to All Other Electrodes except Grid No.1 . . . . .	-	14	$\mu\mu\text{f}$

\* With shell connected to cathode. \*\* With external shield connected to cathode.

Maximum Ratings:

CONVERTER SERVICE

PLATE VOLTAGE . . . . .	300 max	volts
GRIDS-NO.2-AND-NO.4 VOLTAGE . . . . .	100 max	volts
GRIDS-NO.2-AND-NO.4 SUPPLY VOLTAGE . . . . .	300 max	volts
GRID-NO.3 VOLTAGE:		
Negative bias value . . . . .	-50 max	volts
Positive bias value . . . . .	0 max	volts
PLATE DISSIPATION . . . . .	1.0 max	watt
GRIDS-NO.2-AND-NO.4 INPUT . . . . .	1.0 max	watt
TOTAL CATHODE CURRENT . . . . .	14 max	ma
PEAK HEATER-CATHODE VOLTAGE:		
Heater negative with respect to cathode . . . . .	90 max	volts
Heater positive with respect to cathode . . . . .	90 max	volts

Typical Operation:

	Self-Excitation†		Separate Excitation		
Plate Voltage . . . . .	100	250	100	250	volts
Grids-No.2-and-No.4 Voltage . . . . .	100	100	100	100	volts
Grid-No.3 (Control-Grid) Voltage . . . . .	0	0	-2	-2	volts
Grid-No.1 Resistor . . . . .	20000	20000	20000	20000	ohms
Plate Resistance (Approx.) . . . . .	0.5	1.0	0.5	1.0	megohm
Conversion Transconductance . . . . .	425	450	425	450	$\mu\text{mhos}$
Grid-No.3 Voltage (Approx.)					
for transconductance of 10 $\mu\text{mhos}$ . . . . .	-25	-25	-25	-25	volts
Grid-No.3 Voltage (Approx.) for conversion transconductance of 100 $\mu\text{mhos}$ . . . . .	-9	-9	-9	-9	volts
Plate Current . . . . .	3.3	3.5	3.3	3.5	ma
Grids-No.2-and-No.4 Current . . . . .	8.5	8.5	8.5	8.5	ma
Grid-No.1 Current . . . . .	0.5	0.5	0.5	0.5	ma
Total Cathode Current . . . . .	12.3	12.5	12.3	12.5	ma

NOTE: The transconductance between grid No.1 and grids No.2 and No.4 connected to plate (not oscillating) is approximately 4500  $\mu\text{mhos}$  under the following conditions: grids No.1, No.3, and shell at 0 volts; grids No.2 and No.4 and plate at 100 volts.

† Characteristics are approximate only and are shown for a Hartley circuit with a feedback of approximately 2 volts peak in the cathode circuit.

## INSTALLATION AND APPLICATION

Types 6SA7 and 6SA7-GT require octal socket and may be mounted in any position. Outlines 3 and 22, respectively, OUTLINES SECTION. For heater and cathode considerations, refer to type 6AV6.

Because of the special structural arrangement of the 6SA7 and 6SA7-GT, a change in signal-grid voltage produces little change in cathode current. Consequently, an rf voltage on the signal grid produces little modulation of the electron current flowing in the cathode circuit. This feature is important because it is desirable that the impedance in the cathode circuit should produce little degeneration or regeneration of the signal-frequency input and intermediate-frequency output. Another important feature is that, because signal-grid voltage has little effect on the space charge near the cathode, changes in avc bias produce little change in oscillator transconductance and in the input capacitance of the No.1 grid. There is, therefore, little detuning of the oscillator by avc bias.

A typical self-excited oscillator circuit for use with the 6SA7 will be similar to that for the 6BE6 in the CIRCUIT SECTION. For operation in frequency bands lower than approximately 6 megacycles per second, the circuit should generally be adjusted to provide, with recommended values of plate and grids-No.2-and-No.4 voltage, a cathode voltage of approximately 2 volts peak, and an oscillator-grid current of 0.5 milliampere through a grid resistor of 20000 ohms. In the low- and medium-frequency bands, the recommended oscillator conditions can be readily met. However, in the band covering frequencies higher than approximately 6 megacycles per second, the tank-circuit impedance is generally so low that it is not easy to obtain these oscillator conditions. For optimum performance in this band, it is generally best to adjust the oscillator circuit for maximum conversion gain at the low-frequency end of the band. Maximum conversion gain at this end of the band is usually obtained by adjustment of the oscillator circuit to give a cathode voltage of approximately 2 volts peak and an oscillator-grid current of 0.20 to 0.25 milliampere, with a grid resistor of 20000 ohms.

In the 6SA7 and 6SA7-GT operation characteristics curves with self-excitation,  $E_k$  is the voltage across the oscillator-coil section between cathode and ground;  $E_g$  is the oscillator voltage between cathode and grid.

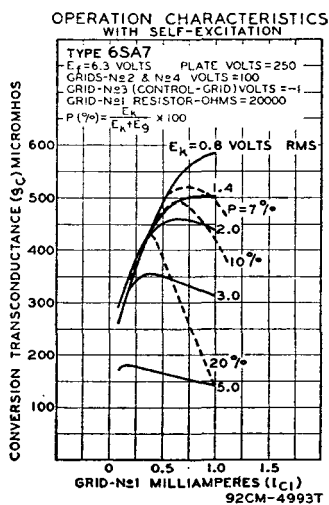
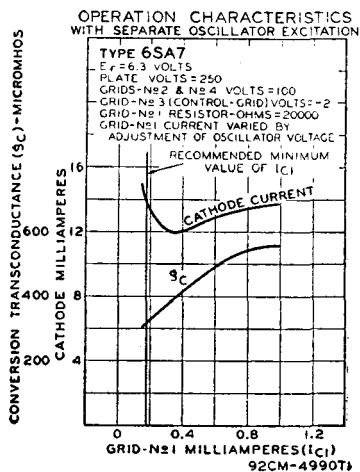

PENTAGRID CONVERTER

6SB7-Y

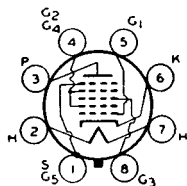

Metal type used as converter in superheterodyne circuits. Because of its high conversion and oscillator transconductance, it is especially useful in FM converter service in the 100-megacycle region. The 6SB7-Y has a micanol base which minimizes drift in oscillator frequency during warm-up period. For general discussion of pentagrid types, see Frequency Conversion in ELECTRON TUBE APPLICATIONS SECTION. Outline 3, OUTLINES SECTION. Tube requires octal socket and may be mounted in any position. For heater and cathode considerations, refer to type 6AV6.

HEATER VOLTAGE (AC/DC) .....	6.3	volts
HEATER CURRENT .....	0.3	ampere

Maximum Ratings: CONVERTER SERVICE

PLATE VOLTAGE .....	300 max	volts
GRIDS-NO.2-AND-NO.4 VOLTAGE .....	100 max	volts
GRIDS-NO.2-AND-NO.4 SUPPLY VOLTAGE .....	300 max	volts
PLATE DISSIPATION .....	2.0 max	watts
GRIDS-NO.2-AND-NO.4 INPUT .....	1.5 max	watts
TOTAL CATHODE CURRENT .....	22 max	ma
GRID-NO.3 VOLTAGE:		
Negative bias voltage .....	100 max	volts
Positive bias voltage .....	0 max	volts
PEAK HEATER-CATHODE VOLTAGE:		
Heater negative with respect to cathode .....	90 max	volts
Heater positive with respect to cathode .....	90 max	volts

Typical Operation (Separate Excitation):\*

Plate Voltage .....	100	250	volts
Grids-No.2-and-No.4 (Screen) Voltage .....	100	100	volts
Grid-No.3 (Control-Grid) Voltage .....	-1.0	-1.0	volt
Grid-No.1 (Oscillator Grid) Resistor .....	20000	20000	ohms
Plate Resistance (Approx.) .....	0.5	1.0	megohm
Conversion Transconductance .....	900	950	μmhos
Conversion Transconductance with grid-No.3 bias of -20 volts .....	3.5	3.5	μmhos
Plate Current .....	3.6	3.8	ma
Grids-No.2-and-No.4 Current .....	10.2	10	ma
Grid-No.1 Current .....	0.35	0.35	ma
Total Cathode Current .....	14.2	14.2	ma

\* The characteristics shown with separate excitation correspond very closely with those obtained in a self-excited oscillator circuit operating with zero bias.

Typical Operation in FM Band (88-108 Mc):

Plate Voltage .....	250	volts	
Grids-No.2-and-No.4 Supply Voltage .....	250	volts	
Grids-No.2-and-No.4 Resistor .....	12000	ohms	
Grid-No.1 Resistor .....	22000	ohms	
Signal Frequency .....	88	Mc	
Oscillation Frequency .....	98.7	118.7	Mc
Plate Current .....	6.8	6.5	ma
Grids-No.2-and-No.4 Current .....	12.6	12.5	ma
Grid-No.1 Current .....	0.130	0.140	ma

NOTE: The transconductance between grid No.1 and grids No.2 and No.4 connected to plate (not oscillating) is approximately 8000 μmhos under the following conditions: signal applied to grid No.1 at zero bias; grids No.2 and No.4 and plate at 100 volts; grid No.3 grounded. Under the same conditions, the plate current is 32 milliamperes and the amplification factor is 16.5.

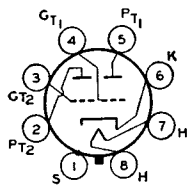

## HIGH-MU TWIN TRIODE

Metal type used as phase inverter or voltage amplifier in radio equipment. Except for common cathode, each triode is independent of the other. Outline 3, OUTLINES SECTION.

# 6SC7

Tube requires octal socket and may be mounted in any position. For heater and cathode considerations, refer to type 6AV6. For typical operation as a resistance-coupled amplifier, refer to Chart 17, RESISTANCE-COUPLED AMPLIFIER SECTION.

HEATER VOLTAGE (AC/DC) .....	6.3	volts
HEATER CURRENT .....	0.3	ampere
DIRECT INTERELECTRODE CAPACITANCES (Shell connected to cathode):*		
Grid to Plate .....	2	$\mu\text{f}$
Input .....	2	$\mu\text{f}$
Output .....	3	$\mu\text{f}$

\* Approximate values for each unit.

### Maximum Ratings:

### CLASS A<sub>1</sub> AMPLIFIER

PLATE VOLTAGE .....	250 max	volts
PEAK HEATER-CATHODE VOLTAGE:		
Heater negative with respect to cathode .....	90 max	volts
Heater positive with respect to cathode .....	90 max	volts

### Typical Operation (Each Unit):

Plate Voltage .....	250	volts
Grid Voltage .....	-2	volts
Amplification Factor .....	70	
Plate Resistance (Approx.) .....	53000	ohms
Transconductance (Approx.) .....	1325	$\mu\text{mhos}$
Plate Current .....	2	ma

AVERAGE PLATE CHARACTERISTICS  
EACH TRIODE UNIT

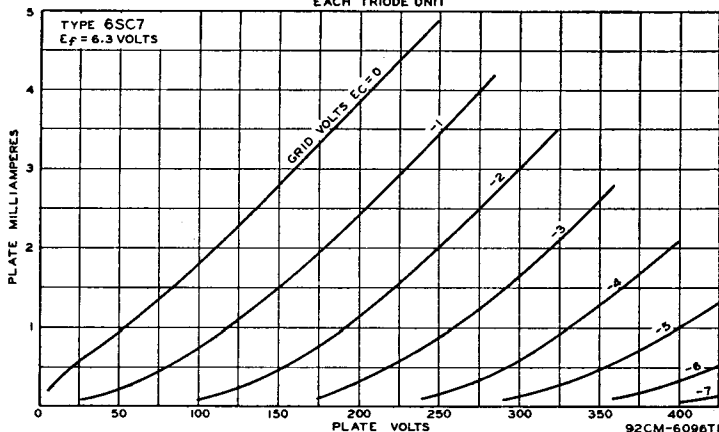

## HIGH-MU TRIODE

Metal type 6SF5 and glass-octal type 6SF5-GT are used in resistance-coupled amplifier circuits. Outlines 3 and 22, respectively, OUTLINES SECTION. Tubes require octal socket and may be mounted in any position. Characteristics, application, and references under type 6F5 apply to types 6SF5 and 6SF5-GT. Heater volts (ac/dc), 6.3; amperes, 0.3.

# 6SF5 6SF5-GT

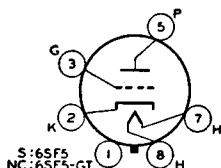

S: 6SF5  
NC: 6SF5-GT

**DIODE—  
REMOTE-CUTOFF PENTODE**

**6SF7**

Metal type used as combined rf or if amplifier and detector or avc tube in radio receivers. Also used as resistance-coupled af amplifier. Outline 3, OUTLINES SECTION. Tube requires octal socket and may be mounted in any position. For heater and cathode considerations, refer to type 6AV6. For typical operation as a resistance-coupled amplifier, refer to Chart 19, RESISTANCE-COUPLED AMPLIFIER SECTION.

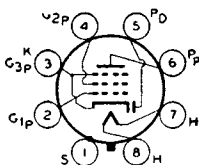

HEATER VOLTAGE (AC/DC) .....	6.3	volts
HEATER CURRENT .....	0.3	ampere
DIRECT INTERELECTRODE CAPACITANCES (Shell connected to cathode):		
Pentode Unit:		
Grid No. 1 to Plate .....	0.004 max	$\mu\text{f}$
Input .....	5.5	$\mu\text{f}$
Output .....	6.0	$\mu\text{f}$
Pentode Grid No.1 to Diode .....	0.002 max	$\mu\text{f}$
Pentode Plate to Diode .....	0.8	$\mu\text{f}$

**Maximum Ratings: PENTODE UNIT AS CLASS A<sub>1</sub> AMPLIFIER**

PLATE VOLTAGE .....	300 max	volts
GRID-NO.2 (SCREEN) VOLTAGE .....	100 max	volts
GRID-NO.2 SUPPLY VOLTAGE .....	300 max	volts
GRID-NO.1 (CONTROL-GRID) VOLTAGE, Positive Bias Value .....	0 max	volts
PLATE DISSIPATION .....	3.5 max	watts
GRID-NO.2 INPUT .....	0.5 max	watt
PEAK HEATER-CATHODE VOLTAGE:		
Heater negative with respect to cathode .....	90 max	volts
Heater positive with respect to cathode .....	90 max	volts

**Typical Operation:**

Plate Voltage .....	100	250	volts
Grid-No.2 Voltage .....	100	100	volts
Grid-No.1 Voltage .....	-1	-1	volt
Plate Resistance (Approx.) .....	0.2	0.7	megohm
Transconductance .....	1975	2050	$\mu\text{mhos}$
Grid-No.1 Bias (Approx.) for transconductance of 10 $\mu\text{mhos}$ ..	-35	-35	volts
Plate Current .....	12	12.4	ma
Grid-No. 2 Current .....	3.4	3.3	ma

**DIODE UNIT**

The diode plate is placed around the cathode, the sleeve of which is common to the pentode unit. For diode operation curves, refer to type 6SQ7.

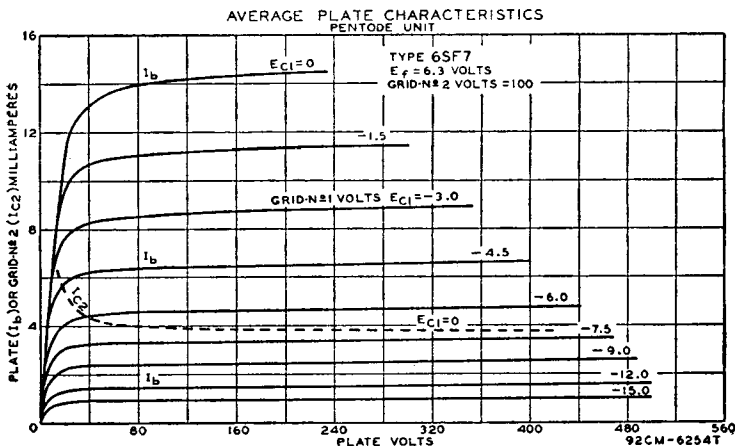

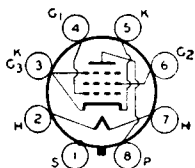

## REMOTE-CUTOFF PENTODE

# 6SG7

Metal type used as rf amplifier in high-frequency and wide-band applications. Features high transconductance with low grid-No.1-to-plate capacitance. Suitable for frequencies up to 18 megacycles per second (approx.). Two separate cathode terminals enable the input and output circuits to be effectively isolated from each other. Outline 3, **OUTLINES SECTION**. Tube requires octal socket and may be mounted in any position. For heater and cathode considerations, refer to type 6AV6.

HEATER VOLTAGE (AC/DC) .....	6.3	volts
HEATER CURRENT .....	0.3	ampere
DIRECT INTERELECTRODE CAPACITANCES (Shell connected to cathode):		
Grid No.1 to Plate .....	0.003 <i>max</i>	$\mu\text{f}$
Input .....	8.5	$\mu\text{f}$
Output .....	7.0	$\mu\text{f}$

### CLASS A<sub>1</sub> AMPLIFIER

**Maximum Ratings:**

PLATE VOLTAGE .....	300 <i>max</i>	volts
GRID-NO.2 (SCREEN) VOLTAGE .....	200 <i>max</i>	volts
GRID-NO.2 SUPPLY VOLTAGE .....	300 <i>max</i>	volts
GRID-NO.1 (CONTROL-GRID) VOLTAGE, Positive Bias Value .....	0 <i>max</i>	volts
PLATE DISSIPATION .....	3 <i>max</i>	watts
GRID-NO.2 INPUT .....	0.6 <i>max</i>	watt
<b>PEAK HEATER-CATHODE VOLTAGE:</b>		
Heater negative with respect to cathode .....	90 <i>max</i>	volts
Heater positive with respect to cathode .....	90 <i>max</i>	volts

**Typical Operation:**

Plate Voltage .....	100	250	250	volts
Grid-No.2 Voltage .....	100	125	150	volts
Grid-No.1 Voltage .....	-1	-1	-2.5	volts
Grid No.3 (Suppressor) .....	Connected to pin No. 3 internally			
Plate Resistance (Approx.) .....	0.25	0.9	+	megohm
Transconductance .....	4100	4700	4000	$\mu\text{mhos}$
Grid-No.1 Bias (Approx.) for transconductance of 40 $\mu\text{mhos}$ .....	-11.5	-14	-17.5	volts
Plate Current .....	8.2	11.8	9.2	ma
Grid-No.2 Current .....	3.2	4.4	3.4	ma
+ Greater than 1 megohm.				

AVERAGE PLATE CHARACTERISTICS

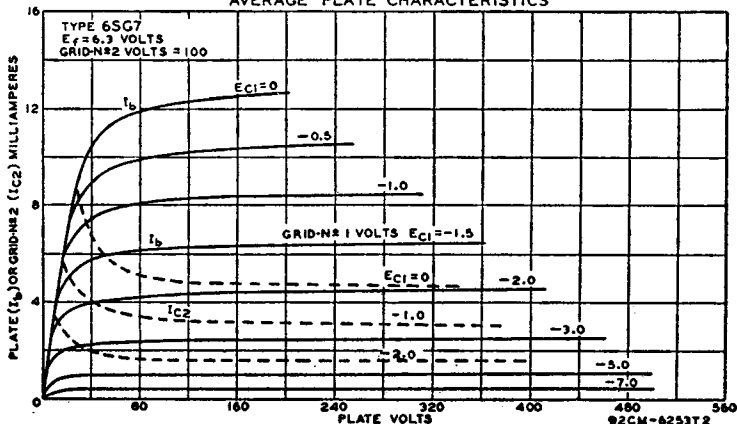

SHARP-CUTOFF PENTODE

6SH7

Metal type used as rf amplifier in high-frequency, wide-band applications and as a limiter tube in FM equipment. Similar electrically to miniature type 6AU6. It features high

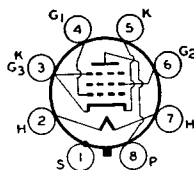

transconductance and low grid-No.1-to-plate capacitance. Outline 3, OUTLINES SECTION. Tube requires octal socket and may be mounted in any position. Two separate cathode terminals enable the input and output circuits to be isolated effectively from each other. This type is not recommended for high-gain, audio-amplifier applications because undesirable hum may be encountered. For heater and cathode considerations, refer to type 6AV6. For typical operation as a resistance-coupled amplifier, refer to Chart 8, RESISTANCE-COUPLED AMPLIFIER SECTION.

HEATER VOLTAGE (AC/DC) .....	6.3	volts
HEATER CURRENT .....	0.3	ampere
DIRECT INTERELECTRODE CAPACITANCES (Shell connected to cathode):		
Grid No.1 to Plate .....	0.003 max	$\mu\text{f}$
Input .....	8.5	$\mu\text{f}$
Output .....	7.0	$\mu\text{f}$

Maximum Ratings:

CLASS A<sub>1</sub> AMPLIFIER

PLATE VOLTAGE .....	300 max	volts
GRID-NO.2 (SCREEN) VOLTAGE .....	150 max	volts
GRID-NO.2 SUPPLY VOLTAGE .....	300 max	volts
PLATE DISSIPATION .....	3 max	watts
GRID-NO.2 INPUT .....	0.7 max	watt
GRID-NO.1 (CONTROL-GRID) VOLTAGE, Positive Bias Value .....	0 max	volts
PEAK HEATER-CATHODE VOLTAGE:		
Heater negative with respect to cathode .....	90 max	volts
Heater positive with respect to cathode .....	90 max	volts

Typical Operation:

Plate Voltage .....	100	250	volts
Grid-No.2 Voltage .....	100	150	volts
Grid-No.1 Voltage .....	-1	-1	volt
Plate Resistance (Approx.) .....	0.35	0.9	megohm
Transconductance .....	4000	4900	$\mu\text{mhos}$
Grid-No.1 Bias for plate current of 10 $\mu\text{a}$ .....	-4.0	-5.5	volts
Plate Current .....	5.3	10.8	ma
Grid-No.2 Current .....	2.1	4.1	ma

AVERAGE PLATE CHARACTERISTICS

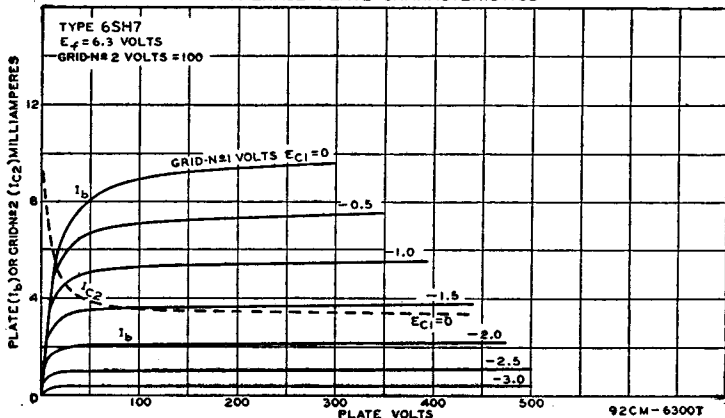



## SHARP-CUTOFF PENTODE

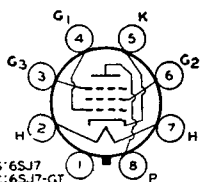

Metal type 6SJ7 and glass-octal type 6SJ7-GT are used as rf amplifiers and biased detectors. As a detector, either type is capable of delivering large audio-frequency output voltage with relatively small input voltage.

# 6SJ7 6SJ7-GT

HEATER VOLTAGE (AC/DC).....	6.3	volts
HEATER CURRENT.....	0.3	ampere
DIRECT INTERELECTRODE CAPACITANCES: <sup>o</sup>		
Pentode Connection:		
Grid No.1 to Plate.....	0.005 max	0.005 max    μf
Input.....	6.0	7.0    μf
Output.....	7.0	7.0    μf
Triode Connection:†		
Grid No.1 to Plate.....	2.8	2.8    μf
Input.....	3.4	3.4    μf
Output.....	11	11    μf

<sup>o</sup> With shell or external shield connected to cathode.

† With grids No.2 and No.3 connected to plate.

### CLASS A<sub>1</sub> AMPLIFIER

#### Maximum Ratings:

	Triode Connection	Pentode Connection	
PLATE VOLTAGE.....	250 max	300 max	volts
GRID-NO.2 (SCREEN) VOLTAGE.....	-	125 max	volts
GRID-NO.2 SUPPLY VOLTAGE.....	-	300 max	volts
GRID-NO.1 (CONTROL-GRID) VOLTAGE, Positive Bias Value.....	0 max	0 max	volts
PLATE DISSIPATION.....	2.5 max	2.5 max	watts
GRID-NO.2 INPUT.....	-	0.70 max	watt
PEAK HEATER-CATHODE VOLTAGE:			
Heater negative with respect to cathode.....	90 max	90 max	volts
Heater positive with respect to cathode.....	90 max	90 max	volts

#### Typical Operation:

	Triode Connection		Pentode Connection		
Plate Voltage.....	180	250	100	250	volts
Grid-No.2 Voltage.....	*	*	100	100	volts
Grid-No.1 Voltage.....	-6	-8.5	-3	-3	volts
Grid No.3 (Suppressor).....	*	*	Connected to cathode at socket		
Amplification Factor.....	19	19	-	-	
Plate Resistance.....	8250	7600	70000	†	ohms
Transconductance.....	2300	2500	1575	1650	μmhos
Grid-No.1 Bias for plate current of 10 μa.....	-	-	-8	-8	volts
Plate Current.....	6.0	9.2	2.9	3.0	ma
Grid-No.2 Current.....	-	-	0.9	0.8	ma

\* Grids No.2 and No.3 connected to plate.

† Greater than 1 megohm.

## INSTALLATION AND APPLICATION

Types 6SJ7 and 6SJ7-GT require octal socket and may be mounted in any position. Outlines 3 and 24, respectively, OUTLINES SECTION. For heater and cathode considerations, refer to type 6AV6.

As a class A<sub>1</sub> amplifier, the 6SJ7 or 6SJ7-GT may be operated either as a pentode or as a triode, as shown under tabulated data. The grid-No.2 voltage for the 6SJ7 operated as a pentode may be obtained from a potentiometer or bleeder circuit across the B-supply device. Due to the grid-No.2-current characteristics of the 6SJ7, a resistor in series with the high-voltage supply may be employed for obtaining the grid-No.2 voltage, provided the cathode-resistor method of bias control is used. This method, however, is not recommended if the high-voltage B-supply exceeds 300 volts.

As a radio-frequency amplifier, the 6SJ7 or 6SJ7-GT may be used particularly in applications where the rf signal applied to grid No.1 is relatively low, that is, of the order of a few volts. In such cases either grid-No.2 or grid-No.1 voltage (or both) may be varied to control the receiver volume. When larger signals are involved, a remote-cutoff amplifier tube should be employed to prevent the occurrence of excessive cross-modulation and modulation-distortion.

As an audio-frequency amplifier in resistance-coupled circuits, the 6SJ7 or 6SJ7-GT may be operated under conditions shown in Chart 20, RESISTANCE-COUPLED AMPLIFIER SECTION.

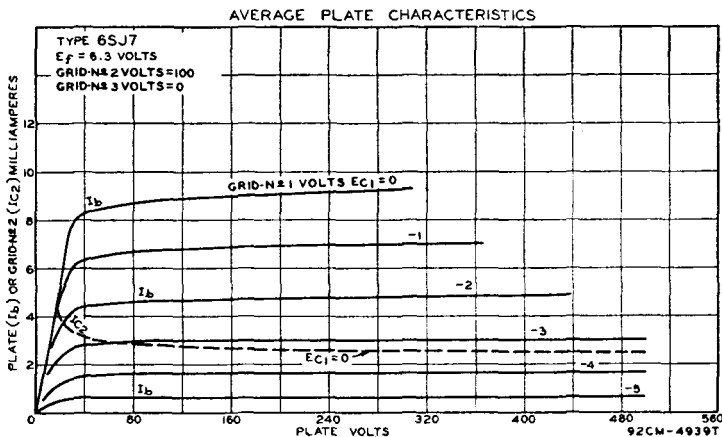

**6SK7**  
**6SK7-GT**

**REMOTE-CUTOFF PENTODE**

Metal type 6SK7 and glass-octal type 6SK7-GT are used as rf or if amplifiers in radio receivers. They feature single-ended construction and interlead shields. Because of remote-cutoff

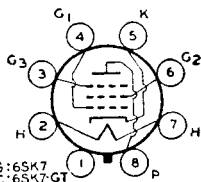

characteristic, these types are able to handle large signal voltages without cross-modulation or modulation-distortion and are often used in receivers with avc.

HEATER VOLTAGE (AC/DC).....	6.3	volts
HEATER CURRENT.....	0.3	ampere
DIRECT INTERELECTRODE CAPACITANCES:		
Grid No.1 to Plate.....	0.003 max	0.005 max
Input.....	6.0	6.5
Output.....	7.0	7.5
		$\mu\mu\text{f}$
		$\mu\mu\text{f}$

\* With shell connected to cathode.

\*\* With external shield connected to cathode.

**Maximum Ratings:**

**CLASS A<sub>1</sub> AMPLIFIER**

PLATE VOLTAGE.....	300 max	volts
GRID-NO.2 (SCREEN) VOLTAGE.....	125 max	volts
GRID-NO.2 SUPPLY VOLTAGE.....	300 max	volts
GRID-NO.1 (CONTROL-GRID) VOLTAGE, Positive Bias Value.....	0 max	volts
PLATE DISSIPATION.....	4.0 max	watts
GRID-NO.2 INPUT.....	0.4 max	watt
PEAK HEATER-CATHODE VOLTAGE:		
Heater negative with respect to cathode.....	90 max	volts
Heater positive with respect to cathode.....	90 max	volts

### Typical Operation:

Plate Voltage.....	100	250	volts
Grid-No.2 Voltage.....	100	100	volts
Grid-No.1 Voltage.....	-1	-3	volts
Grid No.3 (Suppressor).....	Connected to cathode at socket		
Plate Resistance (Approx.).....	0.12	0.8	megohm
Transconductance.....	2350	2000	$\mu$ mhos
Grid-No.1 Bias for transconductance of 10 $\mu$ mhos.....	-35	-35	volts
Plate Current.....	13	9.2	ma
Grid-No.2 Current.....	4.0	2.6	ma

## INSTALLATION AND APPLICATION

Types 6SK7 and 6SK7-GT require octal socket and may be mounted in any position. Outlines 3 and 24, respectively, OUTLINES SECTION. For heater and cathode considerations, refer to type 6AV6.

The interlead shielding within the base of the 6SK7 and other types employing this construction is accomplished by means of a conical stem shield and a cylindrical base shield. The metal cone is inserted through the hole in the stem where the exhaust tube connects. The cone extends some distance into the exhaust tube and is connected to the common grounding pin (pin No.1). The cylindrical base shield is positioned inside the locating base plug, and is also connected to pin No.1. The conical shield reduces the capacitance between leads in the glass of the stem: the cylindrical shield reduces the capacitance between those pins that are diametrically opposite each other. Since the grid-No.1 and the plate leads are diametrically opposite, the capacitance between them is kept to a value comparable with that obtainable with top-cap construction.

Control-grid bias variation will be found effective in changing the volume of the receiver. In order to obtain adequate volume control, an available grid-bias voltage of approximately 50 volts will be required. The exact value will depend upon the circuit design and operating conditions. This voltage may be obtained, depending on the receiver requirements, from a potentiometer across a fixed supply voltage, from a variable cathode-bias resistor, from the avc system, or from a combination of these methods.

The grid-No.2 (screen) voltage may be obtained from a potentiometer or bleeder circuit across the B-supply source, or through a dropping resistor from the plate supply. The use of series resistors for obtaining satisfactory control of grid-No.2 voltage in the case of four-electrode tubes is usually impossible because of secondary-emission phenomena. In the 6SK7, however, because grid No.3 practically removes these effects, it is possible to obtain grid-No.2 voltage through a series-dropping resistor from the plate supply or from some high intermediate voltage, providing these sources do not exceed the plate-supply voltage. With this method, the grid-No.2-to-cathode voltage will fall off very little from minimum to maximum value of the resistor controlling cathode bias. In some cases, it may actually rise. This rise of grid-No.2-to-cathode voltage above the normal maximum value is allowable because both the grid-No.2 current and the plate current are reduced simultaneously by a sufficient amount to prevent damage to the tube. It

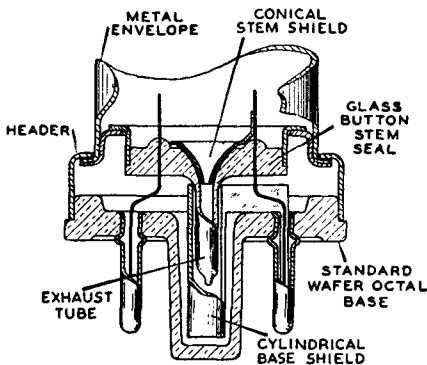

should be recognized that, in general, the series-resistor method of obtaining grid-No.2 voltage from a higher voltage supply necessitates the use of the variable cathode-resistor method of controlling volume in order to prevent too high a voltage on grid No.2. When grid-No.2 and control-grid voltage are obtained in this manner, the remote "cutoff" advantage of the 6SK7 and 6SK7-GT can be fully realized. However, it should be noted that the use of a resistor in the grid-No.2 circuit will have an effect on the change in plate resistance with variation in grid-No.3 (suppressor) voltage in case grid No.3 is utilized for control purposes.

**Grid No.3 (suppressor)** may be connected directly to the cathode or it may be made negative with respect to the cathode. For the latter condition, the grid-No.3 voltage may be obtained from a potentiometer or bleeder circuit, or from the avc system.

For circuits employing the 6SK7, refer to the **CIRCUIT SECTION**.

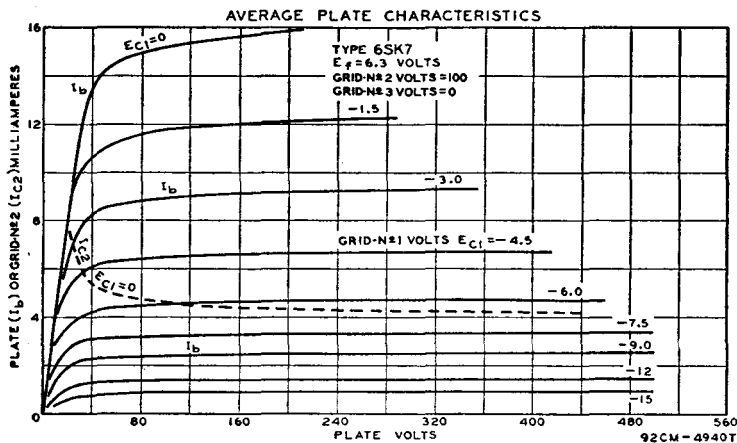

## HIGH-MU TWIN TRIODE

Glass octal type used as phase inverter or resistance-coupled amplifier in radio equipment. Outline 22, **OUTLINES SECTION**. Tube requires octal socket and may be mounted in

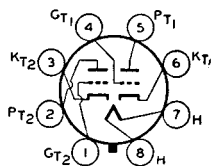

## 6SL7-GT

any position. Except for the common heater, each triode unit is independent of the other. For typical operation as phase inverter or resistance-coupled amplifier, refer to Chart 7, **RESISTANCE-COUPLED AMPLIFIER SECTION**. For heater and cathode considerations, refer to type 6AV6.

HEATER VOLTAGE (AC/DC).....	6.3	volts
HEATER CURRENT.....	0.3	ampere

**DIRECT INTERELECTRODE CAPACITANCES (Approx.):°**

	Triode Unit $T_1$	Triode Unit $T_2$	
Grid to Plate.....	2.8	2.8	$\mu f$
Input.....	3.0	3.4	$\mu f$
Output.....	3.8	3.2	$\mu f$

° With close-fitting shield connected to cathode.

**Maximum Ratings:**
**CLASS A<sub>1</sub> AMPLIFIER (Each Unit)**

PLATE VOLTAGE.....	300 <i>max</i>	volts
GRID VOLTAGE, Positive Bias Value.....	0 <i>max</i>	volts
PLATE DISSIPATION.....	1 <i>max</i>	watt
<b>PEAK HEATER-CATHODE VOLTAGE:</b>		
Heater negative with respect to cathode.....	90 <i>max</i>	volts
Heater positive with respect to cathode.....	90 <i>max</i>	volts

**Typical Operation:**

Plate Voltage.....	250	volts
Grid Voltage.....	-2	volts
Amplification Factor.....	70	
Plate Resistance.....	44000	ohms
Transconductance.....	1600	$\mu$ mhos
Plate Current.....	2.3	ma

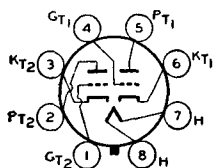
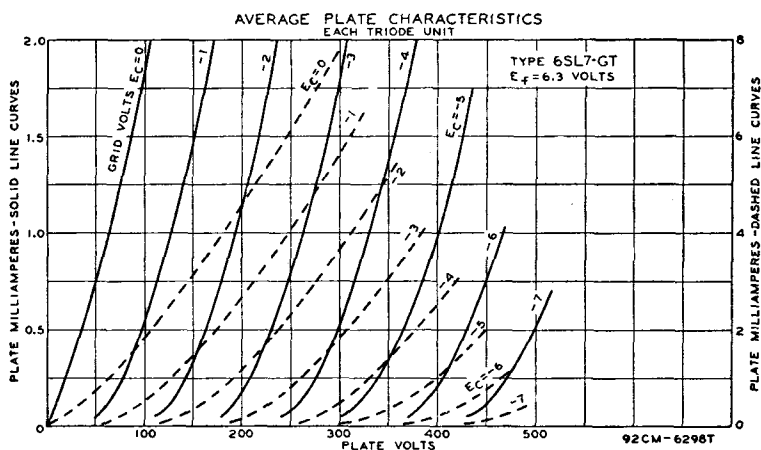

## MEDIUM-MU TWIN TRIODE

# 6SN7-GT

Glass octal type used as phase inverter or resistance-coupled amplifier in radio equipment. Outline 22, OUTLINES SECTION. Tube requires octal socket and may be mounted in

any position. Each triode unit is independent of the other except for the common heater. The peak heater-cathode voltage rating is 200 *max* volts with heater either positive or negative with respect to cathode. For other maximum ratings, typical operation, and curves for each triode unit, refer to type 6J5. For typical operation as phase inverter or resistance-coupled amplifier, refer to Chart 13, RESISTANCE-COUPLED AMPLIFIER SECTION. For heater and cathode considerations, refer to type 6AQ5.

HEATER VOLTAGE (AC/DC).....	6.3	volts
HEATER CURRENT.....	0.6	ampere

DIRECT INTERELECTRODE CAPACITANCES (Approx. With no external shield):

	Triode Unit T <sub>1</sub>	Triode Unit T <sub>2</sub>	
Grid to Plate.....	3.8	4.0	$\mu$ f
Input.....	2.8	3.0	$\mu$ f
Output.....	0.8	1.2	$\mu$ f

# 6SQ7 6SQ7-GT

## TWIN DIODE—HIGH-MU TRIODE

Metal type 6SQ7 and glass-octal type 6SQ7-GT used as combined detector, amplifier, and avc tube in radio receivers. These types are similar electrically to type 6Q7 in many respects, but they have a higher-mu triode.

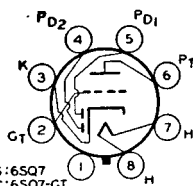

S: 6SQ7  
BC: 6SQ7-GT

HEATER VOLTAGE (AC/DC).....	6.3	volts
HEATER CURRENT.....	0.3	ampere

DIRECT INTERELECTRODE CAPACITANCES (Approx.):		6SQ7 <sup>o</sup>	6SQ7-GT <sup>oo</sup>	
Triode Grid to Triode Plate.....	1.6	1.8		$\mu\mu\text{f}$
Triode Input.....	3.2	4.2		$\mu\mu\text{f}$
Triode Output.....	3.0	3.4		$\mu\mu\text{f}$
Diode Input (Each Unit).....	0.4	1.8		$\mu\mu\text{f}$
Triode Grid to Plate of Diode Unit No.1.....	0.03	0.1 <i>max</i>		$\mu\mu\text{f}$

<sup>o</sup> With shell connected to cathode. <sup>oo</sup> With no external shield.

### Maximum Ratings: TRIODE UNIT AS CLASS A<sub>1</sub> AMPLIFIER

PLATE VOLTAGE.....	300 <i>max</i>	volts
GRID VOLTAGE, Positive Bias Value.....	0 <i>max</i>	volts
PLATE DISSIPATION.....	0.5 <i>max</i>	watt
PEAK HEATER-CATHODE VOLTAGE:		
Heater negative with respect to cathode.....	90 <i>max</i>	volts
Heater positive with respect to cathode.....	90 <i>max</i>	volts

### Characteristics:

Plate Voltage.....	100	250	volts
Grid Voltage.....	-1	-2	volts
Amplification Factor.....	100	100	
Plate Resistance.....	110000	85000	ohms
Transconductance.....	925	1175	$\mu\text{mhos}$
Plate Current.....	0.5	1.1	ma

### Maximum Rating: DIODE UNITS

PLATE CURRENT (Each Unit).....	1.0 <i>max</i>	ma
--------------------------------	----------------	----

Two diode plates are placed around a cathode, the sleeve of which is common to the triode unit. Each diode plate has its own base pin. Diode operation curves are given below.

AVERAGE DIODE CHARACTERISTICS  
HALF-WAVE RECTIFICATION—SINGLE DIODE UNIT

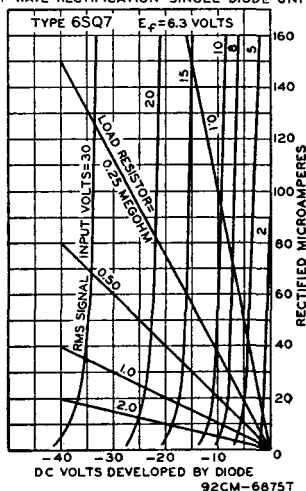

## INSTALLATION AND APPLICATION

Types 6SQ7 and 6SQ7-GT require octal socket and may be mounted in any position. Outlines 3 and 24, respectively, OUTLINES SECTION. For heater and cathode considerations, refer to type 6AV6.

The triode unit of the 6SQ7 and 6SQ7-GT is recommended for use only in resistance-coupled circuits; refer to Chart 4, RESISTANCE-COUPLED AMPLIFIER SECTION. Diode-biasing of the triode unit is not suitable because of the probability of triode plate-current cutoff even with relatively small signal voltages applied to the diode circuit.

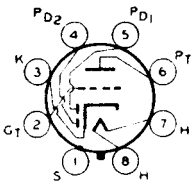
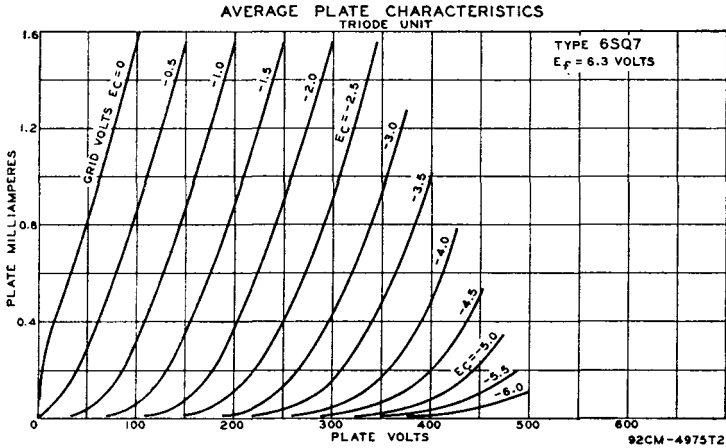

## TWIN DIODE— MEDIUM-MU TRIODE

Metal type used as combined detector, amplifier, and avc tube. It is equivalent in performance to miniature type 6BF6. Outline 3, OUTLINES SECTION. Tube requires octal socket

# 6SR7

and may be mounted in any position. For typical operation as a resistance-coupled amplifier, refer to Chart 9, RESISTANCE-COUPLED AMPLIFIER SECTION. For heater and cathode considerations, refer to type 6AV6.

HEATER VOLTAGE (AC/DC).....	6.3	volts
HEATER CURRENT.....	0.3	ampere
DIRECT INTERELECTRODE CAPACITANCES—Triode Unit:*		
Grid to Plate.....	2.4	$\mu\mu\text{f}$
Input.....	3.0	$\mu\mu\text{f}$
Output.....	2.8	$\mu\mu\text{f}$

\* Shell connected to cathode. Values are approximate.

<b>Maximum Ratings:</b>		
<b>TRIODE UNIT AS CLASS A<sub>1</sub> AMPLIFIER</b>		
PLATE VOLTAGE.....	250 <i>max</i>	volts
PLATE DISSIPATION.....	2.5 <i>max</i>	watts
PEAK HEATER-CATHODE VOLTAGE:		
Heater negative with respect to cathode.....	90 <i>max</i>	volts
Heater positive with respect to cathode.....	90 <i>max</i>	volts

<b>Typical Operation with Transformer Coupling:</b>		
Plate Voltage.....	250	volts
Grid Voltage.....	-9	volts
Amplification Factor.....	16	
Plate Resistance.....	8500	ohms
Transconductance.....	1900	$\mu\text{mhos}$
Plate Current.....	9.5	ma
Load Resistance.....	10000	ohms
Power Output.....	300	mw

### DIODE UNITS

Two diode plates are placed around a cathode, the sleeve of which is common to the triode unit. Each diode plate has its own base pin. For diode operation curves, refer to type 6SQ7.

REMOTE-CUTOFF PENTODE

6SS7

Metal type used in rf or if stages of radio receivers particularly those employing avc. Outline 3, OUTLINES SECTION. Tube requires octal socket and may be mounted in any position. For heater and cathode considerations, refer to type 6AV6.

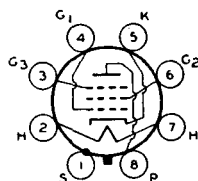

HEATER VOLTAGE (AC/DC).....	6.3	volts
HEATER CURRENT.....	0.15	ampere
DIRECT INTERELECTRODE CAPACITANCES (Approx.):*		
Grid No.1 to Plate.....	0.004 max	$\mu\mu\text{f}$
Input.....	5.5	$\mu\mu\text{f}$
Output.....	7.0	$\mu\mu\text{f}$

\* With shell connected to cathode.

CLASS A<sub>1</sub> AMPLIFIER

Maximum Ratings:

PLATE VOLTAGE.....	300 max	volts
GRID-NO.2 (SCREEN) VOLTAGE.....	100 max	volts
GRID-NO.2 SUPPLY VOLTAGE.....	300 max	volts
GRID-NO.1 (CONTROL-GRID) VOLTAGE, Positive Bias Value.....	0 max	volts
PLATE DISSIPATION.....	2.25 max	watts
GRID-NO.2 INPUT.....	0.35 max	watt
PEAK HEATER-CATHODE VOLTAGE:		
Heater negative with respect to cathode.....	90 max	volts
Heater positive with respect to cathode.....	90 max	volts

Typical Operation:

Plate Voltage.....	100	250	volts
Grid-No.2 Voltage.....	100	100	volts
Grid-No.1 Voltage.....	-1	-3	volts
Grid No.3 (Suppressor).....	Connected to cathode at socket		
Plate Resistance (Approx.).....	0.12	1	megohm
Transconductance.....	1930	1850	$\mu\text{mhos}$
Grid-No.1 Bias for transconductance of 10 $\mu\text{mhos}$ .....	-35	-35	volts
Plate Current.....	12.2	9	ma
Grid-No.2 Current.....	3.1	2	ma

TWIN DIODE—MEDIUM-MU TRIODE

6ST7

Metal type used as combined detector, amplifier, and avc tube. Within maximum ratings this type is electrically identical to type 6BF6 except for interelectrode capacitances and heater current. Outline 3, OUTLINES SECTION. Tube requires octal socket and may be mounted in any position. Heater volts (ac/dc), 6.3; amperes, 0.15. Maximum ratings of triode

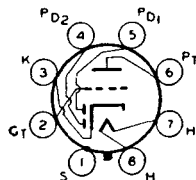

unit as class A<sub>1</sub> amplifier: plate volts, 250 max; plate dissipation, 2.5 max watts. For diode operation curves, refer to type 6SQ7.

TWIN DIODE—HIGH-MU TRIODE

6SZ7

Metal type used as combined detector, amplifier, and avc tube in radio receivers. Except for heater-current rating and interelectrode capacitances, this type is essentially the same electrically as type 6AT6. Outline 3, OUTLINES SECTION. Tube requires octal socket and may be mounted in any position. Heater volts (ac/dc), 6.3; amperes, 0.15. Direct interelectrode capacitances of triode unit (shell connected to cathode): grid to plate, 1.1  $\mu\mu\text{f}$ ; input, 2.4  $\mu\mu\text{f}$ ; output, 2.8  $\mu\mu\text{f}$ . For diode operation curves, refer to type 6SQ7.

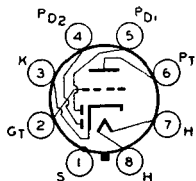



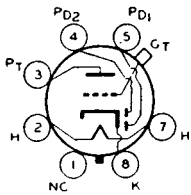

**TWIN DIODE—HIGH-MU TRIODE**

**6T7-G**

Glass octal type used as combined detector, amplifier, and avc tube in radio receivers. Outline 33, OUTLINES SECTION. For heater and cathode considerations, refer to type 6AV6. Heater volts (ac/dc), 6.3; amperes, 0.15. Refer to Chart 7, RESISTANCE-COUPLED AMPLIFIER SECTION for typical operation as a resistance-coupled amplifier. Typical operation as class A<sub>1</sub> amplifier: plate volts, 250 max; grid volts, -3; plate ma., 1.2; plate resistance, 62000 ohms; amplification factor, 65; transconductance, 1050  $\mu$ hos. For diode operation curves, refer to type 6SQ7. Type 6T7-G is used principally for renewal purposes.

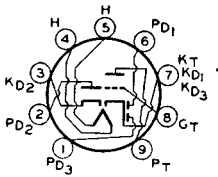

**TRIPLE DIODE—HIGH-MU TRIODE**

**6T8**

Miniature type used as combined audio amplifier, AM detector, and FM detector in AM/FM radio receivers. Diode unit No.1 is used for AM detection, and diode units No.2 and No.3 are used for FM detection. Outline 13, OUTLINES SECTION. Tube requires noval nine-contact socket and may be mounted in any position. For typical operation as a resistance-coupled amplifier, refer to Chart 7, RESISTANCE-COUPLED AMPLIFIER SECTION. For heater and cathode considerations, refer to type 6AQ5.

HEATER VOLTAGE (AC/DC) .....	6.3	volts
HEATER CURRENT .....	0.45	ampere
DIRECT INTERELECTRODE CAPACITANCES:*		
Triode Grid to Triode Plate .....	2.2	$\mu$ f
Triode Input .....	1.6	$\mu$ f
Triode Output .....	1.0	$\mu$ f
Diode-No.1 Plate to Cathode and Heater .....	3.8	$\mu$ f
Diode-No.2 Plate to Cathode and Heater .....	4.5	$\mu$ f
Diode-No.3 Plate to Cathode and Heater .....	3.8	$\mu$ f
Diode-No.2 Cathode to All Other Electrodes .....	8.5	$\mu$ f
Triode Grid to Any Diode Plate .....	0.035 max	$\mu$ f

\*No external shield. Approximate values.

**TRIODE UNIT AS CLASS A<sub>1</sub> AMPLIFIER**

**Maximum Ratings:**

PLATE VOLTAGE .....	300 max	volts
GRID VOLTAGE, Positive Bias Value .....	0 max	volts
PLATE DISSIPATION .....	1 max	watt
PEAK HEATER-CATHODE VOLTAGE:		
Heater negative with respect to cathode .....	90 max	volts
Heater positive with respect to cathode .....	90 max	volts

**Characteristics:**

Plate Voltage .....	100	250	volts
Grid Voltage .....	-1	-3	volts
Amplification Factor .....	70	70	
Plate Resistance .....	54000	58000	ohms
Transconductance .....	1300	1200	$\mu$ hos
Plate Current .....	0.8	1.0	ma

**DIODE UNITS**

**Maximum Rating:**

PLATE CURRENT (Each Unit) .....	5 max	ma
---------------------------------	-------	----

Diode units No.1 and No.3 have a common cathode. Diode unit No.2 has a separate cathode.

## AVERAGE PLATE CHARACTERISTICS

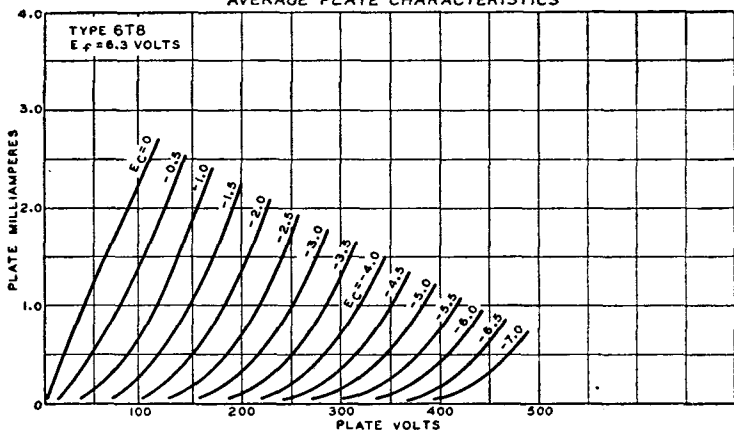

92CM-7063T

## 6U5

### ELECTRON-RAY TUBE

Glass type used to indicate visually, by means of a fluorescent target, the effects of a change in a controlling voltage. It is used as a convenient, non-mechanical means of indicating

accurate radio-receiver tuning. Outline 30, OUTLINES SECTION. Tube requires six-contact socket and may be mounted in any position. For heater and cathode considerations, refer to type 6AV6. Type 6U5 has a remote plate-current cutoff characteristic. For a discussion of electron-ray tube considerations, refer to ELECTRON TUBE APPLICATION SECTION.

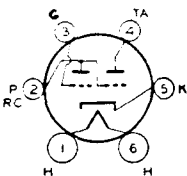

HEATER VOLTAGE (AC/DC) .....	6.3	volts
HEATER CURRENT .....	0.3	ampere

#### Maximum Ratings:

#### INDICATOR SERVICE

PLATE-SUPPLY VOLTAGE .....	285 max	volts
TARGET VOLTAGE .....	{ 285 max	volts
	{ 125 min	volts
PLATE DISSIPATION .....	1 max	watt
PEAK HEATER-CATHODE VOLTAGE:		
Heater negative with respect to cathode .....	90 max	volts
Heater positive with respect to cathode .....	90 max	volts

#### Typical Operation:

Plate- and Target-Supply Voltage .....	200	250	volts
Series Triode-Plate Resistor .....	1	1	megohm
Target Current (For zero grid voltage) .....	3.0	4.0	ma
Triode Plate Current (For zero grid voltage) .....	0.19	0.24	ma
Triode Grid Voltage (Approx. for 0° shadow angle) .....	-18.5	-22	volts
Triode Grid Voltage (Approx. for 90° shadow angle) .....	0	0	volts

### REMOTE-CUTOFF PENTODE

Glass octal type used in rf and if stages of radio receivers employing avc. It is also used as a mixer in superheterodyne circuits. Outline 37, OUTLINES SECTION. Tube requires octal socket. Refer to type 6SK7 for general application information. Heater volts (ac/dc), 6.3; amperes, 0.3. This type is used principally for renewal purposes. Maximum ratings as class A1

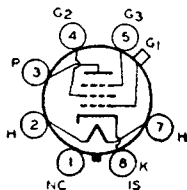

## 6U7-G

amplifier: plate volts, 300; grid-No.2 (screen) volts, 100; grid-No.2 supply volts, 300; grid-No.1 (control-grid) volts, 0 min; plate dissipation, 2.25 watts; grid-No.2 input, 0.25 watt.

**Typical Operation:**

Plate Voltage.....	100	250	volts
Grid-No.2 Voltage.....	100	100	volts
Grid-No.1 Voltage.....	-3	-3	volts
Grid No.3 (Suppressor).....	Connected to cathode at socket		
Plate Resistance (Approx.).....	0.25	0.8	megohm
Transconductance.....	1500	1600	$\mu$ mhos
Grid-No.1 Bias for transconductance of 2 $\mu$ mhos.....	-50	-50	volts
Plate Current.....	8	8.2	ma
Grid-No.2 Current.....	2.2	2	ma

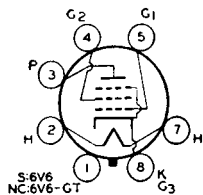

## BEAM POWER AMPLIFIER

# 6V6 6V6-GT

Metal type 6V6 and glass-octal type 6V6-GT are used as output amplifiers in automobile, battery-operated, and other receivers in which reduced plate-current drain is desirable. Out-

lines 6 and 22, respectively, **OUTLINES SECTION**. Tubes require octal socket and may be mounted in any position. The 6V6 and 6V6-GT are equivalent in performance to type 6AQ5. Refer to type 6AQ5 for heater and cathode considerations, application information, and characteristic curves.

HEATER VOLTAGE (AC/DC).....	6.3	volts	
HEATER CURRENT.....	0.45	ampere	
DIRECT INTERELECTRODE CAPACITANCES (Approx.):	6V6 <sup>o</sup>	6V6-GT <sup>oo</sup>	
Grid No.1 to Plate.....	0.3	0.7	$\mu$ f
Input.....	10	9.0	$\mu$ f
Output.....	11	7.5	$\mu$ f

<sup>o</sup> With shell connected to cathode.      <sup>oo</sup> With no external shield.

### Maximum Ratings: SINGLE-TUBE CLASS A<sub>1</sub> AMPLIFIER

PLATE VOLTAGE.....	315 <i>max</i>	volts
GRID-NO.2 (SCREEN) VOLTAGE.....	285 <i>max</i>	volts
PLATE DISSIPATION.....	12 <i>max</i>	watts
GRID-NO.2 INPUT.....	2 <i>max</i>	watts
PEAK HEATER-CATHODE VOLTAGE:		
Heater negative with respect to cathode.....	90 <i>max</i>	volts
Heater positive with respect to cathode.....	90 <i>max</i>	volts

**Typical Operation:**

Plate Voltage.....	180	250	315	volts
Grid-No.2 Voltage.....	180	250	225	volts
Grid-No.1 (Control-Grid) Voltage.....	-8.5	-12.5	-13	volts
Peak AF Grid-No.1 Voltage.....	8.5	12.5	13	volts
Zero-Signal Plate Current.....	29	45	34	ma
Maximum-Signal Plate Current.....	30	47	35	ma
Zero-Signal Grid-No.2 Current (Approx.).....	3	4.5	2.2	ma
Maximum-Signal Grid-No.2 Current (Approx.).....	4	7	6	ma
Plate Resistance.....	50000	50000	80000	ohms
Transconductance.....	3700	4100	3750	$\mu$ mhos
Load Resistance.....	5500	5000	8500	ohms
Total Harmonic Distortion.....	8	8	12	per cent
Maximum-Signal Power Output.....	2	4.5	5.5	watts

### Maximum Ratings: PUSH-PULL CLASS AB<sub>1</sub> AMPLIFIER

(Same as for single-tube class A<sub>1</sub> amplifier)

**Typical Operation (Values are for two tubes):**

Plate Voltage.....	250	285	volts
Grid-No.2 Voltage.....	250	285	volts
Grid-No.1 (Control-Grid) Voltage*.....	-15	-19	volts
Peak AF Grid-No.1-to-Grid-No.1 Voltage.....	30	38	volts
Zero-Signal Plate Current.....	70	70	ma
Maximum-Signal Plate Current.....	79	92	ma
Zero-Signal Grid-No.2 Current (Approx.).....	5	4	ma
Maximum-Signal Grid-No.2 Current (Approx.).....	13	13.5	ma
Plate Resistance (Approx.).....	60000	70000	ohms
Transconductance.....	3750	3600	$\mu$ mhos
Effective Load Resistance.....	10000	8000	ohms
Total Harmonic Distortion.....	5	3.5	per cent
Maximum-Signal Power Output.....	10	14	watts

\* The type of input coupling used should not introduce too much resistance in the grid circuit. Transformer- or impedance-coupling devices are recommended. When the grid-No.1 circuit has a resistance not higher than 0.1 megohm, fixed bias may be used; for higher values, cathode bias is required. With cathode bias, the grid-No.1 circuit may have a resistance not to exceed 0.5 megohm.

**TWIN DIODE—MEDIUM-MU TRIODE**

Glass octal type used as combined detector, amplifier, and avc tube. Outline 33, OUTLINES SECTION. Except for interelectrode capacitances, this type is identical electrically with type 85. Heater volts (ac/dc), 6.3; amperes, 0.3. For diode operation curves, refer to type 6SQ7. This is a DISCONTINUED type listed for reference only.

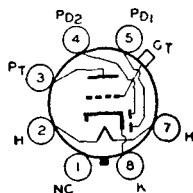

**6V7-G**

**HALF-WAVE  
VACUUM RECTIFIER**

Glass octal type used as damper diode in magnetic deflection circuit of television receivers and as a rectifier in conventional power-supply applications. Outline 22, OUTLINES SECTION.

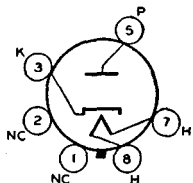

**6W4-GT**

Tube requires octal socket and may be mounted in any position. It is especially important that this tube, like other power-handling tubes, should be adequately ventilated.

HEATER VOLTAGE (AC) .....	6.3	volts
HEATER CURRENT .....	1.2	amperes

**DAMPER SERVICE**

**Maximum Ratings:**

PEAK INVERSE PLATE VOLTAGE* .....	3500 max	volts
PEAK PLATE CURRENT .....	600 max	ma
DC PLATE CURRENT .....	125 max	ma
PEAK HEATER-CATHODE VOLTAGE:		
Heater negative with respect to cathode* .....	2100 max	volts
Heater positive with respect to cathode .....	100 max	volts

\* The duration of the voltage pulse must not exceed 15% of one horizontal scanning cycle. In a 525-line, 30-frame system, 15% of one horizontal scanning cycle is 10 microseconds.

**RECTIFIER SERVICE**

**Maximum Ratings:**

PEAK INVERSE PLATE VOLTAGE .....	1250 max	volts
PEAK PLATE CURRENT .....	600 max	ma
HOT-SWITCHING TRANSIENT PLATE CURRENT (For duration of 0.2 second max) .....	3.5 max	amperes
DC OUTPUT CURRENT .....	125 max	ma
PEAK HEATER-CATHODE VOLTAGE:		
Heater negative with respect to cathode .....	450 max	volts
Heater positive with respect to cathode .....	100 max	volts

**Typical Operation (Capacitor-Input Filter):**

	Half-Wave Rectifier (One Tube)	Full-Wave Rectifier (Two Tubes)	
AC Plate-to-Plate Supply Voltage (rms) .....	—	700	volts
AC Plate-Supply Voltage (rms) .....	350	—	volts
Filter-Input Capacitor .....	20	20	μf
Minimum Total Effective Plate-Supply Impedance per Plate .....	145	145	ohms
DC Output Current .....	125	250	ma
DC Output Voltage at Input to Filter (Approx.):			
At half-load current of { 62.5 ma .....	390	—	volts
{ 125 ma .....	—	395	volts
At full-load current of { 125 ma .....	335	—	volts
{ 250 ma .....	—	350	volts
Voltage Regulation (Approx.):			
Half-load to full-load current .....	55	45	volts

## SHARP-CUTOFF PENTODE

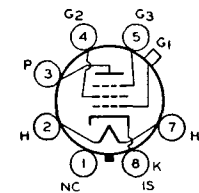

Glass octal type used as biased detector or high-gain amplifier in radio receivers. Outline 33, OUTLINES SECTION. Tube requires octal socket. Heater volts (ac/dc), 6.3; amperes, 0.15. Maximum ratings: plate volts, 300 *max*; grid-No.2 (screen) volts, 100 *max*; grid-No.2 supply volts, 300 *max*; grid-No.1 (control-grid) volts, 0 *min*; plate dissipation, 0.5 *max*

# 6W7-G

watt; grid-No.2 input, 0.1 *max* watt. Within its maximum ratings, this type is identical electrically with type 6J7. Type 6W7-G is used principally for renewal purposes.

## FULL-WAVE VACUUM RECTIFIER

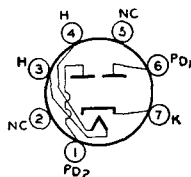

Miniature type used in power supply of automobile and ac-operated radio receivers. Equivalent in performance to larger types 6X5 and 6X5-GT.

# 6X4

HEATER VOLTAGE (AC/DC) . . . . . 6.3 volts  
HEATER CURRENT . . . . . 0.6 ampere

### FULL-WAVE RECTIFIER

#### Maximum Ratings:

PEAK INVERSE PLATE VOLTAGE . . . . .	1250 <i>max</i>	volts
PEAK PLATE CURRENT PER PLATE . . . . .	210 <i>max</i>	ma
DC OUTPUT CURRENT . . . . .	70 <i>max</i>	ma
<b>PEAK HEATER-CATHODE VOLTAGE:</b>		
Heater negative with respect to cathode . . . . .	450 <i>max</i>	volts
Heater positive with respect to cathode . . . . .	450 <i>max</i>	volts

#### Typical Operation:

<i>Filter Input</i>	<i>Capacitor</i>	<i>Choke</i>	
AC Plate-to-Plate Supply Voltage (rms) . . . . .	650	900	volts
Filter-Input Capacitor . . . . .	4	-	$\mu$ f
Total Effective Plate-Supply Impedance per Plate . . . . .	150	-	ohms
Min. Filter-Input Choke . . . . .	-	8	henries
DC Output Current . . . . .	70	70	ma
DC Output Voltage at Input to Filter (Approx.):			
At half-load current (35 ma.) . . . . .	390	385	volts
At full-load current (70 ma.) . . . . .	355	375	volts
Voltage Regulation (Approx.):			
Half-load to full-load current . . . . .	35	10	volts

## INSTALLATION AND APPLICATION

Tube requires miniature seven-contact socket and may be mounted in any position. Outline 15, OUTLINES SECTION. It is especially important that this tube, like other power-handling tubes, should be adequately ventilated.

When operation requires a filter-input capacitor larger than 4  $\mu$ f, it may be necessary to use more plate-supply impedance than the value shown to limit the peak plate current to the rated value. For additional information on filter circuits, refer to ELECTRON TUBE APPLICATIONS SECTION.

### OPERATION CHARACTERISTICS

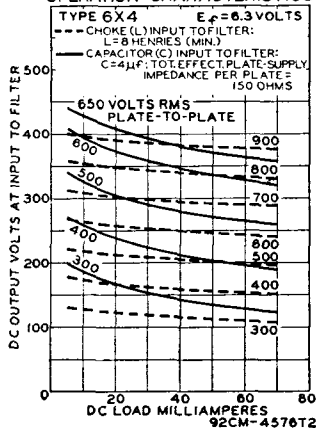

**FULL-WAVE  
VACUUM RECTIFIER**

**6X5  
6X5-GT**

Metal type 6X5 and glass-octal type 6X5-GT are used in power supply of automobile and ac-operated receivers. Outlines 6 and 22, respectively, OUTLINES SECTION. Type 6X5 is

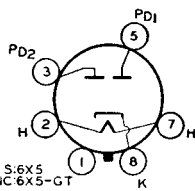

used principally for renewal purposes. Both types require octal socket. Type 6X5 should be mounted in vertical position, but horizontal operation is permissible if pins 3 and 5 are in horizontal plane. Type 6X5-GT may be operated in any position. For maximum ratings, typical operation data, and curves, refer to type 6X4.

**TRIODE—PENTODE CONVERTER**

**6X8**

For technical data, see page 306.

**FULL-WAVE VACUUM RECTIFIER**

**6Y5**

Glass type used in power supply of radio receivers. Outline 32, OUTLINES SECTION. Heater volts (ac/dc), 6.3; amperes, 0.8. The maximum ac plate voltage per plate is 350 volts (rms), and the dc output current is 50 ma. This is a DISCONTINUED type listed for reference only.

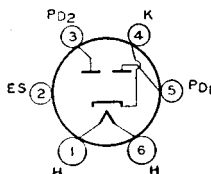

**BEAM POWER AMPLIFIER**

**6Y6-G**

Glass octal type used as output amplifier in radio receivers in which the plate voltage available for the output stage is relatively low. It is also used in rf-operated, high-voltage power

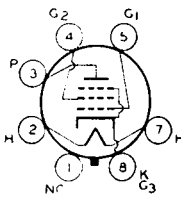

supplies in television equipment. Outline 35, OUTLINES SECTION. Tube requires octal socket and may be mounted in any position. Heater volts (ac/dc), 6.3; amperes, 1.25. Typical operation and maximum ratings as class A<sub>1</sub> amplifier: plate volts, 135 (200 max); grid-No.2 (screen) volts, 135 max; plate dissipation, 12.5 max watts; grid-No.2 input, 1.75 max watts; grid-No.1 (control-grid) volts, -13.5; plate ma., 58; grid-No.2 ma., 3.5; plate resistance, 9300 ohms; transconductance, 7000 μmhos; load resistance, 2000 ohms; maximum-signal output watts, 3.6. At maximum ratings, the 6Y6-G can deliver 6 watts output with load resistance of 2600 ohms.

**RF POWER AMPLIFIER AND OSCILLATOR—Class C Telegraphy**

Maximum Ratings:		
DC PLATE VOLTAGE.....	350 max	volts
DC GRID-NO.2 VOLTAGE.....	135 max	volts
DC GRID-NO.1 VOLTAGE.....	-90 max	volts
DC PLATE CURRENT.....	80 max	ma
DC GRID-NO.1 CURRENT.....	1.5 max	ma
PLATE INPUT.....	23 max	watts
GRID-NO.2 INPUT.....	0.6 max	watt
PLATE DISSIPATION.....	8.0 max	watts

Typical Operation:		
DC Plate Voltage.....	350	volts
DC Grid-No.2 Voltage*.....	115	volts
DC Grid-No.1 Voltage†.....	-40	volts
Peak RF Grid-No.1 Voltage.....	48	volts
DC Plate Current.....	60	ma
DC Grid-No.2 Current.....	5.1	ma
DC Grid-No.1 Current (Approx.).....	1.4	ma
Driving Power (Approx.).....	0.1	watt
Power Output (Approx.).....	14	watts

\* Obtained from a separate source, from a potentiometer, or from plate supply through a series resistor of 45000 ohms.

† Obtained from fixed supply, by grid-No.1 resistor of 30000 ohms, by cathode resistor of 600 ohms, or by a combination of methods.

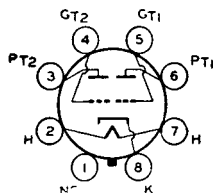

## HIGH-MU TWIN POWER TRIODE

Glass octal type used as class B amplifier in output stage of radio receivers. Outline 31, OUTLINES SECTION. For electrical characteristics, refer to type 79. Heater volts (ac/dc), 6.3; amperes, 0.6. This is a DISCONTINUED type listed for reference only

# 6Y7-G

## FULL-WAVE VACUUM RECTIFIER

Glass type used in power supply of radio receivers. Outline 32, OUTLINES SECTION. Heater volts (ac/dc), 12.6 in series heater arrangement and 6.3 in parallel arrangement; amperes, 0.4 (series), 0.8 (parallel). Maximum ac plate voltage per plate is 230 volts, and maximum dc output current is 60 ma. This is a DISCONTINUED type listed for reference only.

# 6Z5

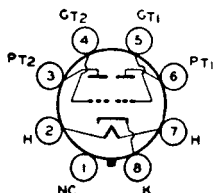

## HIGH-MU TWIN POWER TRIODE

Glass octal type used as class B amplifier in output stage of radio receivers. Outline 31, OUTLINES SECTION. Tube requires octal socket. Heater volts (ac/dc), 6.3; amperes 0.3. Typical operation and maximum ratings as class B power amplifier: plate volts, 180 *max*; grid volts, 0; peak plate ma. per plate, 60 *max*; average plate dissipation, 8 *max* watts; zero-signal plate ma. per plate, 4.2; plate-to-plate load resistance, 12000 ohms; output watts, 4.2 with an average input of 320 milliwatts applied between grids. For typical operation as a resistance-coupled amplifier, refer to Chart 21, RESISTANCE-COUPLED AMPLIFIER SECTION. This type is used principally for renewal purposes.

# 6Z7-G

## FULL-WAVE VACUUM RECTIFIER

Glass octal type used in power supply of radio equipment where economy of power is important. Outline 31, OUTLINES SECTION. Tube requires octal socket and may be mounted in any position. Heater volts (ac/dc), 6.3; amperes, 0.3. Maximum ratings: peak inverse plate volts, 1250; peak plate ma. per plate, 120; dc output ma., 40; peak heater-cathode volts, 450. This type is used principally for renewal purposes.

# 6ZY5-G

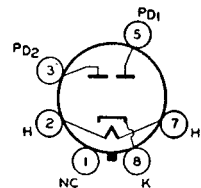

### Typical Operation:

### FULL-WAVE RECTIFIER

Filter Input	Capacitor	Choke	
AC Plate-to-Plate Supply Voltage (rms) .....	650	900	volts
Filter Input Capacitor .....	4	-	μf
Min. Total Effective Plate-Supply Impedance per Plate† .....	225	-	ohms
Min. Filter-Input Choke .....	-	13.5	henries
DC Output Current .....	40	40	ma

† When a filter-input capacitor larger than 4 μf is used, it may be necessary to use more plate-supply impedance than the minimum value shown to limit the peak plate current to the rated value.

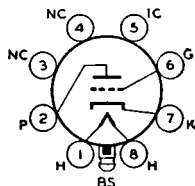

## MEDIUM-MU TRIODE

Glass lock-in type used as detector, amplifier, or oscillator in radio equipment. Outline 14, OUTLINES SECTION. Tube requires lock-in socket. Heater volts (ac/dc), 6.3; amperes, 0.3. Maximum ratings, typical operating conditions, and curves for type 7A4 are the same as for metal type 6J5.

# 7A4

**BEAM POWER AMPLIFIER**

**7A5**

Glass lock-in type used as output amplifier in radio receivers in which the plate voltage available for the output stage is relatively low. Outline 19, OUTLINES SECTION. Tube requires lock-in socket. Heater volts (ac/dc), 6.3; amperes, 0.75. Typical operation and maximum ratings as class A<sub>1</sub> amplifier: plate volts, 110 (125 *max*); grid-No.2 volts, 110 (125 *max*);

plate dissipation, 5.5 *max* watts; grid-No.2 input, 1.2 *max* watts; grid-No.1 volts, 7.5; plate ma., 40; grid-No.2 ma., 3; plate resistance, 16000 ohms; transconductance, 5800  $\mu$ mhos; load resistance, 2500 ohms; maximum-signal output watts, 1.5.

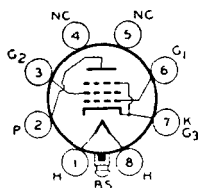

**TWIN DIODE**

**7A6**

Glass lock-in type used as detector, low-voltage rectifier, or avc tube. Outline 14, OUTLINES SECTION. Tube requires lock-in socket. Heater volts (ac/dc), 6.3; amperes, 0.15. Maximum ratings as rectifier: ac plate volts per plate (rms), 150; dc output ma. per plate, 8; peak ma. per plate, 45; peak heater-cathode volts, 330. The application of this type is similar to that of metal type 6H6.

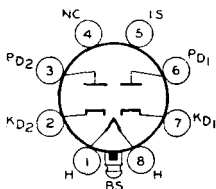

**REMOTE-CUTOFF PENTODE**

**7A7**

Glass lock-in type used as rf or if amplifier in radio receivers. Outline 14, OUTLINES SECTION. Tube requires lock-in socket. Heater volts (ac/dc), 6.3; amperes, 0.3. For maximum ratings, typical operation, and curves, refer to metal type 6SK7.

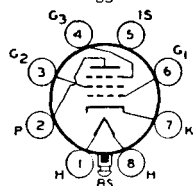

**OCTODE CONVERTER**

**7A8**

Glass lock-in type used as converter in superheterodyne circuits. Outline 14, OUTLINES SECTION. Tube requires lock-in socket. Heater volts (ac/dc), 6.3; amperes, 0.15. Typical operation and maximum ratings as frequency converter: plate volts, 250 (300 *max*); grids-No.3-and-No.5 volts, 100 *max*; grid-No.2 supply volts, 250 (300 *max*) applied through

20000-ohm dropping resistor properly bypassed; grid-No.2 volts, 165 (200 *max*); plate dissipation, 1 *max* watt; grids-No.3-and-No.5 input, 0.3 *max* watt; grid-No.2 input, 0.75 *max* watt; grid-No.4 volts, -3 (0 *min*); grid-No.1 resistor, 50000 ohms; plate ma., 3; grids-No.3-and-No.5 ma., 3.2; grid-No.2 ma., 4.2; grid-No.1 ma., 0.4; plate resistance, 0.7 megohm; conversion transconductance, 550  $\mu$ mhos; conversion transconductance with grid-No.1 bias of -30 volts, 2  $\mu$ mhos. The application of this type is similar to that of metal type 6A8 and glass-octal type 6D8-G.

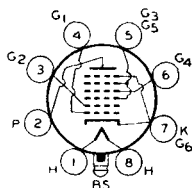

**POWER PENTODE**

**7AD7**

Lock-in type used in output stage of video amplifier of television receivers. Outline 19, OUTLINES SECTION. Tube requires lock-in socket. Heater volts (ac/dc), 6.3; amperes, 0.6. Typical operation and ratings as class A<sub>1</sub> video amplifier: plate volts, 300 *max*; grid-No.2 volts, 150 *max*; plate dissipation, 10 *max* watts; grid-No.2 input, 1.2 *max* watts; cathode resistor, 68

ohms; plate ma., 28; grid-No.2 ma., 7; plate resistance, 300000 ohms; transconductance, 9500  $\mu$ mhos.

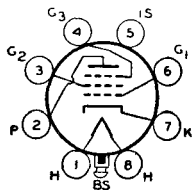

**MEDIUM-MU TWIN TRIODE**

**7AF7**

Glass lock-in type used as voltage amplifier or phase inverter in radio equipment. Outline 14, OUTLINES SECTION. Tube requires lock-in socket. Heater volts (ac/dc), 6.3; amperes, 0.3. Ratings and characteristics as class A<sub>1</sub> amplifier (each section): plate volts, 250 (300 *max*); cathode resistor, 1100 ohms; plate ma., 9; transconductance, 2100  $\mu$ mhos; amplification factor, 16; plate resistance, 7600 ohms.

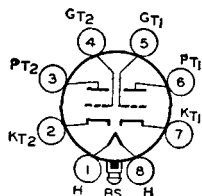



**SHARP-CUTOFF PENTODE**

**7AG7**

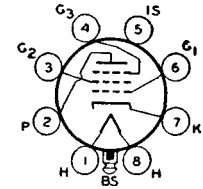

Glass lock-in type used as rf amplifier in ac/dc receivers or in mobile equipment where low heater-current drain is important. Outline 14, OUTLINES SECTION. Tube requires lock-in socket. Heater volts (ac/dc), 6.3; amperes, 0.15. Maximum ratings and characteristics as class A<sub>1</sub> amplifier: plate and grid-No.2 volts, 250 (300 max); plate dissipation, 2 max watts; grid-No.2 input, 0.75 max watt; grid

No.3 and internal shield connected to cathode at socket; plate resistance (approx.), 0.75 megohm; transconductance, 4200 μmhos; grid-No.1 bias for plate current of 10 μa, -10; cathode resistor, 250 ohms; plate ma., 6; grid-No.2 ma., 2. The application of this type is similar to that of miniature type 6BH6.

**REMOTE-CUTOFF PENTODE**

**7AH7**

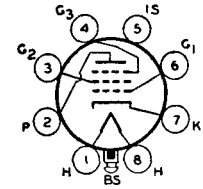

Glass lock-in type used as rf amplifier in high-frequency and wide-band applications. Outline 14, OUTLINES SECTION. Tube requires lock-in socket. Heater volts (ac/dc), 6.3; amperes, 0.15. Maximum ratings and characteristics as class A<sub>1</sub> amplifier: plate and grid-No.2 volts, 250 (300 max); plate dissipation, 2 max watts; grid-No.2 input, 0.7 max watt; cathode resistor, 250 ohms; grid No.3 and internal shield

connected to cathode at socket; plate resistance (approx.), 1 megohm; transconductance, 3300 μmhos; grid-No.1 bias for transconductance of 35 μmhos, -20 volts; plate ma., 6.8; grid-No.2 ma., 1.9. The application of this type is similar to that of miniature type 6BJ6.

**HIGH-MU TRIODE**

**7B4**

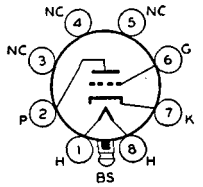

Glass lock-in type used in resistance-coupled amplifier circuits. Outline 14, OUTLINES SECTION. Tube requires lock-in socket. Heater volts (ac/dc), 6.3; amperes, 0.3. Except for interelectrode capacitances, this type has the same maximum ratings and characteristics as metal types 6F5 and 6SF5.

**POWER PENTODE**

**7B5**

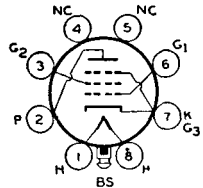

Glass lock-in type used in output stage of radio receivers. Outline 19, OUTLINES SECTION. Tube requires lock-in socket. Heater volts (ac/dc), 6.3; amperes, 0.4. Except for interelectrode capacitances, this type is the same electrically as glass-octal type 6K6-GT.

**TWIN DIODE—HIGH-MU TRIODE**

**7B6**

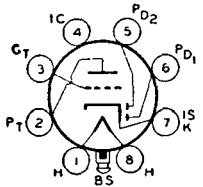

Glass lock-in type used as combined detector, amplifier, and avc tube. Outline 14, OUTLINES SECTION. Tube requires lock-in socket. Heater volts (ac/dc), 6.3; amperes, 0.3. Except for interelectrode capacitances, this type is the same electrically as metal type 6SQ7.

**REMOTE-CUTOFF PENTODE**

**7B7**

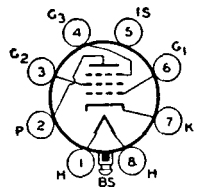

Glass lock-in type used as rf or if amplifier in radio receivers employing avc. Outline 14, OUTLINES SECTION. Tube requires lock-in socket. Heater volts (ac/dc), 6.3; amperes, 0.15. Typical operation as class A<sub>1</sub> amplifier: plate volts, 250 (300 max); grid-No.2 volts, 100 max; grid-No.1 volts, -3; grid No.3 connected to cathode at socket; plate ma., 8.5; grid-No.2

ma., 1.7; plate resistance, 0.75 megohm; transconductance, 1750 μmhos; transconductance at bias of -40 volts, 10 μmhos. The application of this type is similar to that of metal types 6SK7 and 6SS7.

**PENTAGRID CONVERTER**

**7B8**

Glass lock-in type used as frequency converter in superheterodyne circuits. Outline 14, OUTLINES SECTION. Tube requires lock-in socket. Heater volts (ac/dc), 6.3; amperes, 0.3. Except for interelectrode capacitances, this type is the same electrically as metal type 6A8.

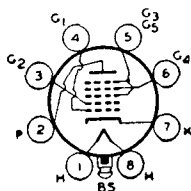

**BEAM POWER AMPLIFIER**

**7C5**

Glass lock-in type used as output amplifier in radio receivers. Outline 19, OUTLINES SECTION. Tube requires lock-in socket. Heater volts (ac/dc), 6.3; amperes, 0.45. Refer to metal type 6V6 for maximum ratings and typical operation as single-tube class A<sub>1</sub> amplifier and as push-pull amplifier, and for curves, to miniature type 6AQ5.

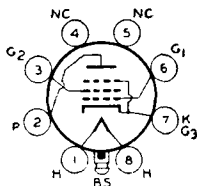

**TWIN DIODE—HIGH-MU TRIODE**

**7C6**

Glass lock-in type used as combined detector, amplifier, and avc tube. Outline 14, OUTLINES SECTION. Tube requires lock-in socket. Heater volts (ac/dc), 6.3; amperes, 0.15. Typical operation of triode unit as class A<sub>1</sub> amplifier: plate volts, 250 (300 max); grid volts, -1; plate ma., 1.3; plate resistance, 0.1 megohm; transconductance, 1000 μmhos. For diode operation curves and triode application, refer to metal type 6SQ7.

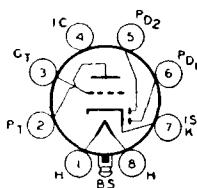

**SHARP-CUTOFF PENTODE**

**7C7**

Glass lock-in type used as biased detector or rf amplifier. Outline 14, OUTLINES SECTION. Tube requires lock-in socket. Heater volts (ac/dc), 6.3; amperes, 0.15. Typical operation as class A<sub>1</sub> amplifier: plate volts, 250 (300 max); grid-No.2 volts, 100 max; grid-No.1 volts, -3 (0 min); grid No.3 and internal shield connected to cathode at socket; plate resistance (approx.), 2 megohms; plate ma., 2; grid-No.2 ma., 0.5; transconductance, 1300 μmhos. The application of this type is similar to that of metal type 6SJ7 and glass-octal type 6W7-G.

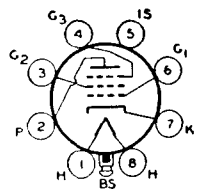

**KINESCOPE**

**7DP4**

Directly viewed picture tube used in television receivers. Employs a high-efficiency white fluorescent screen utilizing phosphor No.4 of the sulfide type. For curve showing spectral-energy

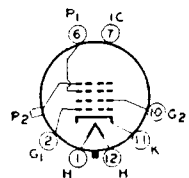

emission characteristic of this phosphor, refer to type 12LP4-A. The 7DP4 has electrostatic focus and magnetic deflection to provide a rectangular picture with rounded corners about 5½ x 4 inches or a rounded-end picture 6¾ x 4¾ inches. Has a deflection angle of approximately 50°. Tube requires duodecal twelve-contact socket and may be mounted in any position. Outline 45, OUTLINES SECTION. For installation and handling considerations, refer to ELECTRON TUBE INSTALLATION SECTION.

HEATER VOLTAGE (AC/DC) .....	6.3	volts
HEATER CURRENT .....	0.6	ampere

# RCA RECEIVING TUBE MANUAL

## DIRECT INTERELECTRODE CAPACITANCES (Approx.):

Grid No.1 to All other Electrodes . . . . .	6	μf
Cathode to All Other Electrodes . . . . .	5	μf
External Conductive Coating to Anode No.2 . . . . .	1500 max 400 min	μf μf

## Maximum Ratings:

ANODE-NO.2 VOLTAGE* . . . . .	8000 max	volts
ANODE-NO.1 VOLTAGE . . . . .	2400 max	volts
GRID-NO.2 VOLTAGE . . . . .	410 max	volts
<b>GRID-NO.1 VOLTAGE:</b>		
Negative bias value . . . . .	125 max	volts
Positive bias value . . . . .	0 max	volts
Positive peak value . . . . .	2 max	volts
<b>PEAK HEATER-CATHODE VOLTAGE:</b>		
Heater negative with respect to cathode:		
During equipment warm-up period not exceeding 15 seconds . . . . .	410 max	volts
After equipment warm-up period . . . . .	150 max	volts
Heater positive with respect to cathode . . . . .	150 max	volts

## Typical Operation:

Anode-No.2 Voltage* . . . . .	6000	volts
Anode-No.1 Voltage for Focus <sup>o</sup> . . . . .	1215 to 1645	volts
Grid-No.2 Voltage . . . . .	250	volts
Grid-No.1 Voltage for Visual Extinction of		
Undelected Focused Spot . . . . .	-27 to -63	volts
Maximum Anode-No.1 Current Range . . . . .	-15 to +10	μa

## Maximum Circuit Value:

Grid-No.1-Circuit Resistance . . . . .	1.5 max	megohms
--	---------	---------

\* The product of anode-No.2 voltage and average anode-No.2 current should be limited to 6 watts.

<sup>o</sup> With the combined grid-No.1-bias voltage and video-signal voltage adjusted to produce a highlight brightness of 12 foot-lamberts on a 5½" x 4" picture area.

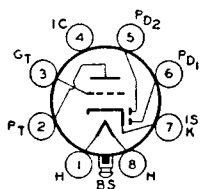

## TWIN DIODE—MEDIUM-MU TRIODE

Glass lock-in type used as combined detector, amplifier, and avc tube. Outline 14, OUTLINES SECTION. Tube requires lock-in socket. Heater volts (ac/dc), 6.3; amperes, 0.3. For maximum ratings, typical operation, and curves, refer to miniature type 6BF6.

# 7E6

## TWIN DIODE—REMOTE-CUTOFF PENTODE

Glass lock-in type used as combined detector, amplifier, and avc tube. Outline 14, OUTLINES SECTION. Tube requires lock-in socket. Heater volts (ac/dc), 6.3; amperes, 0.3. Typical operation and maximum ratings of pentode unit as class A<sub>1</sub> amplifier: plate volts, 250 (300 max); grid-No.2 volts, 100 max; plate dissipation, 2-max watts; grid-No.2 input, 0.3

# 7E7

max watt; cathode-bias resistor, 330 ohms; plate resistance (approx.), 0.7 megohm; transconductance, 1300 μmhos; grid-No.1 bias for transconductance of 2 μmhos, -42.5; plate ma., 7.5; grid-No.2 ma. 1.6. For diode operation curves, refer to type 6SQ7.

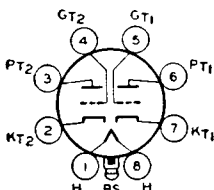

## HIGH-MU TWIN TRIODE

Glass lock-in type used as phase inverter or resistance-coupled amplifier. Outline 14, OUTLINES SECTION. Tube requires lock-in socket. Heater volts (ac/dc), 6.3; amperes, 0.3. For maximum ratings, typical operation as class A<sub>1</sub> amplifier, and curves, refer to glass-octal type 6SL7-GT.

# 7F7

**MEDIUM-MU TWIN TRIODE**

**7F8**

Glass lock-in type used as amplifier or oscillator in radio equipment. Outline 10, OUTLINES SECTION. Tube requires lock-in socket. Heater volts (ac/dc), 6.3; amperes, 0.3. Typical operation and maximum ratings as class A<sub>1</sub> amplifier (per unit); plate volts, 250 (300 *max*); cathode resistor, 500 ohms; plate ma., 6.0; transconductance, 3300  $\mu$ hos; am-

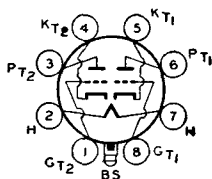

plification factor, 48; grid bias for plate current of 10  $\mu$ a., -11; grid-circuit resistor, 0.5 *max* megohm.

**SHARP-CUTOFF PENTODE**

**7G7**

Glass lock-in type used in video amplifiers of television receivers and in other applications requiring high transconductance. Outline 14, OUTLINES SECTION. Tube requires lock-in socket. Heater volts (ac/dc), 6.3; amperes, 0.45. Typical operation and maximum ratings as class A<sub>1</sub> amplifier: plate volts, 250 (300 *max*); grid-No.2 volts, 100 *max*; plate dissipation, 1.5

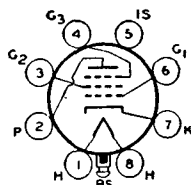

*max* watts; grid-No.2 input, 0.3 *max* watt; grid-No.1 volts, -2; grid No.3 and internal shield connected to cathode at socket; plate resistance (approx.), 0.8 megohm; transconductance, 4500  $\mu$ hos; grid-No.1 bias for cathode-current cutoff, -7; plate ma., 6; grid-No.2 ma., 2.0. The application of this type is similar to that of miniature type 6AU6.

**KINESCOPE**

**7GP4**

Directly viewed picture tube used in television receivers. Features a white fluorescent screen and utilizes electrostatic focus and deflection to provide a picture about 5½ x 4 inches. Outline 46, OUTLINES SECTION. Tube has medium-shell diheptal 12-pin base. Except for base connections and within its maximum ratings (anode-No.2 and grid-No.2 volts,

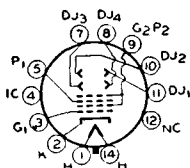

4000 *max*; anode-No.1 volts, 1500 *max*), this type is identical with type 7JP4. The 7JP4 may be used to replace the 7GP4 provided no connections are made to pins 4 and 12. The 7GP4 is a DISCONTINUED type listed for reference only.

**REMOTE-CUTOFF PENTODE**

**7H7**

Glass lock-in type used as rf or if amplifier in radio receivers. Outline 14, OUTLINES SECTION. Tube requires lock-in socket. Heater volts (ac/dc), 6.3; amperes, 0.3. Typical operation and maximum ratings as class A<sub>1</sub> amplifier: plate volts, 250 (300 *max*); grid-No.2 volts, 150 *max*; plate dissipation, 2.5 *max* watts; grid-No.2 input, 0.5 *max* watt; grid No.3 and internal shield connected to cathode at socket; cathode resistor, 180 ohms; plate resistance (approx.), 0.8

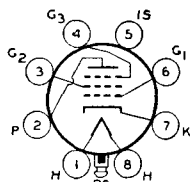

megohm; transconductance, 4000  $\mu$ hos; grid-No.1 volts for transconductance of 35  $\mu$ hos, -19; plate ma., 10; grid-No.2 ma., 3.2. The application of this type is similar to that of miniature type 6BA6.

**TRIODE—HEPTODE CONVERTER**

**7J7**

Glass lock-in type used as combined oscillator and heptode mixer in radio receivers. Outline 14, OUTLINES SECTION. Tube requires lock-in socket. Heater volts (ac/dc), 6.3; amperes, 0.3. For maximum ratings and typical operation, refer to glass-octal type 6J8-G.

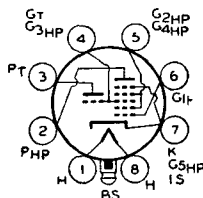

KINESCOPE

7JP4

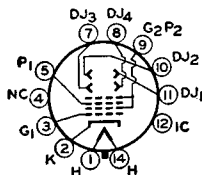

Directly viewed picture tube used in television receivers and in oscillograph equipment. Employs a high-efficiency white fluorescent screen utilizing phosphor No.4 of the sulfide type.

For curve showing spectral-energy emission characteristic of this phosphor, refer to type 12LP4-A. The 7JP4 has electrostatic focus and deflection to provide a rectangular picture with rounded corners about 5½ x 4 inches or a rounded-end picture 6½ x 4-7/8 inches.

HEATER VOLTAGE (AC/DC).....	6.3	volts
HEATER CURRENT.....	0.6	ampere
DIRECT INTERELECTRODE CAPACITANCES (Approx.):		
Grid No.1 to All Other Electrodes.....	6	μf
Cathode to All Other Electrodes.....	5	μf
DJ <sub>1</sub> to DJ <sub>2</sub> .....	3	μf
DJ <sub>3</sub> to DJ <sub>4</sub> .....	2	μf
DJ <sub>1</sub> to All Other Electrodes.....	9	μf
DJ <sub>2</sub> to All Other Electrodes.....	8	μf
DJ <sub>3</sub> to All Other Electrodes.....	7	μf
DJ <sub>4</sub> to All Other Electrodes.....	7	μf

Maximum Ratings:

ANODE-NO.2 AND GRID-NO.2 VOLTAGE‡.....	6000 max	volts
ANODE-NO.1 VOLTAGE.....	2800 max	volts
GRID-NO.1 VOLTAGE:		
Negative bias value.....	200 max	volts
Positive bias value.....	0 max	volts
Peak positive value.....	2 max	volts
PEAK VOLTAGE BETWEEN ANODE NO.2 AND ANY DEFLECTING ELECTRODE.....	750 max	volts
PEAK HEATER-CATHODE VOLTAGE:		
Heater negative with respect to cathode:		
During equipment warm-up period not exceeding 15 seconds.....	410 max	volts
After equipment warm-up period.....	125 max	volts
Heater positive with respect to cathode.....	125 max	volts

Typical Operation:

Anode-No.2 Voltage‡.....	4000	6000	volts
Anode-No.1 Voltage for focus.....	1080 to 1600	1620 to 2400	volts
Grid-No.1 Voltage.....	48 to 112	75 to 168	volts
Maximum Anode-No.1 Current Range.....	-15 to +10	-15 to +10	μa
Deflection Factors:			
DJ <sub>1</sub> and DJ <sub>2</sub> .....	124 to 164	186 to 246	volts dc/in
DJ <sub>3</sub> and DJ <sub>4</sub> .....	100 to 136	150 to 204	volts dc/in

Maximum Circuit Values:

Grid-No.1-Circuit Resistance.....	1.5 max	megohms
Resistance in any Deflecting-Electrode Circuit‡.....	5.0 max	megohms

‡ The product of anode-No.2 voltage and average anode-No.2 current should be limited to 6 watts.

† It is recommended that the deflecting-electrode-circuit resistances be approximately equal.

INSTALLATION AND APPLICATION

The base pins of the 7JP4 fit in the medium diheptal twelve-contact socket and the tube may be mounted in any position. The socket, however, should not be used to support the tube but should have flexible leads and be allowed to move freely. The tube should be supported by a padded mechanism about the neck and by a cushioned ring or saddle arrangement near the screen end. Outline 46, OUTLINES SECTION.

Deflecting electrodes DJ<sub>1</sub> and DJ<sub>2</sub> are nearer the screen; deflecting electrodes DJ<sub>3</sub> and DJ<sub>4</sub> are nearer the base. When DJ<sub>1</sub> is positive with respect to DJ<sub>2</sub>, the spot is deflected toward pin 5; when DJ<sub>3</sub> is positive with respect to DJ<sub>4</sub>, the spot is deflected toward pin 2.

For installation and handling considerations, refer to ELECTRON TUBE INSTALLATION SECTION.

**TWIN DIODE—HIGH-MU TRIODE**

**7K7**

Glass lock-in type used as FM detector and audio amplifier in circuits which require diode and triode units with separate cathodes. Outline 14, OUTLINES SECTION. Tube requires lock-in socket. Heater volts (ac/dc), 6.3; amperes, 0.3. For ratings and typical operation, refer to glass-octal type 6AQ7-GT.

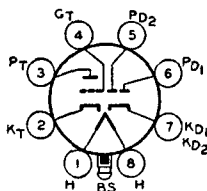

**SHARP-CUTOFF PENTODE**

**7L7**

Glass lock-in type used as rf and if amplifier in radio equipment. Outline 14, OUTLINES SECTION. Tube requires lock-in socket. Heater volts (ac/dc), 6.3; amperes, 0.3. Typical operation and maximum ratings as class A<sub>1</sub> amplifier: plate volts, 250 (300 max); grid-No.2 volts, 100 (125 max); grid-No.1 volts, -1.5; grid No.3 tied to cathode at socket; cathode

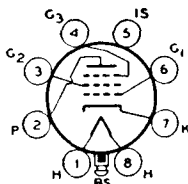

resistor, 250 ohms; plate ma., 4.5; grid-No.2 ma., 1.5; plate resistance (approx.), 1 megohm; trans-conductance, 3100 μmhos. The application of this type is similar to that of miniature type 6AU6.

**MEDIUM-MU TWIN TRIODE**

**7N7**

Glass lock-in type used as voltage amplifier or phase inverter in radio equipment. Outline 19, OUTLINES SECTION. Tube requires lock-in socket. Heater volts (ac/dc), 6.3; amperes, 0.6. For maximum ratings and typical operation of each triode unit, refer to metal type 6J5. The application of this type is similar to that of glass-octal type 6SN7-GT.

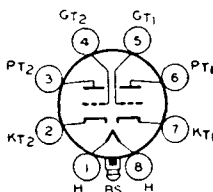

**PENTAGRID CONVERTER**

**7Q7**

Glass lock-in type used as converter in superheterodyne circuits. Outline 14, OUTLINES SECTION. Tube requires lock-in socket. Heater volts (ac/dc), 6.3; amperes, 0.3. For maximum ratings, typical operation in converter service, and curves, refer to metal type 6SA7.

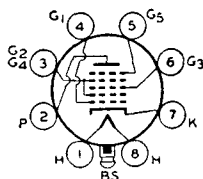

**TWIN DIODE—REMOTE-CUTOFF PENTODE**

**7R7**

Glass lock-in type used as combined detector, amplifier, and avc tube. Outline 14, OUTLINES SECTION. Tube requires lock-in socket. Heater volts (ac/dc), 6.3; amperes, 0.3. Typical operation and ratings of pentode unit as class A<sub>1</sub> amplifier: plate volts, 250 max; grid-No.2 volts, 100 max; plate dissipation, 2 max watts; grid-No.2 input, 0.25 max watt; grid-No.1

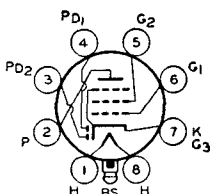

volts, -1 (0 min); plate resistance (approx.), 1.0 megohm; transconductance, 3200 μmhos; plate ma., 5.7; grid-No.2 ma., 2.1, grid-No.1 volts for transconductance of 10 μmhos, -20. Refer to type 6SQ7 for diode operation curves.

**TRIODE—HEPTODE CONVERTER**

**7S7**

Glass lock-in type used as combined triode oscillator and heptode mixer in radio receivers. Outline 14, OUTLINES SECTION. Tube requires lock-in socket. Heater volts (ac/dc), 6.3; amperes, 0.3. Typical operation of heptode unit: plate volts, 250 (300 max); grids-No.2-and-No.4 volts, 100 max; grid-No.1 volts, -2; plate resistance, 1.25 megohms; conversion transcon-

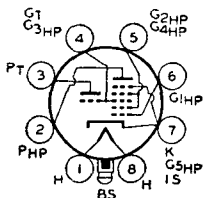

ductance, 525 μmhos; plate ma., 1.8; grids-No.2-and-No.4 ma., 3.0. Typical operation of triode unit: plate supply volts, 250 (300 max) applied through a 20000-ohm dropping resistor bypassed by a 0.1-μf capacitor; grid resistor, 50000 ohms; plate ma., 5.0; total cathode ma. (both units), 10.2.

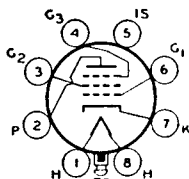

**SHARP-CUTOFF PENTODE**

Glass lock-in type used as rf or if amplifier in radio receivers. Outline 14, OUTLINES SECTION. Tube requires lock-in socket. Heater volts (ac/dc), 6.3; amperes, 0.45. Typical operation and maximum ratings as class A<sub>1</sub> amplifier: plate volts and grid-No.2 supply volts, 300 *max*; grid-No.2 series resistor, 40000 ohms; plate dissipation, 4 *max* watts; grid-No.2 input,

**7V7**

0.8 *max* watt; grid No.3 connected to cathode at socket; cathode-bias resistor, 160 *min* ohms; plate resistance, 0.3 megohm; transconductance, 5800  $\mu$ mhos; plate ma., 10; grid-No.2 ma., 3.9; grid-No.1 bias for plate current of 10  $\mu$ a., -16. The application of this type is similar to that of miniature type 6AU6.

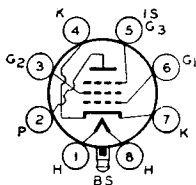

**SHARP-CUTOFF PENTODE**

Glass lock-in type used as rf or if amplifier in radio receivers. Outline 14, OUTLINES SECTION. Tube requires lock-in socket. Heater volts (ac/dc), 6.3; amperes, 0.45. This type is the same as type 7V7 except for socket connections.

**7W7**

**TWIN DIODE—HIGH-MU TRIODE**

Glass lock-in type used as combined detector, amplifier, and avc tube in circuits which require diodes with separate cathodes. Outline 19, OUTLINES SECTION. Tube requires lock-in socket. Heater volts (ac/dc), 6.3; amperes, 0.3. Ratings and characteristics of triode unit as class A<sub>1</sub> amplifier: plate volts, 250 (300 *max*); grid volts, -1; amplification factor, 100; plate resistance, 67000 ohms; transconductance, 1500  $\mu$ mhos; plate ma., 1.9.

**7X7**

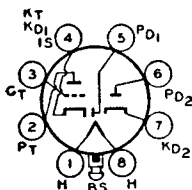

**FULL-WAVE VACUUM RECTIFIER**

Glass lock-in type used in power supply of automobile radio receivers and compact ac-operated receivers. Outline 14, OUTLINES SECTION. Tube requires lock-in socket. Heater volts (ac/dc), 6.3; amperes, 0.5. Maximum ratings: peak inverse plate volts, 1250; peak plate ma. per plate, 180; dc output ma., 70; peak heater-cathode volts, 450. For typical operation, refer to miniature type 6X4.

**7Y4**

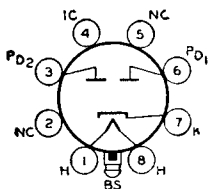

**FULL-WAVE VACUUM RECTIFIER**

Glass lock-in type used in power supply of automobile and ac-operated radio receivers. Outline 19, OUTLINES SECTION. Tube requires lock-in socket. Heater volts (ac/dc), 6.3; amperes, 0.9. Maximum ratings: peak inverse plate volts, 1250; peak plate ma. per plate, 300; dc output ma., 100; peak heater-cathode volts, 450.

**7Z4**

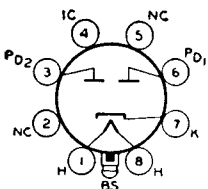

**Typical Operation:**

*Filter Input*

AC Input-to-Plate Supply Voltage (rms).....	650
Filter-Input Capacitor.....	4
Min. Total Effective Plate-Supply Impedance per Plate.....	75
Min. Filter-Input Choke.....	-
DC Output Current.....	100

**FULL-WAVE RECTIFIER**

Capacitor	Choke	volts
650	900	
4	-	$\mu$ f
75	-	ohms
-	6	henries
100	100	ma

† When a filter capacitor larger than 40  $\mu$ f is used, it may be necessary to use more plate-supply impedance than the minimum value shown to limit the peak plate current to the rated value.

**KINESCOPE**

Directly viewed picture tube used in television receivers. Employs a white fluorescent screen having medium persistence and high efficiency. It utilizes electrostatic focus and magnetic deflection to provide a picture about 7-1/8 inches by 5-3/8 inches. Maximum diameter is 9-1/8 inches; maximum overall length is 21-3/8 inches. Tube requires six-contact socket. Refer to type

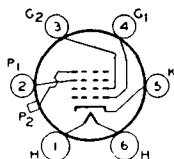

**9AP4**

12AP4 for maximum ratings, characteristics, and typical operation. For handling and safety considerations, refer to ELECTRON TUBE INSTALLATION SECTION. This type is used only for renewal purposes.

**POWER TRIODE**

Glass type used as an audio-frequency amplifier. Outline 41, OUTLINES SECTION. Tube requires four-contact socket and should be operated in vertical position with base down. Filament volts (ac/dc), 7.5; amperes, 1.25. Typical operation as class A<sub>1</sub> af power amplifier: plate volts, 425 max; grid volts, -40; peak af grid volts, 35; plate ma., 18; plate resistance,

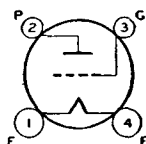

**10**

5000 ohms; transconductance, 1600  $\mu$ mhos; load resistance, 10200 ohms; undistorted output watts, 1.6. This is a DISCONTINUED type listed for reference only. Replace by transmitting type 10-Y.

**KINESCOPE**

Directly viewed picture tubes used in television receivers. Both types feature a high-efficiency, white fluorescent screen utilizing phosphor No.4 of the sulfide type on a practically flat face.

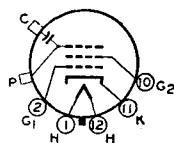

**10BP4  
10BP4-A**

For curve showing spectral-energy emission characteristic of this phosphor, refer to type 12LP4-A. The face plate of the 10BP4-A is made of RCA "Filterglass" to provide increased contrast. Type 10BP4-A supersedes type 10BP4. Both types have a deflection angle of approximately 52° and contain an ion-trap electron gun requiring an external, double-field magnet. They utilize magnetic focus and magnetic deflection to provide a rounded-end picture 9 3/8 x 7 inches or a rectangular picture with rounded corners about 8 x 6 inches.

HEATER VOLTAGE (AC/DC).....	6.3	volts
HEATER CURRENT.....	0.6	ampere
DIRECT INTERELECTRODE CAPACITANCES (Approx.):		
Grid No.1 to All Other Electrodes.....	6	$\mu$ f
Cathode to All Other Electrodes.....	5	$\mu$ f
External Conductive Coating to Anode.....	{ 2000 max	$\mu$ f
	{ 500 min	$\mu$ f

**Maximum Ratings:**

ANODE VOLTAGE*.....	12000 max	volts
GRID-NO.2 VOLTAGE.....	410 max	volts
GRID-NO.1 VOLTAGE:		
Negative bias value.....	125 max	volts
Positive bias value.....	0 max	volts
Positive peak value.....	2 max	volts
PEAK HEATER-CATHODE VOLTAGE:		
Heater negative with respect to cathode:		
During equipment warm-up period not exceeding 15 seconds.....	410 max	volts
After equipment warm-up period.....	150 max	volts
Heater positive with respect to cathode.....	150 max	volts

**Typical Operation:**

Anode Voltage**.....	9000	11000	volts
Grid-No.2 Voltage.....	250	250	volts
Grid-No.1 Voltage for Visual Extinction of Undelected Focused Spot.....	-27 to -63	-27 to -63	volts



**Maximum Circuit Value:**

Grid-No.1 Circuit Resistance . . . . . 1.5 *max* megohms

\* The product of anode voltage and average anode current should be limited to 6 watts.

\*\* Brilliance and definition decrease with decreasing anode voltage. In general, the anode voltage should not be less than 8000 volts.

## INSTALLATION AND APPLICATION

The 10BP4 was supplied formerly with a duodecal seven-pin base requiring a duodecal twelve-contact socket, but now has a duodecal five-pin base like the 10BP4-A to permit use with either a duodecal five-contact segment socket, or a duodecal twelve-contact socket. Both types may be mounted in any position. The socket should not be used to support the tube, but should have flexible leads and be allowed to move freely. The tube should be supported by a cushioned ring or saddle arrangement near the screen end of the tube, and by the deflecting yoke. *The conductive coating on the exterior of the bulb must be grounded.* Connection to the coating may be made by means of a soft brush contact attached to the deflection yoke. A contact area of at least  $\frac{1}{4}$  square inch should be used in making this connection to the external coating. Outline 47, OUTLINES SECTION.

For installation and handling considerations, refer to the ELECTRON TUBE INSTALLATION SECTION. For the recommended sequence of adjustments in lining up either the 10BP4 or 10BP4-A with its associated components, refer to type 12LP4-A.

### KINESCOPE

For technical data, see page 308.

## 10FP4-A

### DETECTOR AMPLIFIER

11

Glass types used as detectors and amplifiers in battery-operated receivers. Filament volts (dc), 1.1; amperes, 0.25. Typical operation as class A<sub>1</sub> amplifier: plate volts, 135 *max*; grid volts, -10.5; plate resistance, 15500 ohms; transconductance, 440  $\mu$ mhos; plate ma., 3. These are DISCONTINUED types listed for reference only.

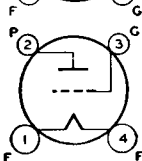
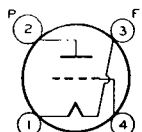

12

### POWER PENTODE

Glass type used as output amplifier in ac/dc radio receivers. Outline 32, OUTLINES SECTION. Heater volts (ac/dc), 12.6 in series heater arrangement and 6.3 in parallel arrangement; amperes, 0.3 (series), 0.6 (parallel). Typical operation as class A<sub>1</sub> amplifier: plate volts and grid-No.2 volts, 180 *max*; grid-No.1 volts, -25; plate ma., 45; grid-No.2 ma., 8; plate resistance, 35000 ohms; transconductance, 2400  $\mu$ mhos; load resistance, 3300 ohms; output watts, 8.4

12A5

This is a DISCONTINUED type listed for reference only.

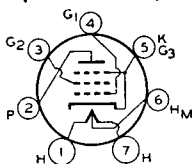

### RECTIFIER—POWER PENTODE

Glass type used as combined half-wave rectifier and power amplifier. Outline 34, OUTLINES SECTION. Tube requires small seven-contact (0.75-inch, pin-circle diameter) socket. Heater volts (ac/dc), 12.6; amperes, 0.3. Typical operation of pentode unit as class A<sub>1</sub> amplifier: plate volts and grid-No.2 volts, 135 *max*; grid-No.1 volts, -13.5; load resistance, 13500

12A7

ohms; plate resistance, 10000 ohms; transconductance, 975  $\mu$ mhos; cathode resistance, 1175 ohms; plate ma., 9; grid-No.2 ma., 2.5; output watts, 0.55. Maximum ratings of rectifier unit with capacitor-input filter: ac plate volts (rms), 125; dc output ma., 30. This type is used principally for renewal purposes.

**PENTAGRID CONVERTER**

**12A8-GT**

Glass octal type used as converter in ac/dc receivers. Outline 23, OUTLINES SECTION. Heater volts (ac/dc), 12.6; amperes, 0.15. Except for heater rating, this type is identical with glass-octal type 6A8-GT.

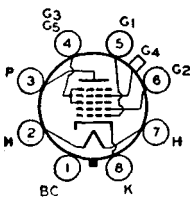

**MEDIUM-MU TWIN TRIODE**

**12AH7-GT**

Glass octal tube used as audio amplifier in radio equipment. Outline 17, OUTLINES SECTION. Tube requires octal socket. Heater volts (ac/dc), 12.6; amperes, 0.15. Typical operation as class A<sub>1</sub> amplifier: plate volts, 180 max; grid volts, -6.5; amplification factor, 16; transconductance, 1900 μmhos; plate resistance, 8400 ohms; plate ma., 7.6; grid-bias volts for plate current of 10 μa, -16.

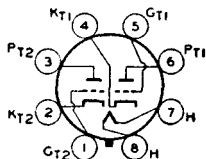

**TWIN DIODE**

**12AL5**

Miniature, high-perveance type used as detector in FM and television circuits. It is especially useful as a ratio detector in ac/dc FM receivers. Outline 9, OUTLINES SECTION.

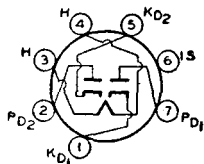

Heater volts (ac/dc), 12.6; amperes, 0.15. Except for heater rating, this type is identical with miniature type 6AL5.

**KINESCOPE**

**12AP4**

Directly viewed picture tube used in television receivers. Employs white fluorescent screen having medium persistence and high efficiency. It utilizes electrostatic focus and magnetic deflection to provide a picture about 9¾ by 7¾ inches. Maximum diameter is 12-3/16 inches; maximum overall length is 25¾ inches. Tube requires six-contact socket.

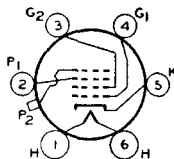

handling and safety considerations, refer to ELECTRON TUBE INSTALLATION SECTION. This type is used only for renewal purposes.

HEATER VOLTAGE (AC/DC).....	2.5	volts
HEATER CURRENT.....	2.1	amperes
DIRECT INTERELECTRODE CAPACITANCE:		
Grid No.1 to All Other Electrodes.....	9	μf
Maximum Ratings:		
ANODE-NO.2 VOLTAGE.....	7000 max	volts
ANODE-NO.1 VOLTAGE.....	2000 max	volts
GRID-NO.2 VOLTAGE.....	300 max	volts
GRID-NO.1 VOLTAGE:		
Negative bias value.....	125 max	volts
Positive bias value.....	0 max	volts
Positive peak value.....	2 max	volts

**Typical Operation:**

Anode-No.2 Voltage.....	6000	7000	volts
Anode-No.1 Voltage Range.....	1020 to 1530	1192 to 1788	volts
Grid-No.2 Voltage.....	250	250	volts
Grid-No.1 Voltage for Visual Extinction of			
Undelected Focused Spot.....	-20 to -60	-20 to -60	volts

**Maximum Circuit Value:**

 Grid-No.1-Circuit Resistance . . . . . 5 *max* megohms

¶ Brilliance and definition decrease with decreasing anode-No.2 voltage. In general, anode-No.2 voltage should not be less than 6000 volts.

## TWIN DIODE— HIGH-MU TRIODE

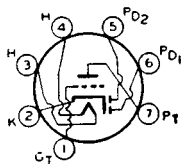

Miniature type used as a combined detector, amplifier, and avc tube in compact ac/dc radio receivers. Outline 12, OUTLINES SECTION. Heater volts (ac/dc), 12.6; amperes, 0.15. Except for the heater rating, this type is identical with miniature type 6AT6.

# 12AT6

## HIGH-MU TWIN TRIODE

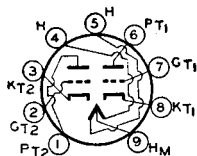

Miniature type used as grounded-grid amplifier or frequency converter in the FM and television broadcast bands. Outline 13, OUTLINES SECTION. Tube requires noval nine-contact socket and may be mounted in any position. Each triode unit is independent of the other except for the common heater.

# 12AT7

<b>HEATER ARRANGEMENT</b>	<i>Series</i>	<i>Paralle</i>	
HEATER VOLTAGE (AC/DC) . . . . .	12.6	6.3	volts
HEATER CURRENT . . . . .	0.15	0.3	ampere
<b>DIRECT INTERELECTRODE CAPACITANCES (No external shield):</b>			
Grid to Grid . . . . .	0.005 <i>max</i>		μf
Plate to Plate . . . . .	0.4 <i>max</i>		μf
<i>Grounded-Cathode Operation</i>			
Grid to Plate (Each Unit) . . . . .	1.5		μf
Input (Each Unit) . . . . .	2.2		μf
Output (Unit No.1) . . . . .	0.5		μf
Output (Unit No.2) . . . . .	0.4		μf
Heater to Cathode (Each Unit) . . . . .	2.4		μf
<i>Grounded-Grid Operation</i>			
Plate to Cathode (Each Unit) . . . . .	0.2		μf
Input (Cathode to Heater and Grid—Each Unit) . . . . .	4.6		μf
Output (Plate to Heater and Grid—Each Unit) . . . . .	1.8		μf

### Maximum Ratings: CLASS A<sub>1</sub> AMPLIFIER (Each Unit)

PLATE VOLTAGE . . . . .	300 <i>max</i>	volts
GRID VOLTAGE, Negative Bias Value . . . . .	-50 <i>max</i>	volts
PLATE DISSIPATION . . . . .	2.5 <i>max</i>	watts
<b>PEAK HEATER-CATHODE VOLTAGE:</b>		
Heater negative with respect to cathode . . . . .	90 <i>max</i>	volts
Heater positive with respect to cathode . . . . .	90 <i>max</i>	volts

**Characteristics:**

Plate Voltage . . . . .	100	250	volts
Cathode Resistor . . . . .	270	200	ohms
Amplification Factor . . . . .	60	60	
Plate Resistance (Approx.) . . . . .	15000	10900	ohms
Transconductance . . . . .	4000	5500	μmhos
Grid Bias (Approx.) for plate current of 10 μa . . . . .	-5	-12	volts
Plate Current . . . . .	3.7	10	ma

**AVERAGE PLATE CHARACTERISTICS  
FOR EACH UNIT**

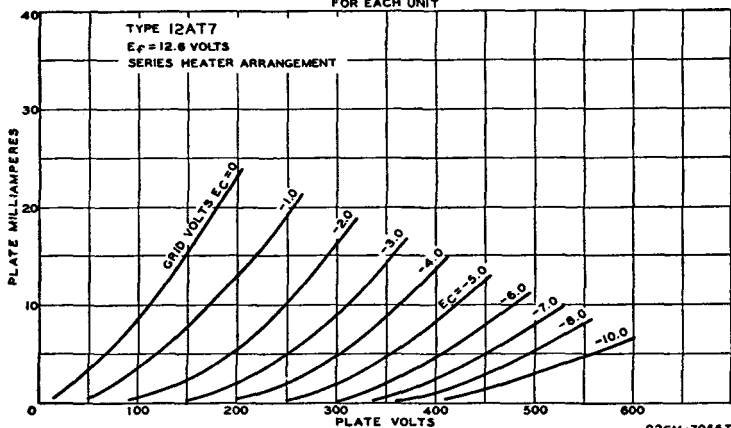

## 12AU6

**SHARP-CUTOFF PENTODE**

Miniature type used in compact ac/dc radio equipment as an rf amplifier especially in high-frequency, wide-band applications. Outline 12, OUTLINES SECTION. Heater volts (ac/dc), 12.6; amperes, 0.15. Except for heater rating, this type is identical with miniature type 6AU6.

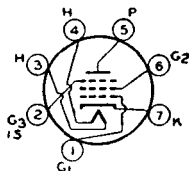

## 12AU7

### MEDIUM-MU TWIN TRIODE

Miniature type used as phase inverter or amplifier in ac/dc radio equipment and in many diversified applications such as multivibrators or oscillators in industrial control devices.

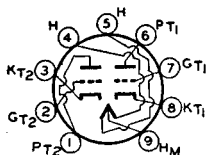

Outline 13, OUTLINES SECTION. Tube requires noval nine-contact socket and may be mounted in any position. Its characteristics are similar to glass-octal type 6SN7-GT. Each triode unit is independent of the other except for the common heater. For typical operation as a resistance-coupled amplifier, refer to Chart 10, RESISTANCE-COUPLED AMPLIFIER SECTION.

HEATER ARRANGEMENT	<i>Series</i>	<i>Parallel</i>	
HEATER VOLTAGE (AC/DC) .....	12.6	6.3	volts
HEATER CURRENT .....	0.15	0.3	ampere
DIRECT INTERELECTRODE CAPACITANCES (No external shield):			
	<i>Triode Unit T<sub>1</sub></i>	<i>Triode Unit T<sub>2</sub></i>	
Grid to Plate .....	1.5	1.5	$\mu\text{f}$
Input .....	1.6	1.6	$\mu\text{f}$
Output .....	0.40	0.32	$\mu\text{f}$

**Maximum Ratings:**

**CLASS A<sub>1</sub> AMPLIFIER**

PLATE VOLTAGE .....	300 <i>max</i>	volts
PLATE DISSIPATION .....	2.75 <i>max</i>	watts
CATHODE CURRENT .....	20 <i>max</i>	ma
<b>GRID VOLTAGE:</b>		
Negative bias value .....	50 <i>max</i>	volts
Positive bias value .....	0 <i>max</i>	volts
<b>PEAK HEATER-CATHODE VOLTAGE:</b>		
Heater negative with respect to cathode .....	180 <i>max</i>	volts
Heater positive with respect to cathode .....	180 <i>max</i>	volts

**Characteristics:**

Plate Voltage.....	100	250	volts
Grid Voltage.....	0	-8.5	volts
Amplification Factor.....	20	17	
Plate Resistance (Approx.).....	6500	7700	ohms
Transconductance.....	3100	2200	$\mu$ mhos
Grid Bias (Approx.) for plate current of 10 $\mu$ a.....	-	-24	volts
Plate Current.....	11.8	10.5	ma

**Maximum Circuit Values (For maximum rated conditions):**

Grid-Circuit Resistance {	Cathode Bias.....	1.0 max	megohm
	Fixed Bias.....	0.25 max	megohm

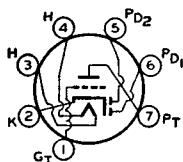
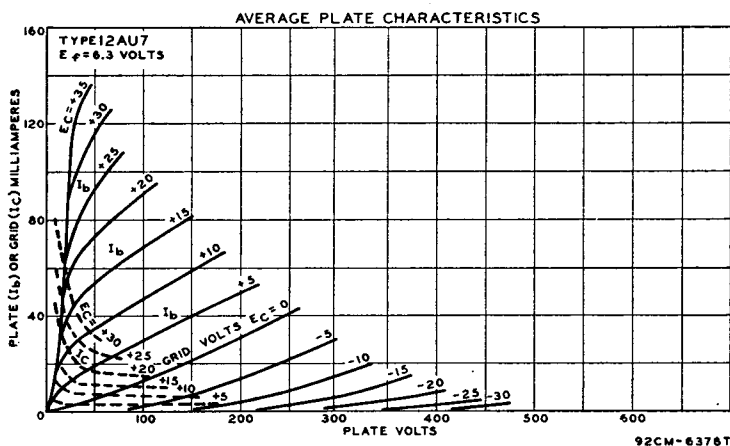

### TWIN DIODE— HIGH-MU TRIODE

Miniature type used as combined detector, amplifier, and avc tube in automobile and ac-operated receivers. Outline 12, OUTLINES SECTION.

## 12AV6

Heater volts (ac/dc), 12.6; amperes, 0.15. Except for heater rating, this type is identical with miniature type 6AV6.

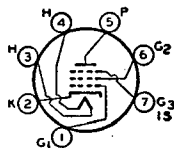

### SHARP-CUTOFF PENTODE

Miniature type used as an rf or if amplifier up to 400 megacycles in compact ac/dc FM receivers. Outline 12, OUTLINES SECTION. Tube requires miniature seven-contact socket

## 12AW6

and may be mounted in any position. Heater volts (ac/dc), 12.6; amperes, 0.15. Except for heater ratings and terminal connections, this type is identical with miniature type 6AG5.

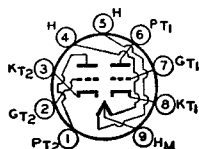

### HIGH-MU TWIN TRIODE

Miniature type used as phase inverter or resistance-coupled amplifier in radio equipment and in many diversified applications such as multivibrators or oscillators in industrial control

## 12AX7

devices. Outline 13, OUTLINES SECTION. Tube requires noval nine-contact socket and may be mounted in any position. Its characteristics are similar to glass-octal type 6SL7-GT. Each triode unit is independent of the other except for the common heater. For characteristics and curves, refer to type 6AV6. For typical operation as a resistance-coupled amplifier, refer to Chart 25, RESISTANCE-COUPLED AMPLIFIER SECTION.

<b>HEATER ARRANGEMENT</b>	<i>Series</i>	<i>Parallel</i>	
HEATER VOLTAGE (AC/DC).....	12.6	6.3	volts
HEATER CURRENT.....	0.15	0.3	ampere
DIRECT INTERELECTRODE CAPACITANCES (No external shield):			
	<i>Triode Unit T<sub>1</sub></i>	<i>Triode Unit T<sub>2</sub></i>	
Grid to Plate.....	1.7	1.7	$\mu\text{f}$
Input.....	1.6	1.6	$\mu\text{f}$
Output.....	0.46	0.34	$\mu\text{f}$

**Maximum Ratings:**

<b>PLATE VOLTAGE</b> .....	300 <i>max</i>		volts
<b>PLATE DISSIPATION</b> .....	1 <i>max</i>		watt
<b>GRID VOLTAGE:</b>			
Negative bias value.....	50 <i>max</i>		volts
Positive bias value.....	0 <i>max</i>		volts
<b>PEAK HEATER-CATHODE VOLTAGE:</b>			
Heater negative with respect to cathode.....	180 <i>max</i>		volts
Heater positive with respect to cathode.....	180 <i>max</i>		volts

### CLASS A<sub>1</sub> AMPLIFIER

### TRIODE—PENTODE

Glass octal type used as combined detector and rf or if amplifier in ac/dc receivers. Heater volts (ac/dc), 12.6; amperes, 0.3. Characteristics of triode unit: plate volts, 90; grid volts, 0; amplification factor, 90; plate resistance, 37000 ohms; transconductance, 2400  $\mu\text{mhos}$ ; plate ma., 2.8. Characteristics of pentode unit: plate volts, 90; grid-No.2 volts, 90; grid-No.1 volts,

-3; plate resistance, 200000 ohms; transconductance, 1800  $\mu\text{mhos}$ ; grid-No.1 volts for transconductance of 2  $\mu\text{mhos}$ , -42.5; plate ma., 7; grid-No.2 ma., 2. This is a DISCONTINUED type listed for reference only.

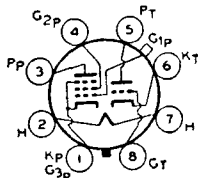

## 12B8-GT

### REMOTE-CUTOFF PENTODE

Miniature type used as rf amplifier in ac/dc standard broadcast receivers, in FM receivers, and in other wide-band, high-frequency applications. Outline 12, OUTLINES SECTION. Heater volts (ac/dc), 12.6; amperes, 0.15. Except for heater ratings, this type is identical with miniature type 6BA6.

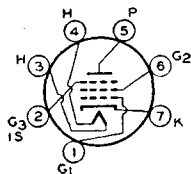

## 12BA6

### PENTAGRID CONVERTER

Miniature type used as converter in ac/dc superheterodyne circuits especially those for the FM broadcast band. Outline 16, OUTLINES SECTION. Heater volts (ac/dc), 12.6; am-

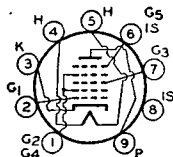

## 12BA7

peres, 0.15. Except for heater rating, this type is identical with miniature type 6BA7.

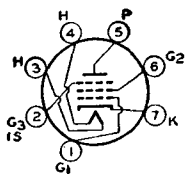

**REMOTE-CUTOFF PENTODE**

Miniature type used as rf or amplifier in radio receivers. Outline 12, OUTLINES SECTION. Heater volts (ac/dc), 12.6; amperes, 0.15. Except for heater rating, this type is identical with miniature type 6BD6.

**12BD6**

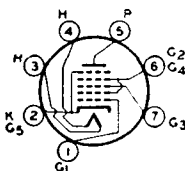

**PENTAGRID CONVERTER**

Miniature type used as converter in ac/dc receivers for both standard broadcast and FM bands, Outline 12, OUTLINES SECTION. Heater volts (ac/dc), 12.6; amperes, 0.15. Except for heater rating, this type is identical with miniature type 6BE6.

**12BE6**

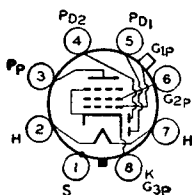

**TWIN DIODE—REMOTE-CUTOFF PENTODE**

Metal type used as combined detector, amplifier, and avc tube in ac/dc receivers. Outline 4, OUTLINES SECTION. Heater volts (ac/dc), 12.6; amperes, 0.15. Except for heater rating, this type is identical with metal type 6B8.

**12C8**

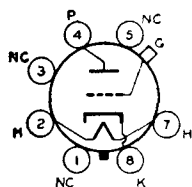

**HIGH-MU TRIODE**

Glass octal type used in resistance-coupled amplifier circuits of ac/dc receivers. Outline 20, OUTLINES SECTION. Heater volts (ac/dc), 12.6; amperes, 0.15. Except for heater rating, this type is identical with glass-octal type 6F5-GT.

**12F5-GT**

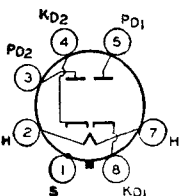

**TWIN DIODE**

Metal type used as detector, low-voltage rectifier, or avc tube in ac/dc radio receivers. Outline 1, OUTLINES SECTION. Heater volts (ac/dc), 12.6; amperes, 0.15. Except for heater rating, this type is identical with metal type 6H6.

**12H6**

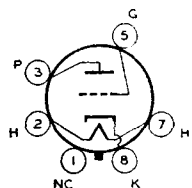

**MEDIUM-MU TRIODE**

Glass octal type used as detector, amplifier, or oscillator in ac/dc radio equipment. Outline 24, OUTLINES SECTION. Heater volts (ac/dc), 12.6; amperes, 0.15. Except for heater rating, this type is identical with glass-octal type 6J5-GT.

**12J5-GT**

# 12J7-GT

## SHARP-CUTOFF PENTODE

Glass octal type used as biased detector or high-gain audio amplifier in ac/dc radio receivers. Outline 23, OUTLINES SECTION. Heater volts (ac/dc), 12.6; amperes, 0.15. Except for heater rating, this type is identical with glass-octal type 6J7-GT.

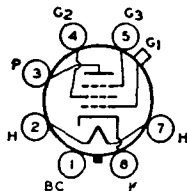

# 12K7-GT

## REMOTE-CUTOFF PENTODE

Glass octal type used as rf or if amplifier in ac/dc radio receivers particularly those employing avc. Outline 23, OUTLINES SECTION. Heater volts (ac/dc), 12.6; amperes, 0.15. Except for heater rating, this type is identical with glass-octal type 6K7-GT.

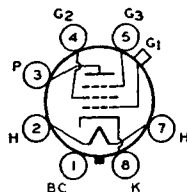

# 12K8

## TRIODE—HEXODE CONVERTER

Metal type used as combined triode oscillator and hexode mixer in ac/dc radio receivers. Outline 5, OUTLINES SECTION. Heater volts (ac/dc), 12.6; amperes, 0.15. Except for heater rating, this type is identical with metal type 6K8.

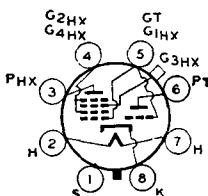

# 12KP4-A

## KINESCOPE

For technical data see page 308.

# 12LP4 12LP4-A

## KINESCOPE

Directly viewed picture tube used in television receivers. Both types feature a high-efficiency, white fluorescent screen utilizing phosphor No.4 of the sulfide type on a practically flat face

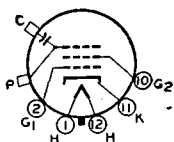

plate. The face plate of the 12LP4-A is made of RCA "Filterglass" to provide increased contrast. Type 12LP4-A supersedes type 12LP4. Both types have a deflection angle of approximately 57°, contain an ion-trap electron gun requiring an external, double-field magnet, and utilize magnetic focus and magnetic deflection to provide a rounded-end picture 11 3/8 x 8 1/2 inches or a rectangular picture with rounded corners about 10 x 7 1/2 inches.

HEATER VOLTAGE (AC/DC).....	6.3	volts
HEATER CURRENT.....	0.6	ampere
DIRECT INTERELECTRODE CAPACITANCES (Approx.):		
Grid No.1 to All Other Electrodes.....	6	μf
Cathode to All Other Electrodes.....	5	μf
External Conductive Coating to Anode.....	{ 2000 max 750 min	{ μf μf

### Maximum Ratings:

ANODE VOLTAGE*.....	12000 max	volts
GRID-NO.2 VOLTAGE.....	410 max	volts
GRID-NO.1 VOLTAGE:		
Negative bias value.....	125 max	volts
Positive bias value.....	0 max	volts
Positive peak value.....	2 max	volts



**PEAK HEATER-CATHODE VOLTAGE:**

Heater negative with respect to cathode:

During equipment warm-up period not exceeding 15 seconds. . . . .	410 <i>max</i>	volts
After equipment warm-up period. . . . .	150 <i>max</i>	volts
Heater positive with respect to cathode. . . . .	150 <i>max</i>	volts

**Typical Operation:**

Anode Voltage** . . . . .	9000	11000	volts
Grid-No.2 Voltage . . . . .	250	250	volts
Grid-No.1 Voltage for Visual Extinction of Undelected Focused Spot. . . . .	-27 to -63	-27 to -63	volts

**Maximum Circuit Value:**

Grid-No.1-Circuit Resistance. . . . .	1.5 <i>max</i>	megohms
---------------------------------------	----------------	---------

\* The product of anode voltage and average anode current should be limited to 6 watts.

\*\* Brilliance and definition decrease with decreasing anode voltage. In general, the anode voltage should not be less than 9000 volts.

## INSTALLATION AND APPLICATION

Type 12LP4-A is designed for use with a duodecal five-contact segment socket; the 12LP4 is designed for use with the duodecal twelve-contact socket. Both types may be mounted in any position. The socket should not be used to support the tube, but should have flexible leads and be allowed to move freely. The tube should be supported by a cushioned ring or saddle arrangement near the screen end of the tube, and by the deflecting yoke. The conductive coating on the exterior of the bulb must be grounded. Connecting to the coating may be made by means of a soft brush contact attached to the deflecting yoke. A contact area of at least 1/4 square inch should be used in making this connection to the external coating. Outline 48, OUTLINES SECTION.

For installation and handling considerations, refer to the ELECTRON TUBE INSTALLATION SECTION.

The *recommended sequence of adjustments* in lining up the 12LP4-A with its associated components is as follows:

1. Place the deflecting yoke on the tube neck and press it firmly against the bulb cone. Space the focusing device at least 1/2 inch back of the end of the deflecting-coil windings, coaxial with the neck. Next, position the ion-trap magnet on the neck so that the stronger of its two magnets is approximately over the internal pole pieces (see Outline Drawing) and the weaker is toward the face of the tube.

2. Apply operating voltages to the tube and adjust the grid-No.1 voltage to a value at least as high as midway between zero and cutoff.

3. With grid-No.1 voltage adjusted as indicated in (2) to give low anode current, *immediately* adjust the position of the ion-trap magnet by moving it a short distance forward or backward and rotating it slightly until maximum light output at the center of the raster is obtained. *It is important that this adjustment be made with low anode current and without delay after the operating voltages are applied.* Operation of the tube with ion-trap magnet improperly positioned will damage the tube. If the anode voltage supply is not of the limited-energy type, damage may occur very quickly.

4. Focus the pattern by adjusting the focusing-coil field strength. Then, adjust grid-No.1 drive and grid-No.1 voltage to obtain a picture of *normal* brightness.

5. Center the pattern. The procedure depends on the method of centering employed, which will vary with different receiver designs. If a shadow appears at the edge of the raster, the deflecting-yoke position should be checked to make sure

that the yoke bears against the bulb cone; and any remaining shadow should be eliminated by adjusting the position of the focusing device. The position of the ion-trap magnet should not be adjusted to eliminate shadow if the center screen brightness is thereby reduced.

6. Readjust the position of the ion-trap magnet for maximum light output, if necessary. Bowing of opposite sides of the raster in the same direction may occur if the ion-trap has improper rotational position, or if the focusing field is so close as to interact with the field of the ion-trap magnet.

7. Readjust centering, if necessary. If this step requires appreciable change in focusing-device position, it should be followed by a recheck of the ion-trap-magnet position (Step 6).

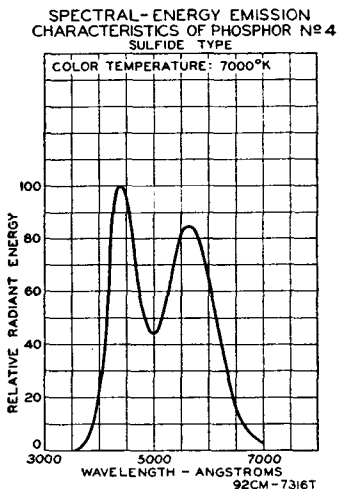

**TWIN DIODE—  
HIGH-MU TRIODE**

**12Q7-GT**

Glass octal type used as combined detector, amplifier, and avc tube in ac/dc radio receivers. Outline 23, OUTLINES SECTION. Heater volts (ac/dc), 12.6; amperes, 0.15. Except for heater rating, this type is identical with glass-octal type 6Q7-GT.

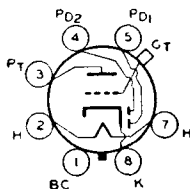

**TRIPLE DIODE—HIGH-MU TRIODE**

**12S8-GT**

Glass octal type used as audio amplifier, AM detector, and FM detector in AM/FM receivers. Outline 27, OUTLINES SECTION. Heater volts (ac/dc), 12.6; amperes, 0.15. Except for heater rating, this type is identical with glass octal type 6S8-GT.

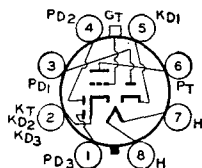

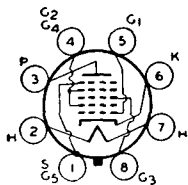

**PENTAGRID CONVERTER**

**12SA7**

Metal type 12SA7 and glass-octal type 12SA7-GT used as converter in ac/dc receivers. Outlines 3 and 22, respectively, OUTLINES SECTION. Heater volts (ac/dc), 12.6; amperes, 0.15. Except for heater ratings, type 12SA7 is identical with metal type 6SA7, and type 12SA7-GT is identical with glass-octal type 6SA7-GT.

**12SA7-GT**

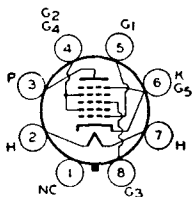

**HIGH-MU TWIN TRIODE**

**12SC7**

Metal type used as phase inverter or voltage amplifier in ac/dc radio equipment. Outline 3, OUTLINES SECTION. Heater volts (ac/dc), 12.6; amperes, 0.15. Except for heater rating, this type is identical with metal type 6SC7.

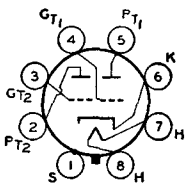

**HIGH-MU TRIODE**

**12SF5  
12SF5-GT**

Metal type 12SF5 and glass-octal type 12SF5-GT used in resistance-coupled amplifier circuits of ac/dc radio equipment. Outlines 3 and 22, respectively, OUTLINES SECTION. Heater volts (ac/dc), 12.6; amperes, 0.15. Except for heater rating, type 12SF5 is identical with metal type 6SF5, and type 12SF5-GT is identical with glass-octal type 6SF5-GT. Type 12SF5-GT is a DISCONTINUED type listed for reference only.

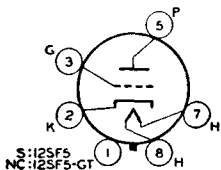

**DIODE—**

**REMOTE-CUTOFF PENTODE**

**12SF7**

Metal type used as combined rf or if amplifier and detector or avc tube in ac/dc radio receivers. Outline 3, OUTLINES SECTION. Heater volts (ac/dc), 12.6; amperes, 0.15. Except for heater rating, this type is identical with metal type 6SF7.

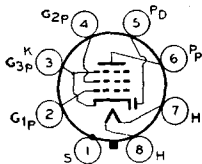

**REMOTE-CUTOFF PENTODE**

**12SG7**

Metal type used as rf amplifier in ac/dc receivers involving high-frequency, wide-band applications. Outline 3, OUTLINES SECTION. Heater volts (ac/dc), 12.6; amperes, 0.15. Except for heater rating, this type is identical with metal type 6SG7.

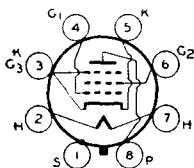

**SHARP-CUTOFF PENTODE**

**12SH7**

Metal type used as rf amplifier in ac/dc receivers involving high-frequency, wide-band applications and as limiter tube in FM equipment. Outline 3, OUTLINES SECTION. Heater volts (ac/dc), 12.6; amperes, 0.15. Except for heater rating, this type is identical with metal type 6SH7.

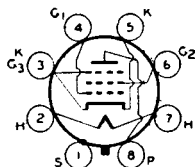

**SHARP-CUTOFF PENTODE**

**12SJ7  
12SJ7-GT**

Metal type 12SJ7 and glass-octal type 12SJ7-GT used as rf amplifiers and biased detectors in ac/dc radio receivers. Outlines 3 and 24, respectively, OUTLINES SECTION.

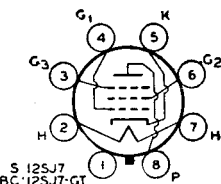

Heater volts (ac/dc), 12.6; amperes, 0.15. Except for heater rating, type 12SJ7 is identical with metal type 6SJ7, and type 12SJ7-GT is identical with glass-octal type 6SJ7-GT.

**REMOTE-CUTOFF PENTODE**

**12SK7  
12SK7-GT**

Metal type 12SK7 and glass-octal type 12SK7-GT used as rf and if amplifiers in ac/dc radio receivers. Outlines 3 and 24, respectively, OUTLINES SECTION. Heater volts

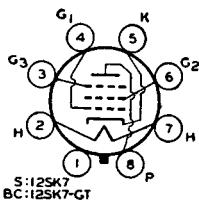

(ac/dc), 12.6; amperes, 0.15. Except for heater rating, type 12SK7 is identical with metal type 6SK7, and type 12SK7-GT is identical with glass-octal type 6SK7-GT.

**HIGH-MU TWIN TRIODE**

**12SL7-GT**

Glass octal type used as phase inverter or resistance-coupled amplifier in ac/dc radio equipment. Outline 22, OUTLINES SECTION. Heater volts (ac/dc), 12.6; amperes, 0.15. Except for heater rating, this type is identical with glass-octal type 6SL7-GT.

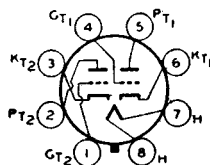

**MEDIUM-MU TWIN TRIODE**

**12SN7-GT**

Glass octal type used as phase inverter or resistance-coupled amplifier in ac/dc radio equipment. Outline 22, OUTLINES SECTION. Heater volts (ac/dc), 12.6; amperes, 0.3. Except for heater rating, this type is identical with glass-octal type 6SN7-GT.

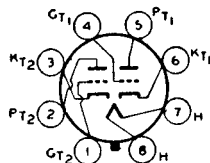

**TWIN DIODE—  
HIGH-MU TRIODE**

**12SQ7  
12SQ7-GT**

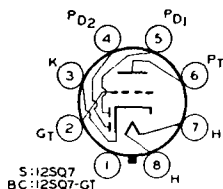

Metal type 12SQ7 and glass-octal type 12SQ7-GT used as combined detector, amplifier, and avc tube in ac/dc radio receivers. Outlines 3 and 24, respectively, OUTLINES SECTION.

Heater volts (ac/dc), 12.6; amperes, 0.15. Except for heater rating, type 12SQ7 is identical with metal type 6SQ7, and type 12SQ7-GT is identical with glass-octal type 6SQ7-GT.

**TWIN DIODE—MEDIUM-MU TRIODE**

**12SR7  
12SR7-GT**

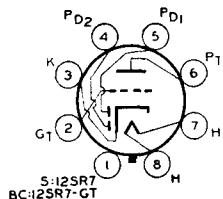

Metal type 12SR7 and glass-octal type 12SR7-GT used as combined detector, amplifier, and avc tube in ac/dc radio receivers. Outlines 3 and 22, respectively, OUTLINES SECTION. Heater volts (ac/dc), 12.6; amperes, 0.15. Except for heater rating, type 12SR7 is identical with type 6SR7, and type 12SR7-GT is electrically identical with type 6SR7 except for interelectrode capacitances. The 12SR7-GT is a DISCONTINUED type listed for reference only. Both types are similar in performance to miniature type 6BF6.

**HALF-WAVE VACUUM RECTIFIER**

**12Z3**

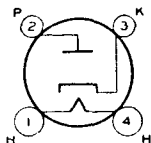

Glass type used in power supply of ac/dc receivers. Outline 32, OUTLINES SECTION. Tube requires four-contact socket and may be mounted in any position. It is especially important that this tube, like other power-handling tubes, should be adequately ventilated. Use of capacitor-input filter recommended in order to obtain as high a dc output voltage as

possible. Heater volts (ac/dc), 12.6; amperes, 0.3. Maximum ratings as half-wave rectifier: peak inverse plate volts, 700 max; peak plate ma 330 max; dc output ma., 55 max; peak heater-cathode volts, 350 max. With typical operating ac plate voltages of 117, 150, and 235 volts rms, the minimum total effective plate-supply impedance required is 0, 30, and 75 ohms, respectively. This type is used principally for renewal purposes.

**MEDIUM-MU TRIODE**

**14A4**

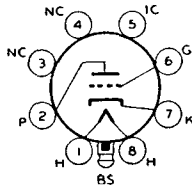

Glass lock-in type used as detector, amplifier, or oscillator in ac/dc radio receivers. Outline 14, OUTLINES SECTION. Tube requires lock-in socket. Heater volts (ac/dc), 12.6; amperes, 0.15. Except for heater rating and capacitances, this type is electrically identical with lock-in type 7A4 and metal type 6J5. The application of this type is similar to that of glass-octal type 12J5-GT.

**BEAM POWER AMPLIFIER**

**14A5**

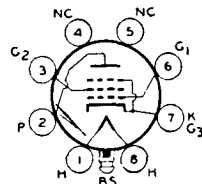

Glass lock-in type used as output amplifier in ac/dc radio receivers. Outline 14, OUTLINES SECTION. Tube requires lock-in socket. Heater volts (ac/dc), 12.6; amperes, 0.15. Typical operation and ratings as class A<sub>1</sub> amplifier: plate volts and grid-No.2 volts, 250 (300 max); plate dissipation, 7.5 watts; grid-No.2 input, 1.5 volts; grid-No.1 volts, -12.5; plate ma., 32;

grid-No.2 ma., 5.5; plate resistance, 70000 ohms; transconductance, 3000 μmhos; load resistance, 7500 ohms; output watts, 2.8.

**REMOTE-CUTOFF PENTODE**

Glass lock-in type used as rf or if amplifier in ac/dc radio receivers. Outline 14, OUTLINES SECTION. Tube requires lock-in socket. Heater volts (ac/dc), 12.6; amperes, 0.15. Except for heater rating and capacitances, this type is electrically identical with metal type 6SK7 and lock-in type 7A7. The application of this type is similar to that of metal type 12SK7.

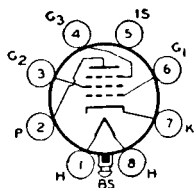

**MEDIUM-MU TWIN TRIODE**

Glass lock-in type used as voltage amplifier or phase inverter in radio equipment. Outline 14, OUTLINES SECTION. Tube requires lock-in socket. Heater volts (ac/dc), 12.6; amperes, 0.15. Except for heater ratings, this type is electrically identical with lock-in type 7AF7.

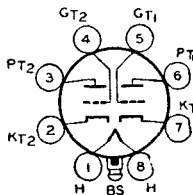

**TWIN DIODE—HIGH-MU TRIODE**

Glass lock-in type used as combined detector, amplifier, and avc tube in ac/dc radio receivers. Outline 14, OUTLINES SECTION. Tube requires lock-in socket. Heater volts (ac/dc), 12.6; amperes, 0.15. Except for heater rating and capacitances, this type is electrically identical with lock-in type 7B6 and metal type 6SQ7. The application of this type is similar to that of metal type 12SQ7.

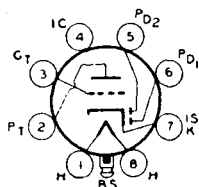

**PENTAGRID CONVERTER**

Glass lock-in type used as converter in ac/dc radio receivers. Outline 14, OUTLINES SECTION. Tube requires lock-in socket. Heater volts (ac/dc), 12.6; amperes, 0.15. Except for heater rating and capacitances, this type is electrically identical with lock-in type 7B8 and metal type 6A8. The application of this type is similar to that of glass-octal type 12A8-GT.

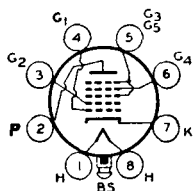

**BEAM POWER AMPLIFIER**

Glass lock-in type used as output amplifier in ac/dc radio receivers. Outline 19, OUTLINES SECTION. Tube requires lock-in socket. Heater volts (ac/dc), 12.6; amperes, 0.225. Except for heater rating, this type is electrically identical with lock-in type 7C5 and metal type 6V6.

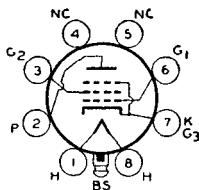

**SHARP-CUTOFF PENTODE**

Glass lock-in type used as rf amplifier and biased detector in ac/dc radio receivers. Outline 14, OUTLINES SECTION. Tube requires lock-in socket. Heater volts (ac/dc), 12.6; amperes, 0.15. Typical operation and maximum ratings as class A<sub>1</sub> amplifier: plate volts, 250 (300 max); grid-No.2 volts, 100 max; plate dissipation, 1 max watt; grid-No.2 input, 0.1

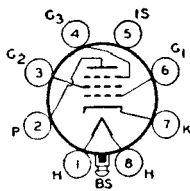

max watt; grid No.1 volts, -3; grid No.3 connected to cathode at socket; plate resistance, greater than 1 megohm; transconductance, 1575 μmhos; plate ma., 2.2; grid-No.2 ma., 0.7. Within the limits of its maximum ratings, this type is similar in performance to metal types 6SJ7 and 12SJ7.

**14CP4**

**KINESCOPE**

For technical data, see page 308.

**TWIN DIODE—MEDIUM-MU TRIODE**

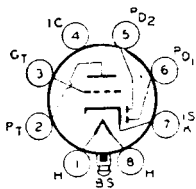

Glass lock-in type used as combined detector, amplifier, and avc tube in ac/dc radio receivers. Outline 14, OUTLINES SECTION. Tube requires lock-in socket. Heater volts, (ac/dc), 12.6; amperes, 0.15. Except for heater rating, this type is electrically identical with lock-in type 7E6 and miniature type 6BF6. The application of this type is similar to that of metal type 12SR7

**14E6**

**TWIN DIODE—REMOTE-CUTOFF PENTODE**

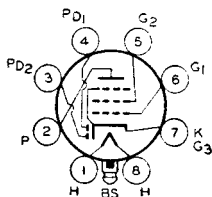

Glass lock-in type used as combined detector, amplifier, and avc tube in ac/dc receivers. Outline 14, OUTLINES SECTION. Tube requires lock-in socket. Heater volts (ac/dc), 12.6; amperes, 0.15. Except for heater rating, this type is electrically identical with lock-in type 7E7.

**14E7**

**KINESCOPE**

For technical data, see page 309.

**14EP4**

**HIGH-MU TWIN TRIODE**

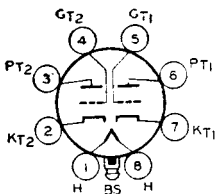

Glass lock-in type used as phase inverter or resistance-coupled amplifier in ac/dc radio receivers. Outline 14, OUTLINES SECTION. Tube requires lock-in socket. Heater volts (ac/dc), 12.6; amperes, 0.15. Except for heater rating, this type is electrically identical with lock-in type 7F7 and glass-octal type 6SL7-GT. The application of this type is similar to that of glass-octal type 12SL7-GT.

**14F7**

**MEDIUM-MU TWIN TRIODE**

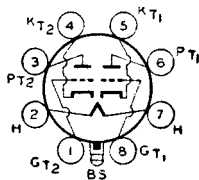

Glass lock-in type used as amplifier or oscillator in ac/dc radio equipment. Outline 10, OUTLINES SECTION. Tube requires lock-in socket. Heater volts (ac/dc), 12.6; amperes, 0.15. Except for heater rating, this type is electrically identical with lock-in type 7F8.

**14F8**

**REMOTE-CUTOFF PENTODE**

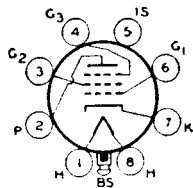

Glass lock-in type used as rf or if amplifier in ac/dc radio receivers. Outline 14, OUTLINES SECTION. Tube requires lock-in socket. Heater volts (ac/dc), 12.6; amperes, 0.15. Except for heater rating, this type is electrically identical with lock-in type 7H7. The application of this type is similar to that of miniature type 12BA6.

**14H7**

**TRIODE—HEPTODE CONVERTER**

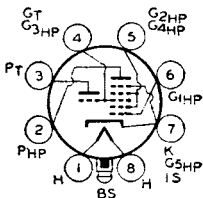

Glass lock-in type used as combined triode oscillator and heptode mixer in ac/dc radio receivers. Outline 14, OUTLINES SECTION. Tube requires lock-in socket. Heater volts (ac/dc), 12.6; amperes, 0.15. Except for heater rating, this type is electrically identical with lock-in type 7J7.

**14J7**

**MEDIUM-MU TWIN TRIODE**

Glass lock-in type used as voltage amplifier or phase inverter in ac/dc radio equipment. Outline 19, OUTLINES SECTION. Tube requires lock-in socket. Heater volts (ac/dc), 12.6; amperes, 0.3. Except for heater rating and capacitance, this type is electrically identical with lock-in type 7N7 and glass-octal type 6SN7-GT. The application of this type is similar to that of glass-octal type 12SN7-GT.

**14N7**

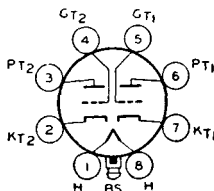

**PENTAGRID CONVERTER**

Glass lock-in type used as converter in ac/dc radio receivers. Outline 14, OUTLINES SECTION. Tube requires lock-in socket. Heater volts (ac/dc), 12.6; amperes, 0.15. Except for heater ratings and capacitance, this type is electrically identical with metal type 6SA7 and lock-in type 7Q7. The application of this type is similar to that of metal type 12SA7.

**14Q7**

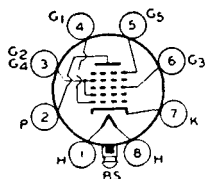

**TWIN DIODE—**

**REMOTE-CUTOFF PENTODE**

Glass lock-in type used as combined detector, amplifier, and avc tube in ac/dc radio receivers. Outline 14, OUTLINES SECTION. Tube requires lock-in socket. Heater volts (ac/dc), 12.6; amperes, 0.15. Except for heater rating, this type is electrically identical with lock-in type 7R7.

**14R7**

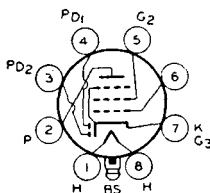

**SHARP-CUTOFF PENTODE**

Glass type used as rf amplifier in battery operated receivers. Outline 34, OUTLINES SECTION. Tube requires five-contact socket. Heater volts (dc), 2.0; amperes, 0.22. Typical operation as class A<sub>1</sub> amplifier: plate volts, 135 max; grid-No.2 (screen) volts, 67.5 max; grid-No.1 volts, -1.5; plate ma., 1.85; grid-No.2 ma., 0.3; plate resistance, 0.80 megohm; transconductance, 750 μmhos. This is a DISCONTINUED type listed for reference only.

**15**

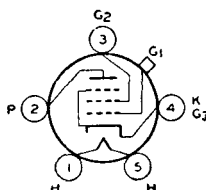

**KINESCOPE**

Directly viewed picture tubes of the metal-cone type used in television receivers. Type 16AP4-A features a high-efficiency, white fluorescent screen on a practically flat face made of RCA

**16AP4**  
**16AP4-A**

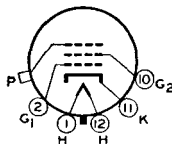

“Filterglass” to provide increased contrast. Type 16AP4-A supersedes type 16AP4. Both types have a deflection angle of approximately 53°, contain an ion-trap electron gun requiring an external, double-field magnet, and utilize magnetic focus and magnetic deflection to provide a rounded-end picture 14<sup>5</sup>/<sub>8</sub> x 11 inches or a rectangular picture with rounded corners about 13<sup>3</sup>/<sub>4</sub> x 10 inches. Use of the metal-cone envelope not only makes practical a construction which weighs substantially less than a similar all-glass type, but also makes practical the use of a higher-quality face plate than is commonly used on all-glass tubes.



# RCA RECEIVING TUBE MANUAL

HEATER VOLTAGE (AC/DC).....	6.3	volts
HEATER CURRENT.....	0.6	ampere
DIRECT INTERELECTRODE CAPACITANCES (Approx.):		
Grid No.1 to All Other Electrodes.....	6	$\mu\text{f}$
Cathode to All Other Electrodes.....	5	$\mu\text{f}$

### Maximum Ratings:

ANODE VOLTAGE*.....	14000 max	volts
GRID-NO.2 VOLTAGE.....	410 max	volts
GRID-NO.1 VOLTAGE:		
Negative bias value.....	125 max	volts
Positive bias value.....	0 max	volts
Positive peak value.....	2 max	volts
PEAK HEATER-CATHODE VOLTAGE:		
Heater negative with respect to cathode:		
During equipment warm-up period not exceeding 15 seconds.....	410 max	volts
After equipment warm-up period.....	150 max	volts
Heater positive with respect to cathode.....		
	150 max	volts

### Typical Operation:

Anode Voltage**.....	9000	12000	volts
Grid-No.2 Voltage.....	300	300	volts
Grid-No.1 Voltage for Visual Extinction of			
Undelected Focused Spot.....	-33 to -77	-33 to -77	volts

### Maximum Circuit Value:

Grid-No.1-Circuit Resistance.....	1.5 max	megohms
-----------------------------------	---------	---------

\* The product of anode voltage and average anode current should be limited to 6 watts.

\*\* Brilliance and definition decrease with decreasing anode voltage. In general, the anode voltage should not be less than 9000 volts.

## INSTALLATION AND APPLICATION

Type 16AP4-A and 16AP4 are designed for use with either the duodecal five-contact segment socket or the duodecal twelve-contact socket. Both tubes may be mounted in any position. The socket should not be used to support the tube, but should have flexible leads and be allowed to move freely. The tube should be supported by suitable supporting insulators at the large end, and by the deflecting yoke on the neck. Each supporting insulator should have a minimum creepage distance of two inches. The anode connection to the outside of the cone lip can be carried by one of the supporting insulators and can conveniently be a suitable piece of metal on which the lip rests. Outline 52, OUTLINES SECTION.

Because the glass of the face plate does not have especially high electrical resistance, it is essential that any mask material bearing on the face plate have insulating properties adequate for 15500 volts, as well as a minimum creepage distance of two inches. Unless this precaution is observed, picture distortion may result.

Do not allow the metal cone to come in contact with a magnet and thus become permanently magnetized. A magnetized cone can produce localized distortion of the picture edges.

The fluorescent screen of these tubes utilizes phosphor No.4 of the sulfide type which is highly efficient. Refer to type 12LP4-A for curve showing spectral-energy emission characteristic of this phosphor. For installation and handling considerations refer to the ELECTRON TUBE INSTALLATION SECTION. For the recommended sequence of adjustments in lining up the 16AP4-A with its associated components, refer to type 12LP4-A.

**KINESCOPE**  
For technical data, see page 309.

# 16DP4-A

KINESCOPE

- 16GP4
- 16GP4-A
- 16GP4-B
- 16GP4-C

Directly viewed picture tubes of the metal-cone type used in television receivers. Have over-all length of only 17-11/16 inches and feature a high-efficiency, white fluorescent screen on a practically flat face. In the 16GP4-B, the face plate is made of frosted

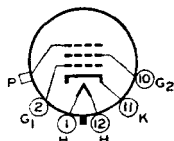

“Filterglass” to provide increased contrast and to diffuse reflections of bright objects which would otherwise be objectionable. Type 16GP4 has an unfrosted “Filterglass” face plate; type 16GP4-A has an unfrosted clear-glass face plate; and type 16GP4-C has a frosted clear-glass face plate. All types have a deflection angle of approximately 70°, contain an ion-trap electron gun requiring an external, single-field magnet, and utilize magnetic focus and magnetic deflection to provide a rounded-end picture 14<sup>5</sup>/<sub>8</sub> x 11 inches or a rectangular picture with rounded corners about 13<sup>1</sup>/<sub>4</sub> x 10 inches. Use of the metal-cone envelope not only makes practical a construction which weighs substantially less than a similar all-glass type, but also makes practical the use of higher-quality face plate than is commonly used on all-glass tubes.

HEATER VOLTAGE (AC/DC).....	6.3	volts
HEATER CURRENT.....	0.6	ampere
DIRECT INTERELECTRODE CAPACITANCES (Approx.):		
Grid No.1 to All Other Electrodes.....	6	μf
Cathode to All Other Electrodes.....	5	μf

Maximum Ratings:

ANODE VOLTAGE*.....	14000 max	volts
GRID-NO.2 VOLTAGE.....	410 max	volts
GRID-NO.1 VOLTAGE:		
Negative bias value.....	125 max	volts
Positive bias value.....	0 max	volts
Positive peak value.....	2 max	volts
PEAK HEATER-CATHODE VOLTAGE:		
Heater negative with respect to cathode:		
During equipment warm-up period not exceeding 15 seconds.....	410 max	volts
After equipment warm-up period.....	180 max	volts
Heater positive with respect to cathode.....	180 max	volts

Typical Operation:

Anode Voltage**.....	12000	volts
Grid-No.2 Voltage.....	300	volts
Grid-No.1 Voltage for Visual Extinction of Undelected Focused Spot..	-33 to -77	volts

Maximum Circuit Value:

Grid-No.1-Circuit Resistance.....	1.5 max	megohms
-----------------------------------	---------	---------

\* The product of anode voltage and average anode current should be limited to 6 watts.

\*\* Brilliance and definition decrease with decreasing anode voltage. In general, the anode voltage should not be less than 9000 volts.

INSTALLATION AND APPLICATION

Types 16GP4, 16GP4-A, 16GP4-B and 16GP4-C are designed for use with either the duodecal five-contact segment socket or the duodecal twelve-contact socket. The socket should not be used to support the tube, but should have flexible leads and be allowed to move freely. The tube should be supported by suitable supporting insulators at the large end, and by the deflecting yoke on the neck. Each supporting insulator should have a minimum creepage distance of two inches. The anode connection to the outside of the cone lip can be carried by one of the supporting insulators and can conveniently be a suitable piece of metal on which the lip rests. Outline 53, OUTLINES SECTION.

Because the glass of the face plate does not have especially high electrical resistance, it is essential that any mask material bearing on the face plate have

insulating properties adequate for 15500 volts, as well as a minimum creepage distance of 2 inches. Unless this precaution is observed, picture distortion may result.

Do not allow the metal cone to come in contact with a magnet and thus become permanently magnetized. A magnetized cone can produce localized distortion of the picture edges. The fluorescent screen of this tube utilizes phosphor No. 4 of the sulfide type which is highly efficient. Refer to type 12LP4-A for curve showing spectral-energy emission characteristic of this phosphor. For installation and handling considerations, refer to ELECTRON TUBE INSTALLATION SECTION.

The recommended sequence of adjustments in lining up the 16GP4, 16GP4-A, 16GP4-B, or 16GP4-C with its associated components is as follows:

1. Place the deflecting yoke on the tube neck and press it firmly against the bulb cone. Then insert a cylindrical liner with a tapered end between base end of the yoke windings and the tube neck. Space the focusing device about  $\frac{1}{2}$  inch back of the deflecting-coil windings and position it coaxially with the tube neck. Next, position the ion-trap magnet on the neck so that its poles are roughly aligned with grid No.2 (see sketch at right).

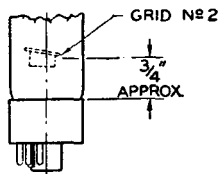

Location of Grid No.2  
in Tube Neck.

2. Apply operating voltages with scanning to the tube and adjust the grid-No.1 voltage to a value about midway between zero and cutoff.

3. Then, promptly rotate the ion-trap magnet and move it slightly forward and backward until the maximum raster brightness is obtained. Readjust grid-No.1 bias to give average picture brightness. Move the ion-trap magnet backward and forward noting both positions at which brightness is diminished, and then locate it halfway between these positions. *It is important that this adjustment be made with low anode current and without delay after the operating voltages are applied.* Operation of the tube with the ion-trap magnet improperly positioned may damage the tube. If the anode voltage supply is not of the limited-energy type, damage may occur very quickly.

4. Focus the pattern by adjusting the focusing-field strength. Then, rotate the deflecting yoke to align the raster with the tube mask and adjust the raster size to fit the mask. Center the raster by adjusting the dc current through the deflecting yoke. If such adjustment is not provided, centering may be obtained by moving the focusing field slightly off center or by tilting the focusing field. The latter method generally produces the most distortion. If a corner of the raster is shadowed, it may be due to excess dc current in the yoke or to incorrect alignment of the components on the tube neck. It may be possible to obtain minor correction by readjustment of the ion-trap magnet. If not, rotate both the tube and the ion-trap magnet approximately  $180^\circ$  and repeat Steps 3 and 4.

5. Vary grid-No.1 drive and grid-No.1 bias through the expected operating range to observe whether shadowing occurs. If a shadow appears near the edges of the raster, first check to be sure that the deflecting yoke bears firmly against the bulb cone; and then eliminate any remaining shadow as explained in Step 4.

## KINESCOPIES

For technical data, see pages 309-312.

16KP4	16LP4
16RP4-A	16TP4
16WP4-A	17BP4-A
17CP4	17CP4-A
17GP4	17TP4

19

**HIGH-MU TWIN POWER TRIODE**

Glass type used in output stage of battery-operated receivers. Outline 32, OUTLINES SECTION. Tube requires six-contact socket. Filament volts (dc), 2.0; amperes, 0.26. Except for filament current, this type is electrically identical with type 1J6-GT. Type 19 is used principally for renewal purposes.

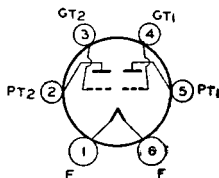

**19AP4**  
**19AP4-A**  
**19AP4-B**  
**19AP4-D**

**KINESCOPE**

Directly viewed picture tubes of the metal-cone type used in television receivers. Feature a high-efficiency, white fluorescent screen. Faceplate of types 19AP4-A and 19AP4-B are made

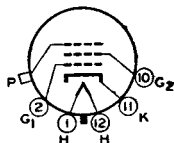

of RCA "Filterglass" to provide increased contrast. Types 19AP4 and 19AP4-D have clear glass faceplates. In types 19AP4-B and 19AP4-D, the faceplate is frosted to diffuse reflections of bright objects which would otherwise be objectionable. All types have a deflection angle of approximately 66°, contain an ion-trap electron gun requiring an external, single-field magnet, and utilize magnetic deflection to provide a rounded-end picture 17<sup>3</sup>/<sub>8</sub> x 13 inches or a rectangular picture with rounded corners about 15<sup>5</sup>/<sub>8</sub> x 11<sup>3</sup>/<sub>4</sub> inches. Use of the metal-cone envelope not only makes practical a construction which weighs substantially less than a similar all-glass type, but also makes practical the use of higher-quality faceplate than is commonly used on all-glass tubes.

HEATER VOLTAGE (AC/DC).....	6.3	volts
HEATER CURRENT.....	0.6	ampere
DIRECT INTERELECTRODE CAPACITANCES (Approx.):		
Grid No.1 to All Other Electrodes.....	7	μf
Cathode to All Other Electrodes.....	5	μf

**Maximum Ratings:**

ANODE VOLTAGE.....	19000 max	volts
GRID-NO.2 VOLTAGE.....	410 max	volts
GRID-NO.1 VOLTAGE:		
Negative bias value.....	125 max	volts
Positive bias value.....	0 max	volts
Positive peak value.....	2 max	volts
PEAK HEATER-CATHODE VOLTAGE:		
Heater negative with respect to cathode:		
During equipment warm-up period not exceeding 15 seconds.....	410 max	volts
After equipment warm-up period.....	150 max	volts
Heater positive with respect to cathode.....	150 max	volts

**Typical Operation:**

Anode Voltage.....	12000	14000	volts
Grid-No.2 Voltage.....	300	300	volts
Grid-No.1 Voltage for Visual Extinction of			
Undelected Focused Spot.....	-33 to -77	-33 to -77	volts

**Maximum Circuit Value:**

Grid-No.1-Circuit Resistance.....	1.5 max	megohms
-----------------------------------	---------	---------

**INSTALLATION AND APPLICATION**

Types 19AP4, 19AP4-A, 19AP4-B and 19AP4-D are designed for use with either the duodecal five-contact segment socket or the duodecal twelve-contact socket. The socket should not be used to support the tube, but should have flexible leads and be allowed to move freely. The tube should be supported by suitable

supporting insulators at the large end, and by the deflecting yoke on the neck. Each supporting insulator should have a minimum creepage distance of two inches when the tube is operated at anode voltages up to 14,000 volts. For anode operating voltages above 14,000 volts a creepage distance greater than two inches is required. The anode connection to the outside of the cone lip can be carried by one of the supporting insulators and can conveniently be a suitable piece of metal on which the lip rests. Outline 54, OUTLINES SECTION.

The fluorescent screen of this tube utilizes phosphor No.4 of the sulfide type. Refer to type 12LP4-A for curve showing spectral-energy emission characteristics of this phosphor. For faceplate, masking, and metal-cone considerations, refer to type 16GP4-B. For installation and handling considerations, refer to ELECTRON TUBE INSTALLATION SECTION.

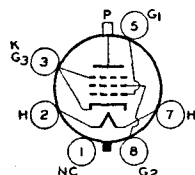

**BEAM POWER AMPLIFIER**

Glass octal type used as output amplifier in horizontal deflection circuits of television equipment of the "transformerless" type where high pulse voltages occur during short-duty cycles. Outline 42, OUTLINES SECTION. Tube requires octal socket. Vertical tube mounting is preferred but horizontal operation is permissible if pins No.2 and 7 are in vertical plane. Heater

**19BG6-G**

volt (ac/dc), 19.8; amperes, 0.3. Except for heater rating and peak heater-cathode voltage rating of 250 volts with heater either negative or positive with respect to cathode, this type is identical with glass octal type 6BG6-G.

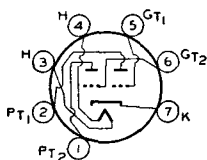

**MEDIUM-MU TWIN TRIODE**

Miniature type used for converter service in ac/dc AM and FM receivers and as oscillator, amplifier, or mixer in television receivers of the "transformerless" type. Outline 12, OUTLINES

**19J6**

SECTION. Tube requires miniature seven-contact socket and may be mounted in any position. For direct interelectrode capacitances, ratings, and typical operation as a class A<sub>1</sub> amplifier, and curves, refer to type 6J6.

HEATER VOLTAGE (AC/DC).....	18.9	volts
HEATER CURRENT.....	0.15	ampere

**MIXER SERVICE**  
Values are for each unit.

<b>Maximum Ratings:</b>		
PLATE VOLTAGE.....	300 max	volts
PLATE DISSIPATION.....	1.5 max	watts
PEAK HEATER-CATHODE VOLTAGE:		
Heater negative with respect to cathode.....	90 max	volts
Heater positive with respect to cathode.....	90 max	volts

**Typical Operation and Characteristics:**

Plate Voltage.....	150	volts
Cathode-Bias Resistor*.....	810	ohms
Peak Oscillator Voltage.....	3	volts
Plate Resistance.....	10200	ohms
Conversion Transconductance.....	1900	μmhos
Plate Current.....	4.8	ma

\* Under maximum rated conditions, the resistance in the grid circuit should not exceed 0.5 megohm with cathode bias. Operation with fixed bias is not recommended.

**TRIPLE DIODE—HIGH-MU TRIODE**

**19T8**

Miniature type used as combined audio amplifier, AM detector, and FM detector in AM/FM receivers of the ac/dc or "transformerless" type. Outline 13, OUTLINES SECTION. Tube

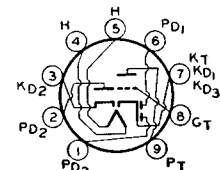

requires noval nine-contact socket and may be mounted in any position. Heater volts (ac/dc), 18.9; amperes, 0.15. Except for heater rating, this type is identical with miniature type 6T8.

**POWER TRIODE**

Glass type used as output amplifier in dry-battery-operated receivers. Filament volts (dc), 3.3; amperes, 0.132. Characteristics as class A<sub>1</sub> amplifier: plate volts, 135 *max*; grid volts, -22.5; plate ma., 6.5; plate resistance, 6300 ohms; amplification factor, 3.3; transconductance, 525  $\mu$ mhos; load resistance, 6500 ohms; output mw., 110. This is a DISCONTINUED type listed for reference only.

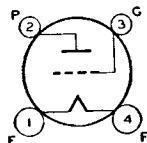

**20**

**20CP4  
21AP4**

**KINESCOPES**

For technical data, see pages 312 and 313.

**SHARP-CUTOFF TETRODE**

Glass type used as rf amplifier in dry-battery-operated receivers. Outline 39, OUTLINES SECTION. Filament volts (dc), 3.3; amperes, 0.132. Characteristics as class A<sub>1</sub> amplifier: plate volts, 135 *max*; grid-No.2 (screen) volts, 67.5 *max*; grid-No.1 volts, -1.5; plate ma., 3.7; grid-No.2 ma., 1.3; plate resistance, 325000 ohms; transconductance, 500  $\mu$ mhos. This is a DISCONTINUED type listed for reference only.

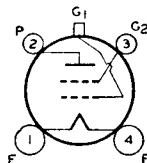

**22**

**SHARP-CUTOFF TETRODE**

Glass type used as rf amplifier or biased detector in ac-operated receivers. Outline 39, OUTLINES SECTION. Tube requires five-contact socket. Heater volts (ac/dc), 2.5; amperes, 1.75. Typical operation and maximum ratings as class A<sub>1</sub> amplifier: plate volts, 250 (275 *max*); grid-No.2 volts, 90 *max*; grid-No.1 volts, -3; plate resistance, 0.6 megohm; trans-

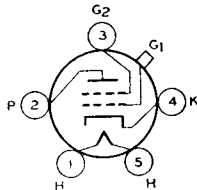

**24-A**

conductance, 1050  $\mu$ mhos; plate ma., 4; grid-No.2 ma., 1.7 *max*. This type is used principally for renewal purposes.

**POWER PENTODE**

Metal type 25A6 and glass-octal type 25A6-GT are used in output stage of ac/dc receivers. Outlines 6 and 22, respectively, OUTLINES SECTION. Tubes require octal socket and may be mounted in any position. Heater volts (ac/dc), 25; amperes, 0.3. Maximum ratings as class A<sub>1</sub> amplifier: plate volts, 160; grid-No.2 volts, 135; plate dissipation, 5.3

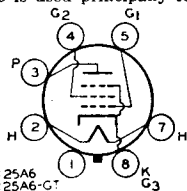

**25A6  
25A6-GT**

watts; grid-No.2 input, 1.9 watts. Type 25A6 is used principally for renewal purposes. Type 25A6-GT is a DISCONTINUED type listed for reference only.

**Typical Operation:**

**CLASS A<sub>1</sub> AMPLIFIER**

Plate Voltage	95	135	160	volts
Grid-No.2 (Screen) Voltage	95	135	120	volts
Grid-No.1 (Control-Grid) Voltage	-15	-20	-18	volts
Zero-Signal Plate Current	20	37	33	ma
Zero-Signal Grid-No.2 Current	4	8	6.5	ma
Plate Resistance	45000	35000	42000	ohms
Transconductance	2000	2450	2375	$\mu$ mhos
Load Resistance	4500	4000	5000	ohms
Maximum-Signal Power Output	0.9	2	2.2	watts

**RECTIFIER—POWER PENTODE**

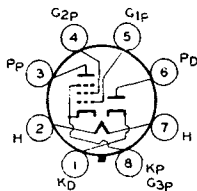

$\mu$ hos; load resistance, 4500 ohms; output watts, 0.77. Maximum ratings of rectifier unit: peak inverse plate volts, 350; peak plate ma., 450; dc output ma., 75; peak heater-cathode volts, 175. This is a **DISCONTINUED** type listed for reference only.

**25A7-GT**

**HIGH-MU POWER TRIODE**

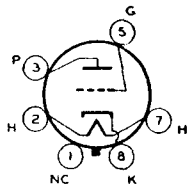

Glass octal type used in output stage of ac/dc receivers. Outline 22, **OUTLINES SECTION**. Heater volts (ac/dc), 25; amperes, 0.3. Maximum ratings: plate volts, 180 *max*; plate dissipation, 10 *max* watts. Type 25AC5-GT is used principally for renewal purposes.

**25AC5-GT**

**DIRECT-COUPLED POWER AMPLIFIER**

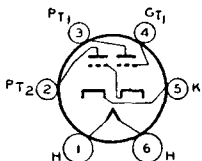

Glass type used as class A<sub>1</sub> power amplifier. One triode, the driver, is directly connected within the tube to the second, or output, triode. Heater volts (ac/dc), 25; amperes, 0.3. Maximum ratings and characteristics are the same as for type 25N6-G. This is a **DISCONTINUED** type listed for reference only.

**25B5**

**POWER PENTODE**

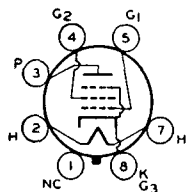

Glass octal type used in output stage of ac/dc receivers. Outline 35, **OUTLINES SECTION**. Heater volts (ac/dc), 25; amperes, 0.3. Typical operation as class A<sub>1</sub> amplifier: plate volts, 200 *max*; grid-No.2 volts, 135 *max*; grid-No.1 volts, -23; plate ma., 62; grid-No.2 ma., 1.8; plate resistance, 18000 ohms; transconductance, 5000  $\mu$ hos; load resistance, 2500 ohms; output watts, 7.1. This is a **DISCONTINUED** type listed for reference only.

**25B6-G**

**TRIODE—PENTODE**

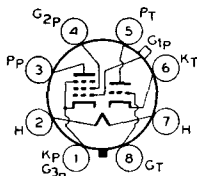

ductance, 2000  $\mu$ hos, grid-No.1 volts for transconductance of 2  $\mu$ hos, -41. Triode unit: plate volts, 100; grid volts, -1; plate ma., 0.6; amplification factor, 112; plate resistance, 75000; transconductance, 1500  $\mu$ hos. This is a **DISCONTINUED** type listed for reference only.

**25B8-GT**

**BEAM POWER AMPLIFIER**

For technical data, see page 313.

**25BQ6-GT**

**BEAM POWER AMPLIFIER**

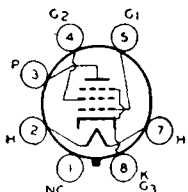

Glass octal type used as output amplifier. Outline 35, **OUTLINES SECTION**. Heater volts (ac/dc), 25; amperes, 0.3. Refer to type 6Y6-G for typical operation as a class A<sub>1</sub> amplifier. This is a **DISCONTINUED** type listed for reference only.

**25C6-G**

**25L6**  
**25L6-GT**

**BEAM POWER AMPLIFIER**

Metal type 25L6 and glass-octal type 25L6-GT are used in output stage of ac/dc receivers. Outlines 6 and 22, respectively, **OUTLINES SECTION**. These tubes require octal sockets and

may be mounted in any position. Heater volts (ac/dc), 25; amperes, 0.3. For maximum ratings and typical operation, refer to type 50L6-GT. Refer to miniature type 50C5 for curves, installation, and application information, but take into consideration the differences in heater ratings.

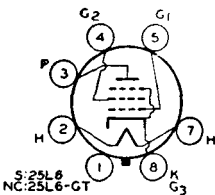

**DIRECT-COUPLED TWIN  
POWER AMPLIFIER**

Glass octal type used as class A<sub>1</sub> power amplifier. One triode, the driver, is directly connected within the tube to the second, or output, triode. Heater volts (ac/dc), 25; amperes, 0.3. Characteristics as class A<sub>1</sub> amplifier—input triode: plate volts, 100 (180 max); grid volts, 0; peak at grid volts, 29.7; plate ma., 5.8. Output triode: plate volts, 180 max; plate ma., 46; load resistance, 4000 ohms; output watts, 3.8. This is a **DISCONTINUED** type listed for reference only.

**25N6-G**

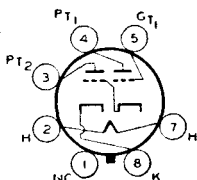

**HALF-WAVE VACUUM RECTIFIER**

Glass octal type used as damper diode in magnetic deflection circuit of television receivers and as a rectifier in conventional power-supply applications. Outline 21, **OUTLINES SECTION**. Heater volts (ac/dc), 25; amperes, 0.3. Except for heater rating and, in damper service, a peak inverse plate voltage rating of 2000 max volts and a peak heater-cathode voltage rating of 450 max volts with heater negative with respect to cathode, this type is identical with glass octal type 6W4-GT.

**25W4-GT**

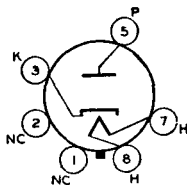

**VACUUM RECTIFIER-DOUBLER**

Glass type used as half-wave rectifier or voltage doubler in ac/dc receivers. Outline 32, **OUTLINES SECTION**. Heater volts (ac/dc), 25; amperes, 0.3. Maximum ratings: peak inverse plate volts, 700; peak plate ma. per plate, 450; peak heater-cathode volts, 350; dc output ma. per plate, 75. This is a **DISCONTINUED** type listed for reference only.

**25Y5**

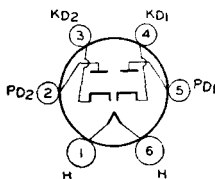

**VACUUM RECTIFIER-DOUBLER**

Glass type used as half-wave rectifier or voltage doubler in ac/dc receivers. For voltage-doubler considerations, refer to **ELECTRON TUBE APPLICATIONS SECTION**. Outline

**25Z5**

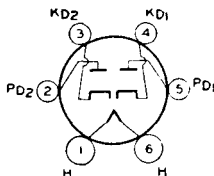

32, **OUTLINES SECTION**. Tube requires six-contact socket and may be mounted in any position. Heater volts (ac/dc), 25; amperes, 0.3. This type is electrically identical with metal type 25Z6.



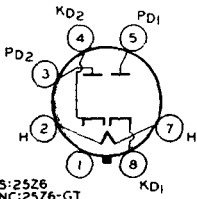

VACUUM RECTIFIER-DOUBLER

25Z6  
25Z6-GT

Metal type 25Z6 and glass-octal type 25Z6-GT used as half-wave rectifiers or voltage-doublers in ac/dc receivers. These types are used particularly in "transformerless" receivers of either the ac/dc type or the voltage-

doubler type. Outlines 6 and 22, respectively, OUTLINES SECTION. Tubes require octal socket and may be mounted in any position. Type 25Z6 is used principally for renewal purposes.

HEATER VOLTAGE (AC/DC) .....	25	volts
HEATER CURRENT .....	0.3	ampere

Maximum Ratings: HALF-WAVE RECTIFIER

PEAK INVERSE PLATE VOLTAGE .....	700 <i>max</i>	volts
PEAK PLATE CURRENT PER PLATE .....	450 <i>max</i>	ma
DC OUTPUT CURRENT PER PLATE .....	75 <i>max</i>	ma
PEAK HEATER-CATHODE VOLTAGE .....	350 <i>max</i>	volts

Typical Operation (Capacitor-Input Filter):<sup>o</sup>

(Unless otherwise indicated, values are for both plates in parallel.)

AC Plate-Supply Voltage per Plate (rms) .....	117	150	235	volts
Filter-Input Capacitor .....	16	16	16	$\mu$ f
Min. Total Effective Plate-Supply Impedance per Plate† .....	15	40	100	ohms
DC Output Current per Plate .....	75	75	75	ma
DC Output Voltage At Input to Filter (Approx.):				
At half-load current (75 ma.) .....	115	-	255	volts
At full-load current (150 ma.) .....	80	-	200	volts
Voltage Regulation (Approx.):				
Half-load to full-load current .....	35	-	55	volts

Maximum Ratings: VOLTAGE DOUBLER

(Same as for Half-Wave Rectifier.)

Typical Operation:

	Half-Wave	Full-Wave	
AC Plate-Supply Voltage per Plate (rms) .....	117	117	volts
Filter-Input Capacitor (Each) .....	16	16	$\mu$ f
Min. Total Effective Plate-Supply Impedance per Plate† .....	30	15	ohms
DC Output Current .....	75	75	ma

<sup>o</sup> In half-wave rectifier service, the two units may be used separately or in parallel.

† When a filter-input capacitor larger than 40  $\mu$ f is used, it may be necessary to use more plate-supply impedance than the minimum value shown to limit the peak plate current to the rated value.

OPERATION CHARACTERISTICS HALF-WAVE RECTIFIER

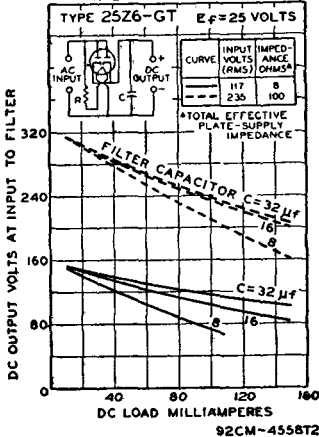

OPERATION CHARACTERISTICS FULL-WAVE VOLTAGE DOUBLER

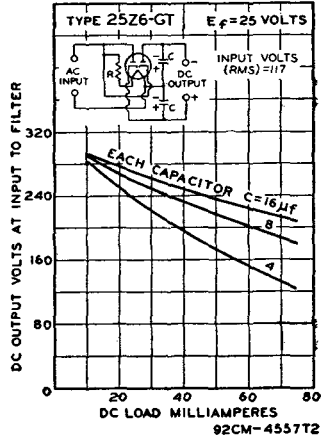

26

MEDIUM-MU TRIODE

Glass type used as *rf* voltage amplifier in ac-operated receivers. Outline 36, OUTLINES SECTION. Tube requires four-contact socket. Filament volts (ac/dc), 1.5; amperes, 1.05. This type is used principally for renewal purposes.

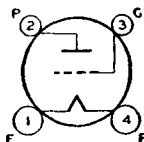

Characteristics:

	CLASS A <sub>1</sub> AMPLIFIER			
Plate Voltage (180 volts <i>max</i> )	90	135	180	volts
Grid Voltage	-7	-10	-14.5	volts
Amplification Factor	8.3	8.3	8.3	
Plate Resistance	8900	7600	7300	ohms
Transconductance	935	1100	1150	μmhos
Plate Current	2.9	5.5	6.2	ma

MEDIUM-MU TRIODE

Glass type used as voltage amplifier or detector in ac-operated receivers. Outline 32, OUTLINES SECTION. Tube requires five-contact socket. Heater volts (ac/dc), 2.5; amperes, 1.75. This type is used principally for renewal purposes.

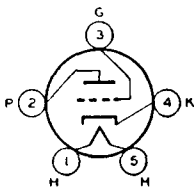

27

CLASS A<sub>1</sub> AMPLIFIER

Characteristics:

	CLASS A <sub>1</sub> AMPLIFIER				
Plate Voltage (275 volts <i>max</i> )	90	135	180	250	volts
Grid Voltage	-6	-9	-13.5	-21	volts
Amplification Factor	9	9	9	9	
Plate Resistance	11000	9000	9000	9250	ohms
Transconductance	820	1000	1000	975	μmhos
Plate Current	2.7	4.5	5.0	5.2	ma

MEDIUM-MU TRIODE

Glass type used as voltage amplifier or detector in battery-operated receivers. Outline 32, OUTLINES SECTION. Tube requires four-contact socket. Filament volts (dc), 2.0; amperes, 0.06. Except for interelectrode capacitances, this type is electrically identical with glass-octal type 1H4-G. Type 30 is used principally for renewal purposes.

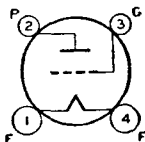

30

POWER TRIODE

Glass type used in output stage of battery-operated receivers. Outline 32, OUTLINES SECTION. Tube requires four-contact socket. Filament volts (dc), 2.0; amperes, 0.13. Typical operation as class A<sub>1</sub> amplifier: plate volts, 180 *max*; grid volts, -30; plate ma., 12.3; plate resistance, 3600 ohms; amplification factor, 3.8; transconductance, 1050 μmhos; load resistance, 5700 ohms; output watts, 0.375. This type is used principally for renewal purposes.

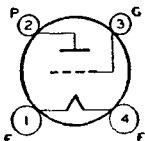

31

SHARP-CUTOFF TETRODE

Glass type used as *rf* amplifier or biased detector in battery-operated receivers. Outline 39, OUTLINES SECTION. Tube requires four-contact socket. Filament volts (dc), 2.0; amperes, 0.06. Typical operation as class A<sub>1</sub> amplifier: plate volts, 180 *max*; grid-No.2 ma., 0.4 *max*; plate resistance, greater than 1 megohm; plate ma., 1.7; transconductance, 650 μmhos. This type is used principally for renewal purposes.

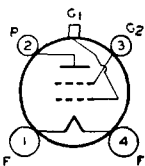

32

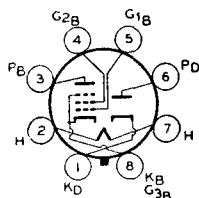

**RECTIFIER—BEAM POWER AMPLIFIER**

**32L7-GT**

Glass octal type used as combined half-wave rectifier and output amplifier in ac/dc receivers. Outline 22, OUTLINES SECTION. Tube requires octal socket. Heater volts (ac/dc), 32.5; amperes, 0.3. Maximum ratings for rectifier unit: ac plate volts (rms), 125; dc output ma., 60. Typical operation of beam power unit as class A<sub>1</sub> amplifier: plate and grid-No.2 volts, 90; grid-No.1 volts, -7; plate ma., 27; grid-No.2 ma., 2; plate resistance, 17000 ohms; transconductance, 4800 μmhos; load resistance, 2600 ohms; maximum-signal output watts, 1.0. This type is used principally for renewal purposes.

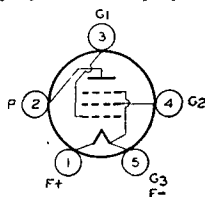

**POWER PENTODE**

**33**

Glass type used in output stage of battery-operated receivers. Outline 36, OUTLINES SECTION. Tube requires five-contact socket. Filament volts (dc), 2.0; amperes, 0.26. Typical operation as class A<sub>1</sub> amplifier: plate and grid-No.2 volts, 180 max; grid-No.1 volts, -18; plate ma., 22; grid-No.2 ma., 5; plate resistance, 55000 ohms; transconductance, 1750 μmhos; load resistance, 6000 ohms; output watts, 1.4. This type is used principally for renewal purposes.

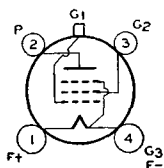

**REMOTE-CUTOFF PENTODE**

**34**

Glass type used as rf or if amplifier in battery-operated radio receivers, particularly those employing avc. Outline 39, OUTLINES SECTION. Tube requires four-contact socket. Filament volts (dc), 2.0; amperes, 0.06. Characteristics as class A<sub>1</sub> amplifier: plate volts, 180 max; grid-No.2 volts, 67.5 max; grid-No.1 volts, -3 min; plate ma., 2.8; grid-No.2 ma., 1.0; plate resistance, 1.0 megohm; transconductance, 620 μmhos; transconductance at grid-No.1 bias of -22.5 volts, 15 μmhos. This type is used principally for renewal purposes.

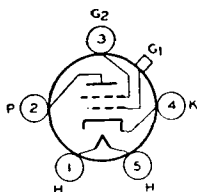

**REMOTE-CUTOFF TETRODE**

**35**

Glass type used as rf or if amplifier in ac receivers. Outline 39, OUTLINES SECTION. Tube requires five-contact socket. Heater volts (ac/dc), 2.5; amperes, 1.75. Characteristics as class A<sub>1</sub> amplifier: plate volts, 250 (275 max); grid-No.2 volts, 90 max; grid-No.1 volts, -3 min; plate ma., 6.5; grid-No.2 ma., 2.5; transconductance, 1050 μmhos; transconductance at grid-No.1 bias of -40 volts, 15 μmhos. This type is used principally for renewal purposes.

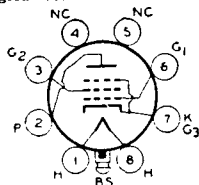

**BEAM POWER AMPLIFIER**

**35A5**

Glass lock-in type used in output stage of ac/dc receivers. Outline 19, OUTLINES SECTION. Tube requires lock-in socket. Heater volts (ac/dc), 35; amperes, 0.15. For ratings, and curves, refer to glass-octal type 35L6-GT.

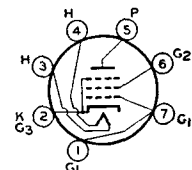

**BEAM POWER AMPLIFIER**

**35B5**

Miniature type used in output stage of compact, ac/dc radio receivers. Because of its high power sensitivity at plate and screen voltages available in ac/dc receivers, it is capable of providing a relatively high power output. Outline 15, OUTLINES SECTION. Tube requires miniature seven-contact socket and may be mounted in any position.

Within its maximum ratings, type 35B5 is equivalent in performance to glass-octal type 35L6-GT, and miniature type 35C5. Refer to type 35C5 for typical operation, maximum circuit values, installation, application information, and curves.

HEATER VOLTS (AC/DC) .....	35	volts
HEATER CURRENT .....	0.15	ampere
DIRECT INTERELECTRODE CAPACITANCES (Approx.):*		
Grid No.1 to Plate .....	0.4	$\mu\text{f}$
Input .....	11	$\mu\text{f}$
Output .....	6.5	$\mu\text{f}$

\* With no external shield.

### CLASS A<sub>1</sub> AMPLIFIER

**Maximum Ratings:**

PLATE VOLTAGE .....	117 <i>max</i>	volts
GRID-NO.2 (SCREEN) VOLTAGE .....	117 <i>max</i>	volts
PLATE DISSIPATION .....	4.5 <i>max</i>	watts
GRID-NO.2 INPUT .....	1.0 <i>max</i>	watt
PEAK HEATER-CATHODE VOLTAGE:		
Heater negative with respect to cathode .....	150 <i>max</i>	volts
Heater positive with respect to cathode .....	150 <i>max</i>	volts

### BEAM POWER AMPLIFIER

Miniature type used in output stage of compact, ac/dc radio receivers. Because of its high power sensitivity and high efficiency at plate and screen voltages available in ac/dc receivers, the 35C5 is capable of providing a relatively high power output. Except

## 35C5

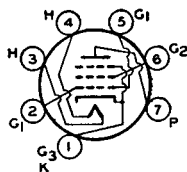

for terminal connections and slightly higher ratings, type 35C5 is equivalent in performance to miniature type 35B5 and, within its maximum ratings, to glass-octal type 35L6-GT. The basing arrangement of the 35C5 simplifies the problem of meeting Underwriters' Laboratories requirements in the design of ac/dc receivers.

HEATER VOLTAGE (AC/DC) .....	35	volts
HEATER CURRENT .....	0.15	ampere
DIRECT INTERELECTRODE CAPACITANCES (Approx.):°		
Grid No.1 to Plate .....	0.57	$\mu\text{f}$
Input .....	12	$\mu\text{f}$
Output .....	6.2	$\mu\text{f}$

° With no external shield.

### CLASS A<sub>1</sub> AMPLIFIER

**Maximum Ratings:**

PLATE VOLTAGE .....	135 <i>max</i>	volts
GRID-NO.2 (SCREEN) VOLTAGE .....	117 <i>max</i>	volts
PLATE DISSIPATION .....	4.5 <i>max</i>	watts
GRID-NO.2 INPUT .....	1.0 <i>max</i>	watt
PEAK HEATER-CATHODE VOLTAGE:		
Heater negative with respect to cathode .....	180 <i>max</i>	volts
Heater positive with respect to cathode .....	180 <i>max</i>	volts
BULB TEMPERATURE (At hottest point on bulb surface) .....	250 <i>max</i>	°C

#### Typical Operation:

Plate Voltage .....	110	volts
Grid-No.2 Voltage .....	110	volts
Peak AF Grid-No.1 Voltage .....	7.5	volts
Zero-Signal Plate Current .....	40	ma
Maximum-Signal Plate Current .....	41	ma
Zero-Signal Grid-No.2 Current (Approx.) .....	3	ma
Maximum-Signal Grid-No.2 Current (Approx.) .....	7	ma
Plate Resistance (Approx.) .....	13000	ohms
Transconductance .....	5800	$\mu\text{mhos}$

Load Resistance .....	2500	ohms
Total Harmonic Distortion .....	10	per cent
Maximum-Signal Power Output .....	1.5	watts

**Maximum Circuit Values (For maximum rated conditions):**

Grid-No.1-Circuit Resistance	{ Cathode Bias .....	0.5 max	megohm
	{ Fixed Bias .....	0.1 max	megohm

## INSTALLATION AND APPLICATION

Type 35C5 requires miniature seven-contact socket and may be mounted in any position. Outline 15, OUTLINES SECTION. It is especially important that this tube, like other power-handling tubes, should be adequately ventilated.

The 35-volt heater is designed to operate under the normal conditions of line-voltage variation without materially affecting the performance or serviceability of the 35C5. For operation of the 35C5 in series with other types having 0.15-ampere rating, the current in the heater circuit should be adjusted to 0.15 ampere for the normal supply voltage.

In a series-heater circuit of the "dc power line" type employing several 0.15-ampere types and one or two 35C5's, the heater(s) of the 35C5('s) should be placed on the positive side of the line. Under these conditions, heater-cathode voltage of the 35C5 must not exceed the value given under maximum ratings. In a series-heater circuit of the "universal" type employing rectifier tube 35W4, one or two 35C5's and several 0.15-ampere types, it is recommended that the heater(s) of the 35C5('s), be placed in the circuit so that the higher values of heater-cathode bias will be impressed on the 35C5('s) rather than on the other 0.15-ampere types. This is accomplished by arranging the 35C5('s) on the side of the supply line which is connected to the cathode of the rectifier, i.e., the positive terminal of the rectified voltage supply. Between this side of the line and the 35C5('s), any necessary auxiliary resistance and the heater of the 35W4 are connected in series.

As a power amplifier (class A<sub>1</sub>), the 35C5 is recommended for use either singly or in push-pull combination in the power-output stage of "ac/dc" receivers. The operating values shown under typical operation have been determined on the basis that grid-No.1 current does not flow during any part of the input cycle. The type of input coupling used should not introduce too much resistance in the grid-No.1 circuit. Transformer- or impedance-coupling devices are recommended.

AVERAGE PLATE CHARACTERISTICS  
PENTODE CONNECTION

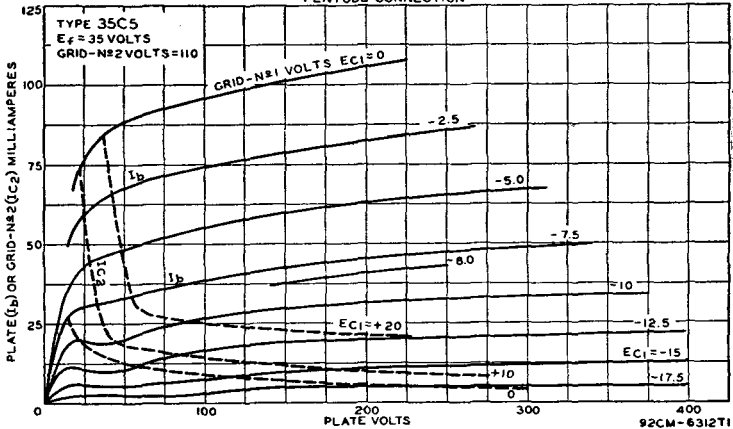

**BEAM POWER AMPLIFIER**

**35L6-GT**

Glass octal type used in output stage of ac/dc radio receivers. Outline 22, OUTLINES SECTION. Tube requires octal socket and may be mounted in any position. Refer to

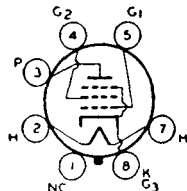

miniature type 35C5 for installation, application information, and curves.

HEATER VOLTAGE (AC/DC).....	35	volts
HEATER CURRENT.....	0.15	ampere
DIRECT INTERELECTRODE CAPACITANCES (Approx.):°		
Grid No.1 to Plate.....	0.8	μμf
Input.....	13	μμf
Output.....	9.5	μμf

° With no external shield.

**CLASS A<sub>1</sub> AMPLIFIER**

**Maximum Ratings:**

PLATE VOLTAGE.....	200 max	volts
GRID-NO.2 (SCREEN) VOLTAGE.....	125 max	volts
PLATE DISSIPATION.....	8.5 max	watts
GRID-NO.2 INPUT.....	1.0 max	watt

**PEAK HEATER-CATHODE VOLTAGE:**

Heater negative with respect to cathode.....	90 max	volts
Heater positive with respect to cathode.....	90 max	volts

**Typical Operation:**

	<i>Fixed Bias</i>	<i>Cathode Bias</i>	
Plate Voltage.....	110	200	volts
Grid-No.2 Voltage.....	110	110	volts
Grid-No.1 (Control-Grid) Voltage.....	-7.5	-	volts
Cathode Resistor.....	-	180	ohms
Peak AF Grid-No.1 Voltage.....	7.5	8	volts
Zero-Signal Plate Current.....	40	43	ma
Maximum-Signal Plate Current.....	41	43	ma
Zero-Signal Grid-No.2 Current (Approx.).....	3	2	ma
Maximum-Signal Grid-No.2 Current (Approx.).....	7	5.5	ma
Plate Resistance (Approx.).....	14000	34000	ohms
Transconductance.....	5800	6100	μmhos
Load Resistance.....	2500	5000	ohms
Total Harmonic Distortion.....	10	10	per cent
Maximum-Signal Power Output.....	1.5	3.0	watts

**HALF-WAVE VACUUM RECTIFIER**

**35W4**

Miniature type used in power supply of ac/dc receivers. Equivalent in performance to glass-octal type 35Z5-GT. The heater is provided with a tap for operation of a panel lamp.

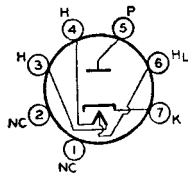

HEATER VOLTAGE (AC/DC):	*	**	
ENTIRE HEATER (PINS 3 AND 4).....	35	32	volts
PANEL LAMP SECTION (PINS 4 AND 6).....	7.5	5.5	volts
HEATER CURRENT:			
BETWEEN PINS 3 AND 4.....	0.15	-	ampere
BETWEEN PINS 3 AND 6.....	-	0.15	ampere

\* Without panel lamp.

\*\* With No.40 or No.47 panel lamp.

**Maximum Ratings:**

**HALF-WAVE RECTIFIER**

PEAK INVERSE PLATE VOLTAGE.....	330 max	volts
PEAK PLATE CURRENT.....	600 max	ma
DC OUTPUT CURRENT:		
With Panel Lamp and { No Shunting Resistor.....	60 max	ma
{ Shunting Resistor.....	90 max	ma
Without Panel Lamp.....	100 max	ma

# RCA RECEIVING TUBE MANUAL

## PANEL-LAMP-SECTION VOLTAGE (rms):

When Panel Lamp Fails.....	15 max	volts
<b>PEAK HEATER-CATHODE VOLTAGE:</b>		
Heater negative with respect to cathode.....	330 max	volts
Heater positive with respect to cathode.....	330 max	volts

## Typical Operation with Panel Lamp:†

AC Plate-Supply Voltage (rms).....	117	117	117	117	volts
Filter-Input Capacitor.....	40	40	40	40	μf
Minimum Total Effective Plate-Supply Impedance.....	15	15	15	15	ohms
Panel-Lamp Shunting Resistor.....	-	300	150	100	ohms
DC Output Current.....	60	70	80	90	ma

† No.40 or No.47 panel lamp used in circuit given below with capacitor-input filter.

## Typical Operation without Panel Lamp:

AC Plate-Supply Voltage (rms).....	117	volts
Filter-Input Capacitor.....	40	μf
Minimum Total Effective Plate-Supply Impedance.....	15	ohms
DC Output Current.....	100	ma
<b>DC Output Voltage at Input to Filter (Approx.):</b>		
At half-load current (50 ma.).....	135	volts
At full-load current (100 ma.).....	120	volts
<b>Voltage Regulation (Approx.):</b>		
Half-load to full-load current.....	15	volts

## Maximum Circuit Values:

<b>Panel-Lamp Shunting Resistor*:</b>		
For dc output current of		
70 ma.....	800 max	ohms
80 ma.....	400 max	ohms
90 ma.....	250 max	ohms

\* Required when dc output current is greater than 60 milliamperes.

## INSTALLATION AND APPLICATION

Tube requires miniature seven-contact socket and may be mounted in any position. Outline 15, OUTLINES SECTION. For heater considerations, refer to miniature type 35C5.

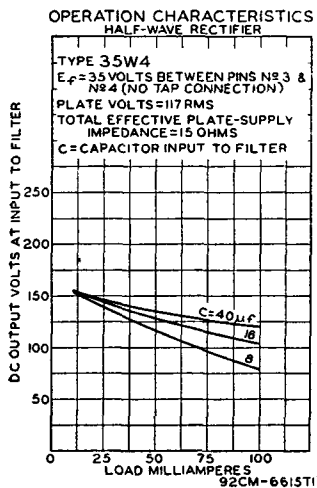

With the panel lamp connected as shown in the diagram, the drop across R and all heaters (with panel lamp) should equal 117 volts at 0.15 ampere. The shunting resistor  $R_s$  is required when dc output current exceeds 60 milliamperes. Values of  $R_s$  for dc output currents greater than 60 milliamperes are given in tabulated data.

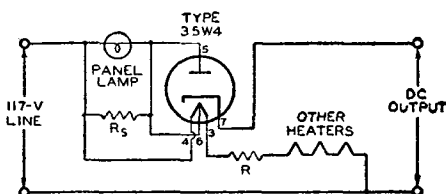

# 35Y4

## HALF-WAVE VACUUM RECTIFIER

Glass lock-in type used in power supply of ac/dc receivers. The heater is provided with tap for the operation of a panel lamp. Outline 19, OUTLINES SECTION. Tube requires lock-in socket. Heater volts (ac/dc), 35; amperes, 0.15. For maximum ratings, refer to glass-octal type 35Z5-GT. For typical operation and curves, refer to miniature type 35W4.

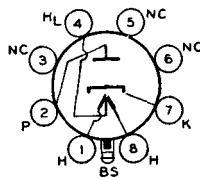

# 35Z3

## HALF-WAVE VACUUM RECTIFIER

Glass lock-in type used in power supply of ac/dc receivers. Outline 19, OUTLINES SECTION. Tube requires lock-in socket. Heater volts (ac/dc), 35; amperes, 0.15. For maximum ratings and typical operation, refer to glass-octal type 35Z5-GT without panel lamp.

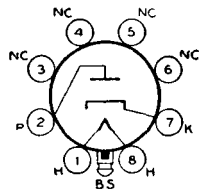

# 35Z4-GT

## HALF-WAVE VACUUM RECTIFIER

Glass octal type used in power supply of ac/dc receivers. Outline 22, OUTLINES SECTION. Tube requires octal socket. Heater volts (ac/dc), 35; amperes, 0.15. For maximum ratings and typical operation, refer to glass-octal type 35Z5-GT without panel lamp. This type is used principally for renewal purposes.

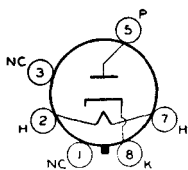

# 35Z5-GT

## HALF-WAVE VACUUM RECTIFIER

Glass octal type used in power supply of ac/dc receivers. The heater is provided with a tap for operation of a panel lamp. Outline 22, OUTLINES SECTION. Tube requires octal socket and may be mounted in any position. For installation and application considerations, refer to miniature type 35W4.

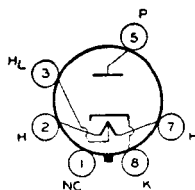

octal socket and may be mounted in any position. For installation and application considerations, refer to miniature type 35W4.

HEATER VOLTAGE (AC/DC):	*	**	
ENTIRE HEATER (PINS 2 AND 7) . . . . .	35	32	volts
PANEL LAMP SECTION (PINS 2 AND 3) . . . . .	7.5	5.5	volts
HEATER CURRENT:			
BETWEEN PINS 2 AND 7 . . . . .	0.15	-	ampere
BETWEEN PINS 3 AND 7 . . . . .	-	0.15	ampere

\* Without panel lamp.      \*\* With No.40 or No. 47 panel lamp.

<b>HALF-WAVE RECTIFIER</b>		
PEAK INVERSE PLATE VOLTAGE . . . . .		700 maz volts
PEAK PLATE CURRENT . . . . .		600 maz ma
DC OUTPUT CURRENT:		
With Panel Lamp and { No Shunting Resistor . . . . .		60 maz ma
{ Shunting Resistor . . . . .		90 maz ma
Without Panel Lamp . . . . .		100 maz ma
PANEL-LAMP-SECTION VOLTAGE (rms):		
When Panel Lamp Fails . . . . .		15 maz volts
PEAK HEATER-CATHODE VOLTAGE:		
Heater negative with respect to cathode . . . . .		350 maz volts
Heater positive with respect to cathode . . . . .		350 maz volts

<b>Typical Operation with Panel Lamp:†</b>						
AC Plate-Supply Voltage (rms) . . . . .	117	117	117	117	235	volts
Filter-Input Capacitor . . . . .	40	40	40	40	40	µf
Minimum Total Effective Plate-Supply Impedance . . . . .	15	15	15	15	100	ohms
Panel-Lamp Shunting Resistor . . . . .	-	300	150	100	-	ohms
DC Output Current . . . . .	60	70	80	90	60	ma

† No.40 or No.47 panel lamp used in circuit with capacitor-input filter given under type 35W4.



### Typical Operation without Panel Lamp:

AC Plate-Supply Voltage (rms) .....	117	235	volts
Filter-Input Capacitor .....	40	40	$\mu$ f
Minimum Total Effective Plate-Supply Impedance .....	15	100	ohms
DC Output Current .....	100	100	ma
DC Output Voltage at Input to Filter (Approx.):			
At half-load current (50 ma.) .....	140	280	volts
At full-load current (100 ma.) .....	120	235	volts
Voltage Regulation (Approx.):			
Half-load to full-load current .....	20	45	volts

### Maximum Circuit Values:

#### Panel-Lamp Shunting Resistor\*:

For dc output current of	70 ma .....	800 <i>max</i>	ohms
	80 ma .....	400 <i>max</i>	ohms
	90 ma .....	250 <i>max</i>	ohms

\* Required when dc output current is greater than 60 milliamperes.

## SHARP-CUTOFF TETRODE

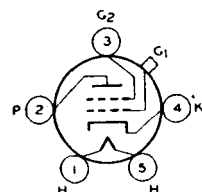

Glass type used as rf or if amplifier or as biased or grid-resistor detector in radio receivers. Outline 34, OUTLINES SECTION. Tube requires five-contact socket. Heater volts (ac/dc), 6.3; amperes, 0.3. Characteristics as class A<sub>1</sub> amplifier: plate volts, 250 *max*; grid-No.2 volts, 90 *max*; grid-No.1 volts, -3; plate ma., 3.2; grid-No.2 ma., 1.7 *max*; plate resistance, 0.55 megohm; transconductance, 1080  $\mu$ mhos. This type is used principally for renewal purposes.

# 36

## MEDIUM-MU TRIODE

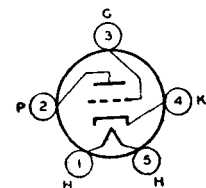

Glass type used as voltage amplifier or detector in radio receivers. Outline 32, OUTLINES SECTION. Tube requires five-contact socket. Heater volts (ac/dc), 6.3; amperes, 0.3. Characteristics as class A<sub>1</sub> amplifier: plate volts, 250 *max*; grid volts, -18; plate ma., 7.5; plate resistance, 8400 ohms; amplification factor, 9.2; transconductance, 1100  $\mu$ mhos. This type is used principally for renewal purposes.

# 37

## POWER PENTODE

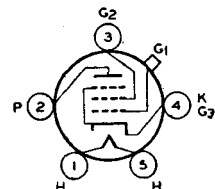

Glass type used in output stage of radio receivers. Outline 34, OUTLINES SECTION. Tube requires five-contact socket. Heater volts (ac/dc), 6.3; amperes, 0.3. Characteristics as class A<sub>1</sub> amplifier: plate and grid-No.2 volts, 250 *max*; grid-No.1 volts, -25; plate ma., 22; grid-No.2 ma., 3.8; plate resistance, 0.1 megohm; transconductance, 1200  $\mu$ mhos; load resistance, 10000 ohms; output watts, 2.5. This type is used principally for renewal purposes.

# 38

## REMOTE-CUTOFF PENTODE

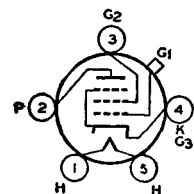

Glass type used as rf or if amplifier in radio receivers, particularly those employing avc. Outline 34, OUTLINES SECTION. Tube requires five-contact socket. Heater volts (ac/dc), 6.3; amperes, 0.3. Characteristics as class A<sub>1</sub> amplifier: plate volts, 250 *max*; grid-No.2 volts, 90 *max*; grid-No.1 volts, -3 *min*; plate ma., 5.8; grid-No.2 ma., 1.4; plate resistance, 1.0 megohm; transconductance, 1050  $\mu$ mhos; transconductance at grid-No.1 bias of -42.5 volts, 2  $\mu$ mhos. This type is used principally for renewal purposes.

# 39/44

ohm; transconductance, 1050  $\mu$ mhos; transconductance at grid-No.1 bias of -42.5 volts, 2  $\mu$ mhos. This type is used principally for renewal purposes.

## MEDIUM-MU TRIODE

**40**

Glass type used as resistance-coupled or impedance-coupled amplifier in battery-operated receivers. Outline 36, OUTLINES SECTION. Filament volts (dc), 5; amperes, 0.25. Characteristics as class A<sub>1</sub> amplifier: plate-supply volts, 180; load resistance, 250000 ohms; grid volts, -3; plate ma., 0.2; plate resistance, 150000 ohms; amplification factor, 30; transconductance, 200  $\mu$ mhos. This is a DISCONTINUED type listed for reference only.

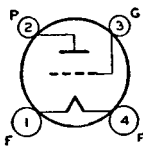

## POWER PENTODE

**41**

Glass type used in output stage of radio receivers. Outline 32, OUTLINES SECTION. Tube requires six-contact socket. Heater volts (ac/dc), 6.3; amperes, 0.4. This type is electrically identical with type 6K6-GT. Type 41 is used principally for renewal purposes.

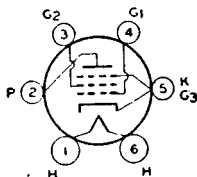

## POWER PENTODE

**42**

Glass type used in audio output stage of ac receivers. Outline 36, OUTLINES SECTION. Tube requires six-contact socket. Heater volts (ac/dc), 6.3; amperes, 0.7. This type is electrically identical with type 6F6. Type 42 is used principally for renewal purposes.

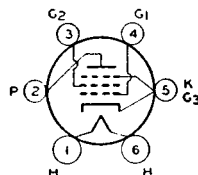

## POWER PENTODE

**43**

Glass type used in audio output stage of ac/dc receivers. Outline 36, OUTLINES SECTION. Tube requires six-contact socket. Heater volts (ac/dc), 25; amperes, 0.3. This type is electrically identical with type 25A6. Type 43 is used principally for renewal purposes.

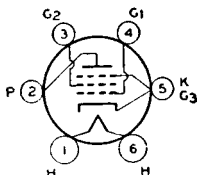

## POWER TRIODE

**45**

Glass type used in output stage of radio receivers. Outline 36, OUTLINES SECTION. Tube requires four-contact socket and should preferably be mounted in vertical position. Horizontal operation is permissible if pins 1 and 4 are in vertical plane. This type is used principally for renewal purposes.

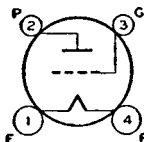

FILAMENT VOLTAGE (AC/DC) .....	2.5	volts
FILAMENT CURRENT .....	1.5	amperes

### CLASS A<sub>1</sub> AMPLIFIER

Typical Operation:				
Plate Voltage (275 volts max) .....	180	250	275	volts
Grid Voltage* .....	-31.5	-50	-56	volts
Cathode-Bias Resistor .....	1020	1470	1550	ohms
Plate Current .....	31	34	36	ma
Plate Resistance .....	1650	1610	1700	ohms
Amplification Factor .....	3.5	3.5	3.5	
Transconductance .....	2125	2175	2050	$\mu$ mhos
Load Resistance .....	2700	3900	4600	ohms
Undistorted Power Output .....	0.825	1.6	2.0	watts

\* Grid volts measured from mid-point of ac-operated filament. Cathode bias is advisable in all cases; required if grid-coupling resistor (max value of 1.0 megohm) is used.

## PUSH-PULL CLASS AB<sub>2</sub> AMPLIFIER

Typical Operation (Values are for two tubes):

	Fixed Bias	Cathode Bias	
Plate Voltage (275 volts max).....	275	275	volts
Grid Voltage.....	-68	-	volts
Cathode-Bias Resistor.....	-	775	ohms
Average Driving Power (Grid-to-grid).....	656	460	mw
Zero-Signal Plate Current.....	28	36	ma
Maximum-Signal Plate Current.....	138	90	ma
Effective Load Resistance (Plate-to-plate).....	3200	5060	ohms
Total Harmonic Distortion.....	5	5	per cent
Maximum-Signal Power Output.....	18	12	watts

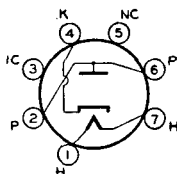

### HALF-WAVE VACUUM RECTIFIER

Miniature type used in power supply of small, portable, ac/dc/battery receivers where small size and low heat dissipation are important. Outline 12, OUTLINES SECTION. Tube requires miniature seven-contact socket and may be mounted in any position. This type is used principally for renewal purposes.

## 45Z3

HEATER VOLTAGE (AC/DC).....	45		volts
HEATER CURRENT.....	0.075		ampere

### HALF-WAVE RECTIFIER

Maximum Ratings:

PEAK INVERSE PLATE VOLTAGE.....	350 max		volts
PEAK PLATE CURRENT.....	390 max		ma
DC OUTPUT CURRENT.....	65 max		ma
PEAK HEATER-CATHODE VOLTAGE:			
Heater negative with respect to cathode.....	175 max		volts
Heater positive with respect to cathode.....	175 max		volts

Typical Operation (With Capacitor-Input Filter):

AC Plate Voltage (rms).....	117		volts
Filter-Input Capacitor.....	16		$\mu$ f
Minimum Total Effective Plate-Supply Impedance.....	15		ohms
DC Output Current.....	65		ma
DC Output Voltage at Input to Filter (Approx.):			
At half-load current (32.5 ma.).....	132		volts
At full-load current (65 ma.).....	112		volts
Voltage Regulation (Approx.):			
Half-load to full-load current.....	20		volts

### HALF-WAVE VACUUM RECTIFIER

Glass octal type used in power supply of ac/dc receivers. The heater is provided with a tap for operation of a panel lamp. Outline 22, OUTLINES SECTION. Tube requires octal socket. Except for difference in heater voltage, this type has the same ratings and typical operation values as glass-octal type 35Z5-GT.

## 45Z5-GT

HEATER VOLTAGE (AC/DC):	*		
ENTIRE HEATER (PINS 2 AND 7).....	45	**	
PANEL LAMP SECTIONS (PINS 2 AND 3).....	7.5	5.5	volts
HEATER CURRENT:			
BETWEEN PINS 2 AND 7.....	0.15	-	
BETWEEN PINS 3 AND 7.....	-	0.15	ampere

\* Without panel lamp.      \*\* With No. 40 or No.47 panel lamp.

### DUAL-GRID POWER AMPLIFIER

Glass type used as class A<sub>1</sub> or class B amplifier in radio equipment. Outline 41, OUTLINES SECTION. Tube requires five-contact socket. Filament volts (ac/dc), 2.5; amperes, 1.75. Typical operation as class A<sub>1</sub> amplifier (grid No.2 connected to plate at socket): plate volts, 250 max; grid volts, -33; plate ma., 22; plate resistance, 2380 ohms; amplification factor, 5.6; transconductance, 2350  $\mu$ mhos; load resistance for maximum undistorted power output, 6400 ohms; undistorted output watts, 1.25. This type is used principally for renewal purposes.

## 46

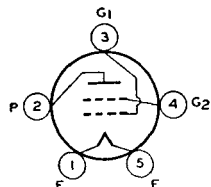

## PUSH-PULL CLASS B AMPLIFIER

(Grids No.1 and No.2 connected together at socket)

### Maximum Ratings:

PLATE VOLTAGE.....	400 <i>max</i>	volts
PEAK PLATE CURRENT.....	200 <i>max</i>	ma
AVERAGE PLATE DISSIPATION.....	10 <i>max</i>	watts

### Typical Operation (Values are for two tubes):

Plate Voltage.....	300	400	volts
Grid Voltage.....	0	0	volts
Peak AF Grid-to-Grid Voltage.....	113	116	volts
Zero-Signal Plate Current.....	8	12	ma
Effective Load Resistance (Plate-to-plate).....	5200	5800	ohms
Maximum-Signal Power Output (Approx.).....	16†	20#	watts

† With average power input of 950 milliwatts applied between grids.

# With average power input of 650 milliwatts applied between grids.

## POWER PENTODE

Glass type used in audio output stage of radio receivers. Outline 41, OUTLINES SECTION. Tube requires five-contact socket and should preferably be mounted in vertical position. Horizontal operation is permissible if pins 1 and 5 are in vertical plane. Filament volts (ac/dc), 2.5; amperes, 1.75. This type is used principally for renewal purposes.

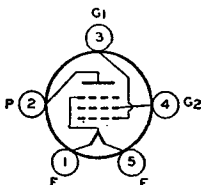

# 47

## CLASS A<sub>1</sub> AMPLIFIER

### Characteristics:

Plate Voltage (250 volts <i>max</i> ).....	250	volts
Grid-No.2 (Screen) Voltage (250 volts <i>max</i> ).....	250	volts
Grid-No.1 Voltage (Control-Grid)†.....	-16.5	volts
Cathode-Bias Resistor.....	450	ohms
Plate Current.....	31	ma
Grid-No.2 Current.....	6	ma
Plate Resistance.....	60000	ohms
Transconductance.....	2500	μmhos
Load Resistance.....	7000	ohms
Power Output.....	2.7	watts

† If filament is operated on dc, the grid bias should be -15.3 volts. The dc resistance in the grid circuit should not exceed 0.5 megohm with cathode bias, or 100000 ohms with fixed bias.

## POWER TETRODE

Glass type used in audio output stage of radio receivers designed to operate from dc powerlines. Outline 41, OUTLINES SECTION Heater volts (dc), 30; amperes, 0.4. Typical operation as class A<sub>1</sub> amplifier: plate volts, 125 *max*; grid-No.2 volts, 100 *max*; grid-No.1 volts, -20; plate ma., 56; grid-No.2 ma., 9.5; transconductance, 3900 μmhos; load resistance, 1500 ohms; output watts, 2.5. This is a DISCONTINUED type listed for reference only.

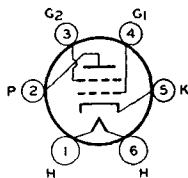

# 48

## DUAL-GRID POWER AMPLIFIER

Glass type used in output stage of battery-operated receivers. Outline 36, OUTLINES SECTION. Tube requires five-contact socket. Filament volts (dc), 2.0; amperes, 0.12. Typical operation as class A<sub>1</sub> amplifier (grid No.2 connected to plate at socket): plate volts, 135 *max*; grid volts, -20; plate ma., 6; plate resistance, 4175 ohms; amplification factor, 4.7; transconductance, 1125 μmhos; load resistance, 11000 ohms; output watts (approx.), 0.17. This type is used principally for renewal purposes.

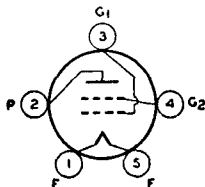

# 49

## PUSH-PULL CLASS B AMPLIFIER

(Grids No.1 and No.2 connected together at socket.)

### Maximum Ratings:

PLATE VOLTAGE.....	180 <i>max</i>	volts
PEAK PLATE CURRENT.....	50 <i>max</i>	ma

### Typical Operation (Values are for two tubes):

Plate Voltage.....	135	180	volts
Grid Voltage.....	0	0	volts
Zero-Signal Plate Current.....	2.6	4	ma
Effective Load Resistance (Plate-to-plate).....	8000	12000	ohms
Power Output (Approx.).....	2.3	3.5	watts

## POWER TRIODE

# 50

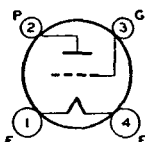

Glass type used in output stage of af amplifiers employing transformer input coupling. Outline 43, OUTLINES SECTION. Tube requires four-contact socket and should be mounted in vertical position with base down. Filament volts (ac/dc), 7.5; amperes, 1.25. Characteristics as class A<sub>1</sub> amplifier: plate volts, 450 *max*; grid volts, -84; cathode resistor, 1530 ohms; plate ma., 55; plate resistance, 1800 ohms; amplification factor, 3.8; transconductance, 2100  $\mu$ mhos;

load resistance, 4350 ohms; output watts, 4.6. Resistance in grid-coupling circuit should not exceed 10000 ohms. This type is used principally for renewal purposes.

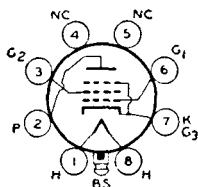

## BEAM POWER AMPLIFIER

# 50A5

Glass lock-in type used in output stage of ac/dc receivers. Outline 19, OUTLINES SECTION. Tube requires lock-in socket. Heater volts (ac/dc), 50; amperes, 0.15. For ratings and data, refer to glass-octal type 50L6-GT.

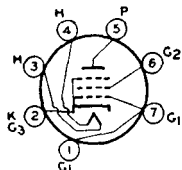

## BEAM POWER AMPLIFIER

# 50B5

Miniature type used in output stage of compact ac/dc receivers. Because of its high power sensitivity at plate and screen voltages available in ac/dc receivers, it is capable of providing a relatively high power output. Outline 15, OUTLINES SECTION. Tube requires miniature seven-contact socket and may be mounted in any position. Within its maximum ratings, type 50B5 is equivalent in performance to glass-octal type 50L6-GT and miniature type 50C5. Refer to type 50C5 for maximum ratings, typical operation, maximum circuit values, installation, application information, and curves.

providing a relatively high power output. Outline 15, OUTLINES SECTION. Tube requires miniature seven-contact socket and may be mounted in any position. Within its maximum ratings, type 50B5 is equivalent in performance to glass-octal type 50L6-GT and miniature type 50C5. Refer to type 50C5 for maximum ratings, typical operation, maximum circuit values, installation, application information, and curves.

HEATER VOLTS (AC/DC).....	50	volts
HEATER CURRENT.....	0.15	ampere
DIRECT INTERELECTRODE CAPACITANCES (Approx.):*		
Grid No.1 to Plate.....	0.5	$\mu$ mf
Input.....	13	$\mu$ mf
Output.....	6.5	$\mu$ mf

\* With no external shield.

BEAM POWER AMPLIFIER

50C5

Miniature type used in output stage of compact, ac/dc radio receivers. Because of its high power sensitivity and high efficiency at plate and screen voltages available in ac/dc receivers, the 50C5 is capable of providing a relatively high power output. Except

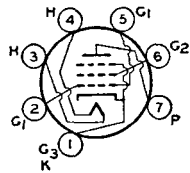

for terminal connections and slightly higher ratings, type 50C5 is equivalent in performance to miniature type 50B5 and, within its maximum ratings, to glass-octal type 50L6-GT. The basing arrangement of the 50C5 simplifies the problem of meeting Underwriters' Laboratories requirements in the design of ac/dc receivers.

HEATER VOLTAGE (AC/DC) .....	50	volts
HEATER CURRENT .....	0.15	ampere
DIRECT INTERELECTRODE CAPACITANCES (Approx.): <sup>o</sup>		
Grid No.1 to Plate .....	0.64	$\mu$ f
Input .....	13	$\mu$ f
Output .....	6.1	$\mu$ f

<sup>o</sup> With no external shield.

CLASS A<sub>1</sub> AMPLIFIER

Maximum Ratings:

PLATE VOLTAGE .....	135 <i>max</i>	volts
GRID-NO.2 (SCREEN) VOLTAGE .....	117 <i>max</i>	volts
PLATE DISSIPATION .....	5.5 <i>max</i>	watts
GRID-NO.2 INPUT .....	1.25 <i>max</i>	watts
PEAK HEATER-CATHODE VOLTAGE:		
Heater negative with respect to cathode .....	180 <i>max</i>	volts
Heater positive with respect to cathode .....	180 <i>max</i>	volts
BULB TEMPERATURE (At hottest point on bulb surface) .....	250 <i>max</i>	°C

Typical Operation:

Plate Voltage .....	110	volts
Grid-No.2 Voltage .....	110	volts
Grid-No.1 (Control-Grid) Voltage .....	-7.5	volts
Peak AF Grid-No.1 Voltage .....	7.5	volts
Zero-Signal Plate Current .....	49	ma
Maximum-Signal Plate Current .....	50	ma
Zero-Signal Grid-No.2 Current (Approx.) .....	4	ma
Maximum-Signal Grid-No.2 Current (Approx.) .....	8.5	ma
Plate Resistance (Approx.) .....	10000	ohms
Transconductance .....	7500	$\mu$ mhos
Load Resistance .....	2500	ohms
Total Harmonic Distortion .....	9	per cent
Maximum-Signal Power Output .....	1.9	watts

Maximum Circuit Values (For maximum rated conditions):

Grid-No.1-Circuit Resistance {	Cathode Bias .....	0.5 <i>max</i>	megohm
	Fixed Bias .....	0.1 <i>max</i>	megohm

INSTALLATION AND APPLICATION

Type 50C5 requires miniature seven-contact socket and may be mounted in any position. Outline 15, OUTLINES SECTION. It is especially important that this tube, like other power-handling tubes, should be adequately ventilated.

The 50-volt heater is designed to operate under the normal conditions of line-voltage variation without materially affecting the performance or serviceability of the 50C5. For operation of the 50C5 in series with other types having 0.15-ampere rating, the current in the heater circuit should be adjusted to 0.15 ampere for the normal supply voltage.

In a series-heater circuit of the "dc power line" type employing several 0.15-ampere types and one or two 50C5's, the heater(s) of the 50C5(s) should be placed on the positive side of the line. Under these conditions, heater-cathode voltage of the 50C5 must not exceed the value given under maximum ratings. In a series-heater circuit of the "universal" type employing rectifier tube 35W4, one or two 50C5's, and several 0.15-ampere types, it is recommended that the heater(s) of the 50C5's be placed in the circuit so that the higher values of heater-cathode bias will be impressed on the 50C5(s) rather than on the other 0.15-ampere types. This is accomplished by arranging the 50C5(s) on the side of the supply line which is connected to the cathode of the rectifier, i.e., the positive terminal of the rectified voltage supply. Between this side of the line and the 50C5(s), any necessary auxiliary resistance and the heater of the 35W4 are connected in series.

As a power amplifier (class A<sub>1</sub>), the 50C5 is recommended for use either singly or in push-pull combination in the power-output stage of "ac/dc" receivers. The operating values shown under typical operation have been determined on the basis that grid-No.1 current does not flow during any part of the input cycle. The type of input coupling used should not introduce too much resistance in the grid-No.1 circuit. Transformer- or impedance-coupling devices are recommended.

When the tube is operated at maximum rated conditions, the grid-No.1 circuit should have a dc resistance not higher than 0.1 megohm for fixed bias; for higher values, cathode bias is required. With cathode bias, the grid-No.1 circuit may have a dc resistance as high as, but not higher than, 0.5 megohm.

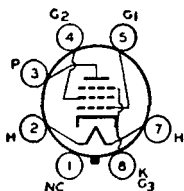
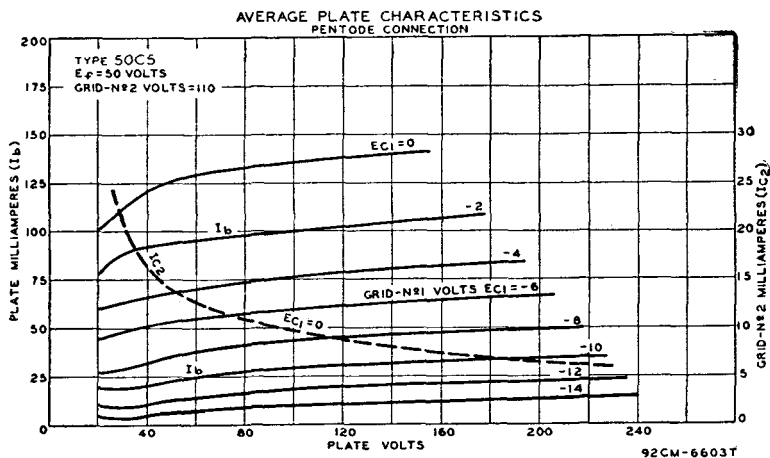

### BEAM POWER AMPLIFIER

Glass octal type used in output stage of ac/dc receivers. Outline 35, OUTLINES SECTION. Heater volts (ac/dc), 50; amperes, 0.15. Except for heater rating, this type is identical with glass octal type 6Y6-G.

## 50C6-G

**BEAM POWER AMPLIFIER**

Glass octal type used in output stage of ac/dc radio receivers. Outline 22, OUTLINES SECTION. Tube requires octal socket and may be mounted in any position. Refer to miniature type 50C5 for curves and installation and application information.

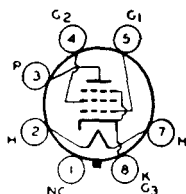

**50L6-GT**

HEATER VOLTAGE (AC/DC).....	50	volts
HEATER CURRENT.....	0.15	ampere
DIRECT INTERELECTRODE CAPACITANCES (Approx.):†		
Grid No.1 to Plate.....	0.6	μf
Input.....	15	μf
Output.....	9.5	μf

† With no external shield.

**CLASS A<sub>1</sub> AMPLIFIER**

**Maximum Ratings:**

PLATE VOLTAGE.....	200 max	volts
GRID-NO.2 (SCREEN) VOLTAGE.....	125 max	volts
PLATE DISSIPATION.....	10 max	watts
GRID-NO.2 INPUT.....	1.25 max	watts
PEAK HEATER-CATHODE VOLTAGE:		
Heater negative with respect to cathode.....	150 max	volts
Heater positive with respect to cathode.....	150 max	volts

**Typical Operation:**

	Fixed Bias	Cathode Bias	
Plate Voltage.....	110	200	volts
Grid-No.2 Voltage.....	110	125	volts
Grid-No.1 (Control-Grid) Voltage.....	-7.5	-	volts
Peak AF Grid-No.1 Voltage.....	7.5	8.0	volts
Cathode Resistor.....	-	180	ohm
Zero-Signal Plate Current.....	49	46	ma
Maximum-Signal Plate Current.....	50	47	ma
Zero-Signal Grid-No.2 Current (Approx.).....	4	2.2	ma
Maximum-Signal Grid-No.2 Current (Approx.).....	10	8.5	ma
Plate Resistance (Approx.).....	13000	28000	ohms
Transconductance.....	8000	8000	μmhos
Load Resistance.....	2000	4000	ohms
Total Harmonic Distortion.....	10	10	per cent
Maximum-Signal Power Output.....	2.1	3.8	watts

**VACUUM RECTIFIER-DOUBLER**

Lock-in type used as half-wave rectifier or voltage doubler in ac/dc receivers. Outline 19, OUTLINES SECTION. Tube requires lock-in socket. Heater volts (ac/dc), 50; amperes, 0.15. This type is electrically identical with glass-octal type 50Y6-GT and, except for heater rating, with glass-octal type 25Z6-GT. Refer to type 25Z6-GT for maximum ratings, typical operation, and curves.

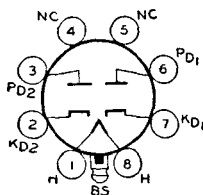

**50X6**

**VACUUM RECTIFIER-DOUBLER**

Glass octal type used as half-wave rectifier or voltage doubler in ac/dc receivers. This type is used particularly in "transformerless" receivers of either the ac/dc type or the voltage-doubler type. Outline 22, OUTLINES SECTION. Tube requires octal socket. Heater volts (ac/dc), 50; amperes, 0.15. Except for heater rating, this type is electrically identical with type 25Z6-GT.

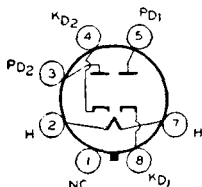

**50Y6-GT**



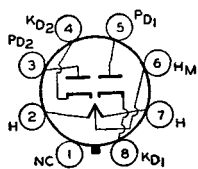

**VACUUM RECTIFIER-DOUBLER**

Glass octal type used as half-wave rectifier or voltage doubler in ac/dc receivers. This type is used particularly in "transformerless" receivers of either the ac/dc type or the voltage-doubler type. The heater is provided with a tap for operation of a panel lamp. Outline 22, OUTLINES SECTION. Tube requires octal socket.

**50Y7-GT**

For maximum ratings and typical operation as half-wave rectifier or voltage doubler without panel lamp, refer to glass octal type 25Z6-GT. When operated with a panel lamp and 250-ohm panel-lamp shunting resistor, ratings and typical operation are the same as for type 25Z6-GT, except that dc output current per plate is 65 ma.

HEATER VOLTAGE (AC/DC):	*	**	
ENTIRE HEATER (PINS 2 AND 7).....	50	46	volts
PANEL LAMP SECTION (PINS 6 AND 7).....	7.5	5.5	volts
HEATER CURRENT:			
BETWEEN PINS 2 AND 7.....	0.15	-	ampere
BETWEEN PINS 2 AND 6.....	-	0.15	ampere

\* Without panel lamp.      \*\* With No. 40 or No. 47 panel lamp.

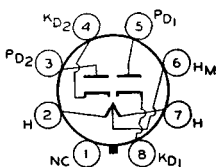

**VACUUM RECTIFIER-DOUBLER**

Glass octal type used as half-wave rectifier or voltage doubler in ac/dc receivers. Outline 31, OUTLINES SECTION. The heater is provided with a tap for operation of a panel lamp. Without panel lamp, heater volts (ac/dc) of entire heater (pins 2 and 7), 50; amperes, 0.15. With panel lamp, heater volts (ac/dc) of panel-lamp section (pins 6 and 7 with 0.15 ampere

**50Z7-G**

between pins 2 and 7), 2. Maximum ratings as rectifier or doubler: peak inverse plate volts, 700 max; peak plate ma. per plate, 400 max; dc output ma. per plate with panel lamp, 65 max; peak heater-cathode volts, 350 max; panel lamp section volts (pins 6 and 7), 2.5 max. This is a DISCONTINUED type listed for reference only.

**HIGH-MU TWIN POWER TRIODE**

Glass type used in output stage of ac-operated receivers as a class B power amplifier. Outline 36, OUTLINES SECTION. Tube requires medium seven-contact (0.855-inch pin-circle diameter) socket. Heater volts (ac/dc), 2.5; amperes, 2.0. Except for heater rating, this type is electrically identical with metal type 6N7. Type 53 is used principally for renewal purposes.

**53**

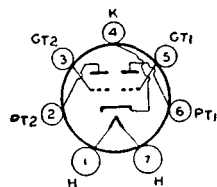

**TWIN DIODE—MEDIUM-MU TRIODE**

Glass type used as a combined detector, amplifier, and avc tube. Outline 34, OUTLINES SECTION. Tube requires six-contact socket. Heater volts (ac/dc), 2.5; amperes, 1.0. Except for heater rating, this type is electrically identical with glass type 85. Type 55 is used principally for renewal purposes.

**55**

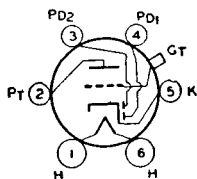

**MEDIUM-MU TRIODE**

Glass type used as detector, amplifier, or oscillator in ac-operated receivers. Outline 32, OUTLINES SECTION. Tube requires five-contact socket. Heater volts (ac/dc), 2.5; amperes, 1.0. Except for heater rating, this type is electrically identical with glass type 76. Type 56 is used principally for renewal purposes.

**56**

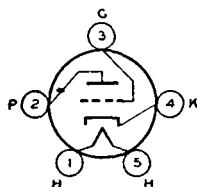

**SHARP-CUTOFF PENTODE**

57

Glass type used as biased detector in ac-operated receivers. Outline 38, OUTLINES SECTION. Tube requires six-contact socket. Heater volts (ac/dc), 2.5; amperes, 1.0. Except for heater rating and capacitances, this type is electrically identical with metal type 6J7. Type 57 is used principally for renewal purposes.

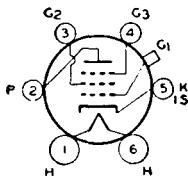

**REMOTE-CUTOFF PENTODE**

58

Glass type used in rf and if stages of radio receivers employing avc and as a mixer in super-heterodyne circuits. Outline 38, OUTLINES SECTION. Tube requires six-contact socket. Heater volts (ac/dc), 2.5; amperes, 1.0. Except for heater ratings, this type is electrically identical with glass-octal type 6U7-G. Type 58 is used principally for renewal purposes.

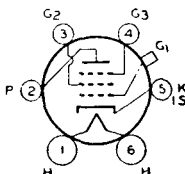

**TRIPLE-GRID POWER AMPLIFIER**

59

Glass type used in audio output stage of ac-operated receivers. Outline 41, OUTLINES SECTION. Tube requires medium seven-contact (0.855-inch, pin-circle diameter) socket. Heater volts (ac/dc), 2.5; amperes, 2.0. Typical operation as class A<sub>1</sub> amplifier (triode connection; grids No.2 and No.3 tied to plate): plate volts, 250 max; grid volts, -28; plate ma., 26;

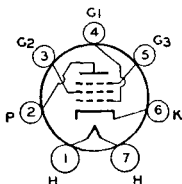

plate resistance, 2300 ohms; amplification factor, 6; transconductance, 2600; load resistance for maximum undistorted power output, 5000 ohms; undistorted output watts, 1.25. For typical operation as class A<sub>1</sub> amplifier (pentode connection; grid No.3 tied to cathode at socket), refer to type 6F6 with plate voltage of 250 volts. This type is used principally for renewal purposes.

**CLASS B AMPLIFIER—Triode Connection\***

**Maximum Ratings:**

PLATE VOLTAGE .....	400 max	volts
PEAK PLATE CURRENT .....	200 max	ma
PLATE DISSIPATION .....	10 max	watts
GRID INPUT (GRIDS NO.1 AND NO.2) .....	1.5 max	watts

**Typical Operation (Values are for two tubes):**

Plate Voltage .....	300	400	volts
Grid Voltage .....	0	0	volts
Zero-Signal Plate Current .....	20	26	ma
Effective Load Resistance (Plate-to-plate) .....	4600	6000	ohms
Power Output (Approx.) .....	15	20	watts

\* Grid No.3 tied to plate; grids No.1 and No.2 tied together.

**RECTIFIER—BEAM POWER AMPLIFIER**

70L7-GT

Glass octal type used as combined half-wave rectifier and output amplifier in ac/dc receivers. Outline 26, OUTLINES SECTION. Tube requires octal socket. Heater volts (ac/dc), 70; amperes, 0.15. Maximum ratings of rectifier unit: peak inverse plate volts, 350; peak plate ma., 420; dc output ma., 70; peak heater-cathode volts, 175; minimum total effective

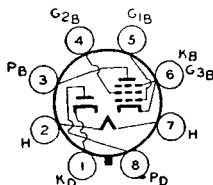
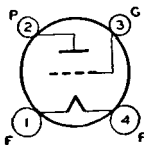

plate-supply impedance, 15 ohms. Typical operation and maximum ratings of beam power unit as class A<sub>1</sub> amplifier: plate and grid-No.2 volts, 110 (117 max); grid-No.1 volts, -7.5; plate ma., 40; grid-No.2 ma., 3; plate resistance, 15000 ohms; transconductance, 7500 μmhos; load resistance, 2000 ohms; output watts, 1.8; plate dissipation, 5 max watts; grid-No.2 input, 1 max watt.

**POWER TRIODE**

**71-A**



Glass type used in output stage of audio-frequency amplifiers. Outline 36, OUTLINES SECTION. Tube requires four-contact socket. Filament volts (ac/dc), 5.0; amperes, 0.25. Characteristics as class A<sub>1</sub> amplifier: plate volts, 180 *max*; grid volts, -40.5; cathode resistor, 2150 ohms; plate ma., 20; plate resistance, 1750 ohms; amplification factor, 3; transconductance,

1700  $\mu$ hos; load resistance, 4800 ohms; undistorted output watts, 0.79. This type is used principally for renewal purposes.

**TWIN DIODE—HIGH-MU TRIODE**

**75**

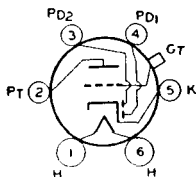

Glass type used as combined detector, amplifier, and avc tube in radio receivers. Outline 34, OUTLINES SECTION. Tube requires six-contact socket. Heater volts (ac/dc), 6.3; amperes, 0.3. Except for interelectrode capacitances and plate volts of 250 *max*, this type is identical electrically with metal type 6SQ7. Type 75 is used principally for renewal purposes.

**MEDIUM-MU TRIODE**

**76**

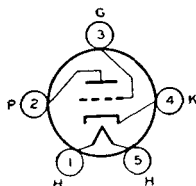

Glass type used as voltage amplifier or detector in radio receivers. Outline 32, OUTLINES SECTION. Tube requires five-contact socket. Heater volts (ac/dc), 6.3; amperes, 0.3. Characteristics as class A<sub>1</sub> amplifier: plate volts, 250 *max*; grid volts, -13.5; plate ma., 5; plate resistance, 9500 ohms; transconductance, 1450  $\mu$ hos. For typical operation as a resistance-

coupled amplifier, refer to Chart 23, RESISTANCE-COUPLED AMPLIFIER SECTION. This type is used principally for renewal purposes.

**SHARP-CUTOFF PENTODE**

**77**

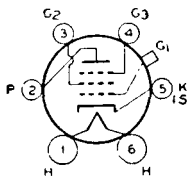

Glass type used as biased detector or high-gain amplifier in radio receivers. Outline 34, OUTLINES SECTION. Tube requires six-contact socket. Heater volts (ac/dc), 6.3; amperes, 0.3. Except for capacitances and grid-No. 2 rating of 100 *max* volts, type 77 is electrically identical with metal type 6J7. This type is used principally for renewal purposes.

**REMOTE-CUTOFF PENTODE**

**78**

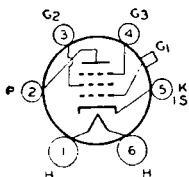

Glass type used in rf and if stages of radio receivers, particularly those employing avc. Outline 34, OUTLINES SECTION. Tube requires six-contact socket. Heater volts (ac/dc), 6.3; amperes, 0.3. Except for capacitances, this type is identical electrically with metal type 6K7. Type 78 is used principally for renewal purposes.

**HIGH-MU TWIN POWER TRIODE**

**79**

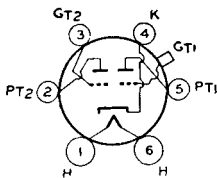

Glass type used in output stage of radio receivers as a class B power amplifier or a class A<sub>1</sub> driver. Outline 34, OUTLINES SECTION. Tube requires six-contact socket. Heater volts (ac/dc), 6.3; amperes, 0.6. Maximum ratings and typical operation as class B power amplifier: plate volts, 250 *max*; grid volts, 0; zero-signal plate ma., 10.5; effective load resistance

(plate-to-plate), 14000 ohms; output watts (approx.), 8; peak plate ma. per plate, 90 *max*; average plate dissipation, 11.5 watts *max*. For typical operation as a resistance-coupled amplifier, refer to Chart 24, RESISTANCE-COUPLED AMPLIFIER SECTION. This type is used principally for renewal purposes.

**FULL-WAVE VACUUM RECTIFIER**

**80**

Glass type used in power supply of radio equipment having moderate direct-current requirements. Outline 36, OUTLINES SECTION. Tube requires four-contact socket and should

be mounted preferably in a vertical position. Horizontal mounting is permissible if pins 1 and 4 are in a horizontal plane. Filament volts (ac), 5.0; amperes, 2.0. For filament operation, refer to type 5U4-G. Type 80 is electrically identical with glass-octal type 5Y3-GT.

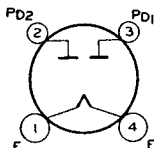

**HALF-WAVE VACUUM RECTIFIER**

**81**

Glass type used in power supply of radio receivers. Outline 43, OUTLINES SECTION. Tube requires four-contact socket and should be mounted preferably in a vertical position. Horizontal mounting is permissible if pins 1 and 4 are in a vertical plane. Filament volts (ac), 7.5; amperes, 1.25. Ratings as half-wave rectifier: peak inverse plate volts, 2000 *max*; peak plate ma., 500 *max*; dc output ma., 85 *max*. This type is used principally for renewal purposes.

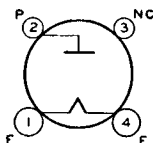

**FULL-WAVE MERCURY-VAPOR RECTIFIER**

**82  
83**

Glass types used to supply dc power of uniform voltage to receivers in which the rectified current requirements are subject to considerable variation. Outlines 36 and 41, respectively, OUTLINES SECTION. Tubes require four-contact socket and should be mounted in vertical position with base down. Type 82 is used principally for renewal purposes.

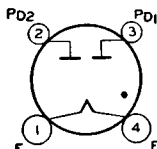

FILAMENT VOLTAGE (AC).....	<i>Type 82</i> 2.5	<i>Type 83</i> 5	volts
FILAMENT CURRENT.....	3	3	amperes

**Maximum Ratings: FULL-WAVE RECTIFIER**

PEAK INVERSE PLATE VOLTAGE.....	1550 <i>max</i>	1550 <i>max</i>	volts
PEAK PLATE CURRENT PER PLATE.....	0.6 <i>max</i>	1.0 <i>max</i>	ampere
DC OUTPUT CURRENT.....	115 <i>max</i>	225 <i>max</i>	ma
CONDENSED-MERCURY TEMPERATURE RANGE.....	24 to 60	20 to 60	°C

**Typical Operation (With Capacitor-Input Filter):**

AC Plate-to-Plate Supply Voltage (rms).....	900	900	volts
Minimum Total Effective Plate-Supply Impedance per Plate†.....	50	50	ohms
DC Output Current.....	115	225	ma

**Typical Operation (With Choke-Input Filter):**

AC Plate-to-Plate Supply Voltage (rms).....	1100	1100	volts
Minimum Filter-Input Choke.....	6	3	henries
DC Output Current.....	115	225	ma

† When a filter-input capacitor larger than 40  $\mu$ f is used, it may be necessary to use more plate-supply impedance than the minimum value shown to limit the peak plate current to the rated value.

**FULL-WAVE VACUUM RECTIFIER**

**83-v**

Glass type used in power supply of radio equipment having high dc requirements. Outline 36, OUTLINES SECTION. Tube requires four-contact socket. Heater volts (ac), 5.0; amperes, 2. This type is identical electrically with glass-octal type 5V4-G. Type 83-v is used principally for renewal purposes.

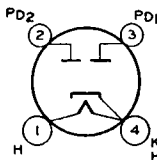

**FULL-WAVE VACUUM RECTIFIER**

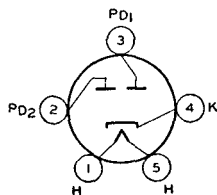

Glass type used in power supply of automobile and ac-operated radio receivers. Outline 32, OUTLINES SECTION. Tube requires five-contact socket. Heater volts (ac/dc), 6.3; amperes, 0.5. Maximum ratings: peak inverse plate volts, 1250 *max*; peak plate ma., 180 *max*; dc output ma., 60 *max*; peak heater-cathode volts, 450 *max*. Typical operation with capacitor-

**84/6Z4**

input filter: ac plate-to-plate supply volts (rms), 650; minimum total effective plate-supply impedance per plate, 150 ohms; dc output ma., 60. Typical operation with choke-input filter: ac plate-to-plate supply volts (rms), 900; minimum filter-input choke, 10 henries; dc output ma., 60. This type is used principally for renewal purposes.

**TWIN DIODE—MEDIUM-MU TRIODE**

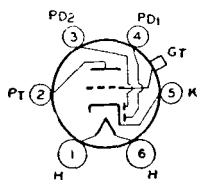

Glass type used as a combined detector, amplifier, and avc tube. Outline 34, OUTLINES SECTION. Tube requires six-contact socket. Heater volts (ac/dc), 6.3; amperes, 0.3. Characteristics of triode unit as class A<sub>1</sub> amplifier: plate volts, 250 *max*; grid volts, -20; amplification factor, 8.3; transconductance, 1100  $\mu$ mhos; plate ma., 8.0; plate resistance, 7500 ohms; load

**85**

resistance, 20000 ohms; output watts, 0.35. For typical operation as a resistance-coupled amplifier, refer to Chart 22, RESISTANCE-COUPLED AMPLIFIER SECTION. This type is used principally for renewal purposes.

**TRIPLE-GRID POWER AMPLIFIER**

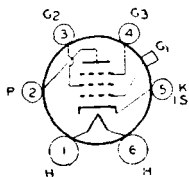

Glass type used in output stage of radio receivers. Outline 34, OUTLINES SECTION. Tube requires six-contact socket. Heater volts (ac/dc), 6.3; amperes, 0.4. Maximum ratings as class B amplifier (triode connection): plate volts, 250 *max*; peak plate ma. per tube, 90 *max*; average grid input of grids No.1 and No.2 tied together, 0.35 *max* watt. This type is used principally for renewal purposes.

**89**

**CLASS A<sub>1</sub> AMPLIFIER**

**Typical Operation:**

	Triode Connection*	Pentode Connection**	
Plate Voltage (250 <i>max</i> )	180	180	volts
Grid-No.2 (Screen) Voltage (250 <i>max</i> )	-	180	volts
Grid-No.1 (Control-Grid) Voltage	-22.5	-18	volts
Cathode Resistor	1125	785	ohms
Plate Current	20	20	ma
Grid-No.2 Current	-	3	ma
Amplification Factor	4.7	-	
Plate Resistance	3000	8000	ohms
Transconductance	1550	1550	$\mu$ mhos
Load Resistance	6500†	8000	ohms
Power Output	0.4	1.5	watts

\* Grids No.2 and No.3 tied to plate.

\*\* Grid No.3 tied to cathode.

† Optimum for maximum undistorted power output of 0.4 watt.

**CLASS B AMPLIFIER (Triode Connection)‡**

**Typical Operation (Values are for two tubes):**

Plate Voltage	180	volts
Grid Voltage	0	volts
Peak AF Grid-to-Grid Voltage	68	volts
Zero-Signal Plate Current	6	ma
Effective Load Resistance (Plate-to-plate)	9400	ohms
Total Harmonic Distortion	8	per cent
Power Output (Approx.)	3.5	watts

‡ Grids No.1 and No.2 tied together; grid No.3 tied to plate.

**DETECTOR AMPLIFIER TRIODE**

**V99**

Glass types used as detector or amplifier in battery-operated receivers. Filament volts (dc), 3.0 to 3.3; amperes, 0.060 to 0.063. Characteristics as class A<sub>1</sub> amplifier: plate volts, 90 *max*; grid volts, -4.5; amplification factor, 6.6; transconductance, 425 μmhos; plate ma., 2.5. Operation as grid-resistor detector: plate volts, 45; grid resistor, 0.25 to 5 megohms; grid capacitor, 250 μμf; grid return to (+) filament. Operation as biased detector: plate volts, 90 *max*; grid volts (approx.), -10.5. These are DISCONTINUED types listed for reference only.

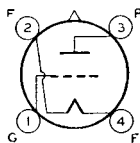

**X99**

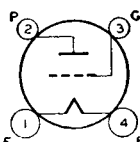

**DETECTOR AMPLIFIER TRIODE**

**112-A**

Glass type used as detector or amplifier in battery-operated receivers. Outline 36, OUTLINES SECTION. Filament volts (dc), 5.0; amperes, 0.25. Operation as class A<sub>1</sub> amplifier: plate volts, 180 *max*; grid volts, -13.5; amplification factor, 8.5; transconductance, 1800 μmhos; plate ma., 7.7; load resistance, 10650 ohms; output watts, 0.285. Operation as biased detector: plate volts, 180; grid volts, -21. This is a DISCONTINUED type listed for reference only.

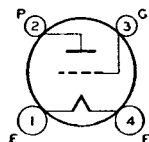

**RECTIFIER—BEAM POWER AMPLIFIER**

**117L7/  
M7-GT**

Glass octal type used as combined half-wave rectifier and output amplifier in ac/dc receivers. Outline 26, OUTLINES SECTION. Tube requires octal socket. Heater volts (ac/dc), 117;

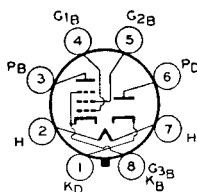

amperes, 0.09. For ratings and operation of rectifier unit, refer to type 117N7-GT

**AMPLIFIER UNIT AS CLASS A<sub>1</sub> AMPLIFIER**

**Maximum Ratings:**

PLATE VOLTAGE.....	117 <i>max</i>	volts
GRID-NO.2 (SCREEN) VOLTAGE.....	117 <i>max</i>	volts
PLATE INPUT.....	6.0 <i>max</i>	watts
GRID-NO.2 DISSIPATION.....	1.0 <i>max</i>	watt

**Typical Operation:**

PLATE VOLTAGE.....	105	volts
Grid-No.2 Voltage.....	105	volts
Grid-No.1 (Control-Grid) Voltage.....	-5.2	volts
Peak AF Grid-No.1 Voltage.....	5.2	volts
Zero-Signal Plate Current.....	43	ma
Maximum-Signal Plate Current.....	43	ma
Zero-Signal Grid-No.2 Current (Approx.).....	4	ma
Maximum-Signal Grid-No.2 Current (Approx.).....	5.5	ma
Plate Resistance (Approx.).....	17000	ohms
Transconductance.....	5300	μmhos
Load Resistance.....	4000	ohms
Total Harmonic Distortion.....	5	per cent
Maximum-Signal Power Output.....	0.85	watt

**RECTIFIER—BEAM POWER  
AMPLIFIER**

**117N7-GT**

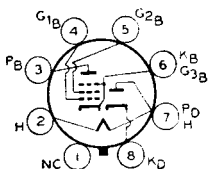

Glass octal type used as combined half-wave rectifier and output amplifier in ac/dc receivers. Outline 26, OUTLINESSECTION. Tuberequires octal socket and may be mounted in

any position. Heater volts (ac/dc), 117; amperes, 0.09. When the amplifier unit is operated at maximum rated conditions, the grid-No.1 circuit should have a dc resistance not higher than 0.25 megohm for fixed bias; for higher values, cathode bias is required. With cathode bias, the grid-No.1 circuit may have a dc resistance as high as, but not higher than, 1.0 megohm.

**RECTIFIER UNIT AS HALF-WAVE RECTIFIER**

**Maximum Ratings:**

PEAK INVERSE PLATE VOLTAGE.....	350 <i>max</i>	volts
PEAK PLATE CURRENT.....	450 <i>max</i>	ma
DC OUTPUT CURRENT.....	75 <i>max</i>	ma
PEAK HEATER-CATHODE VOLTAGE:		
Heater negative with respect to cathode.....	175 <i>max</i>	volts

**Typical Operation (Capacitor-Input Filter):**

AC Plate-Supply Voltage (rms).....	117	volts
Filter-Input Capacitor.....	40	$\mu$ f
Minimum Total Effective Plate-Supply Impedance†.....	15	ohms
DC Output Current.....	75	ma
DC Output Voltage at Input to Filter (Approx.).....	122	volts

†When a filter-input capacitor larger than 40  $\mu$ f is used, it may be necessary to use more plate-supply impedance than the minimum value shown to limit the peak plate current to the rated value.

**AMPLIFIER UNIT AS CLASS A<sub>1</sub> AMPLIFIER**

**Maximum Ratings:**

PLATE VOLTAGE.....	117 <i>max</i>	volts
GRID-NO.2 (SCREEN) VOLTAGE.....	117 <i>max</i>	volts
PLATE DISSIPATION.....	5.5 <i>max</i>	watts
GRID-NO.2 INPUT.....	1.0 <i>max</i>	watt

**Typical Operation:**

Plate Voltage.....	100	volts
Grid-No.2 Voltage.....	100	volts
Grid-No.1 (Control-Grid) Voltage.....	-6	volts
Peak AF Grid-No.1 Voltage.....	6	volts
Zero-Signal Plate Current.....	51	ma
Zero-Signal Grid-No.2 Current.....	5	ma
Plate Resistance (Approx.).....	16000	ohms
Transconductance.....	7000	$\mu$ mhos
Load Resistance.....	3000	ohms
Total Harmonic Distortion.....	6	per cent
Maximum-Signal Power Output.....	1.2	watts

**RECTIFIER—BEAM POWER  
AMPLIFIER**

**117P7-GT**

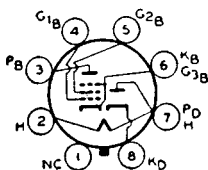

Glass octal type used as combined half-wave rectifier and output tube. Outline 26, OUTLINES SECTION. Tube requires octal socket. Heater volts (ac/dc), 117; amperes, 0.09. This tube is electrically identical with glass-octal type 117L7/M7-GT.

### HALF-WAVE VACUUM RECTIFIER

# 117Z3

Miniature type used in power supply of ac/dc, battery radio receivers. The heater is designed for operation directly across a 117-volt ac or dc supply line.

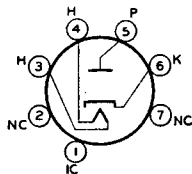

HEATER VOLTAGE (AC/DC).....	117	volts
HEATER CURRENT.....	0.04	ampere

### HALF-WAVE RECTIFIER

**Maximum Ratings:**

PEAK INVERSE PLATE VOLTAGE.....	330 <i>max</i>	volts
PEAK PLATE CURRENT.....	540 <i>max</i>	ma
DC OUTPUT CURRENT.....	90 <i>max</i>	ma
PEAK HEATER-CATHODE VOLTAGE:		
Heater negative with respect to cathode.....	175 <i>max</i>	volts
Heater positive with respect to cathode.....	100 <i>max</i>	volts

**Typical Operation (Capacitor-Input to Filter):**

AC Plate-Supply Voltage (rms).....	117	volts
Filter-Input Capacitor.....	30	$\mu$ f
Minimum Total Effective Plate-Supply Impedance.....	20	ohms
DC Output Current.....	90	ma
DC Output Voltage at Input to Filter (Approx):		
At half-load current (45 ma.).....	130	volts
At full-load current (90 ma.).....	110	volts
Voltage Regulation (Approx.):		
Half-load to full-load current.....	20	volts

When a filter-input capacitor larger than 40  $\mu$ f is used, it may be necessary to use more plate-supply impedance than the minimum value shown to limit the peak plate current to the rated value.

## INSTALLATION AND APPLICATION

Type 117Z3 requires miniature seven-contact socket and may be mounted in any position. Outline 15, OUTLINES SECTION. It is especially important that this tube, like other power-handling tubes, should be adequately ventilated.

Refer to the CIRCUITS SECTION for typical application of the 117Z3 as a half-wave rectifier in a portable 3-way superheterodyne receiver.

OPERATION CHARACTERISTICS

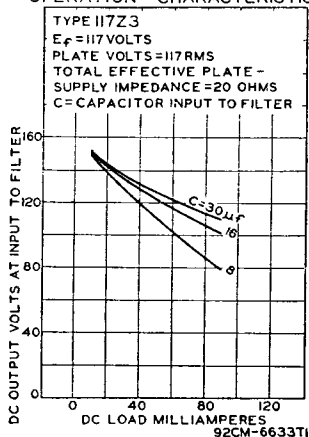



## HALF-WAVE VACUUM RECTIFIER

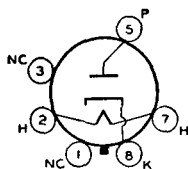

# 117Z4-GT

Glass octal type used in power supply of ac/dc/battery radio receivers. Dimensions: maximum overall length, 3 inches; maximum seated height, 2 $\frac{3}{4}$  inches; maximum diameter, 1-5/16 inches; T-9 bulb; intermediate-shell octal 7-pin base. Tube requires octal socket. Heater volts (ac/dc), 117; amperes, 0.04. Maximum ratings as half-wave rectifier: peak inverse plate volts, 350 *max*; peak plate ma., 540 *max*;

peak heater-cathode volts, 175 *max*. Typical operation with capacitor-input filter: ac plate supply volts (rms), 117; minimum total effective plate-supply impedance, 30 ohms; dc output ma., 90.

## VACUUM RECTIFIER-DOUBLER

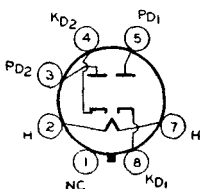

# 117Z6-GT

Glass octal type used as half-wave rectifier or voltage doubler in ac/dc receivers. Outline 22, OUTLINES SECTION. Tube requires octal socket and may be mounted in any position. Heater volts (ac/dc), 117; amperes, 0.075.

### HALF-WAVE RECTIFIER

#### Maximum Ratings:

PEAK INVERSE PLATE VOLTAGE.....	700 <i>max</i>	volts
PEAK PLATE CURRENT PER PLATE.....	360 <i>max</i>	ma
DC OUTPUT CURRENT PER PLATE.....	60 <i>max</i>	ma
PEAK HEATER-CATHODE VOLTAGE.....	350 <i>max</i>	volts

#### Typical Operation (Capacitor-Input Filter):<sup>o</sup>

AC Plate-Supply Voltage per Plate (rms).....	117	150	235	volts
Filter-Input Capacitor.....	40	40	40	$\mu$ f
Minimum Total Effective Plate-Supply Impedance per Plate $\dagger$ .....	15	40	100	ohms
DC Output Current per Plate.....	60	60	60	ma

### VOLTAGE DOUBLER

#### Maximum Ratings:

(Same as for Half-Wave Rectifier)

#### Typical Operation:

	<i>Half-Wave</i>	<i>Full-Wave</i>	
AC Plate-Supply Voltage per Plate (rms).....	117	117	volts
Filter-Input Capacitor.....	40	40	$\mu$ f
Minimum Total Effective Plate-Supply Impedance per Plate $\dagger$ ..	30	15	ohms
DC Output Current.....	60	60	ma

<sup>o</sup> In half-wave rectifier service, the two units may be used separately or in parallel.

$\dagger$  When a filter-input capacitor larger than 40 $\mu$ f is used, it may be necessary to use more plate-supply impedance than the minimum value shown to limit the peak plate current to the rated value.

## POWER TRIODE

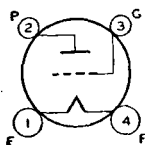

Glass type used in output stage of radio receivers. Outline 36, OUTLINES SECTION. Filament volts (ac/dc), 5.0; amperes, 1.25. Characteristics: plate volts, 250; grid volts, -60; plate ma., 30; amplification factor, 3; plate resistance, 1750 ohms; transconductance, 1700  $\mu$ mhos; load resistance, 5000 ohms; output watts, 1.8. This is a DISCONTINUED type listed for reference only.

# 183/483

## DETECTOR AMPLIFIER TRIODE

485

Glass type used as detector or class A<sub>1</sub> amplifier in radio receivers. Outline 32, OUTLINES SECTION. Heater volts (ac/dc), 3; amperes, 1.25. Characteristics: plate volts, 180; grid volts, -9; amplification factor, 12.5; plate resistance, 8900 ohms; transconductance, 1400  $\mu$ mhos; plate ma., 5.8. This is a DISCONTINUED type listed for reference only.

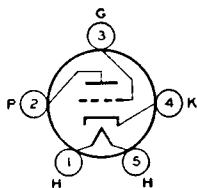

## CURRENT REGULATORS

876

886

Constant-current regulating devices (ballast tubes) used in radio receivers. Bases fit the standard mogul screw socket and tubes may be mounted in any position. Tubes operate at high bulb temperature. They must be surrounded by a protective metal ventilating stack. Operating conditions: voltage range, 40 to 60 volts; ambient temperature, 150°F; operating current for the 876, 1.7 amperes; for the 886, 2.05 amperes. These are DISCONTINUED types listed for reference only.



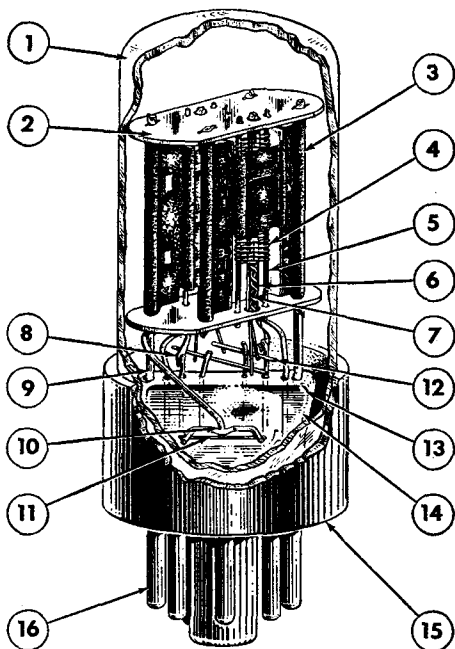

## TUBE-PART MATERIALS in Typical RCA Electron Tube

- |  |   |
|--|---|
| 1. ENVELOPE—Lime glass   | 8. CATHODE TAB—Nickel                                     |
| 2. SPACER—Mica sprayed with magnesium oxide  | 9. MOUNT SUPPORT — Nickel or nickel-plated iron           |
| 3. PLATE—Carbonized nickel or nickel-plated steel                                  | 10. GETTER SUPPORT AND LOOP— Nickel or nickel-plated iron |
| 4. GRID WIRES—Manganese-nickel or molybdenum                                       | 11. GETTER—Barium-magnesium alloys                        |
| 5. GRID SIDE-RODS—Chrome copper, nickel, or nickel-plated iron                     | 12. HEATER CONNECTOR—Nickel or nickel-plated iron         |
| 6. CATHODE—Nickel coated with barium-calcium-strontium carbonates                  | 13. STEM LEAD-IN WIRES—Nickel, dumet, copper              |
| 7. HEATER—Tungsten or tungsten-molybdenum alloy with insulating coating of alundum | 14. PRESSED STEM—Lead glass                               |
|  | 15. BASE—Bakelite   |
|  | 16. BASE PINS—Nickel-plated brass                         |

# Electron Tube Testing

The electron tube user—service man, experimenter, or non-technical radio listener—is interested in knowing the condition of his tubes, since they govern the performance of the device in which they are used. In order to determine the condition of a tube, some method of test is necessary. Because the operating capabilities and design features of a tube are indicated and described by its electrical characteristics, a tube is tested by measuring its characteristics and comparing them with values established as standard for that type. Tubes which read abnormally high with respect to the standard for the type are subject to criticism just the same as tubes which are too low.

Certain practical limitations are placed on the accuracy with which a tube test can be correlated with actual tube performance. These limitations make it unnecessary for the service man and dealer to employ complex and costly testing equipment having laboratory accuracy. Because the accuracy of the tube-testing device need be no greater than the accuracy of the correlation between test results and receiver performance, and since certain fundamental characteristics are virtually fixed by the manufacturing technique of leading tube manufacturers, it is possible to employ a relatively simple test in order to determine the serviceability of a tube.

In view of these factors, dealers and service men will find it economically expedient to obtain adequate accuracy and simplicity of operation by employing a device which indicates the status of a single characteristic. Whether the tube is satisfactory or unsatisfactory is judged from the test result of this single characteristic. Consequently, it is very desirable that the characteristic selected for the test be one which is truly representative of the tube's overall condition.

The following information and circuits are given to describe and illustrate general theoretical and practical tube-tester considerations and not to provide information on the construction of a home-made tube tester. In addition to the problem of determining what tube characteristic is most representative of performance capabilities in all types of receivers, the designer of a home-made tester faces the difficult problem of determining satisfactory limits for his particular tester. The obtaining of information of this nature, if it is to be accurate and useful, is a tremendous job. It requires the testing of a large number of tubes of each type, the testing of many types, and the correlation of these readings with performance in many kinds of equipment.

## SHORT CIRCUIT TEST

The fundamental circuit of a short-circuit tester is shown in Fig. 78. Although this circuit is suitable for tetrodes and types having less than four electrodes, tubes of more electrodes may be tested by adding more indicator lamps to the circuit. Voltages are applied between the various electrodes with lamps in series with the electrode leads. The value of the voltages applied will depend on the type of tube being tested. Any two shorted electrodes complete a circuit and light one or more lamps. Since two electrodes may be just touching to give a high-resistance short, it is desirable that the indicating lamps operate on very low current. It is also desirable to maintain the filament or heater of the

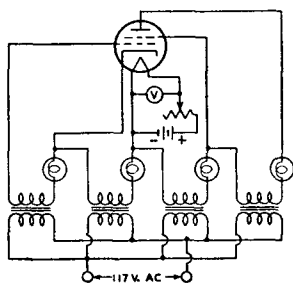

Fig. 78

tube at its operating temperature during the short-circuit test, because short-circuits in a tube may sometimes occur only when the electrodes are heated.

### SELECTION OF A SUITABLE CHARACTERISTIC FOR TEST

Some characteristics of a tube are far more important in determining its operating worth than are others. The cost of building a device to measure any one of the more important characteristics may be considerably higher than that of a device which measures a less representative characteristic. Consequently, three methods of test will be discussed, ranging from relatively simple and inexpensive equipment to more elaborate, more accurate, and more costly devices.

An **emission test** is perhaps the simplest method of indicating a tube's condition. (Refer to **Diodes**, in **ELECTRONS, ELECTRODES, AND ELECTRON TUBES SECTION**, for a discussion of electron emission.) Since emission falls off as the tube wears out, low emission is indicative of the end of tube serviceability. However, the emission test is subject to limitations because it tests the tube under static conditions and does not take into account the actual operation of the tube. On the one hand, coated filaments, or cathodes, often develop active spots from which the emission is so great that the relatively small grid area adjacent to these spots cannot control the electron stream. Under these conditions, the total emission may indicate the tube to be normal although the tube is unsatisfactory. On the other hand, coated types of filaments are capable of such large emission that the tube will often operate satisfactorily after the emission has fallen far below the original value.

Fig. 79 shows the fundamental circuit diagram for an emission test. All of the electrodes of the tube, except the cathode, are connected to the plate. The filament, or heater, is operated at rated voltage; after the tube has reached constant temperature, a low positive voltage is applied to the plate and the electron emission is read on the meter. Readings which are well below the average for a particular tube type indicate that the total number of available electrons has been so reduced that the tube is no longer able to function properly.

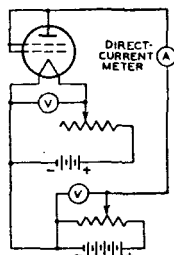

Fig. 79

A **transconductance test** takes into account a fundamental operating principle of the tube. (This will be seen from the definition of transconductance in the Section on **ELECTRON TUBE CHARACTERISTICS**.) It follows that transconductance tests when properly made, permit better correlation between test results and actual performance than does a straight emission test.

There are two forms of transconductance test which can be utilized in a tube tester. In the first form (illustrated by Fig. 80 giving a fundamental circuit with a tetrode under test), appropriate operating voltages are applied to the electrodes of the tube. A plate current depending upon the electrode voltages, will then be indicated by the meter. If the bias on the grid is then shifted by the application of a different grid voltage, a new plate-current reading is obtained. The difference between the two plate-current readings is indicative of the transconductance of the tube. This method of transconductance testing is commonly called the "grid-shift" method, and depends on readings under static conditions. The fact that this form of test is made under static conditions imposes limitations not encountered in the second form of test made under dynamic conditions.

The dynamic transconductance test illustrated in Fig. 81 gives a fundamental circuit with a tetrode under test. This method is superior to the static transconductance test in that ac voltage is applied to the grid. Thus, the tube is tested

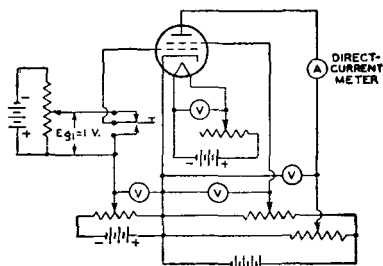

Fig. 80

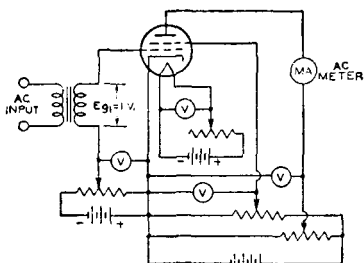

Fig. 81

under conditions which approximate actual operating conditions. The alternating component of the plate current is read by means of an ac ammeter of the dynamometer type. The transconductance of the tube is equal to the ac plate current divided by the input-signal voltage. If a one-volt rms signal is applied to the grid, the plate-current-meter reading in milliamperes multiplied by one thousand is the value of transconductance in micromhos.

The **power-output test** probably gives the best correlation between test results and actual operating performance of a tube. In the case of voltage amplifiers, the power output is indicative of the amplification and output voltages obtainable from the tube. In the case of power-output tubes, the performance of the tube is closely checked. Consequently, although more complicated to set up, the power-output test will give closer correlation with actual performance than any other single test.

Fig. 82 shows the fundamental circuit of a power-output test for class A operation of tubes. The diagram illustrates the method for a pentode. The ac output voltage developed across the plate-load impedance ( $L$ ) is indicated by the current meter. The current meter is isolated as far as the dc plate current is concerned by the capacitor ( $C$ ). The power output can be calculated from the current reading and known load resistance. In this way, it is possible to determine the operating condition of the tube quite accurately.

Fig. 83 shows the fundamental circuit of a power-output test for class B operation of tubes. With ac voltage applied to the grid of the tube, the current in the plate circuit is read on a dc milliammeter. The power output of the tube is approximately equal to:

$$\text{Power output (watts)} = \frac{(\text{dc current in amperes})^2 \times \text{load resistance in ohms}}{0.405}$$

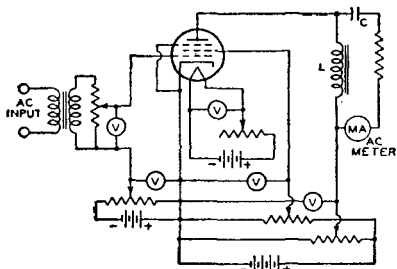

Fig. 82

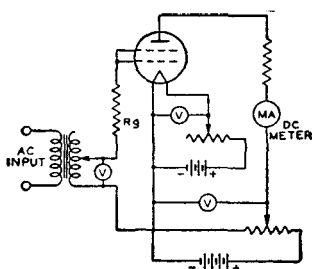

Fig. 83

## ESSENTIAL TUBE-TESTER REQUIREMENTS

1. It is desirable that the tester provide for a short-circuit test to be made prior to measurement of the tube's characteristics.

2. It is important that some means of controlling the voltages applied to the electrodes of the tube be provided. If the tester is ac operated, a line-voltage control permits the supply of proper electrode voltages.

3. It is essential that the rated voltage applied to the filament or heater be maintained accurately.

4. It is suggested that the characteristics test follow one of the methods described. The method selected and the quality of the parts used in the test will depend upon the requirements of the user.

## TUBE-TESTER LIMITATIONS

A tube-testing device can only indicate the difference between a given tube's characteristics and those which are standard for that particular type. Since the operating conditions imposed upon a tube of a given type may vary within wide limits, it is impossible for a tube-testing device to evaluate tubes in terms of performance capabilities for all applications. The tube tester, therefore, cannot be looked upon as a final authority in determining whether or not a tube is always satisfactory. Actual operating test in the equipment in which the tube is to be used will give the best possible indication of a tube's worth.

# Resistance-Coupled Amplifiers

Type	Chart No.	Type	Chart No.
1L4	1	6SR7	9
1S5	2	6ST7	9
1U4	3	6SZ7	7
1U5	2	6T7-G	7
2A6	4	6T8	7
2B7	5	6W7-G	11
6A6	6		
6AQ6	7	6Z7-G	21
6AQ7-GT	7	12AT6	7
6AT6	7	12AU6	8
6AU6	8	12AV6	25
6AV6	25	12AU7	10
6B6-G	4	12AX7	25
6B7	5	12C8	5
6B8 (G)	5	12F5-GT	18
6BF6	9	12J5-GT	13
6C4	10	12J7-GT	}T 11
6C5 (GT)	11		
6C6	}T 11	12Q7-GT	7
		}P 14	12S8-GT
6C8-G	12		12SC7
6F5 (GT)	18	12SF5	18
6F8-G	13	12SF7	19
6J5 (GT)	13	12SH7	8
6J7 (G,GT)	}T 11	12SJ7 (GT)	20
		}P 14	12SL7-GT
6L5-G	15		12SN7-GT
6N7 (GT)	6	12SQ7 (GT)	4
6Q7 (G,GT)	7	12SR7	9
6R7 (GT)	9	19T8	7
6S7 (G)	16	53	6
6S8-GT	4	55	22
6SC7	17	56	23
6SF5 (GT)	18	57	}T 11
6SF7	19		
6SH7	8	75	4
6SJ7 (GT)	20	76	23
6SL7-GT	7	79	24
6SN7-GT	13	85	22
6SQ7 (GT)	4		

T=Triode Connection  
P=Pentode Connection

## KEY TO CHARTS

Resistance-coupled, audio-frequency voltage amplifiers utilize simple components and are capable of providing essentially uniform amplification over a relatively wide frequency range.

## Suitable Tubes

In this section, data are given for over 80 types of tubes suitable for use in resistance-coupled circuits. These types include low- and high- $\mu$  triodes, twin triodes, triode-connected pentodes, and pentodes. The accompanying key to tube types will assist in locating the appropriate data chart.

## Circuit Advantages

For most of the types shown, the data pertain to operation with cathode bias; for all of the pentodes, the data pertain to operation with series screen resistor. The use of a cathode-bias resistor where feasible and a series screen resistor where applicable offer several advantages over fixed-voltage operation.

The advantages are: (1) effects of possible tube differences are minimized; (2) operation over a wide range of plate-supply voltages without appreciable change in gain is feasible; (3) the low frequency at which the amplifier cuts off is easily changed; and (4) tendency toward motorboating is minimized.

## Number of Stages

These advantages can be enhanced by the addition of suitable decoupling filters in the plate supply of each stage of a multi-stage amplifier. With proper filters, three or more amplifier stages can be operated from a single power-supply unit of conventional design without encountering any difficulties due to coupling through the power unit. When decoupling filters are not used, not more than two stages should be operated from a single power-supply unit.



## SYMBOLS USED IN RESISTANCE-COUPLED AMPLIFIER CHARTS

- |   |   |
|---|---|
| <p><math>C</math> = Blocking Capacitor (<math>\mu f</math>).</p> <p><math>C_k</math> = Cathode Bypass Capacitor (<math>\mu f</math>).</p> <p><math>C_{g2}</math> = Screen Bypass Capacitor (<math>\mu f</math>).</p> <p><math>E_{bb}</math> = Plate-Supply Voltage (volts).<br/>Voltage at plate equals plate-supply voltage minus drop in <math>R_p</math> and <math>R_k</math>. See Note 1 below.</p> <p><math>R_k</math> = Cathode Resistor (ohms).</p> <p><math>R_{g2}</math> = Screen Resistor (megohms).</p> <p><math>R_g</math> = Grid Resistor (megohms) for following stage.</p> <p><math>R_p</math> = Plate Resistor (megohms).</p> | <p><math>V.G.</math> = Voltage Gain. At 5 volts (rms) output unless otherwise specified.</p> <p><math>E_o</math> = Peak Output Voltage (volts).<br/>This voltage is obtained across <math>R_g</math> (for following stage) at any frequency within the flat region of the output vs frequency curve, and is for the condition where the signal level is adequate to swing the grid of the resistance-coupled amplifier tube to the point where its grid starts to draw current.</p> |
|---|---|

**Note 1:** For other supply voltages differing by as much as 50 per cent from those listed, the values of resistors, capacitors, and voltage gain are approximately correct. The value of voltage output, however, for any of these other supply voltages, equals the listed voltage output multiplied by the new plate-supply voltage divided by the plate-supply voltage corresponding to the listed voltage output.

## GENERAL CIRCUIT CONSIDERATIONS

In the discussions which follow, the frequency ( $f_2$ ) is that value at which the high-frequency response begins to fall off. The frequency ( $f_1$ ) is that value at which the low-frequency response drops below a satisfactory value, as discussed below. Decoupling filters are not necessary for two stages or less. A variation of 10 per cent in values of resistors and capacitors has only slight effect on performance. One-half-watt resistors are usually suitable for  $R_{g2}$ ,  $R_g$ ,  $R_p$ , and  $R_k$  resistors. Capacitors  $C$  and  $C_{g2}$  should have a working voltage equal to or greater than  $E_{bb}$ . Capacitor  $C_k$  may have a low working voltage in the order of 10 to 25 volts. Peak Input Voltage is equal to the Peak Output Voltage divided by the Voltage Gain.

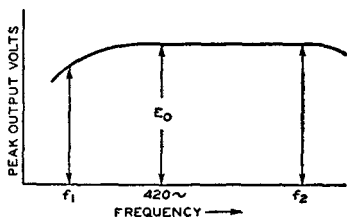

### Triode (Heater-Cathode Type) Amplifier

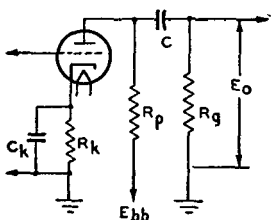

Diagram No. 1

Capacitors  $C$  and  $C_k$  have been chosen to give an output voltage equal to  $0.8 E_o$  for a frequency ( $f_1$ ) of 100 cycles. For any other value of  $f_1$ , multiply values of  $C$  and  $C_k$  by  $100/f_1$ . In the case of capacitor  $C_k$ , the values shown in the charts are for an amplifier with dc heater excitation; when ac is used, depending on the character of the associated circuit, the gain, and the value of  $f_1$ , it may be necessary to increase the value of  $C_k$  to minimize hum disturbances. It may be desirable to operate the heater at a positive voltage of from 15 to 40 volts with respect to the cathode. The voltage output at  $f_1$  of "n" like stages equals  $(0.8)^n E_o$  where  $E_o$  is the peak output voltage of final stage. For an amplifier of typical construction, the value of  $f_2$  is well above the audio-frequency range for any value of  $R_p$ .

Pentode (Filament-Type) Amplifier

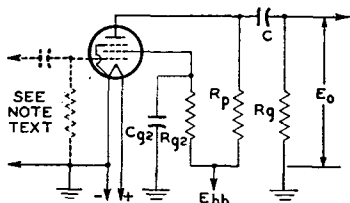

Diagram No. 2

should be such that their product lies between 0.02 and 0.1. Values commonly used are 0.005  $\mu$ f and 10 megohms.

Capacitors C and  $C_{g2}$  have been chosen to give an output voltage equal to 0.8  $E_o$  for a frequency ( $f_1$ ) of 100 cycles. For any other value of  $f_1$ , multiply values of C and  $C_{g2}$  by  $100/f_1$ . The voltage output at  $f_1$  for "n" like stages equals  $(0.8)^n E_o$  where  $E_o$  is peak output voltage of final stage. For an amplifier of typical construction, and for  $R_p$  values of 0.1, 0.25, and 0.5 megohm, approximate values of  $f_2$  are 20000, 10000, and 5000 cps, respectively. Note: The values of input-coupling capacitor in microfarads and of grid resistor in megohms

Pentode (Heater-Cathode Type) Amplifier

Capacitors C,  $C_k$ , and  $C_{g2}$  have been chosen to give an output voltage equal to 0.7  $E_o$  for a frequency ( $f_1$ ) of 100 cycles. For any other value of  $f_1$ , multiply values of C,  $C_k$ , and  $C_{g2}$  by  $100/f_1$ . In the case of capacitor  $C_k$ , the values shown in the charts are for an amplifier with dc heater excitation; when ac is used, depending on the character of the associated circuits, the voltage gain, and the value of  $f_1$ , it may be necessary to increase the value of  $C_k$  to minimize hum disturbances. It may be desirable to operate the heater at a positive voltage of from 15 to 40 volts with respect to the cathode. The voltage output at  $f_1$  for "n" like stages equals  $(0.7)^n E_o$  where  $E_o$  is peak output voltage of final stage. For an amplifier of typical construction, and for  $R_p$  values of 0.1, 0.25, and 0.5 megohm, approximate values of  $f_2$  are 20000, 10000, and 5000 cps, respectively.

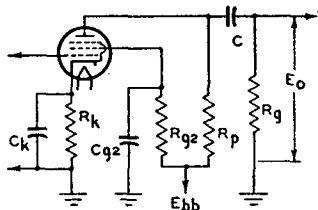

Diagram No. 3

Phase Inverters

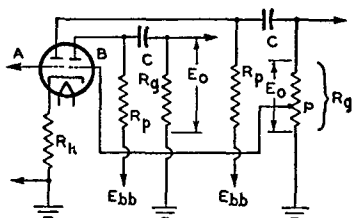

Diagram No. 4

Information given for triode amplifiers, in general, applies to this case. Capacitors C have been chosen to give an output voltage equal to 0.9  $E_o$  for a frequency ( $f_1$ ) of 100 cycles. For any other value of  $f_1$ , multiply values of C by  $100/f_1$ . The signal input is applied to grid of triode unit A. Grid of triode unit B obtains its signal from a tap (P) on the grid resistor ( $R_g$ ) in the output circuit of unit A. The tap is chosen so as to make the voltage output of unit B equal to that of unit A. Its location is determined by the voltage gain

values given in the charts. For example, if V.G. is 20 (from the charts), P is chosen so as to supply 1/20 of the voltage across  $R_g$  to the grid of unit B. For phase-inverter service, the cathode resistor may be left unbypassed unless a bypass capacitor is necessary to minimize hum; omission of the bypass capacitor assists in balancing the output stages. The value of  $R_k$  is specified on the basis that both units are operating simultaneously at the same values of plate load and plate voltage.

# RCA RECEIVING TUBE MANUAL

(See page 247 for explanation of symbols)

Ebb	R <sub>p</sub>	R <sub>g</sub>	R <sub>g2</sub>	R <sub>k</sub>	C <sub>g2</sub>	C <sub>k</sub>	C	E <sub>o</sub>	V.G.
45	0.22	0.22	0.24	-	0.071	-	0.011	12	16★
		0.47	0.32	-	0.06	-	0.006	14	23
		1.0	0.39	-	0.056	-	0.0035	18	30
	0.47	0.47	0.57	-	0.049	-	0.0052	14	22
		1.0	0.64	-	0.047	-	0.0035	17	30
		2.2	0.74	-	0.044	-	0.0018	19	33
	1.0	1.0	1.1	-	0.036	-	0.0028	14	28
		2.2	1.25	-	0.035	-	0.0018	16	32
		3.3	1.45	-	0.032	-	0.0015	18	38
90	0.22	0.22	0.4	-	0.089	-	0.011	26	28
		0.47	0.46	-	0.081	-	0.0055	36	36
		1.0	0.47	-	0.08	-	0.0035	42	41
	0.47	0.47	0.84	-	0.07	-	0.0055	30	34
		1.0	0.9	-	0.069	-	0.003	38	42
		2.2	1.0	-	0.062	-	0.0018	40	50
	1.0	1.0	2.0	-	0.045	-	0.0028	30	45
		2.2	2.1	-	0.045	-	0.0018	35	55
		3.3	2.2	-	0.044	-	0.0012	40	61
135	0.22	0.22	0.5	-	0.09	-	0.011	42	34
		0.47	0.63	-	0.074	-	0.0055	54	51
		1.0	0.67	-	0.072	-	0.0035	57	60
	0.47	0.47	1.1	-	0.071	-	0.005	47	49
		1.0	1.4	-	0.06	-	0.0028	54	68
		2.2	1.5	-	0.051	-	0.0018	60	87
	1.0	1.0	2.1	-	0.059	-	0.0025	45	53
		2.2	2.4	-	0.054	-	0.0018	57	88
		3.3	2.7	-	0.049	-	0.0012	61	91
45	0.22	0.22	0.26	-	0.042	-	0.013	14	17
		0.47	0.36	-	0.035	-	0.006	17	24
		1.0	0.4	-	0.034	-	0.004	18	28
	0.47	0.47	0.82	-	0.025	-	0.0055	14	25
		1.0	1.0	-	0.023	-	0.003	17	33
		2.2	1.1	-	0.022	-	0.002	18	38
	1.0	1.0	1.9	-	0.019	-	0.003	14	31
		2.2	2.0	-	0.019	-	0.002	17	38
		3.3	2.2	-	0.018	-	0.0015	18	43
90	0.22	0.22	0.5	-	0.05	-	0.011	31	25
		0.47	0.59	-	0.05	-	0.006	37	34
		1.0	0.67	-	0.042	-	0.003	40	41
	0.47	0.47	1.2	-	0.035	-	0.005	31	37
		1.0	1.4	-	0.034	-	0.003	36	47
		2.2	1.6	-	0.031	-	0.002	40	57
	1.0	1.0	2.5	-	0.026	-	0.003	31	45
		2.2	2.9	-	0.025	-	0.002	36	58
		3.3	3.1	-	0.024	-	0.0012	38	66
135	0.22	0.22	0.66	-	0.052	-	0.011	45	31
		0.47	0.71	-	0.051	-	0.006	56	41
		1.0	0.86	-	0.039	-	0.003	60	54
	0.47	0.47	1.45	-	0.042	-	0.005	46	44
		1.0	1.8	-	0.034	-	0.003	54	62
		2.2	1.9	-	0.033	-	0.002	60	71
	1.0	1.0	3.1	-	0.03	-	0.003	45	56
		2.2	3.7	-	0.029	-	0.0015	53	76
		3.3	4.3	-	0.026	-	0.0014	56	88

1

1L4

See Circuit Diagram 2

2

1S5  
1U5

See Circuit Diagram 2

★ At 4 volts (rms) output.

# RCA RECEIVING TUBE MANUAL

(See page 247 for explanation of symbols)

3

**1U4**

See Circuit Diagram 2

E <sub>bb</sub>	R <sub>p</sub>	R <sub>g</sub>	R <sub>g2</sub>	R <sub>k</sub>	C <sub>g2</sub>	C <sub>k</sub>	C	E <sub>o</sub>	V.G.
45	0.22	0.22	0.06	-	0.046	-	0.011	11	23
		0.47	0.07	-	0.045	-	0.006	15	33
		1.0	0.011	-	0.04	-	0.003	17	39
	0.47	0.47	0.34	-	0.025	-	0.005	13	34
		1.0	0.44	-	0.022	-	0.003	16	46
		2.2	0.5	-	0.022	-	0.002	18	55
	1.0	1.0	1.0	-	0.016	-	0.003	14	43
		2.2	1.0	-	0.016	-	0.002	17	51
		3.3	1.1	-	0.015	-	0.001	17	60
90	0.22	0.22	0.3	-	0.046	-	0.01	27	37
		0.47	0.36	-	0.04	-	0.006	36	54
		1.0	0.4	-	0.038	-	0.003	39	63
	0.47	0.47	0.9	-	0.027	-	0.0045	29	61
		1.0	1.0	-	0.023	-	0.003	35	82
		2.2	1.1	-	0.022	-	0.002	38	96
	1.0	1.0	1.9	-	0.02	-	0.0025	30	77
		2.2	2.0	-	0.02	-	0.002	35	98
		3.3	2.2	-	0.018	-	0.001	37	114
135	0.22	0.22	0.4	-	0.052	-	0.011	44	46
		0.47	0.49	-	0.037	-	0.005	55	71
		1.0	0.52	-	0.034	-	0.003	60	83
	0.47	0.47	1.1	-	0.029	-	0.0045	45	77
		1.0	1.3	-	0.023	-	0.003	53	106
		2.2	1.4	-	0.022	-	0.002	59	123
	1.0	1.0	2.3	-	0.021	-	0.0025	45	104
		2.2	2.5	-	0.019	-	0.0015	53	136
		3.3	2.9	-	0.016	-	0.001	56	163

4

**2A6  
6B6-G  
6S8-GT  
6SQ7  
6SQ7-GT  
12S8-GT  
12SQ7  
12SQ7-GT  
75**

See Circuit Diagram 1

90	0.1	0.1	-	6300	-	2.2	0.02	3	23 <sup>⊖</sup>
		0.25	-	6600	-	1.7	0.01	5	29 <sup>■</sup>
		0.5	-	6700	-	1.7	0.006	6	31 <sup>★</sup>
	0.25	0.25	-	10000	-	1.24	0.01	5	34 <sup>■</sup>
		0.5	-	11000	-	1.07	0.006	7	40 <sup>★</sup>
		1.0	-	11500	-	0.9	0.003	10	40
	0.5	0.5	-	16200	-	0.75	0.005	7	39
		1.0	-	16600	-	0.7	0.003	10	44
		2.0	-	17400	-	0.65	0.0015	13	48
180	0.1	0.1	-	2600	-	3.3	0.025	16	29
		0.25	-	2900	-	2.9	0.015	22	36
		0.5	-	3000	-	2.7	0.007	23	37
	0.25	0.25	-	4300	-	2.1	0.015	21	43
		0.5	-	4800	-	1.8	0.007	28	50
		1.0	-	5300	-	1.5	0.004	33	53
	0.5	0.5	-	7000	-	1.3	0.007	25	52
		1.0	-	8000	-	1.1	0.004	33	57
		2.0	-	8800	-	0.9	0.002	38	58
300	0.1	0.1	-	1900	-	4.0	0.03	31	31
		0.25	-	2200	-	3.5	0.015	41	39
		0.5	-	2300	-	3.0	0.007	45	42
	0.25	0.25	-	3300	-	2.7	0.015	42	48
		0.5	-	3900	-	2.0	0.007	51	53
		1.0	-	4200	-	1.8	0.004	60	56
	0.5	0.5	-	5300	-	1.6	0.007	47	58
		1.0	-	6100	-	1.3	0.004	62	60
		2.0	-	7000	-	1.2	0.002	67	63

⊖ At 2 volts (rms) output. ■ At 3 volts (rms) output. ★ At 4 volts (rms) output.

# RCA RECEIVING TUBE MANUAL

(See page 247 for explanation of symbols)

E <sub>bb</sub>	R <sub>p</sub>	R <sub>g</sub>	R <sub>g2</sub>	R <sub>k</sub>	C <sub>g2</sub>	C <sub>k</sub>	C	E <sub>o</sub>	V.G.
90	0.1	0.1	0.37	2000	0.07	3.0	0.02	19	24
		0.25	0.5	2200	0.07	3.0	0.01	28	33
		0.5	0.6	2000	0.06	2.8	0.006	29	37
	0.25	0.25	1.18	3500	0.04	1.9	0.008	26	43
		0.5	1.1	3500	0.04	2.1	0.007	33	55
		1.0	1.35	3500	0.04	1.9	0.003	32	65
	0.5	0.5	2.6	5000	0.04	1.5	0.004	22	63
		1.0	2.8	6000	0.04	1.55	0.003	29	85
		2.0	2.9	6200	0.04	1.5	0.003	27	100
180	0.1	0.1	0.44	1000	0.08	4.4	0.02	30	30
		0.25	0.5	1200	0.08	4.4	0.015	52	41
		0.5	0.6	1200	0.07	4.0	0.008	53	46
	0.25	0.25	1.18	1900	0.05	2.7	0.01	39	55
		0.5	1.2	2100	0.06	3.2	0.007	55	69
		1.0	1.5	2200	0.05	3.0	0.003	53	83
	0.5	0.5	2.6	3300	0.04	2.1	0.005	47	81
		1.0	2.8	3500	0.04	2.0	0.003	55	115
		2.0	3.0	3500	0.04	2.2	0.002	53	116
300	0.1	0.1	0.5	950	0.09	4.6	0.025	60	36
		0.25	0.55	1100	0.09	5.0	0.015	89	47
		0.5	0.6	900	0.08	4.8	0.009	86	54
	0.25	0.25	1.2	1500	0.06	3.2	0.015	70	64
		0.5	1.2	1600	0.06	3.5	0.008	100	79
		1.0	1.5	1800	0.08	4.0	0.004	95	100
	0.5	0.5	2.7	2400	0.05	2.5	0.006	80	96
		1.0	2.9	2500	0.05	2.3	0.003	120	150
		2.0	3.4	2800	0.05	2.8	0.0025	90	145

5

**2B7**  
**6B7**  
**6B8**  
**6B8-G**  
**12C8**

See Circuit  
Diagram 3

90	0.1	0.1	-	1900*	-	-	0.025	13	16
		0.25	-	2250*	-	-	0.01	19	19
		0.5	-	2500*	-	-	0.006	20	20
	0.25	0.25	-	4050*	-	-	0.01	16	20
		0.5	-	4950*	-	-	0.006	20	22
		1.0	-	5400*	-	-	0.003	24	23
	0.5	0.5	-	7000*	-	-	0.006	18	22
		1.0	-	8500*	-	-	0.003	23	23
		2.0	-	9650*	-	-	0.0015	26	23
180	0.1	0.1	-	1300*	-	-	0.03	35	19
		0.25	-	1700*	-	-	0.015	46	21
		0.5	-	1950*	-	-	0.007	50	22
	0.25	0.25	-	2950*	-	-	0.015	40	23
		0.5	-	3800*	-	-	0.007	50	24
		1.0	-	4300*	-	-	0.0035	57	24
	0.5	0.5	-	5250*	-	-	0.007	44	24
		1.0	-	6600*	-	-	0.0035	54	25
		2.0	-	7650*	-	-	0.002	61	25
300	0.1	0.1	-	1150*	-	-	0.03	60	20
		0.25	-	1500*	-	-	0.015	83	22
		0.5	-	1750*	-	-	0.007	86	23
	0.25	0.25	-	2650*	-	-	0.015	75	23
		0.5	-	3400*	-	-	0.0055	87	24
		1.0	-	4000*	-	-	0.003	100	24
	0.5	0.5	-	4850*	-	-	0.0055	76	23
		1.0	-	6100*	-	-	0.003	94	24
		2.0	-	7150*	-	-	0.0015	104	24

6

**6A6#**  
**6N7#**  
**6N7-GT#**  
**53#**

See Circuit  
Diagram 4

# The cathodes of the two units have a common terminal  
\*Values shown are for phase-inverter service.

# RCA RECEIVING TUBE MANUAL

(See page 247 for explanation of symbols)

7

**6AQ6**  
**6AQ7-GT**  
**6AT6**  
**6Q7**  
**6Q7-G**  
**6Q7-GT**  
**6SL7-GT\***  
**6SZ7**  
**6T7-G**  
**6T8**  
**12AT6**  
**12Q7-GT**  
**12SL7-GT\***  
**19T8**

See Circuit  
Diagram 1

Ebb	R <sub>p</sub>	R <sub>g</sub>	R <sub>g2</sub>	R <sub>k</sub>	C <sub>g2</sub>	C <sub>k</sub>	C	E <sub>o</sub>	V.G.
90	0.1	0.1	—	4200	—	2.5	0.025	5.4	22●
		0.22	—	4600	—	2.2	0.014	7.5	27●
		0.47	—	4800	—	2.0	0.0065	9.1	30●
	0.22	0.22	—	7000	—	1.5	0.013	7.3	30●
		0.47	—	7800	—	1.3	0.007	10	34■
		1.0	—	8100	—	1.1	0.0035	12	37★
0.47	0.47	—	12000	—	0.83	0.006	10	36■	
	1.0	—	14000	—	0.7	0.0035	14	39★	
	2.2	—	15000	—	0.6	0.002	16	41★	
180	0.1	0.1	—	1900	—	3.6	0.027	19	30★
		0.22	—	2200	—	3.1	0.014	25	35
		0.47	—	2500	—	2.8	0.0065	32	37
	0.22	0.22	—	3400	—	2.2	0.014	24	38
		0.47	—	4100	—	1.7	0.0065	34	42
		1.0	—	4600	—	1.5	0.0035	38	44
0.47	0.47	—	6600	—	1.1	0.0065	29	44	
	1.0	—	8100	—	0.9	0.0035	38	46	
	2.2	—	9100	—	0.8	0.002	43	47	
300	0.1	0.1	—	1500	—	4.4	0.027	40	34
		0.22	—	1800	—	3.6	0.014	54	38
		0.47	—	2100	—	3.0	0.0065	63	41
	0.22	0.22	—	2600	—	2.5	0.013	51	42
		0.47	—	3200	—	1.9	0.0065	65	46
		1.0	—	3700	—	1.6	0.0035	77	48
0.47	0.47	—	5200	—	1.2	0.006	61	48	
	1.0	—	6300	—	1.0	0.0035	74	50	
	2.2	—	7200	—	0.9	0.002	85	51	

8

**6AU6**  
**6SH7**  
**12AU6**  
**12SH7**

See Circuit  
Diagram 3

90	0.1	0.1	0.07	1800	0.11	9.0	0.021	25	52
		0.22	0.09	2100	0.1	8.2	0.012	32	72
		0.47	0.096	2100	0.1	8.0	0.0065	37	88
	0.22	0.22	0.25	3100	0.08	6.2	0.009	25	72
		0.47	0.26	3200	0.078	5.8	0.0055	32	99
		1.0	0.35	3700	0.085	5.1	0.003	34	125
0.47	0.47	0.75	6300	0.042	3.4	0.0035	27	102	
	1.0	0.75	6500	0.042	3.3	0.0027	32	126	
	2.2	0.8	6700	0.04	3.2	0.0018	36	152	
180	0.1	0.1	0.12	800	0.15	14.1	0.021	57	74
		0.22	0.15	900	0.126	14.0	0.012	82	116
		0.47	0.19	1000	0.1	12.5	0.006	81	141
	0.22	0.22	0.38	1500	0.09	9.6	0.009	59	130
		0.47	0.43	1700	0.08	8.7	0.005	67	171
		1.0	0.6	1900	0.066	8.1	0.003	71	200
0.47	0.47	0.9	3100	0.06	5.7	0.0045	54	172	
	1.0	1.0	3400	0.05	5.4	0.0028	65	232	
	2.2	1.1	3600	0.04	3.6	0.0019	74	272	
300	0.1	0.1	0.2	500	0.13	18.0	0.019	76	109
		0.22	0.24	600	0.11	16.4	0.011	103	145
		0.47	0.26	700	0.11	15.3	0.006	129	168
	0.22	0.22	0.42	1000	0.1	12.4	0.009	92	164
		0.47	0.5	1000	0.098	12.0	0.007	108	230
		1.0	0.55	1100	0.09	11.0	0.003	122	262
0.47	0.47	1.0	1800	0.075	8.0	0.0045	94	248	
	1.0	1.1	1900	0.065	7.6	0.0028	105	318	
	2.2	1.2	2100	0.06	7.3	0.0018	122	371	

● At 2 volts (rms) output. ■ At 3 volts (rms) output. ★ At 4 volts (rms) output.  
● One triode unit.

# RCA RECEIVING TUBE MANUAL

(See page 247 for explanation of symbols)

E <sub>bb</sub>	R <sub>p</sub>	R <sub>g</sub>	R <sub>g2</sub>	R <sub>k</sub>	C <sub>g2</sub>	C <sub>k</sub>	C	E <sub>o</sub>	V.G.
90	0.047	0.047	-	2200	-	2.5	0.063	14	9
		0.1	-	2800	-	2.0	0.033	18	10
		0.22	-	3200	-	1.7	0.015	20	10
	0.1	0.1	-	4100	-	1.4	0.032	13	10
		0.22	-	5400	-	1.0	0.013	20	11
		0.47	-	6400	-	0.9	0.007	24	11
	0.22	0.22	-	8500	-	0.67	0.015	18	11
		0.47	-	12000	-	0.5	0.0065	23	11
		1.0	-	14000	-	0.43	0.0035	27	11
180	0.047	0.047	-	2000	-	2.9	0.062	32	10
		0.1	-	2500	-	2.2	0.033	42	10
		0.22	-	3000	-	1.9	0.016	47	11
	0.1	0.1	-	3800	-	1.5	0.033	36	11
		0.22	-	5100	-	1.1	0.015	47	11
		0.47	-	6200	-	0.9	0.007	55	12
	0.22	0.22	-	8000	-	0.73	0.015	41	12
		0.47	-	11000	-	0.5	0.007	54	12
		1.0	-	13000	-	0.4	0.0035	69	12
300	0.047	0.047	-	1800	-	3.0	0.063	58	10
		0.1	-	2400	-	2.4	0.033	74	11
		0.22	-	2900	-	2.0	0.016	85	11
	0.1	0.1	-	3600	-	1.6	0.033	65	12
		0.22	-	5000	-	1.2	0.015	85	12
		0.47	-	6200	-	0.95	0.007	96	12
	0.22	0.22	-	7800	-	0.73	0.015	74	12
		0.47	-	11000	-	0.5	0.007	95	12
		1.0	-	13000	-	0.43	0.0035	106	12
90	0.047	0.047	-	1600	-	3.2	0.061	9	10 <sup>W</sup>
		0.1	-	1800	-	2.5	0.033	11	11★
		0.22	-	2000	-	2.0	0.015	14	11
	0.1	0.1	-	3000	-	1.6	0.032	10	11★
		0.22	-	3800	-	1.1	0.015	15	11
		0.47	-	4500	-	1.0	0.007	18	11
	0.22	0.22	-	6800	-	0.7	0.015	14	11
		0.47	-	9500	-	0.5	0.0065	20	11
		1.0	-	11500	-	0.43	0.0035	24	11
180	0.047	0.047	-	920	-	3.9	0.062	20	11
		0.1	-	1200	-	2.9	0.037	26	12
		0.22	-	1400	-	2.5	0.016	29	12
	0.1	0.1	-	2000	-	1.9	0.032	24	12
		0.22	-	2800	-	1.4	0.016	33	12
		0.47	-	3600	-	1.1	0.007	40	12
	0.22	0.22	-	5300	-	0.8	0.015	31	12
		0.47	-	8300	-	0.56	0.007	44	12
		1.0	-	10000	-	0.48	0.0035	54	12
300	0.047	0.047	-	870	-	4.1	0.065	38	12
		0.1	-	1200	-	3.0	0.034	52	12
		0.22	-	1500	-	2.4	0.016	68	12
	0.1	0.1	-	1900	-	1.9	0.032	44	12
		0.22	-	3000	-	1.3	0.016	68	12
		0.47	-	4000	-	1.1	0.007	80	12
	0.22	0.22	-	5300	-	0.9	0.015	57	12
		0.47	-	8800	-	0.52	0.007	82	12
		1.0	-	11000	-	0.46	0.0035	92	12

9

**6BF6**  
**6R7**  
**6R7-GT**  
**6SR7**  
**6ST7**  
**12SR7**

See Circuit  
Diagram 1

10

**6C4**  
**12AU7\***

See Circuit  
Diagram 1

■ At 3 volts (rms) output. ★ At 4 volts (rms) output. ● One triode unit.

# RCA RECEIVING TUBE MANUAL

(See page 247 for explanation of symbols)

11

**6C5  
6C5-GT**

As Triode:

**6C6  
6J7  
6J7-G  
6J7-GT  
6W7-G  
12J7-GT  
57**

See Circuit  
Diagram 1

E <sub>bb</sub>	R <sub>p</sub>	R <sub>g</sub>	R <sub>g2</sub>	R <sub>k</sub>	C <sub>g2</sub>	C <sub>k</sub>	C	E <sub>o</sub>	V.G.
90	0.05	0.05	-	2800	-	2.0	0.05	14	9
		0.1	-	3400	-	1.62	0.025	17	9
		0.25	-	3800	-	1.3	0.01	20	10
	0.1	0.1	-	4800	-	1.12	0.025	16	10
		0.25	-	6400	-	0.84	0.01	22	11
		0.5	-	7500	-	0.66	0.005	23	12
180	0.25	0.25	-	11400	-	0.52	0.01	18	12
		0.5	-	14500	-	0.4	0.006	23	12
		1.0	-	17300	-	0.33	0.004	26	13
	0.05	0.05	-	2200	-	2.2	0.055	34	10
		0.1	-	2700	-	2.1	0.03	45	11
		0.25	-	3100	-	1.85	0.015	54	11
300	0.1	0.1	-	3900	-	1.7	0.035	41	12
		0.25	-	5300	-	1.25	0.015	54	12
		0.5	-	6200	-	1.2	0.008	55	13
	0.25	0.25	-	9500	-	0.74	0.015	44	13
		0.5	-	12300	-	0.55	0.008	52	13
		1.0	-	14700	-	0.47	0.004	59	13
300	0.05	0.05	-	2100	-	3.16	0.075	57	11
		0.1	-	2600	-	2.3	0.04	70	11
		0.25	-	3100	-	2.2	0.015	83	12
	0.1	0.1	-	3800	-	1.7	0.035	65	12
		0.25	-	5300	-	1.3	0.015	84	13
		0.5	-	6000	-	1.17	0.008	88	13
	0.25	0.25	-	9600	-	0.9	0.015	73	13
		0.5	-	12300	-	0.59	0.008	85	14
		1.0	-	14000	-	0.37	0.003	97	14

12

**6C8-G\***

See Circuit  
Diagram 1

90	0.1	0.1	-	3040	-	2.34	0.028	13	18
		0.25	-	3700	-	1.48	0.0115	17	20
		0.5	-	4520	-	1.29	0.006	19	21
	0.25	0.25	-	6770	-	0.95	0.011	15	21
		0.5	-	7870	-	0.81	0.0065	19	23
		1.0	-	8830	-	0.69	0.0035	21	23
180	0.5	0.5	-	12400	-	0.51	0.006	16	22
		1.0	-	15000	-	0.43	0.0035	20	24
		2.0	-	16500	-	0.38	0.0015	25	24
	0.1	0.1	-	2420	-	2.34	0.028	30	20
		0.25	-	3080	-	1.84	0.012	40	22
		0.5	-	3560	-	1.6	0.0065	45	23
0.25	0.25	-	5170	-	1.25	0.012	35	24	
	0.5	-	6560	-	0.95	0.007	45	25	
	1.0	-	7550	-	0.85	0.0035	50	26	
300	0.5	0.5	-	9840	-	0.66	0.007	38	25
		1.0	-	12500	-	0.5	0.004	44	26
		2.0	-	15600	-	0.44	0.0015	51	26
	0.1	0.1	-	2120	-	3.93	0.037	55	22
		0.25	-	2840	-	2.01	0.013	73	23
		0.5	-	3250	-	1.79	0.007	80	25
0.25	0.25	-	4750	-	1.29	0.013	64	25	
	0.5	-	6100	-	0.96	0.0065	80	26	
	1.0	-	7100	-	0.77	0.004	90	27	
0.5	0.5	-	9000	-	0.67	0.007	67	27	
	1.0	-	11500	-	0.48	0.004	83	27	
	2.0	-	14500	-	0.37	0.002	96	28	

● One triode unit.



# RCA RECEIVING TUBE MANUAL

(See page 247 for explanation of symbols)

Ebb	R <sub>p</sub>	R <sub>g</sub>	R <sub>g2</sub>	R <sub>k</sub>	C <sub>g2</sub>	C <sub>k</sub>	C	E <sub>o</sub>	V.G.
90	0.05	0.05	-	1650	-	2.80	0.06	11	11
		0.1	-	2070	-	2.66	0.029	14	12
		0.25	-	2380	-	1.95	0.012	17	13
	0.1	0.1	-	3470	-	1.85	0.035	12	13
		0.25	-	3940	-	1.29	0.012	17	13
		0.5	-	4420	-	1.0	0.007	19	13
0.25	0.25	-	7860	-	0.73	0.0135	14	13	
	0.5	-	9760	-	0.55	0.007	18	13	
	1.0	-	10690	-	0.47	0.004	20	13	
180	0.05	0.05	-	1190	-	3.27	0.06	24	13
		0.1	-	1490	-	2.86	0.032	30	13
		0.25	-	1740	-	2.06	0.0115	36	13
	0.1	0.1	-	2330	-	2.19	0.038	26	14
		0.25	-	2830	-	1.35	0.012	34	14
		0.5	-	3230	-	1.15	0.006	38	14
	0.25	0.25	-	5560	-	0.81	0.013	28	14
		0.5	-	7000	-	0.62	0.007	36	14
		1.0	-	8110	-	0.5	0.004	40	14
300	0.05	0.05	-	1020	-	3.56	0.06	41	13
		0.1	-	1270	-	2.96	0.034	51	14
		0.25	-	1500	-	2.15	0.012	60	14
	0.1	0.1	-	1900	-	2.31	0.035	43	14
		0.25	-	2440	-	1.42	0.0125	56	14
		0.5	-	2700	-	1.2	0.0065	64	14
	0.25	0.25	-	4590	-	0.87	0.013	46	14
		0.5	-	5770	-	0.64	0.0075	57	14
		1.0	-	6950	-	0.54	0.004	64	14

13

**6F8-G\***  
**6J5**  
**6J5-GT**  
**6SN7-GT\***  
**12J5-GT**  
**12SN7-GT\***

See Circuit Diagram 1

90	0.1	0.1	0.37	1200	0.05	5.2	0.02	17	41
		0.25	0.44	1100	0.05	5.3	0.01	22	55
		0.5	0.44	1300	0.05	4.8	0.006	33	66
	0.25	0.25	1.1	2400	0.03	3.7	0.008	23	70
		0.5	1.18	2600	0.03	3.2	0.005	32	85
		1.0	1.4	3600	0.025	2.5	0.003	33	92
0.5	0.5	2.18	4700	0.02	2.3	0.005	28	93	
	1.0	2.6	5500	0.05	2.0	0.0025	29	120	
	2.0	2.7	5500	0.02	2.0	0.0015	27	140	
180	0.1	0.1	0.44	1000	0.05	6.5	0.02	42	51
		0.25	0.5	750	0.05	6.7	0.01	52	69
		0.5	0.5	800	0.05	6.7	0.006	59	83
	0.25	0.25	1.1	1200	0.04	5.2	0.008	41	93
		0.5	1.18	1600	0.04	4.3	0.005	60	118
		1.0	1.4	2000	0.04	3.8	0.0035	60	140
	0.5	0.5	2.45	2600	0.03	3.2	0.005	45	135
		1.0	2.9	3100	0.025	2.5	0.0025	56	165
		2.0	2.7	3500	0.02	2.8	0.0015	60	165
300	0.1	0.1	0.44	500	0.07	8.5	0.02	55	61
		0.25	0.5	450	0.07	8.3	0.01	81	82
		0.5	0.53	600	0.06	8.0	0.006	96	94
	0.25	0.25	1.18	1100	0.04	5.5	0.008	81	104
		0.5	1.18	1200	0.04	5.4	0.005	104	140
		1.0	1.45	1300	0.05	5.8	0.005	110	185
	0.5	0.5	2.45	1700	0.04	4.2	0.005	75	161
		1.0	2.9	2200	0.04	4.1	0.003	97	200
		2.0	2.95	2300	0.04	4.0	0.0025	100	230

14

**6C6**  
**6J7**  
**6J7-G**  
**6J7-GT**  
**6W7-G**  
**12J7-GT**  
**57**

See Circuit Diagram 3

• One triode unit.

# RCA RECEIVING TUBE MANUAL

(See page 247 for explanation of symbols)

15

**6L5-G**

See Circuit Diagram 1

E <sub>bb</sub>	R <sub>p</sub>	R <sub>g</sub>	R <sub>g2</sub>	R <sub>k</sub>	C <sub>g2</sub>	C <sub>k</sub>	C	E <sub>o</sub>	V.G.*
90	0.05	0.05	—	2120	—	2.3	0.05	14	9.3
		0.1	—	2500	—	1.86	0.03	18	10
		0.25	—	2900	—	1.65	0.014	21	11
	0.1	0.1	—	3510	—	1.36	0.03	16	11
		0.25	—	4620	—	1.08	0.015	22	12
		0.5	—	5200	—	1.0	0.0085	23	12
	0.25	0.25	—	8050	—	0.61	0.0125	18	12
		0.5	—	10300	—	0.49	0.0085	22	12
		1.0	—	12100	—	0.42	0.0055	24	12
180	0.05	0.05	—	1810	—	2.9	0.06	32	10
		0.1	—	2240	—	2.2	0.03	41	11
		0.25	—	2660	—	1.8	0.014	46	12
	0.1	0.1	—	3180	—	1.46	0.03	36	12
		0.25	—	4200	—	1.1	0.0145	46	12
		0.5	—	4790	—	1.0	0.009	50	12
	0.25	0.25	—	7100	—	0.7	0.014	38	12
		0.5	—	9290	—	0.54	0.009	46	12
		1.0	—	10950	—	0.46	0.0055	52	13
300	0.05	0.05	—	1740	—	2.91	0.06	56	11
		0.1	—	2160	—	2.18	0.032	68	12
		0.25	—	2600	—	1.82	0.015	79	12
	0.1	0.1	—	3070	—	1.64	0.032	60	12
		0.25	—	4140	—	1.1	0.014	79	13
		0.5	—	4700	—	0.81	0.0075	89	13
	0.25	0.25	—	6900	—	0.57	0.013	64	13
		0.5	—	9100	—	0.46	0.0075	80	13
		1.0	—	10750	—	0.4	0.005	88	13

16

**6S7  
6S7-G**

See Circuit Diagram 3

90	0.1	0.1	0.59	870	0.065	5.1	0.018	16	33
		0.25	0.65	900	0.061	5.0	0.01	21	47
		0.5	0.7	910	0.057	4.58	0.007	23	54
	0.25	0.25	1.5	1440	0.044	3.38	0.007	14	56
		0.5	1.6	1520	0.044	3.23	0.0055	18	66
		1.0	1.7	1560	0.043	3.22	0.004	19	77
	0.5	0.5	3.2	2620	0.029	2.04	0.004	12	70
		1.0	3.5	2800	0.03	1.95	0.0026	15	84
		2.0	3.7	3000	0.031	1.92	0.0024	16	94
180	0.1	0.1	0.58	530	0.073	7.2	0.017	33	47
		0.25	0.68	540	0.07	6.9	0.01	43	66
		0.5	0.71	540	0.065	6.6	0.0063	48	75
	0.25	0.25	1.6	850	0.05	4.6	0.0071	33	79
		0.5	1.8	890	0.044	4.7	0.005	40	104
		1.0	1.9	950	0.046	4.4	0.0037	44	118
	0.5	0.5	3.3	1410	0.041	3.5	0.0041	30	109
		1.0	3.6	1520	0.037	3.0	0.003	38	134
		2.0	3.8	1600	0.031	2.9	0.0024	42	147
300	0.1	0.1	0.59	430	0.007	8.5	0.0167	57	57
		0.25	0.67	440	0.071	8.0	0.01	75	78
		0.5	0.71	440	0.071	8.0	0.0066	82	89
	0.25	0.25	1.7	620	0.058	6.0	0.0071	54	98
		0.5	1.95	650	0.057	5.8	0.005	66	122
		1.0	2.1	700	0.055	5.2	0.0036	76	136
	0.5	0.5	3.6	1000	0.04	4.1	0.0037	52	136
		1.0	3.9	1080	0.041	3.9	0.0029	66	162
		2.0	4.1	1120	0.043	3.8	0.0023	73	174

★ At 4 volts (rms) output.

# RCA RECEIVING TUBE MANUAL

(See page 247 for explanation of symbols)

E <sub>bb</sub>	R <sub>p</sub>	R <sub>g</sub>	R <sub>g2</sub>	R <sub>k</sub>	C <sub>g2</sub>	C <sub>k</sub>	C	E <sub>o</sub>	V.G.
90	0.1	0.1	-	1850*	-	-	0.028	4.1	13●
		0.25	-	1960*	-	-	0.012	5.9	23■
		0.5	-	2050*	-	-	0.0065	6.9	25★
	0.25	0.25	-	3400*	-	-	0.011	6.2	26★
		0.5	-	3750*	-	-	0.006	8.6	30
		1.0	-	3900*	-	-	0.003	10	33
0.5	0.5	-	5500*	-	-	0.005	7.4	31	
	1.0	-	6300*	-	-	0.003	10	33	
	2.0	-	7450*	-	-	0.0015	12	36	
180	0.1	0.1	-	960*	-	-	0.031	17	25
		0.25	-	1070*	-	-	0.012	24	29
		0.5	-	1220*	-	-	0.0065	27	33
	0.25	0.25	-	1850*	-	-	0.011	21	35
		0.5	-	2150*	-	-	0.006	28	39
		1.0	-	2400*	-	-	0.003	32	41
0.5	0.5	-	3050*	-	-	0.006	24	40	
	1.0	-	3420*	-	-	0.003	32	43	
	2.0	-	3890*	-	-	0.002	36	45	
300	0.1	0.1	-	750*	-	-	0.033	35	29
		0.25	-	930*	-	-	0.014	50	34
		0.5	-	1040*	-	-	0.007	54	36
	0.25	0.25	-	1400*	-	-	0.012	45	39
		0.5	-	1680*	-	-	0.006	55	42
		1.0	-	1840*	-	-	0.003	64	45
0.5	0.5	-	2330*	-	-	0.006	50	45	
	1.0	-	2980*	-	-	0.003	62	48	
	2.0	-	3280*	-	-	0.002	72	49	
90	0.1	0.1	-	4400	-	2.5	0.02	4	28●
		0.25	-	4800	-	2.1	0.01	5	34■
		0.5	-	5000	-	1.8	0.005	6	35★
	0.25	0.25	-	8000	-	1.33	0.01	6	39■
		0.5	-	8800	-	1.18	0.005	7	43★
		1.0	-	9000	-	0.9	0.003	10	44★
0.5	0.5	-	12200	-	0.76	0.005	8	43	
	1.0	-	13500	-	0.67	0.003	10	46	
	2.0	-	14700	-	0.58	0.0015	12	48	
180	0.1	0.1	-	1800	-	4.4	0.025	16	37
		0.25	-	2000	-	3.3	0.015	23	44
		0.5	-	2200	-	2.9	0.006	25	46
	0.25	0.25	-	3500	-	2.3	0.01	21	48
		0.5	-	4100	-	1.8	0.006	26	53
		1.0	-	4500	-	1.7	0.004	32	57
0.5	0.5	-	6100	-	1.3	0.006	24	53	
	1.0	-	6900	-	0.9	0.003	33	63	
	2.0	-	7700	-	0.83	0.0015	37	66	
300	0.1	0.1	-	1300	-	5.0	0.025	33	42
		0.25	-	1600	-	3.7	0.01	43	49
		0.5	-	1700	-	3.2	0.006	48	52
	0.25	0.25	-	2600	-	2.5	0.01	41	56
		0.5	-	3200	-	2.1	0.007	54	63
		1.0	-	3500	-	2.0	0.004	63	67
0.5	0.5	-	4500	-	1.5	0.006	50	65	
	1.0	-	5400	-	1.2	0.004	62	70	
	2.0	-	6100	-	0.93	0.002	70	70	

17

**6SC7#**  
**12SC7#**

See Circuit  
Diagram 4

18

**6F5**  
**6F5-GT**  
**6SF5**  
**6SF5-GT**  
**12F5-GT**  
**12SF5**

See Circuit  
Diagram 1

● - At 2 volts (rms) output. ■ At 3 volts (rms) output. ★ At 4 volts (rms) output.

# The cathodes of the two units have a common terminal.

\* Values are for phase-inverter service.

# RCA RECEIVING TUBE MANUAL

(See page 247 for explanation of symbols)

19

**6SF7  
12SF7**

See Circuit  
Diagram 3

E <sub>bb</sub>	R <sub>p</sub>	R <sub>g</sub>	R <sub>g2</sub>	R <sub>k</sub>	C <sub>g2</sub>	C <sub>k</sub>	C	E <sub>o</sub>	V.G.
90	0.1	0.1	0.26	1500	0.11	4.8	0.02	21	21
		0.22	0.3	1600	0.1	4.4	0.012	26	29
		0.47	0.35	1900	0.09	4.2	0.006	28	37
	0.22	0.22	0.64	2400	0.09	3.4	0.009	21	33
		0.47	0.7	2500	0.09	3.2	0.0055	26	40
		1.0	0.84	2600	0.084	3.0	0.0035	29	52
0.47	0.47	1.5	4200	0.06	2.1	0.0045	21	50	
	1.0	1.6	4400	0.06	1.9	0.003	26	59	
	2.2	1.7	4800	0.058	1.6	0.002	29	64	
180	0.1	0.1	0.33	1000	0.13	6.7	0.02	32	33
		0.22	0.5	1200	0.12	5.8	0.011	37	45
		0.47	0.6	1300	0.11	5.5	0.006	43	52
	0.22	0.22	0.76	1700	0.11	4.5	0.0095	37	47
		0.47	0.9	1700	0.1	4.5	0.0055	44	68
		1.0	1.0	1800	0.1	4.2	0.003	47	82
0.47	0.47	1.8	3300	0.09	2.9	0.0045	38	70	
	1.0	2.0	3800	0.08	2.4	0.003	50	85	
	2.2	2.1	4000	0.07	2.3	0.002	57	98	
300	0.1	0.1	0.32	750	0.19	8.0	0.021	62	39
		0.22	0.36	850	0.18	7.7	0.012	80	46
		0.47	0.37	900	0.18	7.7	0.006	93	57
	0.22	0.22	0.8	1150	0.13	6	0.01	63	62
		0.47	0.94	1300	0.12	5.7	0.0055	78	88
		1.0	0.98	1500	0.11	5.0	0.0035	99	97
0.47	0.47	1.7	2300	0.1	3.5	0.0045	71	82	
	1.0	1.9	2500	0.1	3.5	0.003	89	109	
	2.2	2.0	2800	0.09	3.1	0.002	105	125	

20

**6SJ7  
6SJ7-GT  
12SJ7  
12SJ7-GT**

See Circuit  
Diagram 3

90	0.1	0.1	0.29	820	0.09	8.8	0.02	18	41
		0.25	0.29	880	0.085	7.4	0.016	23	68
		0.5	0.31	1000	0.075	6.6	0.007	28	70
	0.25	0.25	0.69	1680	0.06	5.0	0.012	16	75
		0.5	0.92	1700	0.045	4.5	0.005	18	93
		1.0	0.82	1800	0.04	4.0	0.003	22	104
0.5	0.5	1.5	3600	0.045	2.4	0.003	18	91	
	1.0	1.7	3800	0.03	2.4	0.002	22	119	
	2.0	1.9	4050	0.028	2.35	0.0015	24	139	
180	0.1	0.1	0.29	760	0.10	9.1	0.019	49	55
		0.25	0.31	800	0.09	8.0	0.015	60	82
		0.5	0.37	860	0.09	7.8	0.007	62	91
	0.25	0.25	0.83	1050	0.06	6.8	0.001	38	109
		0.5	0.94	1060	0.06	6.6	0.004	47	131
		1.0	0.94	1100	0.07	6.1	0.003	54	161
0.5	0.5	1.85	2000	0.05	4.0	0.003	37	151	
	1.0	2.2	2180	0.04	3.8	0.002	44	192	
	2.0	2.4	2410	0.035	3.6	0.0015	54	208	
300	0.1	0.1	0.35	500	0.10	11.6	0.019	72	67
		0.25	0.37	530	0.09	10.9	0.016	96	98
		0.5	0.47	590	0.09	9.9	0.007	101	104
	0.25	0.25	0.89	850	0.07	8.5	0.011	79	139
		0.5	1.10	860	0.06	7.4	0.004	88	167
		1.0	1.18	910	0.06	6.9	0.003	98	185
0.5	0.5	2.0	1300	0.06	6.0	0.004	64	200	
	1.0	2.2	1410	0.05	5.8	0.002	79	238	
	2.0	2.5	1530	0.04	5.2	0.0015	89	263	

# RCA RECEIVING TUBE MANUAL

(See page 247 for explanation of symbols)

Ebb	R <sub>p</sub>	R <sub>g</sub>	R <sub>g2</sub>	R <sub>k</sub>	C <sub>g2</sub>	C <sub>k</sub>	C	E <sub>o</sub>	V.G.
90	0.1	0.1	-	1480*	-	2.65	0.025	8	21*
		0.25	-	1760*	-	2.02	0.0115	11	25
		0.5	-	1930*	-	1.7	0.0065	14	26
	0.25	0.25	-	3000*	-	1.36	0.01	12	28
		0.5	-	3390*	-	1.1	0.006	15	30
		1.0	-	3670*	-	0.8	0.0035	18	33
	0.5	0.5	-	5300*	-	0.65	0.0055	14	31
		1.0	-	6050*	-	0.61	0.003	18	33
		2.0	-	6700*	-	0.45	0.0015	20	35
180	0.1	0.1	-	930*	-	3.4	0.028	18	26
		0.25	-	1100*	-	2.6	0.0115	28	31
		0.5	-	1210*	-	2.32	0.007	33	32
	0.25	0.25	-	1820*	-	1.71	0.012	28	35
		0.5	-	2110*	-	1.38	0.007	34	38
		1.0	-	2400*	-	1.1	0.0035	41	39
	0.5	0.5	-	3240*	-	0.9	0.006	32	39
		1.0	-	3890*	-	0.703	0.0035	38	40
		2.0	-	4360*	-	0.553	0.002	44	41
300	0.1	0.1	-	670*	-	3.81	0.028	38	31
		0.25	-	950*	-	2.63	0.012	52	34
		0.5	-	1050*	-	2.34	0.007	60	36
	0.25	0.25	-	1430*	-	1.87	0.012	50	38
		0.5	-	1680*	-	1.46	0.006	59	40
		1.0	-	1930*	-	1.19	0.0035	66	43
	0.5	0.5	-	2540*	-	0.97	0.006	55	42
		1.0	-	3110*	-	0.72	0.0035	70	44
		2.0	-	3560*	-	0.56	0.002	75	45
90	0.05	0.05	-	3800	-	1.4	0.06	16	4.5
		0.1	-	4600	-	1.1	0.03	19	4.9
		0.25	-	5400	-	0.86	0.015	23	5.1
	0.1	0.1	-	6620	-	0.7	0.04	17	5.1
		0.25	-	9000	-	0.55	0.015	22	5.4
		0.5	-	10300	-	0.5	0.007	25	5.5
	0.25	0.25	-	15100	-	0.31	0.015	18	5.3
		0.5	-	20500	-	0.25	0.007	23	5.5
		1.0	-	24400	-	0.2	0.004	26	5.6
180	0.05	0.05	-	3200	-	1.8	0.06	33	4.9
		0.1	-	4100	-	1.6	0.045	44	5.2
		0.25	-	5000	-	1.2	0.02	49	5.3
	0.1	0.1	-	6200	-	0.9	0.04	37	5.3
		0.25	-	8700	-	0.7	0.015	47	5.5
		0.5	-	10000	-	0.57	0.008	50	5.5
	0.25	0.25	-	14500	-	0.43	0.015	40	5.6
		0.5	-	20000	-	0.29	0.008	48	5.7
		1.0	-	24000	-	0.24	0.004	53	5.7
300	0.05	0.05	-	3200	-	1.9	0.08	50	5.2
		0.1	-	4100	-	1.5	0.045	74	5.5
		0.25	-	5100	-	1.2	0.015	85	5.6
	0.1	0.1	-	5900	-	0.8	0.03	64	5.5
		0.25	-	8300	-	0.54	0.015	82	5.7
		0.5	-	9600	-	0.43	0.006	88	5.8
	0.25	0.25	-	14300	-	0.3	0.01	71	5.7
		0.5	-	19400	-	0.22	0.006	84	5.7
		1.0	-	23600	-	0.2	0.003	94	5.8

21

6Z7-G#

See Circuit Diagram 4

22

55  
85

See Circuit Diagram 1

★ At 4 volts (rms) output. \*Values are for phase-inverter service.

# The cathodes of the two units have a common terminal.

# RCA RECEIVING TUBE MANUAL

(See page 247 for explanation of symbols)

23

56  
76

See Circuit  
Diagram 1

Ebb	R <sub>p</sub>	R <sub>g</sub>	R <sub>g2</sub>	R <sub>k</sub>	C <sub>g2</sub>	C <sub>k</sub>	C	E <sub>o</sub>	V.G.
90	0.05	0.05	-	2500	-	2.0	0.06	16	7.0
		0.1	-	3200	-	1.6	0.03	21	7.7
		0.25	-	3800	-	1.25	0.015	23	8.1
	0.1	0.1	-	4500	-	1.05	0.03	19	8.1
		0.25	-	6500	-	0.82	0.015	23	8.9
		0.5	-	7500	-	0.68	0.007	25	9.3
0.25	0.25	-	11100	-	0.48	0.015	21	9.4	
	0.5	-	15100	-	0.36	0.007	24	9.7	
	1.0	-	18300	-	0.32	0.0035	28	9.8	
180	0.05	0.05	-	2400	-	2.5	0.06	36	7.7
		0.1	-	3000	-	1.9	0.035	48	8.2
		0.25	-	3700	-	1.65	0.015	55	9.0
	0.1	0.1	-	4500	-	1.45	0.035	45	9.3
		0.25	-	6500	-	0.97	0.015	55	9.5
		0.5	-	7600	-	0.8	0.008	57	9.8
	0.25	0.25	-	10700	-	0.6	0.015	49	9.7
		0.5	-	14700	-	0.45	0.007	59	10
		1.0	-	17700	-	0.4	0.0045	64	10
300	0.05	0.05	-	2400	-	2.8	0.08	65	8.3
		0.1	-	3100	-	2.2	0.045	80	8.9
		0.25	-	3800	-	1.8	0.02	95	9.4
	0.1	0.1	-	4500	-	1.6	0.04	74	9.5
		0.25	-	6400	-	1.2	0.02	95	10
		0.5	-	7500	-	0.98	0.009	104	10
	0.25	0.25	-	11100	-	0.69	0.02	82	10
		0.5	-	15200	-	0.5	0.009	96	10
		1.0	-	18300	-	0.4	0.005	108	10

24

79#

See Circuit  
Diagram 4

90	0.1	0.1	-	2050*	-	-	0.04	5.8	23 <sup>■</sup>
		0.25	-	2200*	-	-	0.015	8.4	29 <sup>★</sup>
		0.5	-	2350*	-	-	0.009	9.5	29 <sup>★</sup>
	0.25	0.25	-	4000*	-	-	0.015	7.1	31 <sup>★</sup>
		0.5	-	4250*	-	-	0.006	9.7	33
		1.0	-	4650*	-	-	0.004	12	35
180	0.5	0.5	-	6150*	-	-	0.006	8.8	34
		1.0	-	6850*	-	-	0.004	12	38
		2.0	-	7500*	-	-	0.002	15	40
	0.1	0.1	-	1050*	-	-	0.04	21	27
		0.25	-	1250*	-	-	0.02	27	31
		0.5	-	1350*	-	-	0.009	31	34
0.25	0.25	-	2050*	-	-	0.02	26	37	
	0.5	-	2450*	-	-	0.01	34	41	
	1.0	-	2750*	-	-	0.005	40	42	
0.5	0.5	-	3450*	-	-	0.009	30	42	
	1.0	-	4100*	-	-	0.0035	39	44	
	2.0	-	4650*	-	-	0.002	44	45	
300	0.1	0.1	-	800*	-	-	0.025	40	29
		0.25	-	1080*	-	-	0.01	57	34
		0.5	-	1100*	-	-	0.006	60	36
	0.25	0.25	-	1650*	-	-	0.01	56	39
		0.5	-	2050*	-	-	0.0055	66	42
		1.0	-	2350*	-	-	0.003	77	43
	0.5	0.5	-	2850*	-	-	0.0055	61	44
		1.0	-	3600*	-	-	0.003	75	46
		2.0	-	4450*	-	-	0.0015	82	46

■ At 3 volts (rms) output.    ★ At 4 volts (rms) output.

\*Values are for phase-inverter service.

#The cathodes of the two units have a common terminal.

# RCA RECEIVING TUBE MANUAL

(See page 247 for explanation of symbols)

Ebb	R <sub>p</sub>	R <sub>g</sub>	R <sub>g2</sub>	R <sub>k</sub>	C <sub>g2</sub>	C <sub>k</sub>	C	E <sub>o</sub>	V.G.
90	0.1	0.1	-	4400	-	2.7	0.023	5	29●
		0.22	-	4700	-	2.4	0.013	6	35●
		0.47	-	4800	-	2.3	0.007	8	41●
	0.22	0.22	-	7000	-	1.6	0.001	6	39●
		0.47	-	7400	-	1.4	0.006	9	45■
		1.0	-	7600	-	1.3	0.003	11	48★
	0.47	0.47	-	12000	-	0.9	0.006	9	48■
		1.0	-	13000	-	0.8	0.003	11	52★
		2.2	-	14000	-	0.7	0.002	13	55★
180	0.1	0.1	-	1800	-	4.0	0.025	18	40
		0.22	-	2000	-	3.5	0.013	25	47
		0.47	-	2200	-	3.1	0.006	32	52
	0.22	0.22	-	3000	-	2.4	0.012	24	53
		0.47	-	3500	-	2.1	0.006	34	59
		1.0	-	3900	-	1.8	0.003	39	63
	0.47	0.47	-	5800	-	1.3	0.006	30	62
		1.0	-	6700	-	1.1	0.003	39	66
		2.2	-	7400	-	1.0	0.002	45	68
300	0.1	0.1	-	1300	-	4.6	0.027	43	45
		0.22	-	1500	-	4.0	0.013	57	52
		0.47	-	1700	-	3.6	0.006	66	57
	0.22	0.22	-	2200	-	3.0	0.013	54	59
		0.47	-	2800	-	2.3	0.006	69	65
		1.0	-	3100	-	2.1	0.003	79	68
	0.47	0.47	-	4300	-	1.6	0.006	62	69
		1.0	-	5200	-	1.3	0.003	77	73
		2.2	-	5900	-	1.1	0.002	92	75

25

6AV6  
 12AV6  
 12AX7●

See Circuit  
Diagram 1

●— At 2 volts (rms) output. ■ At 3 volts (rms) output. ★ At 4 volts (rms) output.  
 ● One triode unit.

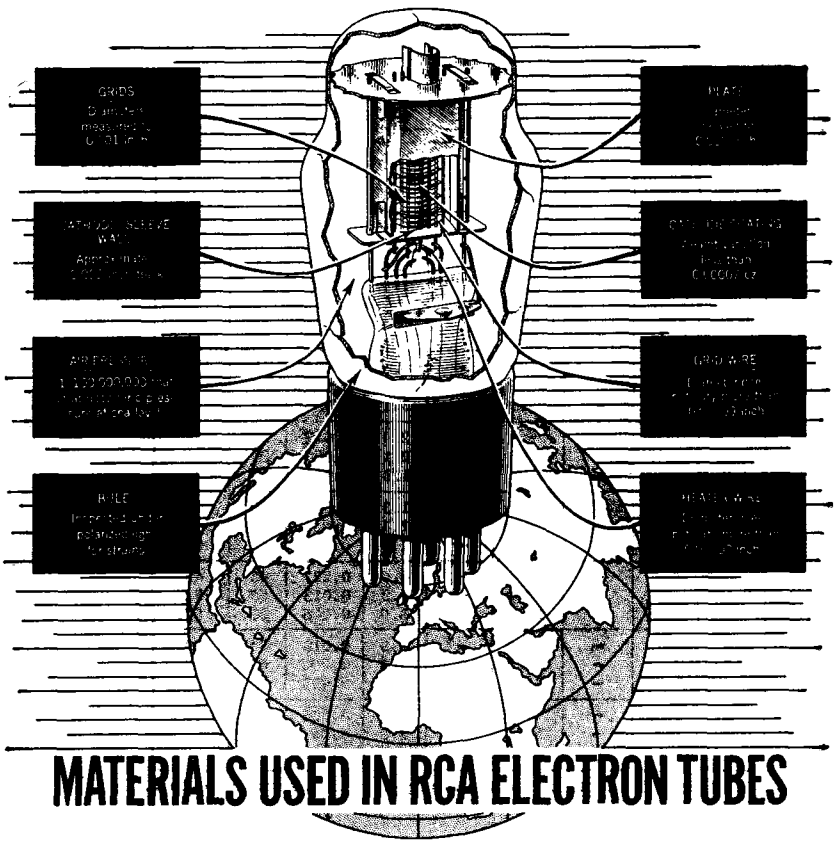

# MATERIALS USED IN RCA ELECTRON TUBES

ACETIC ACID — ACETONE — ACETYLENE GAS — ALUMINA — ALUMINUM — ALUMINUM NITRATE — AMMONIUM CHLORIDE — AMMONIUM HYDROXIDE — AMYL ACETATE — ANTIMONY — ANTIMONY TRICHLORIDE — ARGON — BAKELITE — BARIUM — BARIUM CARBONATE — BARIUM NITRATE — BARIUM STRONTIUM TITANATE — BARIUM SULPHATE — BENTONITE — BENZENE — BERYLLIUM — BERYLLIUM OXIDE — BISMUTH — BORIC ACID — BORON — BUTYL ACETATE — BUTYL ALCOHOL — BUTYL CARBITOL — BUTYL CARBITOL ACETATE — CADMIUM — CESIUM — CESIUM CHROMATE — CALCIUM — CALCIUM CARBONATE — CALCIUM NITRATE — CALCIUM OXIDE — CAMPHOR — CARBON — CARBON BLACK — CARBON DIOXIDE — CARBON TETRACHLORIDE — CASTOR OIL — CHLORINE CHROMIC ACID — CHROMIUM — CLAY — COBALT — COPPER — DIACETONE ALCOHOL — DIATOL — DIETHYL OXALATE — DISTILLED WATER — ETHER — ETHYL ALCOHOL — FERRIC OXIDE — FERRO TITANIUM — GLASS — GLYCERINE — GOLD — GRAPHITE — HELIUM GAS — HYDROCHLORIC ACID — HYDROFLUORIC ACID — HYDROGEN GAS — HYDROGEN PEROXIDE — ILLUMINATING GAS — IRIIDIUM — IRON — ISOLANTITE — ISOPROPANOL — LAVA LEAD — LEAD BORATE — LEAD OXIDE — MAGNESIA — MAGNESIUM — MAGNESIUM NITRATE — MALACHITE GREEN — MANGANESE — MARBLE DUST — MERCURY — METHANOL — MICA — MISCH METAL — MOLYBDENUM — MONEL — NATURAL GAS — NEON — NICKEL — NICKEL CHLORIDE — NICKEL OXIDE — NICKEL SULPHATE — NITRIC ACID — NITROCELLULOSE — NITROGEN — OXALIC ACID — OXYGEN — PALLADIUM — PALMITIC ACID — PETROLEUM JELLY — PHOSPHORIC ACID — PHOSPHORUS — PLATINUM — POTASSIUM — POTASSIUM CARBONATE — POTASSIUM FELDSPAR — POTASSIUM NITRATE — PORCELAIN — RADIUM — RARE EARTHS — RESIN (synthetic) — ROSIN — RUBIDIUM — RUBIDIUM DICHROMATE — SHEL-LAC — SILICA — SILICON — SILVER — SILVER OXIDE — SODIUM — SODIUM CARBONATE — STANNIC OXIDE — STEEL — STRONTIUM — STRONTIUM CARBONATE — STRONTIUM NITRATE — SULPHUR — SULPHURIC ACID — TALC — TANTALUM — THALLIUM — THORIUM — THORIUM NITRATE — TIN — TITANIUM — TITANIUM DIOXIDE — TRICHLOROETHYLENE — TUNGSTEN — WAX — WHEAT FLOUR — WOOD FIBER — XENON — ZINC — ZIRCONIUM HYDRIDE



# Circuits

The circuit diagrams in this Manual have been conservatively designed to illustrate some of the more important applications of receiving tubes and are not necessarily representative of commercial practice.

The circuits for receivers and amplifiers are capable of good response, but the fidelity obtained depends as much on the quality of the components used as on the circuits themselves. The quality of loud-speakers, transformers, chokes, and input sources is especially important.

Electrical specifications have been given for the circuit components to assist those interested in home construction. Details for mechanical layout have been omitted because they vary widely with the requirements of the individual set builder and are dependent upon the size, shape, and quality of the commercial components selected. For the various rf, if, and oscillator coils, commercial units are recommended. These can be purchased through your local dealer by specifying the tuning range, size of tuning capacitors, intermediate frequency, type of converter tube, and type of oscillator coil. The voltage ratings of the capacitors specified in these circuits are the dc working voltages. The wattage ratings of the resistors specified assume provisions for adequate ventilation; for compact installations having poor ventilation, higher-wattage resistors may be required.

Information on the characteristics and the application features of each tube will be found in the TUBE TYPES SECTION. This information will prove of assistance in understanding and utilizing the circuits.

The following circuits will be found in the subsequent pages:

	<i>Circuit No.</i>
Portable Superheterodyne Receiver . . . . .	16-1
Portable 3-Way Superheterodyne Receiver . . . . .	16-2
AC-Operated Superheterodyne Receiver . . . . .	16-3
AC/DC Superheterodyne Receiver . . . . .	16-4
Automobile Receiver . . . . .	16-5
Superregenerative Receiver . . . . .	16-6
AC-Operated Regenerative Short-Wave Receiver . . . . .	16-7
Battery-Operated Short-Wave Receiver . . . . .	16-8
FM Tuner . . . . .	16-9
Class A <sub>1</sub> Audio Amplifier (4 watts) . . . . .	16-10
Microphone and Phonograph Amplifier (6 watts) . . . . .	16-11
High-Fidelity Audio Amplifier with Independent Bass and Treble Controls and High and Low Input Levels (10 watts) . . . . .	16-12
High-Power Audio Amplifier, Class AB <sub>1</sub> (25 watts) . . . . .	16-13
High-Power Audio Amplifier, Class AB <sub>2</sub> (45 watts) . . . . .	16-14
Class B Amplifier for Mobile Use (10 watts) . . . . .	16-15
Two-Channel Audio Mixer . . . . .	16-16
Non-Motorboating Resistance-Coupled Amplifier . . . . .	16-17
Code Practice Oscillator . . . . .	16-18
Intercommunication Set . . . . .	16-19
Electronic Volt-Ohm Meter . . . . .	16-20
AF Voltage Amplifier with Signal Mixer, Master Mixer, and Compressor-Expander . . . . .	16-21

(16-1)

PORTABLE SUPERHETERODYNE RECEIVER

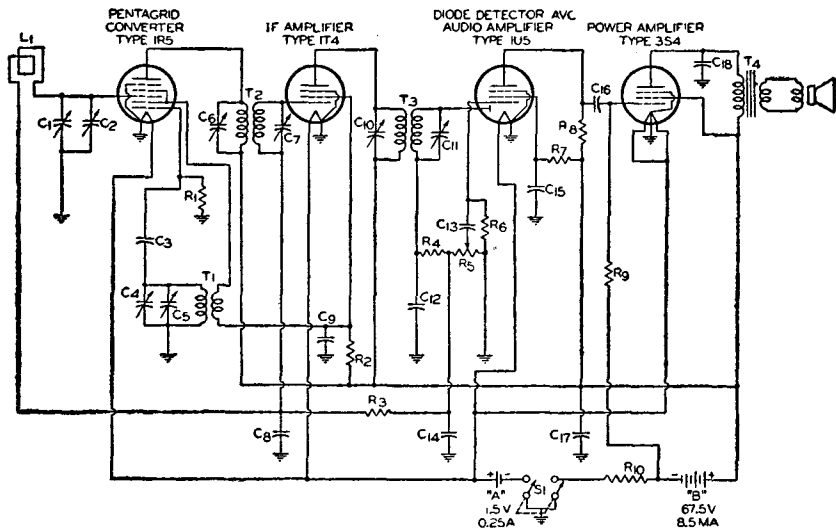

C<sub>1</sub> C<sub>4</sub> = Ganged tuning capacitors: C<sub>1</sub>, 10-274 μf; C<sub>4</sub>, 7.5-122.5 μf

C<sub>2</sub> C<sub>5</sub> = Trimmer capacitors, 2-15 μf

C<sub>3</sub> = 56 μf, ceramic

C<sub>6</sub> C<sub>7</sub> C<sub>10</sub> C<sub>11</sub> = Trimmer capacitors

C<sub>8</sub> = 0.05 μf, tubular, 400 v.

C<sub>9</sub> C<sub>15</sub> = 0.02 μf, tubular, 100 v.

C<sub>12</sub> = 82 μf, ceramic

C<sub>13</sub> C<sub>16</sub> = 0.002 μf, tubular, 150 v.

C<sub>14</sub> = 33 μf, ceramic

C<sub>17</sub> = 10 μf, electrolytic, 50 v.

C<sub>18</sub> = 0.005 μf, tubular, 600 v.

L<sub>1</sub> = Loop antenna, 540-1600 Kc

R<sub>1</sub> = 0.1 megohm, 0.25 watt

R<sub>2</sub> = 15000 ohms, 0.25 watt

R<sub>3</sub> R<sub>9</sub> = 3.3 megohms, 0.25 watt

R<sub>4</sub> = 68000 ohms, 0.25 watt

R<sub>5</sub> = Volume control, potentiometer, 2 megohms

R<sub>6</sub> = 10 megohms, 0.25 watt

R<sub>7</sub> = 4.7 megohms, 0.25 watt

R<sub>8</sub> = 1 megohm, 0.25 watt

R<sub>10</sub> = 820 ohms, 0.25 watt

S<sub>1</sub> = Switch, double-pole, single throw

T<sub>1</sub> = Oscillator coil; for use with tuning capacitor of 7.5-122.5 μf, and 455 Kc if transformer

T<sub>2</sub> T<sub>3</sub> = Intermediate-frequency transformers, 455 Kc

T<sub>4</sub> = Output transformer for matching impedance of voice coil to 5000-ohm tube load

(16-2)

## PORTABLE 3-WAY SUPERHETERODYNE RECEIVER

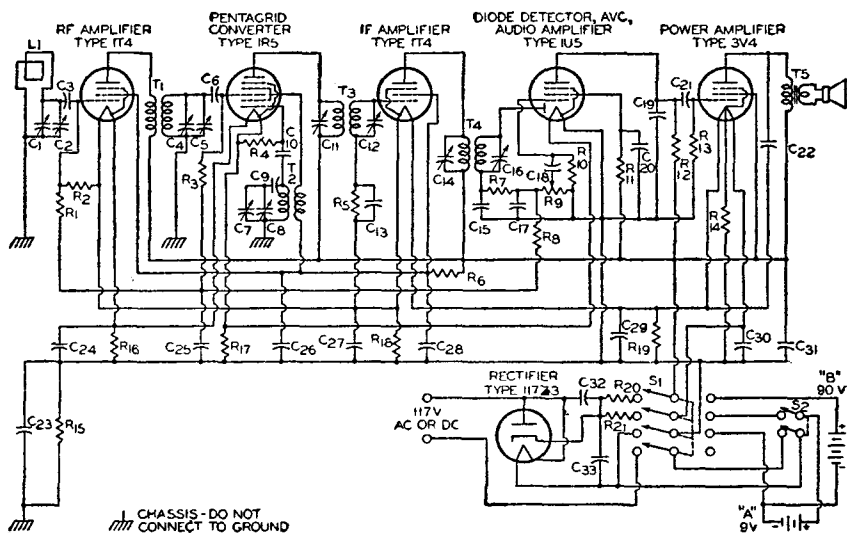

**C<sub>1</sub> C<sub>4</sub> C<sub>8</sub>** = Ganged tuning capacitors, 20-450  $\mu\text{f}$   
**C<sub>2</sub> C<sub>6</sub> C<sub>7</sub> C<sub>11</sub> C<sub>12</sub> C<sub>14</sub> C<sub>16</sub>** = Trimmer capacitors  
**C<sub>3</sub> C<sub>10</sub> C<sub>15</sub> C<sub>17</sub>** = 100  $\mu\text{f}$ , ceramic  
**C<sub>5</sub>** = 82  $\mu\text{f}$ , ceramic  
**C<sub>9</sub>** = 560  $\mu\text{f}$ , ceramic  
**C<sub>13</sub>** = 0.01  $\mu\text{f}$ , tubular, 400 v.  
**C<sub>18</sub> C<sub>21</sub>** = 0.002  $\mu\text{f}$ , tubular, 400 v.  
**C<sub>19</sub>** = 270  $\mu\text{f}$ , ceramic  
**C<sub>20</sub>** = 0.02  $\mu\text{f}$ , tubular, 400 v.  
**C<sub>22</sub> C<sub>22'</sub>** = 0.005  $\mu\text{f}$ , tubular, 400 v.  
**C<sub>23</sub>** = 0.1  $\mu\text{f}$ , 400 v.  
**C<sub>24</sub>** = 0.05  $\mu\text{f}$ , 200 v.  
**C<sub>25</sub> C<sub>26</sub> C<sub>27</sub> C<sub>28</sub>** = 0.05  $\mu\text{f}$ , 400 v.  
**C<sub>29</sub>** = 40  $\mu\text{f}$ , 25 v.

**C<sub>30</sub>** = 160  $\mu\text{f}$ , 25 v.  
**C<sub>31</sub> C<sub>33</sub>** = 20  $\mu\text{f}$ , 150 v.  
**L<sub>1</sub>** = Loop antenna, 540-1600 Kc  
**R<sub>1</sub> R<sub>2</sub> R<sub>11</sub>** = 4.7 megohms, 0.25 watt  
**R<sub>3</sub>** = 2.2 megohms, 0.25 watt  
**R<sub>4</sub>** = 0.10 megohm, 0.25 watt  
**R<sub>5</sub>** = 5.6 megohms, 0.25 watt  
**R<sub>6</sub>** = 0.027 megohm, 0.25 watt  
**R<sub>7</sub>** = 0.068 megohm, 0.25 watt  
**R<sub>8</sub>** = 3.3 megohms, 0.25 watt  
**R<sub>9</sub>** = Volume control, potentiometer, 1 megohm  
**R<sub>10</sub>** = 10 megohms, 0.25 watt  
**R<sub>12</sub>** = 0.220 megohm, 0.25 watt  
**R<sub>13</sub>** = 1 megohm, 0.25 watt  
**R<sub>14</sub> R<sub>15</sub>** = 1800 ohms, 0.25 watt  
**R<sub>16</sub>** = 0.220 megohm, 0.5 watt  
**R<sub>17</sub>** = 1000 ohms, 0.25 watt

**R<sub>18</sub>** = 2700 ohms, 0.25 watt  
**R<sub>19</sub>** = 1500 ohms, 0.25 watt  
**R<sub>20</sub>** = 1800 ohms, 10 watts  
**R<sub>21</sub>** = 2300 ohms, 10 watts  
**S<sub>1</sub>** = Switch, 4-pole double-throw  
**S<sub>2</sub>** = Switch, double-pole, single-throw  
**T<sub>1</sub>** = RF transformer, 540-1600 Kc  
**T<sub>2</sub>** = Oscillator coil for use with a 560- $\mu\text{f}$  padder, 20-450  $\mu\text{f}$  tuning capacitor, and 455 Kc if transformer  
**T<sub>3</sub> T<sub>4</sub>** = Intermediate-frequency transformers, 455 Kc  
**T<sub>5</sub>** = Output transformer for matching impedance of voice coil to 10000-ohm tube load

(16-3)

AC-OPERATED SUPERHETERODYNE RECEIVER

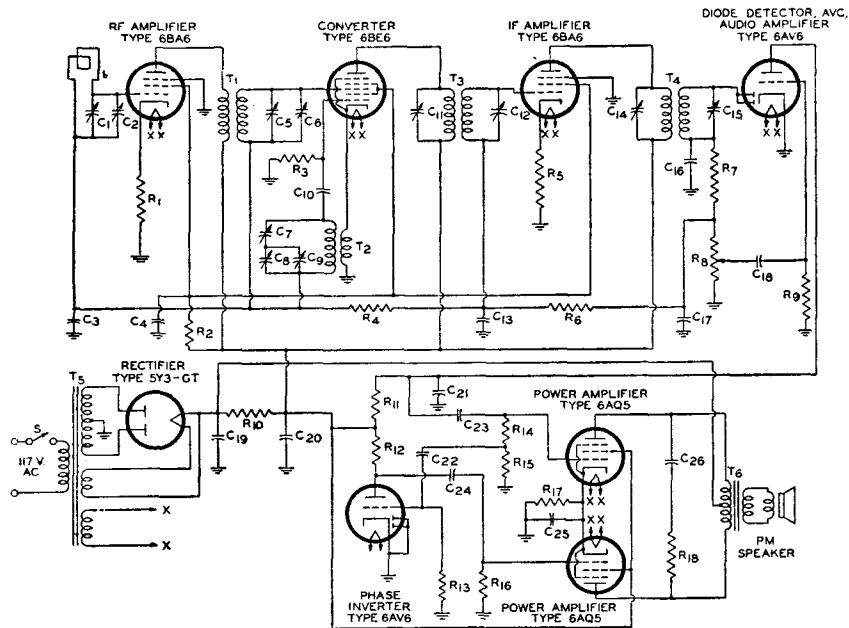

C<sub>1</sub> C<sub>5</sub> C<sub>8</sub>=Ganged tuning capacitors, 365  $\mu$ f  
 C<sub>2</sub> C<sub>6</sub> C<sub>9</sub>=Trimmer capacitors, 4-30  $\mu$ f  
 C<sub>3</sub> C<sub>13</sub>=0.05  $\mu$ f, paper, 50 v.  
 C<sub>4</sub>=0.05  $\mu$ f, paper, 300 v.  
 C<sub>7</sub>=Oscillator padding capacitor—follow oscillator-coil manufacturer's recommendation  
 C<sub>10</sub>=56  $\mu$ f mica  
 C<sub>11</sub> C<sub>12</sub> C<sub>14</sub> C<sub>15</sub>=Trimmer capacitors for if transformers  
 C<sub>16</sub> C<sub>17</sub>=180  $\mu$ f, mica  
 C<sub>18</sub> C<sub>22</sub>=0.01  $\mu$ f, paper, 50 v.  
 C<sub>19</sub> C<sub>20</sub>=20  $\mu$ f, electrolytic, 450 v.

C<sub>21</sub>=120  $\mu$ f, mica  
 C<sub>23</sub> C<sub>24</sub>=0.02  $\mu$ f, paper, 50 v.  
 C<sub>25</sub>=20  $\mu$ f, 50 v.  
 C<sub>26</sub>=0.05  $\mu$ f, paper, 600 v.  
 L=Loop antenna, 540-1600 Kc  
 R<sub>1</sub> R<sub>3</sub>=180 ohms, 0.5 watt  
 R<sub>2</sub>=12000 ohms, 2 watts  
 R<sub>5</sub>=22000 ohms, 0.5 watt  
 R<sub>4</sub> R<sub>6</sub>=2.2 megohms, 0.5 watt  
 R<sub>7</sub>=100000 ohms, 0.5 watt  
 R<sub>8</sub>=Volume control, potentiometer, 1 megohm  
 R<sub>9</sub> R<sub>13</sub>=10 megohms, 0.5 watt  
 R<sub>10</sub>=1800 ohms, 2 watts  
 R<sub>11</sub> R<sub>12</sub>=220000 ohms, 0.5 watt  
 R<sub>14</sub> R<sub>15</sub>=470000 ohms, 0.5 watt  
 R<sub>16</sub>=8200 ohms, 0.5 watt

R<sub>17</sub>=270 ohms, 5 watts  
 R<sub>18</sub>=15000 ohms, 1 watt  
 S=Switch on volume control  
 T<sub>1</sub>=RF transformer, 540-1600 Kc  
 T<sub>2</sub>=Oscillator coil for use with 365- $\mu$ f tuning capacitor and 455-Kc if transformer  
 T<sub>3</sub> T<sub>4</sub>=Intermediate-frequency transformers, 455 Kc  
 T<sub>5</sub>=Power transformer, 250-0-250 volts rms, 100 ma. dc  
 T<sub>6</sub>=Output transformer for matching impedance of voice coil to a 10000-ohm plate-to-plate tube load

(16-4)

AC/DC SUPERHETERODYNE RECEIVER

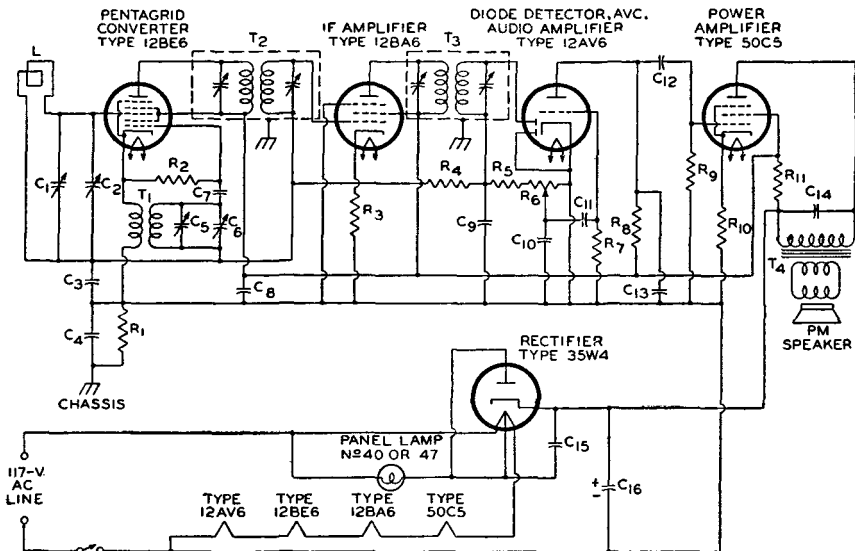

- C<sub>1</sub> C<sub>5</sub>=Ganged tuning capacitors; C<sub>1</sub>, 10-365  $\mu$ f; C<sub>5</sub>, 7-115  $\mu$ f
- C<sub>2</sub> C<sub>6</sub>=Trimmer capacitors, 2-17  $\mu$ f
- C<sub>3</sub> C<sub>15</sub>=0.05  $\mu$ f, paper, 400 v.
- C<sub>4</sub>=0.1  $\mu$ f, paper, 400 v.
- C<sub>7</sub>=56  $\mu$ f, ceramic
- C<sub>8</sub>=50  $\mu$ f, electrolytic, 150 v.
- C<sub>9</sub> C<sub>10</sub>=150  $\mu$ f, ceramic
- C<sub>11</sub> C<sub>14</sub>=0.02  $\mu$ f, paper, 400 v.

- C<sub>12</sub>=0.002  $\mu$ f, paper, 400 v.
- C<sub>13</sub>=330  $\mu$ f, mica
- C<sub>16</sub>=30  $\mu$ f, electrolytic, 150 v.
- L=Loop antenna, 540-1600 Kc
- R<sub>1</sub> R<sub>8</sub>=220000 ohms, 0.5 watt
- R<sub>2</sub>=22000 ohms, 0.5 watt
- R<sub>3</sub>=100 ohms, 0.5 watt
- R<sub>4</sub>=3.3 megohms, 0.5 watt
- R<sub>5</sub>=47000 ohms, 0.5 watt
- R<sub>6</sub>=Volume control, potentiometer, 0.5 megohm
- R<sub>7</sub>=4.7 megohms, 0.5 watt

- R<sub>9</sub>=470000 ohms, 0.5 watt
- R<sub>10</sub>=150 ohms, 0.5 watt
- R<sub>11</sub>=1200 ohms, 1 watt
- T<sub>1</sub>=Oscillator coil for use with tuning capacitor of 7-115  $\mu$ f, and 455-Kc intermediate-frequency transformer
- T<sub>2</sub> T<sub>3</sub>=Intermediate-frequency transformers, 455 Kc
- T<sub>4</sub>=Output transformer for matching impedance of voice coil to 2500-ohm tube load

(16-5)

## AUTOMOBILE RECEIVER

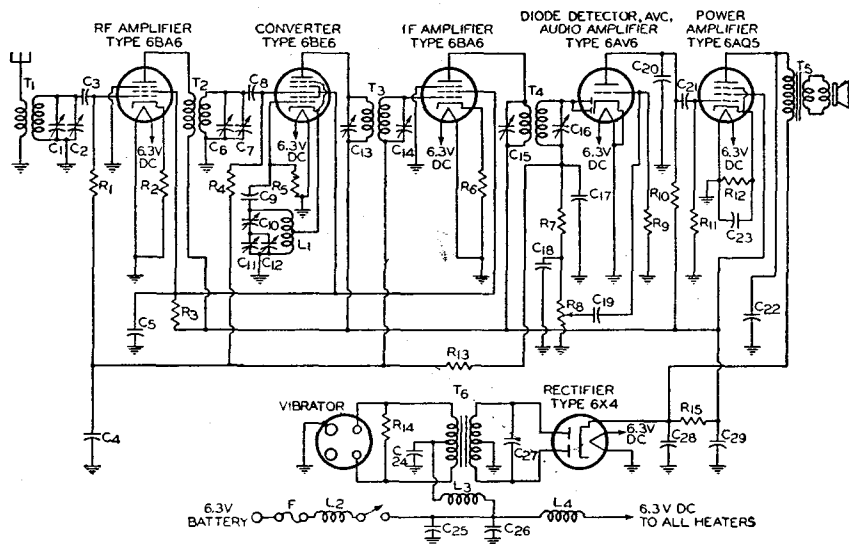

**C<sub>1</sub> C<sub>7</sub> C<sub>11</sub>** = Ganged tuning capacitors, 365  $\mu\text{f}$   
**C<sub>2</sub> C<sub>8</sub> C<sub>12</sub>** = Trimmer capacitors, 4-80  $\mu\text{f}$   
**C<sub>3</sub> C<sub>5</sub>** = 220  $\mu\text{f}$ , mica  
**C<sub>4</sub>** = 0.05  $\mu\text{f}$ , paper, 50 v.  
**C<sub>6</sub>** = 0.05  $\mu\text{f}$ , paper, 300 v.  
**C<sub>9</sub>** = 47  $\mu\text{f}$ , mica  
**C<sub>10</sub>** = Oscillator padding capacitor—follow oscillator-coil manufacturer's recommendation  
**C<sub>13</sub> C<sub>14</sub> C<sub>15</sub> C<sub>16</sub>** = Trimmer capacitors for if transformers  
**C<sub>17</sub> C<sub>18</sub>** = 100  $\mu\text{f}$ , mica  
**C<sub>19</sub>** = 0.01  $\mu\text{f}$ , paper, 50 v.  
**C<sub>20</sub>** = 120  $\mu\text{f}$ , mica  
**C<sub>21</sub>** = 0.005  $\mu\text{f}$ , paper, 300 v.  
**C<sub>22</sub>** = 0.005  $\mu\text{f}$ , paper, 450 v.

**C<sub>23</sub>** = 20  $\mu\text{f}$ , electrolytic, 25 v.  
**C<sub>24</sub> C<sub>25</sub>** = 0.5  $\mu\text{f}$ , paper, 50 v.  
**C<sub>26</sub>** = 470  $\mu\text{f}$ , mica  
**C<sub>27</sub>** = 0.006  $\mu\text{f}$ , paper, 1500 v.  
**C<sub>28</sub> C<sub>29</sub>** = 20  $\mu\text{f}$ , electrolytic, 450 v.  
**F** = Fuse, 10 a.  
**L<sub>1</sub>** = Oscillator coil, tapped, for use with 365- $\mu\text{f}$  tuning capacitor, and 455 Kc if transformer  
**L<sub>2</sub> L<sub>3</sub> L<sub>4</sub>** = RF choke, 10 a.  
**R<sub>1</sub> R<sub>4</sub>** = 1 megohm, 0.5 watt  
**R<sub>2</sub>** = 150 ohms, 0.5 watt  
**R<sub>3</sub>** = 12000 ohms, 2 watts  
**R<sub>5</sub>** = 22000 ohms, 0.5 watt  
**R<sub>6</sub>** = 100 ohms, 0.5 watt  
**R<sub>7</sub>** = 47000 ohms, 0.5 watt  
**R<sub>8</sub>** = Volume control, potentiometer, 1 megohm

**R<sub>9</sub>** = 10 megohms, 0.5 watt  
**R<sub>10</sub>** = 0.27 megohm, 0.5 watt  
**R<sub>11</sub>** = 0.47 megohm, 0.5 watt  
**R<sub>12</sub>** = 390 ohms, 2 watts  
**R<sub>13</sub>** = 2.2 megohms, 0.5 watt  
**R<sub>14</sub>** = 220 ohms, 0.5 watt  
**R<sub>15</sub>** = 1500 ohms, 1 watt  
**T<sub>1</sub> T<sub>2</sub>** = RF transformers, 540-1600 Kc  
**T<sub>3</sub> T<sub>4</sub>** = Intermediate-frequency transformers, 455 Kc  
**T<sub>5</sub>** = Output transformer for matching impedance of voice coil to 5000-ohm tube load  
**T<sub>6</sub>** = Vibrator transformer, Stancor P-4062, or equivalent  
**Vibrator** = Mallory Type No. 859, or equivalent

(16-6)

## SUPERREGENERATIVE RECEIVER

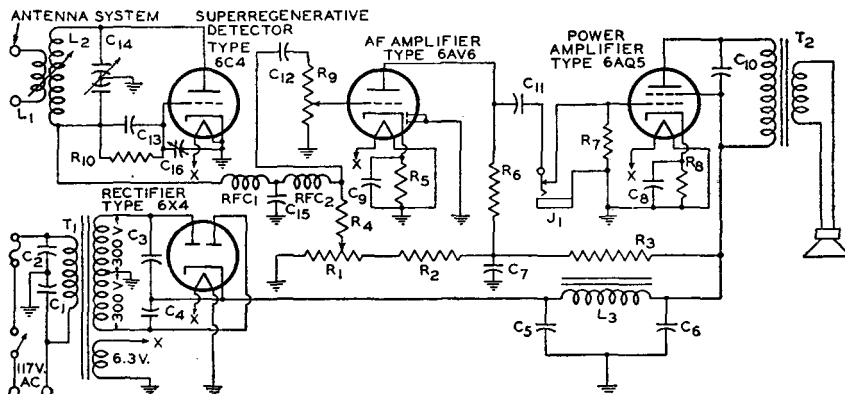

$C_1 C_2 = 0.1 \mu\text{f}$ , paper, 400 v.  
 $C_3 C_4 = 100 \mu\mu\text{f}$ , mica, 500 v.  
 $C_5 C_6 C_7 = 20 \mu\text{f}$ , electrolytic, 450 v.  
 $C_8 = 25 \mu\text{f}$ , electrolytic, 50 v.  
 $C_9 = 25 \mu\text{f}$ , electrolytic, 25 v.  
 $C_{10} = 0.002 \mu\text{f}$ , paper, 600 v.  
 $C_{11} = 0.01 \mu\text{f}$ , paper, 400 v.  
 $C_{12} = 0.005 \mu\text{f}$ , paper, 400 v.  
 $C_{13} = 50 \mu\mu\text{f}$ , silver mica, 300 v.  
 $C_{14} = 10 \mu\mu\text{f}$  max. per section  
 $C_{15} = 0.006 \mu\mu\text{f}$ , mica, 300 v.  
 $C_{16} = 3-30 \mu\mu\text{f}$ , ceramic or mica  
 $J_1 = \text{Jack for earphones}$

$L_1 = \text{Antenna pickup loop}$   
 $L_2 = 4 \text{ turns of No. 12 copper wire on a } \frac{1}{2}'' \text{ I.D. form (144 Mc): adjust spacing to set band}$   
 $L_3 = \text{Speaker field or filter choke, 12 henries, 70 ma.}$   
 $R_1 = \text{Potentiometer, 47000 ohms, 1 watt, wire wound}$   
 $R_2 R_3 = 47000 \text{ ohms, 1 watt}$   
 $R_4 = 27000 \text{ ohms, 0.5 watt}$   
 $R_5 = 2700 \text{ ohms, 1 watt}$   
 $R_6 R_7 = 0.1 \text{ megohm, 0.5 watt}$

$R_8 = 270 \text{ ohms, 1 watt}$   
 $R_9 = \text{Volume control, potentiometer, 500000 ohms}$   
 $R_{10} = 4.7 \text{ megohms, 0.5 watt}$   
 $\text{RFC}_1 = \text{One-quarter wavelength of No. 23 Enam. close wound on a } \frac{1}{4}'' \text{ form (144 Mc)}$   
 $\text{RFC}_2 = \text{RF choke, 8 mh.}$   
 $T_1 = \text{Power transformer, 300-0-300 volts rms, 70 ma.}$   
 $T_2 = \text{Output transformer for matching impedance of voice coil to 5000-ohm tube load}$

(16-7)

AC-OPERATED REGENERATIVE SHORT-WAVE RECEIVER

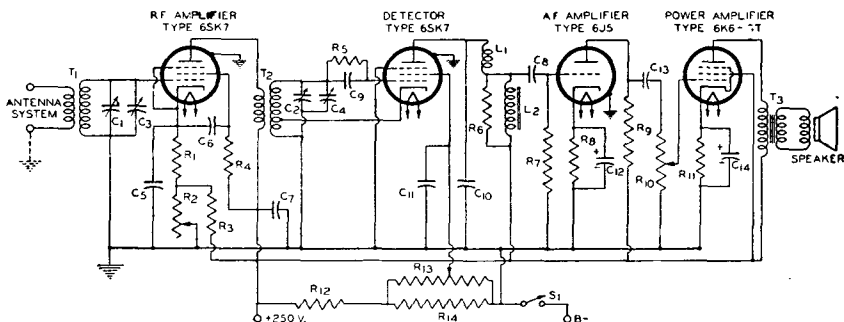

**C<sub>1</sub> C<sub>2</sub>**=35  $\mu$ f  
**C<sub>3</sub> C<sub>4</sub>**=Midget tuning capacitors, 140  $\mu$ f  
**C<sub>5</sub> C<sub>6</sub> C<sub>7</sub> C<sub>13</sub>**=0.05  $\mu$ f  
**C<sub>8</sub>**=0.01  $\mu$ f, 400 v.  
**C<sub>9</sub> C<sub>10</sub>**=0.00025  $\mu$ f, mica  
**C<sub>11</sub>**=1  $\mu$ f, 200 v.  
**C<sub>12</sub>**=8  $\mu$ f, electrolytic, 25 v.  
**C<sub>14</sub>**=16  $\mu$ f, electrolytic, 25 v.  
**L<sub>1</sub>**=RF choke, 8 mh.  
**L<sub>2</sub>**=AF choke, 300-500 mh.  
**R<sub>1</sub>**=270 ohms, 0.5 watt  
**R<sub>2</sub>**=Potentiometer, 10000 ohms, wire wound

**R<sub>3</sub>**=100000 ohms, 1 watt  
**R<sub>4</sub>**=56000 ohms, 1 watt  
**R<sub>5</sub>**=2 to 5 megohms, 0.5 watt  
**R<sub>6</sub>**=270000 ohms, 1 watt  
**R<sub>7</sub>**=1 megohm, 0.5 watt  
**R<sub>8</sub>**=1500 ohms, 1 watt  
**R<sub>9</sub>**=47000 ohms, 0.5 watt  
**R<sub>10</sub>**=Volume control, potentiometer, 500000 ohms  
**R<sub>11</sub>**=560 ohms, 1 watt  
**R<sub>12</sub>**=15000 ohms, 5 watts  
**R<sub>13</sub>**=Regeneration control, potentiometer, 500000 ohms

**R<sub>14</sub>**=5600 ohms, 1 watt  
**S<sub>1</sub>**=Switch, single-pole, single-throw  
**T<sub>1</sub>**=RF coil of the 4-prong, plug-in type for use with a 140- $\mu$ f tuning capacitor  
**T<sub>2</sub>**=Regenerative detector coil of the 5-prong, 2-winding, plug-in type with tapped grid winding for electron-coupled circuit  
**T<sub>3</sub>**=Output transformer for matching impedance of voice coil to a 7500-ohm tube load



(16-8)

## BATTERY-OPERATED SHORT-WAVE RECEIVER 1.4-Volt Types

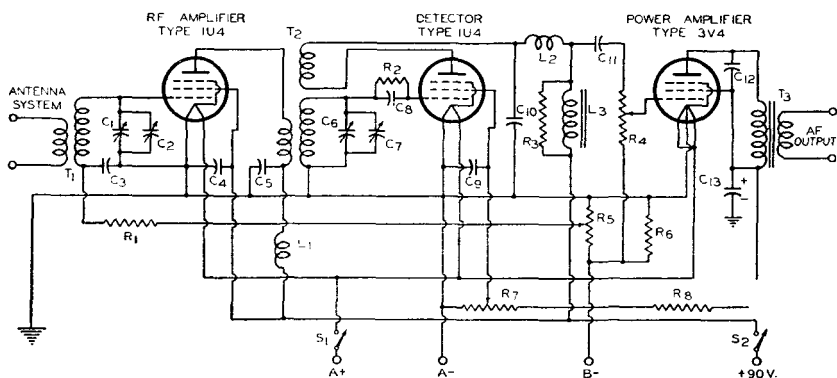

**C<sub>1</sub> C<sub>6</sub>** = Midget tuning capacitors, 140  $\mu\text{f}$   
**C<sub>2</sub> C<sub>7</sub>** = 35  $\mu\text{f}$   
**C<sub>3</sub> C<sub>4</sub> C<sub>11</sub>** = 0.05  $\mu\text{f}$   
**C<sub>8</sub> C<sub>10</sub>** = 0.00025  $\mu\text{f}$   
**C<sub>9</sub>** = 1  $\mu\text{f}$   
**C<sub>12</sub>** = 0.002  $\mu\text{f}$   
**C<sub>13</sub>** = 8  $\mu\text{f}$ , electrolytic, 100 v.  
**L<sub>1</sub> L<sub>2</sub>** = RF chokes, 8 mh.  
**L<sub>3</sub>** = AF choke, 300-500 mh.

**R<sub>1</sub>** = 100000 ohms, 0.5 watt  
**R<sub>2</sub>** = 2 - 5 megohms, 0.5 watt  
**R<sub>3</sub>** = 0.25 megohm, 0.5 watt  
**R<sub>4</sub>** = Volume control, potentiometer, 0.5 megohm  
**R<sub>5</sub> R<sub>7</sub>** = Potentiometers, 50000 ohms  
**R<sub>6</sub>** = 470 ohms, 0.5 watt  
**R<sub>8</sub>** = 30000 ohms, 0.5 watt  
**S<sub>1</sub> S<sub>2</sub>** = Ganged switch, double-pole, single-throw

**T<sub>1</sub>** = RF coil of the 4-prong, 2-winding, plug-in type for use with 140- $\mu\text{f}$  tuning capacitor  
**T<sub>2</sub>** = Regenerative detector coil of the 6-prong, 3-winding, plug-in type for use with 140- $\mu\text{f}$  tuning capacitor  
**T<sub>3</sub>** = Output transformer for matching impedance of voice coil to 9000-ohm tube load

(16-9)

## FM TUNER

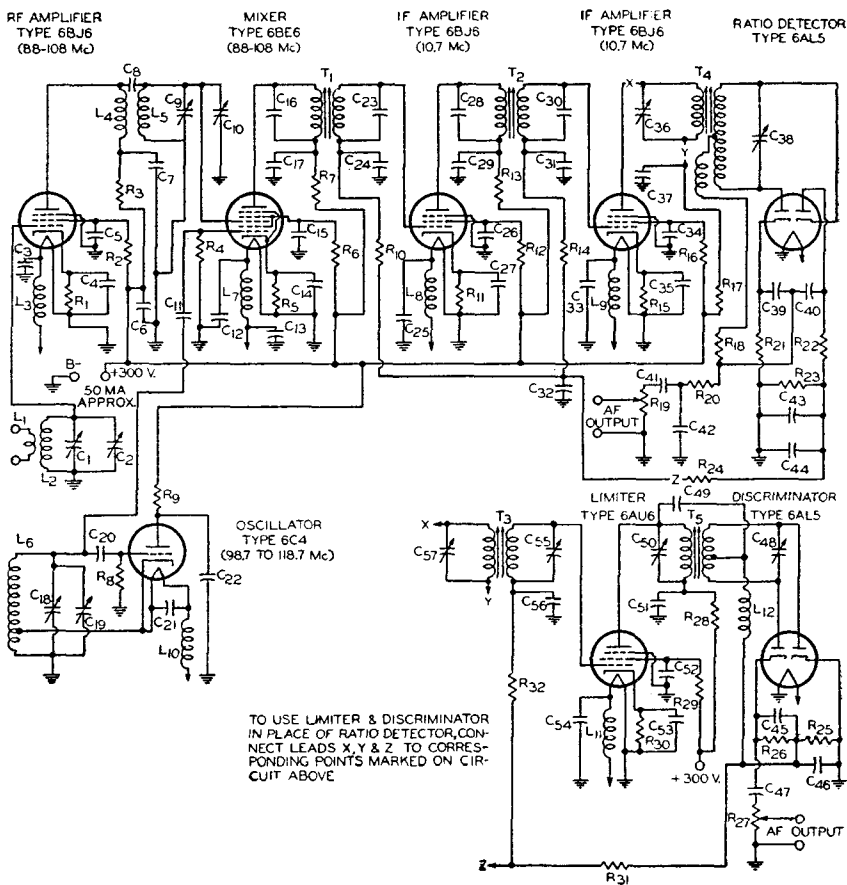

(16-9)

FM TUNER (Cont'd)

- C<sub>1</sub> C<sub>9</sub> C<sub>18</sub>** = Ganged tuning capacitors, 7.5 - 20  $\mu\text{f}$   
**C<sub>2</sub> C<sub>10</sub> C<sub>19</sub>** = Trimmer capacitors, 1.5 - 5.0  $\mu\text{f}$ , ceramic  
**C<sub>3</sub>** = 0.01  $\mu\text{f}$ , mica, 200 v.  
**C<sub>4</sub> C<sub>14</sub> C<sub>24</sub> C<sub>27</sub> C<sub>31</sub> C<sub>33</sub> C<sub>33</sub> C<sub>36</sub>** = 1500  $\mu\text{f}$ , mica, 200 v.  
**C<sub>5</sub> C<sub>7</sub> C<sub>13</sub> C<sub>17</sub> C<sub>21</sub> C<sub>25</sub> C<sub>29</sub> C<sub>34</sub> C<sub>37</sub>**  
**C<sub>52</sub>** = 1500  $\mu\text{f}$ , mica, 400 v.  
**C<sub>6</sub>** = 0.1  $\mu\text{f}$ , paper, 400 v.  
**C<sub>8</sub>** = 33  $\mu\text{f}$ , mica, 400 v.  
**C<sub>11</sub>** = 3  $\mu\text{f}$ , silver mica, 200 v.  
**C<sub>12</sub> C<sub>23</sub> C<sub>32</sub> C<sub>33</sub> C<sub>34</sub>** = 0.01  $\mu\text{f}$ , paper, 200 v.  
**C<sub>13</sub>** = 0.01  $\mu\text{f}$ , paper, 200 v.  
**C<sub>16</sub> C<sub>22</sub> C<sub>28</sub> C<sub>30</sub> C<sub>35</sub> C<sub>38</sub> C<sub>48</sub> C<sub>49</sub>**  
**C<sub>50</sub> C<sub>55</sub> C<sub>57</sub>** = Trimmer capacitors, 22-50  $\mu\text{f}$ , mica, usually part of if transformer  
**C<sub>20</sub>** = 33  $\mu\text{f}$ , silver mica, 200 v.  
**C<sub>21</sub>** = 100  $\mu\text{f}$ , mica, 200 v.  
**C<sub>39</sub> C<sub>40</sub>** = 330  $\mu\text{f}$ , mica, 200 v.  
**C<sub>41</sub>** = 0.05  $\mu\text{f}$ , paper, 200 v.  
**C<sub>42</sub> C<sub>43</sub>** = 0.005  $\mu\text{f}$ , paper, 200 v.  
**C<sub>44</sub>** = 10  $\mu\text{f}$ , electrolytic, 200 v.  
**C<sub>45</sub> C<sub>46</sub>** = 250  $\mu\text{f}$ , mica, 200 v.  
**C<sub>47</sub>** = 0.1  $\mu\text{f}$ , mica, 200 v.  
**C<sub>51</sub>** = 500  $\mu\text{f}$ , mica, 400 v.  
**L<sub>1</sub>** = 1 turn of No.14 Enam. wound on a  $\frac{3}{4}$ " diam. coil form  
**L<sub>2</sub>** = 2.5 turns of No.14 Enam. spaced 1 wire diameter wound on same form as **L<sub>1</sub>** with the ground end of **L<sub>2</sub>** spaced  $\frac{1}{4}$ " from **L<sub>1</sub>**  
**L<sub>3</sub> L<sub>4</sub> L<sub>7</sub> L<sub>8</sub> L<sub>9</sub> L<sub>10</sub> L<sub>11</sub>** = Choke, 1  $\mu\text{h}$  (approx.), 25 turns of No.24 Enam. close-wound on resistor (47000 ohms, 0.5 watt), connected in parallel with resistor.  
**L<sub>5</sub>** = 2.5 turns of No.14 Enam. spaced 1 wire diameter, wound on  $\frac{3}{4}$ " form.  
**L<sub>6</sub>** = 2 turns of No.14 Enam. spaced 1 wire diameter, wound on  $\frac{3}{4}$ " form, tapped at  $\frac{1}{2}$  turn from ground end:  
**L<sub>12</sub>** = Choke, 2.5 mh.  
**R<sub>1</sub> R<sub>5</sub>** = 50 ohms, 0.5 watt  
**R<sub>2</sub> R<sub>12</sub> R<sub>16</sub>** = 0.04 megohm, 0.5 watt  
**R<sub>3</sub> R<sub>7</sub> R<sub>13</sub> R<sub>17</sub>** = 500 ohms, 0.5 watt  
**R<sub>4</sub> R<sub>23</sub> R<sub>28</sub>** = 0.01 megohm, 0.5 watt  
**R<sub>6</sub>** = 0.03 megohm, 1 watt  
**R<sub>8</sub>** = 0.05 megohm, 0.5 watt  
**R<sub>9</sub>** = 0.005 megohm, 1 watt  
**R<sub>10</sub> R<sub>14</sub> R<sub>32</sub>** = 0.2 megohm, 0.5 watt  
**R<sub>11</sub> R<sub>15</sub> R<sub>30</sub>** = 68 ohms, 0.5 watt.  
**R<sub>18</sub>** = 56 ohms, 0.5 watt  
**R<sub>19</sub> R<sub>27</sub>** = Volume controls, potentiometers, 1 megohm  
**R<sub>20</sub>** = 0.015 megohm, 0.5 watt  
**R<sub>21</sub>** = 820 ohms, 0.5 watt  
**R<sub>22</sub>** = 560 ohms, 0.5 watt  
**R<sub>24</sub> R<sub>31</sub>** = 2 megohms, 0.5 watt  
**R<sub>25</sub> R<sub>26</sub>** = 0.1 megohm, 0.5 watt  
**R<sub>29</sub>** = 0.15 megohm, 1 watt

Fig. 15-7 illustrates the circuit for an FM tuner. The basic circuit has been arranged to show the use of a ratio detector, but the limiter/discriminator circuit shown in the lower right-hand corner of the diagram can be substituted as described above.

A word of caution is necessary in connection with this circuit. Because it works at very high frequencies and is required to handle a very wide bandwidth, its construction requires more than ordinary skill and equipment. Placement of component parts is quite critical in a receiver of this nature and requires careful experimentation. All rf leads to components including bypass capacitors must be kept short and must be properly dressed to minimize intercoupling and capacitance effects. The minimum equipment required for circuit alignment and oscillator tracking calls for a frequency-modulated signal generator and a high-impedance vacuum-tube voltmeter. Unless the builder has the necessary equipment and has had considerable experience with broad-band, high-frequency circuits, he should not undertake the construction of this circuit.

(16-10)

**CLASS A<sub>1</sub> AUDIO AMPLIFIER**

For Use On DC Power Line—Power Output, 4 Watts\*

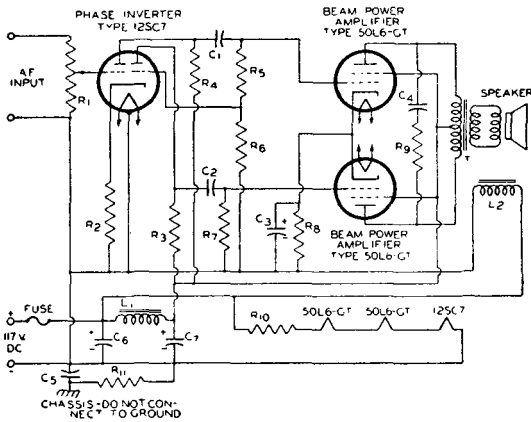

- C<sub>1</sub> C<sub>2</sub> = 0.006  $\mu$ f
- C<sub>3</sub> = 25  $\mu$ f, electrolytic, 25 v.
- C<sub>4</sub> = 0.035  $\mu$ f
- C<sub>5</sub> = 0.1  $\mu$ f, paper, 150 v.
- C<sub>6</sub> = 2  $\mu$ f, electrolytic, 150 v.
- C<sub>7</sub> = 4  $\mu$ f, electrolytic, 150 v.
- L<sub>1</sub> = Filter choke, 10 henries at 125 ma., 60 ohms

- L<sub>2</sub> = Speaker field, 115 volts dc
- R<sub>1</sub> = Volume control, potentiometer, 500000 ohms
- R<sub>2</sub> = 4000 ohms, 0.5 watt
- R<sub>3</sub> R<sub>4</sub> R<sub>11</sub> = 250000 ohms, 0.5 watt
- R<sub>5</sub> = 475000 ohms, 0.5 watt
- R<sub>6</sub> = 16000 ohms, 0.5 watt

- R<sub>7</sub> = 500000 ohms, 0.5 watt
- R<sub>8</sub> = 70 ohms, 1 watt
- R<sub>9</sub> = 4000 ohms, 2 watts
- R<sub>10</sub> = 33 ohms, 1.0 watt
- T = Output transformer for matching the impedance of voice coil to 3000-ohm plate-to-plate tube load

Signal voltage input for full power output = 0.25 volt peak

(16-11)

MICROPHONE AND PHONOGRAPH AMPLIFIER

Power Output, 6 Watts

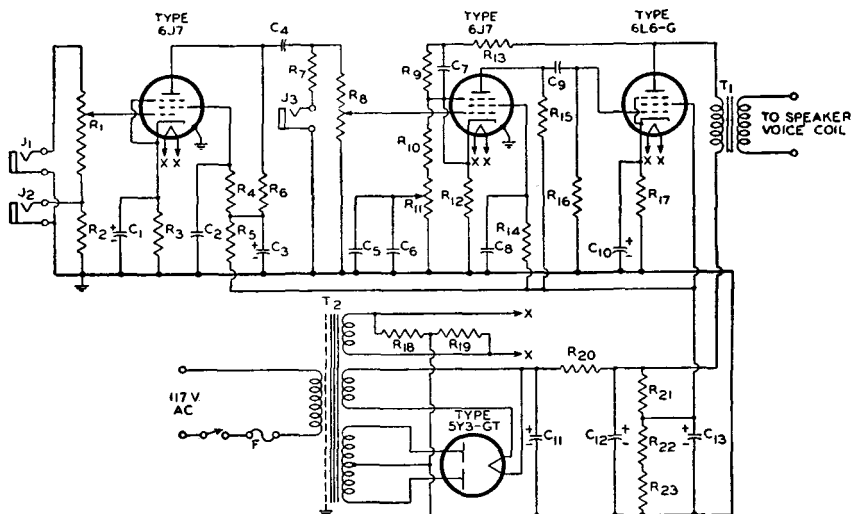

**C<sub>1</sub>** = 16  $\mu$ f, electrolytic, 150 v.  
**C<sub>2</sub>** **C<sub>5</sub>** **C<sub>6</sub>** = 0.1  $\mu$ f, paper, 200 v.  
**C<sub>3</sub>** **C<sub>13</sub>** = 10  $\mu$ f, electrolytic, 450 v.  
**C<sub>4</sub>** **C<sub>9</sub>** = 0.05  $\mu$ f, paper, 400 v.  
**C<sub>6</sub>** = 0.25  $\mu$ f, paper, 200 v.  
**C<sub>7</sub>** = 820  $\mu$ f, mica, 500 v.  
**C<sub>10</sub>** = 20  $\mu$ f, electrolytic, 25 v.  
**C<sub>11</sub>** **C<sub>12</sub>** = 25  $\mu$ f, electrolytic, 450 v.  
**F** = Fuse, 1 ampere  
**J<sub>1</sub>** = Jack for high-impedance crystal microphone input, maximum input: 2 volts peak  
**J<sub>2</sub>** = Jack for low-impedance phono-pickup input, maximum input: 0.135 volt peak

**J<sub>3</sub>** = Jack for high-impedance phono-pick up input, maximum input: 20 volts peak  
**R<sub>1</sub>** **R<sub>5</sub>** = Volume control, potentiometer, 0.5 megohm  
**R<sub>2</sub>** = 2200 ohms, 0.5 watt  
**R<sub>3</sub>** = 1500 ohms, 0.5 watt  
**R<sub>4</sub>** **R<sub>14</sub>** = 1.2 megohms, 0.5 watt  
**R<sub>5</sub>** **R<sub>13</sub>** = 82000 ohms, 0.5 watt  
**R<sub>7</sub>** **R<sub>9</sub>** = 470000 ohms, 0.5 watt  
**R<sub>10</sub>** = 47 ohms, 0.5 watt  
**R<sub>11</sub>** = Tone control, potentiometer, 5000 ohms

**R<sub>12</sub>** = 1000 ohms, 0.5 watt  
**R<sub>15</sub>** = 220000 ohms, 0.5 watt  
**R<sub>16</sub>** = 330000 ohms, 0.5 watt  
**R<sub>17</sub>** = 220 ohms, 2 watts  
**R<sub>18</sub>** **R<sub>19</sub>** = 33 ohms, 0.5 watt  
**R<sub>20</sub>** = 440 ohms, 10 watts  
**R<sub>21</sub>** = 8200 ohms, 0.5 watt  
**R<sub>22</sub>** **R<sub>23</sub>** = 33000 ohms, 2 watts  
**T<sub>1</sub>** = Output transformer for matching impedance of voice coil to 4000-ohm tube load  
**T<sub>2</sub>** = Power transformer, 350-0-350 volts rms, 125 ma.

(16-12)

### HIGH-FIDELITY AUDIO AMPLIFIER

With Independent Bass and Treble Controls and Preamplifier  
for Low-Level Inputs—10 Watts

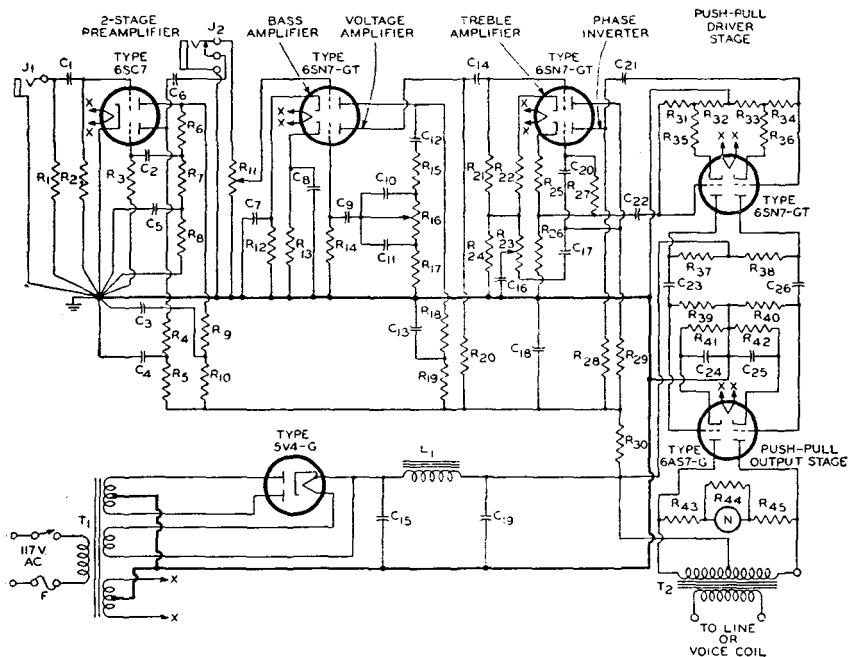

C<sub>1</sub> C<sub>2</sub> C<sub>11</sub>=0.05  $\mu$ f, paper, 600 v.  
 C<sub>3</sub> C<sub>4</sub>=20  $\mu$ f, electrolytic, 450 v.  
 C<sub>5</sub> C<sub>9</sub>=0.01  $\mu$ f, paper, 600 v.  
 C<sub>6</sub> C<sub>16</sub> C<sub>20</sub> C<sub>21</sub> C<sub>22</sub> C<sub>23</sub> C<sub>26</sub>=0.02  $\mu$ f, paper, 600 v.  
 C<sub>7</sub> C<sub>8</sub>=25  $\mu$ f, electrolytic, 50 v.  
 C<sub>10</sub> C<sub>14</sub> C<sub>17</sub>=0.005  $\mu$ f, paper, 600 v.  
 C<sub>12</sub>=0.1  $\mu$ f, paper, 400 v.  
 C<sub>13</sub>=8  $\mu$ f, electrolytic, 450 v.  
 C<sub>15</sub> C<sub>19</sub>=15  $\mu$ f, electrolytic, 450 v.  
 C<sub>18</sub>=10  $\mu$ f, electrolytic, 450 v.  
 C<sub>24</sub> C<sub>25</sub>=20  $\mu$ f, electrolytic, 150 v.  
 F=1 ampere  
 J<sub>1</sub>=Jack for low-impedance phono-pickup input  
 J<sub>2</sub>=Closed-circuit jack for high impedance phono-pickup input

L<sub>1</sub>=Filter choke, 12 henries, 230 ohms, 150 ma.  
 N=Overload indicator, neon lamp, 1/4 watt  
 R<sub>1</sub>=5600 ohms, 0.5 watt  
 R<sub>2</sub> R<sub>3</sub>=3.3 megohms, 0.5 watt  
 R<sub>4</sub> R<sub>5</sub> R<sub>29</sub>=33000 ohms, 0.5 watt  
 R<sub>6</sub>=200000 ohms, 0.5 watt  
 R<sub>7</sub>=27000 ohms, 0.5 watt  
 R<sub>8</sub>=180000 ohms, 0.5 watt  
 R<sub>9</sub> R<sub>10</sub>=68000 ohms, 0.5 watt  
 R<sub>11</sub>=Volume control, potentiometer, 0.5 megohm  
 R<sub>12</sub> R<sub>13</sub> R<sub>22</sub>=1500 ohms, 0.5 watt  
 R<sub>14</sub> R<sub>21</sub> R<sub>27</sub> R<sub>31</sub> R<sub>34</sub> R<sub>39</sub> R<sub>40</sub>=0.5 megohm, 0.5 watt  
 R<sub>15</sub> R<sub>43</sub> R<sub>45</sub>=100000 ohms, 0.5 watt  
 R<sub>16</sub>=Bass control, potentiometer, 1 megohm

R<sub>17</sub> R<sub>24</sub>=10000 ohms, 0.5 watt  
 R<sub>18</sub> R<sub>20</sub> R<sub>26</sub> R<sub>28</sub> R<sub>27</sub> R<sub>35</sub>=47000 ohms, 0.5 watt  
 R<sub>19</sub>=20000 ohms  
 R<sub>23</sub>=Treble control, potentiometer, 0.25 megohm  
 R<sub>25</sub>=4700 ohms, 0.5 watt  
 R<sub>30</sub>=10000 ohms, 2.0 watts  
 R<sub>32</sub> R<sub>33</sub> R<sub>35</sub> R<sub>36</sub>=2700 ohms  
 R<sub>41</sub> R<sub>42</sub>=2500 ohms, wire-wound, 10 watts  
 R<sub>44</sub>=75000 ohms, 0.5 watt  
 T<sub>1</sub>=Power transformer, 375-0-375 volts rms, 160 ma.  
 T<sub>2</sub>=Output transformer for matching impedance of line or voice coil to 5000-ohm plate-to-plate tube load

NOTE: Refer to type 6AS7-G in TUBE TYPES SECTION for operation characteristic and operating conditions for this circuit.

(16-13)

## HIGH-POWER AUDIO AMPLIFIER

Class AB<sub>i</sub>; Output, 25 Watts

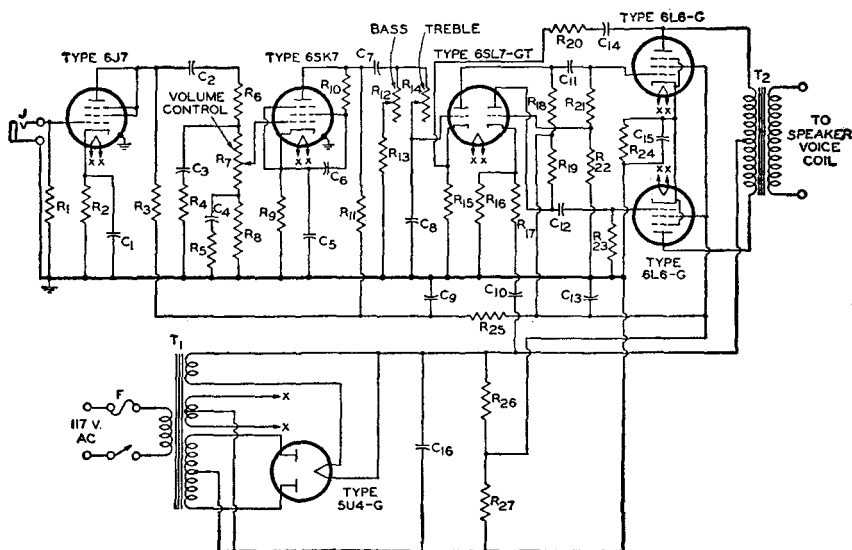

$C_1$   $C_6$   $C_{15}$  = 20  $\mu$ f, electrolytic, 25 v.  
 $C_2$   $C_3$   $C_7$  = 0.01  $\mu$ f, paper, 400 v.  
 $C_4$  = 0.005  $\mu$ f, paper, 100 v.  
 $C_5$  = 0.5  $\mu$ f, paper, 400 v.  
 $C_8$  = 330  $\mu$ mf, mica  
 $C_9$   $C_{13}$  = 30  $\mu$ f, electrolytic, 450 v.  
 $C_{10}$   $C_{11}$   $C_{12}$   $C_{14}$  = 0.1  $\mu$ f, paper, 400 v.  
 $C_{16}$  = 40  $\mu$ f, electrolytic, 450 v.  
**F** = Fuse, 3 amperes  
**J** = Jack for high-impedance phono-pickup input  
 $R_1$  = 1 megohm, 0.5 watt  
 $R_2$  = 1800 ohms, 0.5 watt

$R_3$   $R_4$  = 82000 ohms, 0.5 watt  
 $R_5$   $R_{13}$  = 47000 ohms, 0.5 watt  
 $R_6$   $R_7$   $R_8$  = Volume control, potentiometer, 1.5 megohm, tapped at 0.25 and 0.5 megohm.  
 $R_8$  is 0.25-megohm section.  
 $R_9$  = 390 ohms, 0.5 watt  
 $R_{10}$  = 120000 ohms, 0.5 watt  
 $R_{11}$  = 15000 ohms, 0.5 watt  
 $R_{12}$  = Bass control, potentiometer, 0.5 megohm  
 $R_{14}$  = Treble control, potentiometer, 0.5 megohm  
 $R_{15}$   $R_{14}$  = 4700 ohms, 0.5 watt  
 $R_{17}$  = 250000 ohms, 0.5 watt

$R_{18}$   $R_{19}$  = 220000 ohms, 1 watt  
 $R_{20}$  = 560000 ohms, 0.5 watt  
 $R_{21}$   $R_{23}$  = 270000 ohms, 0.5 watt  
 $R_{22}$  = 12000 ohms, 0.5 watt  
 $R_{24}$  = 185 ohms, 10 watts  
 $R_{25}$  = 10000 ohms, 1 watt  
 $R_{26}$  = 2000 ohms, 20 watts  
 $R_{27}$  = 12500 ohms, 20 watts  
 $T_1$  = Power transformer, 400-0-400 volts rms, 200 ma.  
 $T_2$  = Output transformer for matching impedance of voice coil to 6600-ohm plate-to-plate tube load.

**NOTE:** The value of  $R_{17}$  should be adjusted for minimum power-supply ripple in output.

(16-14)

**HIGH-POWER AUDIO-AMPLIFIER**  
 Class AB<sub>2</sub> 6L6's, Output 45 Watts

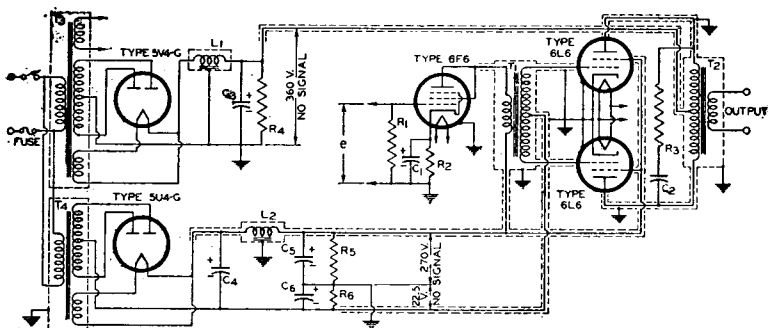

C<sub>1</sub> C<sub>6</sub> = 25  $\mu$ f, electrolytic, 25 v.  
 C<sub>2</sub> = 0.035  $\mu$ f, 1000 v.  
 C<sub>3</sub> = 16  $\mu$ f, electrolytic, 450 v.  
 C<sub>4</sub> C<sub>5</sub> = 8  $\mu$ f, electrolytic, 450 v.  
 L<sub>1</sub> = Filter choke, 5 henries at  
 220 ma., 50 ohms or less  
 L<sub>2</sub> = Filter choke, 20 henries at  
 150 ma., 100 ohms or less  
 R<sub>1</sub> = 0.5 megohm, 0.5 watt

R<sub>2</sub> = 650 ohms, 0.5 watt  
 R<sub>3</sub> = 5000 ohms, 20 watts  
 R<sub>4</sub> = 50000 ohms, 5 watts  
 R<sub>5</sub> = 3500 ohms, 30 watts  
 R<sub>6</sub> = 200 ohms, 5 watts  
 T<sub>1</sub> = Interstage transformer for  
 matching a single 6F6 to push-  
 pull 6L6's as class AB<sub>2</sub> ampli-  
 fiers

T<sub>2</sub> = Output transformer for  
 matching the impedance of  
 voice coil to a 3800-ohm plate-  
 to-plate tube load  
 T<sub>3</sub> = Power transformer, 440-  
 0-440 volts rms, 175 ma. dc  
 T<sub>4</sub> = Power transformer, 315-  
 0-315 volts rms, 150 ma. dc



(16-15)

**CLASS B AMPLIFIER FOR MOBILE USE**

Power Output 10 Watts\*

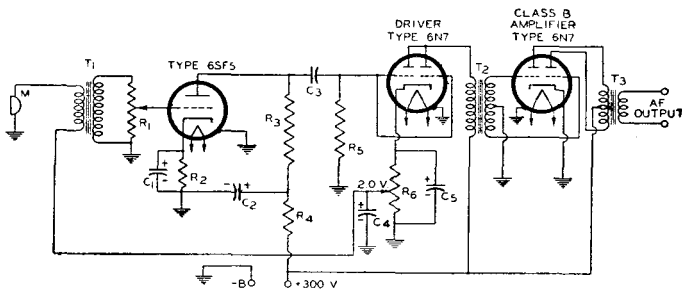

$C_1 = 5 \mu\text{f}$ , electrolytic, 25 v.  
 $C_2 = 4 \mu\text{f}$ , electrolytic, 250 v.  
 $C_3 = 0.025 \mu\text{f}$   
 $C_4 = 25 \mu\text{f}$ , electrolytic, 25 v.  
 $M =$  Microphone, single-button, 200 ohms  
 $R_1 =$  Volume control, potentiometer, 500000 ohms

$R_2 = 1300$  ohms, 0.5 watt  
 $R_3 R_5 = 100000$  ohms, 0.5 watt  
 $R_4 = 50000$  ohms, 0.5 watt  
 $R_6 =$  Voltage control, variable resistor, 1000 ohms, set for 2.0 volts  
 $T_1 =$  Transformer for matching a single-button microphone to a single grid

$T_2 =$  Input transformer for matching parallel-connected 6N7 to a 6N7 class B amplifier  
 $T_3 =$  Output transformer for matching impedance of voice coil to 8000-ohm plate-to-plate tube load

\* Peak signal-input voltage to 6SF5 grid is 0.15 volt for full power output

(16-16)

**TWO-CHANNEL AUDIO MIXER**

Voltage Gain From Each Grid of 6SC7 to Output is Approximately 15

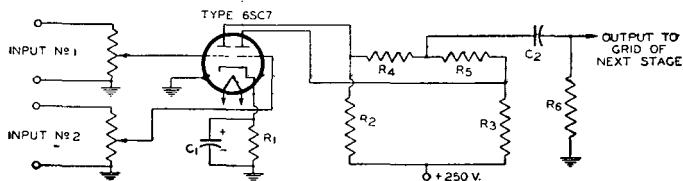

$C_1 = 8 \mu\text{f}$ , electrolytic, 25 v.  
 $C_2 = 0.005 \mu\text{f}$ , paper, 400 v.

$R_1 = 2000$  ohms, 0.5 watt

$R_2 R_3 = 250000$  ohms, 0.5 watt  
 $R_4 R_5 R_6 = 1$  megohm, 0.5 watt

(16-17)

NON-MOTORBOATING RESISTANCE-COUPLED AMPLIFIER

Voltage Gain, 9000

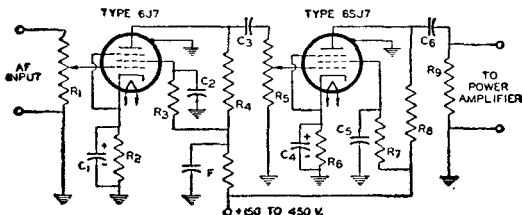

$C_1$   $C_4 = 8 \mu\text{f}$ , electrolytic, 25 v.  
 $C_2$   $C_5 = 0.06 \mu\text{f}$ , voltage rating  
 as high as voltage supply  
 $C_3$   $C_6 = 0.006 \mu\text{f}$ , voltage rating  
 as high as voltage supply

$R_1$  = Volume control, potentiometer  
 $R_2$   $R_6 = 600$  ohms, 0.5 watt  
 $R_3$   $R_7$   $R_9 = 500000$  ohms, 0.5 watt

$R_4$   $R_8 = 100000$  ohms, 0.5 watt  
 $R_5$  = Volume control, potentiometer, 0.5 megohm, ganged with  $R_1$   
 F = Decoupling filter

NOTE: Values of resistance and capacitance shown in this circuit are taken from Charts 14 and 20 in the RESISTANCE-COUPLED AMPLIFIER SECTION. The values are chosen to give a sharp low-frequency cutoff and, thus, to minimize tendency of multiple stages to motorboat. Three or more stages, including power stage, operated from a common B-supply may require a decoupling filter in the plate-supply lead of one or more of the voltage amplifier stages. The constants of decoupling filters depend on the design requirements of the amplifier.

(16-18)

CODE PRACTICE OSCILLATOR

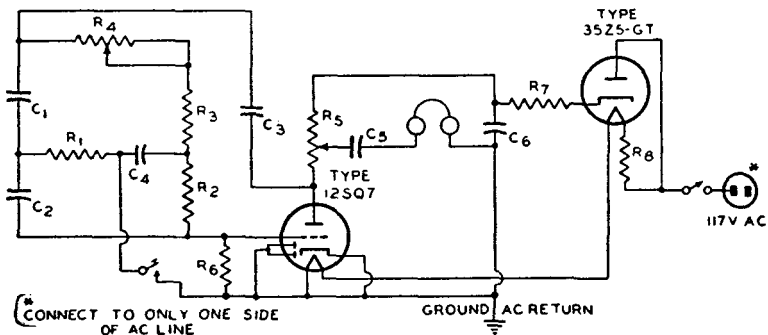

$C_1$   $C_2 = 0.001 \mu\text{f}$ , mica, 300 v.  
 $C_3 = 0.01 \mu\text{f}$ , paper, 400 v.  
 $C_4 = 0.002 \mu\text{f}$ , mica, 300 v.  
 $C_5 = 0.003 \mu\text{f}$ , paper, 400 v.  
 $C_6 = 20 \mu\text{f}$ , electrolytic, 250 v.

$R_1 = 27000$  ohms, 0.5 watt  
 $R_2 = 0.27$  megohm, 0.5 watt  
 $R_3 = 0.22$  megohm, 0.5 watt  
 $R_4$  = Potentiometer, 1.0 megohm, carbon

$R_5$  = Volume control, potentiometer, 0.1 megohm  
 $R_6 = 2.2$  megohms, 0.5 watt  
 $R_7 = 47000$  ohms, 0.5 watt  
 $R_8 = 470$  ohms, 25 watts

(16-19)

## INTERCOMMUNICATION SET With Master Unit and Six Remote Units

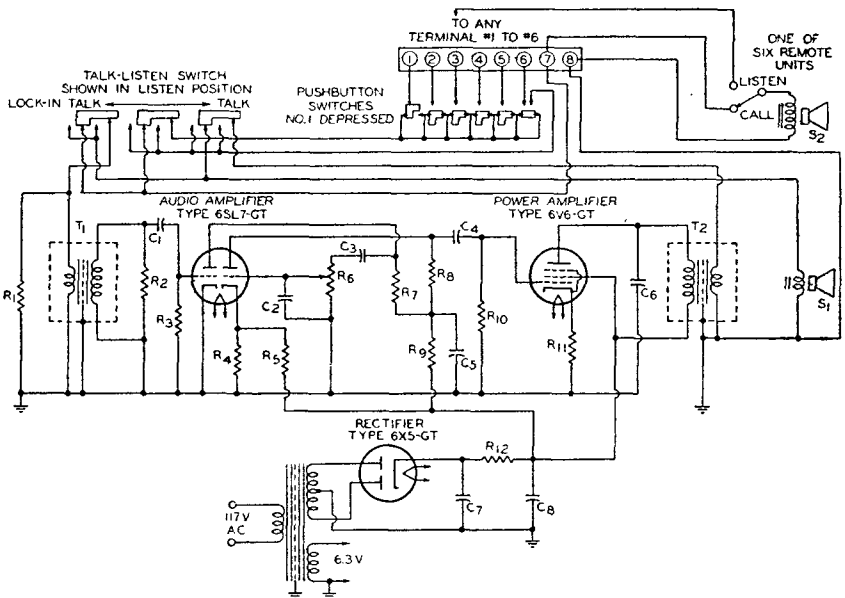

$C_1 = 0.0025 \mu\text{f}, 400 \text{ v.}$   
 $C_2 = 470 \mu\text{f}, 500 \text{ v.}$   
 $C_3 = 330 \mu\text{f}, 500 \text{ v.}$   
 $C_4 = 0.01 \mu\text{f}, 600 \text{ v.}$   
 $C_5 = 0.1 \mu\text{f}, 400 \text{ v.}$   
 $C_6 = 5600 \mu\text{f}, 500 \text{ v.}$   
 $C_7, C_8 = 20 \mu\text{f}, 350 \text{ v.}$   
 $R_1 = 12 \text{ ohms}, 0.5 \text{ watt}$   
 $R_2 = 0.47 \text{ megohm}, 0.5 \text{ watt}$

$R_3 = 10 \text{ megohms}, 0.5 \text{ watt}$   
 $R_4 = 330 \text{ ohms}, 0.5 \text{ watt}$   
 $R_5 = 56000 \text{ ohms}, 0.5 \text{ watt}$   
 $R_6 = \text{Volume control, potentiometer}, 0.5 \text{ megohm}$   
 $R_7, R_8, R_{10} = 0.33 \text{ megohm}, 0.5 \text{ watt}$   
 $R_9 = 82000 \text{ ohms}, 0.5 \text{ watt}$   
 $R_{11} = 270 \text{ ohms}, 0.5 \text{ watt}$

$R_{12} = 470 \text{ ohms}, 2 \text{ watts}$   
 $S_1, S_2 = \text{Speakers, permanent-magnet}$   
 $T_1 = \text{Input transformer, primary to secondary turns ratio } 1:47.5$   
 $T_2 = \text{Output transformer for matching impedance of voice coil to } 5000\text{-ohm tube load}$

(16-20)

ELECTRONIC VOLT-OHM METER

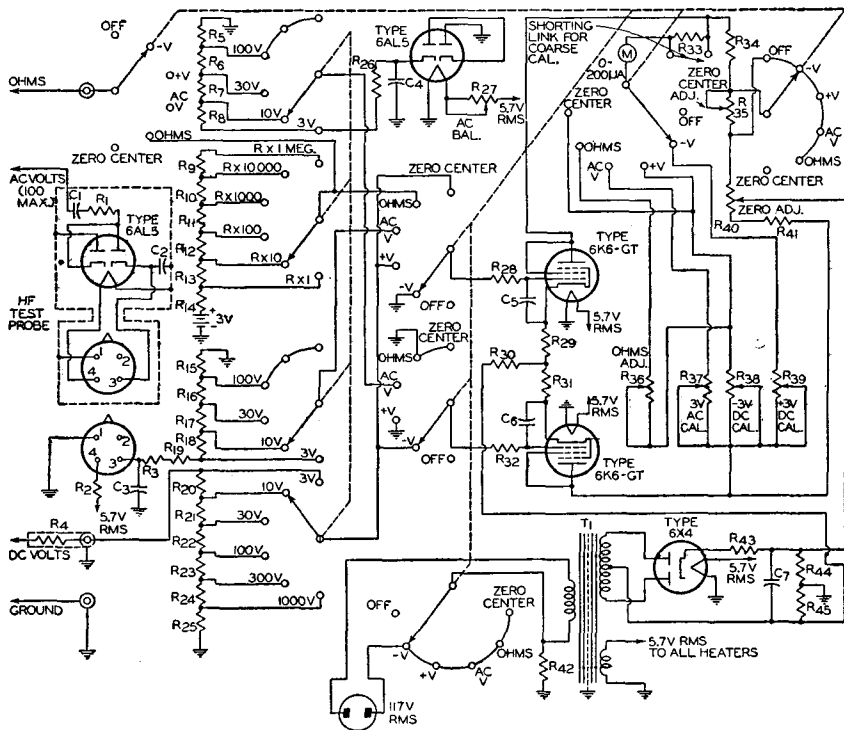

C<sub>1</sub> C<sub>2</sub> = 0.05 μf, oil-filled, 600 v.  
 C<sub>3</sub> = 47 μf, ceramic  
 C<sub>4</sub> C<sub>5</sub> C<sub>6</sub> = 3300 μf, mica  
 C<sub>7</sub> = 0.25 μf, tubular, 400 v.  
 R<sub>1</sub> = 82 ohms, 0.5 watt  
 R<sub>2</sub> = 2.4 ohms, 1 watt  
 R<sub>3</sub> R<sub>10</sub> = 3.9 megohms, 0.5 watt  
 R<sub>4</sub> = 1 megohm, 0.5 watt  
 R<sub>5</sub> = 0.12 megohm, 0.5 watt  
 R<sub>6</sub> = 0.27 megohm, 0.5 watt  
 R<sub>7</sub> = 0.91 megohm, 0.5 watt  
 R<sub>8</sub> = 3.3 megohms, 0.5 watt  
 R<sub>9</sub> = 9.9 megohms ± 1%, 0.5 watt  
 R<sub>10</sub> = 90000 ohms ± 1%, 0.5 watt  
 R<sub>11</sub> = 9000 ohms ± 1%, 0.5 watt  
 R<sub>12</sub> = 900 ohms ± 1%, 0.5 watt  
 R<sub>13</sub> = 90 ohms ± 1%, 0.5 watt  
 R<sub>14</sub> = 9.5 ohms ± 1%, 0.5 watt

R<sub>15</sub> = 0.121 megohm ± 1%, 0.5 watt  
 R<sub>16</sub> = 0.290 megohm ± 1%, 0.5 watt  
 R<sub>17</sub> = 0.830 megohm ± 1%, 0.5 watt  
 R<sub>18</sub> = 3.12 megohms ± 1%, 0.5 watt  
 R<sub>20</sub> = 7 megohms (two 3.5-megohm ± 1%, 2-watt resistors in series)  
 R<sub>21</sub> = 2 megohms ± 1%, 1 watt  
 R<sub>22</sub> = 0.70 megohm ± 1%, 0.5 watt  
 R<sub>23</sub> = 0.20 megohm ± 1%, 0.5 watt  
 R<sub>24</sub> = 70000 ohms ± 1%, 0.5 watt  
 R<sub>25</sub> = 30000 ohms ± 1%, 0.5 watt

R<sub>26</sub> = 8.2 megohms, 0.5 watt  
 R<sub>27</sub> = Potentiometer, 20 ohms, 5 watts  
 R<sub>28</sub> R<sub>32</sub> = 3.3 megohms, 0.5 watt  
 R<sub>29</sub> R<sub>31</sub> = 3000 ohms, 0.5 watt  
 R<sub>30</sub> = 39000 ohms, 0.5 watt  
 R<sub>33</sub> = 3300 ohms, 0.5 watt  
 R<sub>34</sub> R<sub>41</sub> = 18000 ohms, 0.5 watt  
 R<sub>35</sub> = Potentiometer, 30000 ohms, 2 watts  
 R<sub>36</sub> R<sub>40</sub> = Potentiometers, 7000 ohms, 2 watts  
 R<sub>37</sub> R<sub>38</sub> R<sub>39</sub> = Potentiometers, 8000 ohms, 2 watts  
 R<sub>42</sub> = 5.6 megohms, 1 watt  
 R<sub>43</sub> = 6200 ohms, 0.5 watt  
 R<sub>44</sub> = 15000 ohms, 0.5 watt  
 R<sub>45</sub> = 20000 ohms, 0.5 watt  
 T<sub>1</sub> = Power transformer, 100-100 volts rms, dc load current less than 5 ma.

(16-21)

AF VOLTAGE AMPLIFIER WITH SIGNAL MIXER, MASTER MIXER AND COMPRESSOR-EXPANDER

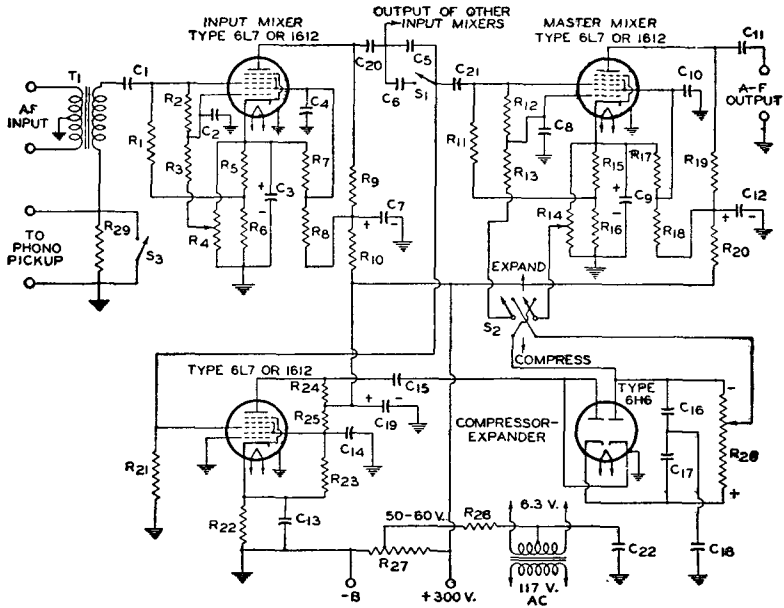

- C<sub>1</sub> C<sub>4</sub> C<sub>6</sub> C<sub>10</sub> C<sub>11</sub> C<sub>14</sub> C<sub>15</sub> C<sub>16</sub> C<sub>17</sub>
- C<sub>18</sub> C<sub>20</sub> C<sub>21</sub> = 0.05 μf
- C<sub>2</sub> C<sub>8</sub> = 0.25 μf
- C<sub>3</sub> C<sub>7</sub> C<sub>9</sub> C<sub>12</sub> = 8 μf
- C<sub>5</sub> = 0.0015 μf
- C<sub>13</sub> = 0.5 μf
- C<sub>19</sub> = 4 μf
- C<sub>22</sub> = 0.1 μf
- R<sub>1</sub> = 50000 ohms, 0.5 watt
- R<sub>2</sub> R<sub>12</sub> = 1.2 megohms, 0.5 watt
- R<sub>3</sub> R<sub>13</sub> = 820000 ohms, 0.5 watt
- R<sub>4</sub> R<sub>14</sub> = Potentiometers, 250000 ohms

- R<sub>5</sub> R<sub>15</sub> = 1000 ohms, 0.5 watt
- R<sub>6</sub> R<sub>7</sub> R<sub>16</sub> R<sub>17</sub> = 30000 ohms, 0.5 watt
- R<sub>8</sub> R<sub>18</sub> = 150000 ohms, 1 watt
- R<sub>9</sub> R<sub>19</sub> R<sub>24</sub> = 300000 ohms, 0.5 watt
- R<sub>10</sub> R<sub>20</sub> = 50000 ohms, 0.5 watt
- R<sub>11</sub> R<sub>25</sub> = 100000 ohms, 0.5 watt
- R<sub>21</sub> = 150000 ohms, 0.5 watt
- R<sub>22</sub> = 500 ohms, 0.5 watt
- R<sub>23</sub> = 40000 ohms, 0.5 watt
- R<sub>26</sub> = Potentiometer, 1 megohm

- R<sub>27</sub> = Bleeder resistor, tapped at 50 to 60 volts to provide heater-circuit bias
- R<sub>28</sub> = 100000 ohms, 0.5 watt
- R<sub>29</sub> = 5000 ohms, 0.5 watt
- S<sub>1</sub> = Switch, music-speech, single-pole, single-throw
- S<sub>2</sub> = Switch, expand-compress, double-pole, double-throw
- S<sub>3</sub> = Switch, phonograph; close when phonograph is not in use
- T<sub>1</sub> = Transformer, microphone input

NOTE 1: Potentiometer R<sub>4</sub> controls the bias on grid No.1 of the input mixer stage and thus controls the gain of this stage. When the contact is at the cathode end of R<sub>4</sub>, gain is at maximum. Because the leads to R<sub>4</sub> do not carry any voltage, R<sub>4</sub> can be connected to the circuit through a long cable for remote control. Potentiometer R<sub>14</sub> controls the no-signal gain of the master mixer stage. When the circuit is to be used as a volume expander, the contact should be set at the ground end of R<sub>14</sub>; when it is to be used as a compressor, the contact should be set at the cathode end of R<sub>14</sub>. The degree of expansion or compression can be controlled by R<sub>28</sub>. Maximum expansion or compression is obtained with the contact at the positive end. R<sub>14</sub> and R<sub>28</sub> can also be connected to the circuit through cables for remote control.

NOTE 2: Volume expander circuits are discussed on page 31 of the ELECTRON TUBE APPLICATIONS SECTION.

# Outlines

## METAL TUBES—Outlines 1-7

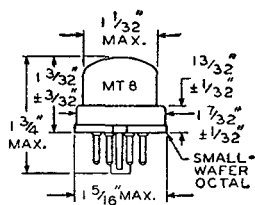

- 1 -

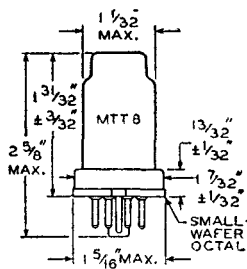

- 2 -

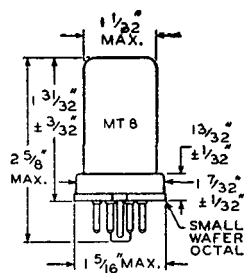

- 3 -

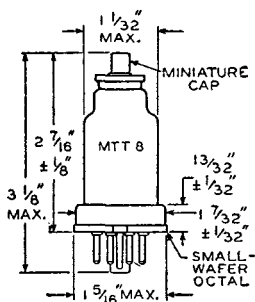

- 4 -

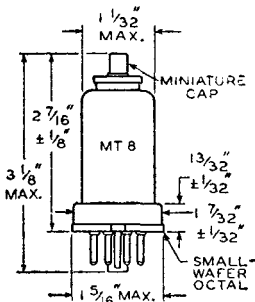

- 5 -

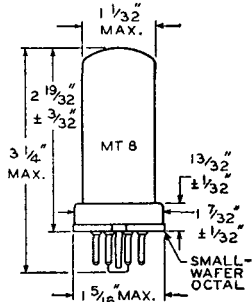

- 6 -

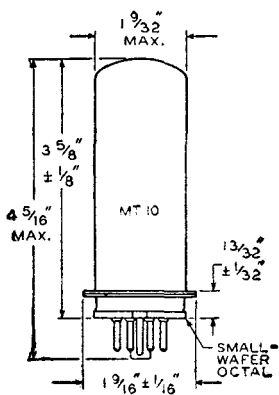

- 7 -

## GLASS TUBES—Outlines 8-19

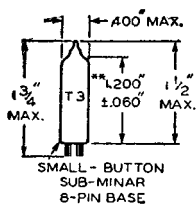

-8-

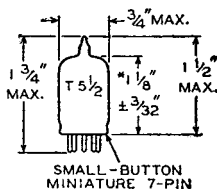

-9-

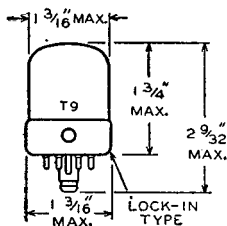

-10-

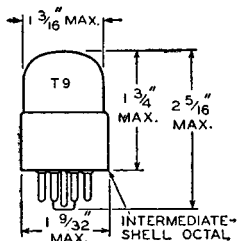

-11-

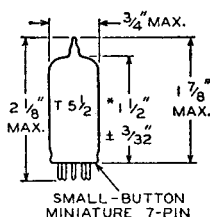

-12-

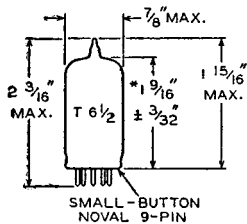

-13-

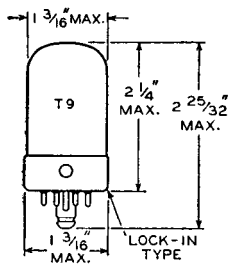

-14-

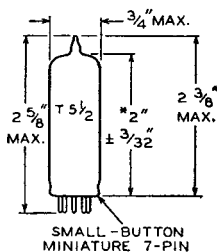

-15-

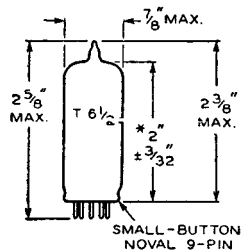

-16-

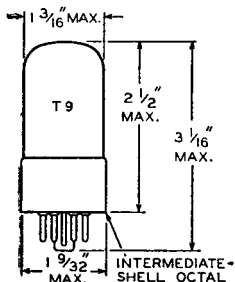

-17-

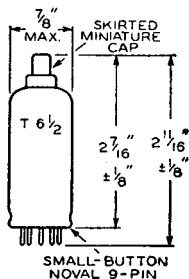

-18-

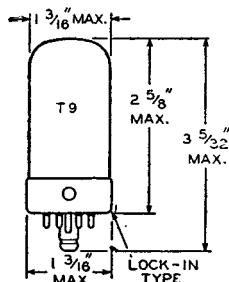

-19-

\* MEASURED FROM BASE SEAT TO BULB TOP LINE AS DETERMINED BY RING GAUGE OF 7/16" I.D.  
 \*\* MEASURED FROM BASE SEAT TO BULB TOP LINE AS DETERMINED BY RING GAUGE OF .210 I.D.

GLASS TUBES—Outlines 20-28

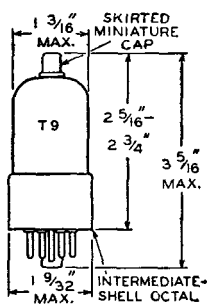

-20-

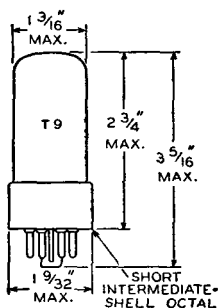

-21-

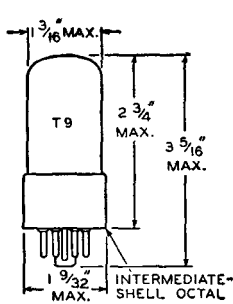

-22-

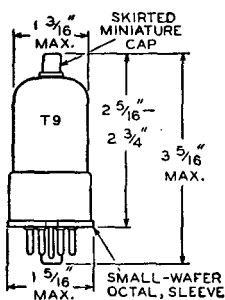

-23-

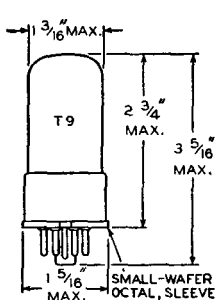

-24-

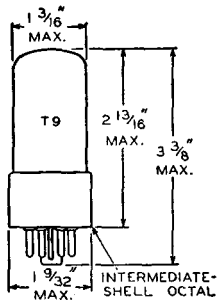

-25-

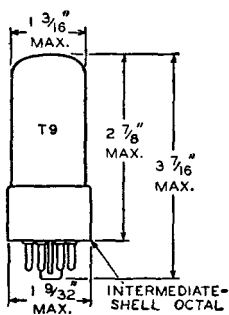

-26-

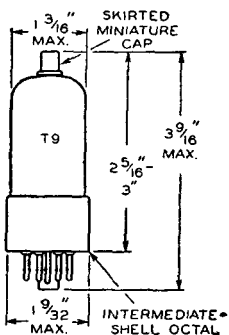

-27-

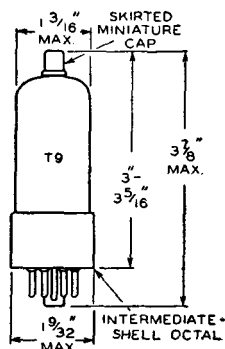

-28-



## GLASS TUBES—Outlines 29-37

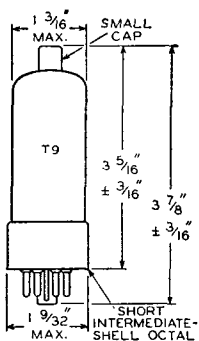

-29-

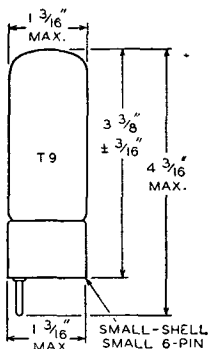

-30-

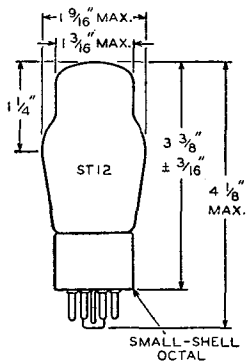

-31-

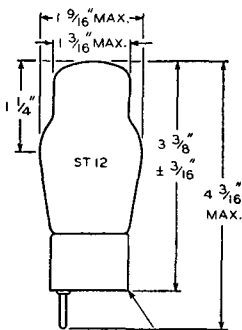

-32-

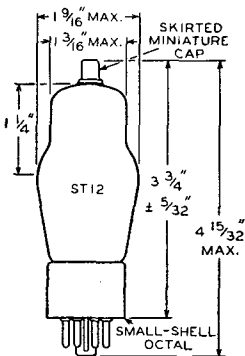

-33-

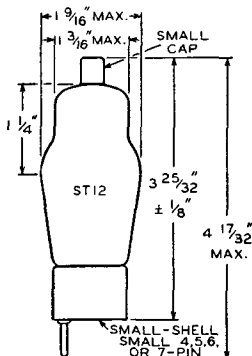

-34-

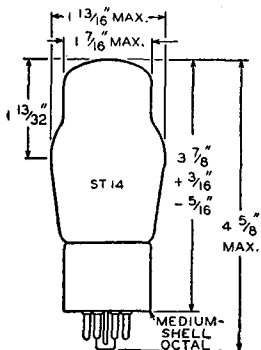

-35-

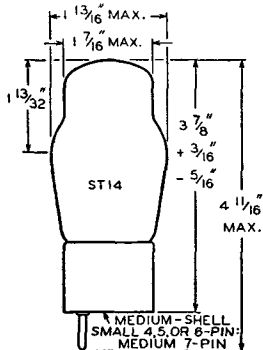

-36-

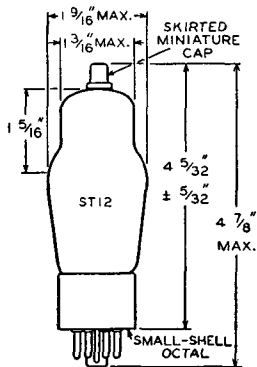

-37-

GLASS TUBES—Outlines 38-43

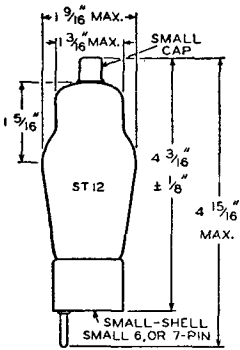

-38-

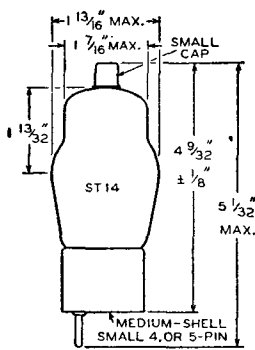

-39-

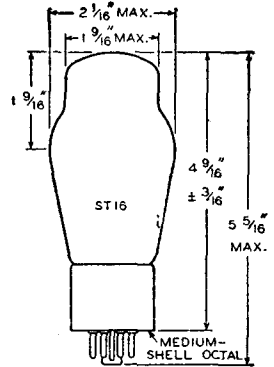

-40-

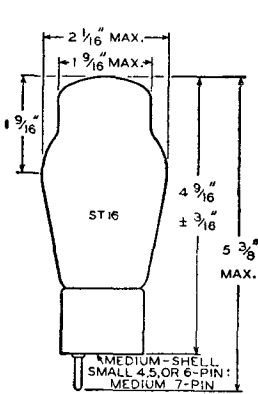

-41-

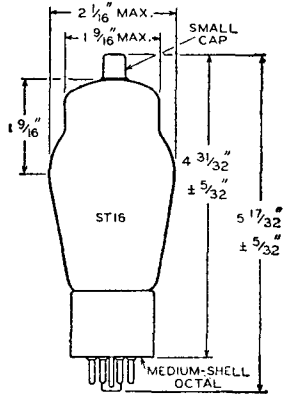

-42-

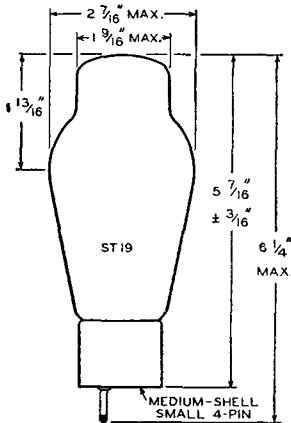

-43-

## KINESCOPIES—Outlines 44-47

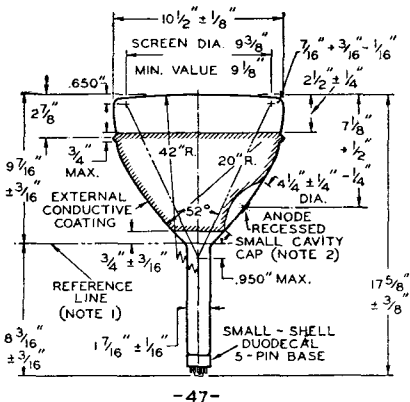
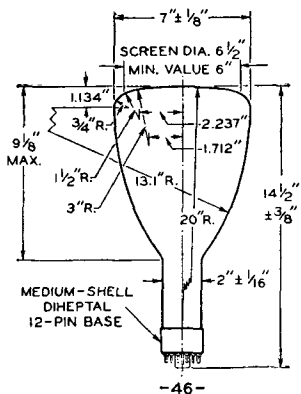
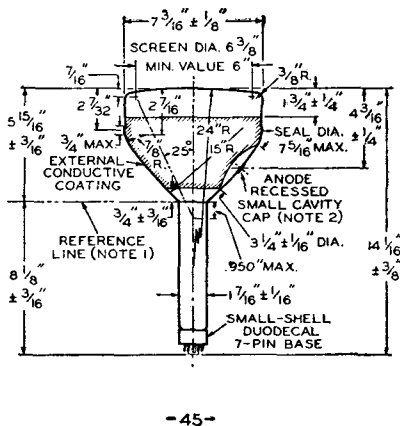
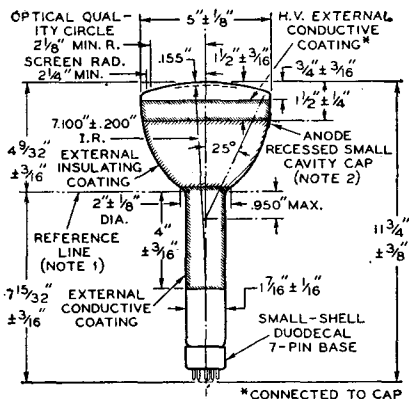

NOTE 1: Reference line is determined by position where gauge 1.500" ± .003"-.000" I.D. and 2" long will rest on bulb cone.

NOTE 2: Plane through tube axis and vacant

pin position No.3 may vary from plane through tube axis and anode terminal by an angular tolerance (measured about the tube axis) of ±10°. Anode terminal is on same side as vacant pin position No.3.

KINESCOPIES—Outlines 48-51

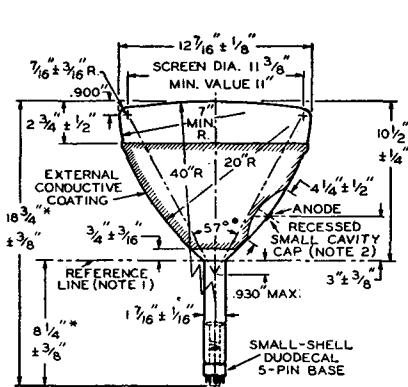

-48-

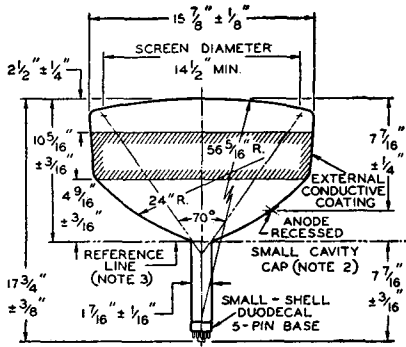

-49-

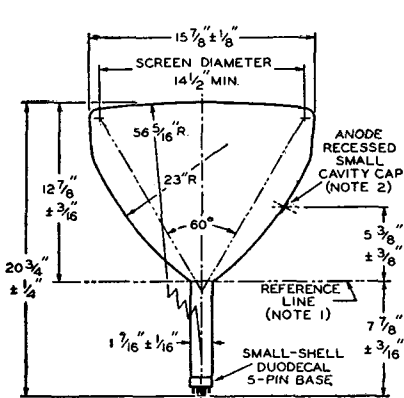

-50-

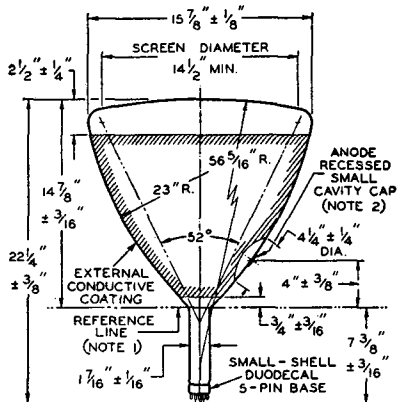

-51-

\*In type 12KP4-A, this dimension is  $1\frac{1}{8}$  inch shorter.

● In type 12KP4-A, this angle is  $54^\circ$  with vertex .950 inch from reference line.

NOTE 1: Reference line is determined by position where gauge  $1.500'' + .003'' - .000''$  I.D. and  $2''$  long will rest on bulb cone.

NOTE 2: Plane through tube axis and vacant pin position No.3 may vary from plane through

tube axis and anode terminal by an angular tolerance (measured about the tube axis) of  $\pm 10^\circ$ . Anode terminal is on same side as vacant pin position No.3.

NOTE 3: With tube neck inserted through flared end of reference-line gauge (see page 291) and with tube seated in gauge, the reference line is determined by the intersection of the plane CC' of the gauge with the glass funnel.

KINESCOPES—Outlines 52-54

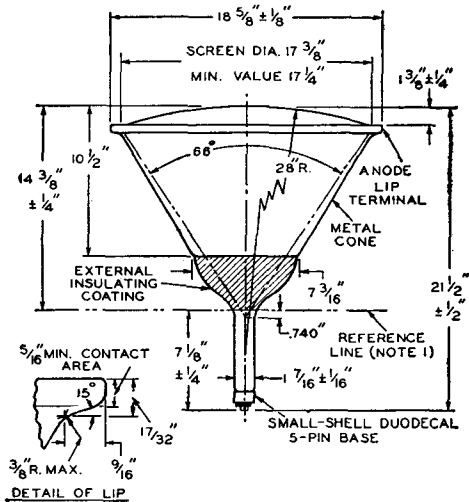
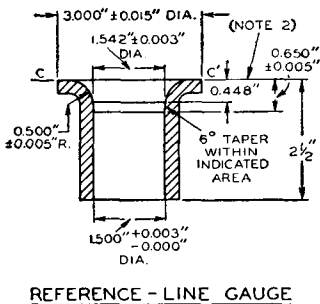
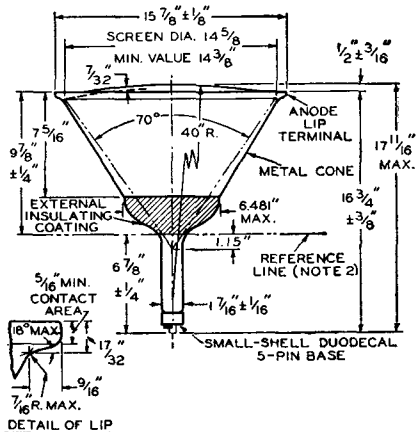
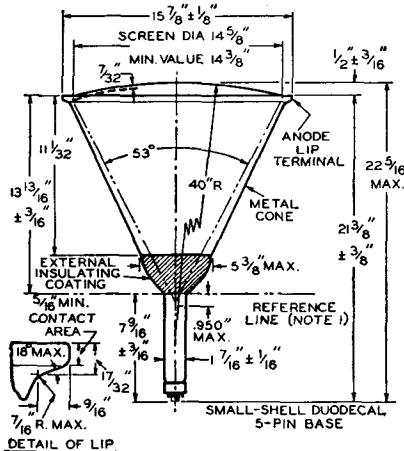

NOTE 1: Reference line is determined by position where hinged gauge 1.500" + .003" - .000" I.D. and 2" long will rest on bulb cone.

NOTE 2: With tube neck inserted through

flared end of reference-line gauge (above) and with tube seated in gauge, the reference line is determined by the intersection of the plane CC' of the gauge with the glass funnel.

KINESCOPIES—Outline 55

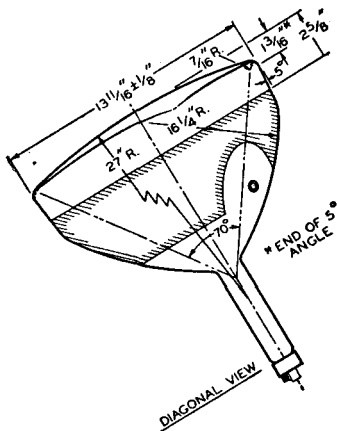
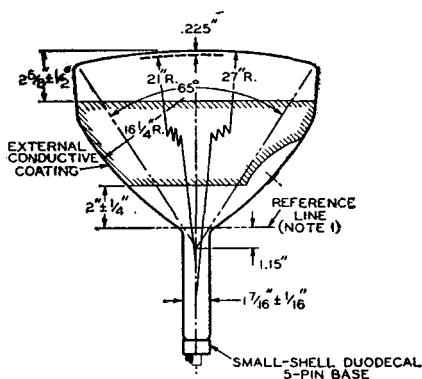
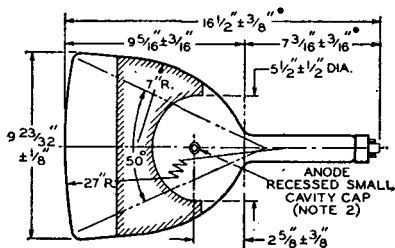
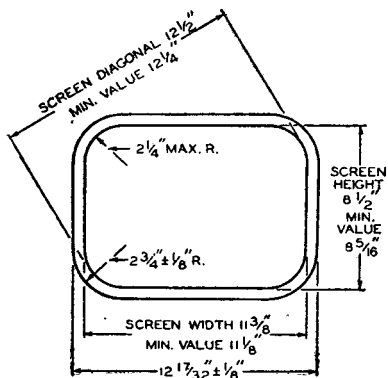

-55-

•In type 14CP4, this dimension is  $\frac{1}{4}$  inch longer.

NOTE 1: With tube neck inserted through flared end of reference-line gauge (see page 291) and with tube seated in gauge, the reference line is determined by the intersection of the plane CC' of the gauge with the glass funnel.

NOTE 2: Plane through tube axis and vacant pin position No.6 may vary from plane through tube axis and anode terminal by angular tolerance (measured about the tube axis) of  $\pm 30^\circ$ . Anode terminal is on same side as vacant pin position No.6.

KINESCOPIES—Outline 56

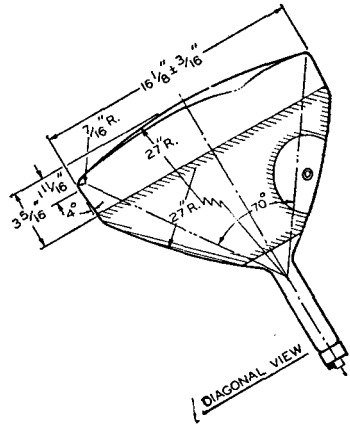
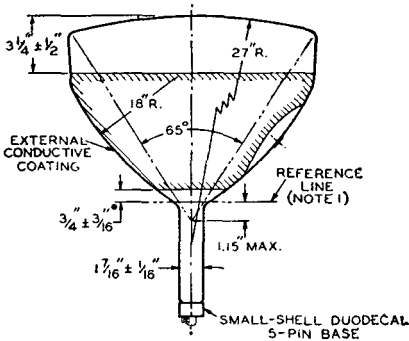
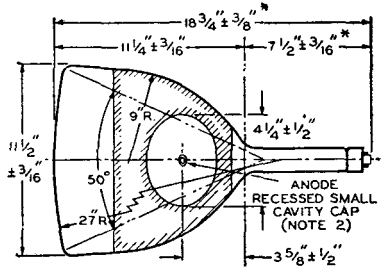
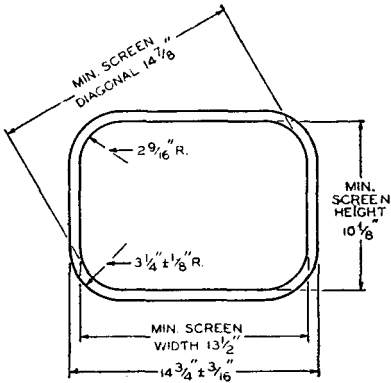

-56-

\*In type 16TP4, this dimension is  $\frac{5}{8}$  inch shorter.

• In type 16KP4, this dimension is 2 inches.

NOTE 1: With tube neck inserted through flared end of reference-line gauge (see page 291) and with tube seated in gauge, the reference line is determined by the intersection of the plane

CC' of the gauge with the glass funnel.

NOTE 2: Plane through tube axis and vacant pin position No.6 may vary from plane through tube axis and anode terminal by angular tolerance (measured about the tube axis) of  $\pm 30^\circ$ . Anode terminal is on same side as vacant pin position No.6.

KINESCOPIES—Outline 57

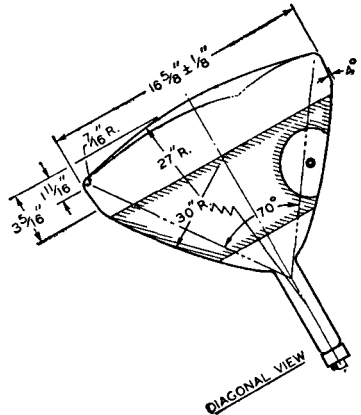
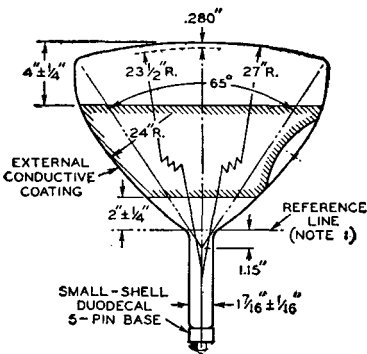
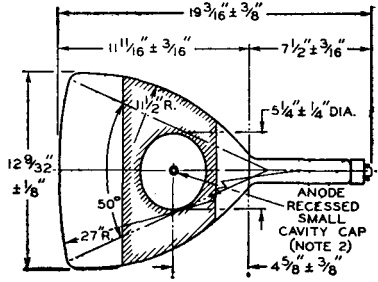
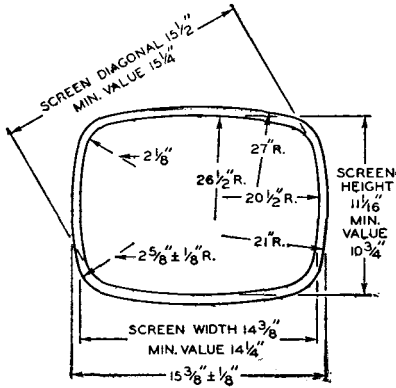

-57-

NOTE 1: With tube neck inserted through flared end of reference-line gauge (see page 291) and with tube seated in gauge, the reference line is determined by the intersection of the plane CC' of the gauge with the glass funnel.

NOTE 2: Plane through tube axis and vacant pin position No.6 may vary from the plane through the tube axis and anode terminal by an angular tolerance (measured about the tube axis) of  $\pm 30^\circ$ . Anode terminal is on same side as vacant pin position No.6.



KINESCOPIES—Outline 58

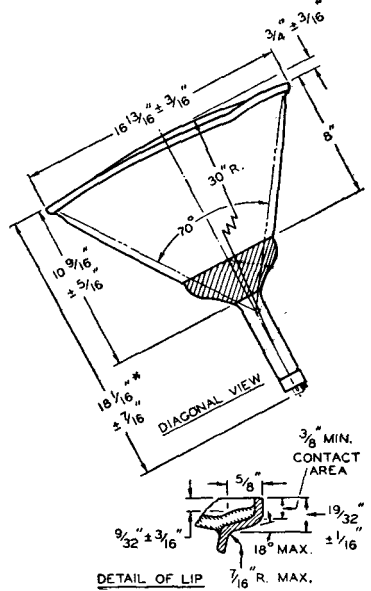
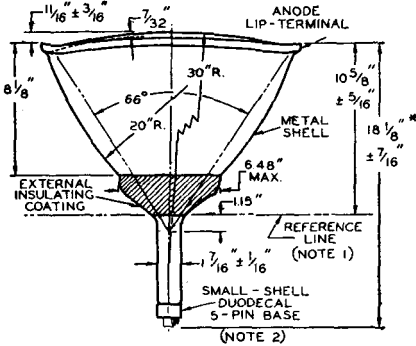
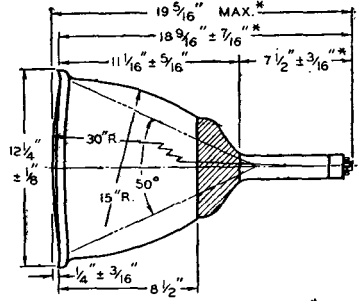
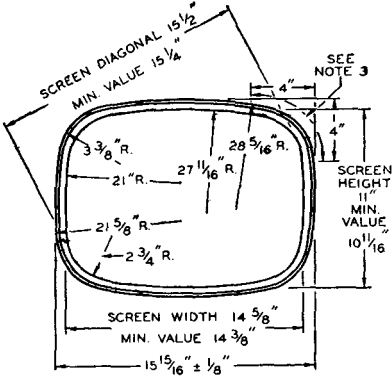

\*In types 17CP4 and 17CP4-A, this dimension is  $\frac{5}{16}$  inch shorter.

NOTE 1: With tube neck inserted through flared end of reference-line gauge (see page 291) and with tube seated in gauge, the reference line is determined by the intersection of the plane CC' of the gauge with the glass funnel.

NOTE 2: Plane through tube axis and pin position No.6 may vary from the horizontal axis of glass face by an angular tolerance (measured about the tube axis) of  $\pm 10^\circ$ . Types 17GP4 and 17TP4 have 6-pin base.

NOTE 3: Support tube by lip only at corners within this space.

KINESCOPIES—Outline 59

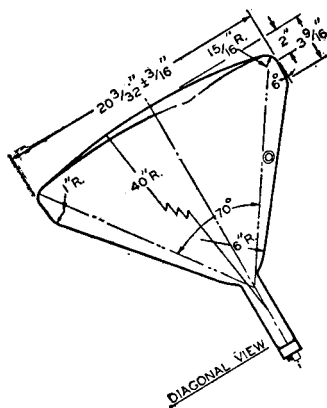
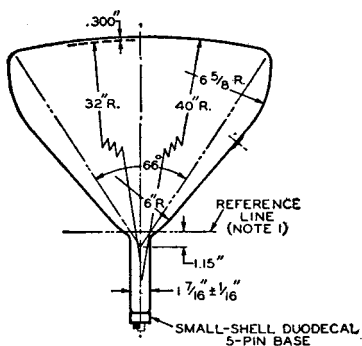
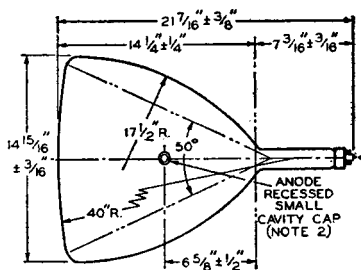
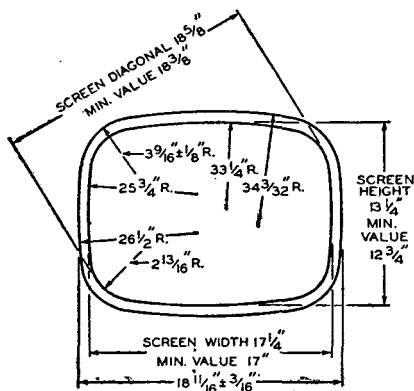

-59-

NOTE 1: With tube neck inserted through flared end of reference-line gauge (see page 291) and with tube seated in gauge, the reference line is determined by the intersection of the plane CC' of the gauge with the glass funnel.

NOTE 2: Plane through tube axis and vacant pin position No.6 may vary from the plane through the tube axis and anode terminal by an angular tolerance (measured about the tube axis) of  $\pm 30^\circ$ . Anode terminal is on same side as vacant pin position No.6.



*Notes:*

- 1 – Metal Envelope
- 2 – Spacer Shield
- 3 – Insulating Spacer
- 4 – Mount Support
- 5 – Control Grid
- 6 – Coated Cathode
- 7 – Screen
- 8 – Heater
- 9 – Suppressor
- 10 – Plate
- 11 – Batalum Getter
- 12 – Conical Stem Shield
- 13 – Header
- 14 – Glass Seal
- 15 – Header Insert
- 16 – Glass-Button Stem Seal
- 17 – Cylindrical Base Shield
- 18 – Header Skirt
- 19 – Lead Wire
- 20 – Crimped Lock
- 21 – Octal Base
- 22 – Exhaust Tube
- 23 – Base Pin

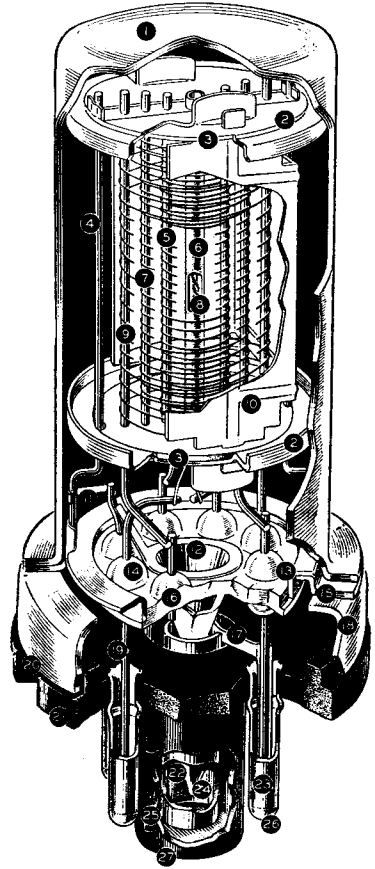

1¾ times actual size

- 24 – Exhaust Tip
- 25 – Aligning Key
- 26 – Solder
- 27 – Aligning Plug

## Structure of a Metal Tube



# INDEX

	<i>Page</i>		<i>Page</i>
<b>A</b> dmittance, Input .....	15	plate resistance .....	12
<b>A</b> mplification Factor ( $\mu$ ) .....	12	power output .....	17, 21, 23
<b>A</b> mplifier:		power sensitivity .....	12
audio-frequency .....	14	transconductance .....	12, 28, 29
audio mixer, circuit .....	279, 283	voltage amplification (gain) .....	14, 28, 30
cathode follower .....	28	<b>C</b> apacitor-Input Filter .....	54
class A .....	13, 14, 16	<b>C</b> athode:	
class A <sub>1</sub> , circuit .....	274, 275, 276, 280	bias .....	51
class AB .....	13, 22	bypassing .....	51
class AB <sub>1</sub> .....	22	connection .....	50
class AB <sub>1</sub> , circuit .....	277	current .....	51
class AB <sub>2</sub> .....	25	directly heated .....	4
class AB <sub>2</sub> , circuit .....	278	follower .....	28
class B .....	13, 25	indirectly heated .....	4
class B, circuit .....	279	resistor .....	51
class C .....	13	types .....	3
dc .....	43	<b>C</b> haracteristic Curves, Interpretation of ...	59
limiter .....	32, 39	<b>C</b> haracteristics:	
parallel .....	17	amplification factor .....	12
phase-inverter .....	31	control-grid-plate transconductance .....	12
push-pull .....	17, 19, 22, 25	conversion transconductance .....	12
radio-frequency .....	13, 16	dynamic .....	12
remote-cutoff .....	15, 43	plate resistance .....	12
sharp-cutoff .....	43	static .....	11
voltage .....	14	<b>C</b> harts and Tables:	
voltage-compressor circuit .....	283	materials chart .....	262
volume-expander .....	31	outline drawings .....	284
volume-expander, circuit .....	283	preferred types list .....	Inside Back Cover
<b>A</b> mplitude Modulation (AM) .....	35	resistance-coupled amplifiers .....	246
<b>A</b> node .....	5	structure of a kinscope gun .....	2
<b>A</b> node-Grid .....	45	structure of metal tube .....	295
<b>A</b> rc-Back Limit .....	58	structure of miniature tube .....	64
<b>A</b> utomatic Frequency Control (AFC) .....	46	tube classification by use and by filament	
<b>A</b> utomatic Volume Control (AVC) .....	40	or heater voltage .....	62
<b>B</b> eam Power Tube Considerations .....	8	tube-part materials .....	241
<b>B</b> ias:		types not recommended for new	
battery .....	51	equipment design .....	Inside Back Cover
cathode (self) .....	51	<b>C</b> hock-Input Filter .....	54
diode .....	37	<b>C</b> ircuit Diagram of:	
grid-resistor .....	38, 51, 52	ac/dc superheterodyne receiver (16-4) ..	267
self (cathode) .....	51	ac-operated regenerative short-wave	
<b>C</b> alculation of:		receiver (16-7) .....	270
amplification factor .....	12	ac-operated superheterodyne receiver	
cathode (self-bias) resistor .....	51	(16-3) .....	266
cathode load resistor .....	29, 30	af voltage amplifier with signal	
control-grid-plate transconductance .....	12	mixer, master mixer, and compressor-	
filament resistor power dissipation .....	48	expander (16-21) .....	283
filament (or heater) resistor value .....	48	audio mixer (16-16) .....	279
harmonic distortion .....	18, 19, 21, 24	automobile receiver (16-5) .....	268
load resistance .....	20, 21, 23	battery-operated short-wave receiver	
operating conditions from conversion		(16-8) .....	271
curves .....	21	class A audio amplifier (16-10) .....	274
peak inverse plate voltage .....	58	class B amplifier for mobile use (16-15) ..	279
plate efficiency .....	12	code practice oscillator (16-18) .....	280
		electronic volt-ohm meter (16-20) .....	282
		FM tuner (16-9) .....	272

# INDEX (Continued)

	<i>Page</i>		<i>Page</i>
high-fidelity audio amplifier		<b>Electron:</b>	
class A <sub>1</sub> —10 watts (16-12).....	276	considerations.....	3
high-power audio amplifier:		secondary.....	8, 9
class AB <sub>1</sub> —25 watts (16-13).....	279	Electron Tube Applications.....	18
class B—45 watts (16-14).....	278	Electron Tube Characteristics.....	11
intercommunication set (16-19).....	261	Electron Tube Installation.....	47
microphone and phonograph amplifier—		Electron Tube Testing.....	242
6 watts (16-11).....	275	Electrons, Electrodes, and Electron Tubes	3
non-motorboating resistance-coupled		Electron-Ray Tubes.....	42
amplifier (16-17).....	280	Emission:	
portable superheterodyne receiver		current.....	5
(16-1).....	264	secondary.....	8, 9
portable 3-way superheterodyne		test.....	243
receiver (16-2).....	265	<b>Feedback:</b>	
superregenerative receiver (16-6).....	269	inverse.....	25
Conversion Curves, Use of.....	21	undesired.....	54
Conversion Transconductance.....	12	<b>Filament (also see Heater and Cathode):</b>	
Corrective Filter.....	30	operation.....	3, 47
Cross-Modulation.....	15, 52	resistor.....	48
Current:		series operation.....	48
cathode.....	51	shunt resistor.....	49
dc output.....	59	supply voltage.....	47
grid.....	13, 22	<b>Filter:</b>	
peak plate.....	59	capacitor-input.....	55
plate.....	5	choke-input.....	55
Curves, Interpretation of Characteristic..	59	corrective.....	30
Cutoff.....	15	radio-frequency.....	55
<b>DC Amplifier</b> .....	43	smoothing.....	55
Degeneration (See Inverse Feedback)		<b>Formulas (see Calculation)</b>	
Delayed Automatic Volume Control		<b>Frequency Conversion</b> .....	44
(DAVC).....	41	<b>Frequency Modulation (FM)</b> .....	35, 38
Demodulation.....	35	<b>Full-Wave Diode Detection</b> .....	36
Design-Center System of Ratings.....	59	<b>Full-Wave Rectifier</b> .....	5, 33
Detection:		<b>Fuses, Use of</b> .....	50
diode.....	35	<b>Gain (Voltage Amplification)</b> .....	14
discriminator.....	38	<b>Grid:</b>	
full-wave diode.....	36	anode.....	45
grid bias.....	38	bias.....	51
grid-resistor and capacitor.....	38	bias detection.....	38
ratio detector.....	39	considerations.....	6
Diode:		current.....	13, 22
biasing.....	37	resistor.....	14, 51
considerations.....	5	resistor and capacitor detection.....	38
detection.....	35	voltage supply.....	50
load resistor.....	36	<b>Grid-Plate Capacitance</b> .....	7
Discriminator.....	38	<b>Grid-Plate Transconductance</b> .....	12
Dress of Circuit Leads.....	54	<b>Half-Wave Rectifier</b> .....	5, 33
Driver.....	16, 22, 25	<b>Harmonic Distortion</b> .....	18, 19, 21, 24
Dynamic Characteristics.....	12		



## INDEX (Continued)

	<i>Page</i>	<i>Page</i>
<b>Heater:</b>		
cathode.....	4	
cathode bias.....	51	
cathode connection.....	50	
resistor.....	51	
series operation.....	48	
shunt resistor.....	49	
supply voltage.....	47	
<b>Hexode Mixer.....</b>	<b>46</b>	
<b>Impedance, Input.....</b>	<b>15</b>	
<b>Input Capacitance.....</b>	<b>13</b>	
<b>Instantaneous Peak Voltage.....</b>	<b>55</b>	
<b>Interelectrode Capacitances.....</b>	<b>7, 13</b>	
<b>Intermediate Frequency, Production of... </b>	<b>44</b>	
<b>Interpretation of Tube Data.....</b>	<b>58</b>	
<b>Inverse Feedback:</b>		
constant-current type.....	26, 27	
constant-voltage type.....	26	
<b>Key to Socket Connection</b>		
Diagrams.....	Inside Front Cover	
<b>Kinescope:</b>		
corona considerations.....	57	
deflection.....	11	
dust considerations.....	57	
essential elements.....	10	
handling precautions.....	57	
high-voltage considerations.....	56	
humidity considerations.....	56	
safety considerations.....	57	
screen.....	11	
structure.....	2, 10	
x-ray radiation precautions.....	57	
<b>Kinescope Gun Structure.....</b>	<b>2</b>	
<b>Limiters.....</b>	<b>32, 39</b>	
<b>Load:</b>		
resistance.....	20, 21, 23	
resistance line.....	17, 19, 20, 22	
<b>Materials Chart.....</b>	<b>262</b>	
<b>Metal Tube, Structure of.....</b>	<b>299</b>	
<b>Mercury-Vapor Rectifier:</b>		
considerations.....	6	
interference from.....	55	
<b>Mho.....</b>	<b>12</b>	
<b>Micromho.....</b>	<b>12</b>	
<b>Miniature Tube, Structure of.....</b>	<b>64</b>	
<b>Mixer:</b>		
audio.....	279, 283	
hexode.....	46	
pentagrid.....	45	
<b>Modulated Wave.....</b>	<b>35, 38</b>	
<b>Modulation.....</b>	<b>35</b>	
<b>Modulation-Distortion.....</b>	<b>15, 53</b>	
<b>Multi-Electrode Tube.....</b>	<b>9</b>	
<b>Multi-Unit Tubes.....</b>	<b>9</b>	
<b>Multivibrator.....</b>	<b>44</b>	
<b>Mutual Conductance</b>		
(see Transconductance)		
<b>Oscillator:</b>		
considerations.....	43	
multivibrator.....	44	
relaxation.....	43	
<b>Outlines of Tubes.....</b>	<b>284</b>	
<b>Output Capacitance.....</b>	<b>13</b>	
<b>Output-Coupling Devices.....</b>	<b>56</b>	
<b>Parallel Operation.....</b>	<b>17</b>	
<b>Parasitic Oscillations.....</b>	<b>17</b>	
<b>Peak Inverse Plate Voltage.....</b>	<b>58</b>	
<b>Peak Plate Current.....</b>	<b>59</b>	
<b>Pentagrid Converter.....</b>	<b>9, 45</b>	
<b>Pentagrid Mixer.....</b>	<b>31, 46</b>	
<b>Pentode Considerations.....</b>	<b>8</b>	
<b>Phase Inverter.....</b>	<b>31, 248</b>	
<b>Plate:</b>		
current.....	5	
dissipation.....	58	
efficiency.....	12	
load.....	20, 21, 23	
resistance.....	12	
voltage supply.....	50	
<b>Plate-Cathode Capacitance.....</b>	<b>7, 13</b>	
<b>Power Output:</b>		
calculations.....	17, 21, 23	
test.....	244	
<b>Power Sensitivity.....</b>	<b>12</b>	
<b>Power Supply.....</b>	<b>51</b>	
<b>Preferred Types List.....</b>	<b>Inside Back Cover</b>	
<b>Push-Pull Operation.....</b>	<b>17, 19, 22, 25</b>	
<b>Radio-Frequency:</b>		
amplifier.....	13, 16	
filter.....	55	
<b>Ratings, Design-Center System.....</b>	<b>59</b>	
<b>Ratio Detector.....</b>	<b>39</b>	
<b>Reading List.....</b>	<b>320</b>	

# INDEX (Continued)

	<i>Page</i>		<i>Page</i>
Receiving Tube Classification Chart.....	62	<b>T</b> ables and Charts:	
Recently Added Tube Types.....	305	(see Charts and Tables)	
<b>Rectifiers:</b>		Technical Data for Tube Types.....	65, 305
full-wave.....	5, 33	Testing Electron Tubes.....	242
half-wave.....	5, 33	Tetrode Considerations.....	7
ionic-heated cathode.....	6	Transconductance:	
parallel operation of.....	33	conversion.....	12
voltage doubler.....	34	grid-plate.....	12
Relaxation Oscillator.....	43	test.....	243
Remote-Cutoff Tubes.....	15, 43	Triode Considerations.....	6
Resistance Coupling.....	14	<b>T</b> ube:	
Resistance-Coupled Amplifier.....	27, 31, 246	materials chart.....	262
<b>Resistor:</b>		outlines.....	284
cathode (self-biasing).....	51	ratings, interpretation of.....	58
center tap.....	51	structure of a kinescope gun.....	2
filament.....	48	structure of metal.....	299
filter.....	55	structure of <i>miniature</i> .....	64
grid.....	14	tester requirements.....	245
plate load.....	20, 21, 23	Tube Types:	
screen.....	53	technical data.....	65, 305
<b>S</b> aturation Current.....	5	Tuning Indicators.....	42
Screen (Grid No. 2):		<b>T</b> win Diode:	
considerations.....	7	pentode.....	10
input.....	58	triode.....	10, 36
voltage supply.....	53	Typical Operation Values,	
Secondary Emission.....	8	Interpretation of.....	59, 61
Secondary Electrons.....	8, 9	<b>V</b> oltage:	
Self-bias (cathode bias).....	51	amplification, class A.....	13
Shielding.....	54	doubler rectifier.....	34
Short-Circuit Test.....	242	peak heater-cathode.....	58
Socket Connection Diagrams,		peak inverse plate.....	58
Key to.....	Inside Front Cover	supply.....	47
Space Charge.....	5, 9	Voltage Conversion Factor.....	21
Static Characteristics.....	11	Voltage Doubler.....	34
Structure of a Metal Tube.....	299	Volume Control:	
Structure of a Miniature Tube.....	64	automatic (AVC).....	40
Suppressor (Grid No. 3).....	8	by grid-voltage variation.....	52
Symbols Used in Resistance-Coupled		by screen-voltage variation.....	53
Amplifier Charts.....	247	delayed automatic (DAVC).....	41
		Volume Expander.....	31, 283
		<b>Z</b> ero-Bias Operation.....	51

# Recently Added RCA Tube Types

This section contains technical descriptions of tubes that have been recently added to the RCA line.

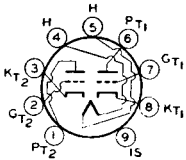

## MEDIUM-MU TWIN TRIODE

# 6BQ7

Miniature type used as first rf amplifier in tuners of vhf television receivers or as low-noise if pre-amplifier tube in uhf television receivers employing a crystal mixer. It is especially useful

in the rf stage of television receivers utilizing a driven grounded-grid amplifier of the direct-coupled type or in push-pull grounded-grid rf amplifiers. Outline 13, OUTLINES SECTION. Tube requires noval nine-contact socket and may be mounted in any position.

HEATER VOLTAGE (AC/DC) .....	6.3	volts
HEATER CURRENT .....	0.4	ampere
DIRECT INTERELECTRODE CAPACITANCES (Approx.): <sup>o</sup>		

	Triode Unit T <sub>1</sub>	Triode Unit T <sub>2</sub>	
Grid to Plate .....	1.15	1.15	$\mu\mu\text{f}$
Input .....	2.85	-	$\mu\mu\text{f}$
Input (Grounded Grid) .....	-	4.95	$\mu\mu\text{f}$
Output .....	1.35	-	$\mu\mu\text{f}$
Output (Grounded Grid) .....	-	2.27	$\mu\mu\text{f}$
Plate to Cathode .....	0.15 max	0.15 max	$\mu\mu\text{f}$
Heater to Cathode .....	2.20	2.30	$\mu\mu\text{f}$
Plate of Unit No.1 to Plate of Unit No.2 .....	0.010 max		$\mu\mu\text{f}$
Plate of Unit No.2 to Plate and Grid of Unit No.1 .....	0.024 max		$\mu\mu\text{f}$

### CLASS A<sub>1</sub> AMPLIFIER (Each Unit)

#### Maximum Ratings:

PLATE VOLTAGE .....	250*max	volts
PLATE DISSIPATION .....	2 max	watts
CATHODE CURRENT .....	20 max	ma
PEAK HEATER-CATHODE VOLTAGE:		
Heater negative with respect to cathode .....	200*max	volts
Heater positive with respect to cathode .....	200 max	volts

#### Characteristics:

Plate Voltage .....	150	volts
Cathode-Bias Resistor .....	220	ohms
Amplification Factor .....	35	
Plate Resistance .....	5800	ohms
Transconductance .....	6000	$\mu\text{mhos}$
Plate Current .....	9	ma
Grid Bias (Approx.) for plate current of 10 $\mu\text{a}$ .....	-10	volts

<sup>o</sup> With external shield connected to cathode.

\* Under cutoff conditions, in grounded-grid circuits with direct-coupled drive, it is permissible for this voltage to be as high as 300 volts.

AVERAGE PLATE CHARACTERISTICS FOR EACH UNIT

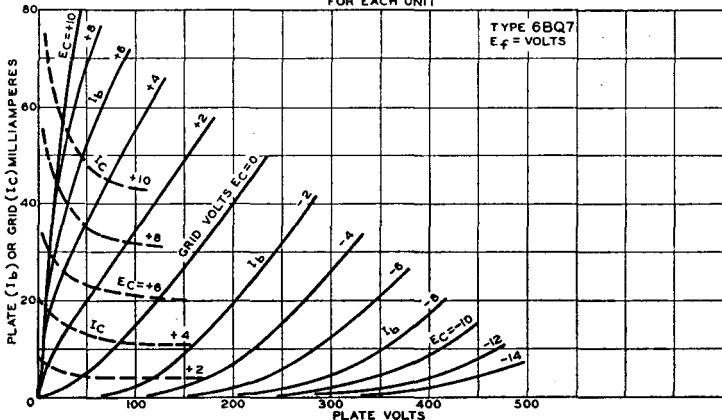

92CM-7536T

## TRIODE-PENTODE CONVERTER

# 6X8

Miniature type used as combined oscillator and mixer tube in television receivers utilizing an intermediate frequency in the order of 40 megacycles per second. In such service, the 6X8

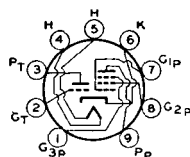

gives performance comparable to that obtainable with a 6AG5 mixer and an oscillator consisting of one unit of a type 6J6. When used in an AM/FM receiver, the triode unit is used as an oscillator for both sections. In the AM section, the pentode unit is used as a high-gain pentode mixer; in the FM section, the pentode unit is used either as a pentode mixer or as a triode-connected mixer depending on signal-to-noise considerations. Outline 13, OUTLINES SECTION. Tube requires noval nine-contact socket and may be mounted in any position.

HEATER VOLTAGE..... 6.3 volts  
 HEATER CURRENT..... 0.45 ampere

**DIRECT INTERELECTRODE CAPACITANCES (Approx.):**

	<i>Without External Shield</i>	<i>With External Shield</i>	
<b>TRIODE UNIT:</b>			
Grid to Plate.....	1.4	1.4	$\mu\text{f}$
Input.....	2.0	2.6	$\mu\text{f}$
Output.....	0.5	1.0	$\mu\text{f}$
<b>PENTODE UNIT:</b>			
Grid No.1 to Plate.....	0.09 max	0.06 max	$\mu\text{f}$
Input.....	4.3	4.5	$\mu\text{f}$
Output.....	0.7	1.4	$\mu\text{f}$
Pentode Grid No.1 to Triode Plate.....	0.045 max	0.035 max	$\mu\text{f}$
Pentode Plate to Triode Plate.....	0.040 max	0.008 max	$\mu\text{f}$

**Characteristics:**

	<i>Triode Unit</i>	<i>Pentode Unit</i>	
Plate Voltage.....	100	250	volts
Grid No.3 (Suppressor).....	-	Connected to cathode at socket	
Grid-No.2 Voltage.....	-	150	volts
Cathode-Bias Resistor.....	100	200	ohms
Amplification Factor.....	40	-	
Plate Resistance (Approx.).....	6900	750000	ohms
Transconductance.....	5800	4600	$\mu\text{mhos}$

AVERAGE PLATE CHARACTERISTICS  
 TRIODE UNIT

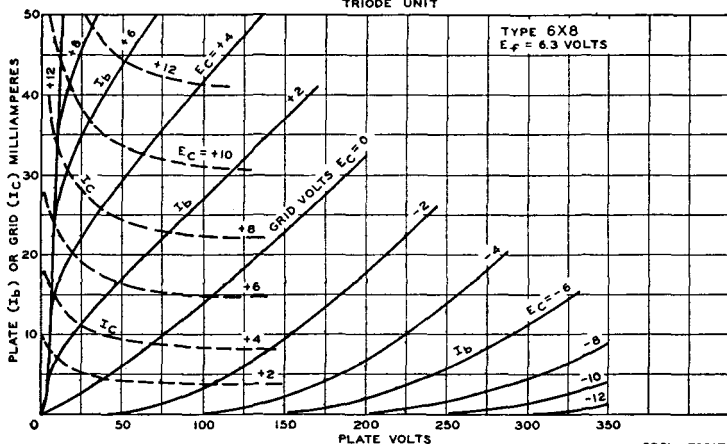

92CM-75317

# RCA RECEIVING TUBE MANUAL

Grid-No.1 Bias for plate current of 10 $\mu$ a .....	-10	-10	volts
Plate Current .....	8.5	7.7	ma
Grid-No.2 Current .....	-	1.6	ma

## CONVERTER SERVICE

Maximum Ratings:	<i>Triode Unit as Osc.</i>	<i>Pentode Unit as Mixer</i>	
PLATE VOLTAGE .....	250 max	250 max	volts
GRID-NO.2 (SCREEN) VOLTAGE .....	-	150 max	volts
<b>GRID-NO.1 (CONTROL-GRID) VOLTAGE:</b>			
Negative bias value .....	40 max	40 max	volts
Positive bias value .....	0 max	0 max	volts
PLATE DISSIPATION .....	1.5 max	2.0 max	watts
GRID-NO.2 INPUT .....	-	0.4 max	watt
GRID-NO.1 INPUT .....	0.5 max	-	watt
<b>PEAK HEATER-CATHODE VOLTAGE:</b>			
Heater negative with respect to cathode .....	100 max	100 max	volts
Heater positive with respect to cathode .....	140 max	100 max	volts

Typical Operation:	<i>Triode Unit as 250-Mc Osc.</i>	<i>Pentode Unit as Mixer*</i>	
Plate Voltage .....	150	150	volts
Grid No.3 .....	-	<i>Connected to cathode at socket</i>	
Grid-No.2 Voltage .....	-	150	volts
Mixer Grid-No.1 Supply Voltage .....	-	-3.5	volts
Oscillator Voltage at Mixer Grid No.1 .....	-	2.6 rms	volts
Mixer Grid-No.1-Circuit Resistance .....	-	120000	ohms
Oscillator Grid Resistor .....	2700	-	ohms
Conversion Transconductance .....	-	2100	$\mu$ mhos
Plate Current .....	13	6.2	ma
Grid-No.2 Current .....	-	1.8	ma
Grid-No.1 Current .....	-	2.0	$\mu$ a
Oscillator Power Output (Approx.) .....	0.5†	-	watt

### Maximum Circuit Values:

<b>Grid-No.1-Circuit Resistance:</b>			
For fixed-bias operation .....	0.1 max		megohm
For cathode-bias operation .....	0.5 max		megohm

\*With separate excitation and triode unit grounded.

†In TV or FM receivers, it is generally desirable to operate the oscillator with less power input than shown in the tabulated data in order to avoid over-excitation and excessive oscillator radiation.

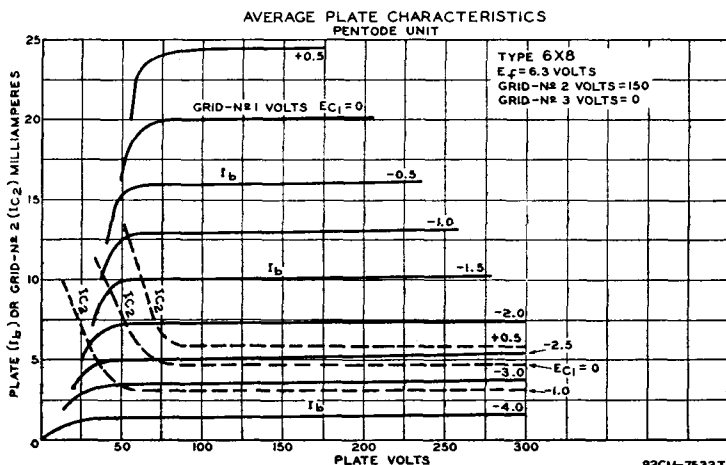

KINESCOPE

10FP4-A

Directly viewed picture tube used in television receivers. Features high-efficiency, metal-backed white fluorescent screen and faceplate of "Filter-glass" to provide increased contrast.

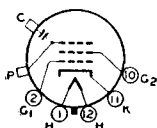

It utilizes phosphor No.4 of the sulfide type. For curve showing spectral-energy emission characteristic of this phosphor, refer to type 12LP4-A. Has a deflection angle of approximately 50° and utilizes magnetic focus and magnetic deflection to provide a rectangular picture with rounded corners about 8 x 6 inches. Tube uses either duodecal five-contact segment socket or the duodecal twelve-contact socket. Outline 47, OUTLINES SECTION. For support and mounting considerations, refer to type 10BP4-A; for installation and handling considerations, refer to the ELECTRON TUBE INSTALLATION SECTION. For tabulation of electrical and physical characteristics, refer to RCA KINESCOPE CHARACTERISTICS CHART, pages 314 and 315.

KINESCOPE

12KP4-A

Directly viewed picture tube used in television receivers. Features high-efficiency metal-backed white fluorescent screen and faceplate of "Filter-glass" to provide increased contrast.

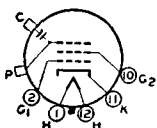

It utilizes phosphor No.4 of the sulfide type. For curve showing spectral-energy emission characteristic of this phosphor, refer to type 12LP4-A. Has a deflection angle of approximately 54° and utilizes magnetic focus and magnetic deflection to provide a rectangular picture with rounded corners about 10¼ x 7½ inches. Tube uses either duodecal five-contact segment socket or the duodecal twelve-contact socket. Outline for this tube is essentially the same as Outline 48, OUTLINES SECTION except neck length and overall length are 1½ inch shorter and deflection angle is 54°. For support and mounting considerations, refer to type 12LP4-A; for installation and handling considerations, refer to the ELECTRON TUBE INSTALLATION SECTION. For tabulation of electrical and physical characteristics, refer to RCA KINESCOPE CHARACTERISTICS CHART, pages 314 and 315.

KINESCOPE

14CP4

Directly viewed rectangular picture tube used in television receivers. Features high-efficiency white fluorescent screen and faceplate of "Filter-glass" to provide increased contrast.

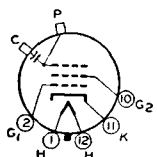

It utilizes phosphor No.4 of the sulfide type. For curve showing spectral-energy emission characteristic of this phosphor, refer to type 12LP4-A. Has a horizontal deflection angle of approximately 65° and utilizes magnetic focus and magnetic deflection to provide a rectangular picture area 11⅜ x 8½ inches with slightly curved sides and rounded corners. Tube uses either duodecal five-contact segment socket or the duodecal twelve-contact socket. Outline 55, OUTLINES SECTION, except that neck length and overall length are ¼ inch longer. For support and mounting considerations, refer to type 12LP4-A; for installation and handling considerations, refer to the ELECTRON TUBE INSTALLATION SECTION. For tabulation of electrical and physical characteristics, refer to RCA KINESCOPE CHARACTERISTICS CHART, pages 314 and 315.

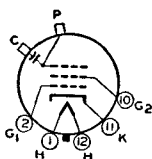

**KINESCOPE**

**14EP4**

Directly viewed rectangular picture tube used in television receivers. Features high-efficiency white fluorescent screen and faceplate of "Filter-glass" to provide increased contrast.

It utilizes phosphor No.4 of the sulfide type. For curve showing spectral-energy emission characteristic of this phosphor, refer to type 12LP4-A. Has a horizontal deflection angle of approximately 65° and utilizes magnetic focus and magnetic deflection to provide a rectangular picture area 11 $\frac{3}{8}$  x 8 $\frac{1}{2}$  inches with slightly curved sides and rounded corners. Tube uses either duodecal five-contact segment socket or the duodecal twelve-contact socket. Outline 55, OUTLINES SECTION. For support and mounting considerations, refer to type 12LP4-A; for installation and handling considerations, refer to the ELECTRON TUBE INSTALLATION SECTION. For tabulation of electrical and physical characteristics, refer to RCA KINESCOPE CHARACTERISTICS CHART, pages 314 and 315.

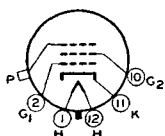

**KINESCOPE**

**16DP4-A**

Directly viewed picture tube used in television receivers. Features high-efficiency white fluorescent screen and faceplate of "Filterglass" to provide increased contrast. It utilizes phosphor

No.4 of the sulfide type. For curve showing spectral-energy emission characteristic of this phosphor, refer to type 12LP4-A. Has a deflection angle of approximately 60° and utilizes magnetic focus and magnetic deflection to provide a rounded-end picture 14 $\frac{1}{2}$  x 10 $\frac{1}{4}$  inches. Tube uses either duodecal five-contact segment socket or the duodecal twelve-contact socket. Outline 50, OUTLINES SECTION. For support and mounting considerations, refer to type 12LP4-A; for installation and handling considerations, refer to the ELECTRON TUBE INSTALLATION SECTION. For tabulation of electrical and physical characteristics, refer to RCA KINESCOPE CHARACTERISTICS CHART, pages 314 and 315.

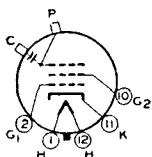

**KINESCOPE**

**16KP4**

Directly viewed rectangular picture tube used in television receivers. Features high-efficiency white fluorescent screen and faceplate of "Filter-glass" to provide increased contrast.

It utilizes phosphor No.4 of the sulfide type. For curve showing spectral-energy emission characteristic of this phosphor, refer to type 12LP4-A. Has a horizontal deflection angle of approximately 65° and utilizes magnetic focus and magnetic deflection to provide a rectangular picture area 13 $\frac{1}{2}$  x 10 $\frac{1}{8}$  inches with slightly curved sides and rounded corners. Tube uses either duodecal five-contact segment socket or the duodecal twelve-contact socket. Outline 56, OUTLINES SECTION. For support and mounting considerations, refer to type 12LP4-A; for installation and handling considerations, refer to the ELECTRON TUBE INSTALLATION SECTION. For tabulation of electrical and physical characteristics, refer to RCA KINESCOPE CHARACTERISTICS CHART, pages 314 and 315.

## KINESCOPE

## 16LP4-A

Directly viewed picture tube used in television receivers. Features high-efficiency white fluorescent screen and faceplate of "Filterglass" to provide increased contrast. It utilizes phosphor

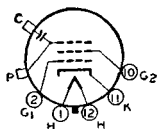

No. 4 of the sulfide type. For curve showing spectral-energy emission characteristic of this phosphor, refer to type 12LP4-A. Has a deflection angle of approximately  $52^\circ$  and utilizes magnetic focus and magnetic deflection to provide a rounded-end picture  $14\frac{1}{2} \times 10\frac{1}{4}$  inches. Tube uses either duodecal five-contact segment socket or the duodecal twelve-contact socket. Outline 51, OUTLINES SECTION. For support and mounting considerations, refer to type 12LP4-A; for installation and handling considerations, refer to ELECTRON TUBE INSTALLATION SECTION. For tabulation of electrical and physical characteristics, refer to RCA KINESCOPE CHARACTERISTICS CHART, pages 314 and 315.

## KINESCOPE

## 16RP4

Directly viewed rectangular picture tube used in television receivers. Features high-efficiency white fluorescent screen and faceplate of "Filterglass" to provide increased contrast.

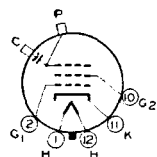

It utilizes phosphor No.4 of the sulfide type. For curve showing spectral-energy emission characteristic of this phosphor, refer to type 12LP4-A. Has a horizontal deflection angle of approximately  $65^\circ$  and utilizes magnetic focus and magnetic deflection to provide a rectangular picture area  $13\frac{1}{2} \times 10\frac{1}{8}$  inches with slightly curved sides and rounded corners. Tube uses either duodecal five-contact segment socket or the duodecal twelve-contact socket. Outline 56, OUTLINES SECTION. For support and mounting considerations, refer to type 12LP4-A; for installation and handling considerations, refer to the ELECTRON TUBE INSTALLATION SECTION. For tabulation of electrical and physical characteristics, refer to RCA KINESCOPE CHARACTERISTICS CHART, pages 314 and 315.

## KINESCOPE

## 16TP4

Directly viewed rectangular picture tube used in television receivers. Features high-efficiency white fluorescent screen and faceplate of "Filterglass" to provide increased contrast.

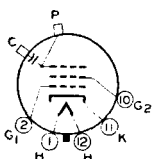

It utilizes phosphor No.4 of the sulfide type. For curve showing spectral-energy emission characteristic of this phosphor, refer to type 12LP4-A. Has a horizontal deflection angle of approximately  $65^\circ$  and utilizes magnetic focus and magnetic deflection to provide a rectangular picture area  $13\frac{1}{2} \times 10\frac{1}{8}$  inches with slightly curved sides and rounded corners. Tube uses either duodecal five-contact segment socket or the duodecal twelve-contact socket. Outline 56, OUTLINES SECTION. For support and mounting considerations, refer to type 12LP4-A; for installation and handling considerations, refer to the ELECTRON TUBE INSTALLATION SECTION. For tabulation of electrical and physical characteristics, refer to RCA KINESCOPE CHARACTERISTICS CHART, pages 314 and 315.



**KINESCOPE**

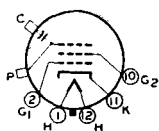

Directly viewed picture tube used in television receivers. Features high-efficiency white fluorescent screen and faceplate of "Filterglass" to provide increased contrast. It utilizes phosphor

**16WP4-A**

No.4 of the sulfide type. For curves showing spectral-energy emission characteristic of this phosphor, refer to type 12LP4-A. Has a deflection angle of approximately  $70^\circ$  and utilizes magnetic focus and magnetic deflection to provide a rounded-end picture  $14\frac{1}{2} \times 10\frac{1}{4}$  inches. Tube uses either duodecal five-contact segment socket or the duodecal twelve-contact socket. Outline 49, OUTLINES SECTION. For support and mounting considerations, refer to type 12LP4-A; for installation and handling considerations, refer to ELECTRON TUBE INSTALLATION SECTION. For tabulation of electrical and physical characteristics, refer to RCA KINESCOPE CHARACTERISTICS CHART, pages 314 and 315.

**KINESCOPE**

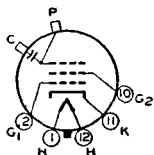

Directly viewed rectangular picture tube used in television receivers. Features high-efficiency white fluorescent screen and faceplate of "Filterglass" to provide increased contrast.

**17BP4-A**

It utilizes phosphor No.4 of the sulfide type. For curve showing spectral-energy emission characteristic of this phosphor, refer to type 12LP4-A. Has a horizontal deflection angle of approximately  $65^\circ$  and utilizes magnetic focus and magnetic deflection to provide a picture area  $14\frac{3}{8} \times 11\text{-}1/16$  inches with slightly curved sides and rounded corners. Tube uses either duodecal five-contact segment socket or the duodecal twelve-contact socket. Outline 57, OUTLINES SECTION. For support and mounting considerations, refer to type 12LP4-A; for installation and handling considerations, refer to the ELECTRON TUBE INSTALLATION SECTION. For tabulation of electrical and physical characteristics, refer to RCA KINESCOPE CHARACTERISTICS CHART, pages 314 and 315.

**KINESCOPE**

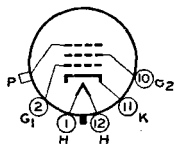

Directly viewed rectangular picture tubes of the metal-shell type used in television receivers. Both types feature a high-efficiency white fluorescent screen made of "Filterglass" to provide

**17CP4**

**17CP4-A**

increased contrast. The screen utilizes phosphor No.4 of the sulfide type. For curve showing spectral-energy emission characteristic of this phosphor, refer to type 12LP4-A. Type 17CP4 has a frosted faceplate to diffuse reflections of bright objects which would otherwise be objectionable. Has a horizontal deflection angle of approximately  $66^\circ$  and utilizes magnetic focus and magnetic deflection to provide a picture area  $14\frac{5}{8} \times 11$  inches with slightly curved sides and rounded corners. Tube uses either duodecal five-contact segment socket or the duodecal twelve-contact socket. Outline 58, OUTLINES SECTION. For support and mounting considerations, and for the recommended sequence of adjustments in lining up this tube with its associated components, refer to type 16GP4. For installation and handling considerations, refer to ELECTRON TUBE INSTALLATION SECTION. For tabulation of electrical and physical characteristics, refer to RCA KINESCOPE CHARACTERISTICS CHART, pages 314 and 315.

KINESCOPE

17GP4

Directly viewed rectangular picture tube of the metal-shell type used in television receivers. Features high-efficiency white fluorescent screen and faceplate of "Filterglass" to provide

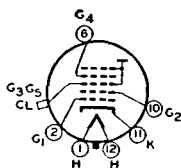

increased contrast. It utilizes phosphor No.4 of the sulfide type. For curve showing spectral-energy emission characteristic of this phosphor, refer to type 12LP4-A. Faceplate is frosted to diffuse reflections of bright objects which would otherwise be objectionable. Has a horizontal deflection angle of approximately 66° and utilizes electrostatic focus and magnetic deflection to provide a picture area 14 $\frac{5}{8}$  x 11 inches with slightly curved sides and rounded corners. Focusing voltage required is in the order of 8000 volts. Tube uses duodecal twelve-contact socket. Outline 58, OUTLINES SECTION. For support and mounting considerations, refer to type 16GP4; for installation and handling considerations, refer to ELECTRON TUBE INSTALLATION SECTION. For tabulation of electrical and physical characteristics, refer to RCA KINESCOPE CHARACTERISTICS CHART, pages 314 and 315.

KINESCOPE

17TP4

Directly viewed rectangular picture tube of the metal-shell type used in television receivers. Features high-efficiency white fluorescent screen and faceplate of "Filterglass" to provide

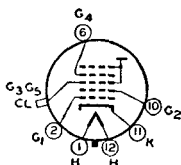

increased contrast. It utilizes phosphor No.4 of the sulfide type. For curve showing spectral-energy emission characteristic of this phosphor, refer to type 12LP4-A. Faceplate is frosted to diffuse reflections of bright objects which would otherwise be objectionable. Has a horizontal deflection angle of approximately 66° and utilizes electrostatic focus and magnetic deflection to provide a picture area 14 $\frac{5}{8}$  x 11 inches with slightly curved sides and rounded corners. Focusing voltage required is in the order of 0 to 400 volts. Tube uses duodecal twelve-contact socket. Outline 58, OUTLINES SECTION. For support and mounting considerations, refer to type 16GP4; for installation and handling considerations, refer to ELECTRON TUBE INSTALLATION SECTION. For tabulation of electrical and physical characteristics, refer to RCA KINESCOPE CHARACTERISTICS CHART, pages 314 and 315.

KINESCOPE

20CP4

Directly viewed rectangular picture tube used in television receivers. Features high-efficiency white fluorescent screen and faceplate of "Filterglass" to provide increased contrast.

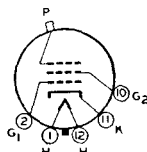

It utilizes phosphor No.4 of the sulfide type. For curve showing spectral-energy emission characteristic of this phosphor, refer to type 12LP4-A. Has a horizontal deflection angle of approximately 66° and utilizes magnetic focus and magnetic deflection to provide a picture area 17 $\frac{1}{4}$  x 13 $\frac{1}{4}$  inches with slightly curved sides and rounded corners. Tube uses either duodecal five-contact segment socket or the duodecal twelve-contact socket. Outline 59, OUTLINES SECTION. For support and mounting considerations, refer to type 12LP4-A; for installation and handling considerations, refer to the ELECTRON TUBE INSTALLATION SECTION. For tabulation of electrical and physical characteristics, refer to RCA KINESCOPE CHARACTERISTICS CHART, pages 314 and 315.

KINESCOPE

21AP4

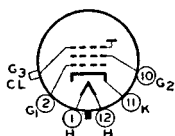

Directly viewed rectangular picture tube of the metal-shell type used in television receivers. Features high-efficiency white fluorescent screen and faceplate of "Filterglass" to provide

increased contrast. It utilizes phosphor No.4 of the sulfide type. For curve showing spectral-energy emission characteristic of this phosphor, refer to type 12LP4-A. Faceplate is frosted to diffuse reflections of bright objects which would otherwise be objectionable. Has a horizontal deflection angle of approximately 66° and utilizes magnetic focus and magnetic deflection to provide a picture area 18 $\frac{3}{8}$  x 13-15/16 inches with slightly curved sides and rounded corners. Tube uses either duodecal five-contact segment socket or the duodecal twelve-contact socket. Outline 60, OUTLINES SECTION. For support and mounting considerations, and for the recommended sequence of adjustments in lining up this tube with its associated components, refer to type 16GP4. For installation and handling considerations, refer to ELECTRON TUBE INSTALLATION SECTION. For tabulation of electrical and physical characteristics, refer to RCA KINESCOPE CHARACTERISTICS CHART, pages 314 and 315.

BEAM POWER AMPLIFIER

25BQ6-GT

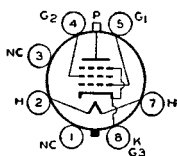

Glass octal type used as horizontal deflection amplifier in circuits of television equipment of the "transformerless" type. Outline 28, OUTLINES SECTION. Tube requires

octal socket and may be mounted in any position. Heater volts (ac/dc), 25; amperes, 0.3. Except for heater rating, this type is identical with glass octal type 6BQ6-GT.

# RCA Kinescope

RCA Type	Envelope	Faceplate	External Conductive Coating		Focusing Method	Deflection Method	Ion-Trap Magnet	Approx. Deflection Angle† Degrees	Maximum Dimensions Inches				Neck Length Inches
			Max. $\mu\text{f}$	Min. $\mu\text{f}$					Overall Length	Envelope Diameter	Width	Height	
3KP4	Glass Round	Clear	None	None	E	E $\odot$	None	None	11 $\frac{3}{4}$	3 $\frac{1}{8}$	—	—	—
5TP4*	Glass Round	Clear	500	100	E	M	‡	50	12 $\frac{3}{4}$	5 $\frac{1}{8}$	—	—	7 $\frac{1}{2}$
7DP4	Glass Round	Clear	1500	400	E	M	Double	50	14 $\frac{1}{4}$	7 $\frac{3}{8}$	—	—	8 $\frac{3}{4}$
7JP4	Glass	Clear	None	None	E	E $\odot$	None	None	14 $\frac{1}{4}$	7 $\frac{3}{8}$	—	—	—
9AP4	Glass Round	Clear	None	None	E	M	None	40	21 $\frac{3}{4}$	9 $\frac{3}{8}$	—	—	10
10BP4	Same as 10BP4-A, except has clear glass faceplate.												
10BP4-A	Glass Round	Filterglass	2500	500	M	M	Double	52	18	10 $\frac{5}{8}$	—	—	8 $\frac{3}{4}$
10FP4-A	Glass Round	Filterglass	2500	500	M	M	‡	50	18	10 $\frac{5}{8}$	—	—	8 $\frac{3}{4}$
12AP4	Glass Round	Clear	None	None	E	M	None	40	25 $\frac{3}{8}$	12 $\frac{3}{8}$	—	—	9 $\frac{3}{4}$
12KP4-A	Glass Round	Filterglass	2500	500	M	M	‡	54	18	12 $\frac{3}{8}$	—	—	7 $\frac{1}{2}$
12LP4	Same as 12LP4-A, except has clear glass faceplate.												
12LP4-A	Glass Round	Filterglass	2500	750	M	M	Double	57	19 $\frac{1}{4}$	12 $\frac{3}{8}$	—	—	8 $\frac{1}{4}$
14CP4	Glass Rectangular	Filterglass	2000	750	M	M	Single	65	17 $\frac{1}{4}$	13 $\frac{13}{16}$	12 $\frac{21}{32}$	9 $\frac{27}{32}$	7 $\frac{1}{2}$
14EP4	Glass Rectangular	Filterglass	2000	750	M	M	Single	65	16 $\frac{1}{8}$	13 $\frac{13}{16}$	12 $\frac{21}{32}$	9 $\frac{27}{32}$	7 $\frac{1}{2}$
16AP4	Same as 16AP4-A, except has clear glass faceplate.												
16AP4-A	Metal Round	Filterglass	None	None	M	M	Double	53	22 $\frac{5}{16}$	16	—	—	7 $\frac{3}{4}$
16DP4-A	Glass Round	Filterglass	None	None	M	M	Double	60	21	16	—	—	7 $\frac{3}{4}$
16GP4	Same as 16GP4-B, except has Filterglass faceplate.												
16GP4-A	Same as 16GP4-B, except has clear glass faceplate.												
16GP4-B	Metal Round	Frosted Filterglass	None	None	M	M	Single	70	17 $\frac{11}{16}$	16	—	—	6 $\frac{1}{2}$
16GP4-C	Same as 16GP4-B, except has frosted clear glass faceplate.												
16KP4	Glass Rectangular	Filterglass	2000	750	M	M	Single	65	19 $\frac{1}{8}$	16 $\frac{1}{4}$	14 $\frac{3}{8}$	11 $\frac{3}{8}$	7 $\frac{1}{2}$
16LP4-A	Glass Round	Filterglass	3500	1500	M	M	Double	52	22 $\frac{5}{8}$	16	—	—	7 $\frac{3}{4}$
16RP4	Glass Rectangular	Filterglass	2000	750	M	M	Single	65	19 $\frac{1}{8}$	16 $\frac{3}{16}$	14 $\frac{13}{16}$	11 $\frac{11}{16}$	7 $\frac{1}{2}$
16TP4	Glass Rectangular	Filterglass	2000	750	M	M	Single	65	18 $\frac{1}{2}$	16 $\frac{3}{16}$	14 $\frac{13}{16}$	11 $\frac{11}{16}$	6 $\frac{3}{4}$
16WP4-A	Glass Round	Filterglass	2000	750	M	M	Double	70	18 $\frac{1}{8}$	16	—	—	7 $\frac{3}{4}$
17BP4-A	Glass Rectangular	Filterglass	2000	750	M	M	Single	65	19 $\frac{1}{16}$	16 $\frac{3}{8}$	15 $\frac{1}{2}$	12 $\frac{13}{32}$	7 $\frac{1}{2}$
17CP4	Metal Rectangular	Frosted Filterglass	None	None	M	M	Single	66	19	17	16 $\frac{1}{16}$	12 $\frac{3}{8}$	7 $\frac{3}{4}$
17CP4-A	Same as 17CP4, except has Filterglass faceplate.												
17GP4	Metal Rectangular	Frosted Filterglass	None	None	E	M	Single	66	19 $\frac{1}{16}$	17	16 $\frac{1}{16}$	12 $\frac{3}{8}$	7 $\frac{1}{2}$
17TP4	Metal Rectangular	Frosted Filterglass	None	None	E	M	Single	66	19 $\frac{1}{16}$	17	16 $\frac{1}{16}$	12 $\frac{3}{8}$	7 $\frac{1}{2}$
19AP4	Same as 19AP4-B, except has clear glass faceplate.												
19AP4-A	Same as 19AP4-B, except has Filterglass faceplate.												
19AP4-B	Metal Round	Frosted Filterglass	None	None	M	M	Single	66	22	18 $\frac{5}{8}$	—	—	7 $\frac{3}{4}$
19AP4-D	Same as 19AP4-B, except has frosted clear glass faceplate.												
20CP4	Glass Rectangular	Filterglass	None	None	M	M	Single	66	21 $\frac{15}{16}$	20 $\frac{3}{32}$	18 $\frac{3}{8}$	15 $\frac{1}{8}$	7 $\frac{3}{4}$
21AP4	Metal Rectangular	Frosted Filterglass	None	None	M	M	Single	66	22 $\frac{3}{16}$	21	19 $\frac{27}{32}$	15 $\frac{1}{16}$	7 $\frac{1}{2}$

E = Electrostatic. M = Magnetic.  
 Note: All kinescopes shown have 6.3-volt/0.6-ampere heaters except types 9AP4 and 12AP4 which have 2.5-volt/2.1-ampere heaters.

‡ Utilizes metal-backed screen to prevent ion-spot bluish.  
 ■ Projection type.  
 ∞ Grid-No. 2 connected to final high-voltage electrode within tube.

† For rectangular tubes, horizontal deflection angle is shown; corresponding diagonal deflection angle is 70°.

# Characteristics Chart

Picture Size	High-Voltage Terminal	Maximum Ratings				Typical Operating Conditions				 Type
		Final High-Voltage Electrode (ULTOR*) Volts	Focusing Electrode Volts	Grid-No. 2 Volts	Grid-No. 1 Bias Volts <sup>‡</sup>	Final High-Voltage Electrode (ULTOR*) Volts	Focusing Electrode Volts	Grid-No. 2 Volts	Grid-No. 1 Visual-Cutoff Volts <sup>‡</sup>	
2½ x 1⅜	Base Pin	2500	1000	∞	200	1500 to 2500	320 to 600	∞	-38 to -90	3KP4
24 x 18	Small Cavity Cap	27000	6000	350	150	20000 to 27000	4320 to 5400	200	-42 to -98	5TP4*
6⅝ x 4¾	Small Cavity Cap	8000	2400	410	125	5000 to 8000	1200 to 1650	250	-27 to -63	7DP4
6½ x 4¾	Base Pin	6000	2800	∞	200	3000 to 6000	1620 to 2400	∞	-72 to -168	7JP4
5⅝ x 7¼	Medium Cap	7000	2000	300	125	5000 to 7000	1190 to 1790	250	-20 to -60	9AP4
Ratings and characteristics are same as for type 10BP4-A.										10BP4
9⅝ x 7	Small Cavity Cap	12000	—	410	125	8000 to 12000	—	250	-27 to -63	10BP4-A
8 x 6	Small Cavity Cap	12000	—	410	125	8000 to 12000	—	250	-27 to -63	10FP4-A
9¾ x 7⅝	Medium Cap	7000	2000	300	125	6000 to 7000	1190 to 1790	250	-20 to -60	12AP4
10¼ x 7⅝	Small Cavity Cap	12000	—	410	125	9000 to 12000	—	250	-27 to -63	12KP4-A
Ratings and characteristics are same as for type 12LP4-A.										12LP4
11⅝ x 8½	Small Cavity Cap	12000	—	410	125	9000 to 12000	—	250	-27 to -63	12LP4-A
11⅝ x 8½	Small Cavity Cap	14000	—	410	125	10000 to 14000	—	300	-33 to -77	14CP4
11⅝ x 8½	Small Cavity Cap	14000	—	410	125	10000 to 14000	—	300	-33 to -77	14EP4
Ratings and characteristics are same as for type 16AP4-A.										16AP4
14⅝ x 11	Metal-Shell Lip	14000	—	410	125	9000 to 12000	—	300	-33 to -77	16AP4-A
14½ x 10⅝	Small Cavity Cap	15000	—	410	125	12000 to 15000	—	250	-33 to -77	16DP4-A
Ratings and characteristics are same as for type 16GP4-B.										16GP4
Ratings and characteristics are same as for type 16GP4-B.										16GP4-A
14⅝ x 11	Metal-Shell Lip	14000	—	410	125	12000 to 14000	—	300	-33 to -77	16GP4-B
Ratings and characteristics are same as for type 16GP4-B.										16GP4-C
13½ x 10½	Small Cavity Cap	16000	—	410	125	12000 to 16000	—	300	-33 to -77	16KP4
14½ x 10⅝	Small Cavity Cap	14000	—	410	125	12000 to 14000	—	300	-33 to -77	16LP4-A
13½ x 10½	Small Cavity Cap	16000	—	410	125	12000 to 16000	—	300	-33 to -77	16RP4
13½ x 10½	Small Cavity Cap	14000	—	410	125	12000 to 14000	—	300	-33 to -77	16TP4
14½ x 10⅝	Small Cavity Cap	16000	—	410	125	12000 to 16000	—	250	-27 to -63	16WP4-A
14⅝ x 11½	Small Cavity Cap	16000	—	410	125	12000 to 16000	—	300	-33 to -77	17BP4-A
14⅝ x 11	Metal-Shell Lip	16000	—	410	125	12000 to 16000	—	300	-33 to -77	17CP4
Ratings and characteristics are same as for type 17CP4.										17CP4-A
14⅝ x 11	Metal-Shell Lip	16000	5000	500	125	12000 14000	2040 to 2760 2380 to 3220	300 300	-33 to -77 -33 to -77	17GP4
14⅝ x 11	Metal-Shell Lip	16000	500	500	125	14000 16000	0 to 350 0 to 400	300 300	-33 to -77 -33 to -77	17TP4
Ratings and characteristics are same as for type 19AP4-B.										19AP4
Ratings and characteristics are same as for type 19AP4-B.										19AP4-A
17⅝ x 13	Metal-Shell Lip	19000	—	410	125	12000 to 19000	—	300	-33 to -77	19AP4-B
Ratings and characteristics are same as for type 19AP4-B.										19AP4-D
17⅝ x 13¼	Small Cavity Cap	18000	—	410	125	14000 to 18000	—	300	-33 to -77	20CP4
18⅝ x 13¼	Metal-Shell Lip	18000	—	410	125	14000 to 18000	—	300	-33 to -77	21AP4

\* Positive bias value = 0 volts; positive peak value = 2 volts.

† The cutoff bias requirements for a tube in operation are about 5 volts less negative than the indicated values.

‡ Deflection Factors (volts dc/in.) for typical operating conditions shown:

Type	D <sub>1</sub> & D <sub>1</sub> (beam screen)	D <sub>1</sub> & D <sub>1</sub> (beam bias)
3KP4	100 to 136	76 to 104
7JP4	186 to 246	150 to 204

\* ULTOR is defined as the electrode, or the electrode in combination with one or more additional electrodes connected within the tube to it, to which is applied the highest dc voltage for accelerating the electrons in the beam prior to its deflection.

*Notes:*

# RCA Tube Department

## Technical Publications

Copies of the publications listed below may be obtained from your RCA Tube Distributor, or direct from Commercial Engineering, Tube Department, Radio Corporation of America, Harrison, New Jersey.

### Electron Tubes

- **TUBE HANDBOOK**—ALL TYPES HB-3 ( $7\frac{3}{8}'' \times 5''$ ). The bible of the industry—contains over 2600 pages of loose-leaf data and curves on all RCA receiving tubes, power tubes, cathode-ray tubes, phototubes, and special tubes. Three deluxe 4-prong binders imprinted in gold. Available on subscription basis. Price \$10.00\* including service for first year. Write to Commercial Engineering for descriptive folder and order form.
- **RECEIVING TUBE MANUAL**—RC-16 ( $8\frac{3}{8}'' \times 5\frac{1}{2}''$ )—320 pages. Supersedes RC-15. Revised and brought up to date. Contains the latest receiving tubes, including miniature types and kinescopes. Features tube theory written for the layman, application data and circuits for both AM and FM equipment, and expanded Resistance-Coupled Amplifier Section. Lie-flat binding. Price 50 cents.\*
- **PHOTOTUBES BOOKLET**—PT-20R1 ( $11'' \times 8\frac{1}{2}''$ )—16 pages. Phototube theory, data on 15 older types, curves, and circuits for light-operated relays, light measurements, and sound reproduction. Single copy free on request.
- **RADIOTRON DESIGNER'S HANDBOOK**—( $9'' \times 6''$ )—356 pages. Edited by E. Langford Smith of Amalgamated Wireless Valve Company Pty. Ltd. in Australia. Of value to anyone interested in fundamental principles of practical circuit design. Copiously illustrated. Price \$1.25.\*
- **POWER AND GAS TUBES FOR RADIO AND INDUSTRY**—Bulletin PG-101-A ( $11'' \times 8\frac{1}{2}''$ )—20 pages. Technical information on air-and-water-cooled transmitting tubes, rectifiers, thyratrons, ignitrons, and voltage regulators. Includes terminal connections. Price 15 cents.\*
- **PHOTOTUBES, CATHODE-RAY AND SPECIAL TYPES**—Bulletin CRPS-102-A ( $11'' \times 8\frac{1}{2}''$ )—20 pages. Technical information on gas- and vacuum-type phototubes, cathode-ray tubes, camera tubes, low-microphonic types, acorn types, and other small tubes for special applications. Includes terminal connections. Price 15 cents.\*
- **RECEIVING TUBES FOR AM, FM, AND TELEVISION BROADCAST**—Bulletin 1275-E ( $11'' \times 8\frac{1}{2}''$ )—24 pages. Completely revised and brought up to date. Contains characteristics for all RCA receiving tubes including kinescopes. Socket connection diagrams arranged for quick and easy reference. Price 10 cents.\*
- **INSTRUCTION BOOKLETS**—Complete authorized information on RCA non-receiving types by type. Be sure to mention tube-type booklet desired. Single copy on any type free on request.
- **AIR-COOLED TRANSMITTING TUBES MANUAL**—TT3 ( $8\frac{3}{8}'' \times 5\frac{3}{8}''$ )—192 pages. Published several years ago, this book still retains popularity for instruction purposes. It contains basic information on generic tube types, tube parts and materials, tube ratings, tube installation and application, transmitter-design considerations, rectifiers and filters, as well as data on many of the older tube types. Price 35 cents.\*
- **HEADLINERS FOR HAMS**—Bulletin HAM-103A ( $11'' \times 8\frac{1}{2}''$ )—4 pages. Technical information and terminal connections on RCA "HAM" PREFERENCE TYPES: class B modulators, class C amplifiers and oscillators, frequency multipliers, rectifiers, thyratrons, and voltage regulators. Single copy free on request.

\*Prices shown apply in U.S.A. and are subject to change without notice.

- **TRIPLE PINDEX**—2F366R (8" x 3 $\frac{3}{4}$ ")—Completely revised. Receiving and kinescope tube base—diagram guide on over 650 types arranged in numerical-alphabetical sequence. The diagrams of any three tubes can be located and kept in front of you at the same time. Price 75 cents.\*
- **RCA PREFERRED TYPES LIST**—Bulletin PTL-501-B (11" x 8 $\frac{1}{2}$ ")—4 pages. Lists RCA Preferred Tube Types, both receiving and non-receiving, by function. An aid to equipment designers in the selection of tube types for new equipment design. Single copy free on request.
- **RCA INTERCHANGEABILITY DIRECTORY ON TUBES FOR COMMUNICATIONS AND INDUSTRY**—Bulletin ID-1020 (11" x 8 $\frac{1}{2}$ ")—20 pages. Lists 1600 type designations of 24 different manufacturers arranged in alphabetical-numerical sequence; shows the RCA Direct Replacement Type or the RCA Similar Type. Price 15 cents.\*
- **RCA KINESCOPES**—Bulletin KB-1022 (11" x 8 $\frac{1}{2}$ ")—20 pages. Contains characteristics and basing diagrams for all RCA kinescopes. Includes interchangeability directory and features a conversion chart helpful in modifying television receivers for larger kinescopes. Price 15 cents.\*
- **RCA POWER-TUBE FITTINGS**—PFT-1012 (11" x 8 $\frac{1}{2}$ ")—24 pages. Lists and describes 39 power-tube fittings designed for supporting and cooling water-cooled and forced-air-cooled power tubes, and illustrates their use with power tubes made by RCA and other manufacturers. Price 25 cents.\*

## Components and Service Parts

- **RCA VICTOR SERVICE DATA**—Cover RCA Victor radios, phonographs, and television receivers of 1923 through 1951. Material includes schematic and wiring diagrams, electrical and mechanical specifications, alignment and adjustment procedures, complete service parts lists, chassis layouts, and much other useful servicing data. This material is available in two forms: (1) six bound volumes covering the years 1923 through 1950; (2) booklets covering individual or similar models released in 1950 and 1951.

### BOUND VOLUMES—RADIO, PHONOGRAPH, TELEVISION

Volume No.	Years	Pages	Price*
I	1923 to 1937	880	\$3.50
II	1938 to 1942	816	\$4.00
III	1943 to 1946	290	\$4.00
IV	1947 to 1948	566	\$6.00
V	1949	330	\$5.00
VI	1950	472	\$5.50

- **BOOKLETS ON 1950 AND 1951 TV RECEIVERS**—Model Nos. 2T81, 4T101, 4T141, 6T72, 7T143, 9T89, 9T147, S1000, T100, T120, T121, TA128, TA129, TA169, [2T51, 2T60]<sup>o</sup>, [6T84, 6T86, 6T87]<sup>o</sup>, [6T53, 6T54, 6T64, 6T65, 6T71, 6T74, 6T75, 6T76]<sup>o</sup>, [7T103, 7T103B, 7T104, 7T104B, 7T112, 7T112B, 7T122, 7T122B, 7T123, 7T123B, 7T124, 7T125B, 7T132]<sup>o</sup>, [9T57, 9T77, 9T79]<sup>o</sup>, [9T105, 9T126, 9T128]<sup>o</sup>, [TC124, TC125, TC127]<sup>o</sup>. Price per booklet, 50 cents.\*
- **BOOKLETS ON 1950 RADIOS AND PHONOGRAPHS**—Model Nos. A55, A78, A106, BX6, BX55, BX57, 45EY, 45J, RP190, X711, [X551, X552]<sup>o</sup>, [960282-1, 960282-2]<sup>o</sup>, [960284-1, 960284-2]<sup>o</sup>, 960285-1. Price per booklet, 25 cents.\*

- **SERVICE PARTS DIRECTORY FOR RCA VICTOR TV RECEIVERS**—SP-1007 (10 $\frac{7}{8}$ " x 16 $\frac{3}{4}$ ")—80 pages. Schematic diagrams and replacement parts lists for all RCA Victor television receivers manufactured from 1946 through June 1950 (56 models). Large-size book opens so that schematic diagrams face corresponding parts lists for quick reference. Price 75 cents.\*

\*Models within brackets are covered in one booklet.



- **SERVICE PARTS DIRECTORY FOR RCA VICTOR RADIOS**—SP-1008 (11" x 8½")—24 pages. Lists stock numbers of major replacement parts by receiver model numbers for over 600 RCA Victor radio receivers. Covers period from 1938 through 1950. Price 15 cents.\*
- **RCA COMPONENTS DIRECTORY FOR TV RECEIVERS**—SP-1006A (11" x 8½")—16 pages. Lists approximately 500 television receivers of 38 manufacturers and their major replacement parts. Price 10 cents.\*
- **RCA TV COMPONENTS**—CTV-1011-A (11" x 8½")—72 pages. Complete specifications on over 60 RCA TV components. Gives electrical ratings and characteristics, terminal connection diagrams, outline drawings, typical circuits, associated components, and installation recommendations. Price 25 cents.\*
- **TELEVISION SERVICE DATA**—TV1003 (11" x 8½") 112 pages. For RCA Victor Models 630TS and 648PTK. Contains alignment procedures, schematic diagrams, complete parts lists, wiring diagrams, and chassis layout. Price \$1.50.\*
- **RCA TELEVISION "PICT-O-GUIDE" VOLUMES I & II**—Covers different phases of TV trouble shooting by picture analysis. Vol. I contains 100 pages and more than 40 photographs; Vol. II, 224 pages and more than 80 photographs. Each volume contains circuit diagrams, basic television information, and detailed descriptions of picture troubles. Price per volume \$2.50.\*
- **RCA CRYSTAL CARTRIDGE DATA**—SP-1010 (11" x 8½")—4 pages. Lists and illustrates replacement crystal cartridges and styli for RCA Victor record players. Single copy free on request.

## Test and Measuring Equipment

- **INSTRUCTION BOOKLETS**—Complete instruction booklets, containing specifications, maintenance and operating data, replacement parts lists, and schematic diagrams, are available for all RCA test equipment. Instruction booklets for the following popular instruments are available at the prices indicated.

### 25 cents each

WO-55A (3" Oscilloscope)  
 WO-58A (5" Oscilloscope)  
 WR-39A (TV Calibrator)  
 WR-59A (TV Sweep Generator)  
 WR-67A (Test Oscillator)  
 WV-65A (VoltOhmyst†)  
 WV-75A (VoltOhmyst†)  
 WV-84A (Microammeter)  
 WV-95A (VoltOhmyst†)  
 165-A (VoltOhmyst†)  
 195-A (VoltOhmyst†)

### 50 cents each

WO-56A (7" Oscilloscope)  
 WO-57A (3" Oscilloscope)  
 WO-57B (3" Oscilloscope)  
 WO-60C (5" Oscilloscope)  
 WO-79A (3" Oscilloscope)  
 WO-79B (3" Oscilloscope)  
 WR-39B (TV Calibrator)  
 WR-39C (TV Calibrator)  
 WR-59B (TV Sweep Generator)  
 WR-59C (TV Sweep Generator)  
 WV-97A (VoltOhmyst†)

Prices for booklets on other RCA test instruments are available on request.

## Batteries

- **RCA RADIO BATTERIES FOR FLASHLIGHT, RADIO, AND INDUSTRIAL APPLICATIONS**—BAT-134A (11" x 8½")—8 pages. Contains characteristics, terminal types, and socket patterns of 84 RCA dry batteries for radio, flashlight, and industrial applications. Includes interchangeability directory, and a battery replacement guide for 1948, 1949, 1950, and 1951 for portable radios. Single copy free on request.

†Trade Mark Reg. U.S. Pat. Off.

# Reading List

This list includes references of both elementary and advanced character. Obviously, the list is not inclusive, but it will guide the reader to other references.

- ALBERT, A. L. *Fundamental Electronics and Vacuum Tubes*. The MacMillan Co.
- CHAFFEE, E. L. *Theory of Thermionic Vacuum Tubes*. McGraw-Hill Book Co., Inc.
- CHUTE, G. M. *Electronics in Industry*. McGraw-Hill Book Co., Inc.
- COOKE, N. M. *Mathematics for Electricians and Radiomen*. McGraw-Hill Book Co., Inc.
- DOW, W. G. *Fundamentals of Engineering Electronics*. John Wiley and Sons, Inc.
- EASTMAN, A. V. *Fundamentals of Vacuum Tubes*. McGraw-Hill Book Co., Inc.
- EVERITT, W. L. *Communication Engineering*. McGraw-Hill Book Co., Inc.
- FINK, D. G. *Engineering Electronics*. McGraw-Hill Book Co., Inc.
- FINK, D. G. *Principles of Television Engineering*. McGraw-Hill Book Co., Inc.
- GHIRARDI, A. A. *Modern Radio Servicing*. Radio and Technical Publishing Co., Inc.
- GROB, B. *Basic Television*. McGraw-Hill Book Co., Inc.
- HENNEY, KEITH *Radio Engineering Handbook* McGraw-Hill Book Co., Inc.
- HOAG, J. B. *Basic Radio*. D. Van Nostrand Co., Inc.
- KOLLER, L. R. *Physics of Electron Tubes*. McGraw-Hill Book Co., Inc.
- MCILWAIN AND BRAINERD. *High-Frequency Alternating Currents*. John Wiley and Sons, Inc.
- MARKUS AND ZELUFF. *Handbook of Industrial Electronic Circuits*. McGraw-Hill Book Co., Inc.
- M.I.T. ELECTRICAL ENGINEERING STAFF. *Applied Electronics*. John Wiley and Sons, Inc.
- MOYER AND WOSTREL. *Radio Receiving and Television Tubes*. McGraw-Hill Book Co., Inc.
- PENDER, DELMAR, AND MCILWAIN. *Handbook for Electrical Engineers—Communications and Electronics*. John Wiley and Sons, Inc.
- PREISMAN, A. *Graphical Constructions for Vacuum Tube Circuits*. McGraw-Hill Book Co., Inc.
- Proceedings of the Institute of Radio Engineers* (a monthly publication).
- RCA TECHNICAL BOOK SERIES. *Electron Tubes, Vol. I and Vol. II*. RCA Review.
- REICH, H. J. *Theory and Applications of Electron Tubes*. McGraw-Hill Book Co., Inc.
- RICHTER, WALTHER. *Fundamentals of Industrial Electronic Circuits*. McGraw-Hill Book Co., Inc.
- SPANGENBERG, K. R. *Vacuum Tubes*. McGraw-Hill Book Co., Inc.
- TERMAN, F. E. *Fundamentals of Radio*. McGraw-Hill Book Co., Inc.
- TERMAN, F. E. *Radio Engineers Handbook*. McGraw-Hill Book Co., Inc.
- The Radio Amateurs Handbook*. American Radio Relay League.
- VAN DER BIJL, H. J. *Thermionic Vacuum Tubes*. McGraw-Hill Book Co., Inc.
- ZWORYKIN AND MORTON. *Television: The Electronics of Image Transmission*. John Wiley and Sons, Inc.

## RCA Receiving Types NOT Recommended For New Equipment Design

Certain receiving tube types should be avoided in the design of new equipment because they are approaching obsolescence or have limited or dwindling demand. Such RCA Types are listed below:

OY4	2A4-G	6D6	12Z3	45
OZ4-G	2A5	6D8-G	19	45Z3
1A4-P	2A6	6F7	24-A	46
1A6	2A7	6J7-G	25A6	47
1B4-P	2B7	6J8-G	25AC5-GT	49
1B5/25S	2E5	6K5-GT	25Z6	50
1C5-GT	3A8-GT	6K7-G	26	53
1C6	5T4	6K8-G	27	55
1C7-G	5W4	6L5-G	30	56
1D5-GP	5X4-G	6L7-G	31	57
1D7-G	5Y3-G	6N6-G	32	58
1E5-GP	5Y4-G	6P5-GT	32L7-GT	59
1E7-GT	6A3	6Q7-G	33	71-A
1F4	6A6	6S7-G	34	75
1F5-G	6A7	6T7-G	35	76
1F6	6A8-G	6U7-G	35Z4-GT	77
1F7-G	6AC5-GT	6W7-G	36	78
1G5-G	6B5	6X5	37	79
1H4-G	6B6-G	6Z7-G	38	81
1H6-G	6B7	6ZY5-G	39/44	82
1J6-GT	6B8-G	9AP4	41	83-v
1Q5-GT	6C6	12A7	42	84/6Z4
1S4	6C8-G	12AP4	43	85
1-v				89

---

### RCA Preferred Types List

A list of preferred tube types is available to assist equipment designers and manufacturers in formulating their plans for future production of electronic equipment. This list is based on periodic surveys of the needs of the engineering and manufacturing fields and keeps abreast of technological advances in tube design and application.

A copy of this list will be gladly furnished on request. Write to Commercial Engineering, Tube Department, Radio Corporation of America, Harrison, N. J.

