

MOBILE RADIO HANDBOOK



FM-TV

HANDBOOK SERIES

★ Edited by Milton B. Sleeper ★

For The Best In
TWO - WAY RADIO COMMUNICATIONS

always specify

Link

**DESIGN LEADER IN THE FIELD
SINCE 1932 WITH EQUIPMENT**

"Preferred The World Over!"

~ ~ ~
FM

- 25-50 MC • 72-76 MC • 152-162 MC
- 450 MC BAND • 960 MC BAND

~ ~ ~
AM

- 25-50 MC • 1500-3000 KC

~ ~ ~
Portable Units

and

VETRIC Motorcycle Radio Equipment

~ ~ ~
FIXED STATION AND MOBILE EQUIPMENT FOR POLICE • FIRE • FORESTRY •
CONSERVATION • LOGGING • POWER UTILITY • PETROLEUM
AND PIPE LINE UTILITY • COMMON CARRIER • TELEPHONE
INDUSTRIAL • COMMERCIAL • SPECIAL EMERGENCY
AND ALL 2-WAY AND 3-WAY SERVICES.

COMMUNICATION SPECIALISTS FOR 17 YEARS AND THE
OLDEST MANUFACTURER OF FM EQUIPMENT FOR
GENERAL MOBILE APPLICATION.

Link RADIO CORPORATION • 125 WEST 17TH ST., NEW YORK 11, N. Y.

UNIVERSAL MODULATION MONITOR

Monitors the modulation of all FM communications transmitters on 30 to 162 mc.



THE BROWNING Universal FM Modulation Monitor provides a simple and inexpensive means for every communications supervisor to check his own fixed and mobile transmitters—and those of other systems—for compliance with FCC limitations on carrier swing due to modulation.

Maintenance of frequency swing within the plus-and-minus 15 kc. limit is more than a matter of complying with FCC rules. It is absolutely essential to the reduction of adjacent-channel interference! And, with the BROWNING Universal Modulation Monitor, you can check not only your own transmitters, but those of other systems on 30 to 50, 72 to 76, and 152 to 162 mc.

A single BROWNING Monitor can be used to check all transmitters.

There is no worry or expense of crystals, since the accuracy does not depend on crystal control.

Operation of the BROWNING Monitor is so simple that it can be explained in a few words: The multi-range band-selector switch is set to the proper band, and the unmodulated transmitter carrier is tuned in precisely. Then the carrier is modulated by voice or an audio oscillator, and the frequency swing is read directly from a 4-in. panel meter calibrated to 20 kc. Either upward or downward swing can be measured. The meter shows sustained sinusoidal modulation or voice peaks of .3 seconds duration. An audio output jack, connected to an amplifier, permits aural monitoring.

Signals of 500 microvolts are adequate to operate the Monitor. If the instrument is mounted permanently at the headquarters station, cars can be checked while they are on the road.

The BROWNING Universal FM Modulation Monitor is carried on a 19-in. panel. It is supplied with a portable case 20½ ins. wide, 9 ins. high, and 12 ins. deep, or without the case for mounting on a rack at headquarters or in a test truck.

Further technical data on the MD-25, and information on price and delivery will be sent on request. Use the coupon below.

Browning Frequency Meters Have Been the Standard for Communications Since 1939

FREQUENCY METERS: Equally important to reducing adjacent-channel interference is the precision frequency adjustment of fixed and mobile transmitters. For this purpose BROWNING meters are preferred because they are so convenient to use. Moreover, any BROWNING

meter can be checked in the field against WWV standard frequency transmissions. Every BROWNING meter used a 100-kc. crystal, which is a sub-multiple of WWV. Remember this when you buy a frequency meter, because if it has a crystal ground to a specific transmitter frequency, it cannot

be checked against WWV without elaborated interpolating instruments.

BROWNING meters are available for all communications frequencies from 1 mc. to 500 mc. Use the coupon to get complete details on single-frequency and multiple frequency meters.



IN CANADA, ADDRESS:
Measurement Engineering, Ltd., Arnprior, Ont.
EXPORT SALES
9 ROCKEFELLER PLAZA, Room 1422
NEW YORK 20, U. S. A.

BROWNING LABORATORIES, Inc.
750 Main St., Winchester, Mass.

Please send me technical details and prices on the following Browning precision products:

- Model MD-25 Universal Modulation Monitor
- Frequency Meters, calibrated at the following frequencies
.....mc.....mc.....mc.....mc

Name

Address

Company Connection



PIONEER OF TWO-WAY FM COMMUNICATIONS

EDWARD J. Hickey, Commissioner of the Connecticut State Police, sponsored the first 2-way communications system employing Armstrong FM fixed and mobile equipment. The installation, comprising 10 transmitters, most of which were controlled remotely from police barracks, and 225 units in patrol cars, provided complete coverage of the State. This system represented the greatest advance in modern police protection of lives and property. Such outstanding records were achieved in the apprehension of criminals, the recovery of stolen goods, and the improvement of relations between the citizens and the State Police that public officials came from all parts of the United States and many foreign countries to learn first-hand about Connecticut's remarkable system of instantaneous, state-wide communication.

The original engineering survey and planning was done by Prof. Daniel E. Noble in 1939. Prof. Noble was then an instructor at the University of Connecticut. No equipment had ever been build for such a purpose, but its manufacture was undertaken by

Fred M. Link. The system was completed in 1940.

Engineering-wise, it is significant to note that this was less than 5 years after Major Armstrong's first public demonstration of FM before the Institute of Radio Engineers at New York City in November, 1935. At that time, engineers quoted in the press called FM a "visionary dream," and the *Boston Globe* of November 17 reported: "... it is so complex that it requires, at least in its present stage of development, a receiving set of 57 tubes, which is out of the question as a commercial and marketable possibility."

However, the Connecticut system had been so carefully planned and the equipment so well designed that no changes or modifications were required and, according to Commissioner Hickey, most of the original equipment is still in daily operation.

From that initial success, the use of FM communications has grown to a point where, at the beginning of 1950, more than 10,000 fixed stations and 200,000 mobile units are in service, and over 3,000 applications for FM systems are currently pending.

MOBILE RADIO HANDBOOK

TABLE OF CONTENTS

- CHAPTER 1. Basic System Planning**
Page 5
General information on points which must be considered when planning any 2-way communications system, such as relative costs and provision for expansion. By Milton B. Sleeper.
- CHAPTER 2. Rules and Allocations**
Page 10
A resumé of rules, frequencies, and qualifications for each service, and a complete allocations table for the band from 30 to 30,000 mc. Taken from FCC Rules effective July 1, 1949.
- CHAPTER 3. License Application**
Page 25
Step-by-step instructions for selecting and filling out FCC license application forms, with renewal information and list of FCC field offices. By Jeremiah Courtney.
- CHAPTER 4. Equipment Specifications**
Page 37
Details of standard equipment, with complete specifications for fixed and mobile transmitters and receivers, including tube lists and current consumption data.
- CHAPTER 5. Selective Calling**
Page 44
Explaining instantaneous and dial systems of selective calling, and their applications to various mobile installations. By J. K. Kulansky, Mobile Systems Engineer, Hammarlund Co.
- CHAPTER 6. Adjacent-Channel Operation**
Page 52
A discussion of engineering problems of adjacent-channel operation, with a description of equipment now available. By Harold A. Jones, Systems Engineer, Motorola, Inc.
- CHAPTER 7. Antenna Designs**
Page 57
Purposes and characteristics of various antennas for specific types of communications systems. By C. W. Creaser, Antenna Development Engineer, Workshop Associates.
- CHAPTER 8. Guyed Tower Erection**
Page 69
Detailed instructions for erecting a typical 105-foot steel tower, with photographs showing progressive steps from start to finish. By Milton B. Sleeper.
- CHAPTER 9. Radio Relay Systems**
Page 79
Multiplex systems for remote transmitters, telephones, and telemetering, with cost-per-mile figures of radio relays and wire lines. Methods of multiplexing compared and evaluated.
- CHAPTER 10. Systems Maintenance**
Page 82
Typical routines for 2-way FM systems. Test equipment and service-shop layout. Frequency-checks. By Frank Branley, Supervisor of Radio Maintenance, Connecticut State Police.
- CHAPTER 11. Operator Licenses**
Page 96
License examinations, FCC Regulations concerning operators, and operator requirements. From FCC publications and an explanatory letter from T. J. Slowie, Secretary of FCC.
- CHAPTER 12. General FM Theory**
Page 99
By Rene T. Hemmes, former Assistant Editor of *FM and Television Magazine*. Part 8, devoted to AFC circuits, written by Burt Zimet, former Project Engineer, Freed Radio Corp.

FIRST EDITION

FOREWORD

THE task of planning and producing a book on radio communications is very much like the efforts of a donkey who is pursuing a bundle of hay on the end of a stick attached to his collar. Developments in the field of communications are moving forward so rapidly that there is no point at which a book on this subject can be considered as complete.

This applies to the steady march into higher frequencies, to the new equipment being developed for their use, and to new applications for radio systems.

For example, at this time of writing, the possibilities of the band between 450 and 470 mc. are being investigated. It has been determined that they are ideal for point-to-point and relay services. However, the FCC has not processed such applications on the theory that this band will prove useful for mobile services, thereby relieving congestion on the lower channels. Right now, manufacturers are reserving judgment, but some engineers are of the opinion that, just as the band from 152 to 162 mc. was spurned four years ago but is seriously crowded now, a great demand will develop for the channels from 450 to 470 mc. as soon as a few pioneers move into this area. But we had to forego a chapter on this development, reserving it for the second edition, when data will be more complete.

When the list of chapters for this book was first made up, it did not include any data on selective calling. Then, with the equipment made available from factory production, demand developed faster than the engineers could submit specifications and prices. We were able to include information on units now available. That entailed so much delay that we decided against waiting for operational data which will become available in the near future.

Microwave equipment for point-to-point and relay systems is just coming into use. By postponing the completion of this volume, we could have included details on some of the installations now going into service. But with a flood of inquiries coming in from people who had placed advance orders for this

first edition, we decided against any further delay of the publication date.

Thus, only the chapter on FM theory could be considered complete in any final sense. Even there, we had several excellent suggestions for additional material. This chapter was part of the original FM Handbook. It is slanted somewhat toward broadcasting rather than being directed entirely toward communications. We intended to omit certain parts that are not specifically related to communications, but we were persuaded not to do so by schools and colleges where the section on theory in the FM Handbook has been adopted as a standard text. This is generally considered to be the finest presentation of FM theory that has ever been published. However, in the second edition of the Mobile Radio Handbook we shall add material to this chapter relating specifically to communications equipment and operating frequencies, and to developments in frequency-shift circuits under development for various multiplex services.

Meanwhile, we offer this first edition without apologies for omitting data on developments for which data is not presently available. No doubt, when the second edition is published, there will be as many new things which are at the stage where they must go over to the third. Such is the nature of the art and science of radio, and its progress in the service of mankind.

This Handbook represents the work of many minds. Jeremiah Courtney, Washington attorney and former FCC assistant general counsel in charge of safety and special services, has contributed both text and valuable guidance.

Roy Allison, Associate Editor of Radio Communication (*FM-TV*) has carried the considerable burden of preparing and editing the text for publication, and attending to the multitude of mechanical details.

Specific mention is made in the list of chapters of the individuals who contributed separate parts of the text. Their cooperation is gratefully acknowledged.

MILTON B. SLEEPER

Great Barrington, Mass.

March 3, 1950

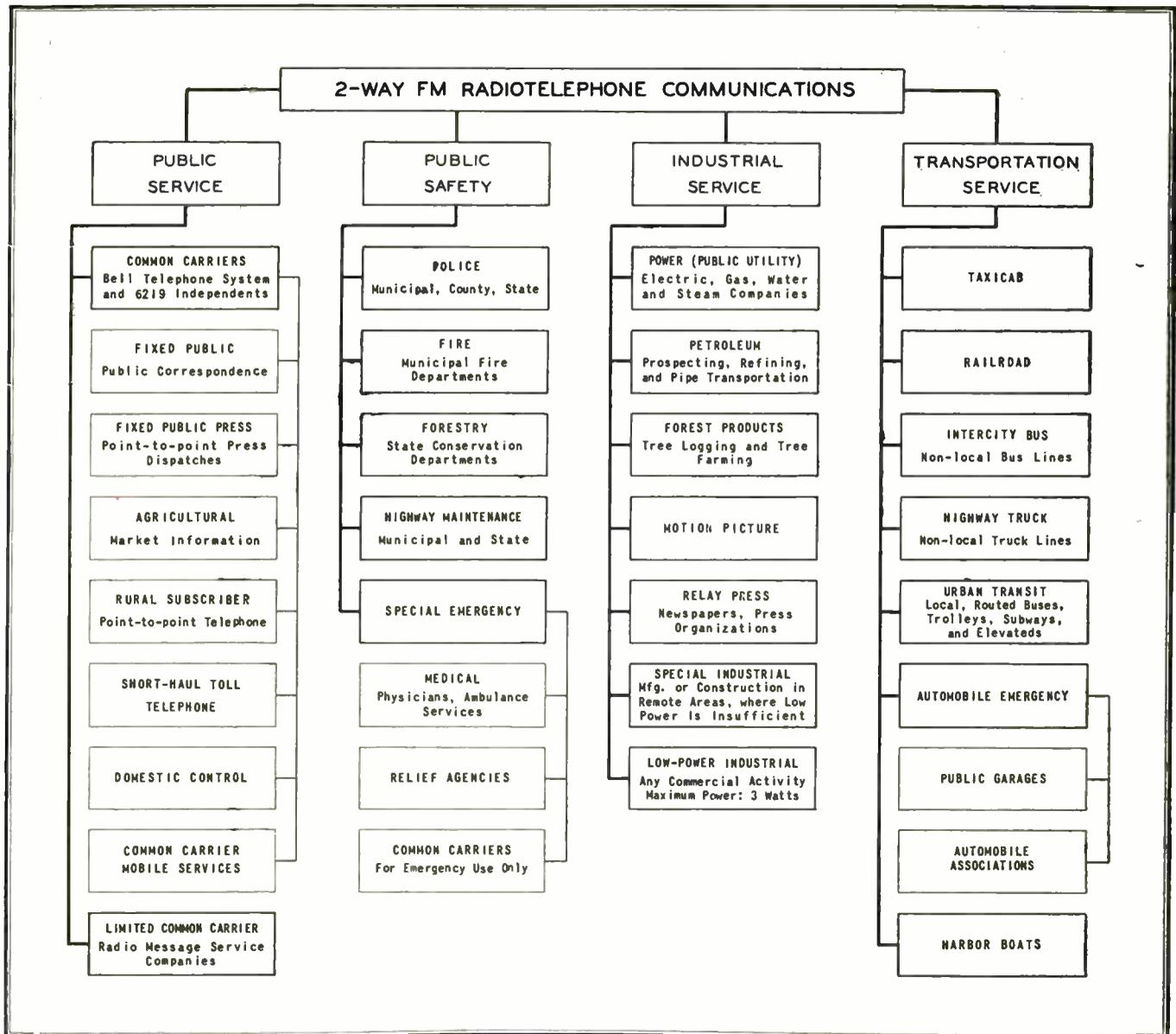

Fig. 1. Here is a complete picture of 2-way FM Communications as set up by FCC rules and allocations effective last July 1st

CHAPTER 1: BASIC SYSTEM PLANNING

BASIC INFORMATION ON SUBJECTS OF PRIMARY IMPORTANCE, WHICH MUST BE CONSIDERED WHEN PLANNING A 2-WAY RADIO COMMUNICATIONS SYSTEM

DURING the first World War, limited use was made of radio telephony for communications purposes, but it was not considered adequate for military purposes. In fact, radio telegraphy was only employed where the wire telegraph could not be set up or maintained.

The first extensive use of the radio telephone was for broadcasting. It was not until this means of public entertainment had developed on a nation-wide scale, and broadcast receivers had been developed for automobiles, that an effort was made to use radio telephony for communication with police cars.

One-way systems, *i.e.*, transmission from headquarters to patrol cars, proved highly successful as an adjunct to police work. A fair degree of reliability was achieved, despite the somewhat inadequate mechanical and electrical design of the equipment, the uncertainty of automobile storage batteries and chargers, the frequent failure of DC plate-voltage supplies for the tubes in the car receivers, and the tendency of municipal officials to rely on local amateurs not only for technical counsel but, frequently, the construction of equipment.

In spite of these handicaps, the speed

and convenience of the radio telephone quickly established its worth, and encouraged established manufacturers to develop and produce improved equipment. One thing was lacking, however, That was a return from the cars to headquarters. The first two-way mobile system ever installed was manufactured and installed by Radio Engineering Laboratories for the police department in Bayonne, N. J., in 1931. It operated on AM, employing a frequency of 31.1 mc. That was considered about the practical limit of high-frequency operation then. The performance was highly satisfactory

over the relatively small area of Bayonne. The only serious fault was susceptibility to static interference. Heterodyne interference, characteristic of AM operation, was not a factor then, because there were no other systems on the same frequency.

The advantages of 2-way operation were easy to demonstrate, but progress was not as rapid as might have been expected, largely due to lack of experienced police radio supervisors. Major Armstrong had demonstrated his static-free FM system in 1935, but that equipment was elaborate enough to fill a patrol car, and even crowd out the driver.

Then, in 1938, Commissioner Edward J. Hickey, of the Connecticut State Police, engaged Prof. Daniel E. Noble, then teaching at the University of Connecticut, to plan a state-wide police radio system. Professor Noble proposed that FM be used, in order to overcome static and interference that might develop from co-channel operation of new systems. No suitable equipment was available commercially, but its development and production was undertaken by Fred M. Link.

Equipment for 12 fixed stations and 250 cars was completed and put into operation¹ in 1940 with a surprising absence of trouble, and in much less time than had been widely predicted. Performance was completely satisfactory from the start.

Other manufacturers undertook the development of mobile FM equipment, adding to engineering information and operating experience. When, in 1941, all civilian radio production was halted, FM was making rapid strides. The use of mobile radio was virtually limited, however, to police service. There were a few public utility systems, and a small assortment of special installations.

During the second World War, the manufacture of FM communications equipment was continued under WPB allocation, and many new police systems were authorized, particularly in strategic coastal areas and industrial centers. The U.S. Navy had a very elaborate FM mobile system of nearly world-wide extent.²

FM equipment was adopted for tank communications, and many of the Army's mobile services. Probably the most widely-used military FM equipment was the famous Walkie-Talkie. Also FM relay equipment was developed and used over long European circuits where wires could not be maintained. Much of the traffic across the English Channel was

handled on FM, too. The wartime Handie-Talkie used AM circuits, but in 1948 a new Signal Corps design, using FM, was adopted as the new standard.

Thus, all through the war, the development of FM equipment and its application to new services made rapid strides, while its superiority over AM for short hauls or long-distance relays became known to Army and Navy radio engineers. That explains the enormous demand for civilian FM communications after the war was over.

Available frequency assignments soon proved inadequate because it was found that many new kinds of services could use FM to great advantage. Finally, in 1948, the Federal Communications Commission undertook an exhaustive study of the needs of the various services, in order to set up revised frequency allocations and rules. This work was completed in May 1949, and the new allocations and rules were made effective the following July 1.

Fig. 1 is a chart of the various services now authorized to use 2-way radio telephone communications on frequencies above 25 mc. While the FCC does not require FM operation, it is now used to the virtual exclusion of AM, not only for mobile systems but for point-to-point and relay installations. This even includes the AT & T radio relays, now being extended from Boston and New York to Chicago and on to San Francisco, for multiplex telephone circuits and television networking.

As the chart shows, there are four principal service groups. Only the public service group is authorized to handle paid traffic. The others are limited to the use of the licensee. Chapter 2 contains a resumé of FCC rules applying to each of the services listed in the chart, together with the complete frequency allocations.

Planning a System:

Since radio communications serve to protect human lives or property, or to speed essential business services, the plans for a new system must be worked out with great care, and with the benefit of expert legal and engineering advice. There are five primary factors in initial planning. These are: 1) selection of the most advantageous frequency or frequencies for the particular purpose of the type of system to be operated and the coverage required, 2) consideration of present and future interference from other systems, 3) the method of operating and maintaining the system, 4) possible requirements of future expansion or inter-connection with other systems, and 5) the purchase of land or acquirement of rights to erect antennas, the legal problems of city ordinances and public liability, and provi-

sions for telephone connections, electric power, and emergency power.

Because of the widely varying purposes for which radio communication is used, it is obviously impossible to detail plans covering all types of services. However, the five basic factors just listed will be discussed in general terms here for purposes of overall guidance.

1. Selection of Frequencies:

When an application for a radio system is filed with the FCC, the operating frequency or frequencies must be specified. This is explained in detail in Chapter 3. It is a matter calling for expert engineering counsel, since the decision must give notice not only to the availability of channels under the FCC allocations plan, but to co-channel and adjacent-channel use by other systems, the conditions of present and future channel loading, and any special rulings that may have been made by the FCC.

Also, there are various organizations which serve in varying degrees to assist new applicants in the selection of frequencies and, in an unofficial but nevertheless definite manner, to screen new applications before they reach the FCC.

Legal counsel will be found highly useful for handling the preparation and filing of the application. It must be remembered that only attorneys specifically authorized to do so can represent clients before the Commission. The reason is that FCC rules and practices must be followed, and corporation lawyers, whatever their other qualifications, are not familiar with them.

Most important of all, the frequencies must be integrated with the plan of the system and the topography of the area to be served. Not one of these elements can be decided independently of the other. If the area is limited to 10 or 12 miles radius over flat terrain, for example, a frequency in the band from 152 to 174 mc. might be suitable. The availability of a tall building or high ground might extend the coverage substantially. High ground near the perimeter of the area to be served might cast a shadow over an important section, or where service may be required later.

When a large area is to be covered, there would be a choice between using a frequency between 30 and 50 mc. for a single transmitter, or perhaps using repeater stations in the higher band. Some systems can talk out and back on the same channel. Others require two separate channels.

These are just a few instances of the correlation between frequencies, system planning, and topography. The foregoing may sound complicated. In practice, it can be compared to the factors of function, location, and materials which

¹ See Link Designs FM for Police, *FM MAGAZINE*, December, 1940; "State-Wide Two-Way FM System," by Edward J. Hickey, and "Two-Way Police FM Performance," by Sydney E. Warner, *FM MAGAZINE*, Jan. 1941.

² "The Navy's Wartime FM Emergency System," by Condr. H. J. Waters, *FM AND TELEVISION*, Feb. 1946.

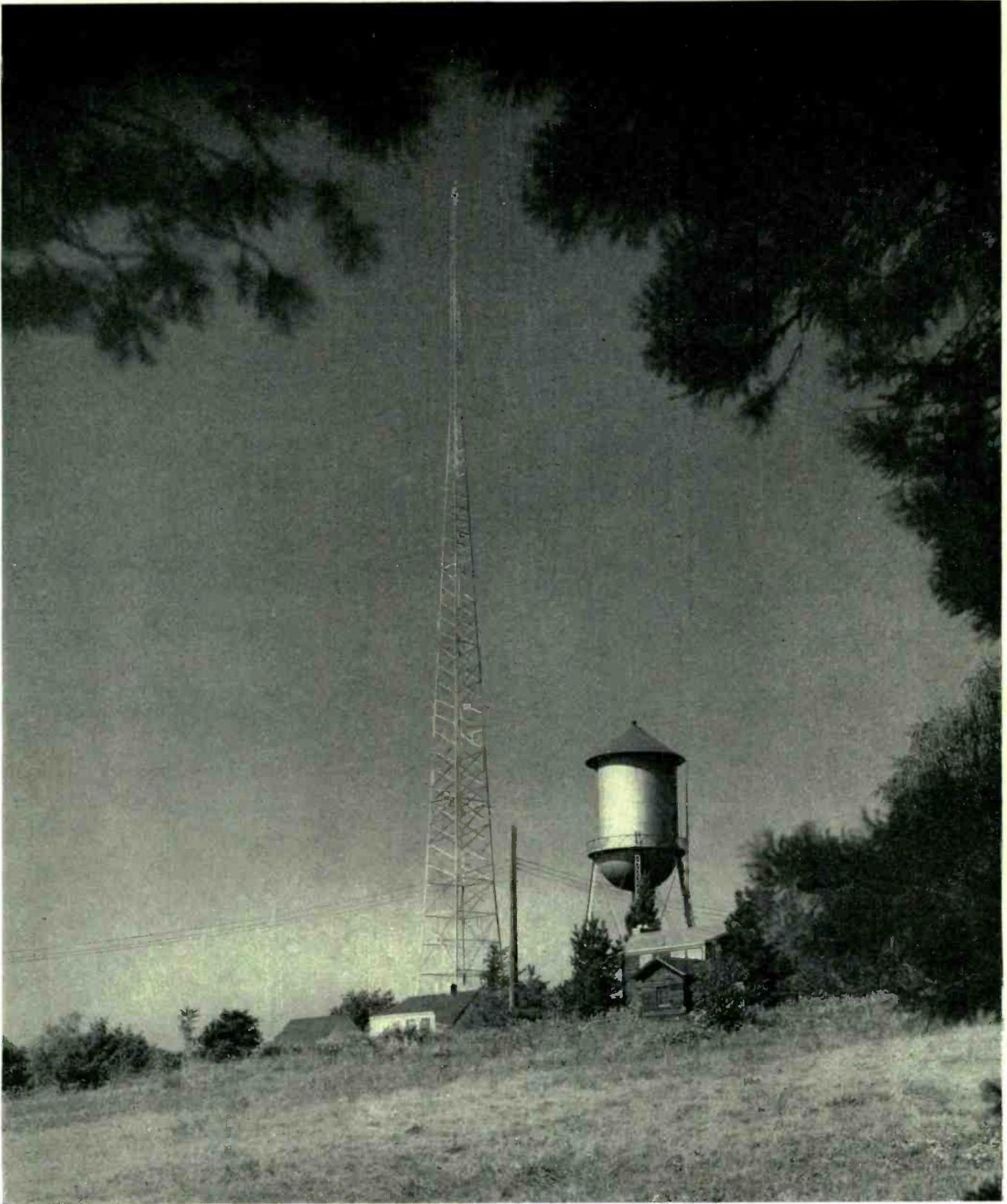

Fig. 2. This Blaw-Knox tower was erected for the Police Department at a hilltop residential section of Erie, Pa. The system also serves the Fire Department and the County Sheriff's Office. Lieut. Louis Raub is engineer in charge

must be considered by an architect who is designing an industrial building.

2. Present & Future Interference:

Interference depends on location as well as present and possible future use of frequencies assigned to a particular service. Present use in a particular area may be

limited now, but if the service is one of those not established prior to July 1, 1949, potential demand may be great.

In selecting a particular frequency, it is not enough to consider interference caused by others to one's own system. Causing interference with others may prove equally embarrassing. It is as im-

portant not to be complained against as not to have a reason for complaining.

Thus, both frequency and power must be weighed, since they are both factors of interference. Under some circumstances there may be a choice, for example, between using one transmitter of high power on a low frequency, or a low-

power main transmitter and repeaters on a higher frequency.

The FCC has already recommended that the use of channels from 452 to 460 mc. be developed, to relieve congestion on the lower bands. There are 20 channels each for land transport, public safety, industrial, and domestic public services. Some manufacturers had development projects in this new band under way at the beginning of 1950, and communications engineers have expressed the opinion that the demand for assignments between 452 and 460 mc. will soon be as active as was the case two years after the 152- to 162-mc. band was made available.

3. Operation and Maintenance:

The operation of a communications system involves the handling, dispatching, and recording of message traffic and, usually, the coordination of the message traffic with other activities. A taxi system does not merely transmit and receive calls. Important as the radio operation may be, it is only part of the total service of getting people where they want to go in the shortest time possible, and with a minimum of dead mileage.

The success of a taxi radio system depends upon the care with which the total plan is laid out, from the locations of the control point and the transmitter to the facilities for receiving incoming calls and handling the orders, and from the training of operators and drivers to the stocking of spare radio parts and the schedule of maintaining equipment.

The functions of a police system, to take another example, extend far beyond the obvious use of sending cars to scenes of accidents and crimes within city limits. Police use must be coordinated with systems operated by adjacent towns and the state police, and also with the local fire department, the constable's office, and the city hospital ambulance.

Legal aspects of records require careful study. Messages must be coded to limit the amount of information which can be picked up by people who can tune in police frequencies. Operators must be instructed concerning the use of names on the air, for carelessness in that respect may have serious political repercussions.

The use of selective calling requires careful study. There are two basic methods. The first is so designed that all car speakers in a fleet are muted except when their main station goes on the air. Thus no calls from other systems are heard. Fleet calling serves the important function of eliminating distracting chatter on busy channels, since the drivers only hear calls that may be intended for them. Also, they know that they must listen to every call that comes in.

A modification of this control is group calling, used where one transmitter serves different city departments, or the police departments of several adjacent towns. If the main station is asked to transmit a call to the cars of town A, a corresponding signal is sent out before the message, and only the speakers in town A's cars are turned on. The message is not heard in cars operated by towns B and C.

The second method of selective calling permits the main station operator to turn on the speaker in any single car of his fleet, whether there are half a dozen or several hundred cars in the system. When a car is called, a signal light shows on the dashboard, and is extinguished only when the driver answers. If required, a call buzzer or bell can be added.

Both methods are coming rapidly into wide use, and already numerous variations of the basic equipment are being employed for telemetering, remote switching, and the control of relay systems.

Operating plans vary with the particular type of service, and the requirements of individual systems. The basic consideration is the extent of traffic records considered necessary. They may be very elaborate, or boiled down to the simple operating log of the station required by the FCC.

Time on the air must be reduced to an absolute minimum by careful observation of the following rules.

1. Messages must be confined to official business.

2. Abbreviations should be used, and all unnecessary conversation eliminated.

3. Consideration must be given to others operating on the same frequency.

4. Operators should be chosen for the quality of their voices, and they should be thoroughly instructed in the use of the microphone, in order to reduce mistakes and repeats due to lack of speech intelligibility. Women's voices are generally superior in that respect to men's voices.

5. When the details of operating practice have been worked out, they should be made available in written form to each person operating the headquarters station or the mobile units, and the standard practice adhered to strictly by all concerned.

The plan of operation must include a schedule of maintenance. This subject is discussed in Chapter 10. It is sufficient at this point to emphasize the fact that the performance of any system regardless of the original quality of the equipment, depends upon:

1. The ability and thoroughness of the man in charge of maintenance, and his assistants.

2. Consistent follow-through of the

maintenance program that is set up.

3. The adequacy and precision of the test instruments provided for this work.

Particular attention must be paid to the selection and use of instruments for measuring frequency and modulation, for FCC is requiring more and more strict observance of limits specified in the rules in order to accommodate an increased number of systems on the channels available.

4. Expansion & Interconnection:

Plans for a communications system should always take into account possible future need for expanding the initial installation, and interconnection with other systems. A point is made of this because operators invariably find many uses for communications not contemplated originally. It is rare indeed that, after a year or even a few months, the use of the system is confined to the specific purpose for which it was installed.

Two-way radio is such a versatile tool that added applications are sure to be found. Therefore, the initial system should be planned in open-end fashion, so that it can be expanded, as time indicates, without having to discard any of the original equipment. This applies particularly to transmitter power, both at headquarters and in the mobile units. Today, it may seem that a relatively limited range will be adequate. Tomorrow, it may be found that the usefulness of the system would be doubled by the availability of added power to cover a few extra miles.

5. Miscellaneous Problems:

Legal as well as engineering counsel is required in the setup of a communications system. If land is purchased or rented for a tower, there are problems of local ordinances and zoning restrictions to consider, and the matter of access to the site. If the antenna is to be on a building, a permit may be required from the building department. Also, the structure of the building must be studied. It may require reinforcement, and there may be difficulties about getting the materials to the roof.

Insurance must be provided to cover all contingencies while construction is under way, and after it is completed.³ A special construction hazard is damage to adjacent buildings when paint is blown in the wind. It may carry for surprising distances!

The operating headquarters must be connected to the transmitter by telephone line or radio link. If remote operation is required, a comparative study of the two methods should be made. Fre-

³The subject of insurance is discussed in "Radio Station Insurance," *FAM-TI* MAGAZINE, Jan., Feb., April, 1947.

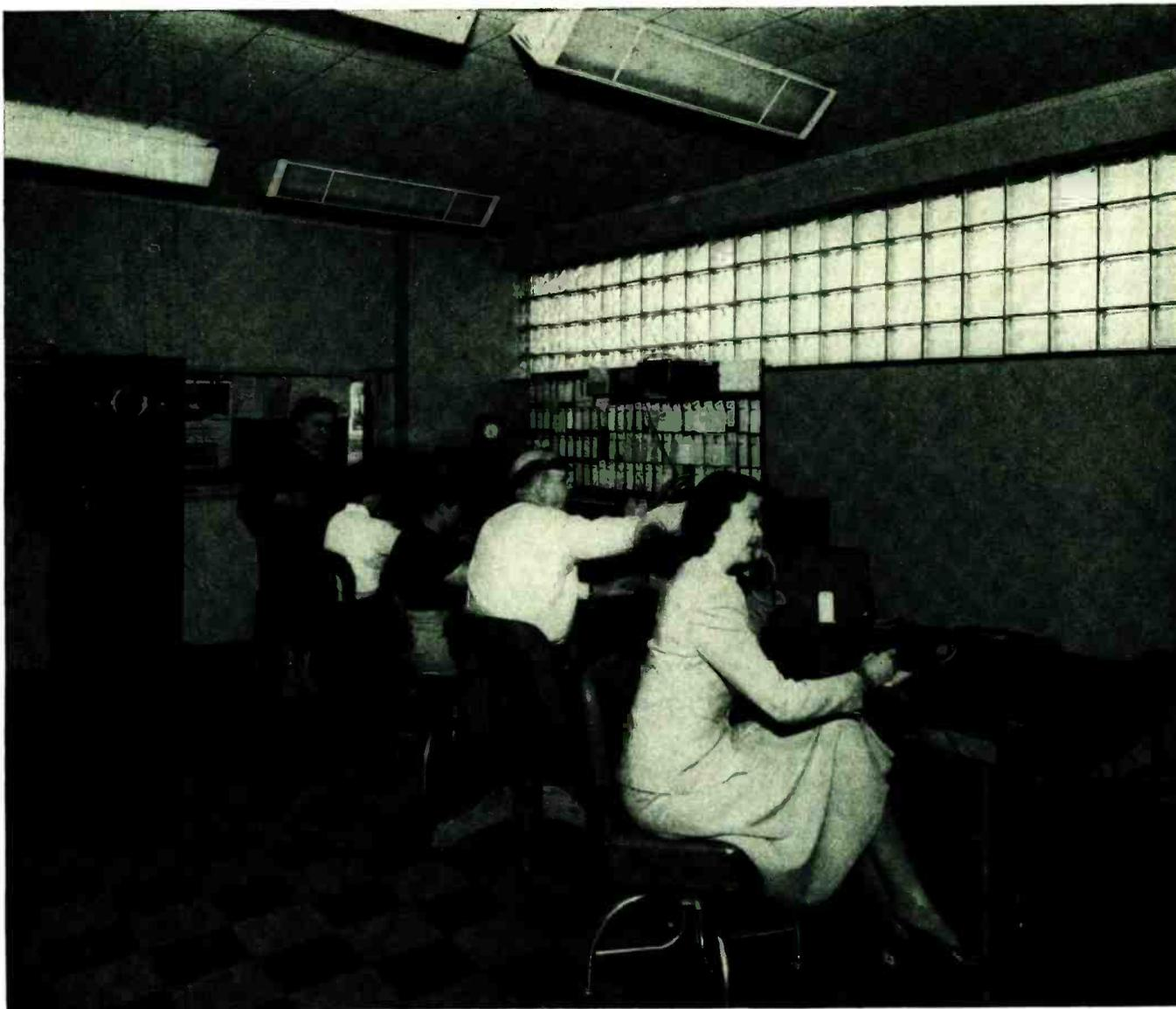

Fig. 3. A dispatching office for handling taxicab communications. This is a Motorola installation, operated by the Erie Cab Co.

quently, a substantial saving can be effected by the use of the latter.

Sometimes, the final choice between two transmitter sites is determined by the availability of electric power, or the cost of running it in. Since radio communication is generally needed most during adverse weather conditions, it is necessary to guard against possible service

interruptions due to sleet and falling trees.

It is usually advisable to provide a source of emergency power from a gasoline engine-driven generator of sufficient power to supply the transmitter and lights for the building, if needed, and the tower. These generators are self-starting, and turn on automatically when the outside

power fails. At unattended installations, it is now standard practice to use an audio-frequency beeper which is cut in at the transmitter whenever the emergency generator is operating. The beeper note, heard on the monitor at the operating-point warns of power failure, and the need of replacing the fuel being used by the gasoline engine.

FCC ALLOCATIONS
Effective July 1, 1949

Service	Frequency Range	Service	Frequency Range	Service	Frequency Range
INDUSTRIAL	25.01-25.33	INDUSTRIAL, SCIENTIFIC, MEDICAL EQUIPMENT²	40.68	PUBLIC SAFETY	154.62-156.25
16 20-kc. channels		PUBLIC SAFETY	42.00-42.96	27 60-kc. channels	
GOVERNMENT	25.33-25.85	24 40-kc. channels		MARITIME MOBILE — (PUB. SAFETY)^{1,10,11,12}	156.25-157.15
INTL. BROADCASTING	25.85-26.10	INDUSTRIAL	42.96-43.00	9 100-kc. channels	
REMOTE BCST. PICKUP	26.10-26.48	1 40-kc. channel		GOVERNMENT	157.15-157.35
19 20-kc. channels		INDUSTRIAL —		MARITIME MOBILE — (PUBLIC SAFETY)	157.35-157.45
GOVERNMENT	26.48-26.95	MARITIME MOBILE	43.00-43.20	1 100-kc. channel	
INTL. FIXED PUBLIC	26.95-26.96	5 40-kc. channels		TAXICABS	157.45-157.74
1 10-kc. channel		DOMESTIC PUBLIC —		4 60-kc. channels	
AMATEUR	26.96-27.23	LAND TRANSPORT	43.20-44.00	DOMESTIC PUBLIC	157.74-158.10
INDUSTRIAL, SCIENTIFIC		20 40-kc. channels		6 60-kc. channels	
MEDICAL EQUIPMENT¹	27.12	LAND TRANSPORT.	44.00-44.60	INDUSTRIAL	158.10-158.46
EXPERIMENTAL	27.23-27.28	15 40-kc. channels		6 60-kc. channels	
INDUSTRIAL	27.28-27.54	PUBLIC SAFETY	44.60-47.68	DOMESTIC PUBLIC	158.46-158.70
13 20-kc. channels		77 40-kc. channels		4 60-kc. channels	
GOVERNMENT	27.54-28.00	INDUSTRIAL	47.68-50.00	PUBLIC SAFETY	158.70-159.48
AMATEUR	28.00-29.70	58 40-kc. channels		13 60-kc. channels	
INDUSTRIAL	29.70-29.80	AMATEUR	50.00-54.00	LAND TRANSPORT — (PUBLIC SAFETY)¹³	159.48-161.85
5 20-kc. channels		TELEVISION BCST.	54.00-72.00	39 60-kc. channels	
AERO. FIXED —		3 6-mc. channels		MARITIME MOBILE	161.85-162.00
INTL. FIXED PUBLIC	29.80-29.89	OPERATIONAL FIXED — (DOM. FIXED PUBLIC)¹⁴	72.00-74.60	COAST	
8 10-kc. channels		65 40-kc. channels		2 channels:	
GOVERNMENT	29.89-29.91	AERO. MARKER	74.60-75.40	{ 161.9 & 162.0 } ^{10,14}	
AERO. FIXED —		BEACON¹⁶	75.40-76.00	GOVERNMENT^{15,16}	162.00-174.00
INTL. FIXED PUBLIC	29.91-30.00	15 40-kc. channels		(REMOTE BCST. PICKUP) ¹⁷	
8 10-kc. channels		OPERATIONAL FIXED	75.40-76.00	TELEVISION BCST.	174.00-216.00
GOVERNMENT	30.00-30.56	2 6-mc. channels		7 6-mc. channels	
INDUSTRIAL	30.56-30.64	FM BCST.⁷	88.00-108.00	GOVT. TELEMETER¹⁸G	216.00-220.00
2 40-kc. channels		100 200-kc. channels		AMATEUR	220.00-225.00
INDUSTRIAL —		AERO. LOCALIZER	108.00-112.00	GOVERNMENT	225.00-328.60
LAND TRANSPORT.	30.64-30.84	39 100-kc. channels		AERO. GLIDE PATH	328.60-335.40
5 40-kc. channels		AERO. RADIO RANGE	112.00-118.00	GOVERNMENT	335.40-400.00
LAND TRANSPORT.		59 100-kc. channels		RADIOSONDE	400.00-406.00
PUBLIC SAFETY	30.84-31.16	AIRDROME CONTROL	118.00-121.40	GOVERNMENT	406.00-420.00
8 40-kc. channels		33 100-kc. channels		AMATEUR	420.00-450.00
PUBLIC SAFETY	31.16-32.00	AERO. MOBILE	121.40-121.60	REMOTE BCST. PICKUP	450.00-452.00
21 40-kc. channels		AERO. UTILITY	121.60-122.00	20 100-kc. channels	
GOVERNMENT	32.00-33.00	2 200-kc. channels		LAND TRANSPORT	452.00-454.00
PUBLIC SAFETY	33.00-33.12	PRIVATE AIRCRAFT	122.00-123.00	20 100-kc. channels	
3 40-kc. channels		5 200-kc. channels		PUBLIC SAFETY	454.00-456.00
INDUSTRIAL	33.12-33.40	FLIGHT TEST —		20 100-kc. channels	
7 40-kc. channels		FLYING SCHOOL	123.00-123.60	INDUSTRIAL	456.00-458.00
PUBLIC SAFETY	33.40-34.00	3 200-kc. channels		20 100-kc. channels	
15 40-kc. channels		AERO. MOBILE	123.60-132.00	DOMESTIC PUBLIC	458.00-460.00
GOVERNMENT	34.00-35.00	42 200-kc. channels		20 100-kc. channels	
INDUSTRIAL	35.00-35.04	GOVERNMENT	132.00-144.00	CITIZENS RADIO	460.00-470.00
1 40-kc. channel		AERO. MOBILE³	140.58	FACSIMILE BCST.	470.00-475.00
INDUSTRIAL —		AMATEUR	144.00-148.00	BROADCASTING	475.00-500.00
MARITIME MOBILE	35.04-35.20	GOVERNMENT	148.00-152.00	TELEVISION BCST.	500.00-890.00
4 40-kc. channels		DOMESTIC PUBLIC	152.00-152.24	BROADCASTING	890.00-940.00
DOMESTIC PUBLIC —		4 60-kc. channels		INDUSTRIAL, SCIENTIFIC, MEDICAL EQUIPMENT^{19,15,20}	940.00-952.00
LAND TRANSPORT	35.20-36.00	TAXICABS	152.24-152.48	FM BCST. S-T LINK¹⁸	940.00-952.00
20 40-kc. channels		4 60-kc. channels		INTL. CONTROL —	
GOVERNMENT	36.00-37.00	DOMESTIC PUBLIC	152.48-152.84	OPERATIONAL FIXED	952.00-960.00
PUBLIC SAFETY	37.00-37.44	6 60-kc. channels		AERO. NAVIGATION	960.00-1,215
11 40-kc. channels		INDUSTRIAL —		AMATEUR	1,215-1,300
INDUSTRIAL	37.44-37.88	(REMOTE BCST. PICKUP)⁹	152.84-153.38	SURVEILLANCE RADAR	1,300-1,365
11 40-kc. channels		9 60-kc. channels		AERO. NAVIGATION	1,365-1,660
PUBLIC SAFETY	37.88-38.00	INDUSTRIAL	153.38-153.74	RADIOSONDE	1,660-1,700
3 40-kc. channels		6 60-kc. channels		GOVERNMENT	1,700-1,850
GOVERNMENT	38.00-39.00	PUBLIC SAFETY	153.74-154.46	INTL. CONTROL —	
PUBLIC SAFETY	39.00-40.00	12 60-kc. channels		OPERATIONAL FIXED	1,850-1,990
25 40-kc. channels		INDUSTRIAL	154.46-154.62		
GOVERNMENT	40.00-42.00	2 80-kc. channels			

¹Emissions from industrial, scientific, and medical equipment using the frequency 27.12 mc. must be confined to the band 26.96-27.28 mc.

²Emissions from industrial, scientific and medical equipment using the frequency 40.68 mc. must be confined to 40.66-40.70 mc.

³Operational fixed stations may be authorized to use frequencies in this band on the condition that harmful interference will not be caused to the reception of television stations on channels 4 or 5. In any area in the continental United States, the aviation service and marine service may each be authorized to use four of the frequencies in the band 72.76 mc. listed for operational fixed stations in these services.

⁴Fixed stations in the domestic fixed public service may be authorized to use any of the frequencies in the band 72.76 mc. on the conditions that at harmful interference will not be caused to the reception of television stations on channels 4 or 5, and that harmful interference will not be caused to operational fixed stations.

⁵The frequency 75 mc. is designated for aeronautical marker beacons. In Region 1, the guardband is ± 0.2 mc; in Regions 2 and 3, ± 0.4 mc.

⁶The use of the frequency 75 mc. by aeronautical marker beacons is temporary and may be authorized until they are moved to a frequency band allocated for the aeronautical radionavigation service, or until they are no longer required.

⁷Facsimile broadcast may be authorized in the band 88-108 mc.

⁸The frequency 140.58 mc. may be authorized on an interim basis to civil aviation as a common simplex frequency for emergency and distress communications, available to all stations operating in or with the aeronautical mobile service.

⁹The use of the frequencies in the block 152.87-153.35 mc. may be authorized, in any area, to remote pickup broadcast base and mobile stations on the condition that harmful interference will not be caused to the industrial radio services.

¹⁰The use of the frequencies 156.27, 156.33, 156.39, 156.45, 156.51, 156.57, 156.63, 156.69, 156.75, 156.87, 156.93, 156.99, 157.05, 157.11, 157.17, 157.47, 161.85, 161.91 and 161.97 mc. may be authorized to base and land mobile stations in the public safety radio services on the condition that no harmful interference will be caused to the maritime mobile service. Public safety service operations at points within 150 miles of coastal areas and navigable gulf, bays, rivers and lakes, may be authorized only after a factual finding indicates that, on an engineering basis, no harmful interference will be caused to the maritime mobile service.

¹¹The international port operational service, on a simplex basis, has priority on this frequency.

¹²The frequency 156.80 mc. has been designated for world-wide use for safety, calling and intership and harbor control communications in the maritime mobile service.

¹³The use of the frequencies in the block 159.51-161.79 mc. may be authorized to base and land mobile stations in the public safety radio services, in any area, on the condition that harmful interference will not be caused to stations in the railroad radio service.

¹⁴In the Chicago area, only the frequencies 161.85 mc. and 161.91 mc. may be authorized to base and land mobile stations only for train communications in the railroad radio service.

¹⁵The government frequencies, 170.425, 170.475, 170.575, 171.425, 171.475, 171.575, 172.225, 172.275, and 172.375 mc. may be authorized to fixed, land and mobile stations owned and operated by non-Federal forest fire fighting agencies, in certain areas, on the condition that no harmful interference will be caused to any government stations.

¹⁶In order to provide for inter-communication for safety purposes between government and non-government stations in the maritime mobile service, the frequencies 157.2 and 157.3 mc. are allocated exclusively in all areas, to government stations in the fixed and mobile services, and the frequencies 173.225, 173.275, 173.325, 173.375 mc. are allocated exclusively, in all areas, to non-government stations in the fixed and land mobile services.

¹⁷The use of the frequencies 166.250 and 170.150 mc. may be authorized to non-government remote pickup broadcast base and land mobile stations and to non-government base fixed and land mobile stations in the public safety radio services (the sum of the band width of emission and tolerance not to exceed 60 Kc.) in Continental U. S. only, except within the area bounded on the west by the Mississippi River, on the north by the parallel of latitude 37° 30' N., and on the east and south by that arc of the circle with center at Springfield, Ill., and radius equal to the airline distance between Springfield, Ill., and Montgomery, Ala., subtended between the foregoing west and north boundaries, on the condition that harmful interference will not be caused to government stations present or future in the government band 162-174 mc. The use of these frequencies by remote pickup broadcast stations will not be authorized for locations within 150 miles of New York City; and the use of these frequencies by the public safety radio services will not be authorized for locations within 150 miles of New York City.

¹⁸Interim FM relay stations may be authorized to use the band 940-952 mc. on the condition that harmful interference will not be caused to stations operating in accordance with the table of frequency allocations.

¹⁹Interim television relay stations may be authorized to use frequencies in this band on the condition that harmful interference will not be caused to stations operating in accordance with the table of frequency allocations.

²⁰Emissions from industrial, scientific and medical equipment using the frequency 10,600 mc. must be confined to the band 10,500-10,700 mc. Sharing by radio-communication services is to be determined at a later date.

²¹Emissions from industrial, scientific and medical equipment using the frequency 18,000 mc. must be confined to the band 17,850-18,150 mc. Radiocommunication services operating within the band 17,850-18,150 mc. must accept any harmful interference that may be experienced from the operation of industrial, scientific and medical equipment.

CHAPTER 2: RULES & ALLOCATIONS

A QUICK-REFERENCE GUIDE TO THE FREQUENCY ASSIGNMENTS AND TECHNICAL REQUIREMENTS FOR ALL THE VARIOUS CLASSES OF MOBILE RADIO SERVICES

THE new FCC allocations and rules for radio communications systems, effective July 1, 1949, introduce so many changes and open the way for such expansion of present services and the inauguration of new ones that everyone concerned with mobile communications must equip himself with this new information.

The Commission's report on the new rules and allocations explains that six general principles were established as guides in making the final determinations. These were:

1. The Commission examined each request for frequencies to determine whether the service really required the use of radio or if wire lines were a practical substitute. With an acute shortage of frequencies, it would not be in the public interest to assign a portion of the spectrum to a service which could adequately and feasibly use wire lines instead of radio. The Commission's determination was not limited to technical considerations, but also took into account economic and social factors, and considerations of national policy.
2. The Commission determined that all radio services should not be evaluated alike. Radio services which are necessary for the safety of life and property deserve more consideration than those services which are more in the nature of convenience and luxury.
3. The Commission considered the total number of persons who would probably receive benefits from a particular service. Where other factors were equal, the Commission attempted to meet the requests of those services which proposed to render benefits to large groups of the population, rather than of those communications services which would aid relatively small groups.
4. The fourth principle related to consideration of the proper place in the spectrum for the service, based upon engineering consideration of propagation characteristics in different portions of the spectrum. Certain frequencies can be used more effectively by services requiring comparatively long range communications, while others are better suited for short range communications.
5. The fifth principle also pertained to assignment of each service to its proper place in the spectrum. In determining competing requests of two or more services for the same frequencies, where one or more of the services involved had already been assigned frequencies on a regular basis, the Commission gave careful

consideration to the number of transmitters and receivers already in use, the investment of the industry and the public in equipment, and the cost and feasibility of converting the equipment for operation on different frequencies.

6. The Commission considered the necessity of achieving international standardization of maritime mobile service allocations around the international calling frequency of 156.8 mc.

The Service Classifications:

Various existing types of communications services have been reclassified, and others have been added. It is necessary, therefore, to understand the new major classifications, and the types of services grouped under each heading. As set up now, they are:

FIXED PUBLIC SERVICES

1. Fixed Public
2. Fixed Public Press
3. Agricultural
4. Rural Subscriber
5. Short-Haul Toll Telephone
6. Domestic Control

DOMESTIC PUBLIC LAND MOBILE SERVICES

1. Common carrier
2. Limited common carrier

PUBLIC SAFETY RADIO SERVICES

1. Police (phone, and zone and inter-zone telegraph)
2. Fire
3. Forestry-Conservation
4. Highway Maintenance
5. Special Emergency
6. Developmental

INDUSTRIAL RADIO SERVICES

1. Power
2. Petroleum
3. Forest Products
4. Motion Picture
5. Relay Press
6. Special Industrial
7. Low-Power Industrial
8. Developmental

LAND TRANSPORTATION RADIO SERVICES

1. Intercity Bus
2. Highway truck
3. Railroad
4. Taxicab
5. Urban Transit
6. Automobile Emergency
7. Developmental

MARITIME MOBILE RADIO SERVICES

1. Boat and Tugboat

An examination of the Rules shows some confusion in the arrangement of information on these services, but the listing above follows the FCC text.

FIXED PUBLIC SERVICES

(Docket No. 9046, Part 6)

FIXED PUBLIC SERVICE

FIXED PUBLIC SERVICES include point-to-point radio communication by telephone, telegraph or facsimile transmission between stations handling 1) public correspondence, 2) press dispatches for newspapers, and 3) agricultural market information. No information is given as to operating frequencies.

RURAL SUBSCRIBER SERVICE

RURAL SUBSCRIBER SERVICE is only referred to in Part 6 by a footnote stating that rules governing this point-to-point service will be promulgated at a later date. However, it is specified that all frequencies assigned to domestic public land mobile services between 152 and 162 mc. are available for rural subscriber service.

SHORT-HAUL TELEPHONE

SHORT-HAUL TOLL TELEPHONE SERVICE is only referred to in Part 6 by a footnote stating that rules governing this point-to-point service will be promulgated at a later date. However, it is specified that all frequencies assigned to domestic public land mobile services are available for short-haul toll telephone service provided that no interference is caused to the land mobile service.

DOMESTIC CONTROL STATIONS

DOMESTIC CONTROL STATIONS are defined as "a fixed station in the fixed public control service, associated directly with the domestic public radio communication service." No further details of this service are given, except to specify that all frequencies assigned to domestic public land mobile services between 152 and 162 mc. are available for domestic control stations provided no interference is caused to the land mobile, short-haul toll telephone, or rural subscriber telephone services.

DOMESTIC PUBLIC LAND MOBILE RADIO SERVICE

(Docket No. 9046, Part 6)

COMMON CARRIER SERVICE

Common carrier mobile systems are those operated by companies "which are also in the business of affording public landline message telephone service."

Frequency Assignments:

The following frequencies are available, some of which are to be assigned on the zone plan detailed below:¹

BASE STATIONS Mc.	MOBILE, AUXILIARY TEST, OR SUBSCRIBER FIXED STATION, Mc.
35.22 ²	152.51
35.26	152.57
35.30	152.63
35.34	152.69
35.38	152.75
35.42	152.81
35.46 ²	43.22 ²
35.50	43.26
35.54	43.30
35.58	43.34
35.62	43.38
35.66	43.42
	43.46 ²
	43.50
	43.54
	43.58 ³
	43.62
	43.66

¹ All frequencies listed between 152 and 162 mc. are available for assignment to the rural subscriber and short-haul toll telephone services on a geographical or frequency separation basis, provided that no interference is caused to the land mobile service. Rules to govern these point-to-point services will be promulgated at a later date.

² All frequencies listed are available for assignment to developmental stations provided no interference is caused to the mobile services.

³ All frequencies listed between 152 and 162 mc. are available for assignment to domestic control stations, provided no interference is caused to the mobile, short-haul toll telephone, or rural subscriber services.

⁴ These frequencies are also designated for assignment to base and mobile stations using facsimile as an integral portion of common carrier telegraph message handling or delivery procedure.

⁵ This frequency is also designated for assignment to common carriers offering only a one-way signalling service to mobile receivers, for actuating a signalling device in the mobile unit.

Zone Allocation Plan:

Certain base and mobile station frequencies will be assigned as follows:

ZONE I, Base 35.66 mc., Mobile 43.66 mc.

Maine	New Jersey
New Hampshire	Pennsylvania
Vermont	Delaware
Connecticut	Maryland
Massachusetts	District of Columbia
Rhode Island	Virginia
New York	West Virginia

ZONE II, Base 35.34 mc. Mobile 43.34 mc.

North Carolina	Alabama
South Carolina	Mississippi
Georgia	Louisiana
Florida	

ZONE III, Base 35.42 mc., Mobile 43.42 mc.

Tennessee	Illinois
Kentucky	Wisconsin
Ohio	Michigan
Indiana	

ZONE IV, Base 35.54 mc., Mobile 43.54 mc.

Minnesota	Nebraska
Iowa	Montana
North Dakota	Wyoming
South Dakota	

ZONE V, Base 35.30 mc., Mobile 43.30

Missouri	Oklahoma
Kansas	Texas

ZONE VI, Base 35.38 mc., Mobile 43.38

Colorado	Arizona
----------	---------

New Mexico Nevada
Utah California
ZONE VII, Base 35.26 mc.,
Mobile 43.26 mc.
Oregon Idaho Washington

Technical Information:

EMISSION LIMITATIONS: Bandwidth for AM phone is 8 kc.; for FM phone, 40 kc. The specified band shall contain those frequencies upon which a total of 99% of the radiated power appears, extended to include any discrete frequency upon which the power is at least 0.25% of the total radiated power. Radiation in excess of these limits is considered unauthorized emission. Any emission appearing on any frequency removed from the carrier frequency by at least 50%, but not more than 100% of the maximum authorized bandwidth shall be attenuated not less than 25 db below the unmodulated carrier. Spurious or harmonic emission on any frequency removed from the carrier by at least 100% of the maximum authorized bandwidth shall be attenuated below the unmodulated carrier by not less than:

40 db with maximum plate power input to the final RF state of 3 watts or less
60 db with more than 3 watts and including 150 watts

70 db with more than 150 watts and including 600 watts

80 db with more than 600 watts

MODULATION: AM or FM phone or tone-signal modulation is authorized, with a maximum modulation of 3,000 cycles. On FM, deviation due to modulation must not exceed plus or minus 15 kc. from the unmodulated carrier.

Each transmitter authorized or installed after July 1, 1950, must be provided with a device which will automatically prevent modulation in excess of that specified above, except that this shall not apply to mobile transmitters using a maximum plate power input to the final RF stage of 3 watts or less.

FREQUENCY STABILITY: Frequency tolerance of the carrier frequency shall be .01% below 50 mc., and .005% from 50 to 220 mc. Stability above 220 mc. will be specified in the FCC authorization.

MAXIMUM POWER: Maximum plate power input to the final RF stage shall not exceed 500 watts at 25 to 100 mc., and 600 watts at 100 to 220 mc. Higher power will be authorized if a clear showing of need is made to the Commission. Power above 220 mc. will be specified in the FCC authorization. Power and antenna height shall be no more than the minimum required for satisfactory technical operation commensurate with the area to be served and local conditions which affect transmission and reception.

TRANSMITTER MEASUREMENTS: Frequency and modulation measurements

on each fixed and mobile unit must be made and entered in the log every 6 months, or whenever an adjustment is made that might affect frequency or modulation. Mobile units may be checked on the bench if they are operated under load conditions. The use of automatic frequency monitors is approved for frequency checking.

Any independent, qualified engineering measurement service may be employed, provided the log entries show the name and address of the firm, and the name of the person making the measurements.

OPERATOR'S LICENSE: While unlicensed persons may operate the transmitters, all adjustments or tests for installation, service, or maintenance "which may affect the proper operation of such a station, shall be made under the immediate supervision and responsibility of a person holding a 1st or 2nd class commercial radio operator license, either radiotelephone or radiotelegraph, who shall be responsible for the proper functioning of the station equipment."

CHECKING LIGHTS: The licensee shall make a daily check of the tower lights "either by visual observation of the tower lights or by observation of an automatic indicator to insure that all such lights are functioning properly." Any observed failure of a code or rotating beacon light not corrected within 30 minutes must be reported to the nearest Airways Communication Station or CAA local office immediately regardless of the cause of the failure, and notice given immediately on resumption of illumination. Lights and light controls must be inspected at least once every three months. Station records, which must be signed and dated, are specified in detail in the Rules. These records must be retained for one year.

LIMITED COMMON CARRIERS

Eight channels have been assigned to "communication common carriers which are not in the business of providing a public land line message telephone service."

Frequency Assignments:

The frequencies assigned to limited common carriers are:

BASE STATIONS Mc.	MOBILE AUXILIARY TEST, OR SUBSCRIBER FIXED STATIONS, Mc.
152.03	158.49
152.09	158.55
152.15	158.61
152.21	158.67

Technical Information:

The same provisions apply to limited common carriers as are listed above for common carriers.

PUBLIC SAFETY RADIO SERVICE
(Docket 9001, Part 10)

POLICE RADIO SERVICE

Types of stations in the police radio service include base and mobile, mobile relay, control, repeater, and zone and interzone stations. In addition, subject to certain limitations, installations may be made in vehicles, which, in an emergency, would require the co-operation of the police, such as fire department vehicles, ambulance, emergency units of public utilities, life-guard emergency units, and rural school buses.

Radio facilities authorized for public safety services shall not be used to carry program material of any kind for use in connection with radio broadcasting, and shall not be used to render a communications common carrier service except for stations in the special emergency radio service while being used to bridge gaps in common carrier wire lines.

Coordinated service may be rendered without cost to subscribers, or contributions to capital and operating expenses may be accepted by the licensee. Such contributions must be on a cost-sharing basis and pro-rated on an equitable basis among all persons who are parties to the cooperative arrangement. Records which reflect the cost of the service and its non-profit, cost-sharing nature shall be maintained by the base station licensee and held available for inspection.

Arrangements may be made between two or more persons for the cooperative use of radio station facilities provided all persons are eligible to hold licenses to operate the type of station shared.

Frequency Assignments:

Available frequencies are listed in the accompanying table, subject to qualifications set forth in the footnotes.

Technical Information:

EMISSION LIMITATIONS: Bandwidth for AM telegraph is .1 kc.; for AM phone, 8 kc.; for FM phone 40 kc. The specified band shall contain those frequencies upon which a total of 99% of the radiated power appears, extended to include any discrete frequency upon which the power is at least .25% of the total radiated power. Radiation in excess of these limits is considered unauthorized emission. Any emission appearing on any frequency removed from the carrier frequency by at least 50%, but not more than 100% of the maximum authorized bandwidth shall be attenuated not less than 25 db below the unmodulated carrier. Spurious or harmonic emission appearing on any frequency removed from the carrier frequency by at least 100% of the maximum authorized bandwidth shall be attenuated below the unmodulated carrier by not less than:

40 db with maximum plate power input to the final RF stage of 3 watts or less
60 db with more than 3 watts and including 150 watts
70 db with more than 150 watts and including 600 watts
80 db with more than 600 watts.

MODULATION: AM or FM phone or tone-

signal modulation is authorized, with a maximum modulation of 3,000 cycles. On FM, deviation due to modulation must not exceed plus or minus 15 kc. from the unmodulated carrier.

Each transmitter authorized or installed after July 1, 1950, must be provided with a device which will automati-

POLICE RADIO FREQUENCIES

FREQ.	CLASS	NOTES	FREQ.	CLASS	NOTES	FREQ.	CLASS	NOTES
1610	Kc. Base, Mob.	6, 7, 12	39.26	Mobile		45.18	"	
1618	"	"	39.30	Mobile		45.22	"	
1626	"	"	39.34	"		45.26	Mobile	
1634	"	"	39.38	"		45.30	"	
1642	"	"	39.42	Base, Mob.		45.34	"	
1650	"	7, 12	39.46	"		45.38	"	
1658	"	"	39.50	"		45.42	Base, Mob.	
1666	"	"	39.54	"		45.46	"	
1674	"	"	39.58	"		45.50	"	
1682	"	"	39.62	"		45.54	"	
1690	"	6, 7, 12	39.66	Mobile		45.58	"	
1698	"	"	39.70	"		45.62	"	
1706	"	"	39.74	"		45.66	"	
1714	"	7, 12	39.78	"		45.70	"	
1722	"	"	39.82	Base, Mob.		45.74	Mobile	
1730	"	"	39.86	"		45.78	"	
2326	"	6, 7, 12	39.90	"		45.82	"	
2366	"	"	39.94	"		45.86	"	
2382	"	7, 12	39.98	"		45.90	Base, Mob.	
2390	"	6, 7, 12	42.02	"	7, 8	45.94	"	
2406	"	7, 12	42.06	"	"	45.98	"	
2414	"	"	42.10	"	"	46.02	"	
2422	"	"	42.14	"	"	72.02 to		
2430	"	"	42.18	Mobile	"	74.58 Op. Fixed		3
2442	"	"	42.22	"	"	75.42 to		"
2450	"	"	42.26	"	"	75.98		
2458	"	"	42.30	"	"	154.65	Mobile	
2466	"	"	42.34	Base, Mob.	"	154.71	"	
2474	"	"	42.38	"	"	154.77	"	
2482	"	"	42.42	"	"	154.83	"	
2490	"	"	42.46	"	"	154.89	Mobile	
2804	Zone, Int'zone	9, 12,	42.50	"	"	154.95	"	
2808	"	"	42.54	"	"	155.01	Base, Mob.	
2812	"	"	42.58	"	"	155.07	"	
5135	"	"	42.62	"	"	155.13	"	
5140	"	"	42.66	Mobile	"	155.19	"	
5195	"	9, 10, 12	42.70	"	"	155.25	"	
7480	"	9, 11, 12	42.74	"	"	155.31	"	
7805	"	"	42.78	"	"	155.37	"	
7935	"	"	42.82	Base, Mob.	"	155.43	"	
37.02	Mc. Mobile		42.86	"	"	155.49	"	
37.06	Base, Mob.		42.90	"	"	155.55	"	
37.10	"		42.94	"	7, 8	155.61	"	
37.14	"		44.62	"	"	155.67	"	
37.18	"		44.66	"	"	155.73	"	
37.22	"		44.70	"	"	155.79	"	
37.26	"		44.74	"	"	155.85	Mobile	
37.30	"		44.78	Mobile	"	155.91	"	
37.34	Mobile		44.82	"	"	155.97	"	
37.38	"		44.86	"	"	156.03	"	
37.42	"		44.90	"	7, 8	156.09	"	
39.02	Base, Mob.		44.94	Base, Mob.	"	156.15	"	
39.06	"		44.98	"	"	156.21	Base, Mob.	
39.10	"		45.02	"	"	156.27	"	5
39.14	"		45.06	"	"	156.33	"	"
39.18	"		45.10	"	"	156.39	"	"
39.22	"		45.14	"	"	156.45	"	"

156.51	"	"	159.51 to	3500 to	"
156.57	"	"	161.79	4 3700 Base, Mob.	"
156.63	"	"	154.05 to	6425 to	"
156.69	"	"	455.95	1 6575	"
156.75	"	"	952 to	6575 to	"
158.73	"	"	960 Op. Fixed	6875 Op. Fixed	"
158.79	"	"	1850 to	11700 to	"
158.85	"	"	1990	12200 Base, Mob.	"
158.91 Mobile			2110 to	12200 to	"
158.97	"	"	2200	12700 Op. Fixed	"
159.03	"	"	2450 to	16600 to	"
159.09 Base, Mob.			2500 Base, Mob.	18000	"
159.15	"	"	Op. Fixed	1, 2 26000 to	"
159.21	"	"	2500 to	30000	"
			2700 Op. Fixed	1	

cally prevent modulation in excess of that specified above, except that this shall not apply to mobile transmitters using a maximum plate power input to the final RF stage of 3 watts or less.

FREQUENCY STABILITY: Frequency tolerance of the carrier frequency must be maintained at .01% below 50 mc., and .005% from 50 to 220 mc. Stability above 220 mc, will be specified in the FCC authorization.

For transmitters with a maximum plate power input to the final RF stage of 3 watts or less, the frequency tolerance required is .02% below 50 mc., and .01% from 50 to 220 mc. Stability above 220 mc. will be specified in the FCC authorization.

MAXIMUM POWER: Maximum plate power input to the final RF stage shall not exceed 2 kw. at 1.6 to 3 mc.; 500

¹ Limited to developmental operation only with the assigned frequency and particulars of operation specified in each authorization.

² Subject to no protection from interference due to the operation of industrial, scientific, and medical devices in this band.

³ Assignable frequencies spaced by 40 kc. beginning with the frequencies 72.02 and 75.42 mc. and ending with the frequencies 74.58 and 75.98 mc. respectively, are available on a shared basis to operational fixed stations in the police radio service on the condition that no harmful interference will be caused to the reception of television stations on Channels 4 or 5.

⁴ Assignable frequencies spaced by 60 kc. beginning with the frequency 159.51 mc. and ending with the frequency 161.79 mc. are available on a shared basis to base and mobile stations in the police radio service upon an adequate showing of need and upon the condition that no harmful interference will be caused to the service of any existing or future station operating in the railroad radio service.

⁵ The use of this frequency may be authorized to base and mobile stations in the police radio service on the condition that no harmful interference will be caused to the maritime mobile service.

Police operations at points within 150 miles of coastal areas and navigable gulfs, bays, rivers and lakes may be authorized only after a factual finding indicates that, on an engineering basis, no

watts at 25 to 100 mc.; and 600 watts at 100 to 220 mc. Power at frequencies above 220 mc. will be specified in the FCC authorization. Stations presently authorized to use power in excess of the limits specified above may continue their operation until the expiration of their current license term. Power and antenna height shall be no more than the minimum required for satisfactory technical operation commensurate with the area to be served and local conditions which affect transmission and reception.

TRANSMITTER MEASUREMENTS: Frequency and modulation measurements on each fixed and mobile unit must be made and entered in the log every 6 months, or whenever an adjustment is made that might affect frequency or modulation. Mobile units may be checked on the bench if they are operating under conditions which will be caused to the maritime mobile service.

⁶ The use of this frequency is subject to the condition that no harmful interference will be caused to the service of any Canadian station.

⁷ This frequency is available for assignment only in accordance with a geographical assignment plan.

⁸ This frequency is reserved primarily for assignment to state police licensees. Assignment to other police licensees will be made only where the frequency is required for coordinated operation with the state police system to which the frequency is assigned. Any request for such assignment must be supported by a statement from the state police system concerned, indicating that the assignment is necessary for coordination of police activities.

⁹ This frequency is available for assignment to zone and interzone stations in the police radio service for use with type A1 emission only and a maximum plate input power of 1,000 watts to the final radio frequency stage of the transmitter.

¹⁰ This frequency is authorized for use as a calling frequency; however, the transmission of operating signals or a single short radio telegram is permissible provided no harmful interference will be caused to any calling signals.

¹¹ This frequency may be used only during that period of time between 2 hours after local sunrise and 2 hours before local sunset.

¹² This frequency may be subject to change when the Atlantic City table of frequency allocations below 27.50 mc. comes into force.

ated under load conditions. The use of automatic frequency monitors is approved for frequency checking.

Any independent, qualified engineering measurement service may be employed, provided the log entries show the name and address of the firm, and the name of the person making the measurements.

OPERATOR'S LICENSE: While unlicensed persons may operate the transmitters, all adjustments or tests for installation, service, or maintenance "which may affect the proper operation of such a station, shall be made under the immediate supervision and responsibility of a person holding 1st or 2nd class commercial radio operator license, either radiotelephone or radiotelegraph, who shall be responsible for the proper functioning of the station equipment."

In the case of radiotelegraph stations, however, adjustments affecting the frequency must be made by a person holding a 1st or 2nd class commercial radiotelegraph operator license.

No person is required to be in attendance at a remote transmitter when operating in the course of normal service, or at transmitters used for telemetering or for self-actuated retransmission.

CHECKING LIGHTS: The licensee shall make a daily check of the tower lights "either by visual observation of the tower lights or by observation of an automatic indicator to insure that all such lights are functioning properly." Any observed failure of a code or rotating beacon light not corrected within 30 minutes must be reported immediately by telegraph or telephone to the nearest Airways Communication Station or CAA office regardless of the cause of the failure, and notice given immediately on resumption of illumination. Lights and light controls must be inspected at least once every three months.

In addition, at intervals not to exceed three months, the voltage must be measured at each socket under load. If that is not practicable, the voltage may be computed from measurements under load at some other point in the circuit.

Station records, which must be signed, dated, and retained for one year, are specified in detail in the Rules.

FIRE RADIO SERVICE

Fire department base stations are authorized to intercommunicate with mobile units on fire apparatus, with other stations in the public safety services, and with receivers at fixed locations. Relay stations will be authorized only where a showing is made that a fire radio system cannot function satisfactorily over necessary distances, or where, in an integrated system comprising two or more fire licensees, the number of nec-

FIRE RADIO FREQUENCIES

FREQ.	CLASS	NOTES	FREQ.	CLASS	NOTES	FREQ.	CLASS	NOTES
1630 kc.	Base, Mob.	7	33.74	"	"	46.14	"	"
33.42 mc.	Mob., Fixed	6	33.78	"	"	46.18	"	"
33.46	Mobile		33.82	"	"	46.22	Mobile	
33.50	"		33.86	"	"	46.26	"	
33.54	"		33.90	"	"	46.30	Mob., Fixed	6
33.58	"		33.94	"	"	46.34	Mobile	
33.62	"		33.98	"	"	46.38	Base, Mob.	
33.66	"		46.06	"	"	46.42	"	
33.70	Base Mob.		46.10	"	"	46.46	"	

essary frequencies can be reduced. Subject to certain limitations, mobile units may be installed in public utility and water department vehicles.

Frequency Assignments:

Available frequencies are listed in the accompanying table, subject to qualifications set forth in the footnotes.

Technical Information:

The same requirements apply to the fire radio service as are listed under Technical Information for the police radio service.

¹ Limited to developmental operation only with the assigned frequency and particulars of operation specified in each authorization.

² Subject to no protection from interference due to the operation of industrial, scientific, and medical devices in this band.

³ Assignable frequencies spaced by 40 kc., beginning with the frequencies 72.02 and 75.42 mc. and ending with frequencies 74.58 and 75.98 mc., respectively, are available on a shared basis to operational fixed stations in the fire radio service on the condition that no harmful interference will be caused to the reception of television

46.50	"		154.37	"		2500 to		
72.02 to			154.43	"		2700	Op. Fixed	1
74.58	Op. Fixed	3	159.51 to			3500 to		
75.42 to			161.79	"	4	3700	Base, Mob.	1
75.98	"	3	166.25	"	5	6425 to		
153.77	Mobile		170.15	"	5	6575	"	1
153.83	Mob., Fixed	6	454.05 to			6575 to		
153.89	Mobile		455.95	"	1	6875	Op. Fixed	1
153.95	"		952 to			11700 to		
154.01	"		960	Op. Fixed	1	12200	Base, Mob.	1
154.07	"		1850 to			12200 to		
154.13	Base, Mob.		1990	"	1	12700	Op. Fixed	1
154.19	"		2110 to			16600 to		
154.25	"		2200	"	1	18000	"	1
154.31	"		2450 to	Base, Mob.	1, 2	26000 to		
			2500	Op. Fixed		30000	"	1

stations on Channels 4 or 5.

⁴ Assignable frequencies spaced by 60 kc., beginning with the frequency 159.51 mc. and ending with the frequency 161.79 mc. are available on a shared basis to base and mobile stations in the fire radio service, upon an adequate showing of need and upon the condition that no harmful interference will be caused to the service of any existing or future station in the railroad radio service.

⁵ This frequency may be assigned to stations in the fire radio service, only at points within 150 miles of New York, N. Y.

⁶ The maximum plate power input to the final radio frequency stage of any transmitter authorized to operate on this frequency shall not exceed 3 watts.

⁷ This frequency may be subject to change when the Atlantic City table of frequency allocations below 27.50 mc. comes into force.

FORESTRY-CONSERVATION

Forestry-conservation base stations are authorized to intercommunicate with mobile units in the same service, with other stations in the public safety services, and with receivers at fixed locations. Relay stations will be authorized only where a showing is made that a forestry-conservation radio system cannot function satisfactorily over necessary distances, or where, in an integrated system comprising two or more forestry-conservation licensees, the number of necessary frequencies can be reduced.

Frequency Assignments:

Available frequencies are listed in the accompanying table, subject to qualifications set forth in the footnotes.

Technical Information:

The same requirements apply to the forestry-conservation service as are listed under Technical Information for police radio service.

¹ Limited to developmental operation only with the assigned frequency and particulars of operation specified in each authorization.

² Subject to no protection from interference due to the operation of industrial, scientific, and medical devices in this band.

³ Assignable frequencies spaced by 40 kc., beginning with the frequencies 72.02 and 75.42 mc. and ending with the frequencies 74.58 and 75.98 mc., respectively, are available on a shared basis to operational fixed stations in the Forestry-Conservation Radio Service on the condition that no harmful interference will be caused to the reception of television stations on Channels 4 or 5.

⁴ Assignable frequencies spaced by 60 kc., beginning with the frequency 159.51 mc. and ending with the frequency 161.79 mc. are available on a shared basis to base and mobile stations in the Forestry-Conservation Radio Service upon an adequate showing of need and upon the condition that no harmful interference will be caused to the service of any existing or future station operating in the Railroad Radio Service.

⁵ The use of this frequency may be authorized to base and mobile stations in the Forestry-Conservation Radio Service on the condition that no harmful interference will be caused to the Maritime Mobile Service. Forestry-Conservation operations at points within 150 miles of coastal areas and navigable gulfs, bays, rivers and lakes may be authorized only after a factual finding indicates

FORESTRY-CONSERVATION FREQUENCIES

FREQ.	CLASS	NOTES	FREQ.	CLASS	NOTES	FREQ.	CLASS	NOTES
2212 kc.	Base, Mob.	6, 12	31.86	Base, Mob.	7, 9, 10	172.225	"	8, 10, 14
2226	"	6, 12	31.90	"	7, 9, 10	172.275	"	8, 10, 13
2236	"	6, 12	31.94	"	7, 9, 10	172.375	"	8, 10, 14
2244	"	6, 12	31.98	"	7, 9, 10	454.05 to		
30.86 mc.	"	11	46.54	"		455.95	"	1
30.90	"	11	46.58	"		952 to		
30.94	"	11	46.62	"		960	Op. Fixed	1
30.98	"	11	46.66	"		1850 to		
31.02	"	7, 9, 10, 11	46.70	"		1990	"	1
31.06	"	7, 9, 10, 11	46.74	"		2110 to		
31.10	"	7, 9, 10, 11	46.78	"		2220	"	1
31.14	"	7, 9, 10, 11	46.82	"		2450 to Base, Mob.,		
31.18	"	7, 9, 10	72.02 to			2500	Op. Fixed	1, 2
31.22	"	7, 9, 10	74.58	Op. Fixed	3	2500 to		
31.26	"	7, 9, 10	75.42 to			2700	Op. Fixed	1
31.30	"	7, 9, 10	75.98	Op. Fixed	3	3500 to		
31.34	"	7, 9, 10	156.87	Base, Mob.	5	3700	Base, Mob.	1
31.38	"	7, 9, 10	156.93	"	5	6425 to		
31.42	"	7, 9, 10	159.27	"		6575	"	1
31.46	"	7, 9, 10	159.33	"		6575 to		
31.50	"	7, 9, 10	159.39	"		6875	Op. Fixed	1
31.54	"	7, 9, 10	159.45	"		11700 to		
31.58	"	7, 9, 10	159.51 to			12200	Base, Mob.	1
31.62	"	7, 9, 10	161.79	"	4	12200 to		
31.66	"	7, 9, 10	170.425	"	8, 10, 14	12700	Op. Fixed	1
31.70	"	7, 9, 10	170.475	"	8, 10, 13	16600 to		
31.74	"	7, 9, 10	170.575	"	8, 10, 14	18000	"	1
31.78	"	7, 9, 10	171.425	"	8, 10, 13	26000 to		
31.82	"	7, 9, 10	171.475	"	8, 10, 14	30000	"	1
			171.575	"	8, 10, 13			

that, on an engineering basis, no harmful interference will be caused to the Maritime Mobile Service.

⁶ The use of this frequency is subject to the condition that no harmful interference will be caused to the service of any Canadian station.

⁷ This frequency is available for assignment only in accordance with a geographical assignment plan.

⁸ This frequency will be assigned only to licensees directly responsible for the prevention, detection, and suppression of forest fires, subject to the condition that no harmful interference will be caused to the service of any U. S. Government station.

⁹ This frequency may be used for conservation activities upon the condition that no harmful interference will be caused to the service of any station using the frequency for forest fire preven-

tion, detection and suppression.

¹⁰ This frequency is reserved primarily for assignment to state licensees. Assignments to other licensees will be made only where the frequency is required for coordinated operation with the state system to which the frequency is assigned. Any request for such assignment must be supported by a statement from the state system concerned, indicating that the assignment is necessary for coordination of activities.

¹¹ This frequency is shared with the Urban Transit Radio Service.

¹² This frequency may be subject to change when the Atlantic City table of frequency allocations below 27.50 Mc. comes into force.

¹³ This frequency will be assigned for use only in areas east of the Mississippi River.

¹⁴ This frequency will be assigned for use only in areas west of the Mississippi River.

HIGHWAY MAINTENANCE

Highway maintenance base stations are authorized to intercommunicate with other fixed and mobile stations in the same service, with other stations in the public safety services, and with receivers at fixed locations. Relay stations will be authorized only where a showing is made that a highway maintenance radio system cannot function satisfactorily over necessary distances, or where, in an integrated system comprising two or more highway maintenance licensees, the number of necessary frequencies can be reduced. Subject to certain limitations, mobile units may be installed in vehicles of contractors or others having direct responsibility for maintenance, supervision, or operation of public highways.

Frequency Assignments:

Except for systems licensed to states, assignments will be limited to the use of only one frequency per system. Available frequencies are listed in the accompanying table, subject to qualifications set forth in the footnotes:

Technical Information:

The same requirements apply to the highway maintenance service as are listed under Technical Information for police radio service.

¹ Limited to developmental operation only with the assigned frequency and particulars of operation specified in each authorization.

HIGHWAY MAINTENANCE FREQUENCIES

FREQ.	CLASS	NOTES	FREQ.	CLASS	NOTES	FREQ.	CLASS	NOTES
33.02	Base, Mob.	6	47.38	Base, Mob.	7, 8	2450 to	Base, Mob.	
33.06	"	6	72.02 to			2500	Op. Fixed	1, 2
33.10	"	6	74.58	Op. Fixed	3	2500 to		
37.90	"	6	75.42 to			2700	Op. Fixed	1
37.94	"	6	75.98	"	3	3500 to		
37.98	"	6	156.99	Base, Mob.	5	3700	Base, Mob.	1
46.86	"	7, 8	157.05	"	5	6425 to		
46.90	"	7, 8	157.11	"	5	6575	"	1
46.94	"	7, 8	157.41	"	5	6575 to		
46.98	"	7, 8	159.51 to			6875	Op. Fixed	1
47.02	"	7, 8	161.79		4	11700 to		
47.06	"	7, 8	454.05 to			12200	Base, Mob.	1
47.10	"	7, 8	455.95		1	12200 to		
47.14	"	7, 8	952 to			12700	Op. Fixed	1
47.18	"	7, 8	960	Op. Fixed	1	16600 to		
47.22	"	7, 8	1850 to			18000	"	1
47.26	"	7, 8	1990	"	1	26000 to		
47.30	"	7, 8	2110 to			30000	"	1
47.34	"	7, 8	2200	"	1			

² Subject to no protection from interference due to the operation of industrial, scientific, and medical devices in this band.

³ Assignable frequencies spaced by 40 kc. beginning with the frequencies 72.02 and 75.42 mc. and ending with the frequencies 74.58 and 75.98 mc. respectively, are available on a shared basis to operational fixed stations in the highway maintenance radio service on the condition that no harmful interference will be caused to the reception of television stations on Channels 4 or 5.

⁴ Assignable frequencies spaced by 60 kc. beginning with the frequency 159.51 mc. and ending with the frequency 161.79 mc. are available on a shared basis to base and mobile stations in the highway maintenance radio service upon an adequate showing of need and upon the condition that no harmful interference will be caused to the service of any existing or future station operating in the railroad radio service.

⁵ The use of this frequency may be authorized to base and mobile stations in the highway main-

tenance radio service on the condition that no harmful interference will be caused to the maritime mobile service. Highway maintenance operations at points within 150 miles of coastal areas and navigable gulfs, bays, rivers, and lakes may be authorized only after a factual finding indicates that, on an engineering basis, no harmful interference will be caused to the maritime mobile service.

⁶ This frequency is shared with the special emergency radio service.

⁷ This frequency will be assigned only in accordance with a geographical assignment plan.

⁸ This frequency is reserved primarily for assignment to highway maintenance systems operated by states. The use of this frequency by other highway maintenance licensees will be authorized only where such use is necessary to coordinate activities with the particular state to which the frequency is assigned. Any request for such use must be supported by a statement from the state concerned.

SPECIAL EMERGENCY SERVICE

Special emergency stations are intended for use by persons having establishments in remote locations where other communications facilities are not available, relief agencies which have a disaster communications plan, physicians normally practicing in remote areas, ambulance services, beach patrols responsible for life saving, rural school buses and communications common carriers.

Special emergency base stations are authorized to intercommunicate with other fixed and mobile stations in the same service, with other stations in the public safety services, and with receivers at fixed locations. Transmission of non-emergency communications is strictly prohibited, except that common carriers may use communications for restoring temporarily a normal communications service disrupted as a result of an emergency.

Frequency Assignments:

Operation of mobile system in the special emergency service is restricted to the use of only one frequency per system. Available frequencies are listed in the accompanying table, subject to qualifications set forth in the footnotes:

FREQ.	CLASS	NOTES	FREQ.	CLASS	NOTES	FREQ.	CLASS	NOTES
2726 kc.	Base, Mob.	9	75.42 to			2450 to	Base, Mob.	
3190	"	9	75.98	Op. Fixed	3	2500	Op. Fixed	1, 2
33.02 mc.	"	6	157.47	Base, Mob.	5, 8	2500 to		
33.06	"	6	159.51 to			2700	Op. Fixed	1
33.10	"	6	161.79	"	4	3500 to		
37.90	"	6	161.85	"	5, 8	3700	Base, Mob.	1
37.94	"	6	161.91	"	5, 8	6425 to		
37.98	"	6	161.97	"	5, 8	6575	"	1
47.42	"	7	454.05 to			6575 to		
47.46	"		455.95	"	1	6875	Op. Fixed	1
47.50	"		952 to			11700 to		
47.54	"		960	Op. Fixed	1	12200	Base, Mob.	1
47.58	"		1850 to			12200 to		
47.62	"		1990	"	1	12700	Op. Fixed	1
47.66	"		2110 to			16600 to		
72.02 to			2200	"	1	18000	"	1
74.58	Op. Fixed	3				26000 to		
						30000	"	1

Technical Information:

The same requirements apply to the highway maintenance service as are listed under Technical Information for police radio service.

¹ Limited to developmental operation only with assigned frequency and particulars of operation specified in each authorization.

² Subject to no protection from interference due to the operation of industrial, scientific and medical devices in this band.

³ Assignable frequencies spaced by 40 kc. beginning with the frequencies 72.02 and 75.42 mc. and ending with the frequencies 74.58 and 75.98 mc., respectively, are available on a shared basis to operational fixed stations in the special emergency radio service on the condition that no harmful interference will be caused to the reception of television stations on Channels 4 or 5.

⁴ Assignable frequencies spaced by 60 kc. beginning with the frequency 159.51 mc. and ending with the frequency 161.79 mc. are available on a shared basis to base and mobile stations in the special emergency radio service upon an adequate showing of need and upon the condition that no harmful interference will be caused to the service of any existing or future station operating in the railroad radio service.

* The use of this frequency may be authorized to base and mobile stations in the special emergency radio service on the condition that no harmful interference will be caused to the maritime mobile service. Special emergency operations at points within 150 miles of coastal areas and navigable gulfs, bays, rivers and lakes may be authorized

only after a factual finding indicates that, on an engineering basis, no harmful interference will be caused to the maritime mobile service.
 * This frequency is shared with the highway maintenance radio service.
 * This frequency is reserved for assignment only to national organizations established for relief

purposes.
 * This frequency will not be assigned to stations in the special emergency radio service at any point within 150 miles of Chicago, Illinois.
 * This frequency may be subject to change when the Atlantic City table of frequency allocations below 27.50 mc. comes into force.

POWER RADIO SERVICE

Individuals or companies eligible to operate power radio systems are those engaged in generating, transmitting, collecting, purifying, storing, or distributing, by means of wire or pipe line, electrical energy, artificial or natural gas, water, or steam for use by the public, or by the members of a corporation organization; or

A non-profit organization formed for the purpose of furnishing a radio communication service solely to persons who are actually engaged in one or more of the activities set forth above.

Frequency Assignments:

Available frequencies are listed in the accompanying table, subject to qualifications set forth in the footnotes.

Technical Information:

Applicants and licensees must cooperate in the selection and use of assigned frequencies in order to minimize interference and obtain the most effective use of facilities authorized. Each frequency or band is available on a shared basis only, and will not be assigned for the exclusive use of any one applicant. Such use may be restricted as to geographical area.

Mobile system frequencies have been made available on the basis of single-frequency, simplex operation. Not more than one frequency or band of frequencies will be assigned to a single applicant unless a conclusive showing is made that an additional assignment is necessary to the operation of the system.

Since most fixed, point-to-point circuits require simultaneous 2-way communication, it will be customary to assign two frequencies or bands with such frequency separation, where possible, as to allow full duplex operation.

EMISSION LIMITATIONS: Bandwidth for AM phone is 8 kc.; for FM phone, 40 kc. The specified band shall contain those frequencies on which 99% of the radiated power appears, extended to include any discrete frequency of which the power is at least .25% of the total radiated power. Radiation in excess of these limits is considered unauthorized emission. Emission appearing on any frequency removed from the carrier frequency by at least 50% but not more than 100% of the maximum authorized bandwidth must be attenuated not less than 25 db below the

¹ This frequency may be subject to change when the Atlantic City table of frequency allocations below 27.5 mc. comes into force.

unmodulated carrier. Spurious or harmonic emission appearing on any frequency removed from the carrier frequency by at least 100% of the maximum authorized bandwidth must be attenuated below the unmodulated carrier by not less than:

- 40 db with maximum plate power input to the final stage of 3 watts or less.
- 60 db with more than 3 watts and including 150 watts.
- 70 db with more than 150 watts and including 600 watts.
- 80 db with more than 600 watts.

It should be noted that, when an unauthorized emission results in harmful interference, the Commission may, at its discretion, require appropriate technical changes in the equipment to alleviate the interference. This may apply in cases where transmitters installed prior to July 1, 1950, are not equipped with devices which automatically limit the modulation.

MODULATION: Maximum audio frequency required for speech intelligibility is considered 3,000 cycles. Transmission of higher frequencies will not be author-

POWER RADIO FREQUENCIES

FREQ.	CLASS	NOTES	FREQ.	CLASS	NOTES	FREQ.	CLASS	NOTES
2292 kc.	Base, Mob.	1, 3	48.30	Base, Mob.	5	457.45	Base, Mob.	7
4637.5	"	1, 2, 3	48.34	"	5	457.55	"	7
35.06 mc.	"	3, 4	48.38	"	5	457.65	"	7
35.10	"	3, 4	48.42	"	5	457.75	"	7
35.14	"	3, 4	48.46	"	5	457.85	"	7
35.18	"	3, 4	48.50	"	5	457.95	"	7
37.46	"	5	48.54	"	5	952	to	
37.50	"	5	72.02	to		960	Fixed	8
37.54	"	5	75.98	Fixed	6	1850	to	
37.58	"	5	153.41	Base, Mob.	5	1990	"	8
37.62	"	5	153.47	"	5	2110	to	
37.66	"	5	153.53	"	5	2200	"	8
37.70	"	5	153.59	"	5	2450	to	
37.74	"	5	153.65	"	5	2500	Base, Mob.	7, 8, 9
37.78	"	5	153.71	"	5		Op. Fixed	
37.82	"	5	158.13	"	5	2500	to	
37.86	"	5	158.19	"	5	2700	Fixed	8
47.70	"	5	158.25	"	5	3500	to	
47.74	"	5	456.05	"	7	3700	Base, Mob.	7
47.78	"	5	456.15	"	7	6425	to	
47.82	"	5	456.25	"	7	6575	"	7
47.86	"	5	456.35	"	7	6575	to	
47.90	"	5	456.45	"	7	6875	Fixed	8
47.94	"	5	456.55	"	7	11700	to	
47.98	"	5	456.65	"	7	12200	Base, Mob.	7
48.02	"	5	456.75	"	7	12200	to	
48.06	"	5	456.85	"	7	12700	Fixed	8
48.10	"	5	456.95	"	7	16000	to	
48.14	"	5	457.05	"	7	18000	"	8, 9
48.18	"	5	457.15	"	7	26000	to	
48.22	"	5	457.25	"	7	30000	"	8
48.26	"	5	457.35	"	7			

² Limited to daytime use only, with a maximum plate power input to the final RF stage not to exceed 100 watts.

³ Available for assignment to base and mobile stations in the power radio service on a shared basis with other services.

⁴ Use of this frequency by stations in the power radio service is subject to causing no harmful interference to the marine mobile service.

⁵ Available for assignment to base and mobile stations in the power radio service only.

⁶ Assignable frequencies spaced by 40 kc. beginning with the frequencies 72.02 and 75.42 mc., and ending with the frequencies 74.58 and 75.98 mc., respectively, are available on a shared basis to operational fixed stations in the power radio ser-

vice on the condition that no harmful interference will be caused to the reception of television stations on Channels 4 or 5.

⁷ Available for assignment to base and mobile stations in the power radio service on a shared basis with other services, under terms of a developmental grant only.

⁸ Available for assignment to fixed stations in the power radio service on a shared basis with other services, under terms of a developmental grant only.

⁹ Use of frequencies in the 2,450- to 2,500-mc. band and 17,850- to 18,000-mc. band is subject to no protection from interference due to the operation of industrial, scientific, and medical devices on 2,450 and 18,000 mc.

ized. On FM, deviation due to modulation must not exceed plus and minus 15 kc. from the unmodulated carrier.

Each transmitter authorized or installed after July 1, 1950, must be provided with a device which will automatically prevent modulation in excess of that specified above, except that this shall not apply to mobile transmitters using a maximum plate power input to the final RF stage of 3 watts or less.

MAXIMUM POWER: Maximum plate power input to the final RF state shall not exceed 2 kw. at 1.6 to 3 mc.; 500 watts at 25 to 100 mc.; and 600 watts at 100 to 220 mc. Power at frequencies above 220 mc. will be specified in the FCC authorization. Stations presently authorized to use power in excess of the limits specified above may continue their operation until the expiration of their current license term. Power and antenna height shall be no more than the minimum required for satisfactory technical operation commensurate with the area to be served and local conditions which affect transmission and reception.

TRANSMITTER MEASUREMENTS: Frequency and modulation measurements on each fixed and mobile unit must be made and entered in the log every 6 months, or whenever an adjustment is made that might affect frequency or modulation. Mobile units may be checked on the bench if they are operated under load conditions. The use of automatic frequency monitors is approved for frequency checking.

Any independent, qualified engineering measurement service may be employed, provided the log entries show the name and address of the firm, and the name of the person making the measurements.

OPERATOR'S LICENSE: While unlicensed persons may operate the transmitters, all adjustments or tests for installation, service, or maintenance "which may affect the proper operation of such a station, shall be made under the immediate supervision and responsibility of a person holding 1st or 2nd class commercial radio operator license, either radio-telephone or radiotelegraph, who shall be responsible

for the proper functioning of the station equipment."

At radiotelegraph stations, adjustments affecting frequency must be made by a person holding a 1st or 2d class commercial radiotelegraph operator license.

No person is required to be in attendance at a remote transmitter when operating in the course of normal service, or at transmitters used for telemetering or for self-actuated retransmission.

CHECKING LIGHTS: The licensee shall make a daily check of the tower lights "either by visual observation of the tower lights or by observation of an automatic indicator to insure that all such lights are functioning properly." Any observed failure of a code or rotating beacon light not corrected within 30 minutes must be reported immediately by telegraph or telephone to the nearest Airways Communication Station or CAA office regardless of the cause of the failure, and notice given immediately on resumption of illumination. Lights and light controls must be inspected at least once every three months.

PETROLEUM RADIO SERVICE

Those eligible to operate stations in the petroleum radio service are persons engaged in prospecting for, producing, collecting, refining, or transporting by means of pipelines, petroleum or petroleum products, including natural gas; or a non-profit organization formed for the purpose of furnishing a radio communication service solely to persons who are actually engaged in one or more of the activities set forth above.

Frequency Assignments:

Available frequencies are listed in the accompanying table, subject to qualifications set forth in the footnotes.

Technical Information:

The same requirements apply to the petroleum radio service as are listed under Technical Information for power radio service.

¹ Available for assignment to base and mobile stations in the petroleum radio service on a shared basis with other services.

² This frequency may be subject to change when the Atlantic City table of frequencies below 27.5 mc. comes into force.

³ Limited to daytime use only, with a maximum plate power input to the final RF stage not to exceed 1000 watts.

⁴ Available for assignment to base and mobile stations in the petroleum radio service only.

⁵ Assignable frequencies spaced by 40 kc., beginning with the frequencies 72.02 and 75.42 mc. and ending with the frequencies 74.58 and 75.98 mc., respectively, are available on a shared basis to operational fixed stations in the petroleum radio service on the condition that no harmful interference will be caused to the reception of television stations on Channels 4 or 5.

⁶ Available for assignment to base and mobile stations in the petroleum radio service on a shared basis with other services, under terms of a developmental grant only.

⁷ Available for assignment to fixed stations in

PETROLEUM RADIO FREQUENCIES

FREQ.	CLASS	NOTES	FREQ.	CLASS	NOTES	FREQ.	CLASS	NOTES
1602 kc	Base, Mob.	1, 2	48.86	Base, Mob.	4	457.35	Base, Mob.	6
1628	"	1, 2	48.90	"	4	457.45	"	6
1652	"	1, 2	48.94	"	4	457.55	"	6
1676	"	1, 2	48.98	"	4	457.65	"	6
1700	"	1, 2	49.02	"	4	457.75	"	6
2292	"	1, 2	49.06	"	4	457.85	"	6
4637.5	"	1, 2, 3	49.10	"	4	457.95	"	6
25.02 mc.	"	4	49.14	"	4	952	to	
25.06	"	4	49.18	"	4	960	Fixed	7
25.10	"	4	72.02	to		1850	to	
25.14	"	4	75.98	Fixed	5	1990	"	7
25.18	"	4	153.05	Base, Mob.	1	2110	to	
25.22	"	4	153.11	"	1	2200	"	7
25.26	"	4	153.17	"	1	2450	to	
25.30	"	4	153.23	"	1	2500	Base Mob.	
30.66	"	1	153.29	"	1		Op. Fixed	6, 7, 8
30.70	"	1	153.35	"	1	2500	to	
30.74	"	1	158.31	"	1	2700	Fixed	7
30.78	"	1	158.37	"	1	3500	to	
30.82	"	1	158.43	"	1	3700	Base, Mob.	6
33.18	"	4	456.05	"	6	6425	to	
33.22	"	4	456.15	"	6	6575	"	6
33.26	"	4	456.25	"	6	6575	to	
33.30	"	4	456.35	"	6	6875	Fixed	7
33.34	"	4	456.45	"	6	11700	to	
33.38	"	4	456.55	"	6	12200	Base, Mob.	6
48.58	"	4	456.65	"	6	12200	to	
48.62	"	4	456.75	"	6	12700	Fixed	7
48.66	"	4	456.85	"	6	16000	to	
48.70	"	4	456.95	"	6	18000	"	7, 8
48.74	"	4	457.05	"	6	26000	to	
48.78	"	4	457.15	"	6	30000	"	7
48.82	"	4	457.25	"	6			

the petroleum radio service on a shared basis with other services, under terms of a developmental grant only.

⁸ Use of frequencies in the 2,450- to 2,500-mc.

band and the 1,750- to 18,000-mc. band is subject to no protection due to the operation of industrial, scientific, and medical devices on 2,450 and 18,000 mc.

FOREST PRODUCTS SERVICE

Those eligible to operate stations in the forest products radio service are persons engaged in tree logging, tree farming, or related woods operations; or

A non-profit organization formed for the purpose of furnishing a radio communication service solely to persons who are actually engaged in one or more of the activities set forth above.

Frequency Assignments:

Available frequencies are listed in the accompanying table, subject to qualifications set forth in the footnotes.

Technical Information:

The same requirements apply to the forest products radio service as are listed under technical information for power service.

¹ Available for assignment to base and mobile stations in the forest products radio service on a shared basis with other services.

² This frequency may be subject to change when the Atlantic City table of frequency allocations below 27.5 mc. comes into force.

³ Available for assignment to base and mobile stations in the forest products service only.

⁴ Assignable frequencies spaced by 40 kc. beginning with the frequencies 72.02 and 75.42 mc. and ending with the frequencies 74.58 and 75.98 mc., respectively, are available on a shared basis to operational fixed stations in the forest products radio service on the condition that no harmful interference will be caused to the reception of

FOREST PRODUCTS RADIO FREQUENCIES

FREQ.	CLASS	NOTES	FREQ.	CLASS	NOTES	FREQ.	CLASS	NOTES
1676 kc.	Base, Mob.	1, 2	158.31	Base, Mob.	1	952	to	
1700	"	1, 2	158.37	"	1	960	Fixed	6
29.73 mc.	"	3	158.43	"	1	1850	to	
29.77	"	3	456.05	"	5	1990	"	6
49.22	"	3	456.15	"	5	2110	to	
49.26	"	3	456.25	"	5	2200	"	6
49.30	"	3	456.35	"	5	2450	to	
49.34	"	3	456.45	"	5	2500	Base, Mob.	
49.38	"	3	456.55	"	5		Op. Fixed	5, 6, 7
49.42	"	3	456.65	"	5	2500	to	
49.46	"	3	456.75	"	5	2700	Fixed	6
49.50	"	3	456.85	"	5	3500	to	
49.54	"	1	456.95	"	5	3700	Base, Mob.	5
49.58	"	1	457.05	"	5	6425	to	
49.62	"	1	457.15	"	5	6575	"	5
49.66	"	1	457.25	"	5	6575	to	
72.02	to		457.35	"	5	6875	Fixed	6
75.98	Fixed	4	457.45	"	5	11700	to	
153.05	Base, Mob.	1	457.55	"	5	12200	Base, Mob.	5
153.11	"	1	457.65	"	5	12200	to	
153.17	"	1	457.75	"	5	12700	Fixed	6
153.23	"	1	457.85	"	5	16000	to	
153.29	"	1	457.95	"	5	18000	"	6, 7
153.35	"	1				26000	to	
						30000	"	6

television stations on Channels 4 or 5.

⁵ Available for assignment to base and mobile stations in the forest products radio service on a shared basis with other services, under the terms of a developmental grant only.

⁶ Available for assignment to fixed stations in the forest products radio service on a shared

basis with other services, under the terms of a developmental grant.

⁷ Use of frequencies in the 2,450- to 2,500-mc. band and 17,850- to 18,000-mc. band is subject to no protection from interference due to the operation of industrial, scientific, and medical devices on 2,450 and 18,000 mc.

MOTION PICTURE RADIO SERVICE

Those eligible to operate stations in the motion picture radio service are persons engaged in the production or filming of motion pictures or

A non-profit organization formed for the purpose of furnishing a radio communication service solely to persons who are actually engaged in one or more of the activities set forth above.

Frequency Assignments:

Available frequencies are listed in the accompanying table, subject to qualifications set forth in the footnotes.

Technical Information:

The same requirements apply to motion picture radio service as are listed under Technical Information for power radio service.

The rules applying to this service specify that prior approval must be obtained from the Commission for each person who proposes to participate in the licensee's service.

¹ May be subject to change when the Atlantic City table of frequency allocations below 27.5 mc. comes into force.

² Available for assignment to base and mobile stations in the motion picture radio service on a shared basis with other services.

³ Available for assignment to base and mobile stations in the motion picture radio service on a

MOTION PICTURE FREQUENCIES

FREQ.	CLASS	NOTES	FREQ.	CLASS	NOTES	FREQ.	CLASS	NOTES
1628 kc.	Base Mob.	1, 2	456.45	Base, Mob.	3	2110	to	
1652	"	1, 2	456.55	"	3	2200	"	6
2292	"	1, 2	456.65	"	3	2450	to	
4637.5	"	1, 2, 4	456.75	"	3	2500	Base, Mob.	
49.70 mc.	"	2	456.85	"	3		Op. Fixed	3, 6, 7
49.74	"	2	456.95	"	3	2500	to	
49.78	"	2	457.05	"	3	2700	Fixed	6
49.82	"	2	457.15	"	3	3500	to	
72.02	to		457.25	"	3	3700	Base, Mob.	3
75.98	Fixed	5	457.35	"	3	6425	to	
152.87	Base, Mob.	2	457.45	"	3	6575	"	3
152.93	"	2	457.55	"	3	6575	to	
152.99	"	2	457.65	"	3	6875	Fixed	6
173.225	"	2	457.75	"	3	11700	to	
173.275	"	2	457.85	"	3	12200	Base, Mob.	3
173.325	"	2	457.95	"	3	12200	to	
173.375	"	2	952	to		12700	Fixed	6
456.05	"	3	960	Fixed	6	16000	to	
456.15	"	3	1850	to		18000	"	6, 7
456.25	"	3	1990	"	6	26000	to	
456.35	"	3				30000	"	6

shared basis with other services under terms of a developmental grant only.

⁴ Limited to daytime use only, with a maximum plate power input to the final RF stage not to exceed 100 watts.

⁵ Assignable frequencies spaced by 40 kc. beginning with the frequencies 72.02 and 75.42 mc. and ending with frequencies 74.58 and 75.98 mc., respectively, are available on a shared basis to operational fixed stations in the motion picture radio service on the condition that no harmful

interference will be caused to the reception of television stations on Channels 4 or 5.

⁶ Available for assignment to fixed stations in the motion picture radio service on a shared basis with other services under terms of a developmental grant only.

⁷ Use of frequencies in the 2,450- to 2,500-mc. band and 17,850- to 18,000-mc. band is subject to no protection from interference due to the operation of industrial, scientific, and medical devices on 2,450 and 18,000 mc.

RELAY PRESS RADIO SERVICE

Those eligible to operate stations in the relay press radio service are persons engaged in the publication of a newspaper or in the operation of an established press association; or

A non-profit organization formed for the purpose of furnishing a radio communication service solely to persons who are actually engaged in one or more of the activities set forth above.

Frequency Assignments:

Available frequencies are listed in the accompanying table, subject to qualifications set forth in the footnotes.

Technical Information:

The same requirements apply to relay press radio service as are listed under Technical Information for power radio service.

¹ Assignable frequencies spaced by 40 kc. beginning with the frequencies 72.02 and 75.42 mc. and ending with the frequencies 74.58 and 75.98 mc., respectively, are available on a shared basis to operational fixed stations in the relay press radio service on the condition that no harmful

RELAY PRESS RADIO SERVICE

FREQ.	CLASS	NOTES	FREQ.	CLASS	NOTES	FREQ.	CLASS	NOTES
72.02	to		457.15	Base, Mob.	3	2500	to	
75.98	Fixed	1	457.25	"	3	2700	Fixed	4
173.225	Base, Mob.	2	457.35	"	3	3500	to	
173.275	"	2	457.45	"	3	3700	Base, Mob.	3
173.325	"	2	457.55	"	3	6425	to	
173.375	"	2	457.65	"	3	6575	"	3
456.05	"	3	457.75	"	3	6575	to	
456.15	"	3	457.85	"	3	6875	Fixed	4
456.25	"	3	457.95	"	3	11700	to	
456.35	"	3	952	to		12200	Base, Mob.	3
456.45	"	3	960	Fixed	4	12200	to	
456.55	"	3	1850	to		12700	Fixed	4
456.65	"	3	1990	"	4	16000	to	
456.75	"	3	2110	to		18000	"	4, 5
456.85	"	3	2200	"	4	26000	to	
456.95	"	3	2450	to		30000		4
457.05	"	3	2500	Base, Mob.				

Op. Fixed 3, 4, 5

interference will be caused to the reception of television stations on Channels 4 or 5.

² Available for assignment to base and mobile stations in the relay press radio service on a shared basis with other services.

³ Available for assignment to base and mobile stations in the relay press radio service on a shared basis with other services, under the terms of a developmental grant only.

⁴ Available for assignment to fixed stations in the relay press radio service on a shared basis with other services, under the terms of a developmental grant only.

⁵ Use of frequencies in the 2,450- to 2,500-mc. band and 17,850- to 18,000-mc. band is subject to no protection from interference due to operation of industrial, scientific, and medical devices on 2,450 and 18,000 mc.

SPECIAL INDUSTRIAL SERVICE

Those eligible to operate stations in the special industrial radio service are persons engaged in an industrial activity the primary function of which is devoted to production, construction, fabrication, manufacturing, or similar processes as distinguished from activities of a service or distribution nature, and, in addition, meets one or more of the following requirements:

1) The industrial operation for which radio is desired is being conducted in a remote or sparsely settled region;

2) The industrial operation is a construction project of a public character;

3) The use of a radio is required within the yard area of a single plant for mobile service communications and the use of a low-power industrial service does not meet the operational requirements of the industry otherwise found eligible under this subparagraph.

Frequency Assignments:

Available frequencies are listed in the accompanying table, subject to qualifications set forth in the footnotes.

Technical Information:

The same requirements apply to special industrial radio service as are listed under Technical Information for power radio service.

¹ This frequency may be subject to change when the Atlantic City table of frequency allocations below 27.5 mc. comes into force.

² Limited to daytime use only, with a maximum plate power input to the final RF state not to exceed 100 watts.

SPECIAL INDUSTRIAL RADIO SERVICE

FREQ.	CLASS	NOTES	FREQ.	CLASS	NOTES	FREQ.	CLASS	NOTES
2292 kc.	Base, Mob.	1	72.02	to		952	to	
4637.5	"	1, 2	75.98	Fixed	8	960	Fixed	6
27.31 mc.	"	3	152.87	Base, Mob.	4	1850	to	
27.35	"	3	152.93	"	4	1990	"	6
27.39	"	3	152.99	"	4	2100	to	
27.43	"	3	154.49	"	3	2200	"	6
27.47	"	3	154.57	"	4	2450	to	
30.58	"	3	456.05	"	5	2500	Base, Mob.	
30.62	"	3	456.15	"	5		Op. Fixed 5, 6, 7	
43.02	"	3	456.25	"	5	2500	to	
43.06	"	3	456.35	"	5	2700	Fixed	6
43.10	"	3	456.45	"	5	3500	to	
43.14	"	3	456.55	"	5	3700	Base, Mob.	5
43.18	"	3	456.65	"	5	6425	to	
49.54	"	4	456.75	"	5	6575	"	5
49.58	"	4	456.85	"	5	6575	to	
49.62	"	4	456.95	"	5	6875	Fixed	6
49.66	"	4	457.05	"	5	11700	to	
49.70	"	4	457.15	"	5	12200	Base, Mob.	5
49.74	"	4	457.25	"	5	12200	to	
49.78	"	4	457.35	"	5	12700	Fixed	6
49.82	"	4	457.45	"	5	16000	to	
49.86	"	3	457.55	"	5	18000	"	6, 7
49.90	"	3	457.65	"	5	26000	to	
49.94	"	3	457.75	"	5	30000	"	6
49.98	"	3	457.85	"	5			
			457.95	"	5			

³ Available for assignment to base and mobile stations in the special industrial radio service only.

⁴ Available for assignment to base and mobile stations in the special industrial radio service on a shared basis with other services.

⁵ Available for assignment to base and mobile stations in the special industrial radio service on a shared basis with other services, under the terms of a developmental grant only.

⁶ Available for assignment to fixed stations in the special industrial radio service on a shared basis with other services, under the terms of a developmental grant only.

⁷ Use of frequencies in the 2,450- to 2,500-mc. band and 17,850- to 18,000-mc. band is subject to no protection from interference due to operation of industrial, scientific, and medical devices on 2,450 and 18,000 mc.

⁸ Assignable frequencies spaced by 40 kc. beginning with the frequencies 72.02 and 75.42 mc. and ending with the frequencies 74.58 and 75.98 mc., respectively, are available on a shared basis to operational fixed stations in the special industrial radio service on the condition that no harmful interference will be caused to the reception of television stations on Channels 4 or 5.

LOW-POWER INDUSTRIAL RADIO

Authorization for stations to be oper-

ated in the low-power industrial radio service may be granted to any person engaged in commercial activity or an in-

dustrial enterprise. All stations that are authorized in this service will be classified and licensed as mobile stations. Such

stations, however, need not necessarily be moved nor used while in motion, and may be at fixed locations.

Frequency Assignments:

The following frequencies are available for assignment to mobile stations in the low-power industrial radio service only:

27.51 mc. 35.02 mc.
33.14 42.98

In addition, the frequency 154.57 mc. is available for assignment to mobile stations in the low-power industrial radio

service on a shared basis with services in other classifications.

Technical Information:

Low-power mobile stations operating on the frequencies listed above are subject to applicable regulations appearing in Technical Information for power radio service, in addition to the following:

Emission shall be confined to voice radio telephony.

Plate power input to the final RF stage shall not exceed 3 watts.

Maximum distance between the transmitter and the radiating portion of the antenna shall not exceed 3 ft.

Use of an antenna having a power gain greater than unity is prohibited.

The transmitter shall not be operated by remote control.

Use of repeater, control, or relay stations will not be permitted.

Stations licensed for operation on these frequencies shall not be used to communicate with stations operating on other frequencies.

INTERCITY BUS SERVICE

Persons eligible to operate intercity bus radio service are those regularly engaged in offering to the public a scheduled common carrier passenger land transportation service over public highways and primarily between established city terminals. An organization may be considered eligible for this service, although not directly engaged in the operation of intercity buses, provided that all persons who are members or shareholders of the organization would themselves be eligible for authorization.

Only one base station will be authorized to serve a particular portion of a highway, and such a station will be required to provide service without discrimination, but on a cooperative maintenance basis, to all bus common carriers eligible for authorization in the intercity bus radio service. A licensee rendering such service may accept contributions to capital and operating expenses on a cost-sharing basis from persons to whom such service is furnished.

Frequency Assignments:

Available frequencies are listed in the accompanying table, subject to qualifications set forth in the footnotes.

Technical Information:

FCC Rules specify that each frequency or band of frequencies assigned to stations in the land transportation radio services is available on a shared basis only, and will not be assigned for the exclusive use of any one applicant. All applicants for, and licensees of, stations in these services shall cooperate in the selection and use of the frequencies assigned, in order to minimize interference and thereby obtain the most effective use of the authorized facilities. In the event that two or more licensees are unable to make an equitable division of transmission time, the Commission, at its discretion, may specify a time-sharing arrangement. The use of any of these frequencies may be restricted to one or more geographical areas.

EMISSION LIMITATIONS: Bandwidth for AM phone is 8 kc.; for FM phone, 40 kc. The specified band shall contain those

INTERCITY BUS FREQUENCIES

FREQ.	CLASS	NOTES	FREQ.	CLASS	NOTES	FREQ.	CLASS	NOTES
43.70	Base, Mob.	1	44.26	Base, Mob.	1	3500 to		
43.74	"	1	44.30	"	1	3700	Base, Mob.	5
43.78	"	1	72.02 to			6425 to		
43.82	"	1	75.98	Fixed	2	6575	"	5
43.86	"	1	952 to			6575 to		
43.90	"	1	960	"	3	6875	Op. Fixed	3
43.94	"	1	1850 to			11700 to		
43.98	"	1	1990	"	3	12200	Base, Mob.	5
44.02	"	1	2110 to			12200 to		
44.06	"	1	2200	"	3	12700	Op. Fixed	3
44.10	"	1	2450 to			16000 to		
44.14	"	1	2500	Base, Mob.,		18000	"	3, 4
44.18	"	1		Op. Fixed	3, 4, 5	26000 to		
44.22	"	1	2500 to			30000	"	3
			2700	Op. Fixed	3			

¹ Available for assignment to base and mobile stations in the intercity bus radio service only.

² Assignable frequencies spaced by 40 kc., beginning with the frequencies 72.02 and 75.42 mc. and ending with the frequencies 74.58 and 75.98 mc., respectively, are available on a shared basis to operational fixed stations in the intercity bus radio service on the condition that no harmful interference will be caused to the reception of television stations on Channels 4 or 5.

³ Available for assignment to fixed stations in

the intercity bus service on a shared basis with other services, under terms of a developmental grant only.

⁴ Use of frequencies in the 2,450- to 2,500-mc. band and the 17,850- to 18,000-mc. band is subject to no protection due to the operation of industrial, scientific, and medical devices on 2,450 and 18,000 mc.

⁵ Available for assignment to base and mobile stations in the intercity bus service on a shared basis with other services, under terms of a developmental grant only.

frequencies on which 99% of the radiated power appears, extended to include any discrete frequency of which the power is at least .25% of the total radiated power. Radiation in excess of these limits is considered unauthorized emission. Emission appearing on any frequency removed from the carrier frequency by at least 50% but not more than 100% of the maximum authorized bandwidth must be attenuated not less than 25 db below the unmodulated carrier. Spurious or harmonic emission appearing on any frequency removed from the carrier frequency by at least 100% of the maximum authorized bandwidth must be attenuated below the unmodulated carrier by not less than:

40 db with maximum plate power input to the final stage of 3 watts or less.

60 db with more than 3 watts and including 150 watts.

70 db with more than 150 watts and including 600 watts.

80 db with more than 600 watts.

MODULATION: Maximum audio frequency required for speech intelligibility is considered 3,000 cycles. Transmission of higher frequencies will not be author-

ized. On FM, deviation due to modulation must not exceed plus and minus 15 kc. from the unmodulated carrier.

Each transmitter authorized or installed after July 1, 1950, must be provided with a device which will automatically prevent modulation in excess of that specified above, except that this shall not apply to mobile transmitters using a maximum plate power input to the final RF stage of 3 watts or less.

MAXIMUM POWER: Maximum plate power input to the final RF stage shall not exceed 500 watts at 30 to 100 mc.; and 120 watts at 100 to 220 mc. Power at frequencies above 220 mc. will be specified in the FCC authorization.

TRANSMITTER MEASUREMENTS: Frequency and modulation measurements on each fixed and mobile unit must be made and entered in the log every 6 months, or whenever an adjustment is made that might affect frequency or modulation. Mobile units may be checked on the bench if they are operated under load conditions. The use of automatic frequency monitors is approved for frequency checking.

Any independent, qualified engineering

measurement service may be employed, provided the log entries show the name and address of the firm, and the name of the person making the measurements.

OPERATOR'S LICENSE: While unlicensed persons may operate the transmitters, all adjustments or tests for installation, service, or maintenance "which may affect the proper operation of such a station, shall be made under the immediate supervision and responsibility of a person holding 1st or 2nd class commercial

radio operator license, either radiotelephone or radiotelegraph, who shall be responsible for the proper functioning of the station equipment."

At radiotelegraph stations, adjustments affecting frequency must be made by an operator holding a 1st or 2nd class commercial radiotelegraph license.

CHECKING LIGHTS: The licensee shall make a daily check of the tower lights "either by visual observation of the tower lights or by observation of an auto-

matic indicator to insure that all such lights are functioning properly."

Any observed failure of a code or rotating beacon light not corrected within 30 minutes must be reported immediately by telegraph or telephone to the nearest Airways Communication Station or CAA office regardless of the cause of the failure, and notice given immediately on resumption of illumination. Light and light controls must be inspected at least once every three months.

HIGHWAY TRUCK SERVICE

Only persons regularly engaged in the operation of trucks, on a route basis, outside metropolitan areas, are eligible for authorizations in the highway truck radio service. This service is not available for truck routes within a single metropolitan area. An organization may be considered eligible for this service, although not directly engaged in the operation of trucks, provided all persons who are members or shareholders thereof would themselves be eligible for an authorization.

Technical Information:

The same requirements apply to highway truck radio service as are listed under technical information for intercity bus service.

Frequency Assignments:

Available frequencies are listed in the accompanying table, subject to qualifications set forth in the footnotes, and in

HIGHWAY TRUCK FREQUENCIES

FREQ.	CLASS	NOTES	FREQ.	CLASS	NOTES	FREQ.	CLASS	NOTES
35.74	Base, Mob.	1	1850 to			6575 to		
35.78	"	1	1990	Fixed	5	6875	Fixed	5
35.82	"	1	2110 to			11700 to		
35.86	"	1	2200	"	5	12200	Base, Mob.	6
35.90	"	1	2450 to			12200 to		
35.94	"	1	2500	Op. Fixed,		12700	Fixed	5
35.98	Mobile	2		Base, Mob.	4, 5, 6	16000 to		
72.02 to			2500 to			18000	"	4, 5
75.98	Fixed	3	2700	Fixed	5	26000 to		
952 to			3500 to			30000	"	5
960	Fixed	5	3700	Base, Mob.	6			
			6425 to					
			6575	"	6			

accordance with a geographical assignment plan.

¹ Available for assignment to base and mobile stations in the highway truck radio service in accordance with a geographical assignment plan.

² Available for assignment in all states to mobile stations only.

³ Assignable frequencies spaced by 40 kc., beginning with the frequencies 72.02 and 75.42 mc. and ending with the frequencies 74.58 and 75.98 mc., respectively, are available on a shared basis to operational fixed stations in the highway truck radio service on the condition that no harmful

interference will be caused to the reception of television stations on Channels 4 or 5.

⁴ Use of frequencies in the bands 2,450 to 2,500 mc. and 17,850 to 18,000 mc. is subject to no protection from interference due to the operation of industrial, scientific, and medical devices on 2,450 and 18,000 mc.

⁵ Available for assignment to fixed stations in the highway truck service on a shared basis with other services, under the terms of a developmental grant only.

⁶ Available for assignment to base and mobile stations in the highway truck service on a shared basis with other services, under the terms of a developmental grant only.

URBAN TRANSIT SERVICE

Persons eligible to operate stations in the urban transit radio service are those regularly engaged in furnishing scheduled common carrier public passenger land transportation service along fixed routes primarily within urban or suburban communities. Although not directly engaged in operating an urban transit system, an organization may be considered eligible for this service provided that all members or shareholders of the organization would themselves be eligible for authorization.

Frequency Assignments:

Available frequencies are listed in the accompanying table, subject to qualifications set forth in the footnotes.

Technical Information:

The same requirements apply to urban transit radio service as are listed for intercity bus service.

¹ Available for assignment to base and mobile stations in the urban transit radio service, on a shared basis with other services.

² Available for assignment to base and mobile stations in the urban transit radio service only.

³ Assignable frequencies spaced by 40 kc. beginning with the frequencies 72.02 and 75.42 mc.

URBAN TRANSIT RADIO FREQUENCIES

FREQ.	CLASS	NOTES	FREQ.	CLASS	NOTES	FREQ.	CLASS	NOTES
30.66	Base, Mob.	1	44.54	Base, Mob.	2	2450 to		
30.70	"	1	44.58	"	2	2500	Base, Mob.,	
30.74	"	1	72.02 to				Op. Fixed	5, 6, 7
30.78	"	1	75.98	Fixed	3	2500 to		
30.82	"	1	453.05	Base, Mob.	4	2700	Op. Fixed	5
30.86	"	1	453.15	"	4	3500 to		
30.90	"	1	453.25	"	4	3700	Base, Mob.	6
30.94	"	1	453.35	"	4	6425 to		
30.98	"	1	453.45	"	4	6575	"	6
31.02	"	1	453.55	"	4	6575 to		
31.06	"	1	453.65	"	4	6875	Op. Fixed	5
31.10	"	1	453.75	"	4	11700 to		
31.14	"	1	952 to			12200	Base, Mob.	6
44.34	"	2	960	Op. Fixed	5	12200 to		
44.38	"	2	1850 to			12700	Op. Fixed	5
44.42	"	2	1990	"	5	16000 to		
44.46	"	2	2110 to			18000	"	5, 7
44.50	"	2	2200	"	5	26000 to		
						30000	"	5

and ending with frequencies 74.58 and 75.98., mc., respectively, are available on a shared basis to operational fixed stations in the urban transit radio service on the condition that no harmful interference will be caused to the reception of television stations on Channels 4 or 5.

⁴ Available for assignment to base and mobile stations in the urban transit radio service on a shared basis with the railroad radio service, under the terms of a developmental grant only.

⁵ Available for assignment to fixed stations in the urban transit radio service on a shared basis

with other services, under the terms of a developmental grant only.

⁶ Available for assignment to base and mobile stations in the urban transit radio service on a shared basis with other services, under the terms of a developmental grant only.

⁷ Use of frequencies in the 2,450- to 2,500-mc. band and the 17,850- to 18,000-mc. band is subject to no protection due to the operation of industrial, scientific, and medical devices on 2,450 and 18,000 mc.

RAILROAD RADIO SERVICE

Persons regularly engaged in offering to the public a passenger or freight transportation service by railroad common carrier are eligible for authorizations to operate stations in the railroad radio service. Although not directly engaged in railroad operation, an organization may be considered eligible for this service, provided that all persons who are members or shareholders of the organization would themselves be eligible for an authorization.

Frequency Assignments:

Available frequencies are listed in the accompanying table, subject to qualifications set forth in the footnotes.

Technical Information:

The same requirements apply to railroad radio service as are listed under technical information for intercity bus service, excepting those affecting operators. These are listed in FCC Rules and Regulations, Sec. 16.354.

¹ Assignable frequencies spaced by 40 kc. beginning with the frequencies 72.02 and 75.42 mc. and ending with the frequencies 74.58 and 75.98 mc., respectively, are available on a shared basis to operational fixed stations in the railroad radio service on the condition that no harmful interference will be caused to the reception of television stations on Channels 4 or 5.

² (a) Available for assignment to base and mobile stations used for end to end, fixed point to train, or train to train communications used in connection with the operation of railroad trains over a track or tracks extending through yard and between stations upon which trains are operated by timetable, train order, or both, or the use of which is governed by block signals. May also be used on a secondary basis for inter-communi-

FREQ.	CLASS	NOTES	FREQ.	CLASS	NOTES	FREQ.	CLASS	NOTES
72.02 to			160.89	Base, Mob.	2	453.75	Base, Mob.	4
75.98	Fixed	1	160.95	"	2	952 to		
159.51	Base, Mob.	2	161.01	"	2	960	Op. Fixed	5
159.57	"	2	161.07	"	2	1850 to		
159.63	"	2	161.13	"	2	1990	"	5
159.69	"	2	161.19	"	2	2110 to		
159.75	"	2	161.25	"	2	2200	"	5
159.81	"	2	161.31	"	2	2450 to		
159.87	"	2	161.37	"	2	2500	Base, Mob.,	
159.93	"	2	161.43	"	2		Op. Fixed	5, 6, 7
159.99	"	2	161.49	"	2	2500 to		
160.05	"	2	161.55	"	2	2700	Op. Fixed	5
160.11	"	2	161.61	"	2	3500 to		
160.17	"	2	161.67	"	2	3700	Base, Mob.	6
160.23	"	2	161.73	"	2	6425 to		
160.29	"	2	161.79	"	2	6575	"	6
160.35	"	2	161.85	"	2, 3	6575 to		
160.41	"	2	161.91	"	2, 3	6875	Op. Fixed	5
160.47	"	2	453.05	"	4	11700 to		
160.53	"	2	453.15	"	4	12200	Base, Mob.	6
160.59	"	2	453.25	"	4	12200 to		
160.65	"	2	453.35	"	4	12700	Op. Fixed	5
160.71	"	2	453.45	"	4	16000 to		
160.77	"	2	453.55	"	4	18000	"	5, 7
160.83	"	2	453.65	"	4	26000 to		
						30000	"	5

cation between adjacent base stations, providing interference is not caused to communications of radio stations aboard rolling stock. (b) All these frequencies may be assigned to base and mobile stations to be operated within railroad yards or terminal areas, or for communications which are of a practical necessity for railroad operation or maintenance, provided no interference is caused stations eligible under (a). Applicants requesting assignment of 159.57, 159.81, 160.53, 161.01, 161.31, or 161.67 mc. must show proof of non-interference of stations authorized under (a).

³ Available for assignment in Chicago area only.
⁴ Available for assignment to base and mobile stations on a shared basis with stations in the

urban transit radio service, under the terms of a developmental grant only.

⁵ Assignable to fixed stations on a shared basis with other services under terms of a developmental grant only.

⁶ Available for assignment to base and mobile stations on a shared basis with other services under the terms of a developmental grant only.

⁷ Use of frequencies in the 2,450- to 2,500-mc. band and 17,850- to 18,000-mc. band is subject to no protection from interference due to operation of industrial, scientific, and medical devices on 2,450 and 18,000 mc.

TAXICAB RADIO SERVICE

Those eligible to operate stations in the taxicab radio service are persons regularly engaged in furnishing to the public a non-scheduled passenger land transportation service not operated over a regular route or between established terminals. An organization may be considered eligible for an authorization, although not directly engaged in the operation of taxicabs, provided that all persons who are members or shareholders would themselves be eligible.

Frequency Assignments:

Available frequencies are listed in the accompanying table, subject to qualifications set forth in the footnotes.

Technical Information:

Requirements are the same for the taxi-

TAXICAB RADIO FREQUENCIES

FREQ.	CLASS	NOTES	FREQ.	CLASS	NOTES	FREQ.	CLASS	NOTES
152.27	Base, Mob.	1	452.15	Base, Mob.	2	2450 to		
152.33	"	1	452.25	"	2	2500	Base, Mob.	3, 4
152.39	"	1	452.35	"	2	3500 to		
152.45	"	1	452.45	"	2	3700	"	3
157.53	Mob. only	1	452.55	"	2	6425 to		
157.59	"	1	452.65	"	2	6575	"	3
157.65	"	1	452.75	"	2	11700 to		
157.71	"	1	452.85	"	2	12200	"	3
452.05	Base, Mob.	2	452.95	"	2			

cab radio service as are listed under technical information for intercity bus service. Mobile units in the taxicab radio service may be installed only in vehicles used for the carriage of passengers.

¹ Available for assignment to base and mobile stations in the taxicab radio service only. Not more than one mobile station frequency and one

base station frequency will be assigned to a licensee, unless clearly shown in a supplement to a license application that the grant of an additional frequency would be in the public interest.

² Available for assignment to base and mobile stations only under terms of a developmental grant.

³ Available for assignment to base and mobile stations on a shared basis with other services under the terms of a developmental grant only.

⁴ Use of frequencies in the 2450-2500 mc. band is subject to no protection from interference due to the operation of industrial, scientific, and medical devices on the 2450 mc. frequency.

AUTOMOBILE EMERGENCY SERVICE

Those eligible to operate stations in the automobile emergency radio service are: 1. associations of owners of private automobiles which provide emergency road service, and 2. public garages oper-

ating emergency road service vehicles.

Stations licensed under this service may transmit only the following types of communications: any communication related to the safety of life or the protection of important property, and communications required for dispatching re-

pair trucks to disabled vehicles.

Frequency Assignments:

The frequency of 35.70 mc. is available for assignment to base and mobile stations in the automobile emergency radio service only. The following frequencies

are available for assignment to base and mobile stations in the automobile emergency radio service, under the terms of a development grant only: 453.85 mc. (available to automobile associations

only) and 453.95 mc. (available to public garages only).

Presumably, a group of garages would be authorized to operate jointly providing each were eligible individually.

Technical Information:

The same requirements apply to automobile emergency radio service as are listed under technical information for intercity bus service.

CHAPTER 3: LICENSE APPLICATION

A STEP-BY-STEP EXPLANATION OF PROPER LICENSE APPLICATION PROCEDURE, WITH LICENSE RENEWAL INFORMATION AND ADDRESSES OF FCC FIELD OFFICES

THE radio spectrum is one of our greatest natural resources. As in the case of our oil and lumber reserves, the available supply of this particular natural resource is limited. Unlike our oil and lumber resources, however, the indiscriminate use of the available radio spectrum would totally destroy its utility for all. Our Government has, therefore, undertaken to parcel out the radio spectrum in a manner that will best serve the national interest.

The task of parcelling out the radio spectrum equitably is obviously too detailed a job for the legislative branch of our Government. Congress has found it necessary to delegate the job to an administrative agency which can devote full time to the work. The agency created by Congress for the purpose of administering the use of the radio spectrum is the Federal Communications Commission. Congress has provided that no one may transmit radio communications without prior authorization from this agency. (In the case of governmental agencies, their authority to use radio is derived from the President through the Inter-departmental Radio Advisory Committee, established for the purpose.)

To assure that the spectrum would not be used indiscriminately and that authorized services would not be interfered with by unauthorized users, Congress has made radio transmission without prior FCC authorization a felony. The offense is punishable by a maximum fine of \$10,000, or imprisonment for two years, or both (Section 501, Communications Act).

Against this background, the need for FCC authorization of all radio use clearly appears. The FCC itself must be assured that every prospective radio user falls within one of the selected classes of persons eligible to use radio; that his plans for radio use have been definitized in a manner that will assure conformance with the FCC Rules adopted for the particular type of radio service desired; and that the prospective user is legally, technically, and financially qualified to operate the radio system proposed. All the information necessary to a determination of these questions is elicited by the FCC in application forms adopted for the different radio services. Thus, everyone who would operate a mobile radio system must first file one of these applications with the FCC.

In the mobile radio services, the Com-

mission has adopted ten principal forms of application (two of which were made obsolete on July 1, 1949) as follows:

New or Modified CP:

FCC FORM 401: *Application for New or Modified Radio Station Construction Permit.* This is probably the most commonly used form in the non-broadcast field. It should be used whenever any doubt exists as to the particular form to be employed, as it is the most detailed and, therefore, most complete form possible to submit to the Commission. It is to be used by all applicants for land transportation, industrial, general or limited common carrier, and experimental radio facilities. Upon the grant of this application, the Commission issues a construction permit authorizing the construction of the facilities for which application has been made.

The eight pages of FCC Form 401, filled out as a typical application should be, are shown on the following pages. This sample application, if studied carefully, will clarify any uncertainties.

Special Application Form:

FCC FORM 401a: *Description of Proposed Antenna Structure (s).* This is another general form, to be used by applicants for all type stations when the proposed antenna is over 150 ft. in height, or when the antenna is to be located within 3 miles of a landing area, and will exceed an over-all height of 1 ft. above ground for each 100 ft. of distance from the nearest boundary of an airport landing area. This form should be filed simultaneously with the application for construction permit. Although the original and one copy of the main application are sufficient, an original and three copies of the Form 401a are necessary. The extra copies are referred by the FCC to the Civil Aeronautics Administration for comment as to whether the proposed antenna structure would constitute a hazard to air navigation.

Emergency Services:

FCC FORM 401-B: *Application for Police, Fire, or Forestry Radio Station Construction Permit.* This is a special form to be used by all applicants for police, fire, or forestry radio facilities, as specified in its title. This form has been streamlined as much as possible to avoid placing any unnecessary burdens on municipal officers.

Old Form for Utilities:

FCC FORM 401-C: *Application for Radio Station Construction Permit in the Utility or Miscellaneous Radio Services.* This is another special type of streamlined application form formerly used by applicants for power, petroleum, relay press, motion picture, and provisional station authorizations. This form was superseded on July 1, 1949. Although the FCC staff is presently processing applications filed on that form after this date if sufficient information is submitted in the application and supporting correspondence, applicants who formerly used this form should now use FCC Form 401.

Old Railroad Radio Form:

FCC FORM 402: *Application for Railroad Radio Station License.* This is the second of the two forms superseded by the July 1, 1949 land-mobile rules. It is the form that was used in applying for railroad radio station license whenever a 401 construction permit had been filed previously, and for those types of railroad stations located exclusively on railroad rolling stock for which a construction permit is not required (Sec. 319, Communications Act). Since the FCC Form 403 is available for use in applying for a license in those cases, very few applications were submitted for licenses of stations to be used exclusively on railroad rolling stock, Form 402 was withdrawn.

Station License Application:

FCC FORM 403: *Application for Radio Station License or Modification thereof.* This form must be filed by an applicant after his construction permit has been issued and the construction of the station has been completed in accordance with the Commission's rules. This form may also be used in cases where the applicant wishes to modify his license by adding or changing mobile equipments. In such a case, the title of the form should be amended to read "Application for Construction Permit and Radio Station License Modification." Wherever the construction of a new base station or the re-location of the existing base station is involved, however, a Form 401 must be submitted.

Renewal Application:

FCC FORM 405: *Application for Renewal of Radio Station License.* This is

the general form for the renewal of a license, applicable to all types of stations.

Request for Additional Time:

FCC FORM 701: *Application for Additional Time to Construct Radio Station.* This form is to be used in all cases when applying for additional time to complete the construction of a radio station. It is to be used only by holders of valid radio station construction permits. If a construction permit has expired it is necessary to file a new 401 construction permit application, entitling it "Application for Reinstatement of Expired Construction Permit."

Assignment of C P:

FCC FORM 702: *Application for Consent to Assignment of Radio Station Construction Permit or License.* This is the application form to be used when an individually owned business is transformed to a partnership or corporation, when one partner dies or withdraws, when a partnership is transformed into a corporation, or when a business is sold. The assignment of any radio station authorization requires the prior consent of the FCC, and cannot become effective without that consent. Contracts of sale should be drawn accordingly.

FCC FORM 703: *Application for Consent to Transfer of Control of Corporation Holding Construction Permit or Station License.* This is the form used to cover a transfer of control in the ownership of a corporate permittee or licensee. What constitutes a transfer of control varies with different fact circumstances. Sale of a majority or substantial interest in the stock of the corporate licensee is certainly such a transfer of control requiring Commission consent. There is no known formula by which it can be definitely ascertained whether a transfer of affirmative or negative corporate control is involved. All the facts have to be considered and, if there is any question, the advice of counsel should be obtained.

How to Apply for a C P:

The way in which these application forms should be completed may be best illustrated by reference to a particular case. Assume that Yellow Taxi, Inc., has decided to dispatch its cabs by radio. The necessary construction permit application on FCC 401, when submitted to the FCC, would then appear as shown on the following pages.

All applications must be filed directly with the office of the Secretary of the Commission. His address is: Federal Communications Commission, Washington 25, D. C. If the application is of particular importance or requests com-

mon carrier authority or presents a special question—of eligibility or control or coordinated service—it may be found advisable to have the application reviewed and filed by communications counsel.

Legal and Engineering Counsel:

This review and revision as necessary serves two principal purposes. It avoids the delay that attends the second processing of defective applications which are required to be returned by the FCC to the applicant. After such return, the resubmitted application must go to the bottom of the pending application file. As there is presently at least a 60-day time lag on processing applications for new facilities in most of the mobile services, a second delay of this order may be quite serious to particular applicants.

Secondly, if a question is raised by the FCC examining staff with respect to a particular application, counsel may be able to arrange for its speedy disposition without the necessity for time-consuming correspondence by the Commission with the distant applicant. Some help may also be afforded with respect to the frequency selection, by reference to the Commission's records of grants already made.

In most cases where proper frequency selection is of critical importance, however, the Commission requires that the application be accompanied by a letter of frequency recommendation from the particular industry frequency-coordinating committee of the area where operation is proposed. These coordinating committees usually have a master plan of allocations for each area, taking into account the present and probable future use of assigned frequencies. The committee recommendations are advisory only, and need not be followed necessarily if the applicant is not satisfied with the committee recommendation.

Finally, in the case of certain applications such as control, repeater, shared-use, and microwave stations, it may be found advisable to arrange for independent engineering assistance. Control and repeater stations, for example, will only be granted in the 72- to 76-mc band upon a detailed engineering showing of non-interference to the adjacent television channels Nos. 4 and 5. Public safety radio service applicants may use certain railroad and maritime mobile frequencies upon appropriate showing of non-interference to the primary service. The many engineering and cost problems attendant upon microwave installations will also require special engineering assistance both at the application and installation stages.

After the construction permit has been issued, the applicant has a period of 8

months within which to complete construction. When the facilities have been installed, they may be tested by giving 2 days' advance notice in writing to the FCC Engineer in Charge of the Radio District in which the base station is located. This notice should give the name of the permittee, station location, call sign, and the frequencies on which the tests are to be conducted. After testing, the application for regular license on FCC Form 403 should then be filed with the Commission. Station operation may be properly continued without interruption while the Commission is taking action on the Form 403 license application. This usually requires less than 30 days. The license then issued will normally have a 4-year term, at the expiration of which a renewal application on FCC Form 405 must be filed. Information on license renewals will be found at the end of this chapter.

Notes on CP Applications:

A review of several thousand of these 401 applications has made it clear that mistakes in the preparation of these forms are made principally because the person preparing the form does not know the reason for the questions asked by the FCC in the form. The following comments with respect to the various questions contained in the basic FCC 401 construction permit application should serve to eliminate the most common mistakes made.

Item 6 (a): The FCC is prohibited from granting a license to any alien or a foreign corporation by Section 310 (a) of the Communications Act of 1934, as amended.

Item 7: The FCC also is prohibited from granting a license to a representative of an alien or of a foreign government by Section 310 (a).

Item 8: It is not necessary to submit copies of the company's articles of incorporation unless an AM, FM, or TV broadcast or common carrier application is involved.

Item 8 (c) & (d): The FCC is prohibited by Section 310 (a) from granting a station license to any corporation of which any officer or director is an alien, or in which more than one-fifth of the capital stock is owned of record or voted by aliens or their representatives, or by a foreign government or representative thereof, or by any corporation organization under the laws of a foreign country. If such a corporation is interested in radio use, there are usually certain legal procedures that can be employed to permit the benefits of radio use.

Item 8 (e) & (f) & 9 (a): The answers to these questions in the case of most applicants will normally be in the

File No.

Call Letters

BASE STATION
UNITED STATES OF AMERICA
FEDERAL COMMUNICATIONS COMMISSION

APPLICATION FOR NEW OR MODIFIED RADIO STATION CONSTRUCTION PERMIT ¹
(OTHER THAN BROADCASTING)

Nature of service..... Class of station.....

(Space above this line for use of Federal Communications Commission)

Submit in duplicate direct to the Federal Communications Commission, Washington, D. C. Swear to one copy only.
(If for an Alaskan station, submit in triplicate to Inspector in Charge, Seattle, Wash.)

Before this application is submitted, applicant should refer to the Rules and Regulations of the Commission, which may be obtained from the Superintendent of Documents, Government Printing Office, Washington, D. C.

TO THE FEDERAL COMMUNICATIONS COMMISSION:

1. Name of applicant Yellow Taxi, Inc. (Must comply with footnote ²)

2. Post-office address: Number and street 213 Elm Street

City New York State New York

3. This application is for:

(a) A new station

(b) Make changes in existing station File No. Call letters

(Of current license)

(c) Modification of valid construction permit File No. Call letters

(Of construction permit)

If (b) or (c) has been checked, indicate nature of proposed construction:

(1) Replace transmitter

(4) Change in location

(2) Additional transmitter

(5) Change in antenna system

(3) Increase in power

(6) Other changes (specify)

4. What is applicant's principal business? Taxi Transportation

5. State whether applicant is an individual, partnership, association, or corporation Corporation

6. If applicant is an individual or partnership, respond to the following inquiries:
(If applicant is a partnership show the following information for each member of the partnership.)

(a) Is applicant a citizen of the United States?

(b) If citizenship is claimed by reason of birth, state date and place of birth

(c) If citizenship is claimed by reason of naturalization of applicant, state the date and place of birth, the date and place of issuance of final certificate of naturalization, the certificate number, and court authorizing the issuance of same

¹ If only additional time for construction is requested, use Form No. 701.

² If a corporation, state corporate name; if a partnership, state names of all partners and the name under which the partnership does business; if an unincorporated association, state the name of an executive officer, the office held by him, and the name of the association. If this application involves a station that is now authorized, the name shown herein must correspond exactly with that shown on current authorization.

negative. If they are not, consideration must be given by the FCC to the question of control of the applicant for the reasons indicated in Section 310 (a) (5).

Item 13: A supporting financial statement is not necessary except for broadcast and common carrier applications.

Item 16 (1): Application should be

made for a frequency which is available under the Commission's Rules for the service involved. Information on allocations will be found in chapter 2. A

(d) If citizenship is claimed by reason of naturalization of a parent, state the name of the parent to whom the final certificate was issued, and the age of applicant at the time said certificate was issued, in addition to the information required by subparagraph (c) hereof

7. Is applicant a representative of an alien or of a foreign government? No

8. If applicant is a corporation, including municipal corporations, a copy of the charter, acts of incorporation, or articles of incorporation, certified by the legal custodian of such records, i. e., secretary of state or other governmental official prescribed by the laws of the State of incorporation, shall be attached if not heretofore filed with the Commission.

(a) Under laws of what State or country is it organized? State of New York

(b) Where is applicant's principal office? 213 Elm St., New York, N. Y.

(c) Is more than one-fifth of capital stock owned of record or may it be voted by aliens or their representatives or by a foreign government or representative thereof, or by any corporation organized under the laws of a foreign country? No

(d) Is any director or officer an alien? No If so, state name and position of each

(e) Give names and addresses of all stockholders owning and/or voting 10 percent or more of applicant's stock and percentage of stock held by each None

(f) Is stock to be sold after this permit is issued for purpose of raising money to construct and/or operate the proposed station? No

9. If applicant is a corporation, is applicant directly or indirectly controlled by any other corporation?

(a) If so, give name and address of such controlling corporation None

(b) Under laws of what State or country is such corporation organized?

(A certified copy of the articles of incorporation shall be attached if not heretofore filed with the Commission.)

(c) Is more than one-fourth of capital stock of such corporation owned of record or may it be voted by aliens, their representatives, or by a foreign government or representative thereof, or by any corporation organized under the laws of a foreign country?

(d) Is any director or officer of such corporation an alien? If so, state name and position of each

(e) Is the above-described controlling corporation in turn a subsidiary? If so, attach additional sheets answering question 9 (a) to (d), inclusive, for each company to and including the organization having final control.

10. If application is made in behalf of an unincorporated association, a copy of the articles of association, or bylaws, certified by an appropriate officer of the organization, shall be attached if not heretofore filed with the Commission, and the following information shall be submitted:

(a) Purpose of the association Not applicable

(b) The number of members

(c) Are any members aliens? If so, give approximate number

(d) Is any director or officer an alien? If so, state name and position of each

check should also be made as to whether any frequency-coordinating committee has been set up for the service involved. If so, the committee's frequency recom-

mendation should be obtained and submitted with the application. Item 17: Each base station requires a separate construction permit applica-

tion. For some classes of stations—taxi and automobile emergency included—a blanket base and mobile station application may be submitted on a single 401

11. (a) Is applicant directly or indirectly, through stock ownership, contract, or otherwise, interested in the ownership or control of any other radio stations? **No**
 If so, state call letters and location of such stations

(b) Has the applicant ever been directly or indirectly interested in the ownership or control of any radio stations other than those referred to under (a)? **No**
 If so, state classes of stations and exact names of licensees

(If a large number of stations, chain or otherwise, are involved, the number of each type may be listed in response to paragraphs 11 (a) and (b).)

12. (a) State applicant's relation to station (whether applicant is to be owner or lessee, and, if neither owner nor lessee, state nature of applicant's interest in use and control of station)

Owner of station.

(If not owner, a copy of agreement showing applicant's interest in station must be attached if not heretofore filed with the Commission.)

(b) If applicant is not to be owner of station, who is?

(c) Will applicant have absolute control of station, both as to physical operation and service conducted? **Yes**

(If not, attach copy of any contract which may in any way affect applicant's right to do so.)

13. State fully the facts showing applicant's financial ability to construct and operate this station. (If application is for a station to be operated as a common carrier, there shall be attached hereto, or incorporated herein by reference if already on file with the Commission, applicant's most recent balance sheet.) **Sufficient funds are available for construction and operation of station.**

14. (a) Has the applicant, or any person directly or indirectly controlling the applicant, been finally adjudged guilty by any Federal court of unlawfully monopolizing, or attempting unlawfully to monopolize radio communication, directly or indirectly, through control of manufacture or sale of radio apparatus, exclusive traffic arrangement, or any other means, or of unfair methods of competition? **No**

(b) Is applicant directly or indirectly engaged in the business of transmitting and/or receiving for hire messages of any cable, wire-telegraph, or telephone lines or systems? **No**

15. The nature of service and class of station for which application is made are (indicate by check mark) . If class of station desired is not listed hereon, indicate same by stating class desired on margin hereof.

<i>Nature of service</i>	<i>Class of station</i>
Fixed Public.....	Point-to-point telegraph. Point-to-point telephone. Point-to-point telegraph. Point-to-point telegraph.
Fixed Public Press.....	
Agriculture.....	
Aviation.....	Aeronautical. Aeronautical Fixed. Aeronautical Public Service. Airport control. Instrument landing. Marker beacon. Flying school. Flight test.

Form. If any doubt exists, the safer course is to file separate applications for the base station and for the mobile units. Under no circumstances may a request

for more than one base station authorization be consolidated on one application form, whether or not the base stations are to be incorporated in one mobile

radio system.

Item 19 (a): If the applicant is not going to purchase a frequency monitor, he must have an outside frequency serv-

(b) Tube complement:

	Number and type of tubes	Normal plate current per tube	Plate voltage
Oscillator stage.....	<u>Complete technical details concerning specified transmitter have previously been filed with the Commission by Radio Manufacturer, Inc.</u>		
Intermediate stages.....			
Final radio stage.....			
Modulator.....			

- (c) Describe type of oscillator circuit
- (d) Describe plate power supply for last radio stage
- Rating: Current Voltage
- (e) State type or class of modulation
- (1) Which radio stage is to be modulated?
- (2) State maximum percentage of modulation
- (f) State maximum rated carrier power
- (This power should not be exceeded by the power specified under item 16(3).)
- (g) Indicate frequency range of the transmitter
18. (a) State what apparatus is included as an integral part of the transmitter for automatically holding the frequency within the allowed frequency tolerance
- (Details previously filed by Radio Manufacturer, Inc.)
- (b) Within how many cycles or within what percentage of the assigned frequency is this apparatus designed or guaranteed by the manufacturer to hold the operating frequency?
- (c) State type, number, if any, and name of manufacturer of frequency-control apparatus
- (d) Is frequency-control apparatus automatically maintained at constant temperature?
19. (a) What provision will be made for measurement and periodic checking of the station frequency?
- (1) If a frequency measuring device is not to be installed, give name and address of frequency checking agency
- (If frequency checking agency is shown above, it is not necessary to answer 19(b)(c)(d)(e).)
- (b) What type of frequency measurement or calibration apparatus will be used?
- Radio Manufacturer Simplified Frequency Monitor - Type 600-B.
- (c) Within how many cycles or within what percentage will this apparatus measure the frequency?
- Within 0.002%
- (d) What methods will be used to check the calibration of this precision instrument?
- Will be checked by reference to WWV as required.
- (e) How often will this instrument be checked? As required.

with respect to a particular station site. There is a list of the FCC field offices at the end of this chapter.

Item 23: The local office of the Civil

Aeronautics Administration will be able to render assistance if doubt exists as to the location of airports or airways with respect to a particular station site.

Item 25: If remote control is necessary, questions 25 (a) through (e) should be answered. Item (c) should show that the transmitter will be kept

20. Estimated cost to establish proposed facilities:

(a) Transmitter (ready for service).....	\$ 600.00
Other items (state the nature and amount applicable to each) Receiver	400.00
Power, wiring, radiators, etc.	450.00
<hr/>	
TOTAL ESTIMATED COST.....	\$ 1,450.00

(b) Applications for instruments of authorization by a radio telephone or telegraph common carrier involving expenditures in excess of \$10,000 shall include a statement showing the principal items of property and purchases represented by such costs. Within 90 days after completion of the construction requested herein the applicant shall file with the Commission a summary of the expenditures made and the accounting performed therewith.

21. Proposed location of transmitter: Portable Mobile

Portable-mobile..... If permanently located at a fixed location give:

State New York County New York

City or town New York Street and number 25 Terminal Street

N. latitude: Degrees 41, minutes 15, seconds 25

W. longitude: Degrees 73, minutes 59, seconds 20

(List correct latitude and longitude accurate to seconds.)

22. The following commercial or Government RECEIVING station antenna systems are known to be located within 3 miles of proposed location of transmitter X.Y.Z. Railroad - 1 mile, 716 N. Terminal St. U. S. Wireless Co. - 2-1/2 miles, Barry Hill, New York, N.Y.
No others known to applicant.23. (a) Give name, location of, and distance to all AIRPORTS within 10 miles of proposed location of transmitter None

(b) Name and give distance to any established AIRWAYS within 10 miles of proposed location of transmitter Traffic pattern of Municipal Airport, Northwest approach, extends over the proposed transmitter location. (13 miles to landing area from transmitter site).

24. (a) Type of antenna Radio Manufacturer Type AM300.

(b) Give complete details, including description of directive system, if any Non-directive

(c) Give number and maximum height (in feet) of towers above ground level* 120 feet above ground level. 30 foot mast mounted on 90 foot building.

(d) Will towers be painted and marked to conform with specifications of Civil Aeronautics Administration? If required. However, mast is no higher than surrounding structures.

*If over 150 feet in height or within 3 miles of a Civil Aeronautics Administration landing area, submit Form 401a in quadruplicate.

locked. Item (d) must be answered in the affirmative. Item (e) should specify the equipment giving the name of the manufacturer's name and the manufac-

turer's model number of the remote control unit.

Item 31: The applicant need show only that construction will be completed

within a maximum of 8 months.

The very rapid growth that has marked all mobile radio service use is placing an increasing premium on the

25. Is the transmitter to be operated with licensed operator on duty at a remote control point only?
 **No** If so, the following information must be furnished. (If licensed operator is to be on duty at the transmitter, data required by this item may be omitted.)
- (a) Location of remote control point: (If more than one remote control point is involved, attach supplementary sheet giving location of each remote control point, plan of operation, etc.)
 State County
 City or town Street and No.
- (b) What is the airline distance between transmitter location and remote control point?
- (c) By what means will the transmitter be rendered inaccessible to unauthorized persons?
- (d) Can transmitter be placed in an inoperative condition from the remote control point?
- (e) Describe below the equipment to be used to enable the operator at the remote control point to determine when there is a deviation from the terms of the station license or when operation is not in accordance with the Commission's rules governing the class of station involved.
26. Give location of receiving equipment associated with this station:
 State County **Same location as transmitter.**
 City or town Street and No.
 N. latitude: Degrees, minutes, seconds
 W. longitude: Degrees, minutes, seconds
- (a) List frequencies, call letters, and locations of stations to be regularly received
- (b) In case of common carrier operating in either the fixed public or fixed public press services, state name of organization, agency, or person operating the receiving end of the circuit as required by regulations governing these services
27. (a) Is station to be open to public correspondence? **No** If so, state hours during which station will be open for such service
- (b) Will any charge be made for handling public correspondence?
- If so, state schedules of charges
- (The statement of rates required herein does not constitute a filing of schedules of charges required by Section 203 of the Communications Act of 1934, as amended, prior to commencing service.)
- (c) State basis of division of charges with other stations
28. If station is to be used in the aviation service—
- (a) Will the service of the station be available for any aircraft desiring to make use of it?.....
 **Not applicable**
- (b) During what hours will station be open for communication with such aircraft?
29. State definite facts why the operation of the station will be in the public convenience, interest, or necessity. **Use of these facilities will enhance efficiency and safety of taxicab operations. Both factors are recognized as matters of primary public interest.**

soundest possible guidance at the time initial applications for new facilities are filed. The foregoing general instructions and comments are therefore not intended

to suggest that any particular application may be regarded as a routine matter requiring only adherence to the sample form of application reproduced

above. The completion of the application may be a routine matter; but the decisions reflected in the various answers to the application form may have a very

- 30. If application is for any class of station in the experimental service, attach supplementary statements as required for the particular class of station. (See rules and regulations governing experimental services.) **Not applicable.**
- 31. If application is for new construction permit, the construction, if authorized, will be commenced within 60 days of the granting thereof, and will be completed within 120 days thereafter.
- 32. If this application is for modification of construction permit and extension of time is required, applicant should answer the following questions: **Not applicable.**
 - (a) Applicant requests that the date of required commencement of construction be extended to _____, and that the date of required completion of construction be extended to _____
 - (b) Applicant represents that this construction cannot be completed within the time specified in the existing construction permit due to _____
- 33. Any exhibits referred to herein and those attached hereto, described and identified as follows, are certified to be true and correct. (List here all exhibits attached to the application.) _____
- 34. The applicant waives any claim to the use of any particular frequency or of the ether as against the regulatory power of the United States because of the previous use of the same, whether by license or otherwise, and requests a construction permit in accordance with this application.

Dated this 1st day of October, 1949

Yellow Taxi, Inc.
Applicant (Must correspond with item 1)

By (signed) John Smith

Designate by checkmark below appropriate classification:

- Individual Applicant
- Member of Applicant Partnership
- Officer of Applicant Corporation or Association

Subscribed and sworn to before me this 1st day of October, 19 49

Notary Public.

[SEAL]

(Notary public's seal must be affixed where law of jurisdiction requires, otherwise state that law does not require seal.)

My commission expires _____

profound effect on the applicant's future radio use. In making these decisions, there is no form to follow. Each case must be decided on the basis of its own special facts. The past growth and future expansion of the mobile services, in which all frequencies are assigned on a shared basis only, make it imperative that the most careful and informed judgment be exercised prior to the filing of each FCC application.

Renewal of Licenses:

Common carrier licenses in the domestic public land mobile service are issued for periods of 2 years only and expire on April 1. Ordinarily, when a new station license is granted within 3 months of expiration date for licenses in this service, such a license will be issued for the remainder of the unexpired period and 2 years succeeding. However, if a new

license is granted any time after the normal expiration date up to 21 months, the license is issued for the remainder of the normal unexpired period only.

Licenses in the public safety, industrial, and land transportation radio services are issued initially for periods of 1 to 5 years from the date of the grant, at the discretion of the Commission. This is to permit proper scheduling of renewal applications so as to provide an orderly,

even flow, with resulting prompt action. Renewal licenses will be subsequently granted for the normal period of four years from renewal date.

Renewal applications for all services must be submitted on FCC Form 405 not less than 60 days before expiration date of current licenses.

In all services, developmental licenses will be granted for maximum periods of one year.

LIST OF FCC FIELD OFFICES

DISTRICT 1—BOSTON, MASS.

1600 CUSTOMHOUSE, BOSTON 9

All counties of Connecticut, Maine, Massachusetts, New Hampshire, Rhode Island, and Vermont.

DISTRICT 2—NEW YORK, N. Y.

641 WASHINGTON ST., NEW YORK 14

New Jersey counties of Bergen, Essex, Hudson, Hunterdon, Mercer, Middlesex, Monmouth, Morris, Passaic, Somerset, Sussex, Union, and Warren.

New York counties of Albany, Bronx, Columbia, Delaware, Dutchess, Greene, Kings, Nassau, New York, Orange, Putnam, Queens, Rensselaer, Richard, Rockland, Schenectady, Suffolk, Sullivan, Ulster, and Westchester.

DISTRICT 3—PHILADELPHIA, PA.

1005 U. S. CUSTOMHOUSE, PHILA. 6

Delaware county of New Castle.

New Jersey counties of Atlantic, Burlington, Camden, Cape May, Cumberland, Gloucester, Ocean, and Salem.

Pennsylvania counties of Adams, Berks, Bucks, Carbon, Chester, Cumberland, Dauphin, Delaware, Lancaster, Lebanon, Lehigh, Monroe, Montgomery, Northampton, Perry, Philadelphia, Schuylkill, and York.

DISTRICT 4—BALTIMORE, MD.

GAY ST. AND FALLSWAY, BALTIMORE 2

All counties of District of Columbia and Maryland.

Delaware counties of Kent and Sussex.

Virginia counties of Arlington, Clarke, Fairfax, Fauquier, Frederick, Loudoun, Page, Prince William, Rappahannock, Shenandoah, and Warren.

West Virginia counties of Barbour, Berkeley, Grant, Hampshire, Hardy, Harrison, Jefferson, Lewis, Marion, Mineral, Monongalia, Morgan, Pendleton, Preston, Randolph, Taylor, Tucker, and Upshur.

DISTRICT 5—NORFOLK, VA.

RM. 402, NEW P. O. BLDG., NORFOLK, 10

All counties of North Carolina except District 6.

All counties of Virginia except District 4.

DISTRICT 6—ATLANTA, GA.

411 FEDERAL ANNEX, ATLANTA 3

All counties of Georgia, South Carolina, and Tennessee.

All counties of Alabama except District 8.

North Carolina counties of Ashe, Avery, Buncombe, Burke, Caldwell, Cherokee, Clay, Cleveland, Graham, Haywood, Henderson, Jackson, McDowell, Macon, Madison, Mitchell, Polk, Rutherford, Swain, Transylvania, Watauga, and Yancey.

DISTRICT 7—MIAMI, FLA.

P. O. BOX 150, MIAMI 1

All counties of Florida except District 8.

DISTRICT 8—NEW ORLEANS, LA.

400 AUDUBON BLDG., NEW ORLEANS, 16

All counties of Arkansas, Louisiana and Mississippi.

Alabama counties of Baldwin and Mobile.

Florida county of Escambia.

Texas city of Texarkana only.

DISTRICT 9—HOUSTON, TEX.

7300 WINGATE ST., HOUSTON 11

Texas counties of Angelina, Aransas, Atascosa, Austin, Bandera, Bastrop, Bee, Bexar, Blanco, Brazoria, Brazos, Brooks, Burleson, Caldwell, Calhoun, Cameron, Chambers, Colorado, Comal, De Witt, Duval, Dimmit, Edwards, Fayette, Fort Bend, Frio, Galveston, Gillespie, Goliad, Gonzales, Grimes, Guadalupe, Hardin, Hays, Harris, Hidalgo, Jackson, Jasper, Jefferson, Jim Hogg, Jim Wells, Karnes, Kenedy, Kendall, Kerr, Kinney, Kleberg, LaSalle, Lavaca, Lee, Liberty, Live Oak, Matagorda, Madison, Maverick, McMullen, Medina, Montgomery, Nacogdoches, Newton, Nueces, Orange, Polk, Real, Refugio, San Augustine, San Jacinto, San Patricio, Sabine, Starr, Travis, Trinity, Uvalde, Val Verde, Victoria, Walker, Waller, Washington, Webb, Wharton, Willacy, Williamson, Wilson, Zapata, Zavala, and Tyler.

DISTRICT 10—DALLAS, TEX.

P. O. BOX 5238, DALLAS 2

All counties of New Mexico and Oklahoma.

All counties of Texas except District 9 and the city of Texarkana.

DISTRICT 11—LOS ANGELES, CALIF.

TEMPLE AND SPRING STS., LOS ANGELES 12
All counties of Arizona.

California counties of Imperial, Inyo, Kern, Los Angeles, Orange, Riverside, San Bernardino, San Diego, San Luis Obispo, Santa Barbara and Ventura.

Nevada county of Clark.

DISTRICT 12—SAN FRANCISCO, CALIF.
323-A CUSTOMHOUSE, SAN FRANCISCO 26

All counties of California except District 11.

All counties of Nevada except Clark.

DISTRICT 13—PORTLAND, ORE.

406 CENTRAL BLDG., PORTLAND 5

All counties of Idaho except District 14.

All counties of Oregon.

Washington counties of Wahkiakum, Cowlitz, Clark, Skamania and Klickitat.

DISTRICT 14—SEATTLE, WASH.

801 FEDERAL OFFICE BLDG., SEATTLE 4

All counties of Montana.

All counties of Washington except District 13.

Idaho counties of Benewah, Bonner, Boundary, Clearwater, Idaho, Kootenai, Latah, Lewis, Nez Perce, and Shoshone.

DISTRICT 15—DENVER, COLO.

521 CUSTOMHOUSE, DENVER, 2

All counties of Colorado, Utah and Wyoming.

Nebraska counties of Banner, Box, Butte, Cheyenne, Dawes, Deuel, Garden, Kimball, Morrill, Scotts Bluff, Sheridan and Sioux.

South Dakota counties of Butte, Custer, Fall River, Lawrence, Meade, Pennington, Shannon, and Washington.

DISTRICT 16—ST. PAUL, MINN.

5th AND WASHINGTON STS., ST. PAUL 2

All counties of Minnesota and North Dakota.

All counties of South Dakota except

District 15.

All counties of Wisconsin except District 18.

Michigan counties of Alger, Baraga, Chippewa, Delta, Dickinson, Gogebic, Houghton, Iron, Keweenaw, Luce, Mackinac, Marquette, Menominee, Ontonagon, and Schoolcraft.

DISTRICT 17—KANSAS CITY, MO.

838 U. S. COURTHOUSE, KANSAS CITY 6

All counties of Kansas and Missouri.

All counties of Iowa except District 18.

All counties of Nebraska except District 15.

DISTRICT 18—CHICAGO, ILL.

246 U. S. COURTHOUSE BLDG., CHICAGO 4

All counties of Illinois and Indiana.

All counties of Kentucky except District 19.

Iowa counties of Allamakee, Buchanan, Cedar, Clayton, Clinton, Delaware, Des Moines, Dubuque, Fayette, Henry, Jackson, Johnson, Jones, Lee, Linn, Louisa, Muscatine, Scott, Washington, and Winneshiek.

Wisconsin counties of Brown, Columbia, Calumet, Crawford, Dane, Dodge, Door, Fond du Lac, Grant, Green, Iowa, Jefferson, Kewaunee, Kenosha, Lafayette, Manitowoc, Marinette, Milwaukee, Ozaukee, Oconto, Outagamie, Racine, Richland, Rock, Sauk, Sheboygan, Walworth, Washington, Waukesha, and Winnebago.

DISTRICT 19—DETROIT, MICH.

1029 NEW FEDERAL BLDG., DETROIT 26

All counties of Ohio.

All counties of Michigan except District 16.

All counties of West Virginia except District 4.

Kentucky counties of Bath, Bell, Boone, Bourbon, Boyd, Bracken, Breathitt, Campbell, Carter, Clark, Clay, Elliott, Estill, Fayette, Fleming, Floyd, Franklin, Gallatin, Garrard, Grant, Greenup, Kenton, Harlan, Harrison, Jackson, Jessamine, Johnson, Knott, Knox, Laurel, Lawrence, Lee, Leslie, Letcher, Lewis, Lincoln, Madison, Magoffin, Martin, Mason, McCreary, Meni-

fee, Montgomery, Morgan, Nicholas, Owen, Owsley, Pendleton, Perry, Pike, Powell, Pulaski, Robertson, Rockcastle, Rowan, Scott, Wayne, Whitley, Wolfe, and Woodford.

DISTRICT 20—BUFFALO, N. Y.

328 POST OFFICE BLDG., BUFFALO 3

All counties of New York except District 2.

All counties of Pennsylvania except District 3.

DISTRICT 21—HONOLULU, T. H.

609 STANGENWALD BLDG., HONOLULU 1

Territory of Hawaii and outlying Pacific possessions, except Alaska and adjacent islands.

DISTRICT 22—SAN JUAN, P. R.

P. O. BOX 2987, SAN JUAN 13

Puerto Rico and Virgin Islands.

DISTRICT 23—JUNEAU, ALASKA

P. O. BOX 1421, JUNEAU

Entire Territory of Alaska, including adjacent islands.

CHAPTER 4: EQUIPMENT SPECS

OPERATING SPECIFICATIONS FOR MOBILE RADIO EQUIPMENT OF ALL MAJOR MANUFACTURERS, WITH COMPLETE TUBE LISTS AND DATA ON BATTERY DRAIN

THE selection of communications equipment is not a matter that can be left to the intuition of a purchasing agent. Neither can it be accomplished with any assurance of ultimate satisfaction by drawing up a few general specifications and picking the lowest bidder who promises to meet them. Many installations are bought by these methods. And many systems in operation today have cost far more than the original appropriation before they performed in a satisfactory manner.

In most cases where a contract goes to the lowest bidder, the practice of calling for sealed bids is employed because the man responsible for awarding the job has no knowledge of radio equipment and does not choose, or is not permitted, to seek and follow expert advice. In either case, he may have to deal with factory representatives who, while not qualifying as radio experts, are experienced in doing business with municipal or state officials, or company executives who know nothing at all about radio. Sometimes, the end result of awarding a contract to the lowest bidder is satisfaction. Or it may be just the beginning of a headache!

If specifications are not prepared by an expert, it may be possible to meet them with a low bid that will, in the end, require the expenditure of a much larger amount. It has also happened that less expensive and entirely adequate equipment has been discredited and ruled out, with the result that contracts have gone to higher bidders without any justification in the facts.

Such things were all too frequent before the war. They happen less often now, at least where the larger systems are involved, because most cities and corporations employ communications experts to supervise the installation, operation, and maintenance of their equipment. Their judgment should carry as much weight as the bid prices, both because they have knowledge born of experience, and because they will have the ultimate responsibility for the satisfactory performance of the radio system.

Most of the equipment offered after the war was of prewar design. Even units for the 152- to 162-mc. band were largely revamped versions of 30- to 40-mc. models. The postwar expansion in the use of radio communication was so rapid that it was obvious that frequency allocations and Rules would have to be

changed. In 1947, the FCC started its study of the entire communications field. Then, with the hearings under way, it was impossible for the manufacturers to finalize any new designs until the Commission's work was completed, and its decisions announced.

This situation explains the fact that, even at this time of writing, not all the models in production when the new allocations and rules were made effective have been replaced by designs subsequent to July 1, 1949. And of the new models, some have been put into use so recently that complete performance data is just becoming available.

Thus, in selecting new equipment, the advice and counsel of the communications supervisor or an independent expert in this field is not only important but essential. Or, to put it differently, conditions which have been created by the new allocations and Rules are such that the practice of issuing general specifications and purchasing from the lowest bidder may lead to serious and costly mistakes.

One factor that has an important bearing on the choice between equipment of different manufacturers at about the same price is the availability of adequate service. If a system is large enough to justify the employment of a full-time supervisor who can handle all repair work, or if there is a competent local organization to take care of this work on a contract basis, then factory service is only a minor consideration. On the other hand, a small system in a remote area may be largely dependent on the manufacturer's field service organization to keep its equipment in operating condition. This is just one of the considerations that do not show up in bid prices.

Spare mobile transmitters and receivers are required for most systems. If spares are not available for quick replacement, a car or truck may be tied up when the radio equipment is being serviced. Practically all mobile units are designed so that a defective one can be removed and replaced in two or three minutes. Some are made up with the transmitter and receiver carried in separate cases, others have both sections on a single chassis, while a third arrangement provides a single case holding individual transmitter and receiver chassis. Each has its special advantages of quick replacement and accessibility for repair work, and the various makes must be

judged on their merits. Good and bad design is not disclosed by the price figures.

Another point has a considerable bearing on maintenance cost and outage time: There are two schools of thought about electrical and mechanical design. One holds that there is justification for working on the low side of performance quality and dependability in order to keep the cost at a minimum. The other insists on making cost secondary to achieving the finest performance and eliminating every possible source of failure. This difference must be weighed according to the requirements of each system. Again, expert counsel is needed.

Battery current consumption may or may not be a vital consideration. This depends largely upon the type of service for which the equipment is to be used. If vehicles travel at 25 miles per hour or more during most of the time the receivers are turned on, and if the transmitters are used at infrequent intervals for short messages, batteries and generators supplied as standard equipment will probably be adequate, even for high-power transmitters.

However, frequent message transmission, as in the taxi service, may require the installation of special generators, such as manufactured by Leece-Neville and Bosch, to keep the battery voltage up to normal. This situation will be further aggravated if the vehicles are parked for any considerable periods from day to day, and the radio equipment turned on while the engine is stopped or idling. Obviously, the conditions of use, the standby battery drain, and the possibility of having to install special generators must be weighed carefully in the selection of mobile units.

Under some circumstances, as pointed out in Chapter 5, it may be necessary to include selective calling or fleet control equipment, either as a part of the initial installation or as a facility to be added if operating experience proves it to be necessary.

On the succeeding pages, manufacturers' specifications are given for all types of fixed and mobile equipment available at the time this information was received. It must be emphasized, however, that some of these units are being modified, and others are being replaced by completely new designs. Accordingly, the companies represented should be consulted as to current changes.

COMMUNICATIONS CO., INC.

Coral Gables, Fla.

Fixed: 275-CA, 25-50 or 152-174 Mc.

Transmitter: 25-50 mc, 25 w. 152-174 mc, 15 w.; AC input 85 w. *Tubes:* 6AQ6 speech amp; 6AQ6 osc; 6AQ6 mod; 2)6BH6 trip; 5618 trip; 5618 doub; 2E24 output. 25-50 Mc model does not include 5618 trip. *Notes:* W.E. handset F3AW3; Rex Bassett crystal FT-243.

Receiver: single superhet.; 4.32 mc. IF; Bassett crystal CR-7. *Tubes:* 6AK5 RF; 6AK5 RF; 6AK5 mix; 6BH6 IF; 6BH6 IF; 6BH6 IF; 6BH6 lim; 6BH6 lim; 6AL5 disc; 6AQ6 AF; 6AQ5 output; 6BH6 sq; 6BH6 osc & 1st mult; 6BH6 2nd mult.

Mobile: No. 275-C, 152-174 Mc. or 275-4C, 25-50 Mc.

Transmitter: 25-50 mc, 15 w.; 152-174 mc, 10 w. to RG5U line; 6 v. input; .75 a. stby; 7 a. trans. *Tubes:* same as 275CA. *Notes:* Mallory vibrators; Electro-Voice or Shure mike or W.E. handset F3AW3.

Receiver: same as 275-CA, 5 a.**Mobile: No. 275-5C, 25-50 Mc. or 275-8C, 152-174 Mc.**

Transmitter: 25-50 Mc., 30 w.; 152-174 Mc., 15 w. to RG59U line; 6 v. input; .75 a. stby; 21 a. trans. *Tubes:* same as 275C. **Receiver:** same as 275-CA, 5 a.

Fixed: No. 260T, 152-162 Mc. or 267T, 30-50 Mc.

Transmitter: 50 w. to 52-ohm line; AC input 250 w. *Tubes:* 2)6AQ6 speech amp; 6AQ6 osc; 6AQ6 mod; 6AQ5 doub; 6BJ6 AF; 2)6AQ5 trip; 832A trip; 829B output. (267T does not include 832-A.) *Notes:* W.E. handset F3AW3; Rex Bassett crystal FT-243.

Fixed: No. 389-R, 25-50, 72-76, 152-162 Mc.

Receiver: single superhet.; Bassett crystal CR-7; AC input 67 w. *Tubes:* 6AK5 RF; 6AK5 RF; 6AK5 mix; 7AG7 IF; 7AG7 IF; 7AG7 IF; 7AG7 IF; 7AG7 IF; 7AG7 IF; 7A6 disc; 7C7 AF; 7C5 AF; 7C6 sq; 7AG7 osc-mult; 6AK5 mult; 5Y3GT rect. *Notes:* receiver is carried on a 5 1/4 in. rack panel.

DOOLITTLE RADIO, INC.

Chicago 36, Illinois

Fixed: No. PVFX-1, 30-44 Mc.

Transmitter: 60 w. to 52-ohm line; AC input 160 w. *Tubes:* 6SJ7 osc; 2)6SA7 mod; 2)6SJ7 quad; 6V6 doub; 2)807 output. *Notes:* Shure mike 36A-55B; Knights crystal H21.

Mobile: No. PJY-2V, 3V; 30-44 Mc.

Transmitter: 30 or 60 w. to RG11U line; 6 v. input, 2.6 a. stby. (30 w.); 3.4 a. stby. (60 w.); 27.2 a. trans. (30 w.); 35 a. trans. (60 w.). *Tubes:* same as PVFX-1, but only one 807 output on 30 w. *Notes:* Carter dynamotor type 4726VS; Doolittle mike S-2 or W.E. handset F1-HA1; 2-freq. operation available.

Receiver: double superhet.; 7.6 a.; 3 mc. IF; Knights crystal H7; Mallory vibrator 294. *Tubes:* 6SJ7 RF; 6SA7 1st conv; 6SJ7 IF; 6SA7 2nd conv; 6SJ7 IF; 6SJ7 IF; 6SJ7 IF; 6SJ7 IF; 6SJ7 IF; 6SJ7 IF; 6H6 disc; 6SL7 noise amp & rect; 6SL7 AF & sq; 6V6 output; 6X5 rect for AC & vibrator operation only.

Fixed: No. PFX-1A, 30-44 Mc.

Transmitter: 250 w. to 70-ohm line. *Tubes:* same as PVFX-1 plus 2)HK254 output; 6H6 ant indicator rect; 5Z3 rect; 2)866A rect; 6J5 speech amp.

Fixed: No. PVFX-11, 152-162 Mc.

Transmitter: 30 w. to 52-ohm line; AC input 160 w. *Tubes:* 12AU7 osc; 2)6AK6 mod; 6AK6 quad; 6AK6 trip; 6AQ5 doub; 5516 doub; 2)5516 output. *Notes:* Shure mike 36A-55B; Knights crystal T9A.

Mobile: No. PJY-12V, 152-162 Mc.

Transmitter: 30 w. to RG59U line; 6 v. input,

1.5 a. stby; 35 a. trans. *Tubes:* same as PVFX-11. *Notes:* Carter dynamotor 4726VS; Doolittle mike or W.E. handset F1-HA1; 2-freq. operation available.

Receiver: Double superhet.; 7.5 a.; 2.8 mc. IF; Knights crystal T9A; Mallory vibrator 294. *Tubes:* 2)6AK5 RF; 6AK5 mix; 6AG5 mult; 6AG5 osc; 6SH7 IF; 6SA7 2nd mix; 6SJ7 IF; 6SJ7 IF; 6SJ7 IF; 6H6 disc; 6SL7 AF & sq con; 6SL7 noise amp & rect; 6X5 rect; 6V6GT output.

Fixed: No. PFX-11, 152-162 Mc.

Transmitter: 250 w. to 52-ohm line. *Tubes:* 12AU7 osc; 2)6AK6 mod; 6AK6 quad; 6AK6 trip; 6AQ5 doub; 5516 doub; 2)5516 drivers; 2)4-125A output; 6H6 carrier indicator rect; 3)5Z3 rect; 2)866A rect; 6K6 speech amp.

Portable: No. PJZ-1A, 25-50 Mc.

Transmitter: .25 w. at antenna; wet or dry cell input, 8 hr. on wet cell. *Tubes:* 5672 or 2E32 osc; 2)2E32 mod; 2E32 quad; 2E32 doub; 2E32 doub; 2E32 or 5678 doub; 3V4 output. *Notes:* Oak MV-2 vibrators; W.E. handset or mike and earpiece.

Receiver: double superhet. *Tubes:* 5678 RF; 5678 RF; 2E32 1st mix; 2E32 IF; 2E32 2nd mix; 2E32 IF; 2E32 IF; 2E32 IF; 2)IN34 crystals disc; 2E32 AF; 2E32 output; 2E32 osc.

Portable: No. PJZ-11, 152-162 Mc.

Transmitter: .1 w. output; wet or dry cell input 8 hr. on wet cell. *Tubes:* 5672 osc; 2)5672 mod; 5678 quad; 5678 trip; 5678 doub; 1AD4 doub; 1AD4 output. *Notes:* Oak MV-2 vibrator; W.E. handset or mike and earpiece.

Receiver: double superhet. *Tubes:* 1AD4 RF; 1AD4 RF; 2E32 osc; 1AD4 mult; 5678 1st mix; 2E32 IF; 2E32 IF; 5678 2nd mix; 2E32 IF 2E32 IF; 2E32 IF; 2)IN48 crystal disc; 5678 output.

FEDERAL TEL. & RADIO CORP.

Clifton, N. J.

Fixed: No. 101A50, 30-40 Mc.

Transmitter: 50 w. to 70-ohm line; AC input 360 w. *Tubes:* 6BH6 osc; 6BH6 mod; 6BH6 doub; 6BH6 quad; 6BH6 doub; 2E30 doub; 2)5516 output. *Notes:* Astatic mike FRN-3166-2; crystal FT-110-A.

Fixed: No. 101A250, 30-40 Mc.

Transmitter: 250 w. to 70-ohm line; AC input 1200 w. *Tubes:* same as 101A50 plus 4-250A output.

Mobile: No. FT-110B50AZ, 30-40 Mc.

Transmitter: 50 w. to RG8U line; 6 v. input, 7.12 a. stby.; 50.5 a. trans. *Tubes:* 6BH6 osc; 6BH6 mod; 6BH6 doub; 6BH6 quad; 6BH6 doub; 2E30 doub; 2)5516 output. *Notes:* also available with 25 w. output; Shure mike RA9119-2, or Telephonics handset FRA-11084-2-1; Carter dynamotor; 2-freq. operation available.

Receiver: double superhet.; 10.7 & 1.7 mc. IF; crystal CR-1; Mallory vibrator 659; 6.7 a. *Tubes:* 6AK5 RF; 6BE6 mix; 6AK5 osc; 6BH6 IF; 6BE6 conv; 6BH6 IF; 6BH6 IF; 6BH6 IF; 6AL5 disc; 6J6 noise amp; 6AQ6 AF; 6V6 output; 6X5 rect.

Fixed: No. 103B25, 152-162 Mc.

Transmitter: 25 w. to 50-ohm line; AC input 300 w. *Tubes:* 6BH6 osc; 6BH6 mod; 6BH6 doub; 6BH6 trip; 6BH6 trip; 2E30 amp; 2)2E30 trip; 2)5516 output. *Notes:* Astatic mike FRN-3166-2; crystal CR-1.

Fixed: No. 106C70A, 148-174 Mc.

Transmitter: 60 w. to 50-ohm line; AC input 326 w. *Tubes:* 5763 osc; 5763 mod; 5763 trip; 5763 doub; 5763 doub; 5763 doub; 2E26 driver; 829 output. *Notes:* Astatic mike FRN-3166-2; crystal CR-7.

Fixed: No. 103B250, 152-162 Mc.

Transmitter: 250 w. to 50-ohm line; AC input 1,100 w. *Tubes:* same as 103B25 plus 2)4-125A output.

Mobile: No. FT-145-10A, 152-162 Mc.

Transmitter: 8-10 w. to RG58U line; 6 v. input, 7.3 a. stby; 23.9 a. trans. *Tubes:* 12AU7 osc-lim; 12AU7 mod-trip; 5812 trip; 5812 doub; 5812 doub; 2)5812 output.

Notes: also available for 12 v. operation; Shure mike 101B, or Telephonics handset FRA-11D84-2-1; 2-freq. operation available.

Receiver: double superhet.; 22 & 1.7 mc. IF; crystal CR-7; Oak vibrator FRN-24225-1; 6.7 a. *Tubes:* 6AK5 RF; 6BH6 RF; 6AK5 mix; 6BH6 IF; 6BE6 2nd mix; 6BH6 IF; 6BH6 IF; 6BH6 IF; 6AL5 disc; 6AQ6 1st AF; 6AR5 2nd AF; 6J6 noise amp; 12AU7 osc-doub; 6BH6 mult; 6X4 rect.

Mobile: No. FT-125-B25AZ, 152-162 Mc.

Transmitter: 25 w. to RG58U line; 6 v. input, 7.3 a. stby; 54.8 a. trans. *Tubes:* same as 103B25. *Notes:* Shure mike RA9119-2 or Telephonics handset FRA-11084-2-1; Carter dynamotor; 2-freq. operation available.

Receiver: double superhet.; 10.7 & 1.7 mc. IF; crystal CR-1; Mallory vibrator 659; 6.7 a. *Tubes:* 6AK5 RF; 6AK5 RF; 6AK5 mix; 6BH6 IF; 6AK5 osc; 6AK5 mult; 6BE6 conv; 6BH6 IF; 6J6 noise amp; 6BH6 IF; 6BH6 IF; 6AL5 disc; 6AQ6 AF; 6V6 output.

Mobile: No. FT-125-C30, 148-174 Mc.

Transmitter: 30 w. to RG58U line; 6 v. input, 0.97 a. stby; 46.5 a. trans. *Tubes:* 12AU7 osc-mod; 12AY7 lim-AF; 6AK6 1st trip; 6AK6 2nd trip; 5812 1st doub; 2E24 doub-driver; 2)2E24 output. *Notes:* Shure mike 101B or Telephonics handset FRA-11084-2-1; Carter dynamotor; 2-freq. operation available; 12 v. operation available.

Receiver: double superhet.; 22 & 1.7 mc. IF; Oak vibrator 6608; crystal CR-7, 6.7 a. *Tubes:* same as in FT-145-10.

GENERAL ELECTRIC CO.

Syracuse, N. Y.

Fixed: 25-50 Mc.

Transmitter: 50 w. to 50-70 ohm line, AC input 200 w. *Tubes:* 6BJ6 osc; 12AU7 mod & mult; 6BH6 mult; 6AQ5 mult; 2)807 output; 2)5R4GY rect; 12AX7 mod lim. *Notes:* mike or handset; G.E. crystal G50, G52; choice of 20 or 40 kc. channel width.

Fixed: 25-50 Mc.

Transmitter: 250 w. to 50-70 ohm line; AC input 1,300 w. *Tubes:* 6BJ6 osc; 12AU7 mod & mult; 6BH6 mult; 6AQ5 mult; 2)807 amp; 2)5R4GY rect; 2)866A or 3B23 rect; 2)GL4D21/4-125A output; 12AX7 mod lim. *Notes:* mike or handset; G.E. crystal G50 or G52; choice of 20 or 40 kc. channel widths.

Mobile: 25-50 Mc.

Transmitter: 30 or 50 w. to RG8U line; 6 v. input; 2.25 a. (30 w.), 3.15 a. (50 w.) stby; 31 a. (30 w.), 50 a. (50 w.) trans. *Tubes:* Same as 50 w. fixed transmitter above, except only one 807 output for 30 w. *Notes:* G.E. dynamotor; Military mike or handset; 2-freq. operation available, choice of 20 or 40 kc. channel width.

Receiver: Double superhet.; 6 mc. & 455 kc. IF for 20 kc. channel width, or 750 kc IF for 40 kc channel width. G.E. crystal G64A; Mallory 534C vibrator; 6 a. *Tubes:* 6BH6 RF; 12AT7 1st osc, 1st conv; 6BH6 IF; 12AT7 2nd osc, 2nd conv; 6BH6 IF; 6BH6 IF; 6BH6 IF; 6AQ7 disc & noise amp; 12AX7 sq amp & AF; 6AQ5 output; 6AL5 noise rect.

Fixed: 152-162 Mc.

Transmitter: 50 w. to 50-70 ohm line; AC input 300 w. *Tubes:* 6AU6 osc; 6BA6 doub; 6BA6 trip; 6AQ5 doub; 2E26 doub; 829B output, 6C4 mod; 12AX7 mod lim; 2)5R4GY rect; G.E. crystal G64.

Fixed: 152-162 Mc.

Transmitter: 250 w. to 50-70 ohm lines; AC input 1,300 w. *Tubes:* 6AU6 osc; 6BA6

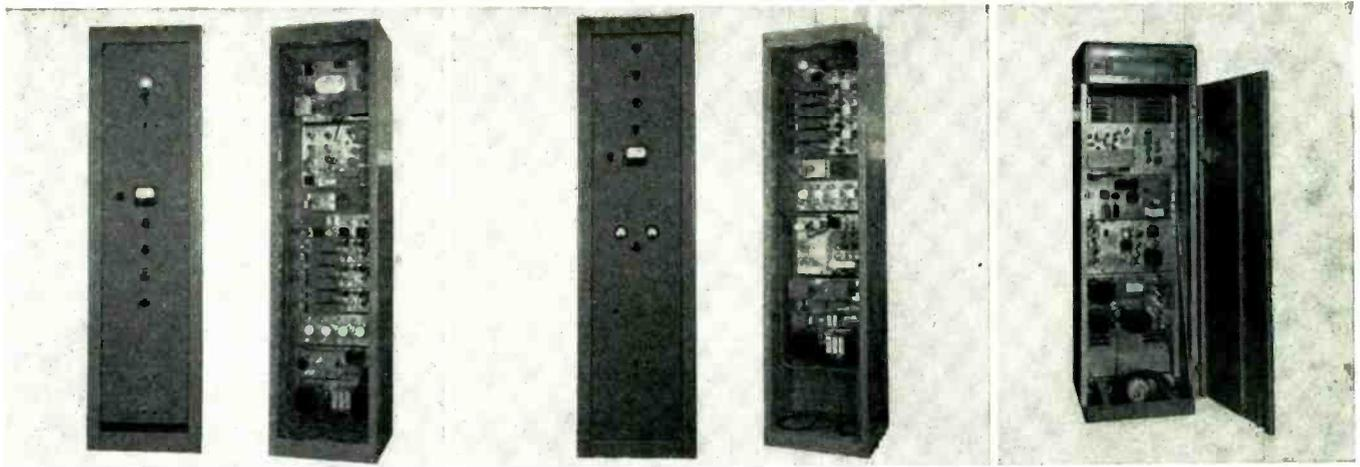

TOP row, left: Raytheon microwave transmitting equipment for link and relay applications. Front and rear views are given. The transmitter is contained in the top panel, followed by the channelizing modulator unit, a meter panel, and four panels of channelizing equipment. Bottom panel contains the power supply. Above this is the channelizing oscillator, and the third panel up con-

tains the frequency-multiplier unit. At top center is the associated receiving equipment. The four input channelizing panels are at the top of the rack. Below them are the meter and frequency-multiplier panels. The receiver is next, with the power supply at the bottom.

A view of Philco's 40-w., 152- to 162-mc. base-station equipment is given at top right. Output of 250 w. can be ob-

tained by adding a pair of 4D21's, a 6X5, and a 6AL5. In the CENTER row, at left, is the associated mobile equipment. These two racks can be combined, one above the other. Chassis are on pull-out drawers for servicing.

Center photo shows Motorola mobile equipment mounted in trunk. At the extreme right center, above the license plate, is a Vibrasponder unit for Moto-

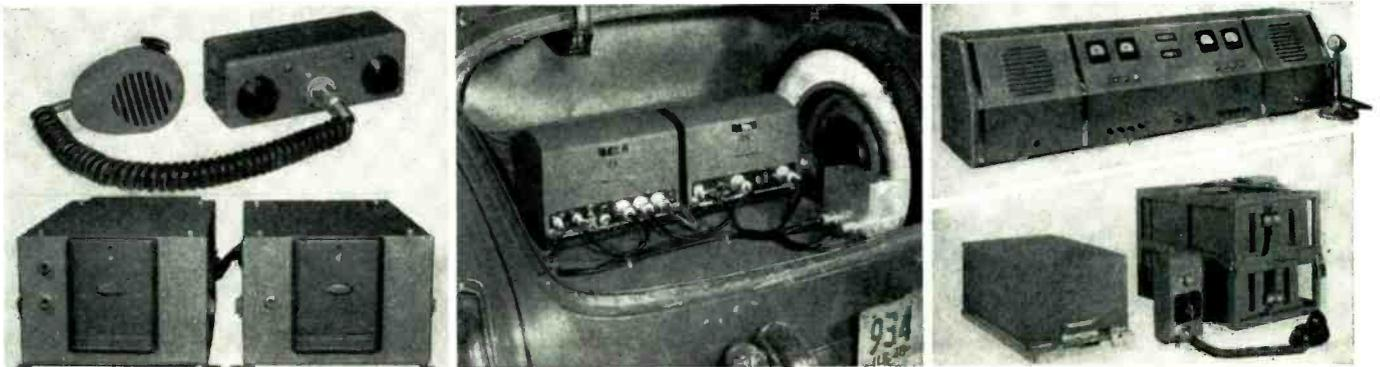

rola's Quik-Call system of selective calling. The lower right-hand picture, center row, shows Motorola one-, two-, or three-channel railroad equipment, operating on 152 to 162 mc., with an output of 30 w.

Just above this is a complete Federal base-station installation for remote-control. Entire front and top of console lifts up as one section for servicing.

IN THE bottom row at left is shown a

base-station transmitter-receiver by Federal. Units in this locally-controlled 25-w., 152- to 162-mc. rack pull out easily as drawers. Another Federal drawer-combination is shown in the center. This is a standard mobile-unit installation, available for 30 to 44 mc. with 25- or 50-w. outputs, and with 25 w. only on 152 to 162 mc.

A complete mobile installation is

shown at the right. Made by General Electric Co., both transmitter and receiver have front-panel jacks for taking meter readings. Two-frequency operation is available on both 25- to 50-mc. and 152- to 162-mc. bands. Power output is 20 w. on 152 to 162 mc., and 30 or 50 w. on 25 to 50 mc. Associated transmitters are available for 50- or 250-w. operation on both frequency bands.

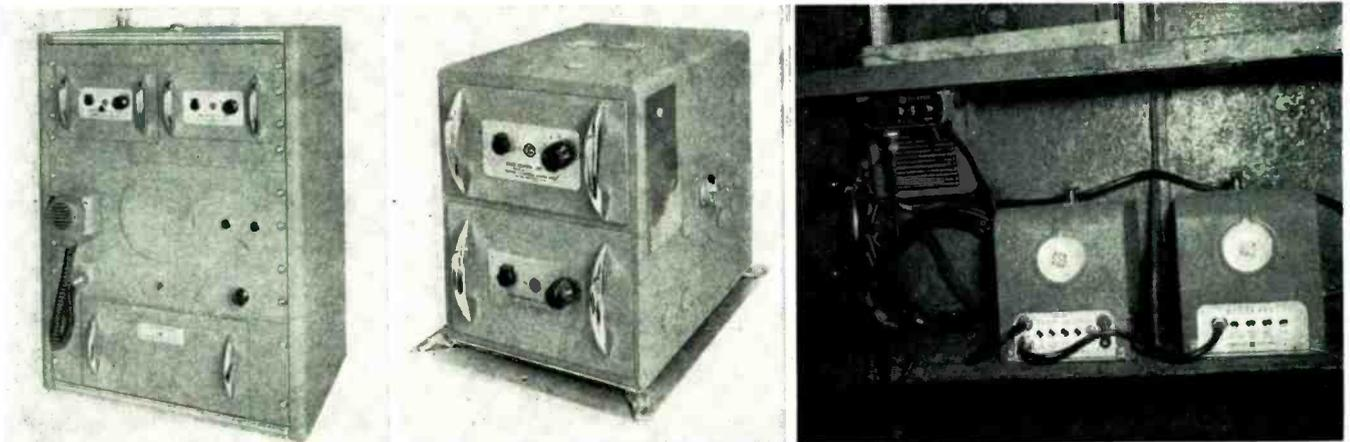

doub; 6BA6 trip; 6AQ5 doub; 2E26 doub; 829B amp, 2)GL4D21/4-125A output; 6C4 mod; 12AX7 mod lim.; 2)5R4GY rect. 2)866A or 3B23 rect; G.E. crystal G64.

Mobile: 152-162 Mc.

Transmitter: 20 w. to RG58U line; 6 v. input, 3 a. stby; 30 a. trans. *Tubes:* 6AG5 osc; 6AG5 quad; 2E30 doub; 2E30 trip; 2E30 doub; 2)2E24 output; 6AG5 mod. *Notes:* G.E. dynamotor; Shure military mike or handset; 2-freq. operation available, 12AX7 modulation limiter available.

Receiver: double superhet.; 6.1-6.7 & 2 mc. IF; G.E. crystal G64A; vibrator power supply. *Tubes:* 6AK5 RF; 6AK5 RF; 6GH6 1st mix; 2)6BJ6 IF; 6BH6 2nd mix; 6BJ6 IF; 6BH6 lim; 6BH6 lim; 6AQ7 disc & noise amp; 6BJ6 osc & trip; 6J6 trip & doub; 6AL5 noise rect; 6SL7-DC amp & AF; 6AQ5 output.

HARVEY RADIO LABS., INC.
Cambridge, Mass.

Fixed: 30-44 Mc.

Transmitter: 25 to 250 w. to 72-ohm line. *Tubes:* 7C7 osc; 7A8 mod; 7AG7 quad; 7C7 doub; 7C5 doub; 7C5 doub; 2)807 output; plus 2)100th for 250 w.

Mobile: 30-44 Mc.

Transmitter: 25 watts to RG8U line; 6 v. input, 2.4 a. stby; 35 a. trans. *Tubes:* same as fixed transmitter, but with one 807 output. *Notes:* W.E. military mike or F3WES handset; Carter dynamotor 620-VS; 2-freq. operation available.

Receiver: double superhet.; 4.5 & 1.6 mc. IF; Radiart vibrator 5515, 5.4 a. *Tubes:* 7AG7 RF; 7AG7 1st mix; 7AG7 IF; 7A8 2nd mix; 7AG7 IF; 7AG7 lim; 7AG7 lim; 7A6 det; 7AG7 osc; 7AG7 noise amp; 7N7 AF & noise rect; 7F7 AF & control; 7C5 output.

Fixed: 152-162 Mc.

Transmitter: 30 or 250 w. to 72-ohm line. *Tubes:* 6AQ6 osc; 6AQ6 speech amp; 6AQ6 mod; 6AK5 trip; 6AQ5 quad; 6AQ5 doub; 2E26 doub; 2)2E26 output; plus 2)WL4D21-4-125A for 250 w.

Mobile: 152-162 Mc.

Transmitter: 30 w. to RG58U lines; 6 v. input; 2.4 a. stby; 35 a. trans. *Tubes:* same as 30 w. fixed transmitter, but with 2)5516 output. *Notes:* Shure mike 101B or W.E. F3WES handset; Carter dynamotor 620-VS **Receiver:** double conversion single crystal; 1st IF 7.3-11.5 mc; 2nd IF 1.7 mc; Radiart vibrator 5515; crystal FT-248. *Tubes:* 6AK5 RF; 6AK5 RF; 6AK5 mix; 6BJ6 IF; 6BJ6 IF; 6BJ6 2nd mix; 6BJ6 IF; 6BH6 lim; 6BH6 lim; 6AL5 disc; 6BH6 noise amp, 12AV7 1st & 2nd AF; 12AX7 noise rect; 6BJ6 osc; 6AK5 mult; 6AQ5 output.

KAAR ENGINEERING CO.

Palo Alto, Calif.

Fixed: No. FM-50A, 30-44 Mc.

Transmitter: 50 w. to 30-70 ohm line; AC input 350 w. *Tubes:* 6V6GT osc; 6V6GT mod; 6V6GT mod; 6V6GT amp mod; 6V6GT trip; 6V6GT quad; 6V6GT quad; 2)807 output; 3)5R4GY rect. *Notes:* Kaar mike G-635; Kaar crystal E.

Mobile: No. FM-50FX, 30-44 Mc.

Transmitter: 50 w. output; 6 v. input, 0 a. stby; 40 a. trans. *Tubes:* 5618 osc; 5618 mod; 5618 mod; 5618 amp mod; 5618 quad; 5618 quad; 2E25A trip; 2)HY69 output. *Notes:* Kaar mike 4C or Conn. handset 2060-W; Carter dynamotor; 2-freq. operation available.

Fixed: No. FM-100A, 30-40 Mc.

Transmitter: 100 w. to 30-70 ohm line. *Tubes:* same as FM-50A, but with 4D22 instead of 2)807 output tubes.

Fixed: No. FM-250A, 30-40 Mc.

Transmitter: 250 w. to 30-70 ohm line.

Tubes: same as FM-50A, plus 4-250A output. **Receiver:** double superhet.; 5.1-5.9 mc. & 455 kc. IF; Oak vibrator; Kaar crystal E; 5.8 a. *Tubes:* 6SS7 RF; 6SS7 RF; 6SS7 1st conv; 6G6G osc; 6SS7 IF; 6SS7 2nd conv; 6SJ7 lim; 6SJ7 lim; 6H6 disc; 6SZ7 noise amp & rect; 6SZ7 AF & sq; 6G6G output.

Mobile: No. FM-100X, 30-44 Mc.

Transmitter: 100 w. output; 6 v. input; 0 a. stby; 70 a. trans. *Tubes:* same as FM-50X except 2)HY69 output.

Fixed: No. FM-70A, 72-76 Mc.

Transmitter: 25 w. to 50-70 ohm line; AC input 350 w. *Tubes:* 6V6GT osc; 6V6GT mod; 6V6GT mod; 6V6GT amp mod; 6V6GT quad; 6V6GT quad; 2E26 doub; 2)807 output. *Notes:* Kaar mike G-635; Kaar crystal E.

Mobile: No. FM-70X, 72-76 Mc.

Transmitter: 20 w. output; 6 v. input, 0 a. stby; 40 a. trans. *Tubes:* 5618 osc; 5618 mod; 5618 mod; 5618 amp mod; 5618 quad; 5618 quad; 2E25 trip; 2)807 doub-output. *Notes:* Kaar mike 4C or Conn. 2060-W handset; Carter dynamotor; 2-freq. operation available.

Receiver: double superhet.; 5.1-5.9 mc. & 455 kc. IF; Oak vibrator; Kaar crystal E; 5.8 a. *Tubes:* same as 30-44 receiver.

Fixed: No. FM-176A, 152-162 Mc.

Transmitter: 50 w. to 50-70 ohm line; AC input 350 w. *Tubes:* 6V6GT osc; 6V6GT mod; 6V6GT mod; 6V6GT amp mod; 6V6GT quad; 6V6GT trip; 6V6GT doub; 2E26 doub; 829B output. *Notes:* Kaar mike G-635; Kaar crystal E.

Fixed: No. FM-252A, 152-162 Mc.

Transmitter: 250 w. to 50-70 ohm line. *Tubes:* same as FM-176A, plus GL-591 output.

Mobile: No. FM-177X, 152-162 Mc.

Transmitter: 15 w. output; 6 v. input; 0 a. stby; 25 a. trans. *Tubes:* 3A4 osc-mod; 3A4 quad; 3A4 trip; 3A4 doub; 2E24 doub; 2E24 output. *Notes:* Kaar mike 4C or Conn. handset 2060-W; Oak vibrator; Kaar crystal E or H; 2-freq. operation available.

Receiver: double superhet.; 5.3-5.7 mc. & 455 kc. IF; Oak vibrator; Kaar crystal E or H; 4 a. *Tubes:* 6AK5 RF; 6AK5 RF; 6AK5 1st mix; 6AK5 osc; 6BH6 mult; 6BH6 IF; 6BH6 2nd mix; 6BH6 IF & lim; 6BH6 lim; 6AL5 disc; 6BH6 noise amp; 6AQ6 AF & noise rect; 2)6AK6 output.

Mobile: No. FM-179X, 152-162 Mc.

Transmitter: 50 w. output; 6 v. input, 0 a. stby; 55 a. trans. *Tubes:* same as FM-177X except 4-65A output and Westinghouse dynamotor.

LINK RADIO CORP.

New York, N. Y.

Fixed: No. 2365, 25-50 Mc.

Transmitter: 30 w. to 50-70 ohm line; AC input 245 w. *Tubes:* 12AT7 osc & mod; 6BJ6 doub; 6BJ6 quad; 2E30 doub; 2E30 doub; 2)2E24 output. *Notes:* W.E. mike F3; Bliley crystal FM8.

Receiver: double superhet.; 5 mc. & 456 IF; Bliley crystal. *Tubes:* 6BJ6 RF; 12AT7 mix & osc; 6BJ6 IF; 6BE6 conv; 6BJ6 IF; 6BJ6 lim; 6BJ6 lim; 6AL5 disc; 12AX7 noise amp & rect; 12AX7 AF & sq; 6AQ5 output.

Fixed: No. 50-UFS, 25-50 Mc.

Transmitter: 50 w. to 50-70 ohm line; AC input 275 w. *Tubes:* 7A4 AF; 7F7 osc-mod; 7V7 doub; 7C5 doub; 7C7 quad; 7C5 doub; 2)807 output. *Notes:* W.E. mike F3; Bliley crystal FM8.

Receiver: same as No. 2365.

Fixed: No. 250-UFS, 25-50 Mc.

Transmitter: 250 w. to 50-200 ohm lines; AC input 1100 w. *Tubes:* same as No. 50-UFS plus final amp.

Receiver: same as No. 2365.

Mobile: No. 2365-LR, 25-50 Mc.

Transmitter: 30 w. to RG58U line; 6 v. input, 1.9 a. stby 25 a. trans. *Tubes:* same as No. 2365. *Notes:* vibrator pwr. supply; W.E. handset, 2-freq. operation available.

Receiver: double superhet.; 5 mc. & 456 kc. IF; Bliley crystal MC9 or FM11; Mallory 1501/94 vibrator; 6.3 a. *Tubes:* same as No. 2365.

Fixed: No. 2210, 152-174 Mc.

Transmitter: 7-10 w. to 50-70 ohm line; AC input 190 w. *Tubes:* 7F7 osc & mod; 6AK5 quad; 6AK5 trip; 2E30 doub; 2E30 doub; 2E24 output. *Notes:* W.E. mike F3; Bliley crystal FM10 or FM10H; available for 75 w. operation.

Receiver: double superhet.; 10.7 mc. & 456 kc. IF; Bliley crystal MC9 or FM11. *Tubes:* 6AK5 RF; 6A1T6 osc; 6AK5 mix; 7AG7 IF; 7AG7 IF; 7A8 conv; 7AG7 lim; 7C7 lim; 7A6 disc; 7A6 noise rect; 7F7 AF & sq; 7B5 output.

Relay: No. 50 MRB, 150-220 Mc.

Transmitter: 50 w. to 50-100 ohm line; AC input 400 w. *Tubes:* 6J5; 6SL7; 3)6SJ7; 3)6V6; 2E26; 2)829B. *Notes:* VPI crystal DC-12A; 12 v. dynamotor for DC operation available.

Fixed: No. 1907, 152-174 Mc.

Transmitter: 50 w. to 50-70 ohm line; AC input 250 w. *Tubes:* 7A4 AF; 7F7 osc & mod; 7AG7 quad; 7W7 doub; 2E26 trip; 2E26 doub; 829B output. *Notes:* W.E. mike F3; Bliley crystal FM10 or FM10H.

Receiver: same as No. 2210.

Fixed: No. 1908, 152-162 Mc.

Transmitter: 250 w. to 40-150 ohm line; AC input 1200 w. *Tubes:* same as No. 1907 plus final amp. *Notes:* W.E. mike F3; Bliley crystal FM8.

Receiver: same as No. 2210.

Mobile: No. 2210 L-R, 152-174 Mc.

Transmitter: 7-10 w. to RG58U line; 6 v. input, 2 a. stby; 18 a. trans. *Tubes:* same as No. 2210. *Notes:* W.E. handset; vibrator pwr. supply; 2-freq. operation available.

Receiver: double superhet; Bliley crystal MC9 or FM11; Mallory vibrator 1501; 7 a. *Tubes:* same as No. 2210.

Fixed: No. 2340-TR, 450-460 Mc.

Transmitter: 10 w. to 50-100 ohm line; AC input 200 w. *Tubes:* 7A4 AF; 7F7 osc & mod; 7AG7 quad; 7W7 doub; 2E26 trip; 2E26 doub; 4X150A trip; 829B output. *Notes:* VPI crystal DC-12A; narrow, medium or wide bandwidths; 100 w. operation available.

Relay: No. 25-PRB, 450-460 Mc.

Transmitter: 25 w. to 50-100 ohm line; AC input 400 w. *Tubes:* 6J5 AF; 6V6 doub; 2E26 doub; 4X150A trip; 6V6 trip; 829B trip output; OD8/VR-150 reg.

Fixed: No. 2048-TR, 940-962 Mc.

Transmitter: 20 w. to 50-100 ohm line; AC input 240 w. *Tubes:* 7A4 AF; 7F7 osc & mod; 7W7 doub; 2E26 trip; 2E26 doub; 4X150A trip; 4X150A doub; 829B output. *Notes:* VPI crystal DC12; narrow, medium or wide bandwidths.

MOTOROLA, INC.

Chicago 51, Illinois

Fixed: No. FSTR-80BY(A), 25-50 Mc.

Transmitter: 30 w. to 50-72 ohm line; AC input 225 w. *Tubes:* 6AK6 osc; 7V7 mod; 7V7 doub; 7C5 doub; 2E26 doub-driver; 2)2E26 output; 12AX7 IDC amps; 6AL5 IDC clip-lim; 2)5R4GY rect. *Notes:* Shure mike or W.E. handset; Motorola DO4 temp. cont. crystal; 2 or 3-freq. operation available; case mounting.

Receiver: double superhet.; 2.7 mc. & 455 kc. IF; Motorola temp. cont. crystal; Sensicon circuit; Permakay filter; 2-freq. Sen-

sicon recvr. available. *Tubes:* 6BH6 RF; 6BH6 RF; 6C4 osc; 6BH6 1st mix; 6BH6 IF; 6BH6 2nd osc; 6BH6 2nd mix; 6BH6 IF; 6BH6 IF; 6BH6 IF; 6BH6 IF; 6BH6 lim; 6BJ6 lim; 6AL5 disc; 6BH6 noise amp; 6AL5 noise rect; 12AX7 1st AF & sq; 6AQ5 output.

Fixed: No. FSTR-80BY(B), 25-50 Mc.
Transmitter: 30 w. to 50-72 ohm line; AC input 225 w. *Tubes:* same as No. FSTR-80BY(A); case mounting.

Receiver: double superhet.; 2.7 & 1.7 mc. IF; Motorola temp. cont. crystal. *Tubes:* 6BH6 RF; 6BH6 RF; 6BH6 1st mix; 6BH6 1st osc; 6BJ6 IF; 6BJ6 IF; 6BH6 2nd mix; 6BH6 2nd osc; 6BJ6 IF; 6BJ6 lim; 6BJ6 lim; 6AL5 disc; 6BH6 noise amp; 6AL5 noise rect; 12AU7 1st AF & sq; 6AQ5 output.

Fixed: No. FSTR-80BR(A), 25-50 Mc.
Transmitter and receiver same as No. FSTR-80BY(A) except in cabinet.

Fixed: No. FSTR-80BR(B), 25-50 Mc.
Transmitter and receiver same as No. FSTR-80BY(B) except cabinet.

Fixed: No. FSTR-140BY(A), 25-50 Mc.
Transmitter: 60 w. to 50-72 ohm line, AC input 375 w. *Tubes:* same as No. FSTR-80BY(A) except 829B output; case mounting.

Receiver: same as No. FSTR-80BY(A).

Fixed: No. FSTR-140BY(B), 25-50 Mc.
Transmitter: 60 w. to 50-72 ohm line, AC input 375 w. *Tubes:* same as No. FSTR-80BY(A) except 829B output; case mounting.

Receiver: same as No. FSTR-80BY(B).

Fixed: No. FSTR-140BR(A), 25-50 Mc.
Transmitter and receiver same as No. FSTR-140BY(A) except cabinet mounting.

Fixed: No. FSTR-140BR(B), 25-50 Mc.
Transmitter and receiver same as No. FSTR-140BY(B) except cabinet mounting.

Fixed: No. FSTR-520BR(A) 25-50 Mc.
Transmitter: 250 w. to 50-72 ohm line; AC input 1100 w. *Tubes:* same as No. FSTR-80BY(A) plus 2)100TH output and 2)866A rect. *Notes:* Shure military mike or W.E. handset; Motorola DO4 temp. cont. crystal; 2-freq. operation available.

Receiver: same as No. FSTR-80BY(A).

Fixed: No. FSTR-520BR(B), 25-50 Mc.
Transmitter: 250 w. to 50-72 ohm line; AC input 1100 w. *Tubes:* same as No. FSTR-80BY(A) plus 2)100TH output and 2)866A rect. *Notes:* same as No. FSTR-80BY(A).

Receiver: same as No. FSTR-80BY(B).

Mobile: No. FHTR-1A (Handi-Talkie Unit) 25-50 Mc.
Transmitter: .5 w. output; 0 w. stby.; 5.8 w. trans. *Tubes:* 5672 osc; 2E36 mod; 2E36 buf; 5672 mult; 2)2E36 mult; 1S4 mult; 3B4 output. *Notes:* 3 miniature 67½ v. B bat; W.E. handset.

Receiver: single superhet.; 2.1 mc. IF; Motorola crystal 802; 1.25 w. *Tubes:* CK569AX/5168 RF; 2E32 RF; 2E36 mix; 2E32 IF; 2E32 IF; 2E32 IF; 2E32 lim; 2E32 lim; 2E36 AF; 5672 osc & mult; 5672 mult; 2)IN34 crystal disc.

Mobile: No. FMTR-40V(B), 25-50 Mc.
Transmitter: 10 w. to 50-72 ohm line; 6 v. input. 3.5 a. stby.; 16 a. trans. *Tubes:* 6AK6 osc; 6AU6 mod; 6AK6 buf; 6AK6 doub; 6AK6 doub; 6AK6 doub; 2E26 doub-driver; 2E26 output; OZ4. 6X5, or CK1204 rect. *Notes:* Shure military mike or W.E. handset; Motorola "temp-fixed" crystal; IDC; 2-freq. operation available.

Receiver: double superhet.; 2.7 & 1.7 mc. IF; Oak or Mallory vibrator; Motorola temp. cont. crystal; 5.5 a. *Tubes:* 6BH6 RF; 6BH6 RF; 6BH6 1st mix; 6BH6 1st osc; 6BJ6 IF; 6BJ6 IF; 6BH6 2nd mix; 6BH6 2nd osc; 6BJ6 IF; 6BJ6 lim; 6BJ6 lim; 6AL5 disc; 6BH6 noise amp; 6AL5 noise rect; 12AU7 1st AF & sq; 6AQ5 output.

Mobile: No. FMTR-40V(A), 25-50 Mc.
Transmitter: 10 w. to 50-72 ohm line; 6 v. input, 3.5 a. stby.; 16 a. trans. *Tubes:* same as No. FMTR-40V(B).

Receiver: same as No. FSTR-80BY(A); 7.5 a.

Mobile: No. FMTR-80D(A), 25-50 Mc.
Transmitter: 30 w. to RG8U line; 6 v. input, 7.0 a. stby.; 40 a. trans. *Tubes:* same as No. FSTR-80BY(A) except no rect. *Notes:* Shure military mike or W.E. handset; Motorola DO4 temp. cont. crystal; Carter dynamotor; 2 or 3-freq. operation available.

Receiver: same as No. FSTR-80BY(A); 7.5 a.

Mobile: No. FMTR-80D(B), 25-50 Mc.
Transmitter: 30 w. to RG8U line; 6 v. input, 7.0 a. rec; 40 a. trans. *Tubes:* same as No. FSTR-80BY(A) except no rect.

Receiver: same as No. FSTR-80BY(B); 5.5 a.

Mobile: No. FMTR-140D(A), 25-50 Mc.
Transmitter: 60 w. to RG8U line; 6 v. input; 8.0 a. stby.; 64 a. trans. *Tubes:* same as No. FSTR-80BY(A) except no rect. *Notes:* same as FMTR-80D(A).

Receiver: same as No. FSTR-80BY(A); 7.5 a.

Mobile: No. FMTR-140D(B), 25-50 Mc.
Transmitter: 60 w. to RG8U line; 6 v. input; 8.0 a. stby.; 64 a. trans. *Tubes:* same as No. FSTR-80BY(A) except no rect. *Notes:* same as No. FMTR-80D(A).

Receiver: same as No. FSTR-80BY(B); 5.5 a.

Fixed: No. FSTRU-80BY(A), 152-174 Mc.
Transmitter: 30 w. (152-170 mc.) or 25 w. (170-174 mc.) to 50-72 ohm line; AC input 250 w. *Tubes:* 6AK6 osc; 7V7 mod; 7V7 buf-doub; 7C5 trip; 7C5 doub; 2E26 doub-driver; 2)2E26 output; 6AL5 IDC clip-lim; 12AX7 IDC amp; 2)5R4GY rect. *Notes:* Shure carbon desk mike or W.E. handset; Motorola DO1 temp. cont. crystal; 2- or 3-freq. operation available; case mounting.

Receiver: same as No. FSTR-80BY(A) except high IF is 5.5 mc. and only one RF stage; 7.5 a.

Fixed: No. FSTRU-80BY(B), 152-174 Mc.
Transmitter: 30 w. to 50-72 ohm line; AC input 250 w. *Tubes:* same as No. FSTRU-80BY(A); case mounting.

Receiver: double superhet.; 7.3-8 and 1.7 mc. IF; Motorola temp. cont. crystal. *Tubes:* 6AK5 RF; 6BH6 RF; 6BJ6 1st mix (152-162 mc.) or 6AK5 1st mix (162-174 mc.); 6BJ6 osc & 1st quad; 6BJ6 IF; 6BJ6 IF; 6BH6 2nd mix; 6BJ6 2nd quad; 6BJ6 lim; 6BJ6 lim; 6AL5 disc; 6BH6 noise amp; 6AL5 noise rect; 12AU7 1st AF & sq; 6AQ5 output, 5.5 a.

Fixed: No. FSTRU-80BR(A), 152-174 Mc.
Transmitter & receiver same as No. FSTRU-80BY(A) except in cabinet mounting.

Fixed: No. FSTRU-80BR(B), 152-174 Mc.
Transmitter & receiver same as No. FSTRU-80BY(B) except cabinet mounting.

Fixed: No. FSTRU-140BY(A), 152-174 Mc.

Transmitter: 60 w. to 50-72 ohm line; AC input 445 w. *Tubes:* same as No. FSTRU-80BY(A) except 829B output; case mounting.

Receiver: same as No. FSTR-80BY(A) except high IF is 5.5 mc. and only one RF stage.

Fixed: No. FSTRU-140BY(B), 152-174 Mc.

Transmitter: 60 w. to 50-72 ohm line; AC input 445 w. *Tubes:* same as No. FSTRU-80BY(A) except 829B output; case mounting.

Receiver: same as No. FSTRU-80BY(B).

Fixed: No. FSTRU-140BR(A), 152-174 Mc.

Transmitter & receiver same as No. FSTRU-

140BY(A) except cabinet mounting.

Fixed: No. FSTRU-140BR(B), 152-174 Mc.

Transmitter & receiver same as No. FSTRU-140BY(B) except cabinet mounting.

Fixed: No. FSTRU-520BR(A), 152-174 Mc.

Transmitter: 250 w. to 50-72 ohm line; AC input 1300 w. *Tubes:* same as No. FSTRU-80BY(A) plus 2)4-125A output and 2)866A rect.

Receiver: same as No. FSTR-80BY(A) except high IF is 5.5 mc. and only one RF stage.

Fixed: No. FSTRU-520BR(B), 152-174 Mc.

Transmitter: 250 w. to 50-72 ohm line; AC input 1300 w. *Tubes:* same as No. FSTRU-80BY(A) plus 2)4-125A output and 2)866A rect.

Receiver: same as No. FSTRU-80BY(B).

Mobile: No. FHTRU-1A (Handi-Talkie Unit), 152-174 Mc.

Transmitter: .25 w. output; 0 w. stby.; 6 w. trans. *Tubes:* 5672 osc; 5672 mod; 2E36 doub; 5672 doub; 5672 doub; 1AD4 doub; 573AX doub; 573AX output. *Notes:* 3 miniature 67½ v. B bat; W.E. handset.

Receiver: single superhet.; 2.1 mc. IF; Motorola crystal C02; 1.5 w. *Tubes:* 1AD4 RF; 5678 mix; 5672 osc; 2E32 IF; 2E32 IF; 2E32 IF; 2E32 lim; 2E32 lim; 2E36 AF; 1AD4 mult; 2)IN34 crystals disc.

Mobile: No. FMTRU-40V(A), 152-174 Mc.

Transmitter: 7-10 w. to RG58U line; 6 v. input; 3.5 a. stby.; 16 a. trans. *Tubes:* 6AK5 osc; 2)6BE6 mod; 6AK5 quad; 6AK5 doub; 2E26 doub-driver; 2E26 output; OZ4A, 6X5, or CK-1024 rect. *Notes:* Shure military mike or W.E. handset; Mallory or Oak vibrator; 2-freq. operation available.

Receiver: same as No. FSTR-80BY(A) except high IF is 5.5 mc. and only one RF stage; 7.5 a.

Mobile: No. FMTRU-5V, 152-174 Mc.

Transmitter: 6-10 w. to RG58U line; 6 v. input, 3.5 a. stby.; 16 a. trans. *Tubes:* same as No. FMTRU-40V(A).

Receiver: same as No. FSTRU-80BY(B); 5.5 a.

Mobile: No. FMTRU-80D(A), 152-174 Mc.

Transmitter: 30 w. to RG58U line; 6 v. input; 7 a. stby.; 42 a. trans. *Tubes:* same as No. FSTRU-80BY(A). *Notes:* Shure military mike or W.E. handset; Carter dynamotor; 2 or 3-freq. operation available.

Receiver: same as No. FSTR-80BY(A) except high IF is 5.5 mc. and only one RF stage; 7.5 a.

Mobile: No. FMTRU-80D(B), 152-174 Mc.

Transmitter: 30 w. to RG58U line; 6 v. input; 7 a. stby.; 42 a. trans. *Tubes:* same as No. FSTRU-80BY(A).

Receiver: same as No. FSTRU-80BY(B); 5.5 a.

Mobile: No. FMTRU-140D(A), 152-162 Mc.

Transmitter: 60 w. to RG58U line; 6 v. input; 8 a. stby.; 74 a. trans. *Tubes:* same as No. FSTRU-80BY(A) except 829B output and no rect. *Notes:* same as No. FMTRU-80D(A).

Receiver: same as No. FSTR-80BY(A) except high IF is 5.5 mc. and only one RF stage; 7.5 a.

PHILCO CORP.
Philadelphia 34, Pa.

Fixed: 30-50 Mc.

Transmitter: 30 w. to 50-72 ohm line; AC input 300 w. *Tubes:* 6C4 osc; 9003 mod; 6BJ6 amp; 6BJ6 trip; 6BJ6 trip; 7C5 doub; 807 output; 2)6L7 AF comp; 7F7 volt amp; 7A6 cont; 7A4 amp; 2)5R4GY rect; 2)VR150

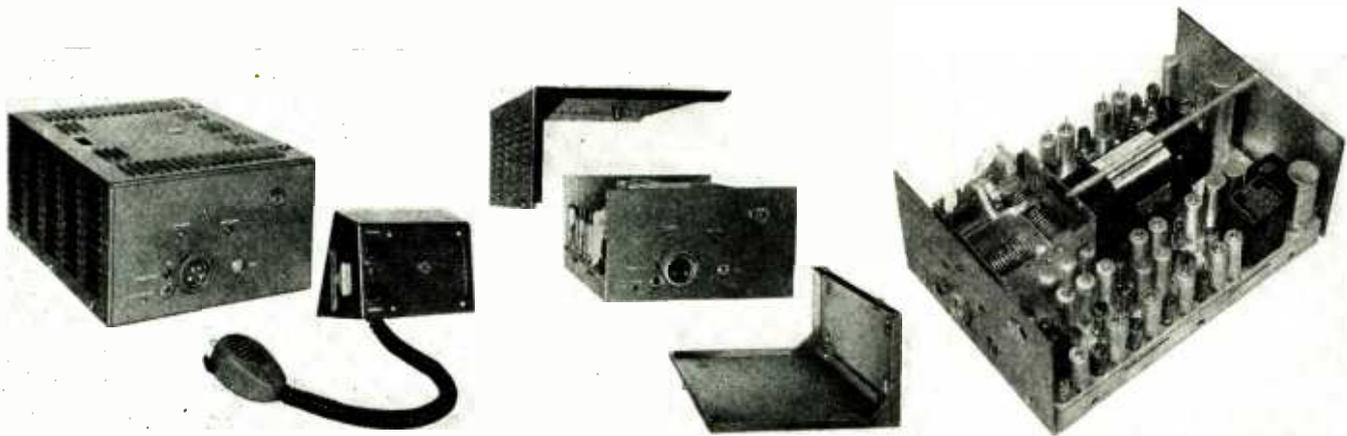

RCA mobile equipment is shown in the top row. Pictured is the Fleetfone, for use on 30 to 50 mc. Smaller but similar equipment is available for 152 to 162 mc.

Transmitter and receiver are combined in one case, as shown at the left. Unique sandwich construction permits insertion of the chassis into the lower half of the case from either right or left sides. Top cover is then attached and secured by

four quarter-turn locking screws. Variety in mounting possibilities is almost unlimited. At the right is shown a detailed view of the chassis, with the transmitter section at the top.

Features are Canyon-Curve selectivity and suppression of spurious emissions. COMMUNICATIONS CO. mobile equipment, center row, is also combined in one case. At left is a complete outfit for mobile installation. Model 275-C is

shown, having 10-w. output on 152 to 162 mc. Also available are 15-w., 152- to 162-mc., and 15- or 30-w., 25- to 50-mc. models.

Small size is a feature of Comco equipment. The center photograph shows an under-dash installation. The speaker has been removed from its case and mounted in the dashboard space provided for a clock. Long cables are eliminated, and an additional advantage is realized

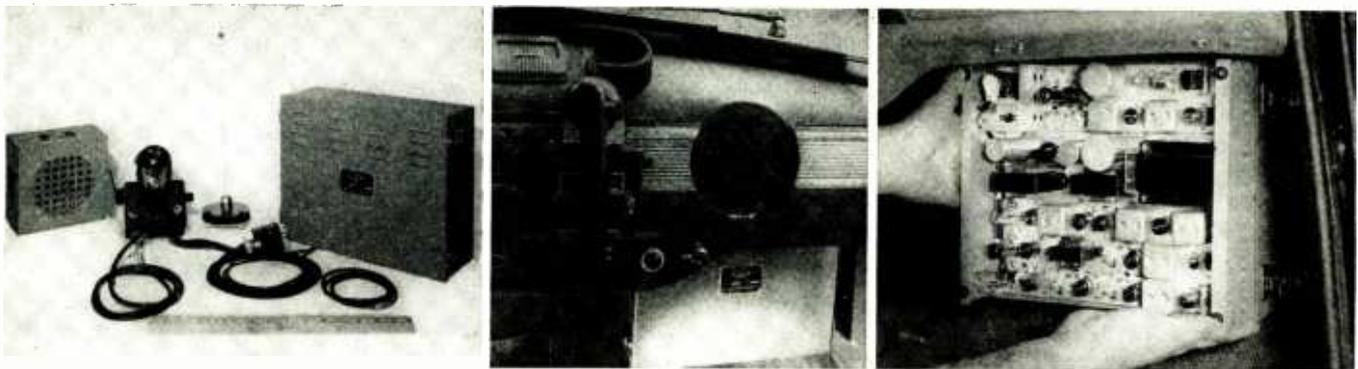

in that the equipment is protected from water much better than it would be in the luggage compartment.

Four latches hold the cover in place. The chassis can be taken out easily for servicing, as illustrated at the right.

IN THE bottom row, Link mobile equipment for the 152- to 162-mc. band is shown at the left. A 10-w. transmitter and receiver are combined in one case here also. Base station equipment is

identical except for accessories, although a console is available if desired.

Next on the right is Link's pack-set, a 1½-w., 30- to 44-mc. portable transmitter-receiver weighing 15½ lbs. complete. Applications include all public safety services, in addition to special emergency and low-power industrial uses.

Second from right is a Link-Vetric 2-way motorcycle installation. Equipment is available for 1.5 to 2.5 mc., 30

to 50 mc., and 152 to 162 mc. Outstanding features are low battery drain, ease of installation, and the fact that the equipment is completely contained within the width of crash bars.

At far right is a Doolittle 250-w. base-station transmitter for 152 to 162 mc. Advantage of high-power base-station transmitters is that mobile receivers need not be adjusted so critically or as often for dependable operation.



CHAPTER 5: SELECTIVE CALLING

IMPROVED METHODS OF SELECTIVE CALLING UTILIZE SIMPLE, STANDARD UNITS WHICH CAN BE INSTALLED IN ANY TYPE OF COMMUNICATIONS EQUIPMENT

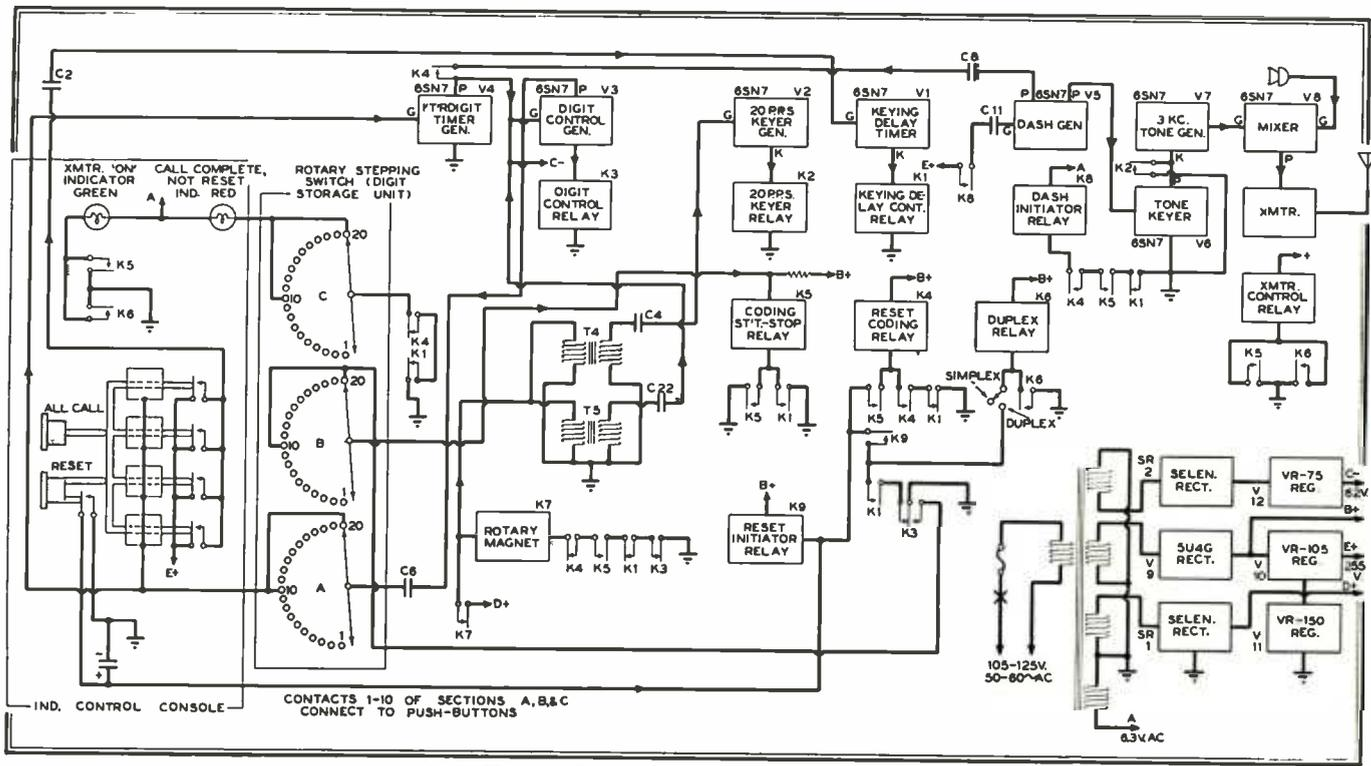

Fig. 1. A block diagram of the Hammarlund coding unit, used with the push-button type of selector

LONG before the self-starter was invented, the automobile had won a permanent place as a popular means of transportation. But today, the idea of cranking an engine by hand is unthinkable. We have a parallel case in mobile radio operation. This method of commu-

nication has gained a permanent place as a means of safeguarding life and property, and of reducing costs by saving time in many essential services. The many disadvantages resulting from lack of privacy are accepted, like the old automobile crank, only because nothing

has been done about them.

Actually, a great deal of progress has been made in the development and perfection of selective calling as a means of securing privacy for radio communications. In fact, the equipment has been proved out in actual operation at a num-

Fig. 2. The push-button selector and coding unit make up the complete selective calling equipment. Telephone indicates size



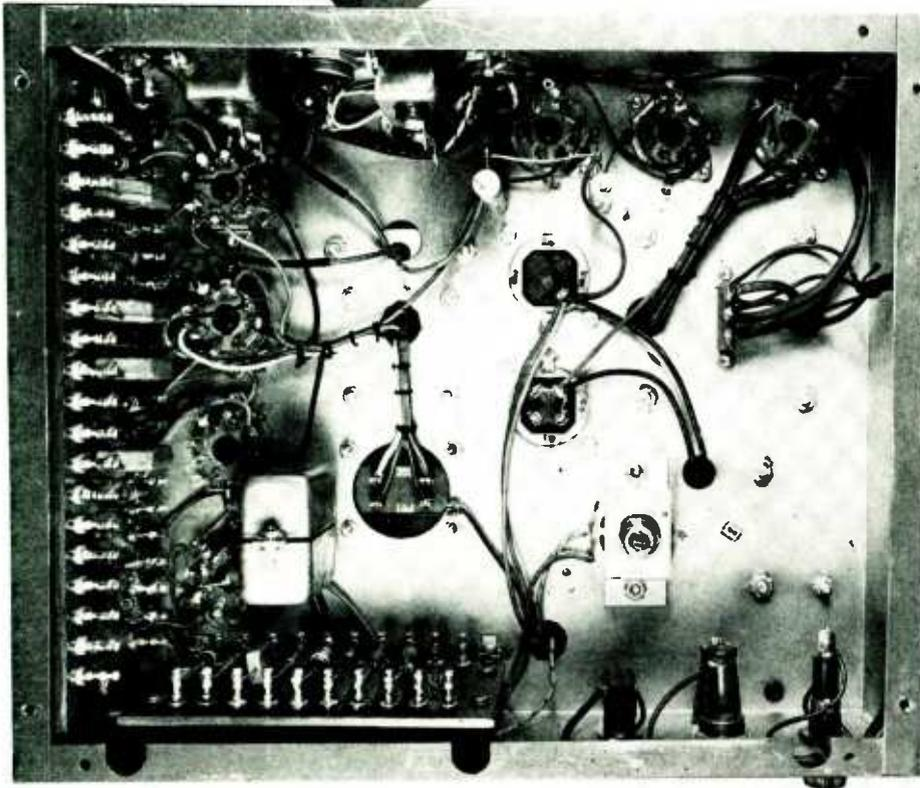

Fig. 3. Rear and bottom views of dial instrument with self-contained coder

ber of radio systems. But it is only now that standard central station coders and mobile decoding units, adaptable to all existing headquarters and mobile radio installations, have become available.

And the use of selective calling has already proved so successful that, in the not very distant future, we shall think back and wonder how mobile radio reached even its present state of development without benefit of this extremely important refinement and convenience.

Advantages of Selective Calling:

Radio telephone communication is such an essential service to those who use it that perhaps you have never stopped to think of its shortcomings, or the improvements that can be achieved by selective calling. Some of the advantages are more important in certain mobile services than in others, but every type of service can be improved by the use of selective calling. Therefore, rather than

list the features, let us review the operation of a mobile system that employs the Hammarlund Push-Button selective calling method of operation.

1. **CAR STANDBY CONDITION:** In the normal standby condition, all loudspeakers are completely silenced. This eliminates the continuous background noise that drivers find so objectionable, as well as the distraction of hearing messages from other radio systems which sometimes come in over great distances, as well as messages from the driver's own transmitter which are intended for other cars. Thus, as is the case with a private land-line telephone, the only calls which come in over any mobile radio receiver are those intended to be heard over it.

2. **CALLING FROM HEADQUARTERS:** When the headquarters operator wants to call car 50, for example, he does not have to call and wait for an acknowledgment before proceeding with his message, as is done in many cases. He simply pushes button 50 on his control coder. By the time he has released the button, he knows that the driver in the car called has seen the green signal light on his control box, and is ready to listen. Also, he knows 1) that he can talk to the driver of car 50 without being overheard by any other driver in the fleet, and 2) he knows that no other car can call in until he has finished talking to No. 50. This interference lock-out will be explained later, in detail.

3. **RECEPTION AT CAR CALLED:** When the headquarters operator calls car 50, a green call light is turned on at the dashboard control unit. If required, the control unit can be supplied with a buzzer, also, or a bell can be furnished which rings when the call light goes on. The bell is for service trucks, in case the driver may be working at some distance from the vehicle.

As the driver picks up the microphone or handset, the call light and buzzer or bell are cut off, and he is ready to receive the message. He uses his press-to-talk microphone switch in the usual manner. The selective calling system does not alter the conventional procedure in any way.

4. **CONDITION AT OTHER CARS:** Of course, all cars in the fleet receive the selective calling impulses. When No. 50 is called, to continue our example, the decoding unit in each of the other cars 1) turns on a busy-signal light, and 2) opens the press-to-talk microphone switch circuit, disabling the transmitter. Thus, even though a driver disregards the busy signal and tries to call headquarters, his transmitter cannot operate as long as the light is on.

5. **HEADQUARTERS RESET:** At the end of his conversation with No. 50, the headquarters operator presses a reset

button. This transmits a signal to clear the interference lock-out in all cars, switching off the busy-signal light in each one, and restoring the microphone-switch circuit to its normal condition.

6. IF CAR CALLED DOES NOT ANSWER: There may be occasions where a car is called but the driver does not answer, as in the case of a delivery or repair truck. If the headquarters operator does not get a prompt response, he presses the reset button. This restores the entire system to normal operation, but the green call light remains on at the car that was called. When the driver returns and sees the light, he knows the operator wants him. The light will go out as soon as he picks up his microphone.

7. SPEED OF CALLING: Using numbered push-buttons corresponding to the number of cars in a fleet, the time required to signal any car is less than 1 second. This high-speed operation is extremely important in taxi systems, for example, where expert operators can handle 20 complete calls per minute. A slower method of calling, even though it took only an extra second to signal the car wanted, would reduce the number of calls per minute by 25 per cent. Such a reduction could not be tolerated, and would offset all the advantages gained by selective calling.

However, a less expensive but slower dial calling unit is available for use where split-second speed is not required.

The H-P-B System:

There are various types of operating signals and mechanisms that can be used for selective calling. The problem of determining the most advantageous method was the subject of a research program initiated by Hammarlund in 1945. This resulted in the decision to use a single audio frequency to actuate the mobile units, and the highly-perfected Clare telephone-type stepping relay to accomplish the actual selection.

The soundness of these basic elements has been demonstrated beyond any question by use in telephone circuits, the most severe operating test to which they could be put. Telephone practice, however, calls for a continuous tone, interrupted to actuate the relay. Radio requires the transmission of audio-frequency pulses. Experience shows that the stepping relay can be operated dependably even though the signal-to-noise ratio is so low that intelligible conversation is impossible. No greater degree of dependability is necessary for any selective calling system.

The use of a single audio frequency and stepping-relay selection makes possible an essential and unique feature, namely, the interference lock-out. This, as previously explained, not only turns on a busy light at every car except the one

called, but locks out all the other transmitters, so that calls cannot be interrupted.

The number of cars which can be called selectively with a single audio frequency works out in this way:

3 digits will call 37 cars

4 digits will call 84 cars

5 digits will call 126 cars.

If the number required is still greater, additional audio signalling frequencies can be employed, repeating the same

code numbers. A 3,000-cycle tone is used ordinarily. When several frequencies are required, a spacing as low as 50 cycles can be used. Thus the number of selective calls that can be made is virtually unlimited.

Central Station Control:

Two types of central station controls are shown in the accompanying illustration.

The model SCPB-3080 push-button central station control transmits a com-

Fig. 4. Rear and bottom views of the coder used with the push-button selector

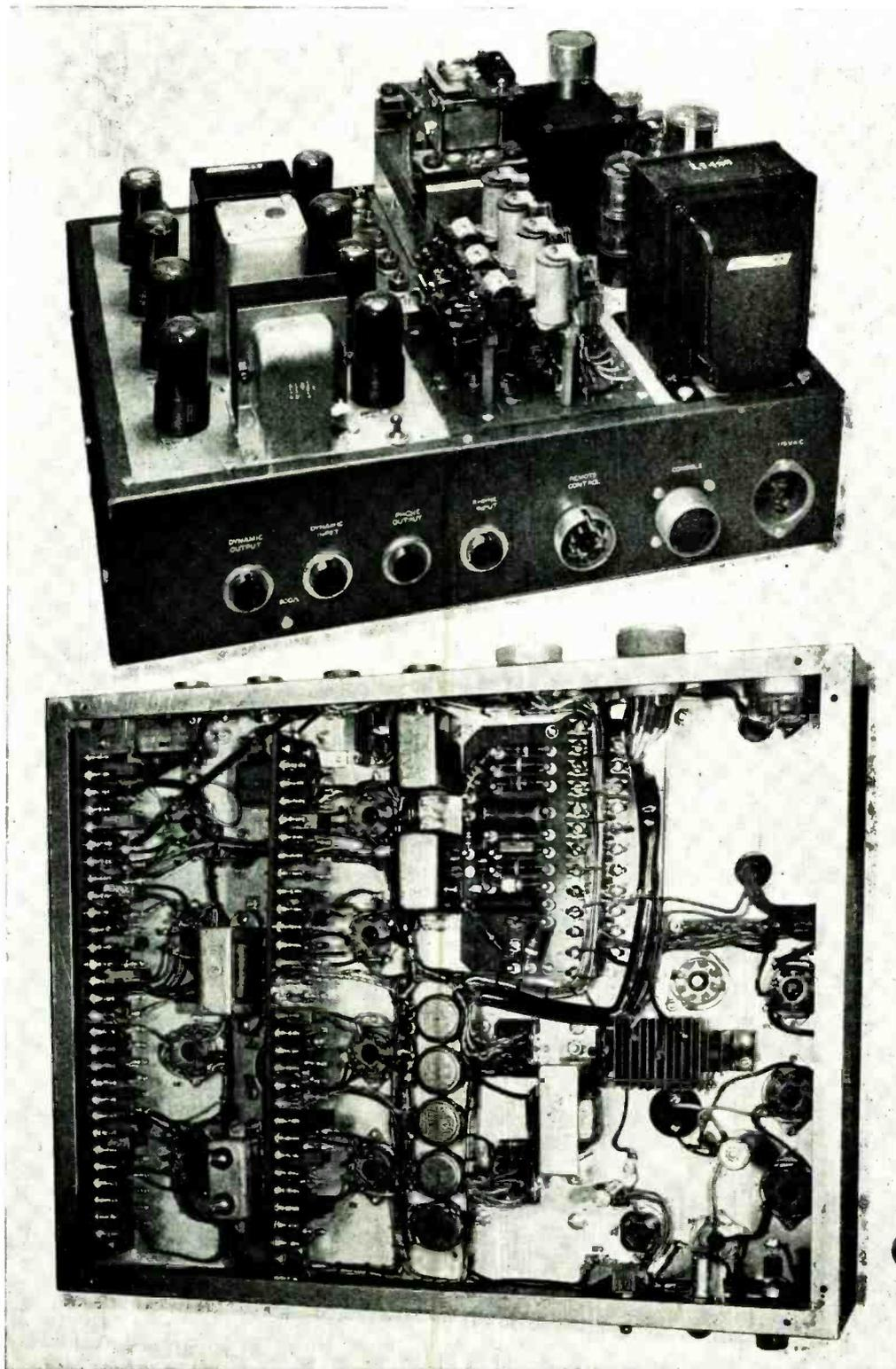



Fig. 5. Below: A completed dial Selector. Above: The 20- and 80-button units

plete code number automatically in less than one second. Figs. 2 and 6 show the 40-button type, while the 20- and 80-button types are illustrated in Fig. 5.

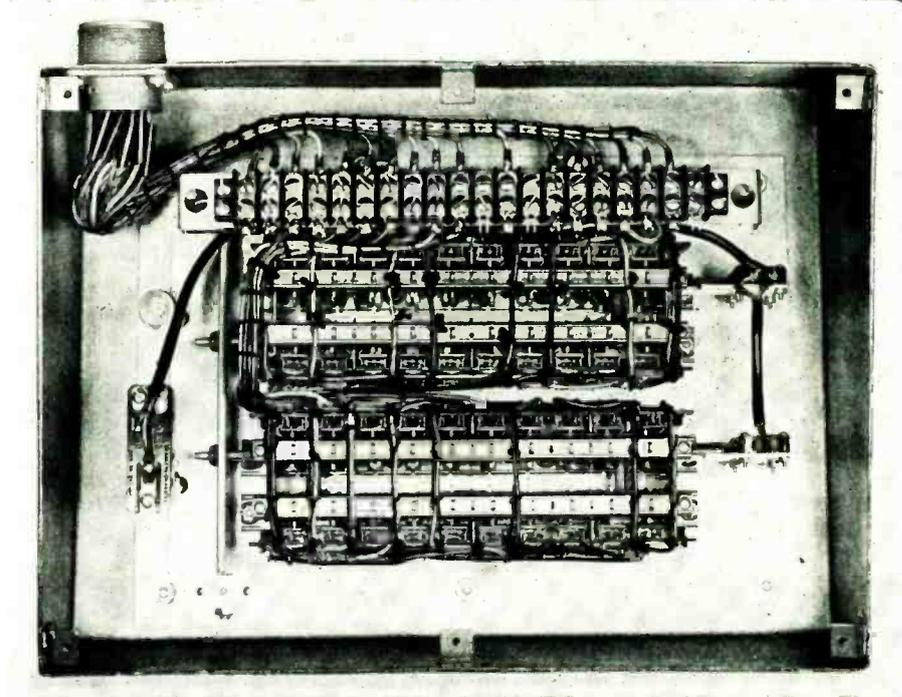

Fig. 6. A view underneath the chassis of the 40-button selector unit

Coding is accomplished by a separate unit, Fig. 4. When a button is pressed, the transmitter is turned on automatically, the code signals sent out, and the transmitter is switched off again. At the end of the message, the operator presses the reset button. Taxi installations and others requiring extremely fast operation use a 2-position foot-operated switch to replace the hand-actuated push-to-talk and reset buttons.

The less expensive unit is the dial-type model SCF-30-C. Fig. 5 shows the front of the instrument, with the rear and bottom views in Fig. 3. It is used in installations where speed of selection is not a prime factor, as $3\frac{1}{2}$ seconds are required to dial 4 digits. The press-to-talk switch is pressed while the number is being dialed. Then the conversation is carried out in the usual way, and the reset button pressed at the conclusion.

For those who are interested in the circuit functions of the automatic coder, a block diagram is given in Fig. 1.

Headquarters Installation:

The addition of either the dial or push-button type of selective calling unit at a headquarters station does not require any modification of existing equipment. The coding unit is plugged into the transmitter in place of the microphone or, where the transmitter is at a remote location, the coder is bridged across a 600-ohm line. Power for the coder is required from an AC line of 105 to 125 volts.

Connectors are provided in both the dial and push-button coders for using a high-impedance crystal or dynamic microphone, or a standard carbon type of 50 to 100 ohms.

Thus the work of setting up the selective calling equipment is merely a matter of making a few plug-in connections. Then the system can be used as soon as the first mobile installations are made, and without waiting until all the cars are equipped with decoders.

DESCRIBING THE MOBILE DECODER UNIT, AND THE SEQUENCE OF OPERATIONS BY WHICH THE FUNCTIONS ARE ACCOMPLISHED

DECODER units to operate with the Hammarlund selective system are designed for DC operation in vehicles, or AC operation at fixed points. They can be connected readily with any type or make of radio telephone equipment.

The decoder is a simple and rugged device, employing a mechanism that can withstand all the rigors of mobile service. Even the matter of setting up the code number to which a given unit will respond has been reduced to merely in-

serting a plug, the pins of which are connected together to establish a given number. This can be changed simply by inserting a different plug.

General Description of Decoder:

Fig. 7 shows the decoder with the cover removed, and the mechanism inside. The dashboard control and signaling unit are illustrated in Fig. 8. This has a buzzer mounted on the under side. On repair trucks, where the driver may be out of

the cab at times, an alarm bell or flashing light may be added.

Some systems require the use of a selective-calling on-off switch on the control unit, so that the transmitter can be monitored when necessary. That is the purpose of the toggle switch shown in Fig. 8. Also, an emergency break-in switch can be provided, so that headquarters can be called even though the channel is busy.

Additional views of the decoder are

presented in Figs. 9 and 10. The latter shows the top and bottom of the chassis. It is mounted permanently. Then, by means of four Dzus fasteners, the decoder base is secured to the chassis. Connections from the decoder are made to the connectors on the chassis through a 12-pin Jones plug. Fig. 10 shows the male part on the former, and the female part on the latter. Thus, a unit can be replaced without touching the wires to the other parts of the installation.

The code plug can be seen in the left view, Fig. 9, on the left hand corner of the base plate. As will be explained, there are no external connections to the code plug.

Installation of Decoder:

For mobile service, the decoder requires the following connections:

1. Hot side of the storage battery, 5.2 to 8 volts. This operating range exceeds the RMA specifications of 5.5 to 7.5 volts. Standby drain is .45 amperes, and 4 amperes during the selecting operation.

2. Ground connection.

3. B+ 150 to 210 volts. The standby drain is .0053 ampere, and peak selecting drain .01 ampere.

4. Audio connection from the discriminator output of the receiver. At that point, the decoder is not affected by manual adjustment of the volume control, and there is little attenuation of the 3,000-cycle code tone in the de-emphasis network.

5. The audio mute connection to the receiver requires the insertion of a .2-megohm resistor to furnish approximately 75 volts bias on the audio output tube to a point below cutoff under standby

conditions. This results in a reduction of 1 ampere in the receiver battery drain, and a net saving of .5 ampere in mobile installations where the decoder is used.

When the decoder is used for fixed service, the AC-operated power supply, Fig. 11, is required. It furnishes 6 volts and 210 volts DC for the two tubes in the decoder, 6 volts filtered bias, and 6

teresting, and well worth the time spent in studying the circuit, Fig. 12. Input and other external connections to the decoder are made through plug P2, as indicated in the list of connections.

Signals of 1 volt or more are required from the receiver. They are fed to a high Q, 3-kc. bandpass filter in the decoder unit. If adjacent tone channels are separated by 75 cycles, the crossover attenuation will be more than 20 db in this filter. Also, the bandpass filter and succeeding limiter-amplifier are designed to exclude sub-multiples of higher frequencies. That is done to prevent stray impulses from actuating the decoder accidentally.

From the limiter-amplifier, signals are fed to a multiple bandpass filter network and on to a pulse detector and amplifier which is biased beyond plate-current cutoff. Using an R-C network, any sharp pulses at 3 kc. are suppressed. That is, if they are below 5 volts or roughly 6 db below normal tone-signal level at this point, they will not operate the pulse detector amplifier.

Electro-mechanical selection is started when pulse digit trains set up at the transmitter are finally fed from the output of the detector amplifier to pulsing relay K1. Each time K1 is actuated, the Clare stepping switch is advanced one position by action of the rotary step magnet. When the stepping switch is advanced to the first position, the transmitter lockout and busy-signal relay K6 is sealed in. The busy light comes on at the dashboard control unit, and a pair of contacts on K6 opens the transmitter control circuit.

At the end of each train of digit pulses,



Fig. 8. This dashboard unit carries the decoder controls and the call buzzer

volts for signal lights and buzzer, call bell, or auxiliary indicator.

To facilitate installation, each coder is supplied with cables cut to the required lengths. Thus, the work can be done very quickly.

Operation of the Decoder:

The operating sequence of the relays and stepping switch in the decoder is very in-

Fig. 7. Left: the complete decoder with the outer cover removed. Right: decoder chassis, showing the arrangement of the relays

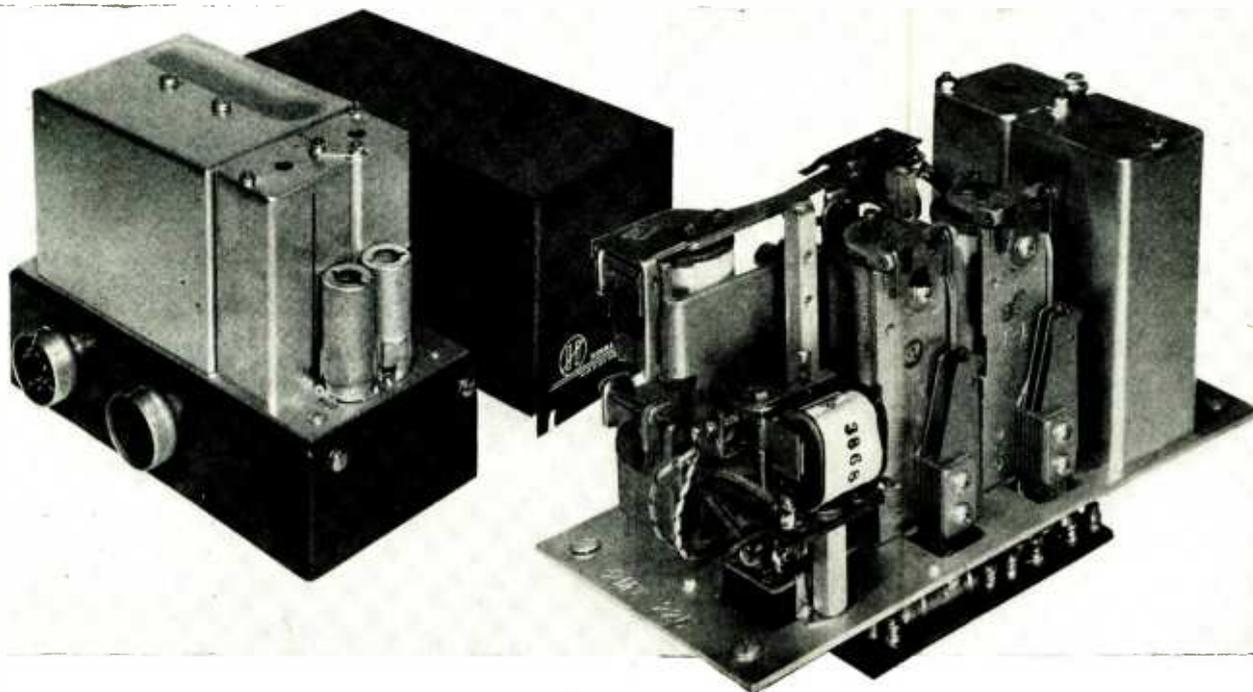

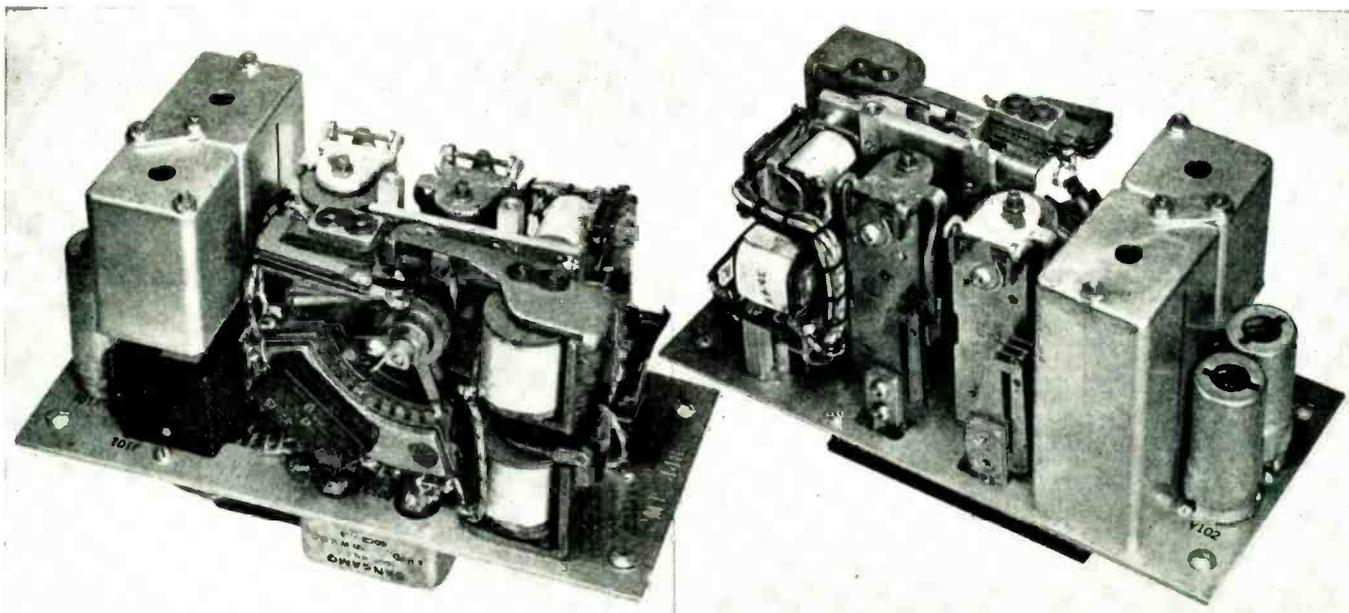

Fig. 9. Additional detailed views of the decoder chassis. The code plug can be seen in the left view, under the small filter case

the rotary arms of the stepping switch come to a point of rest. If this particular point is a point of rejection, as determined by the code connections in the code jack J1, the B coil of pulsing relay K2 will operate the release magnet of the stepping switch, allowing the wiper arms to return to the normal starting position, as shown at the left in Fig. 9.

A rejection point is one at which the number of pulses of a particular digit is not related to the code number of a particular decoder. As Fig. 12 shows, the rejection points are tied together by means of connections in the code jack,

J1, in the circuit between the stepping switch contacts of S1A and the B coil of pulsing relay K2.

Relay K2 is slow-acting, and will not operate when S1A passes a rejection point during the transmission of a digit-pulse train, since it must be energized for at least 100 milliseconds before pulling in. However, it will operate if S1A comes to rest on a rejection point at the end of a digit-pulse train.

A holding point on S1A is one at which the number of pulses of a particular digit is related to the code number of a particular decoder. When a digit-pulse train

leaves S1A at a point not interconnected to relay K2 through the code jack, *ie.*, at a holding point, the rotary arm of the stepping switch will remain at the last advanced position, in readiness for the next digit-pulse train.

Since the digits in each code number used in this system always add up to 10, an unbroken chain of holding points at the corresponding decoder will bring that particular stepping switch to the 10th and final position.

At the 10th point, the lockout relay K6 is unsealed, the busy signal light is switched off, and the break in the trans-

Fig. 10. Left: Top side of base, showing the connector for the chassis. Center: bottom of the chassis. Right: under side of base

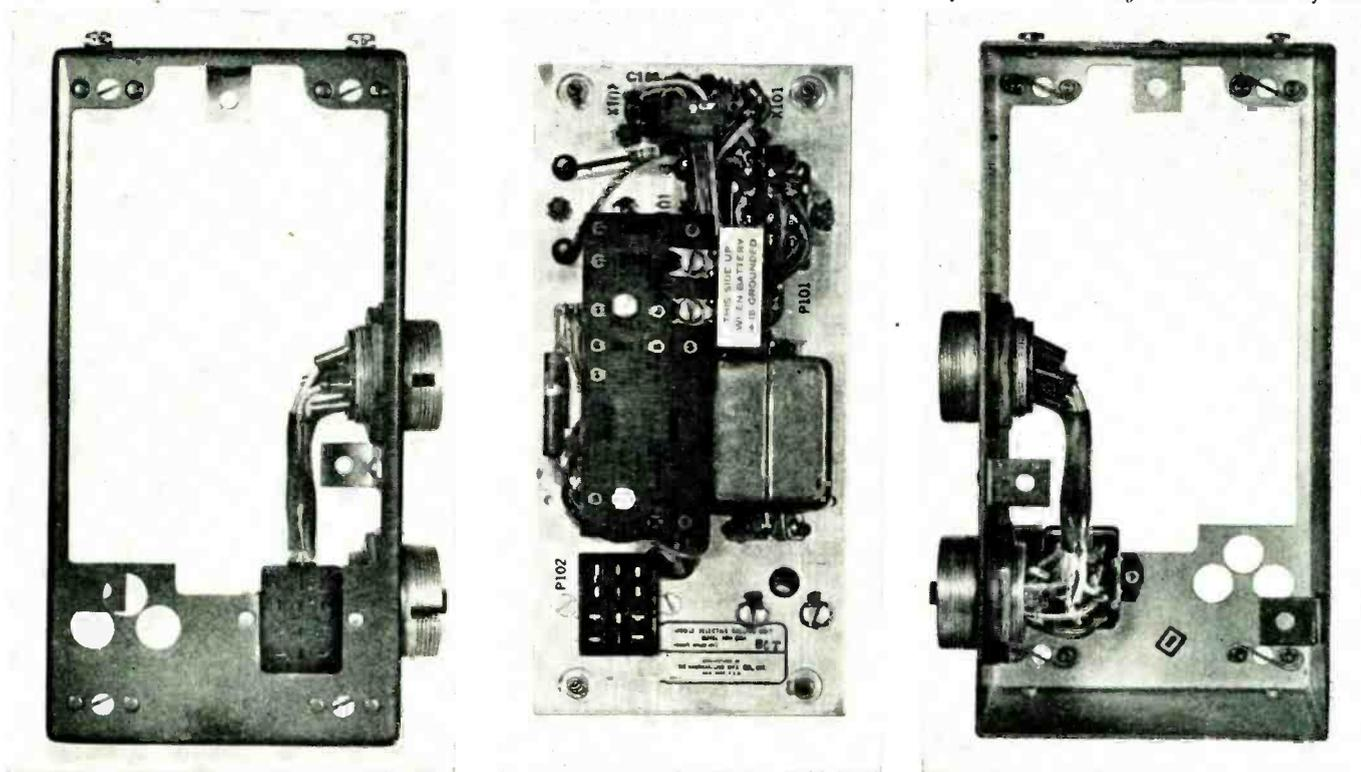

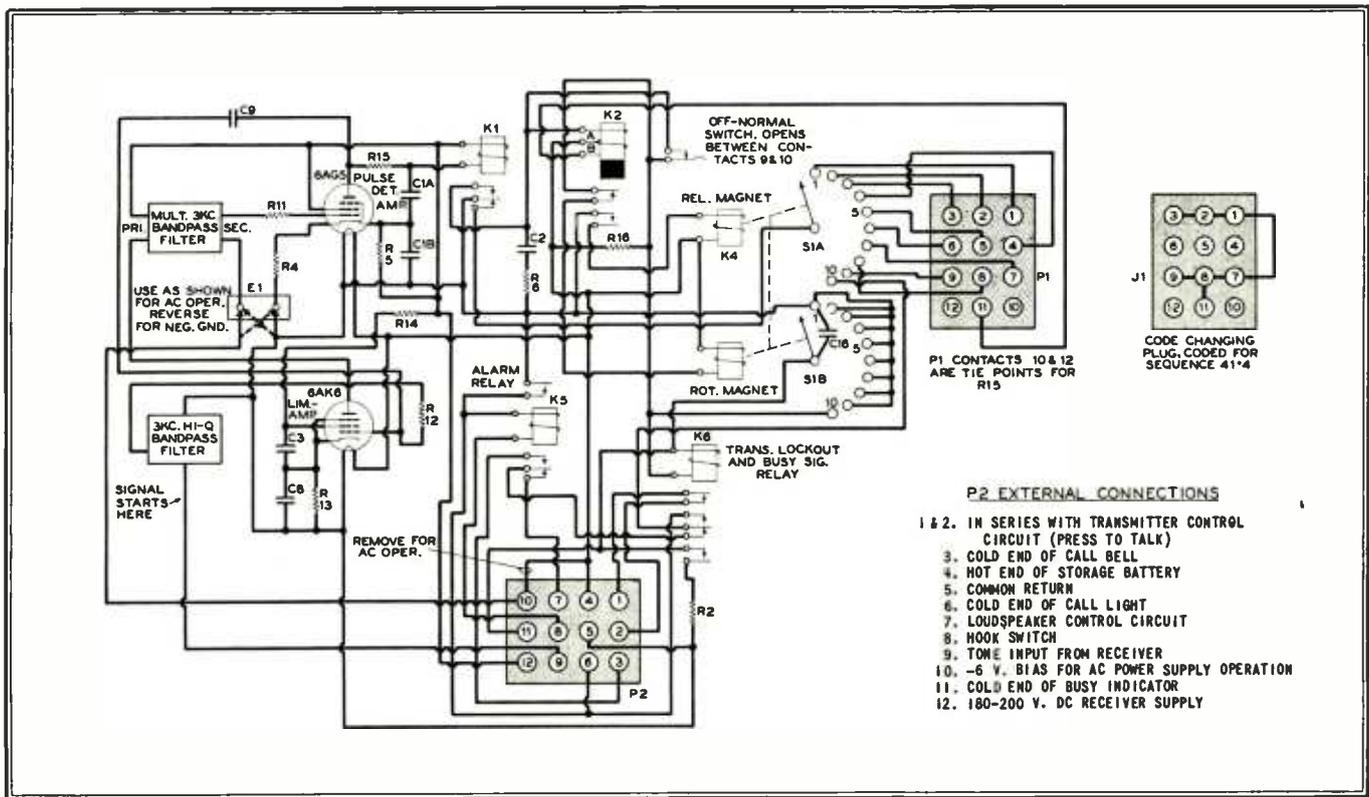

Fig. 12. Complete wiring diagram of the decoder. The code plug, at the extreme right, has pins connected for the code 4114

mitter control circuit is closed. In addition, alarm relay K5 is energized, and assumes a locked position through power applied from the normally-closed contact on K1, contact 10 on the S1A bank, and the momentary-make contact on K6. This cuts in the call light and buzzer or bell.

Removing the handset from the hook-switch in the car, or pushing the alarm release button on the control box opens the alarm circuit. Relay K5 drops out and cuts off the call light and buzzer or bell. Then K5 closes the circuit of the audio power amplifier on the receiver from pin 7 on plug P2, through a normally-closed contact on K6 to position 10 on bank S1A, and through the normally closed contact on K1 to ground.

At that point, all other mobile units show the busy signal light, and are locked out.

As soon as the conversation has been completed between headquarters and the car called, the headquarters operator presses the reset button on the coder. This transmits a signal of .25 second duration, which energizes coil A of the slow-operating decoder relay K2 in every mobile unit. Then release magnet K4 of the stepping switch permits the wipers of both banks to return to their normal starting position. Also, a short is applied across the coil of lockout relay K6 by the energized contact on relay K1, releasing transmitter lockout relay K6, and extinguishing the busy light. This completes the operating cycle.

Special Systems:

Variations of this system can be worked out to suit special situations. However, a careful study of the requirements to be met usually shows that no changes are necessary beyond the choice between the very fast pushbutton coder and the conventional dial-operated coder.

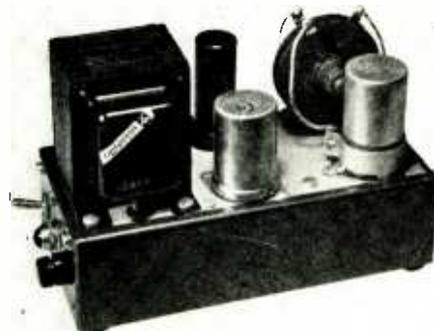

Fig. 11. AC unit for fixed-station decoder

FLEET CONTROL METHODS

A second method of controlling reception is fleet-control, whereby all speakers are muted except when the car receivers pick up a particular audio frequency note. Then the speakers in every car in the fleet are turned on for the duration of the message.

The use of fleet-control units can be applied to the actuation of point-to-point and relay systems, also, and to talk-back operation so that the operator at a head-

quarters station hears only his own cars. It can even be expanded to use with groups of cars, as in the case of a police system serving two or more adjacent towns.

Basic Method of Operation:

The fleet-control system employs very simple units which can be connected readily to radio telephone transmitters and receivers of any type. Simply stated, the transmitter unit develops an audio-frequency tone which is transmitted for 200 milliseconds each time the press-to-talk button on the microphone is actuated. Thus, the short tone-signal automatically precedes each message.

At each associated receiver, the loudspeaker is muted. However, if the receiver picks up a tone signal from an associated transmitter, the receiver control unit turns on the speaker and holds it for the duration of the message.

The idea of using such a control is so simple as to be obvious. The development of the units into commercial designs involved the perfection of circuits that would assure positive lock-and-key functions, operating dependably upon transmission of the actuating signal, and rejecting all impulses and random noise picked up by the receiver. Such equipment has been produced, put through exhaustive field tests, and is now in commercial use for several different types of communication systems. Typical examples of these are described on the following page.

Shared-Channel Operation:

In order to attain maximum use of the frequencies available for communications, the FCC has found it necessary to assign one channel to two or more users in many areas. This is particularly true of the taxi service. Each driver, then, hears every call, and must listen carefully to distinguish between the calls from his own transmitter, and all the calls made by the other transmitters. Such a situation is illustrated in Fig. 13.

Resulting confusion is tiresome, annoying, and distracting. It often causes drivers to miss their own calls. During busy hours, efficiency drops sharply, since the calls are speeded up to 15 to 20 per minute!

Other services, on lower frequencies, may not have as much traffic, but they may have serious skip-reception trouble from the distant stations on the same frequency.

By the use of fleet control units, reception at any receiver of signals other than from the associated transmitter can be eliminated. Fig. 13 shows the operating plan for three independent systems using the same frequency in one area. This is not an uncommon situation.

Each transmitter has an FTC-1 control unit, set respectively at 2,900, 2,950, and 3,000 cycles. All Company A's cars have FRC-1 receiver controls, set at 3,000 cycles. Controls in Company B's cars operate at 2,950 cycles, and Company C's, at 2,900 cycles.

When the operator at transmitter A has a call to put out, he presses the push-to-talk button in the usual manner, but even before he can start to speak, the control unit automatically sends out a 3,000-cycle tone for just 200 milliseconds.

Normally, all the speakers in the cars operated by the three companies are muted. When transmitter A goes on the air, however, the speakers in all Company A cars are turned on by the receiver control units. The message is not heard by Company B and C cars. The same degree of privacy is afforded to messages from the B and C transmitter to their cars.

Similar protection for headquarters receivers can be obtained by adding FRC-2 units to the receivers, and FTC-1 control units to the mobile transmitters. Then the dispatcher will hear only his own cars. When this is done, a different audio frequency is used for the mobile control units in each system. Otherwise, transmission from one car would turn on the speakers in all cars operated by the same company.

Multiple Service Operation:

A variation of the method just described is ideally suited to use at a single trans-

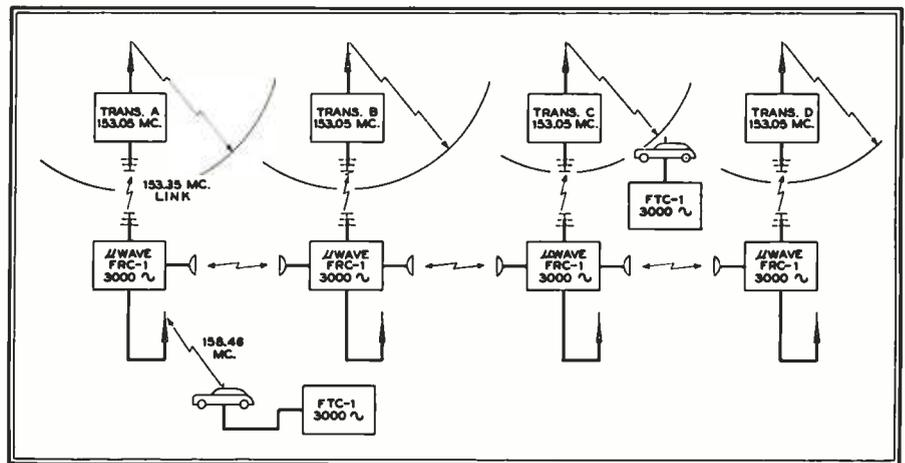

Fig. 14. Relay system is actuated only by 3,000-cycle pulse from car transmitter

mitter which serves two or more groups of cars. For example, several small fleets of taxicabs might join in the use of one main station. Or, as is the case in many areas now, one transmitter may serve the police and fire departments, the county sheriff's office, and the city hospital. In other localities, several adjacent towns may join in the use of one headquarters station. This practice is encouraged by the FCC, and is provided for in the Rules, in order to attain maximum channel utilization.

The drawback to such a plan is that messages intended for one group of cars are heard by all the other cars. Taxi fleet owners object to this, naturally. Many police departments operate individual transmitters not because their traffic warrants it, but because the chiefs

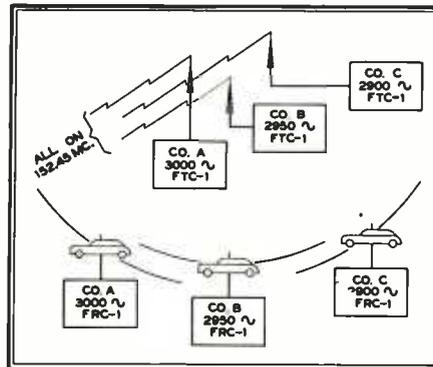

Fig. 13. Three systems on same frequency

do not want their messages to be picked up by other cars.

These objections can be overcome by a modification of the setup illustrated in Fig. 13. By using three FTC-1 control units, set to different audio frequencies, at one transmitter, the dispatcher can turn on the speakers of any particular group of cars.

For example, cars in group A would have receiver control units adjusted to 3,000 cycles, in group B cars, 2,950 cycles, and in group C, 2,900 cycles. Additional frequencies can be used for a larger number of groups.

The actual method of dispatching is very simple. The operator has a control box with as many buttons as there are groups of cars. If he wants to call the cars in group C, he presses button C, and transmits his message in the usual manner. Button C remains depressed, keeping control unit C connected to the transmitter and ready for use. Later, if he wants to reach group A cars, he presses button A, which automatically releases button C.

Relay System Operation:

Quite a different way of using the same control units is shown in Fig. 14. This is a relay system for operation with vehicles traveling on a highway, or service cars patrolling an oil or gas pipe line. It is designed to receive messages from any car, pass them along the microwave relay in both directions, and to transmit them to all other cars in the system, no matter how far away.

Each mobile unit operating, for example, on 158.46-mc. has a transmitter control unit set at 3,000 cycles. There is a 158.46-mc. receiver, with a control unit adjusted to 3,000 cycles, at each relay point. Also, each relay has a VHF link to a 153.05-mc. transmitter so located as to cover one section of the area traveled by the cars.

When any mobile transmitter goes on the air, the initial 3,000-cycle pulse is picked up by the receiver at the nearest relay. This switches on the relay transmitters in both directions, and they, in turn, switch on the succeeding relays over the length of the system.

The link transmitters turn on the repeater transmitters, so that the message from the initiating car is heard at every other car. As soon as the message is completed, and the carrier of the car transmitter goes off the air, the entire system is released.

Noise or transmissions from any other system have no effect, however, for the relays can be put in operation only by the initial 3,000-cycle tone.

CHAPTER 6: THE ADJACENT CHANNEL

HOW THE PROBLEMS OF MOBILE RADIO OPERATION ON ADJACENT CHANNELS ARE FINALLY BEING SOLVED BY NEWLY-DEVELOPED EQUIPMENT AND METHODS

TO the far-sighted individuals interested in the future of mobile radio communications, today's need for space in the radio spectrum, coupled with the inevitable future demands, add up to one obvious fact. Methods for increasing channel utilization, both technical and administrative, must be developed and put to use immediately. Propagation limitations known to the art, along with the myriad demands of all the other radio services, practically eliminate the possibility of assigning more spectrum space to the mobile services. It is imperative,

therefore, that every last kilocycle now allocated be dedicated to useful service.

Channel congestion is an affliction most prevalent in the metropolitan areas. Here, particularly, is demonstrated the need for decreasing the waste of spectrum space. Here it is most imperative that guardbands be cut to the irreducible minimum, and adjacent-channel operations initiated.

The problem of adjacent-channel operations within a given area is not a simple one to solve. However, in light of recent developments, now proved by ac-

tual field tests, there is reason to believe that an entire new approach to channel-utilization can be evolved.

Any long-term scheme to improve spectrum conservation must, obviously, be directly related to equipment design. The time span involved in the transition from an extravagant era of alternate channel operations to the desired period of 100% adjacent-channel operations will necessarily be lengthened in part by technological obstacles, but to a greater extent by the economic considerations involved in clearing out existing, soon-to-be-obsolete equipment.

Representative of new equipment designed to meet the tightened FCC requirements which go into effect July 1, 1950 is the Motorola receiver-transmitter unit for 152 to 174 mc. shown in Fig. 1. The transmitter is furnished with either a 30-watt or 60-watt RF output deck. Individual component assemblies and the basic chassis of the receiver and transmitter are illustrated in Fig. 2.

Problems of Receiver Design:

It is quite universally agreed that the overall receiver selectivity characteristic is one of the major factors in effecting adjacent-channel operations. According to the current minimum-performance standards established by the Radio Manufacturers Association, the desired degree of selectivity for successful adjacent-channel reception on 152 to 174 mc. is at least 85 db down at ± 60 kc., which extends to the centers of the adjacent channels, as indicated in Fig. 3. The results of recent field tests have determined conclusively that a level of -85 db to -100 db at ± 30 kc., the edges of the adjacent channels, is highly desirable.

Were it possible to achieve this degree of frequency discrimination in the radio frequency stages of the receiver, selectivity would, indeed, become the dominant element in equipment design. Instead, it is only one of many factors. Even in this day and age of advanced equipment design, RF selectivity of the desired magnitude is unattainable, as indicated in Fig. 4. Conventional permeability-tuned RF preselection stages contribute only a few negligible decibels attenuation to adjacent- and alternate-channel frequencies. Even the bulky, temperature-stabilized cavities designed for base-station installation contribute no more than 20 or 30 db at frequency departures ± 200 kc. from the desired frequency.

Fig. 2. Chassis assemblies and circuit elements, including 30- and 60-watt output units

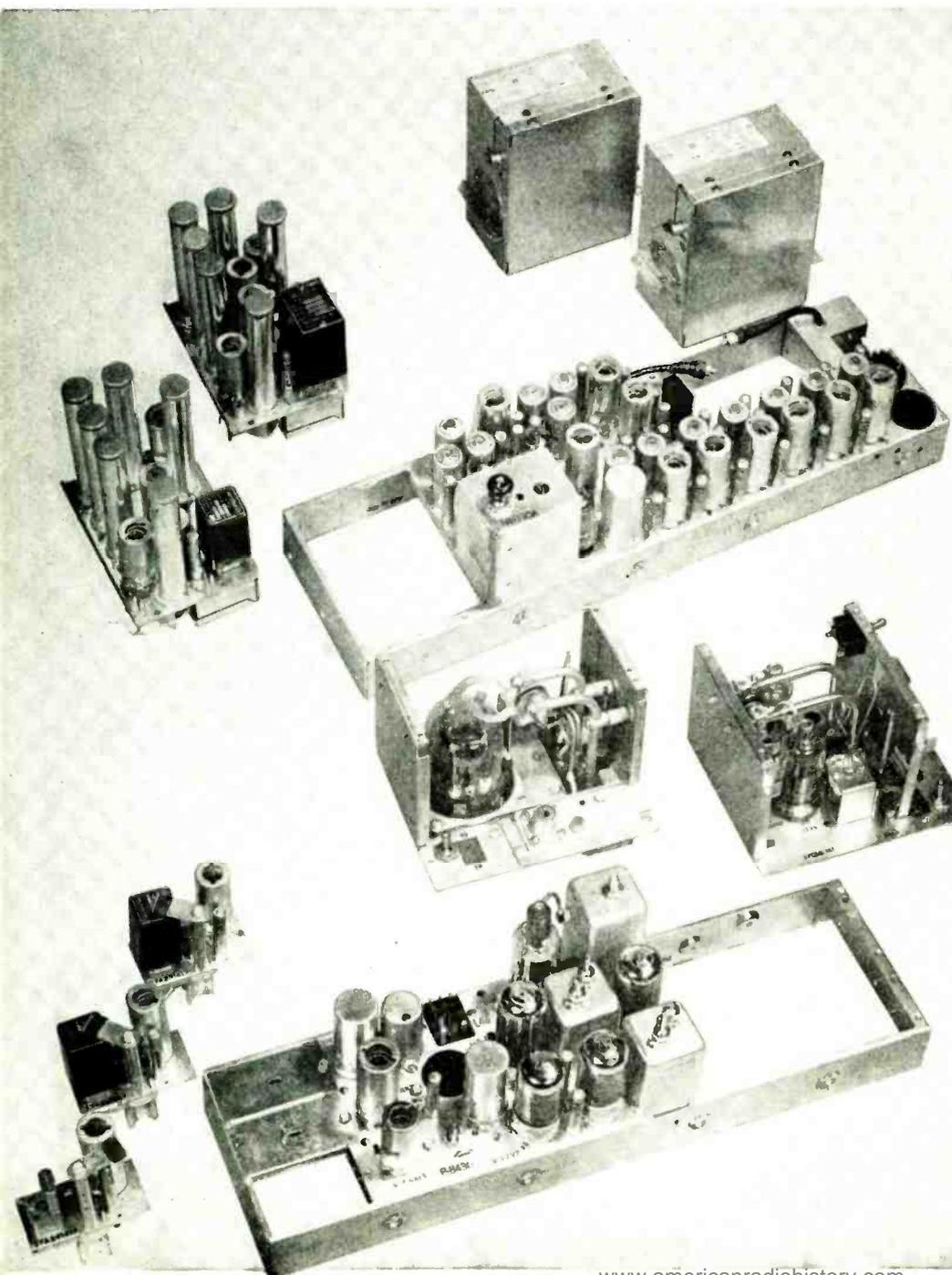

Since immediate perfection of specialized parameters capable of providing the desired degree of selectivity at RF levels is beyond the state of the art, appropriate systems design must be adopted which employ certain other advanced techniques of adjacent-channel utilization now known to research specialists. The methods employed in perfecting the equipment to be discussed here involved long-range development not merely of the selectivity-determining components, but of the overall system design.

The new units, Figs. 1 and 2, coupled with a plan for controlled geographical assignment of channels will, undoubtedly, result in well-defined boundaries to the problem of close channel-occupancy.

Each of the operational obstacles was considered as a separate, major problem. Emphasis was given to the fact that a completely satisfactory solution is impossible unless all disturbing elements are controlled. For example, the simple expedient of providing an extraordinary degree of selectivity in the receiver is not the complete answer, since the pre-

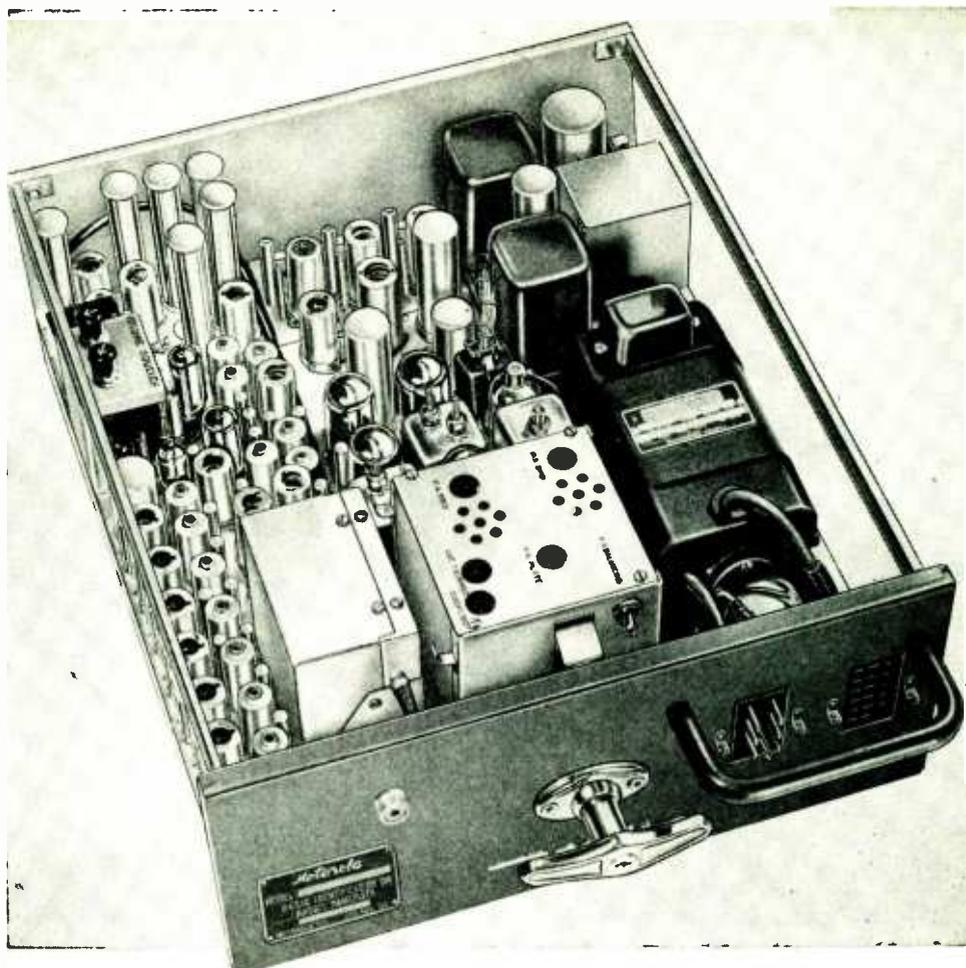

Fig. 1. A 30-watt transmitter-receiver unit for adjacent-channel use on 152 to 174 mc.

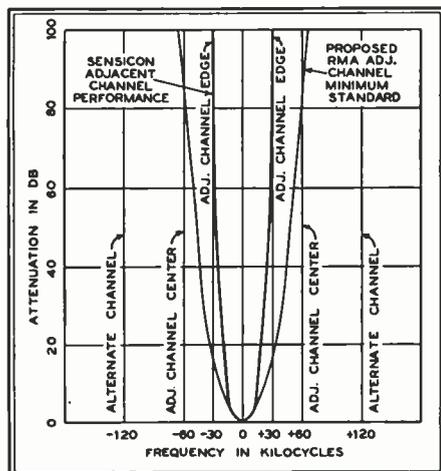

Fig. 3. Overall receiver characteristics

selection cannot be made at the antenna or other RF levels. Extreme IF selectivity is required, together with absolute control of frequency stability, intermodulation interference; de-sensitizing, spurious and image response, temperature drift, nuisance noise, and audio quality. In addition, the associated transmitter must exhibit markedly improved characteristics over and above those of conventional units with respect to spurious and harmonic radiation, frequency stability, and deviation control.

Advances in Receiver Design:

From the design principles employed in the new Motorola narrow-band receiver came several outstanding engineering achievements. To obtain high effectiveness in the RF selectivity circuits, rigid, tunable coaxial lines are employed, as shown at the right in Fig. 5. A total of five such elements precede the first mixer

stage, with a sixth serving to resonate the local oscillator plate circuit. Each resonant circuit is effectively a midjet cavity, silver-plated to improve efficiency, and temperature-compensated with negative-coefficient ceramic capacitors to insure highly stable RF characteristics. Spring-loaded wiping contacts in the tuning elements aid to minimize contact resistance. As a measure of improved performance, the midjet cavities demonstrate loaded Q 's in the order of 250 as compared to Q 's of 50 to 70 in ordinary transmission-line tuners or 10 to 30 in conventional permeability-tuned circuits.

This increased degree of RF selectivity, together with improved interference characteristics realized from design refinements in the radio frequency amplifier and first mixer stages, provide excellent control of out-of-band desensitizing, intermodulation, and spurious response.

Spurious responses can be reckoned with and attenuated to a level of insignificance, but the elements of desensitizing and, more prominently, intermodulation interference have been steadily growing in importance until today they rate separate consideration.

By definition, the intermodulation spurious response attenuation characteristic of a receiver is the measured amount of its ability to receive a desired signal to which it is resonant, in the presence of two interfering signals so separated from the desired signal and from each other that n th-order mixing of the two

undesired signals can occur in the non-linear elements of the receiver, producing a third signal whose frequency is equal to that of the desired signal. Fig 6 illustrates this. For example, let

- A = desired channel,
- B = adjacent channel, and
- C = alternate channel.

f_I = intermodulation interference signal

f_A = desired signal

$f_B = f_A + \Delta f$ = adjacent channel signal

$f_C = f_A + 2\Delta f$ = alternate channel signal

EXAMPLE 1: Assume that the difference frequency generated by mixing of the alternate and adjacent-channel signals beats back with the adjacent-channel signal to form another set of sum and difference products. It can be shown that the sum-product will cause interference on the desired channel as follows:

$$f_I = (f_B - f_C) + f_B \\ = 2f_B - f_C$$

By substitution:

$$f_I = 2f_A + 2\Delta f - f_A - 2\Delta f$$

Therefore, $f_I = f_A$

EXAMPLE 2: Assume mixing of the adjacent channel second harmonic with the alternate-channel signal. It can be shown that the difference product will cause interference on the desired channel as follows:

$$f_I = 2f_B - f_C$$

By substitution:

$$f_I = 2(f_A + \Delta f) - (f_A + 2\Delta f)$$

Therefore, $f_I = f_A$

Unfortunately, as illustrated by these two simple examples, there are numerous

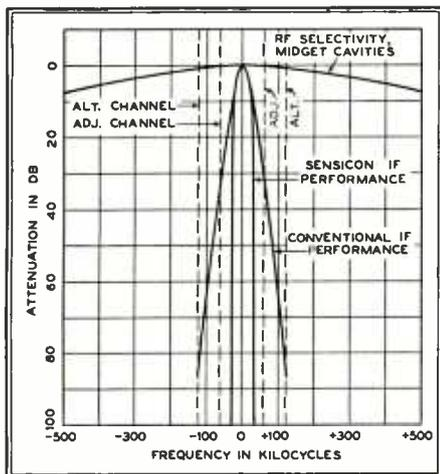

Fig. 4. RF and IF receiver selectivity signal combinations which can produce serious degradation in performance.

As yet there are no established industry-wide tests or minimum performance standards. Tentatively, the following standards and tests have been proposed to furnish the sorely needed basis of comparison and measures of merit for adjacent-channel units:

All receivers designed to provide adjacent-channel service should be capable of satisfying the following minimum performance requirements:

1. **NUISANCE INTERMODULATION SPURIOUS INTERFERENCE:** Two equal signal ratios of not less than 64 db above the on-channel effective 20 db quieting signal level, impressed simultaneously across the receiver antenna terminals at frequencies displaced plus 60 kc. and plus 120 kc. from the desired frequency shall produce a nuisance interference signal which quiets the receiver not more than 20 db.

2. **RECEPTION INTERMODULATION SPURIOUS INTERFERENCE:** Two equal signal ratios of not less than 80 db above the on-channel effective 20 db quieting signal level, impressed simultaneously across the receiver antenna terminals at frequencies displaced plus 60 kc. and plus

120 kc. from the desired frequency, shall produce a reception interference signal resulting in an IF meter reading equal to that normally experienced from a 10-microvolt or 20 times 20 db quieting-level on-channel signal (whichever is the greater). The reception interference shall be measured by IF grid metering.

The paragraphs above outline absolute minimum performance standards considered adequate for satisfactory adjacent-channel operations. The curves in Fig. 6, for example, illustrate the actual performance characteristic of the Motorola Sensicon unit.

Adequate suppression of both desensitizing and intermodulation interferences have been slighted in many receivers now commercially available. Practically, both types of interference have been dominant obstacles in the road toward

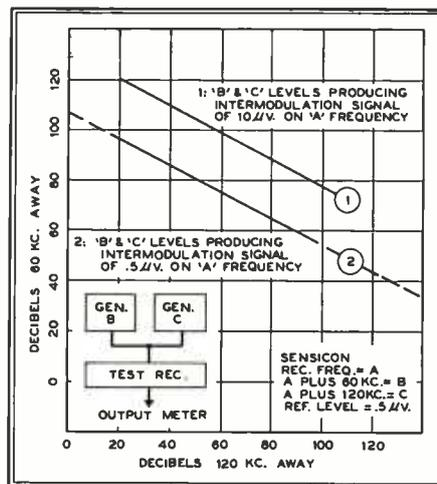

Fig. 6. RF intermodulation characteristics

successful adjacent-channel operations, particularly in same-area operation.

The overall selectivity of this special mobile service receiver is determined predominantly by the separately-packaged IF wave filter illustrated in Fig. 5. Permeability tuned coils and compensating capacitors assembled in a modified constant-K and *m*-derived network comprise

a total of 15 tuned circuits which are permanently fixed electrically and mechanically by casting the entire filter structure in a solid block of polymerized resin. Thus, those circuits which regulate to a controlling degree the frequency-rejection capabilities of the unit are rendered impervious to the extreme heat, humidity, and vibration conditions common in the mobile services. This technique not only prevents degradation of performance through shock or exposure to the elements, but also removes the possibility of tampering or misalignment as a result of field service without proper test equipment.

Electrically, the cast filter provides at least 100 db. attenuation at ± 30 kc., the edges of the adjacent channels for the 152- to 174-mc. band, as indicated in Fig. 4. Recent investigations indicate that the characteristics exhibited by this unit are suitable for same-area, adjacent-channel operations in the 152- to 174-mc. band (60-kc. channels), and for adjacent-area, adjacent-channel operations in the 25- to 50-mc. band (40 kc. channels).

A similar filter has been designed, tested, and put in production to provide 100-db attenuation at ± 20 kc., the edges of the adjacent channels for the 25- to 50-mc. band.

Since the band-acceptance limits of the receiver IF stages are now immovably fixed, a special local oscillator has been introduced. This innovation in manually-tuned, crystal-controlled local oscillators results in a receiver which is easy to tune and maintain. Precision tuning is made possible through the use of a unique series-mode, permeability-adjusted oscillator circuit. Thermal compensation has been incorporated to insure stable performance through broad ambient temperature variations. The circuit, employing a temperature-controlled, oven-type crystal assembly is guaranteed to maintain frequency stability to better than $\pm .00066\%$ over an

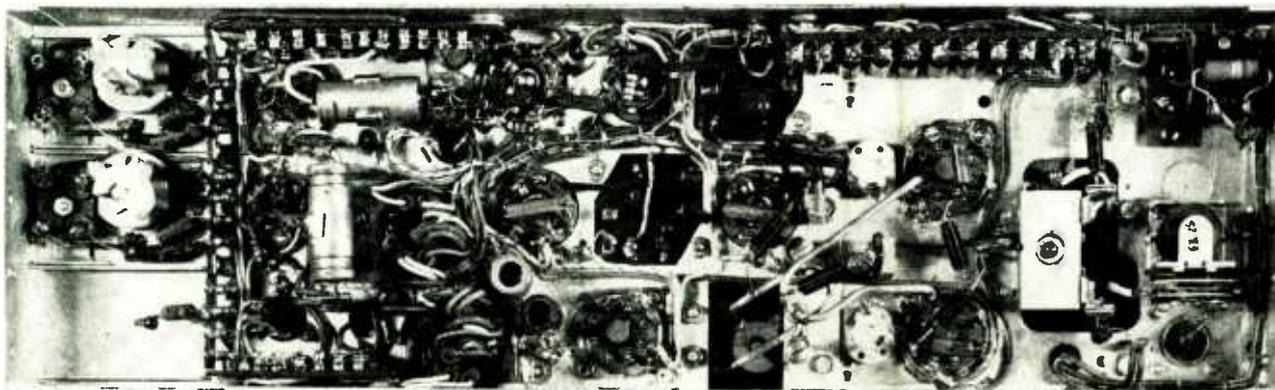

An underside view of the complete 30-watt transmitter section. This illustration should be compared with the views of the chassis and separate decks shown in Fig. 2. The output end of the transmitter is at the right hand side in this view

ambient temperature range of -30° C. to $+60^{\circ}$ C. when operating on any assigned frequency in the band of 152 to 174 mc. A comparable unit is available for operation on 25 to 50 mc.

Transmitter Improvements:

The attainment of extraordinary receiver characteristics will not solve the problem of adjacent-channel or even alternate-channel operations unless the radiated energy of stations occupying these nearby channels is also controlled adequately. Effective steps must be taken to eliminate the possibility of any appreciable on-channel radiation appearing in the neighboring channels. It is impossible to design a receiver which will reject an undesired signal when that signal contains frequencies within the band-acceptance limits of the receiver.

Spurious and harmonic radiation must be eliminated or at least attenuated to safe levels of 70 to 100 db. below the desired carrier level. In addition, carrier deviation due to modulation must be limited to insure operation only out to, and not exceeding, the authorized channel limits.

It is well known that in phase modulation the instantaneous deviation excursion is determined by both the amplitude of the modulating wave and the steepness of the wave front, or slope of the modulating wave. This means that an ordinary amplitude limiter will not control the instantaneous deviation maximums, and in order to gain control it becomes necessary to add a slope limiter to the control circuit. One way to achieve such a control is to use an ordinary amplifier modified by differentiating circuits so that the control voltage increases with an increase in frequency of the modulating wave. Such a system has the disadvantage of slow attack and release time, and is obviously too cumbersome to include in compact mobile and port-

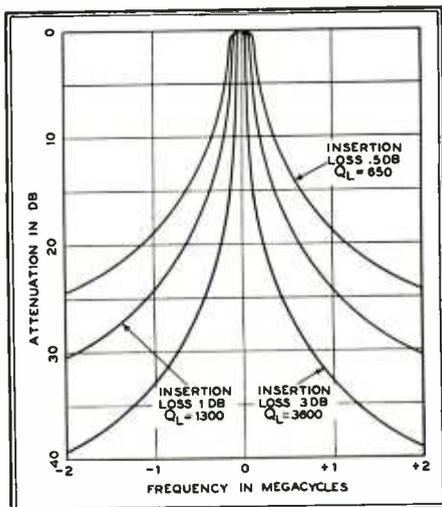

Fig. 7. Curves of a high-quality, 10-in. cavity tunable from 152 to 162 mc

able equipment.

To comply with the requirements of adjacent-channel operations and, more recently, with the FCC ruling effective July, 1950 governing deviation control, an instantaneous deviation control has been designed and developed to provide amplitude limiting and positive slope limiting without introducing time constants for the attack and release of the limiter. The circuit is simple enough to include in the usual types of base station and mobile communications equipment.

The IDC Circuit:

The operation of the Motorola instantaneous deviation control requires first, the differentiation of the modulating wave, followed by a clipping action, and then by an integration operation. Fig. 8 shows the circuit. The initial differentiation process emphasizes voltages

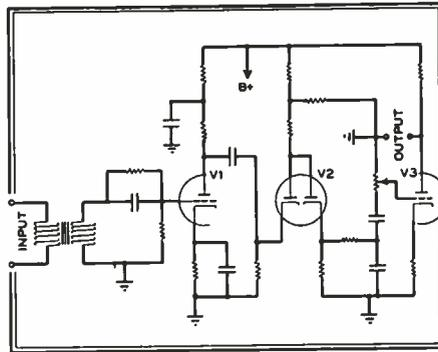

Fig. 8. The basic Motorola IDC circuit

associated with steep wave fronts or steep slopes and, as a result, the clipping action clips off that portion of the wave directly related to steep wave fronts. Since the differentiation results in emphasizing the high frequencies in relation to the low, it follows that undesirable voice pre-emphasis results, and there also remains a distribution of frequency characteristics of the wave which would result in overmodulation. Since the clipper is followed by an integration circuit, the wave characteristics are restored to normal, and any undesirable transients introduced by the clipping action are further reduced. Observing the action of this I.D.C. system on an oscilloscope while subjecting the transmitter modulator input to approximately 30 db overload, the voice wave appears to strike an invisible barrier. The scope is connected to a calibrated discriminator circuit, so that the excursion viewed is a direct indication of the instantaneous deviation.

It is quite true that the control of instantaneous deviation in a phase modulation system does not prevent modulation products from extending beyond the limits of the instantaneous deviation maximum. In other words, there will appear beyond the limits of deviation

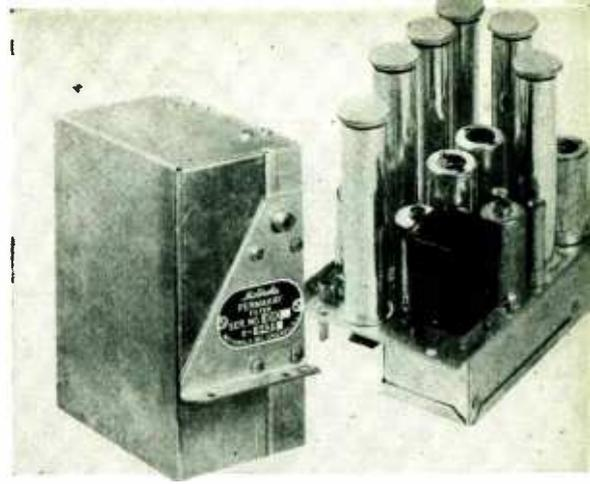

Fig. 5. An IF filter and RF tuner deck

side bands or products of modulation which may extend into the adjacent or the alternate channel. Field tests show, however, that because the energy content in a voice wave is low, and interference capabilities of these transient modulation products in the adjacent and alternate channels are also low, while under certain conditions a degree of monkey chatter and some undesired noises may be produced, there is little or no actual interference with the reception of the desired station. Where the instantaneous deviation is not controlled, the excursion of the carrier outside of the pass-band of the receiver not only decreases the signal-to-noise ratio in the receiver, but it also adds considerably to the interference energy in the adjacent and alternate channels. The combination of superior receiver characteristics in a system where instantaneous deviation control is employed appreciably enhances the practicability of maximum channel utilization.

Today, normal channel operations require and allow ± 15 - to 20 -kc. frequency excursions for optimum 100% modulation levels. Generally speaking, energy in the modulation excursion beyond the normal band acceptance of the receiver is rejected and, therefore, wasted. It is a fair rule-of-thumb to say that energy beyond the 10-db down limit of the selectivity curve is not useful energy. Obviously, then, as the bandwidth of the associated receiver becomes narrower, the transmitter deviation must be held within tighter limits. The narrow-band receivers, exhibiting minus 100 db at ± 20 -kc. characteristics, require only ± 7.5 kc. deviation at 100% modulation for full audio output. Most assuredly, future split-channel operations will decrease the deviation limit still further. Progress achieved in recent years is indicated by Fig. 9, illustrating bandwidth reduction.

Mechanical Design:

Electrical design is paramount in the actual achievement of adjacent-channel performance. However, the mechanical production, and perhaps even more important the economic considerations are

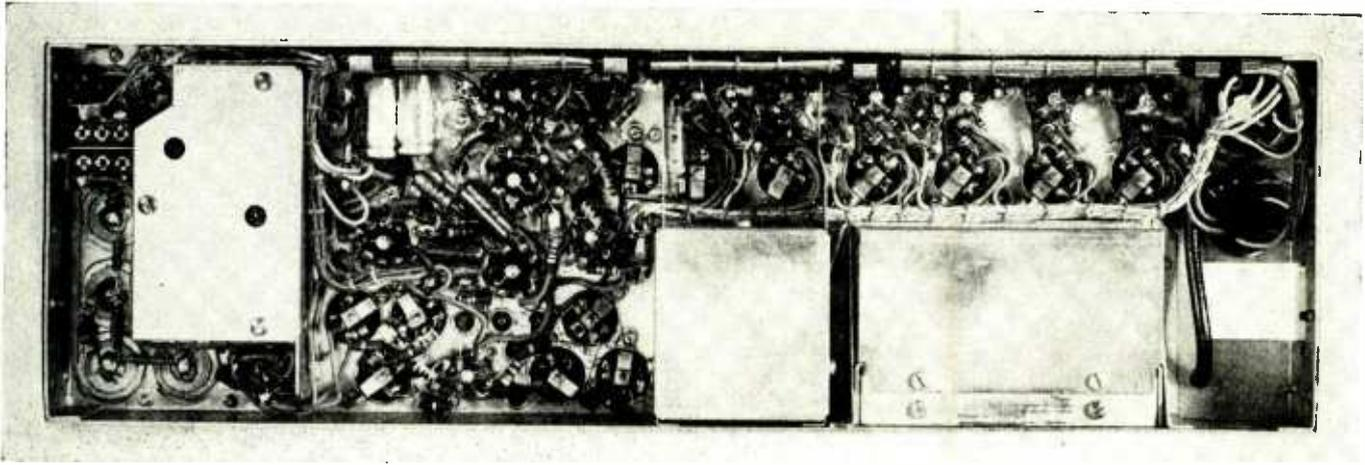

This picture of the under side of the complete receiver section can be more readily understood by comparing it with Fig. 2, which shows the chassis and separate decks. In this view, the RF tuner is at the left, and the meter socket at the right

of interest to the ultimate user. How long will the equipment be modern and abreast of current developments? How soon will it be made obsolete by advances in the art, or how much will it cost to keep the performance characteristics in compliance with federal legislation which may be made effective before the equipment completes its normal useful life?

In the mechanical design and packaging of the transmitter and receiver unit, those basic circuits and components which are not likely to be changed drastically over a reasonable period of time can be incorporated in a foundation or basic chassis unit. Those other circuit elements which are subject to change as the industry progresses toward full adjacent-channel or even split-channel operations should be concentrated on separate plug-in or sub-chassis units.

To allow complete flexibility, the receiver unit discussed here, Fig. 2, has a basic chassis incorporating the IF amplifier stages, limiter circuits, and audio section. On separate sub-assemblies are those elements which vary from one application to another. The RF tuner deck contains the controlling elements of RF selectivity, frequency stability, intermodulation, and desensitizing control, as well as single- and multiple-channel operation. The IF wave filters furnishing the selectivity-determining element are interchangeable to allow 60-kc.,

40-kc. or even narrowed-band operation as desired.

The associated transmitter, also shown in Fig. 2, represents an equally versatile unit. RF oscillator decks containing the frequency-stabilizing crystal assemblies

are heated or unheated units, depending upon the over-all frequency stability required. The final RF power amplifier is designed as a separate unit, to provide whatever output is required. In addition, a level adjustment is available in the deviation control circuit to allow maximum deviation-limit settings to match the bandwidths of the associated receivers.

Integrated Solution Required:

While tremendous strides in equipment design have been demonstrated, continued care must be exercised in the evolution of system combinations. To measure the merits of the advances attained, comprehensive tests and rigorous performance standards must be set.

It is generally recognized that the day of practicable adjacent-channel operations and maximum channel-utilization is upon us. Substantial improvement in the receiver intermodulation characteristic has been accomplished. IF design for the 100-db protection against adjacent-channel signals has been made physically and economically possible. Frequency stability has been improved to a degree allowing even further tightening of channel bandwidths. A carefully-planned program for the geographic assignment of channels will produce efficient spectrum conservation. Such integration will result in a solution of the problems of the mobile radio services.

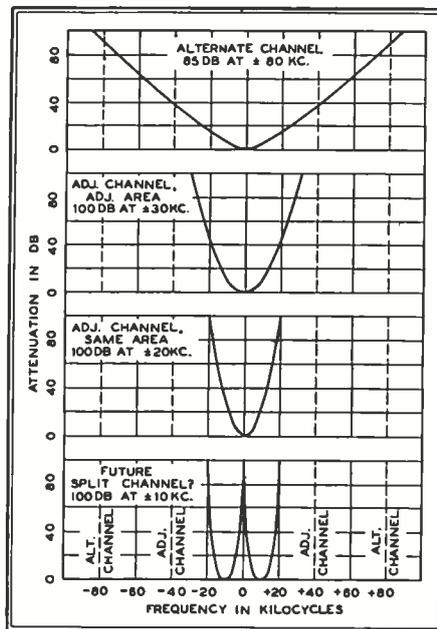

Fig. 9. Steps in reducing bandwidth

provide for operation on 1, 2 or 3 frequencies. Changing from one channel to another is accomplished by a simple switch, with absolutely no circuit readjustments required. Crystal assemblies

CHAPTER 7: ANTENNA DESIGNS

AN INFORMATIVE DISCUSSION OF THE PERFORMANCE AND CHARACTERISTICS OF STANDARD ANTENNAS FOR VARIOUS TYPES OF COMMUNICATIONS SYSTEMS

WHEN plans are made for the installation of communications systems, the importance of the antenna to proper operation and high efficiency of the system is often forgotten, or discounted. However, the use of an antenna best suited to the needs of the proposed system can mean the difference between success or failure to span a point-to-point

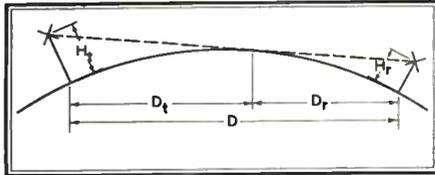

Fig. 1. Line-of-sight propagation distance

distance, or to provide the required coverage for a given area.

Certain types of antennas have been used extensively in the mobile radio field, and have been proved successful in actual service. They are known to be structurally practical and to operate at high efficiencies. These will be described, and their operation explained in a non-mathematical treatment.

Many antennas perform much better on paper than they do in practice. This may be due to difficulty in matching impedances, to the necessity for much-too-

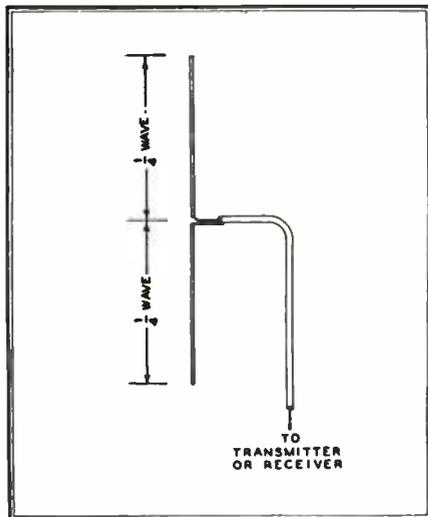

Fig. 2. Simple vertical half-wave dipole

critical adjustments, or because the construction is mechanically unwieldy and will not withstand the elements. The text is written with the following specifications in mind: The mobile radio services require antennas or arrays that will provide high electrical efficiency and the required radiation pattern. At the same

time, they must be simple, easy to match and adjust, and of mechanical construction that will withstand corrosion, icing conditions, high winds, rain, and condensation. An antenna that will not meet these specifications is unsuited for day-in and day-out use, regardless of its theoretical advantages.

Line-of-Sight Transmission:

At communications frequencies, line-of-sight propagation is employed with little or no effect from atmospheric causes. If the transmitting antenna is visible from the receiver, the VHF signal can usually be transmitted reliably both day and night.

Optical line-of-sight distance can be calculated by the following equation:

$$D = 1.23 (\sqrt{H_t} + \sqrt{H_r}),$$

where

D = line-of-sight distance of miles
 H_t = height of transmitting antenna in feet

H_r = height of receiving antenna in feet

At these frequencies, however, a slight extension of the transmitting range will be achieved by refraction. This is known as the quasi-optical or radio horizon distance and is expressed as follows:

$$D = 1.42 (\sqrt{H_t} + \sqrt{H_r})$$

Fig. 1 shows the relation between transmitting distance and antenna height.

It would seem that the greater the height of either or both of the antennas, the greater the range. This is true providing, of course, that the signal radiated is of sufficient power.

The Simple Dipole:

Where a fixed station is required to transmit to mobile units or to many scattered fixed points, the vertical half-wave dipole, Fig. 2, might be considered the most desirable antenna because of its simplicity. It is, however, difficult to mount. Since it is fed at its center point, the transmission line must be led away horizontally for at least a wavelength before descending to the transmitter; otherwise, the proximity of the line to the lower quarter-wave element would interfere with the antenna's characteristics as a dipole.

Horizontal half-wave dipoles can be used only in special cases, since they are bi-directional in the horizontal plane. Another point to be considered is the choice between vertical and horizontal polarization of the radiated waves. Tests have

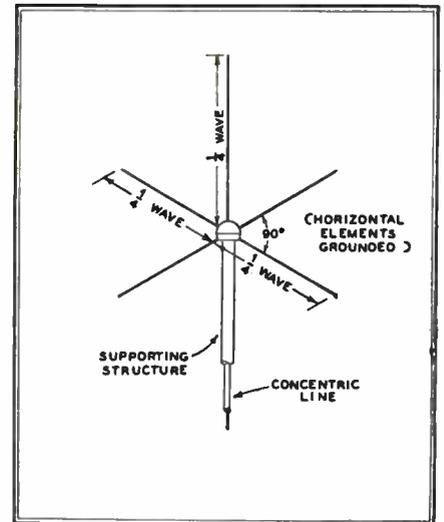

Fig. 4. The ground-plane antenna

shown that horizontal polarization provides better propagation characteristics than vertical polarization over most types of terrain. However, the requirement that mobile antennas be vertical, plus the fact that simple vertically polarized antennas are non-directional, dictates the choice of vertical polarization when communication with mobile units is involved. Therefore, the horizontal dipole is rarely employed. Typical radiation patterns in the horizontal plane for vertical and horizontal dipoles are shown in Fig. 3.

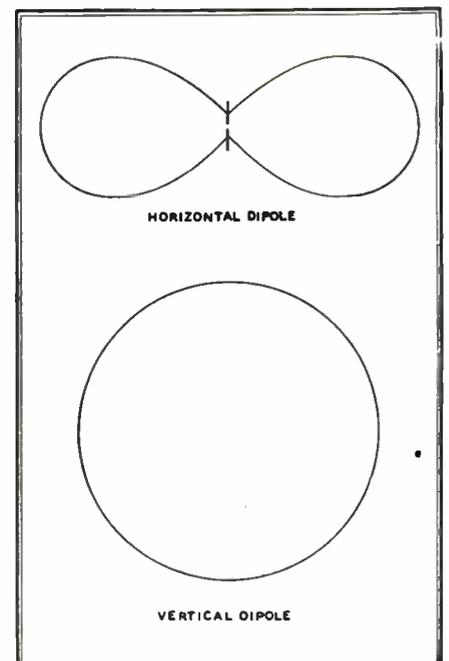

Fig. 3. Radiation patterns of the dipole

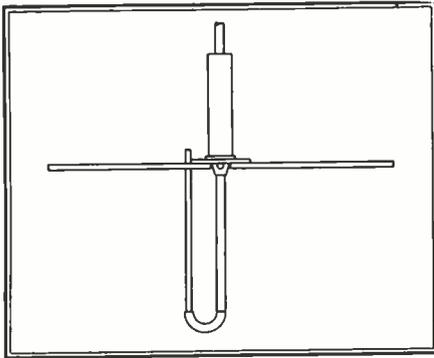

Fig. 5. Outline of the folded unipole

The Quarter-Wave Whip:

If the lower half of a vertical half-wave dipole were eliminated, there would remain nothing more than a quarter-wave whip antenna such as is often used on mobile units. The whip on a mobile unit has the body of the vehicle to use as an RF ground or counterpoise, but it cannot be used alone at the top of a fixed transmitting tower. An RF ground must be provided or the whip will not provide proper termination for the transmission line. This can be accomplished by using a counterpoise system of horizontal whips, as shown in Fig. 4. The grounded horizontal elements provide a ground-plane similar to a metal roof on a mobile unit.

The Folded Unipole:

One of the most popular antennas for fixed stations is the folded unipole. Fig. 5. Slight additional gain over a dipole can be realized, depending on the frequency used. Since the radiating element of the folded unipole antenna is vertical, the radiated signal is vertically polarized, and the radiation pattern in a horizontal plane is nondirectional. The radiation from the folded unipole antenna is concentrated along the horizon, and some improvement in field strength over ordinary coaxial antennas is obtained. This is shown in the vertical directivity pattern of Fig. 6. Measured at 40 mc. the field gain over a dipole is about 1.45, corresponding to a power gain of 2.1 or 3.22

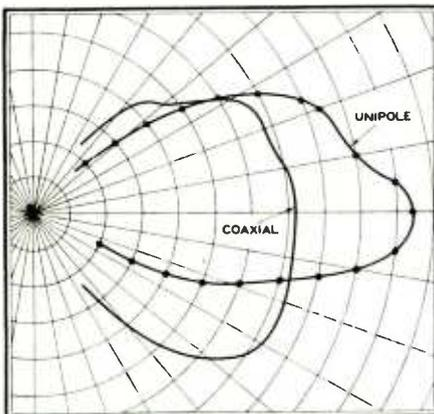

Fig. 6. Unipole vertical radiation pattern

db. The amount of gain varies with frequency. It exceeds 1 db from 25 to 76 mc., and varies between 0 and 1 db from 108 to 174 mc. Fig. 7 illustrates this effect in the horizontal plane. The main feature of this antenna is the grounded radiating element, which minimizes lightning damage and offers a slight improvement in the signal-to-noise ratio.

A modified version of this antenna has also been developed to produce a cardioid directional pattern for special application. If a reflector is attached to one of the ground rods, the cardioid pattern will result, as shown in Fig. 8. Note that coverage is obtained over approximately

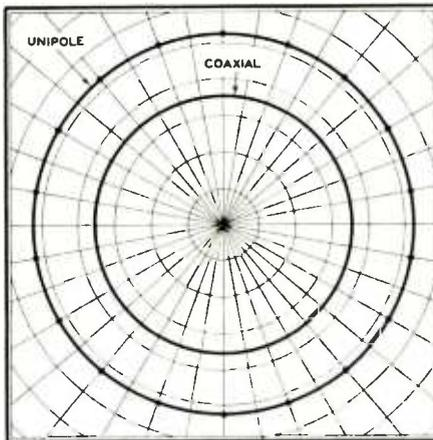

Fig. 7. Unipole horizontal-plane radiation

180°. The illustration shows measured horizontal field intensity patterns for 152 to 162 mc. The average gain in the forward direction is 3.3 db, referred to a folded unipole antenna.

The primary purpose of such a pattern would be for use in mobile services operating along state or city borders, shorelines, or back to back with other services. By concentrating its radiation, this antenna gives greater coverage in required operating areas, and reduces co-channel interference. Short-range communications in the direction in which signal is suppressed is still possible, for back radiation is not entirely eliminated.

Coaxial Antennas:

Another approach to the problem of mounting a half-wave vertical dipole is to lead the transmission line or coaxial cable up inside the lower half of the dipole. This is accomplished in the half-wave coaxial, or concentric, antenna.

The upper half of the dipole is called the whip, and the lower half is called the skirt. Reference to Fig. 9 shows that all elements have a common vertical axis. Hence the name "coaxial antenna." The support tube contains the transmission line, and is electrically common with the outer conductor of the line, both being at ground potential. The inner conductor of the coaxial line feeds the whip, which is insulated from the upper end of the

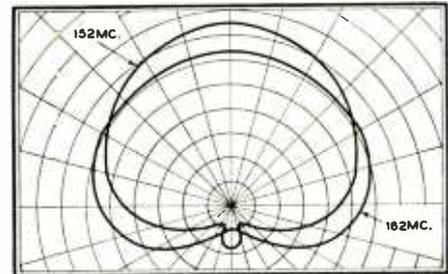

Fig. 8. Patterns of unipole with reflector

support tube. The skirt, while directly connected to the top of the support, is insulated from it below this point by insulating rings which also keep it concentric with the support.

A coaxial antenna can be shunt-fed also. In this case the whip is common electrically with the support tube. The skirt is also grounded at its upper end, as in the case of the series-fed coaxial antenna. To feed the antenna, it is necessary to take the center conductor of the transmission line through the support tube and connect it to the skirt at an impedance-matching point some distance down from its upper end, as in Fig. 10.

Numerous reports from radio men in the field attest to the fact that the correct location of this impedance point is difficult to determine, and that further adjustments may be required after installation to obtain maximum output.

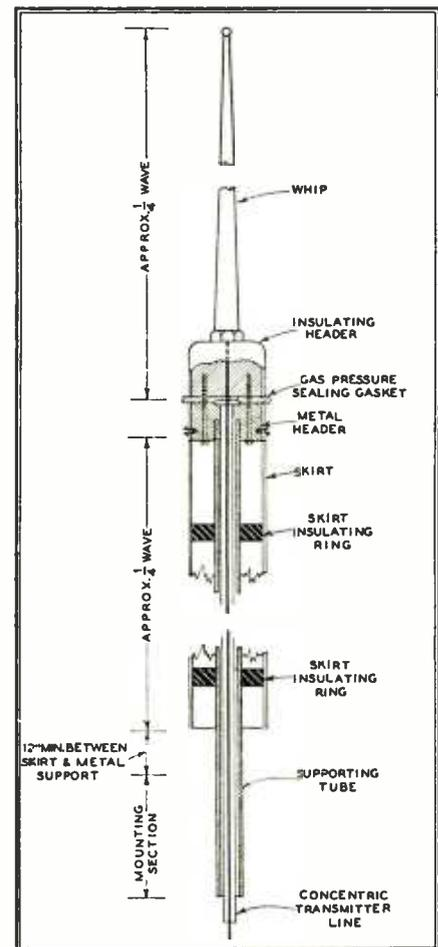

Fig. 9. The series-fed coaxial antenna

About the only advantage that can be claimed for the arrangement is that the highest element, the whip, as well as the skirt, is at ground potential with respect to DC. It must be admitted that this fact should provide a certain protection in case of a lightning strike.

However, experience with several thousand series-fed coaxial antennas shows that lightning usually caused no structural damage to the antenna but, in the case of a heavy stroke, the coaxial transmission line suffers an arc-over or puncture within 6 or 8 ft. of the antenna header. Reports from the field show that the same thing occurs with shunt-fed coaxials, as would be expected. Records show only three or four series-fed coaxial antennas that have suffered structural damage to the whip or the insulating header assembly. In these cases, the available evidence has led to the assumption that the antennas were subjected to particularly heavy and direct lightning discharges. With either series-fed or shunt-fed antennas, the usual damage is to the transmission line alone, necessitating its replacement. Thus it would seem that any advantage of the shunt-fed coaxial, as far as lightning is concerned, is more theoretical than practical.

It is felt, therefore, that the series-fed coaxial antenna provides the ideal an-

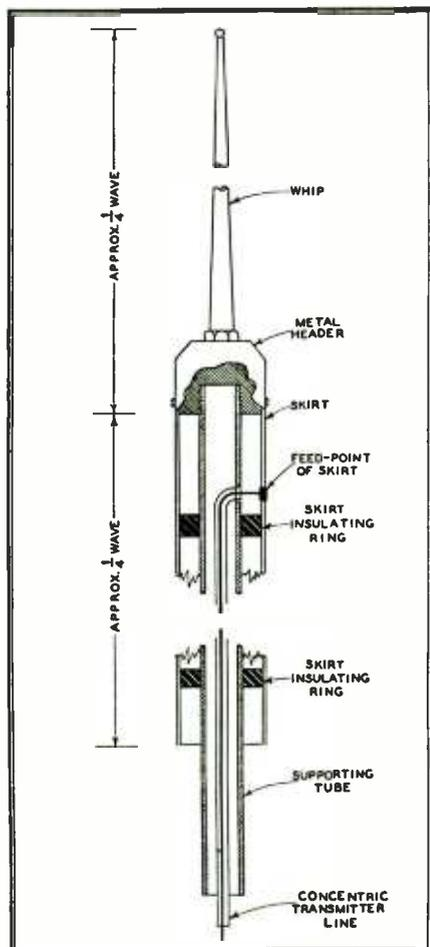

Fig. 10. The shunt-fed coaxial antenna

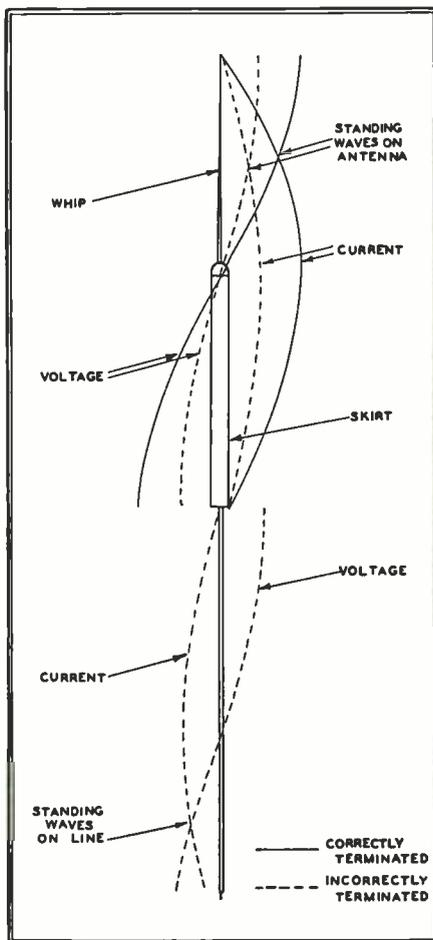

Fig. 12. Standing waves on antenna

tenna at a fixed location, for omni-directional coverage. It is a relatively simple structure, and can be built strongly of lightweight aluminum alloys. Such an antenna, cut for an operating frequency of 30 mc., weighs less than 10 lbs. including the support tube. The vertical radiation pattern of a coaxial half-wave dipole antenna is shown in Fig. 11. It should be noted that this pattern is produced in all horizontal directions and can be compared to a doughnut flattened on the bottom and resting on a table, with a toothpick, representing the antenna, in the center of the hole.

The most critical portion of a coaxial antenna is the length of the skirt. If it is not cut correctly for the operating frequency, the performance of the antenna may be impaired seriously. However, this exact length can be computed

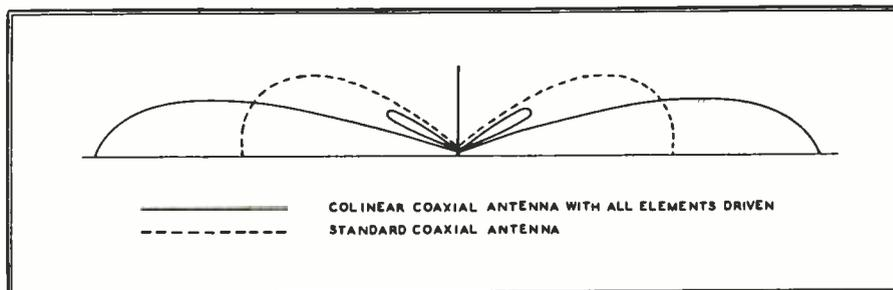

Fig. 11. Dotted lines show the vertical radiation pattern of coaxial antenna

readily. Then the skirt can be cut with the knowledge that the antenna will perform at peak efficiency, and will require no further adjustments after installation.

The effective skirt length is that distance measured from the bottom of the metallic skirt-supporting header to the bottom of the skirt tube. Stated another way, it is the length of the air column enclosed between the skirt and the support tube. This is clearly shown in Fig. 9. On a typical coaxial antenna of aluminum, it has been found that with 50- or 52-ohm transmission line, the proper effective skirt length is slightly under 98 per cent of an electrical quarter-wave at the operating frequency.

The reason for accurate skirt-length adjustment stems from the fact that the skirt, in conjunction with the whip, must provide proper termination for the transmission line. In order for an antenna to operate most efficiently, it must be capable of utilizing as radiation the maximum amount of the power delivered to it by the transmission line. This occurs when the impedance of the antenna at its feed point is equal to the characteristic or surge impedance of the transmission line. If the skirt length is not correct, the impedance presented by the antenna does not equal the characteristic impedance of the line. Consequently, some energy is not utilized by the antenna as radiation, but is reflected back down the line.

The skirt performs two important functions. The first is as a resonating stub, or bazooka, to keep standing waves off the transmission line and the antenna support. Standing waves would destroy the desirable low-angle radiation pattern of the coaxial antenna as a half-wave dipole. Second, it is part of the half-wave dipole and, as such, must be the correct percentage of a quarter-wave.

From the standpoint of its second function, the length of the skirt is less critical, but as a resonating stub, it is necessary to hold its length to a close tolerance. Fig. 12 shows standing waves on a line, and how voltage and current are distributed along the antenna elements. This illustration also shows the effects of mismatched antenna elements.

In practice, it is possible to hold the ratio of maximum to minimum standing-

wave voltage to a value of 1.1 with the series-fed coaxial antenna as described previously. This represents a power loss, due to reflections, of less than 1 per cent. A relatively slight increase or decrease in skirt length from the proper value has a pronounced effect on the standing wave

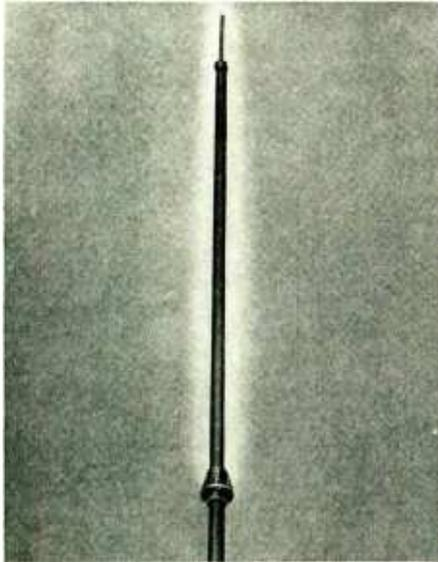

Fig. 15. Series colinear coaxial antenna

ratio, as shown in Fig. 13.

For the aluminum coaxial antenna, the proper length of the whip has been found to be about 95 per cent that of a quarter-wave. This value includes the whip proper and the line contained within the insulating header. In other words, it is that length from the point where the center conductor of the coaxial line emerges from its sheath to the upper end of the whip. The length is not nearly as critical as skirt length. Fig. 14 demonstrates this. While the length of the whip has a definite effect on the performance of the antenna, it can be seen that a variation

from 92 per cent to 98 per cent of a quarter-wavelength has relatively little significance.

The values for skirt and whip lengths given above are for 52-ohm transmission line. If 72-ohm line is used, the skirt length should be almost 99 per cent of a quarter-wave, and the whip, about 94 per cent of a quarter-wave. Actually, the optimum lengths of the skirt and whip for any given coaxial antenna will depend to a slight extent upon the material from which the elements are made, the type and number of insulating rings inside the skirt, end-effects of the skirt, and the ratio of the diameter of the support tube to the skirt tubing. For this typical antenna, as manufactured commercially, the values used are 98 per cent of a quarter-wave for the skirt and 94 per cent for the whip. The antenna can then be fed by 52- or 72-ohm coaxial transmission line, and the standing-wave ratio in either case will not exceed 1.25, representing a power loss of not more than 3 per cent.

Colinear Coaxial Antennas:

A variation of the coaxial antenna which provides greater vertical directivity is the colinear coaxial antenna. Fig. 15 shows an exterior view of this antenna.

There are available three types of colinear antennas: those parasitically excited, series fed, and shunt fed. Fig. 16 illustrates a coaxial antenna with parasitic lower elements. Efficient parasitic excitation of these lower skirts is subject to question, since the additional skirts are not within the main radiation pattern of the series-fed coaxial antenna located above it. Comparison tests against a properly-matched coaxial antenna have shown very little additional gain.

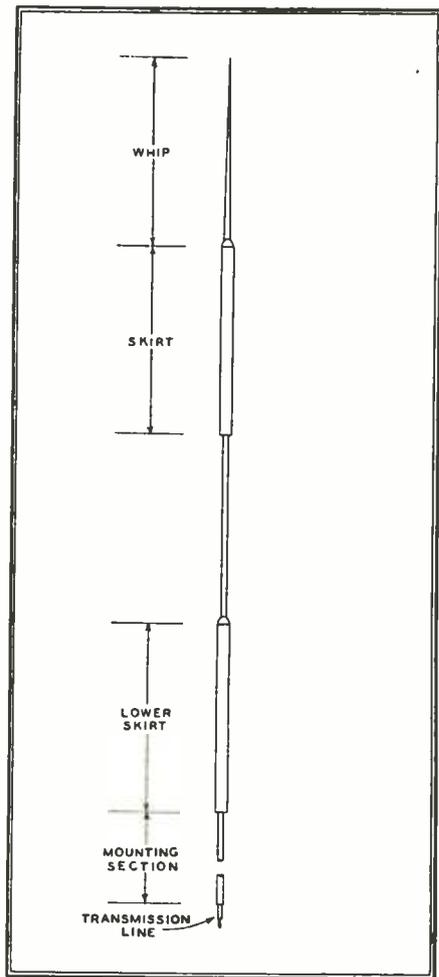

Fig. 16. Parasitic colinear antenna

However, the extra skirts can be employed to advantage in another way. One serious problem in the use of the coaxial antenna is the prevention of power transfer from the antenna to the supporting mast. The problem becomes more important with higher frequencies because of the increasingly greater angle of radi-

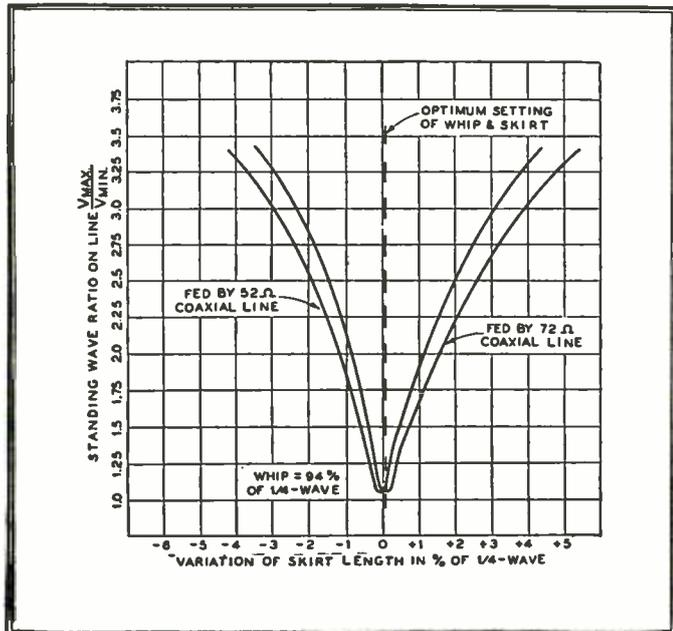

Fig. 13. Effect on standing wave ratio by varying skirt length

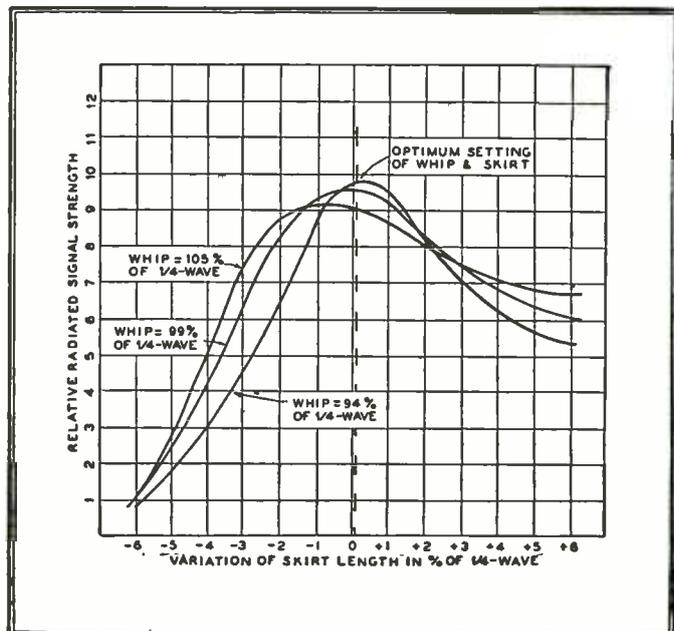

Fig. 14. Effect on standing wave ratio by varying whip length

tion. As more and more energy is transferred from the antenna to the metal supporting mast, two detrimental effects are noted. More of the radiation goes uselessly skyward, and there is less total radiation. Both effects reduce the signal intensity in the horizontal plane.

If the cut lengths of the antenna elements are not precisely correct for the

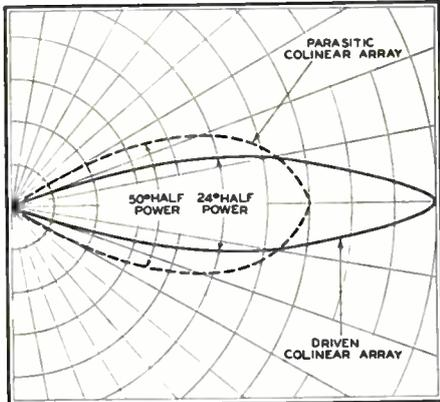

Fig. 17. Radiation curves, colinear arrays operating frequency, this energy transfer to the supporting mast occurs. A method of reducing the energy loss involves the introduction of equivalent series traps. A very efficient isolating trap is the quarter-wavelength skirt, used below the skirt of the coaxial half-wave element. Four to eight of these isolators are generally sufficient, except in a case of grave mismatch. Isolators of any type will complicate the assembly, but the results are usually worth the trouble.

The use of these series high-Q rejection circuits to minimize power transfer from the antenna to the mast and tower has proved fairly effective. However, the higher the frequency the more rejection circuits are required for adequate isolation. Proper spacing of the skirts on the mast is necessary also. In addition, the

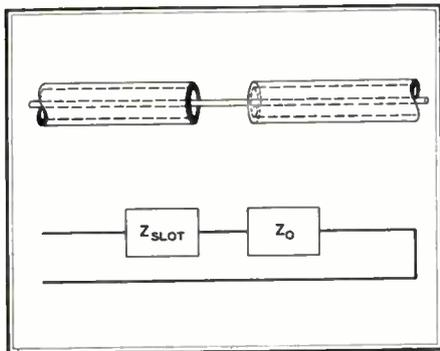

Fig. 18. Impedances in a slotted line

skirts should be cut to slightly different lengths in order to give maximum effective band rejection.

An additional advantage of the use of multiple skirts is the freedom from height effects. Some tests have been made wherein a communications system, employing a simple coaxial antenna, was changed from one completely inadequate

for its intended use to one completely satisfactory by merely raising or lowering the antenna as little as one-quarter wavelength. Height is not critical when skirts are used.

A newly designed series-fed colinear coaxial antenna with all elements driven has proved, during the past 2½ years, to be greatly superior to the standard series-fed coaxial type of antenna, and the parasitically excited coaxial type as well. The design is extremely simple and the antenna can be broadbanded over the entire 152-162 mc. band.

As has been stated, a properly terminated coaxial antenna radiates almost 100 per cent of the power delivered to it. The improvement in signal strength from a colinear coaxial antenna, where all the elements are driven, results not from more radiation but from a lowered angle of radiation in the vertical plane, rendering a compressed radiation pattern as shown in Fig. 17. In any given plane, the area within the radiation pattern boundaries is an expression of the power radiated in that plane. It is obvious that if the vertical width is compressed, the radial distance must be increased to keep the pattern area constant. This provides greater coverage for the same antenna input power.

In the 30- to 42-mc. band, the overall length of the colinear coaxial antenna would be as much as 35 ft., excluding the support tubes. This would probably be too unwieldy. However, in the 152-162 and 162- to 172-mc. bands the length is approximately 10 ft., making possible a mechanically sound structure.

Fig. 15 illustrates a series fed colinear array. Essentially, the antenna is three half-wave dipoles stacked 0.7 wavelength apart and driven in phase. The vertical half-power radiation angle is shown in Fig. 17 to be 24 degrees. Shown also is the half-power radiation angle of the

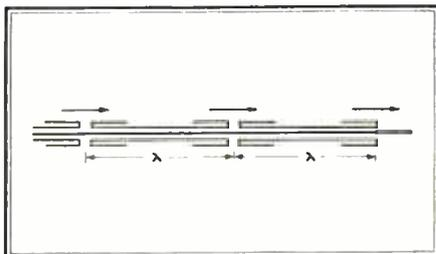

Fig. 19. Instantaneous current in line

parasitic array previously mentioned. The additional gain achieved with the series-fed colinear antenna is clearly indicated. The azimuth pattern of the series-fed colinear antenna is omnidirectional, assuming the antenna site is in a clear, unobstructed location. Feed termination is 51.5 ohms.

A simple explanation of the operating principle is obtained by consideration of an infinitely long coaxial cable, Fig. 18,

in which a slot, small compared to the wavelength, has been cut. The slot presents an impedance in series with the characteristic impedance of the line. If the line is then terminated with a half-wave coaxial antenna, we may slot the line one and two wavelengths back from the termination, and employ phase-reversing skirts to produce the direction of current flow shown by the arrows in Fig. 19. This is in effect three dipoles in series, fed in phase. A concentration of

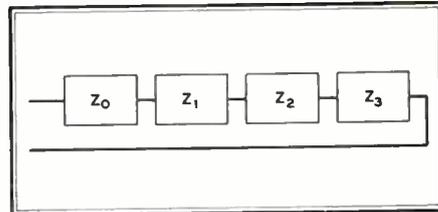

Fig. 20. Equivalent of series-fed colinear

radiated power is produced at right angles to the array. It has been found that the spacing between slots should be 0.7 wavelengths, to keep side lobes 15 to 20 db below the main lobe. In order to obtain the full electrical wavelength required to produce the in-phase condition, the line should be partially filled with polyethylene dielectric.

Driving the elements in phase and in series, as shown in Fig. 20, helps to achieve equal distribution of power in each element because the individual elements have little effect on the current flowing through them. This helps to produce a smooth vertical pattern.

A transformer can be included to broadband the antenna over 152-162 mc. Power gains in the order of 2.75 to 3.5 over ordinary coaxial antennas are realized with this antenna. Therefore, the station coverage can be extended considerably by the use of a high-gain colinear antenna, at minimum cost to the installation.

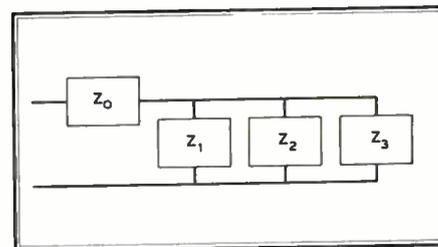

Fig. 21. Equivalent of shunt-fed colinear

The third type of colinear array is shunt-fed. It consists of three half-wave elements stacked and fed in parallel. Although it is theoretically possible to achieve the gain of the series-fed model, measurements of the vertical pattern show unevenness and poor distribution of power. It is difficult to divide power equally into three impedances in parallel, Fig. 21, since each individual impedance determines the power it consumes to such

a large extent. If one element receives more power than another, the effect is that of beaming the radiation up or down, and not along the horizon. Additional problems arise when attempting to broadband the antenna.

In the case of car installations, available power is at a premium. It is practically impossible to use a high-gain antenna in a mobile installation. Therefore, a high-gain headquarters antenna is even more desirable as it boosts the mobile unit signal by an amount equal to its gain, roughly 3 times. Thus, the effective coverage of the car transmitter has been increased three-fold also. If the additional cost of the high-gain antenna is apportioned over the fleet of cars it is to service, it will be found that the cost per car will be quite low.

Directional Arrays:

In order to utilize radiated power most effectively for communication between two fixed points, a beamed signal is desirable, since power radiated to other points serves no useful purpose. Horizontally directional antenna arrays can be used to boost the signal in any direction desired. This means that adequate signal strength can be delivered to a distant point with less transmitter power output than would be required with a nondirectional antenna. Another advantage is that the signal is not broadcast into areas where it might interfere with other services using the same or adjacent channels.

Either vertical or horizontal polarization can be employed for point-to-point transmission. This is because, at fixed locations, the receiving array can be polarized to match the transmitting antenna. Although horizontally-polarized waves travel over most types of terrain with slightly less attenuation than those vertically polarized, a more important consideration is the structural advantage

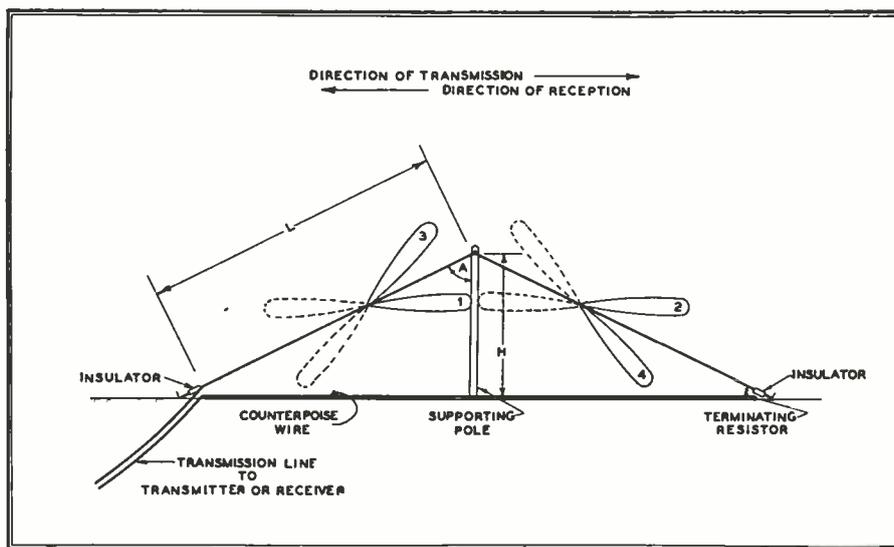

Fig. 23. Half rhombic requires less space, hence is preferred at lower frequencies

offered by one method of polarization over the other.

The Rhombic Antenna:

One of the oldest forms of directional antennas is the rhombic or diamond type. It gives substantial gain but, unfortunately, requires considerable space. Fig. 22 shows a full rhombic antenna.

While a rhombic antenna can be arranged either horizontally or vertically, a vertical half-rhombic or inverted-V antenna, Fig. 23, usually presents the least mechanical problems. The angle of tilt, designated A, is so chosen that the main radiation lobes 1 and 2 are horizontal. Lobes 3 and 4 then cancel and lobes 1 and 2 reinforce. The terminating resistor is used to eliminate the back radiation indicated by dotted lines. With this resistance omitted, the array would be bidirectional, showing about the same gain forward and backward. The angle of tilt can be adjusted by varying the height H or the length of the legs L.

The leg length is not critical, and can be 3 or more multiples of a wavelength

at the operating frequency. While the antenna gain is increased with greater height, performance is more dependent upon the leg length. To realize most of the gain of which the rhombic is capable, L should be at least 3 times the wavelength. However, as L is increased, the gain increases but the beam becomes more narrow. In fact, at 6 times the wavelength, the beam is so highly concentrated that the orientation of the array for maximum signal at the receiving site becomes very critical, and must be done with great care. A gain of 8 to 10 db can be realized with a properly constructed rhombic having a leg length L equal to 6 wavelengths. This means a power gain of about 8 to 1 as compared to a standard half-wave dipole.

The trigonometric computation of the angles and sides of this array is beyond the scope of this text. However, the following relations will produce rhombics that are efficient and will give very satisfactory performance.

Referring to Fig. 23, the proper tilt angle A is approximately 66° , and will be obtained if L is made 2.25 times the height H. Thus, if the operating frequency is 30 mc., and available space permits a leg length equal to 5 wavelengths, L can be found as follows:

$$\begin{aligned} \text{Wavelength} &= \frac{300,000 \times 3.28 \text{ ft.}}{30,000 \text{ kc.}} = 32.8 \text{ ft.} \\ L &= 5 \times 32.8 \text{ ft.} = 164.0 \text{ ft.} \\ H &= \frac{164}{2.25} = 73 \text{ ft.} \end{aligned}$$

At the same frequency, with legs equal to 3 wavelengths, L would equal 98 ft. and H equal 43.5 ft.

At 50 mc., with L equal to 5 wavelengths, H becomes 43.5 ft. and at 3 wavelengths for L, H becomes only 26 ft. It is seen that at higher frequencies, the height of the antenna is seriously cut down. This can be overcome

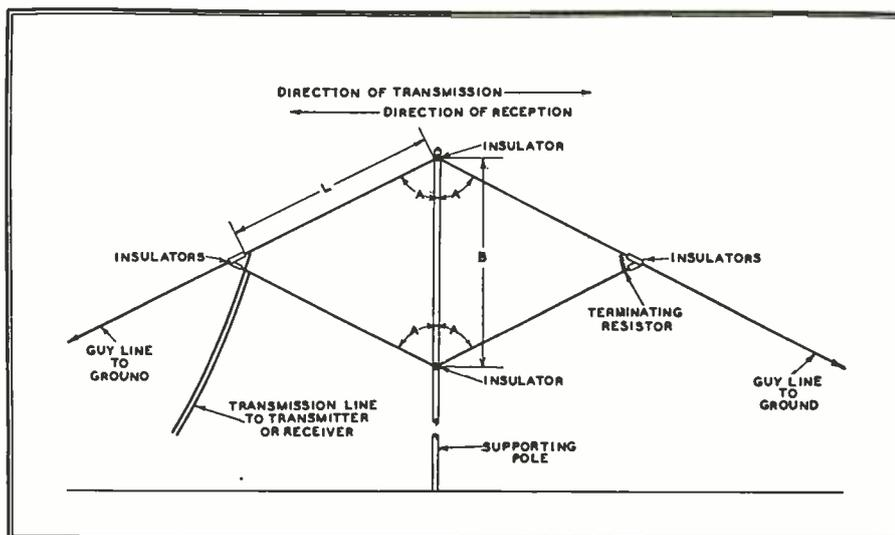

Fig. 22. The full rhombic antenna is highly directional but cumbersome

beyond about 50 mc. by using a full rhombic antenna. As shown in Fig. 22, a single pole can be used to support this array without complicating the mechanical problems to any appreciable degree.

Here the distance B can be made 2 times H as computed above, and the same method used to figure the array. As a typical example, at 75 mc. with legs equal to 5 wavelengths:

$$\begin{aligned} \text{Wavelength} &= \frac{300,000 \times 3.28 \text{ ft.}}{75,000 \text{ kc.}} = 13.08 \text{ ft.} \\ L &= 5 \times 13.08 \text{ ft.} = 65.4 \text{ ft.} \\ B &= 2H = 2 \times \frac{65.4}{2.25} = 58.8 \text{ ft.} \end{aligned}$$

The full rhombic should be as high above the ground as possible, consistent with the space available for the end guys.

With the half rhombic, it is necessary to employ a counterpoise system. This can be simply a wire on or just below the ground, and directly under the antenna. One end is connected to the terminating resistor and the other end is connected to the second conductor of the transmission line. As an alternative, a section of metal screening or simply two wires, one at right angles to, and the other parallel with the antenna can be located on the ground under each end of the array. If the two crossed wires are used, they should be crossed at their mid-points. This point or the center of the screening should then be connected to the transmission line shield at one end of the antenna and to the terminating resistor at the other end of the antenna. If a full rhombic is used, no counterpoise is necessary.

With either the half or full rhombic the following considerations apply equally: The supporting mast must not be of metal. A wood pole, tubular plywood mast, or other non-metallic construction must be used. The mast can be guyed with wires, provided they are approximately at right angles to the direction of transmission. The terminating resistor should have a value of between 500 and 800 ohms. This is not critical. It should also be non-inductive, and must have a wattage rating capable of safely dissipating one-half the transmitter output power, since its function is to eliminate the rear half of the radiation pattern.

Both rhombics exhibit the same characteristics of gain and directivity when used for receiving as for transmitting. The end guys used with the full rhombic, Fig. 22, can be metal without affecting the radiation pattern.

The input impedance of either the half or full rhombic at its feed point is about 600 ohms. If fed by a low impedance coaxial line, a serious mismatch would result. This can be overcome by the

use of an impedance matching transformer. It is properly adjusted when the loading of the transmitter is unaffected by substituting for the rhombic antenna and impedance-matching transformer a dummy antenna, having a resistance equal to the surge impedance of the transmission line. At this adjustment, the antenna current in either leg will also be at maximum.

If, in the case of a full rhombic antenna, it is desired to locate the impedance transformer at or near the ground, an open-wire 600-ohm line can be run from this point to the input end of the antenna. Such a line consists of two lengths of No. 12 wire, as might be used in the antenna, spaced 6 ins. apart by means of waxed wood, Lucite, or porcelain spreaders located every 2 ft. along the length of the line.

Parasitic Directive Arrays:

Where space is not available for a rhombic antenna, or where a compact array is desired, a half-wave dipole with parasitic directors and reflectors can be used. Fig. 24 shows a horizontal dipole array. These arrays present something of a structural problem in the 30- to 44-mc. band. Fortunately, while arrays for those frequencies have been built and are giving satisfactory service, most emergency service point-to-point work will be done on 72 to 76 and 152 to 162 mc.

In most cases, these arrays can be so designed as to lend themselves readily to mounting on towers or pipe masts. They should be all-metal for durability, preferably designed for single-point mounting, and should be self supporting with no external braces.

Returning to Fig. 24, it is seen that the central portion is a half-wave dipole. It is usually fed by a coaxial transmission line, with one quarter-wave element fed by the inner conductor of the line. The other quarter-wave element is connected to the outer conductor of the line. Without the directors and reflectors, it has a radiation pattern as shown in Fig. 3. When tuned elements such as the director and reflector are added, they are located directly in the radiation field of the driven dipole. The metal support-arms for these elements have no effect on the radiation pattern, either with or without the director and reflector. The supports, director, and reflector are all grounded to the hub assembly and to the mast structure, and are therefore at DC ground potential.

The horizontal radiation pattern of such an array is shown in Fig. 25. The function of the director and reflector is to absorb RF energy from the field of the driven dipole and to re-radiate it. By varying the lengths of these elements,

or by varying their separation from the driven dipole, the re-radiated energy can be made to reinforce the signal in the desired direction, and cancel it in the opposite direction.

Referring to Fig. 24, it is seen that the reflector is located slightly less than a quarter-wavelength to the rear, and the director is slightly less than a quarter-wavelength ahead of the driven dipole. Since both are directly in the path of the waves emanating from the driven dipole, each wave cuts across these elements. In doing so, a voltage is induced in the element which is opposite in phase to the inducing voltage. Because of this voltage, a wave is re-radiated from the parasitic element containing up to about 85% of the energy radiated to it by the driven dipole.

The reflector is so spaced that the re-radiated wave, when it returns to the driven dipole, is exactly in phase with the next wave being radiated by the dipole. Since the induced voltage in the reflector is 180° out of phase with the inducing field at the reflector, it is seen that about 90° in time are used for traveling to the reflector, 180° in time are added because of the phase reversal at the reflector, and about another 90° are used in traveling from the reflector to the driven dipole. The re-radiated energy from the reflector has undergone a 360° change of phase by the time it returns to the driven dipole. Thus, it is in phase with the next wave radiated.

The net result is that the two waves involved are so timed in space that they tend to cancel at the reflector and become additive at the driven dipole. Therefore, the circular pattern of the dipole is altered, and is built up in the direction from the reflector toward the driven dipole, and reduced in the opposite direction.

Since the spacing between the parasitic elements and the driven dipole is slightly less than a quarter-wavelength, it becomes necessary to produce a lag at the reflector in order to obtain the 360° phase relationship of the two fields. This can be accomplished by making the reflector element slightly longer than an electrical quarter-wavelength. This makes the reflector appear inductive, and introduces a lagging component of current in the element. By adjusting the length of the reflector element, an optimum value is obtained where the phasing of the radiated and re-radiated fields provides the maximum front-to-back ratio, which is the ratio of the energy radiated in the desired direction to the energy radiated in the opposite direction.

In an array as illustrated in Fig. 24, the reflector is primarily responsible for the directivity, but the addition of a director provides additional gain in the

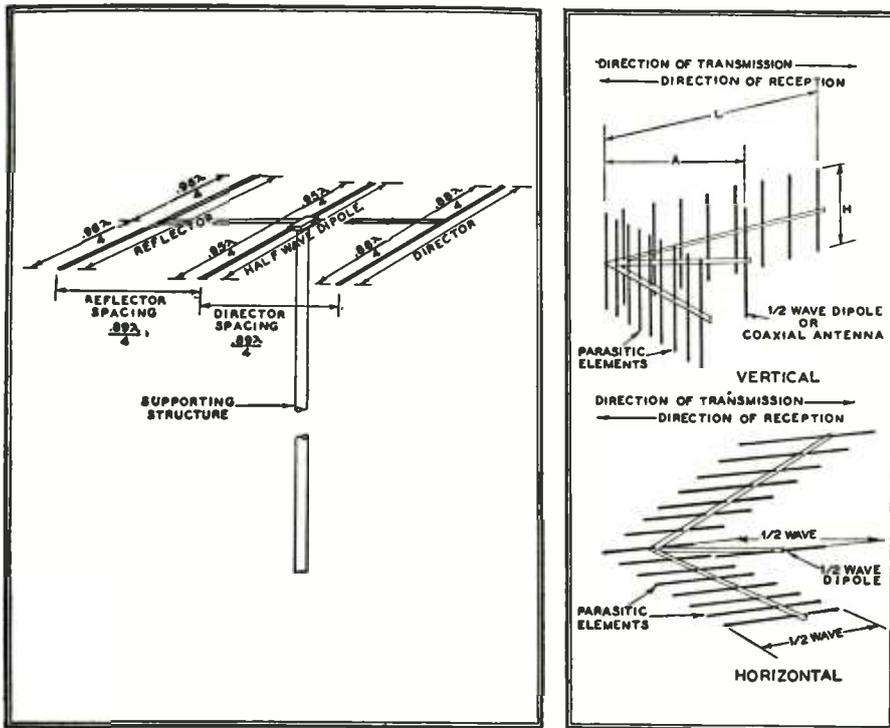

Fig. 24. Horizontally polarized directive array. Fig. 30. Corner reflector antennas

desired direction. More than one director can be used, each spaced about a quarter-wave ahead of the other. When one reflector and two directors are used, the result is the familiar Yagi array.

Trio Manufacturing Company has developed a Yagi array with a gain of 10 db and a front-to-back ratio of 25. This antenna, shown in Fig. 26, employs a folded dipole as the driven element in order to match a 300-ohm line. This is intended for long-distance reception.

In the director, a leading component of current must be introduced, in order to preserve the phasing of the radiated and re-radiated fields, and to provide maximum reinforcement in the desired direction. This is accomplished by making the director elements less than a quarter-wavelength long, so that they appear capacitive.

While each added parasitic element increases the power gain in the desired direction, each one also reduces the mechanical strength of the structure and its bandwidth. Here again the choice must be between power gain and increased wind-and-ice loading on the structure.

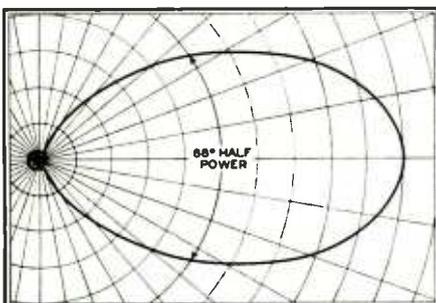

Fig. 25. Pattern of 3-element antenna

The array shown in Fig. 24 is capable of a 2.5 power gain, and a front-to-back ratio of better than 4.5 to 1. This is adequate for most installations. In the event that more gain is necessary, additional parasitic elements can be used. More can be accomplished by adding directors, located in the area of intensified field strength, than by adding reflectors in the area where the field strength has been already reduced.

While the following values will be affected slightly by the type of construction, typical optimum lengths of horizontal elements in terms of a quarter-wavelength are: Driven dipole elements, 95.5%; parasitic reflector and director

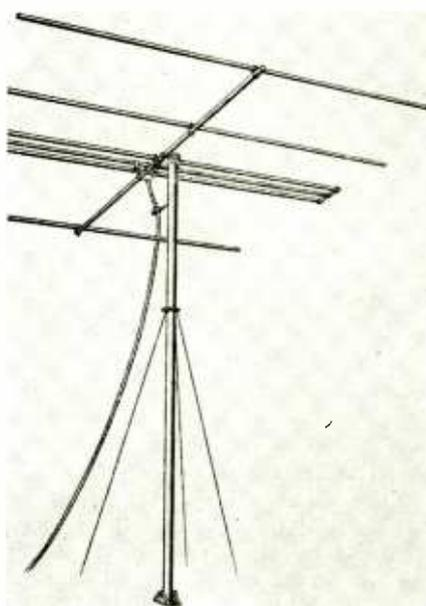

Fig. 26. The Trio Yagi directive array

spacing from driven dipole, 89%; reflector element, 96%; director element, 88%. In arrays consisting of a driven dipole with 1 director and 1 reflector, it should be noted that the impedance presented to the transmission line will remain close to the value presented by a single half-wave center-fed dipole, or approximately 70 ohms.

This array is sometimes constructed with as little as 0.1 to 0.15 wavelength spacing between the driven dipole and the director and reflector. It is found that the impedance presented to the transmission line by such a closely-spaced array is less than 20 ohms, which is a serious impedance mismatch. If the array were to be fed by commercial 50- to 70-ohm concentric cable without a matching transformer, the loss from mismatch, with consequent standing waves on the line, might more than offset any gain from the array.

If the array were rotated 90° around the parasitic support arm as in axis, it would then radiate a vertically-polarized wave. Such an array is readily built about a coaxial antenna.

Quite a number of these arrays are in use, giving highly satisfactory performance. A vertical array based on a central coaxial antenna is shown in Fig. 27. It can be seen that the parasitic support-arm is connected to a hub fitted around the metal skirt-supporting header.

The gain and front-to-back ratio of this array is very similar to that of the horizontal array. Typical dimensions for the vertical coaxial array are presented in terms of a quarter-wavelength

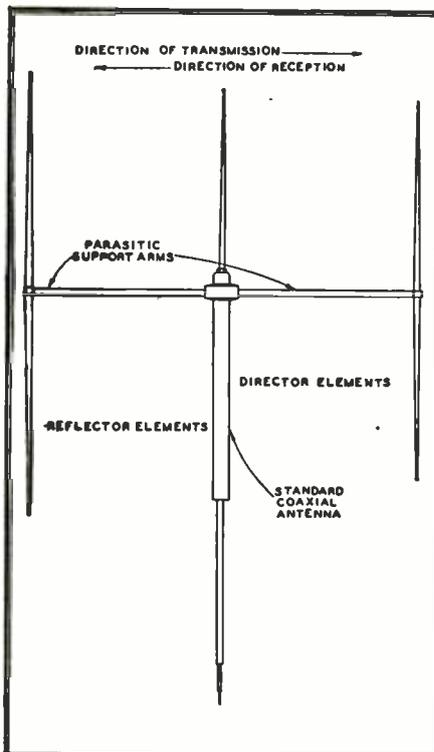

Fig. 27. Directive array with coaxial feed

as follows: Whip length, 94%; skirt length, 98%; spacing from coaxial antenna to director and to reflector 100%; reflector element 103°; and director element, 84%.

Both the vertical and horizontal arrays herein described must have the element-lengths and spacings accurately fixed for optimum performance, but a surprising amount of latitude is possible. A certain amount of droop or sag in the support-arms can be tolerated without serious effect on the performance of the array. Theoretically, the director, reflector and driven dipole should be parallel. Yet misalignment of the elements as much as 30° has little practical effect on the radiated pattern. While such conditions are not desirable, it is obvious that these arrays can take plenty of abuse and still deliver dependable performance.

The Stacked Array:

If additional gain is needed, another three-element array can be stacked one half-wave away. This makes a highly efficient 6-element arrangement. The bays are fed in phase with branch cables. Impedance can be matched with a low standing-wave ratio to 50-ohm transmission line.

The gain of this antenna is approximately 7.6 db. When used in pairs, such as a link installation, the overall gain of the system would be 15.2 db. Fig. 28 illustrates the array, and Fig. 29 shows the horizontal and vertical radiation patterns.

Corner-Reflector Antennas:

Corner-reflector antennas can be used to direct the radiation from either a vertical or horizontal dipole, as shown in Fig. 30. While this type of antenna is mechanically more complicated than those previously discussed, it is a relatively compact array. The central dipole is the only driven member. The other elements are equivalent to two metallic sheets in the form of a corner reflector. Theoretically, each side of the angle should consist of a sheet of metal, which would simply be the ultimate case of having reflecting elements so numerous that they touch each other. Practically, if the spacing of the elements forming the sides is not greater than 0.1 wavelength, the performance of the array does not differ appreciably from that obtained with metal sheets, and offers considerably less wind resistance.

The characteristics of the array can be altered in two ways. As the angle between the sides of a vertically-polarized array is decreased, the beam becomes narrower, mostly in the horizontal plane, but to a certain extent in the vertical plane also. The same effect is noted in a horizontally-polarized array, except that the beam is narrowed more in the vertical

plane as the angle decreases.

Referring to Fig. 30, it is seen that the half-wave dipole is located on a line bisecting the corner angle. The distance A, out from the corner to the dipole location, controls the impedance of the array. The angle between the two sides can be varied between 45° and 180°. At 180°, the effect is that of a dipole located in front of a flat reflecting surface, which produces a very broad pattern forward.

At any angle, however, there is a definite value for A which will produce a desired impedance. For 52-ohm transmis-

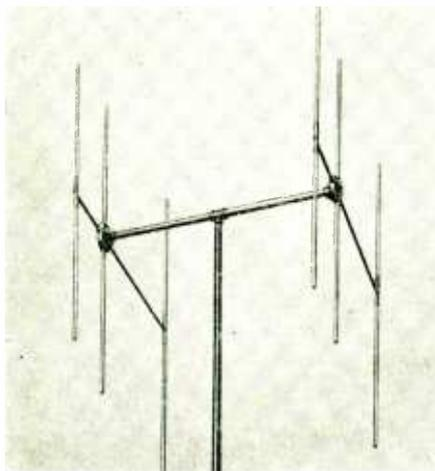

Fig. 28. Stacking gives 2-plane directivity

sion line, the antenna impedance will match the line as follows: For a 180° angle, A should be equal to 0.16 wavelength. At 90°, A becomes 0.3 wavelength and at 60°, A will be 0.45 wavelength. For small angles, the impedance of the array becomes more difficult to match, regardless of how much A is increased. Very small angles produce a radiation pattern broken up into multiple lobes, successively decreasing in gain. To match a 72-ohm transmission line, the foregoing figures should be altered, as follows: For angles of 180°, 90°, and 60°, the correct values for A become 0.21, 0.35 and 0.5 wavelength, respectively. At any of the usual angles given above, smaller values of A decrease the impedance of the array, and larger values increase the impedance.

The value of H, the length of the elements forming the sides of the angle, is not critical, but should be held to a value not less than the overall length of the driven dipole. The elements forming the sides of the angle are not parasitic elements in the usual sense, since they are not tuned. The length L of the sides of the corner reflector is not critical as long as it is not less than 3 or 4 times the value of A. The sides can be carried out farther than this minimum value, but the slight improvement in pattern is not worth the increased size of the array with the attendant mechanical problems introduced.

Corner-reflector antennas, while admittedly more cumbersome, are capable of giving greater gain than the simpler parasitic arrays. Properly designed corner reflectors can be expected to give a power gain of 7 to 10 db, as compared to a single half-wave dipole. This means radiation in the desired direction 10 to 15 times greater than that afforded by a simple dipole. Referring to Fig. 29, it should be noted that the corner reflector antenna can be mounted vertically or horizontally. When mounted vertically the driven dipole can be used to good advantage as a coaxial antenna. If a vertical halfwave dipole is used instead of a vertical coaxial, the transmission line should be led horizontally from the center of the driven dipole to the vertex of the corner reflector, before it drops vertically to the transmitter or receiver.

Mobile Antennas:

As mentioned earlier, vertical antennas are particularly adapted to mobile installations. A quarter-wave whip is most frequently used. The method of installation on the vehicle is of great importance. A prime consideration is the use of maximum possible height. This is limited by the overhead clearances encountered in the area where the vehicles are required to operate.

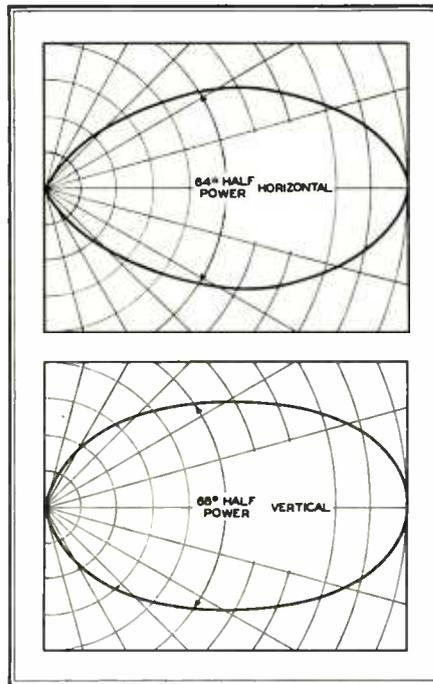

Fig. 29. Stacked array radiation patterns

The ideal location on a passenger car would be the center of the roof. In this position, the radiation pattern is most nearly non-directional. If such an installation is made in a station wagon or on a truck body where the roof is made of wood, it is necessary to sheath the under side of the roof with light copper sheeting or screening, securely bonded to the chas-

sis at several points. This, then, becomes a ground plane immediately below the whip antenna, such as would be provided by the metal roof of a passenger car.

Usually, to provide overhead clearance, the antenna must be mounted toward the rear of the car, somewhere near the rear mudguard. In this position, the radiated pattern is no longer non-directional. With a 30-mc. whip in the rear and at the left side of the car, it will be found that in most cases the greatest radiation and best reception will occur in a direction toward the right front corner of the car. In the 152- to 162-mc. band, the center of the roof is the most logical location for the whip. At these frequencies, the length of a quarter-wave whip is about 18 ins., presenting no overhead clearance problem.

Installation Notes:

The average antenna manufactured for mobile communication service today has a standing-wave ratio of less than 2. A great many will be found with a SWR of 1.5 or better. In order to maintain a good SWR for the system, the line must be terminated without a mismatch at the output end.

The SWR is the yardstick for measuring the impedance mismatch on a line. This is simply the ratio of the maximum RF voltage to the minimum RF voltage on a line. A standing wave ratio of 1.7 causes an efficiency loss of about 6%. An SWR of 2 causes 10% loss and SWR of 3 accounts for roughly 25% of the total power. For this reason, precautions should be taken when joining the transmission line to the antenna. Most important is the use of the proper adapter.

Every manufacturer has a set of adapters for his antennas to match practically any transmission line available. When ordering an antenna, it is wise to specify the transmission line to be used, as well as the operating frequency.

Mechanical Considerations:

Obviously, all ferrous materials, unless heavily plated, should be ruled out for use in the construction of antenna arrays because of rust. Brass is easy to fabricate, withstands corrosion, and can be sweated for maximum electrical contact. Unfortunately, brass is a relatively heavy metal, and imposes a correspondingly heavier load on the array and on the supporting structure. Aluminum and its alloys are ideal because of their light weight. However, they are subject to corrosion from salt water and some acids. If this condition is encountered in the locality where an aluminum antenna or array is contemplated, certain precautions must be taken.

Aluminum corrosion is largely self-inhibiting. That is, as corrosion attacks

the aluminum surface, a scale or oxide is formed which progressively halts further corrosion. This is true on an unbroken surface, but does not hold true where joints occur. Here, in severe cases, moisture finds its way into the joint and freezes the connection. This, together with the corrosion, expands the outer member of the joint and eventually weakens it, causing poor electrical contact.

This can be overcome by using vinylite sleeving or tape wrapped tightly over the joint, or by the application of some of the so-called stripping plastics used so successfully during the war to protect metal parts in ocean shipment. Where conditions necessitate this treatment, it is still worth the effort to take advantage of the lightweight, high-strength aluminum alloys.

The dead weight of the antenna or array is not the only factor to be considered. When high winds deflect an antenna, the moving mass of the system produces inertia effects that are proportional to the mass. Since windage increases with the exposed area of the elements, it is advantageous to keep the cross-section of the elements low. If the required strength can be realized in a given cross-section, it is wise to select the material that will give this strength with a minimum of weight.

Another important consideration is ice loading. In sections where this condition is likely to occur with some severity,

it will be wise to decide on a vertical rather than horizontal antenna. This might not be the best choice from a radiation standpoint, but mechanically it would mean that heavily-iced vertical elements would be subjected to compression or tension loads which are much more readily carried than the bending loads imposed by the same weight of ice on horizontal elements.

Transmission Lines:

In most cases it is possible to use solid dielectric line for the fixed transmitters. Solid dielectric line presents no problems in antenna erection, since the cable is flexible. There are standard constant-impedance connectors readily available. Costs are much in favor of solid dielectric line, since there are no maintenance problems. There is no pressurization required, and no moisture problems, providing the connectors are installed properly.

The standard AN connector, Fig. 31, comprises a coupling ring *a*, the connector shell *b* with holes *c* for soldering to the cable shield *d*, while *e*, indicates the insulated center-pin to which the cable wire *f* is soldered. In Fig. 32, the coupling ring 3 is pushed back to show the soldering points for the cable shield at 2. The wire is soldered at 1 to the pin.

The eight steps for putting a connector on a cable are shown in Figs. 33 to 40. First, the vinyl jacket, shield, and inner insulation are cut, Fig. 33, and removed



Fig. 31. Cross-section of cable and connector; with the coupling ring pushed back



Fig. 32. Be sure that the coupling ring 3 is in place on the cable before the connector shell is soldered to the cable

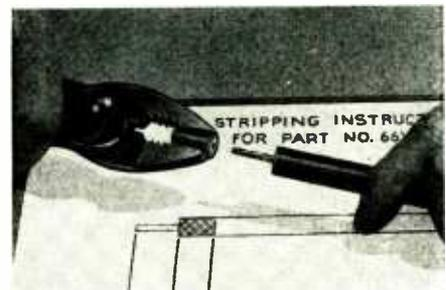

Fig. 34. Remove the insulation and shield

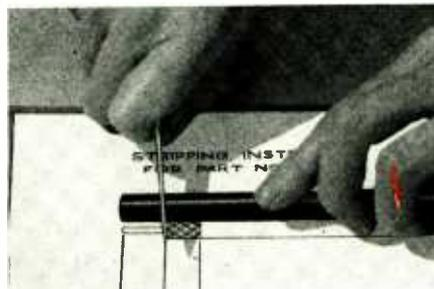

Fig. 33. Cut through to the center wire

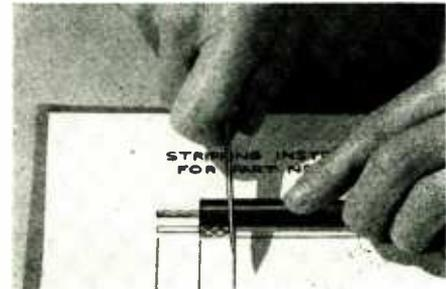

Fig. 35. Cut the outer vinyl jacket only

with pliers, Fig. 34, leaving the center wire, indicated as *f* in Fig. 31. Then the jacket is cut, Fig. 35, taking care not to cut into the shield. The jacket is removed by slitting lengthwise, as in Fig. 36.

At this point, the coupling ring is slipped on the cable, Fig. 37, and the shell screwed onto the jacket, Fig. 38. This brings the soldering holes in the shell over the cable shield, as shown in Fig. 31. Finally, the shield and wire are soldered as in Figs. 39 and 40, and the coupling ring is screwed onto the shell.

It may simplify the soldering to tin the cable and wire before the ring and shell are put in place. Of course, rosin-core solder must be used. Any other kind of flux will cause trouble. Since the thermoplastic insulation softens at 190° F., the soldering should be done quickly, so that the heat will be confined as much as possible to the joint.

It is recommended that the connectors be taped and varnished after insulation to prevent tarnishing. While tarnishing is not harmful in itself, it has been found that tarnished silver connectors are often difficult to remove.

Whenever it is necessary to use very long lines, air dielectric is usually advis-

able to prevent excessive attenuation. As there are many installations in which it is required, some general instructions for handling it are given in the following section.

Air-Dielectric Lines:

Continued trouble-free operation of an antenna system can be expected only if it is properly constructed and installed. Therefore, it is recommended that the installation be undertaken only by those thoroughly qualified to do the work.

The routing of the transmission line from the transmitter to the antenna should be planned in detail, and sketches should be made to show the finished appearance of the line. Only after dimensions are determined and plans completely made should construction begin.

To secure good soldered joints and to speed up the soldering operation, it is recommended that the outer conductor and connectors or other fittings be tinned and wiped free of excess solder before the joints are made.

Any flux or metal particles inside the line should be removed before joining the outer conductor pieces. All soldered joints should be cleaned thoroughly after soldering with a small brush, such as a toothbrush, and carbon tetrachloride. It is imperative that all joints and surfaces inside the line be scrupulously clean. After the line is cleaned, it should be inspected carefully for any foreign material inside the line, and for pinholes or other irregularities in the soldering on the outer surface of the line.

All joints must be bright and clean before soldering. No flux should be used after tinning and cleaning with carbon tetrachloride, for it may cause serious

trouble if it is allowed to run inside the cable. The outer conductor should be cut off so that the last bead is not more than 1/2 in. inside the end of the outer conductor. All burrs must be removed. The inner conductor is then cut so that it extends approximately 3/4 in. beyond the end of the outer conductor.

Using fine sandpaper or steel wool, the outer surface of the outer conductor must be cleaned back about 4 ins. Steel wool shavings or copper dust must not be allowed to enter the line. If a short portion of the outer conductor, beginning at the end and extending back 1/3 in. is taped so that it is left uncleaned, the solder will be prevented from entering. The outer coupler is then slipped over the end of the coaxial transmission line. The inner conductor adapter should be inserted in the end of each inner conductor and the two ends brought together and soldered. Silver solder is preferable for this operation. The outer coupler is brought into place and sweated, using soft solder. A blowtorch or Prestolite torch will be necessary for this operation. Care must be taken to heat the line and coupler uniformly.

The coaxial transmission line should be assembled as completely as possible in a horizontal position, following the plan sketches for the installation. This procedure greatly facilitates the assembly and inspection of the line, and makes it easier to secure strong, gas-tight soldered joints.

The line is usually filled with dry nitrogen and maintained above atmospheric pressure to prevent moisture-bearing air or water from entering the line. The nitrogen is not used for its dielectric properties, and has no effect upon the characteristics of the line. Dry air can be used in place of nitrogen.

It is advisable to test the line and fill it with nitrogen as soon as possible after assembly. Moisture contained in the air inside the line may condense on the ceramic beads or other surfaces and cause trouble unless the air inside the line is replaced with nitrogen quickly. Such condensation may occur when the temperature of the line drops, precipitating the moisture that the cooled air can no longer hold. Compressed air is commonly used to test the line for leakage. Nitrogen is preferable, but will be wasted if the line is not gas-tight. However, the use of nitrogen for testing is strongly recommended when the relative humidity is high.

If a permanent pressure gauge is not attached to the line, a tire pressure gauge can be used for testing and for periodic checking thereafter. An automobile tire pump is suitable for air-testing. A soap and water solution is useful for locating leaks.



Fig. 36. Split jacket but not the shield

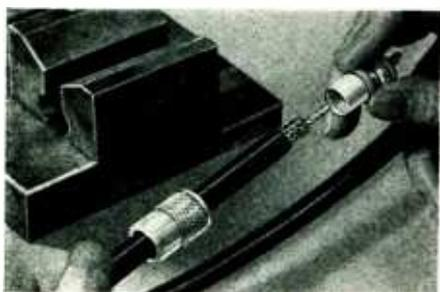

Fig. 37. Slip the shell on to the cable

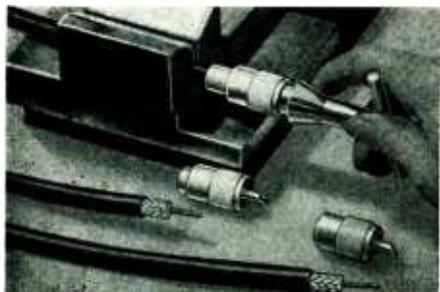

Fig. 38. Screw the shell, as Fig. 31 shows

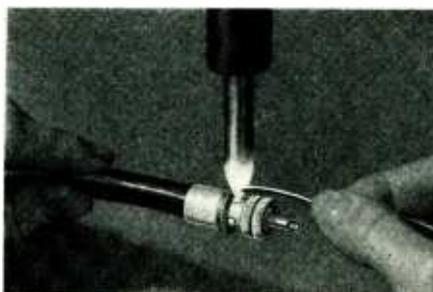

Fig. 39. Solder shell to the cable shield

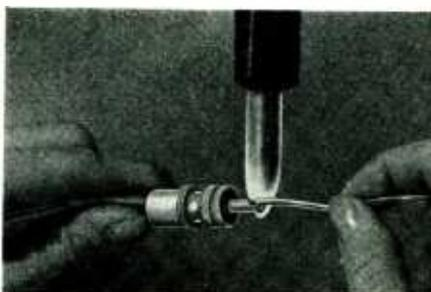

Fig. 40. Solder pin to the center wire

To test the line, a pump or nitrogen tank is connected to the transmitter gas fitting and the line filled. The fitting threads at the transmitter are tested first for leaks. The line is filled until 30 lbs. pressure is reached. End fittings and all joints are then observed for leaks. Full

30-lb. pressure should be maintained for at least 24 hrs., for changes in temperature cause some expansion and contraction in the line, and leaks may develop at weak spots.

If nitrogen is used to test the line, pressure should be reduced to 15 lbs. at

the end of the test. If air is used for testing, the line pressure should be reduced to zero at the end of the test, and then replaced with nitrogen or processed dry air. Line pressure must be kept above atmospheric pressure at all times to prevent intake of moisture-bearing air.

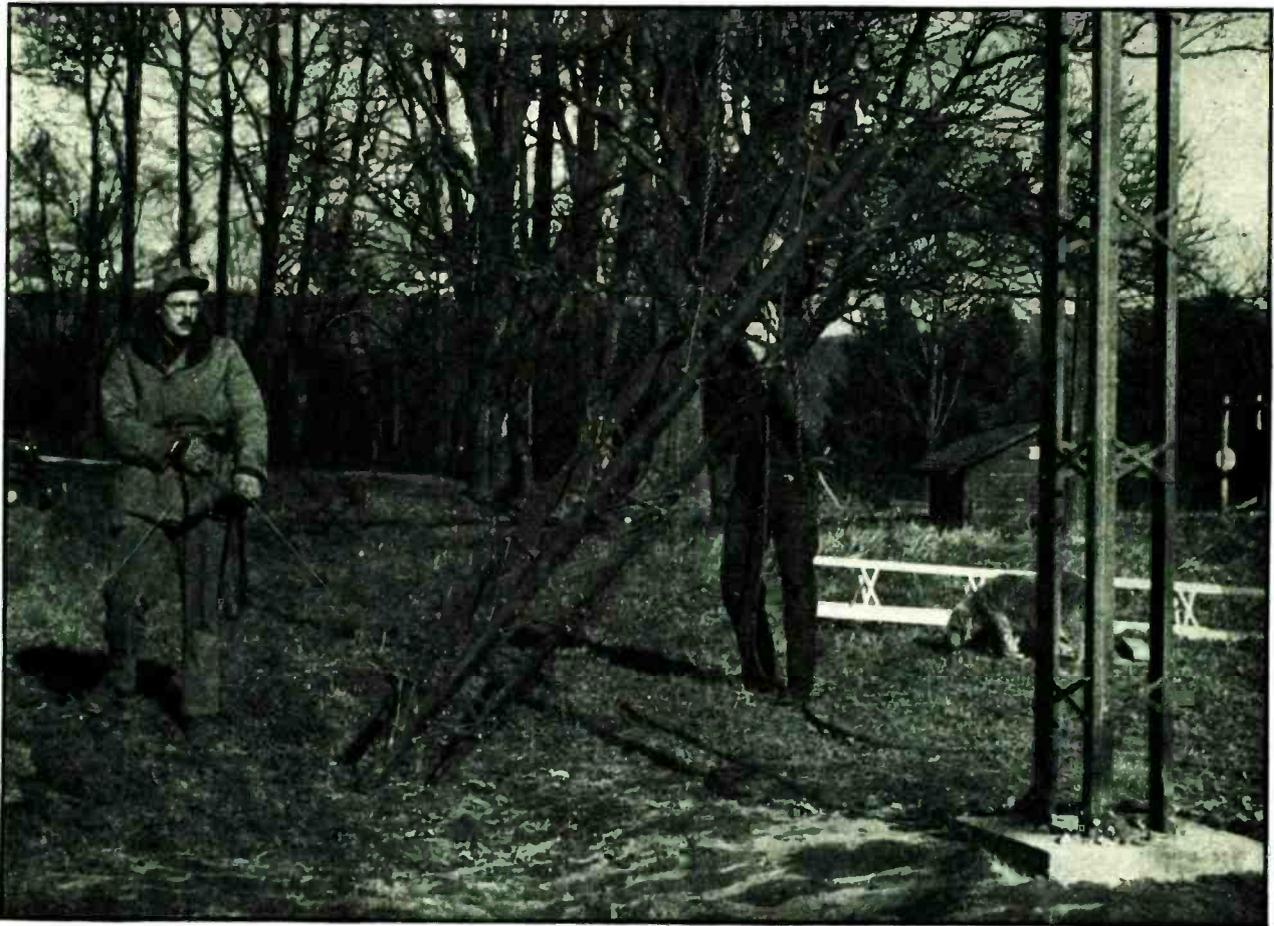

Fig. 1. Hoisting rope is attached just above middle of mast section. Small line steadies section on way up

CHAPTER 8: TOWER ERECTION

DETAILED, STEP-BY-STEP INSTRUCTIONS WITH PROGRESSIVE PHOTOGRAPHS SHOWING HOW TO ERECT A TYPICAL 105-FT. STEEL GUYED ANTENNA TOWER

VARIOUS types of towers are used for main-station transmitters and relays. Some are of self-supporting, fabricated design. Others are guyed types, either of pipe or fabricated steel. The final choice is determined by the particular circumstances at each installation.

Selecting the Tower Design:

In a location where the spread of guy wires cannot be accommodated, the self-supporting tower is a practical solution, provided means are available for anchoring the base. Such towers are erected on the roofs of buildings, for example, if the area is too small for guy wires to be used, or in built-up sections where existing buildings would interfere with wires and anchors.

Self-supporting towers are generally more expensive than guyed types. This applies both to the tower and the foundation. The latter is not an important item when the tower is located on the ground, with a poured concrete foundation. On a roof, however, elaborate construction may be required for the base.

Sometimes it is necessary to reinforce the building itself. Also, consideration must be given to raising the steelwork from the ground to the roof. Engineering advice on such problems is available from the companies which supply the towers.

When plans are being made for a communications system to be operated from a control point in a business area, it may be less expensive to locate the transmitter at some distance away, where an open field is available. However, against that saving must be put the cost of wire service or a point-to-point radio circuit. It may be found that, after all, it will be cheaper to erect the antenna at the site of the control point, and better coverage of the service area may be obtained in this way.

As for guyed towers, the choice lies between the use of fabricated steel construction and seamless steel tubing. The tubing is more expensive, but the erection cost is about the same for the two designs. Structurally, steel pipe has the advantage of being able to carry a greater load, it can withstand higher wind

velocities, and is less affected by icing conditions. In communications work, where simple, vertical radiators are generally employed, the top-loading is too small to be an important factor. Thus, if local icing conditions are not serious, the choice between the two designs lies in the cost, weight, and the preference of the engineer in charge.

Erection of a Fabricated Tower:

As a rule, towers are erected by companies which specialize in this type of work. Their crews travel around the country from one job to another. They have all the tools and equipment necessary, and the men are experienced in all the tricks of their trade.

However, it is not difficult to put up a tower 100 to 200 ft. high if at least two men are available who are skilled in climbing. For the benefit of those who want to tackle such a project, details are presented here on the erection of a 105-ft. Wincharger tower, based on the experience of three GI's who had served in the U. S. Signal Corps.

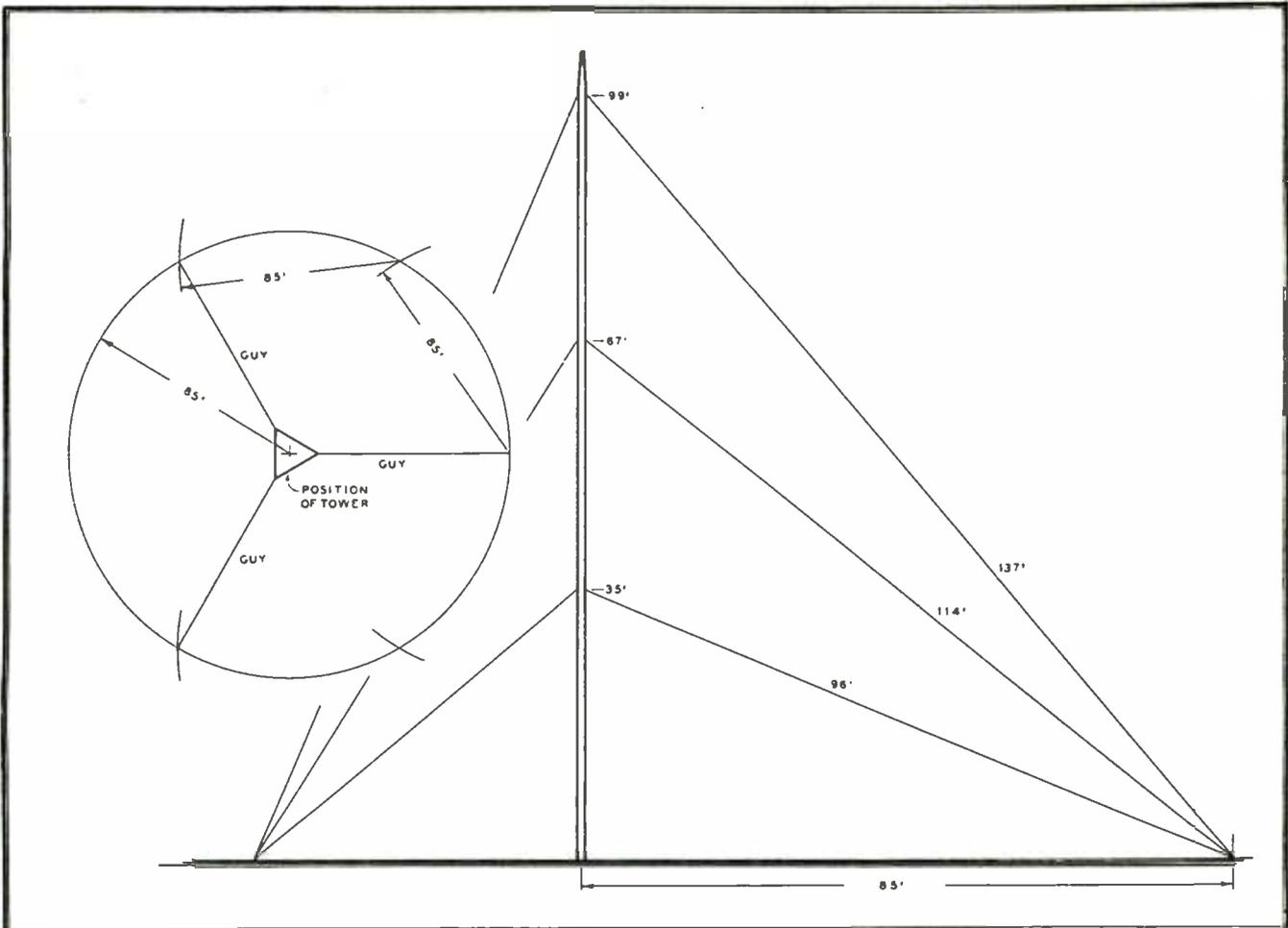
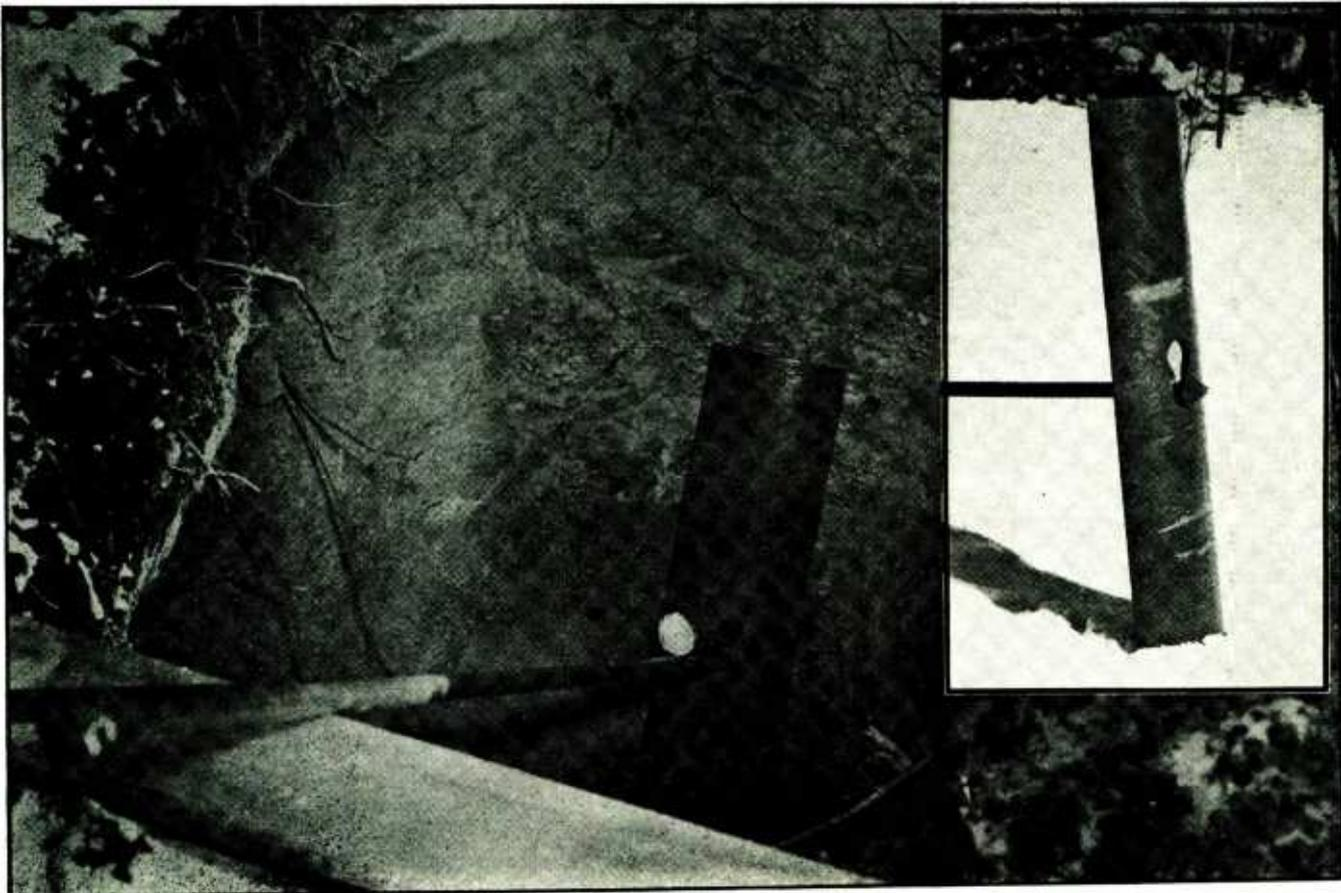

Fig. 2. Three sets of guy wires are required, spaced 120° apart on a radius of 85 ft., as this sketch shows

Fig. 3, below. The anchor ready to be buried, with a board holding the rod at an angle of 45° . Note use of wooden plug



As shipped from the factory, the parts have the appearance of an over-grown Erector set. The 10-ft. leg sections are in bundles. Turnbuckles, rods, and plates are neatly tied together, accompanied by coils of wire and a wooden case containing cross-braces and cloth bags of nuts, bolts, and other hardware. All the parts are cut to size, and the holes drilled, thus eliminating all machine work on the job.

Laying out the Base & Anchors:

Fig. 2 gives the plan of the base and guy anchors. There are 3 of the latter, on an 85-ft. radius. A circle of that size covers considerable ground but, equipped with two sticks separated by 85 ft. of wire (string stretches enough to introduce considerable error) we arrived at a location for the base that brought the anchors within the space available. The position of the first anchor was set in the direction of the prevailing wind.

From that point, we spaced off an 85-ft. segment, and from that point another segment, as indicated in Fig. 2. There we drove a stake into the ground to mark the second anchor.

Starting from the first anchor in the opposite direction, we located the third point by the same method. Then, to be sure we were right, we checked the distance between stakes for the second and third anchors by measuring off two segments again. Since that measurement checked within a few inches, we knew we were right.

Anchors for the Guy Wire:

The guy anchors, Fig. 3, each consisted of a rod and anchor plate. As the insert shows, there is a shoulder on the end of the rod which holds against a slot in the plate. To make sure that the rod could not slip out of the slot, we drove a stick into the hole. This can be seen in Fig. 3.

Holes for the anchors were dug about 5-ft. deep, with the side toward the tower slanting down at about 45°.

The anchors must set at a 45° angle. Therefore, as Fig. 3 shows, we checked the angle by means of the level and 45° head on a machinist's square, and then propped the rod with a board to keep it in place. It is not necessary to do so but, when concrete was poured for the base, we poured a generous amount of concrete on each anchor before the dirt was thrown back.

Construction of the Base:

The form for the base, Fig. 11, was made from second-hand lumber. After the hole had been dug for the base, and the form fitted squarely in place, we threw in dirt around the form. Otherwise, when the concrete was poured in, the form would have floated up, and the concrete would have run out around the bottom.



Fig. 4. Two assembled sections of the tower, ready for the first coat of paint

Fig. 5. Close-up of a tower section, showing the cross braces bolted to the legs

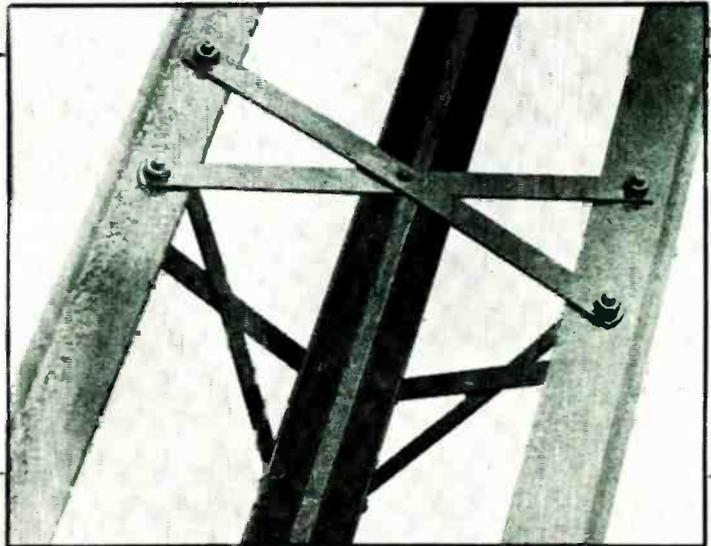

Fig. 6, below. This section carries three saddles to which the guy wires will be fastened



Three and one-half cubic yards of concrete were used for the base and to cover the guy anchors. The day the concrete was poured, the temperature was below zero. It would have been more expensive, if not impossible, to mix the concrete by hand. However, the mixer tank had been filled with hot water, and we covered the base with burlap sacks to hold in the heat as soon as the base plate was in position.

Figs. 8 and 12 show the base plate assembly. This includes one large and two small angles to hold each tower leg, plus the three 12-in. anchor bolts. The latter are held in place with nuts below and above the base plate. As soon as the concrete had been poured, we pushed the anchor bolts into the concrete, first making certain that the leg angles were accurately lined up with the guy rods. This is important! The base plate tended to sink into the concrete. Accordingly, we placed a pipe over the base, and wired the angles to the pipe as soon as the base plate had been trued carefully with a level. This rig can be seen in Fig. 10. Thus, the base plate was kept true while the concrete hardened.

Most of the form for the base stayed in the ground. After the concrete hardened, we just knocked off the upper part before we finished leveling the dirt around the base.

Tower Section Assembly:

While that work was going on, the tower sections were assembled and painted. The legs and braces were already galvanized, but it is necessary to put a preliminary coat on any galvanized surface so that the paint will stick. We used a 50%



Fig. 7. Pouring concrete into the form for the base of the tower

vinegar solution, brushing it on the legs and dipping the braces into it. It was so cold that the solution froze on the legs. That may have been the reason why the paint did not stick as well as we expected, or perhaps the trouble was with the wartime quality of the paint.

Another time, we would substitute for vinegar the following solution, also recommended by Wincharger: 2 oz. copper chloride, 2 oz. copper nitrate, 2 oz. sal ammoniac, 2 oz. muriatic acid, and 1 gal. of water. This solution must be allowed to dry for 10 hours. After application, it turns the galvanizing black, then dull gray.

Figs. 4, 5, and 6 give detailed views of the 10-ft. tower sections. The assembly was easy, for the cross-braces come with a rivet at the center which sets the exact angle. Bolts 5/16-in. by 3/4-in. are used for this purpose, with nuts and lock washers. The nuts must be on the outside. Each section was tagged with a number as it was put together, for reasons which will appear later.

The 4th, 7th, and 10th sections were fitted with guy attachment saddles, held in place by 5/16 by 1-in. bolts which also pass through the cross braces. Fig. 2 shows where the saddles must come. When they are fastened in place, the eyes

Fig. 8. The assembled base plate and anchor bolts, ready to put in place



Fig. 9. CAA tower paint sections

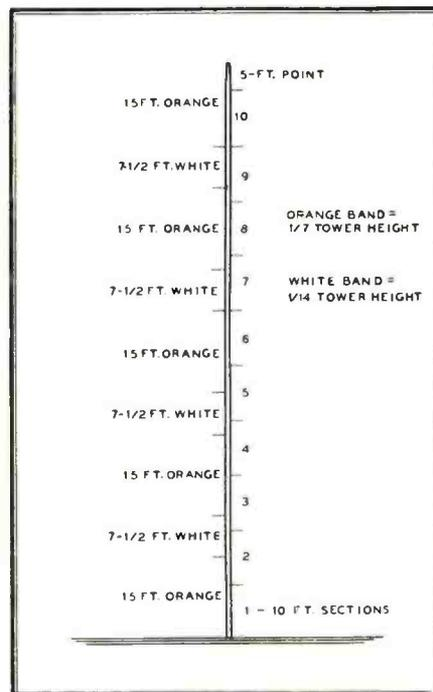



Fig. 10. The base plate levelled and trussed up in the fresh concrete

which take the guys must, of course, point down, or toward the expanded ends of the legs.

Painting the Tower Sections:

The paint job was started as soon as the sections were assembled.

All parts, including the angle strips that are attached at the joints between sections, were given a coat of red priming paint. Then came the outside coat of international orange or white. Fig. 9 shows the length of these alternate bands, in accordance with CAA requirements.

We had to watch the number tags on the sections carefully, as some sections

were partly white and partly orange.

We had some difficulty getting actual international orange, since all paint companies do not make it, but our persistence was rewarded in the end.

Erecting the Sections:

When the paint was dry, the real work of putting up the tower began. First, we put sections 1 and 2 together on the ground. This was just a matter of slipping the expanded ends of the legs of one section over the straight ends of the legs on the second section. Then we secured the joints with two $\frac{3}{8}$ by 1-in. bolts on the outside, and two $\frac{5}{16}$ by $\frac{3}{4}$ -in. bolts

on each side. In addition, one of each of the latter also holds one end of the angle strip braces. These are shown in Fig. 13.

The expanded ends of the legs are always the bottom of a section. Fig. 12 shows this. The sections are so light that we had no difficulty in raising the first two sections in the same way that one would raise a ladder. When they were bolted to the base plate, as in Fig. 12, we ran ropes to the three guy anchors so as to brace them while we put up the 3rd section and the 4th, which is the first to take guy wires.

Fig. 13 shows how the sections were raised, and Fig. 1 shows a section ready to leave the ground. For a gin pole, we used the 16-ft. length of $1\frac{1}{4}$ -in. galvanized iron pipe which, later, became the mast carrying the antenna. A local blacksmith fashioned an iron hook for us in the shape of a long S. This was used to hold the gin pole at the bottom. The upper hook of the S was put over the middle cross brace of the top section, and the lower hook was inserted in the pipe. Then, with ropes, we tied the gin pole to the braces, as Fig. 13 shows. A second, similar hook held the pulley block at the top of the gin pole. This arrangement proved entirely satisfactory, for the pipe carried the load of successive sections without difficulty.

Because the top of the gin pole was hardly more than 10 ft. above the top of the tower, we tied the rope just above the center of the section to be raised, as in Figs. 1 and 13. In addition, we put a light line on the bottom of the section to guide it on the way up.

Bringing a section into line at the top of the tower was a one-man job, but it re-

Fig. 11. Details and dimensions of the concrete base for the tower

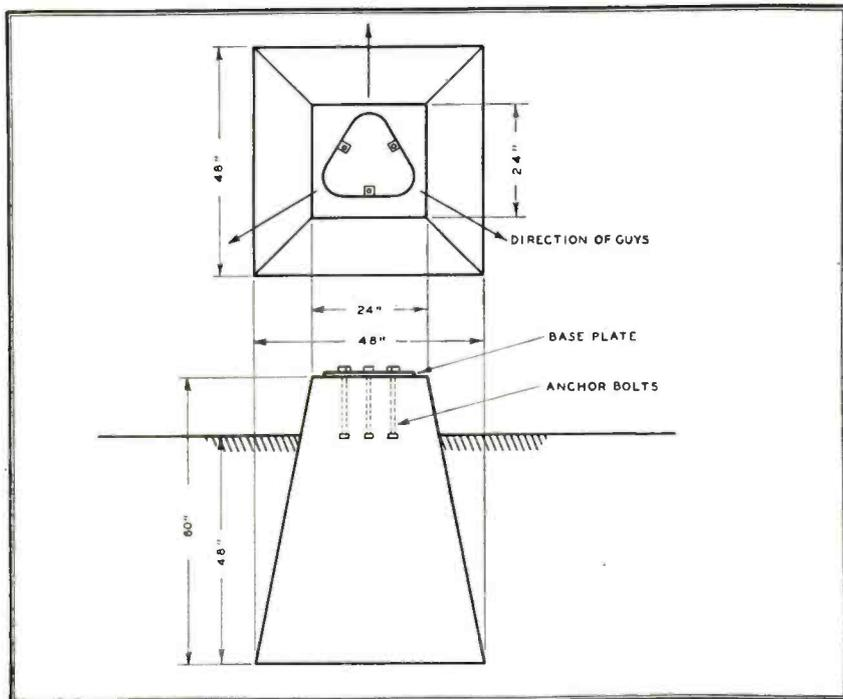
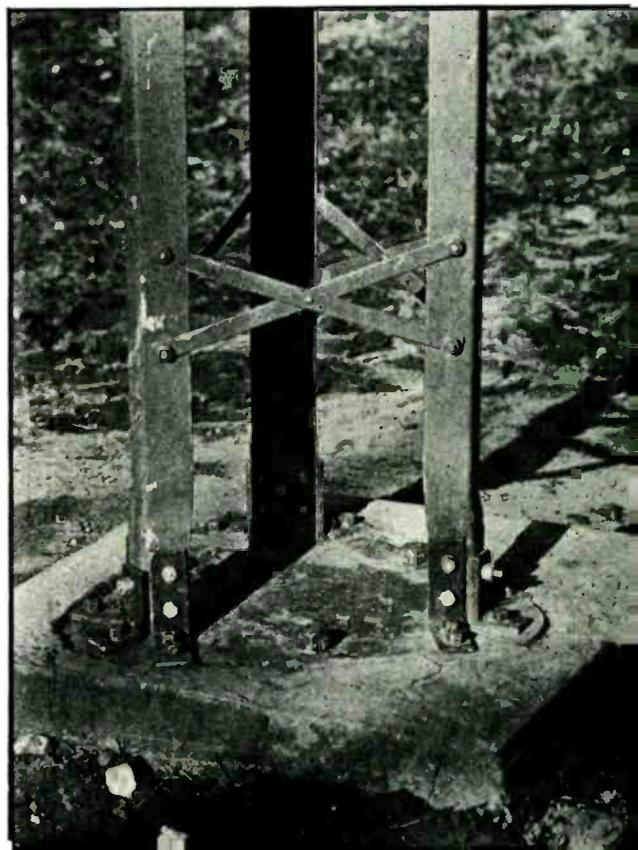
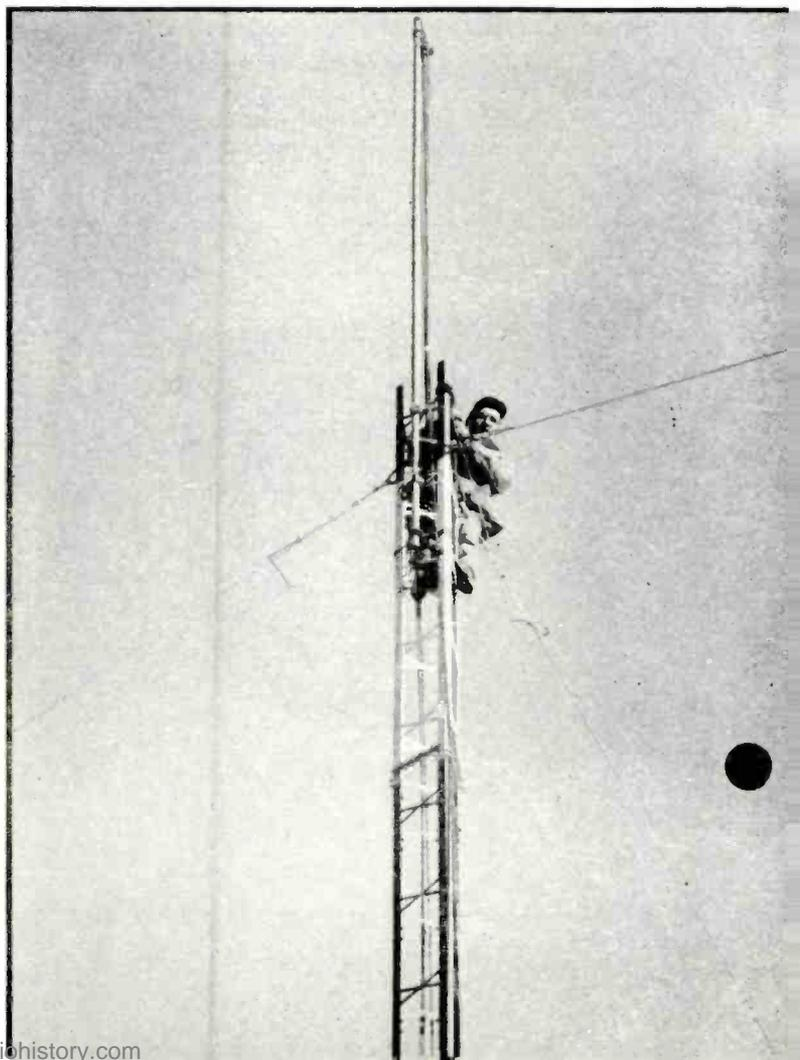
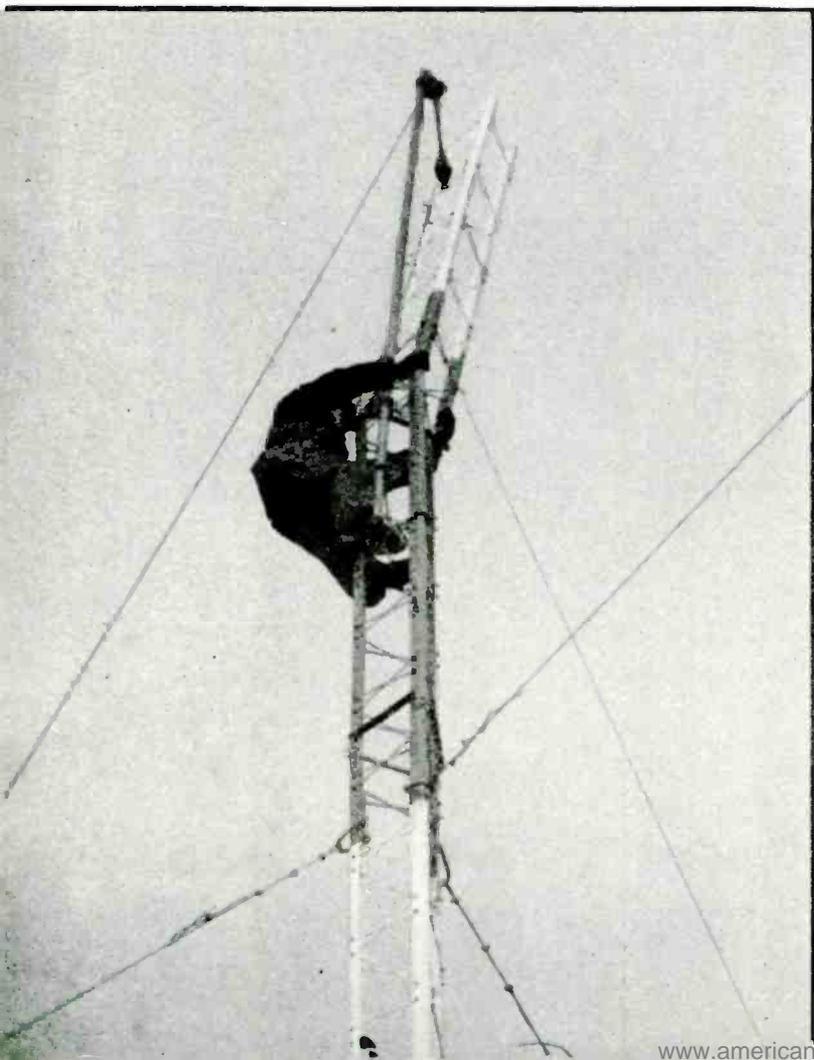
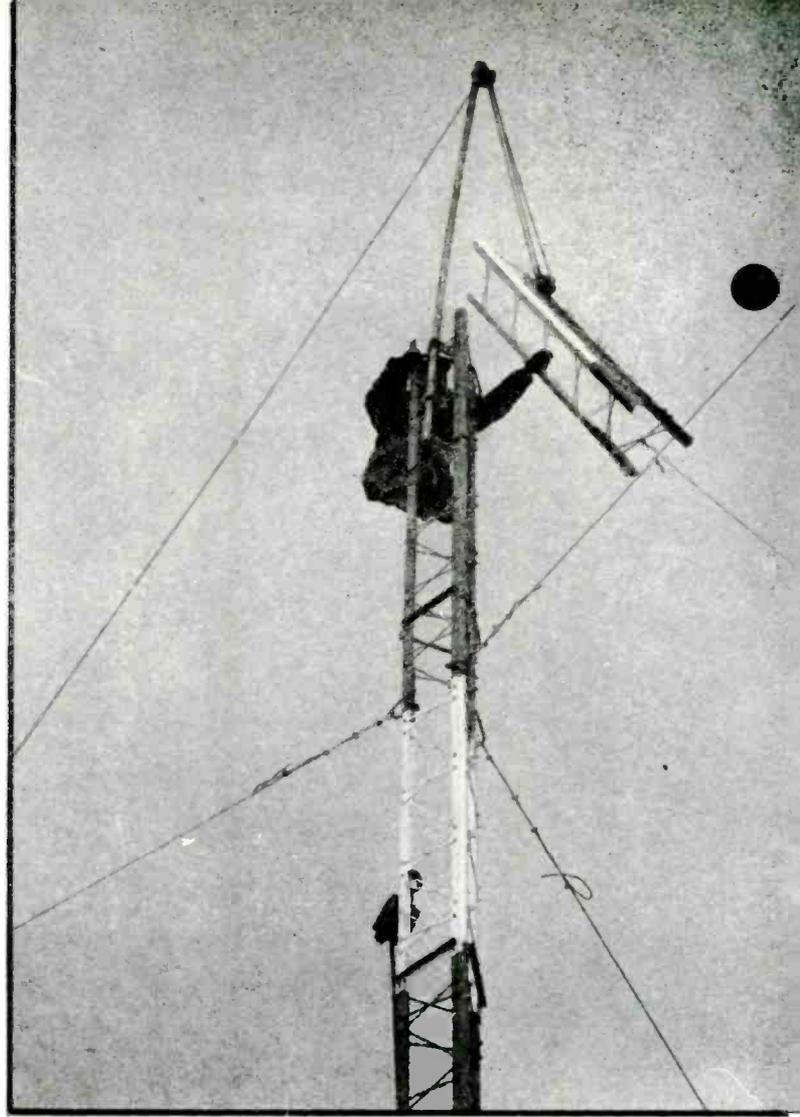

Fig. 12. The base and tower footing





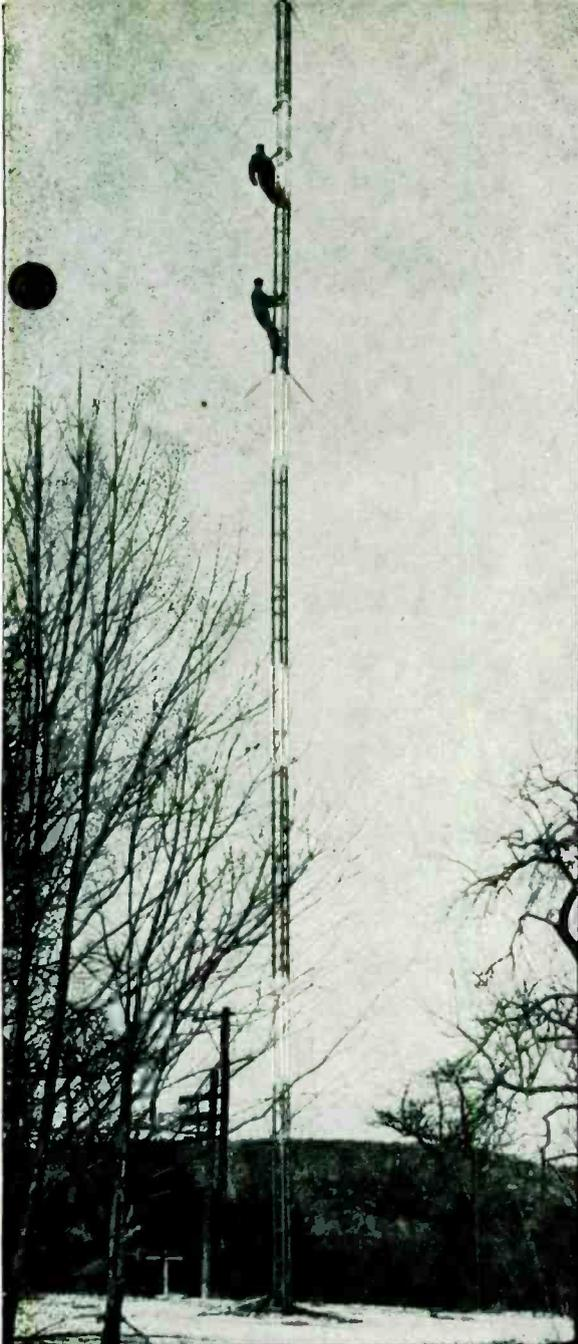

Fig. 14. The tower at 100 ft., all ready for the pointed section

quired the assistance of the men on the ground who held the main rope and the light line. Since the gin pole could be bent slightly by the pull on the rope, the man who held it moved around, under directions from the man on the tower, until the new section could be brought in exact alignment and settled down into place.

A long, tapered pin proved most useful in lining up the holes for the first bolts to be inserted. Once the first bolt was in place, the next two could be fitted easily. Then the rest slid right in, because the holes had been punched in the legs with great accuracy.

As each section was bolted in place, the gin pole was raised and fastened again, ready for the next section. The use of

Fig. 13. Left, Four views showing how the tower sections were hoisted and then set in place

the pipe instead of a wooden pole proved advantageous because the pipe was much lighter and, therefore, easier to handle.

Fastening the Cables:

We found that the amount of cable supplied gave us plenty of extra length, although we were careful not to be extravagant. We cut the cable only as it was needed, so that it wouldn't become tangled on the ground. Fig. 2 shows the actual length of each of the guys. Cables were attached to the tower first, held by the clamps visible in Fig. 13. Later, the ends were cut off and taped to give them a neat appearance.

The eyes of the anchor rods are designed to take three clevises which hold the turnbuckles, and the turnbuckles are equipped with thimbles to relieve the guy wires running up to the tower.

Four clips, tightened by nuts, were supplied to clamp each wire after it was run through the thimble.

At the tower, we put a thimble on each guy saddle, to take the wire, and four more clips secured the loop.

Before we pulled the wires tight, we opened the turnbuckles all the way. That left us the maximum amount to tighten the wires, and to take up any subsequent stretch. Since we didn't have a cable stretcher to tighten the wires, we used a block and tackle arrangement which, though rather crude, did the job satisfactorily.

As each set of guys was put on, we checked the tower with a plumb bob dropped down the center. That was easier than if we had left this step until the tower was completed. Wincharger specifications call for a tension of 200 to 250 lbs. on each guy wire. They make a ten-

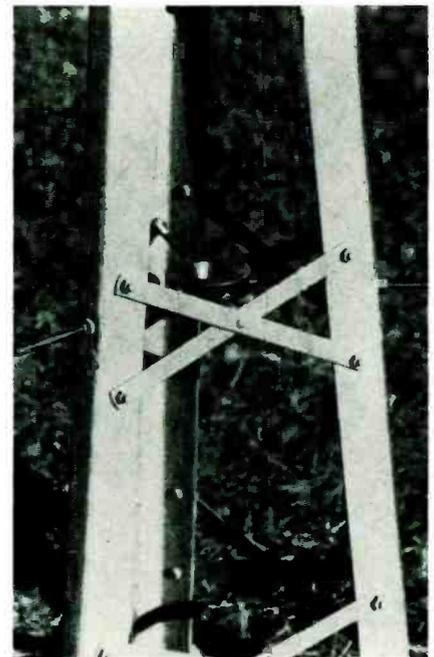

Fig. 16. Lower support for the mast

sioning device that determines and maintains the proper tension. These devices are inserted in one set of guys. Thus, when all the guys have been adjusted to make the tower perpendicular and the load on the set of guys containing the adjusting devices is correct, the load on each is correct and distributed evenly.

Special Notes:

Here is an important word of warning to others who may erect similar towers: Don't go up the tower without a safety belt, and be sure the belt you use is in good condition.

Some of the people who watched the progress of the tower were amazed at the strength of unguyed sections. Even with



Fig. 15. The final arrangement of the guy wires and turnbuckles

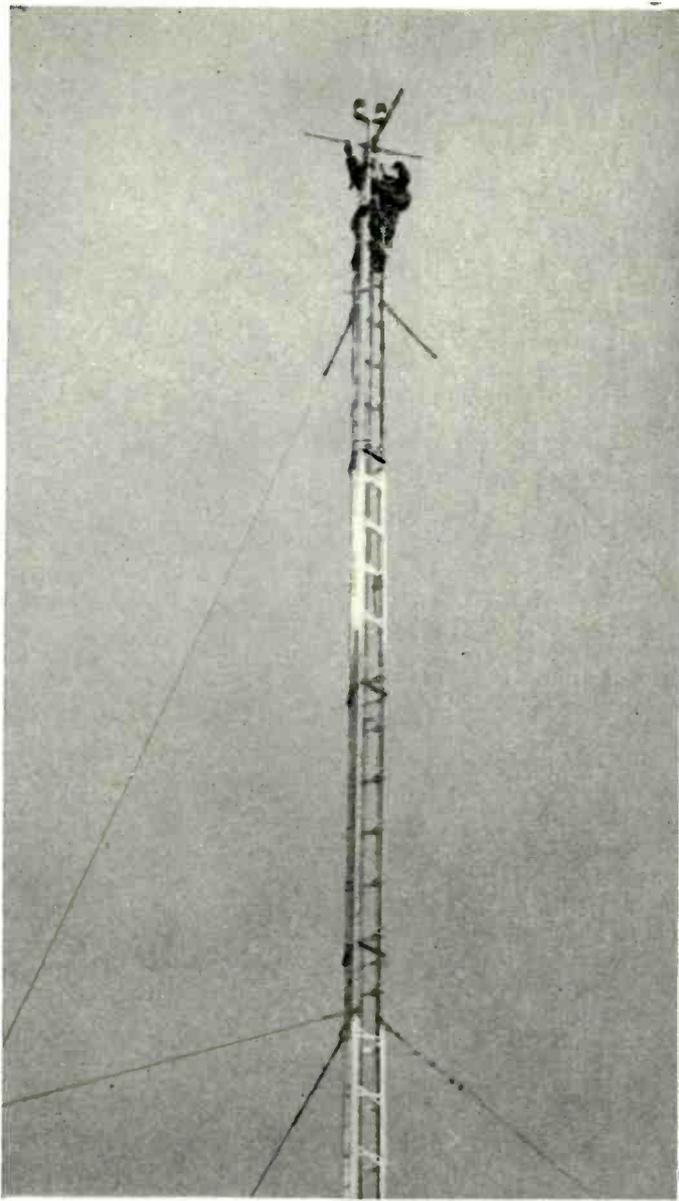

Fig. 17, above. The mount of the mast permits it to be lowered for attaching antenna rigs, or for changing the lights. This has proved to be a very satisfactory arrangement.

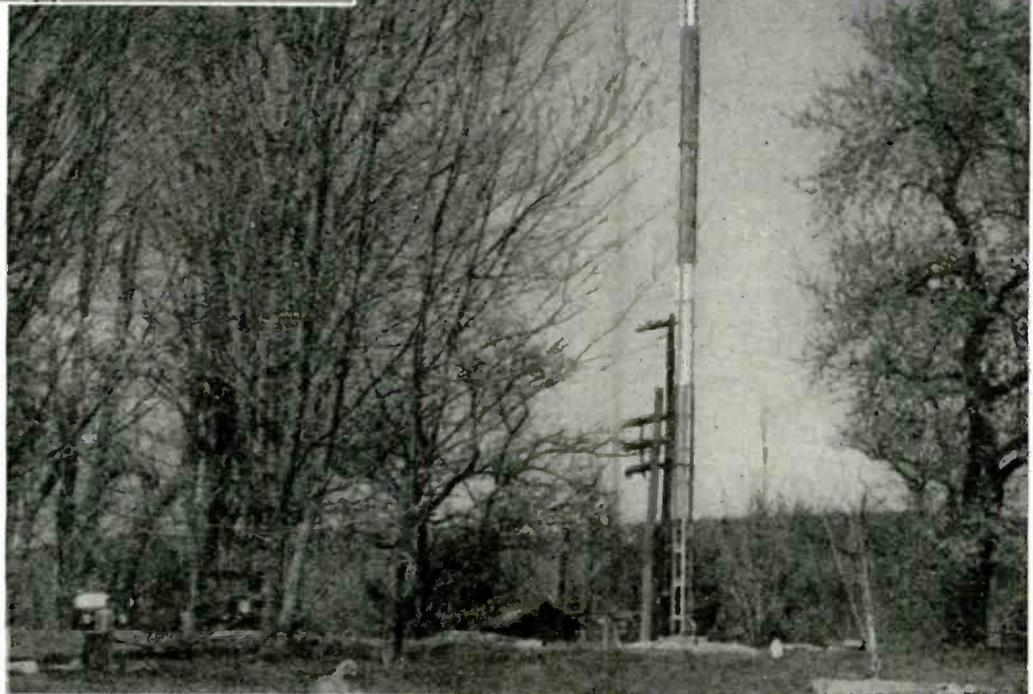

Fig. 18, right. The completed tower, with the mast up and the antenna mounted.

three men up, the tower was firm and steady despite strong winds. After the 4th section was put in place and guyed,

we went right on with the erection of the 5th, 6th, and 7th sections without any temporary gnys. Then, with the 7th sec-

tion in place, the second set of guys were put on. The same procedure was carried out above the 7th section. No further

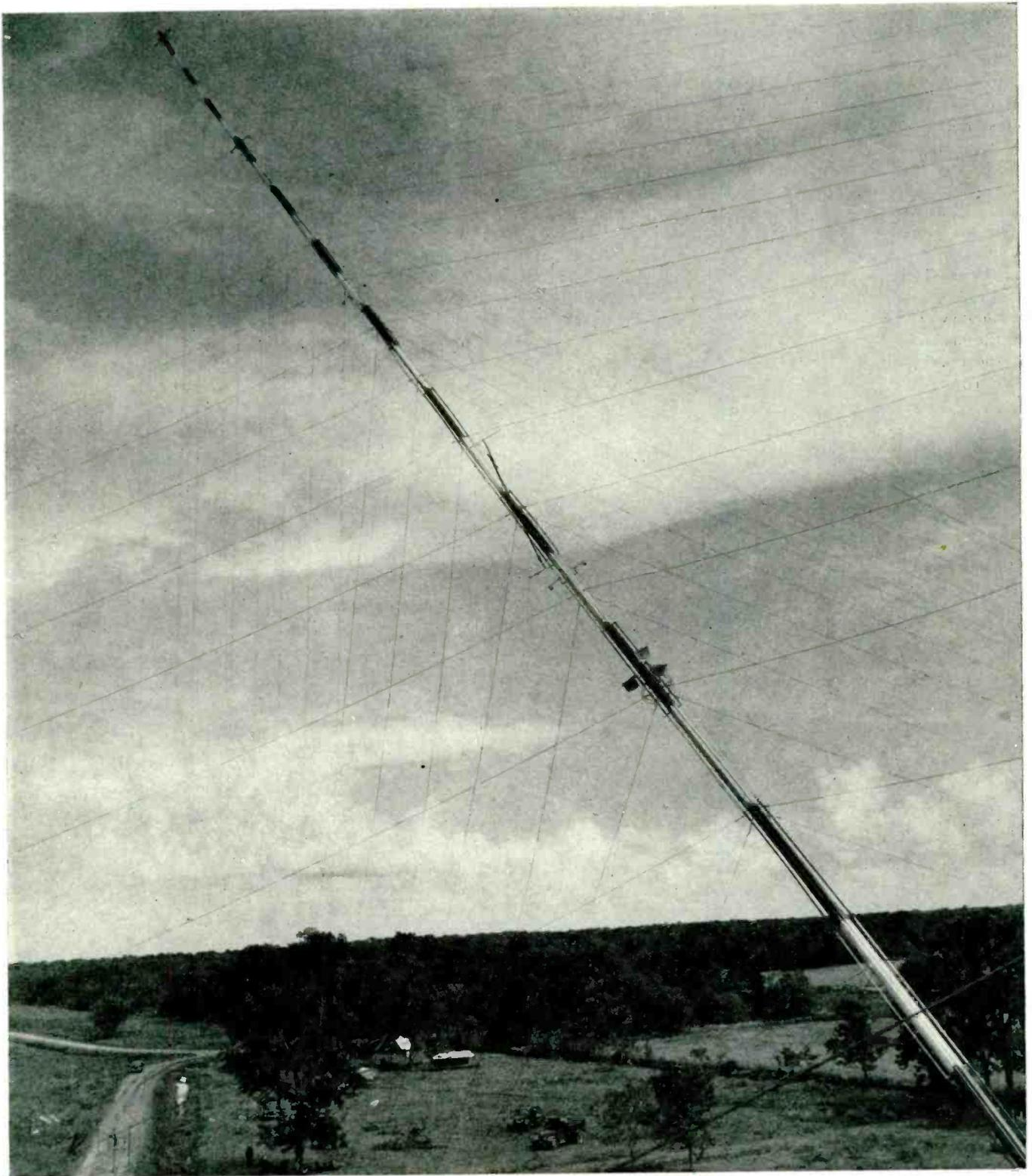

Fig. 19. This unusual picture shows a 500-ft. steel pipe mast being erected in one piece. Guys at right are secured to a boom

guys were needed until the 10th section was up.

Final Paint Job:

After the tower was completed, we realized that we had made a mistake in giving the individual sections their second coat of paint in the beginning. It would have been smarter to give them only the first coat because, with all the

climbing up and down that was done during erection, a considerable amount of paint was scraped off. Consequently, we had to put on another coat afterward.

The final coat was put on by two men, working opposite each other. That is much faster and easier than for one man.

Insurance Is Important:

The Wincharger tower described here is

the standard design used for hundreds of police transmitters and other communications purposes. The factors of safety are very high in this type of design and, as far as we have been able to learn, none of these towers has ever failed from ice loads or wind storms. However, it is wise to be protected against public liability by insurance, for in crowded areas the tower could cause much damage.

Guyed Pipe Towers:

Unlike fabricated towers, those assembled from sections of pipe are generally put together on the ground, and raised in one piece. Four sets of guys are used. One set is anchored to a boom at the foot of the tower and at right angles to it. Two opposite sets, at the sides, keep the tower steady on its way up, and the fourth set is manned by a ground crew. As a donkey engine pulls the boom down and the mast up, the ground crew pays out the opposite guy wires, and snubs them temporarily as the tower comes

into a vertical position. This is a relatively simple operation for towers of average height, if the work is performed by experienced riggers.

The antenna mast shown on its way up in Fig 19 is remarkable in that it is 500 ft. long, made of steel pipe such as is used in the oil fields. In fact, this is one of several similar installations in a system using Link Radio equipment, operated by the West Production Corporation of Texas. This particular tower is at Thompson, 40 miles south of Houston.

As the picture shows, all the wires, fittings, lights, and both the 31.54-mc. com-

munications antenna and 70-mc. relay antennas were assembled on the ground. Very few riggers have the experience to handle this kind of a job, but it can be done if ground space is available. However, it is a relatively easy matter to put up an assembled pipe mast of 200 or 250 ft.

The relay antennas can be seen at a point about one-third of the way up the mast. This is for communication with the headquarters office at Houston. Eventually, they will be replaced with bomb-type microwave antennas.

SYMBOLS INDICATING TRANSMITTER EMISSION

AMPLITUDE MODULATION

Absence of any modulation.....	40
Telegraphy, by carrier keying (no audio modulation)	41
Telegraphy, by keying a modulating audio frequency or by keying a modulated carrier	42
Telephony	
Double sideband, full carrier .	43
Single sideband, reduced carrier	43a
Two independent sidebands, reduced carrier	43b
Facsimile	44
Television	45
Composite transmissions	
Cases not covered by categories above	49

With reduced carrier49c

FREQUENCY AND PHASE MODULATION

Absence of any modulation.....	F0
Telegraphy, by frequency-shift keying (no audio modulation)	F1
Telegraphy, by keying a modulating audio frequency or by keying a modulated carrier ..	F2
Telephony	F3
Facsimile	F4
Television	F5
Composite transmissions and cases not covered by categories above	F9

PULSE MODULATION

Absence of any modulation	P0
Telegraphy, no audio modulation	P1
Telegraphy	
Audio frequency modulating pulse amplitude	P2d
Audio frequency modulating pulse width	P2e
Audio frequency modulating pulse position	P2f
Telephony	
Amplitude-modulated pulse ..	P3d
Width-modulated pulse	P3e
Position-modulated pulse	P3f
Composite transmissions and cases not covered by categories above	P9

CHAPTER 9: RADIO RELAY SYSTEMS

LINK AND RELAY APPLICATIONS OF POINT-TO-POINT SYSTEMS, METHODS OF MULTIPLEXING, AND COST-PER-MILE FIGURES FOR RELAYS AND WIRE LINES

IN many countries outside the USA, FM radio relays offer a practical means for extending communications circuits to communities and areas where new wire circuits cannot be run because of copper shortages, lack of production, mountainous or wooded terrain, or high costs. In our own country, although we have a highly integrated wire and cable system, radio relays offer an attractive solution to the physical and financial problems of additional facilities, transmission over geographical barriers, or more economical or reliable circuits.

Relays Go Where Wires Can't:

The most obvious use for fixed radio services is as a substitute for or extension to telephone lines. The use of radio in providing economical public communication where it cannot be established by wire facilities is steadily increasing all over the world to an extent that is not generally realized. Radio very often can bring outside communication to whole communities where the cost of erecting and maintaining wire lines prohibit their installation. Natural barriers such as rivers, bays, lakes, and swamps can be easily spanned by radio.

Many other less obvious uses for fixed radio circuits are very much in the public interest. Among these are point-to-point circuits for oil and gas pipe lines and public utilities to handle the multiplex transmission of supervisory controls, load controls, telemetering, and voice, teletype and facsimile services. Another interesting example is the 150-mc. relay system recently installed over the entire length of the island of Cuba, about 750 miles, to handle the network operation of a series of broadcast stations.

Modulation Methods:

Two different forms of radio communication can be used for point-to-point and relay systems. These are frequency or phase modulation, and pulse modulation. The former can be applied successfully at any frequency, but the latter must usually be used at microwave frequencies because of its wide bandwidth requirements.

Although the VHF and lower UHF frequencies are quite crowded in the United States, and frequency assignments for fixed and relay systems difficult to obtain, the same situation does not exist in most other countries. In most applications, the use of VHF or the lower UHF

frequencies permits large savings in initial cost and maintenance as compared to microwaves.

Any of the various forms of pulse modulation, on the other hand, is comparatively wasteful of radio frequency spectrum, and must be confined to higher frequencies where broadband operation is permissible at present. Past history has shown that, as the higher frequencies are utilized more and more, there will be heavy pressure to make more economical utilization of the radio frequency spectrum than is accomplished with pulse

in either case is called multiplexing, but the methods used fall into the two general classes of time-division and frequency-division multiplexing.

In the former, the various signals to be transmitted are sent sequentially, so that only one of the channels uses the transmission medium at a time. In order to get the illusion of continuous signals on all channels, however, each signal is chopped up into small segments and then the small samples of each channel are combined in a prearranged sequence. In this way, samples of each

APPROXIMATE COST PER CHANNEL-MILE OF BASIC DUPLEX COMMUNICATION SYSTEM (BELOW 450 MC.)									
Number and Type of Stations	Length of System	NUMBER OF AUDIO CHANNELS							
		1	2	3	4	5	6	7	
Between 2 terminals only	45 miles	\$3730	7100	8460	9880	11200	12560	13980	System cost
		\$ 83	158	188	220	249	279	311	Per mile
		\$ 83	79	63	55	50	47	44	Per channel-mile
2 terminals 1 repeater	90 miles	\$7460	12625	13985	15405	16725	18085	19505	System cost
		\$ 83	141	156	172	185	201	217	Per mile
		\$ 83	71	52	43	37	34	31	Per channel-mile
2 terminals 2 repeaters	135 miles	\$11190	18150	19510	22930	22250	23610	25030	System cost
		\$ 83	135	145	155	165	175	186	Per mile
		\$ 83	68	48	39	33	29	27	Per channel-mile
2 terminals 3 repeaters	180 miles	\$20305	23675	25035	26455	27775	29135	30555	System cost
		\$ 113	132	139	147	155	162	170	Per mile
		\$ 113	66	46	37	31	27	24	Per channel-mile
2 terminals 4 repeaters	225 miles	\$25830	29200	30560	31980	33300	34660	36080	System cost
		\$ 115	130	136	142	148	154	161	Per mile
		\$ 115	65	45	36	30	26	23	Per channel-mile
2 terminals 5 repeaters	270 miles	\$31355	34725	36085	37505	38825	40185	41605	System cost
		\$ 116	129	134	139	144	149	154	Per mile
		\$ 116	65	45	35	29	25	22	Per channel-mile

Fig. 1. Cost of point-to-point radio systems is appreciably less than wire lines

modulation, and pulse modulation will be forced to still higher frequencies in a continuing evolution.

Finally, exhaustive comparisons show that single-sideband subcarriers on a phase-modulated RF channel provides the best performance factors of any of the presently available systems of multiplexing, even considering bandwidths up to 10 mc. These factors indicate that better signal-to-noise ratios can be obtained with less power and less bandwidth than from other methods.

Multiplexing Methods:

It is particularly fortunate that the use of single-sideband subcarriers should prove so advantageous, because that type of channeling equipment has been used for many years as the standard method of providing multiple circuits over telephone lines and cables.

There are two basic methods of combining several channels of intelligence on a single transmission circuit. The process

channel occupy the entire transmission medium one at a time. The sampling procedure must be fast enough so that at least three samples are taken of each wave at the highest audio frequency transmitted. Under this condition, the original wave can be reconstructed at the receiving end of the system with reasonable accuracy. The samples of each channel can be transmitted by phase, frequency, or amplitude modulation, but most systems utilize some form of pulse transmission at microwave frequencies. A radio-frequency carrier is turned on and off in short bursts of energy called pulses, and the intelligence is transmitted by varying in some manner the pulse rate, width, time-position, or amplitude.

The second basic method of multiplexing is frequency-division. In this method, all the channels are transmitted continuously and simultaneously, but each is carried by separate, narrow bands which, combined, comprise the total bandwidth transmitted. At the receiver, the com-

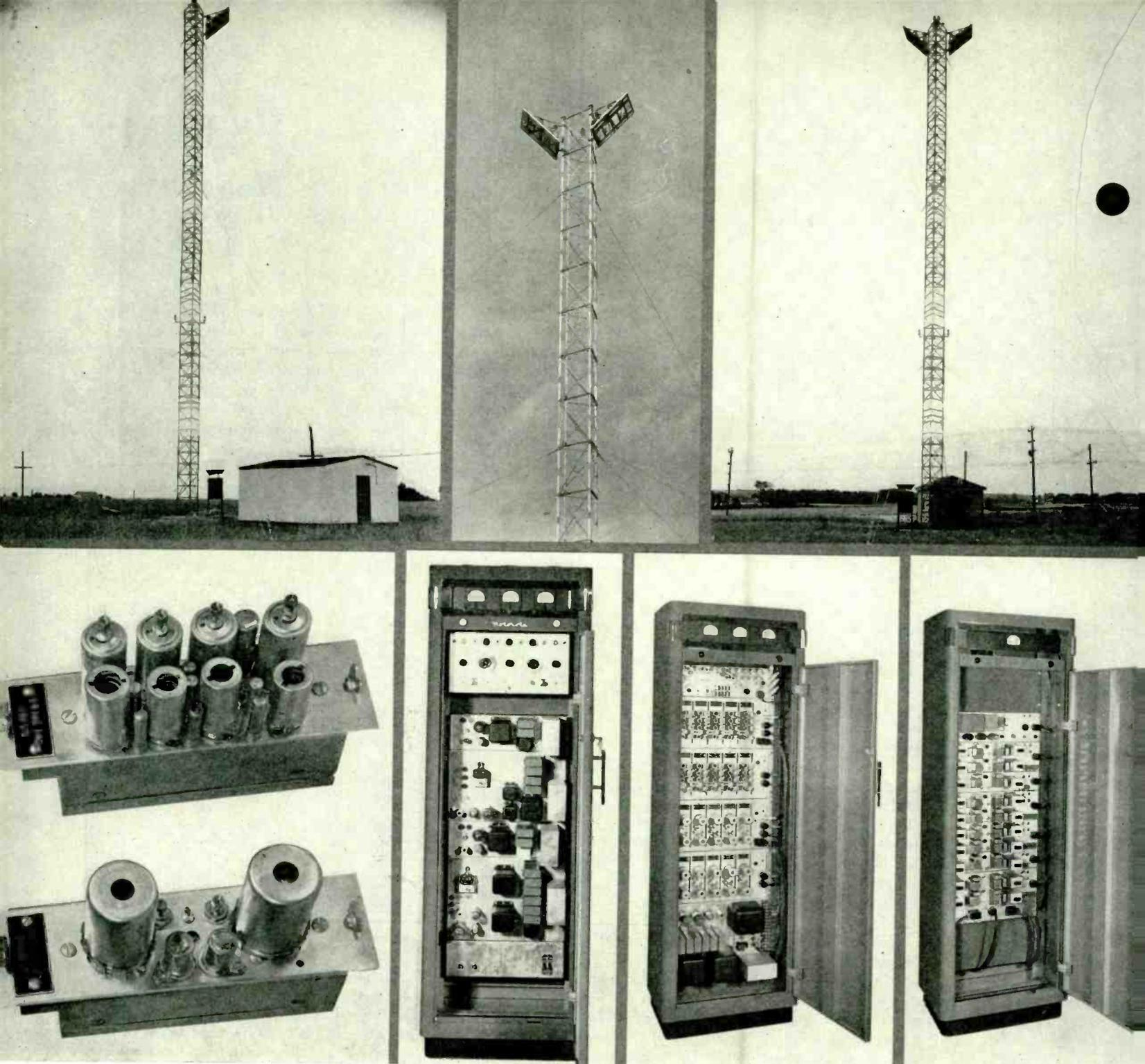

Fig. 2. Multiplex equipment for voice communication, telemetering, and remote control. Upper photos show test installation

posite signal is put through band-pass filters which separate the individual channels and reconvert them to their original forms. Frequency-division multiplexing of voice-frequency channels has been highly developed in the telephone industry in a form calculated to give not only the maximum possible utilization of frequency spectrum, but to give the maximum signal-to-noise ratio for the least power. This form of multiplexing is known as suppressed-carrier, single-side band carrier telephone. Standard equipment of this type is readily available.

Operational Requirements:

Many uses of multiple-channel point-to-point and relay radio systems require the

use of both radio and wire facilities. In those cases, the ability of the wire circuits to transmit the multiple modulation must be considered. The large bandwidths required for time-division systems of multiplexing in general and pulse modulation systems in particular prevent their use over normal telephone facilities. Single-side-band frequency-division channeling equipment, on the other hand, provides the maximum possible usage of available bandwidth and is the accepted method of multiplexing on wire or cable circuits. In a trunk system, then, to be composed of terminal circuits over wires and interconnecting radio links, it is imperative that this latter type of equipment be used. A typical commercial ap-

plication may be visualized in the use of radio in a telephone trunk circuit as a link to span a natural barrier such as a large river or bay. In this case, the radio must accept the complex intelligence on the wire or cable line, reproduce it faithfully at the other end of the radio link, and pass it on again to wire circuits. If the radio equipment is designed around time-division methods of multiplexing and pulse modulation, the intelligence on the wire line would have to be demodulated in carrier terminal equipment to the original voice-frequency channels which would then be reapplied to the time-division modulation circuits. The reverse process would be required at the receiving terminal. The added terminal and

channeling equipment would not only add enormously to the first cost, but would greatly increase the cost of maintenance and add to the distortion, noise, and crosstalk levels of the resulting circuit.

The widespread use of radio relay-equipment during the past war and the expanded studies since that time indicate that single-sideband sub-carrier on a phase-modulated radio link is in many cases the preferred method of radio-relay multiplexing, considering first cost, maintenance, power requirement, flexibility and reliability.

Cost of Relays vs. Wires:

In order to illustrate the order of magnitude of costs involved in systems of the type to be described, the accompanying table was prepared to show approximate costs for systems having from one to seven channels and from one to six links. These figures are given only as representative costs to indicate factually the low cost of radio channels compared to physical wire circuits. A recent analysis by the United States Independent Telephone Association shows that the current cost for a single-channel pole line is approximately \$878 per mile, and for a three-channel pole line is \$1,080 per mile or \$360 per channel mile. Current maintenance expense for the single-chan-

nel line is given as roughly \$46 per mile, and for the three-channel line as \$66 per mile or \$22 per channel mile.

The table shows approximate costs in dollars for all equipment including radio equipment, channeling equipment, antennas, transmission line and towers but not including the land and buildings. The availability of 115-volt AC or 24-volt DC power at each point is assumed. The table is based on presently available equipment operating below 450 mc. At higher frequencies, costs per mile are progressively higher because of increased costs of radio equipment, the necessity for higher towers, and the shorter jumps required between the transmitters.

Multiplex Equipment:

Great progress is being made in the development of multiplexed FM point-to-point and relay systems. So far, most of the work has been kept under wraps. However, we can present at this time details of equipment, Fig. 2 at left, which handles 10 voice channels, operating on 6,600 and 6,700 mc.

The upper illustrations here show a terminal station, a relay repeater, and a detail of the repeater reflectors. The outdoor cabinet, containing duplicate plug-in transmitter-receiver units, can be seen at the base of the tower in the left hand view. Above the cabinet is a

conical dish carrying an upturned parabola, fed by a curved section of waveguide. Microwaves directed toward the reflector are radiated in a horizontal plane.

Of the three racks, that on the left carries the microwave terminal circuits and power supplies. The top panel provides remote control for all functions of the outdoor microwave transmitter and receiver section. Below are four power supply panels, with power switches at the bottom.

The 10-channel multiplex cabinet is shown at the center. At the top is a subcarrier test panel, including a receiver for frequency checking. Next are two rows of five subcarrier receivers, and then two rows of subcarrier transmitters. The power supply section can be seen at the bottom.

The third is the line termination cabinet. There is a voice-test panel at the top, with a 1,000-cycle test oscillator and a 20-cycle ringing-voltage generator. Succeeding panels carry voice terminal circuits.

Detailed views are given of a plug-in FM receiver unit, above, and FM transmitter below. The technique of both telephone and radio apparatus design have been used to make the equipment as nearly fool-proof and as easy to repair as possible.

CHAPTER 10: SYSTEMS MAINTENANCE

TYPICAL MAINTENANCE ROUTINES, ADAPTABLE TO ANY TWO-WAY FM SYSTEM. TEST EQUIPMENT, SERVICE SHOP LAYOUT. HOW TO MAKE FREQUENCY CHECKS.

MAINTENANCE methods and routine for 2-way FM systems will differ according to the size and complexity of the systems. A plan which works out very well for a system of one base station and 10 mobile units would probably be inadequate for a much larger system, whereas a smoothly-running routine suitable for an involved system would not work efficiently on a smaller scale. There is no inflexible method which can be selected from a stockpile, like a ready-made suit, to fit each layout perfectly. However, presented here is an outline of methods used by the Connecticut State Police system. Valuable lessons can be learned from this description of its methods of handling maintenance. Basic routines described in the following pages can be scaled up or down to suit the needs of practically any 2-way FM system.

System Description:

The Connecticut State Police, under Commissioner Edward J. Hickey, installed the first 2-way FM system in 1939. Thus, the information presented here represents over 10 years of operating experience. Today the system comprises eleven 250-watt main stations, two 50-watt main stations operating in conjunction with two of the 250-watt stations, and three hundred and fifty 25-watt mobile units. There is also an auxiliary 50-watt transmitter at central headquarters in Hartford.

All the 250-watt stations are situated on mountain-tops near the centers of the areas served. They are unattended and remotely controlled by telephone lines from police barracks.

The fixed stations transmit on 39.5 mc. only, but receive 2 frequencies, 39.5 and 39.26 mc. The mobile units transmit on 2 frequencies, 39.26 mc. normally (for main station communication) and 39.5 mc. (for car-to-car communication). The cars have receivers tuned to only the one frequency of 39.5 mc.

It may appear that this is a large number of main stations for a relatively small area, but it is effective insurance. In the event that one main station goes off the air, its area is still covered by secondary signals from at least one other station. This is really economy from another standpoint. It makes practical the use of low-power mobile equipment, with consequent reduction of battery drain and generator troubles.

Maintenance Organization:

The maintenance staff consists of the Supervisor of Radio Maintenance, 5 radio maintenance men, one radio mechanic who handles installation work, and one tower maintenance man. The tower man is employed under contract to handle all tower and obstacle-light maintenance.

The State is divided into 3 maintenance areas, each with a well-equipped radio shop and a complete supply of

spare parts.

All members of the maintenance organization are on duty during the day, and are subject to call at any other time.

Selection of Personnel:

The selection of personnel for maintenance in a large system or a small one is a matter for careful consideration. Experience has shown that in addition to technical qualifications, mental attitude and reliability are of great importance. A maintenance man must be available when he is needed. Moreover, he must have complete confidence in the equipment he is hired to service.

In a system large enough to have a supervisor to direct the maintenance work, the supervisor should be a man with an engineering background and extensive maintenance experience. The radio maintenance men under him should be well-trained. It has not been found desirable to attempt training men with no previous radio experience, for it is too long and costly a process. All radio maintenance men must have first- or second-class radiotelephone or radiotelegraph licenses.

The work of the radio mechanic is limited to installation, transfer, and re-installation of mobile units. He need not have any technical radio training. A versatile automobile mechanic with a knowledge of basic electricity will suffice. Usually, a steeplejack is hired for tower maintenance.

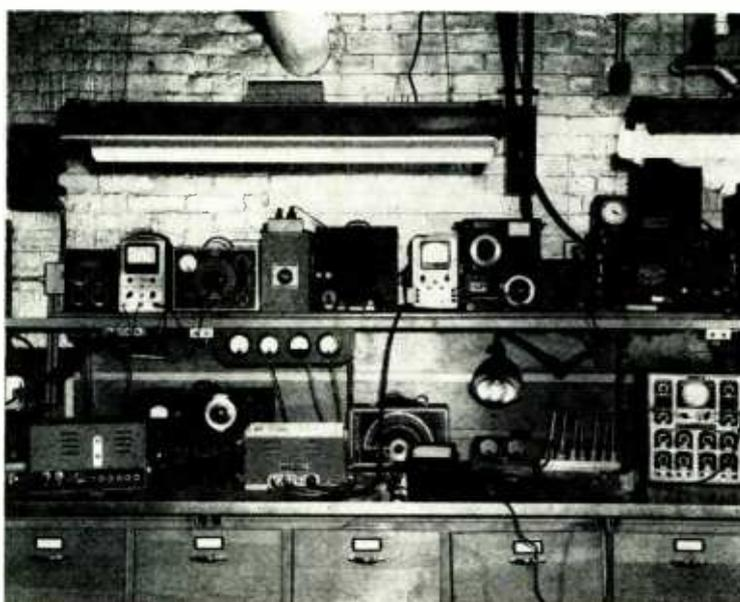

Fig. 1. Supervisor Frank Bramley at the test bench. Fig. 2. Work bench at central radio headquarters laboratory, Hartford

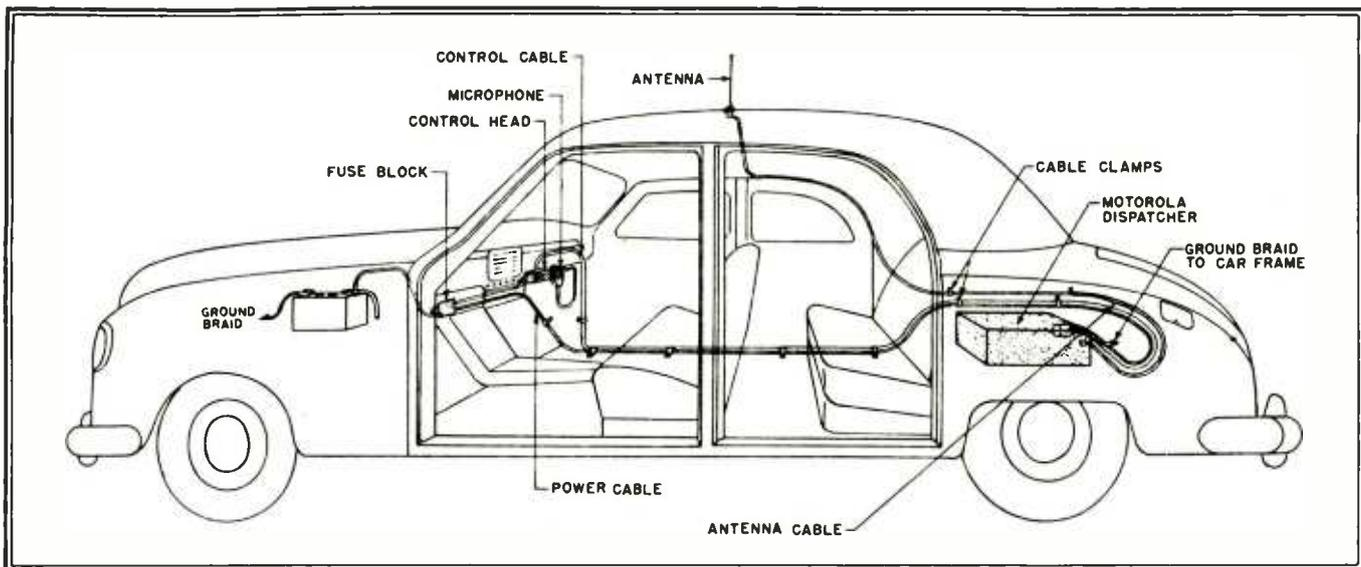

Fig. 5. Use of preformed cables and simplified connectors permits fast, easy installation of modern mobile equipment

required power is available. For this reason the battery and its wiring are more important than is generally realized. The wiring should be heavy and should be carefully watched for corrosion and abrasion. The full-load voltage at the equipment should not be less than 5.8 volts.

However, it has not been found necessary to use heavy-duty batteries in this particular system. A heavy-duty battery will not give any more voltage than a regular-sized battery—it has only a longer reserve. This reserve is not important with the high-rate generators used. Consequently, the regular battery supplied with the car is used until worn out, and is then replaced with a medium-duty battery.

To make sure that batteries are always fully charged, there is a 6-ampere battery charger installed at each barracks. These are mounted on the wall of the garage, and the officer has only to take two long flexible leads and clip them to the battery without removing it from the patrol car. This has proven simple enough so that it is used willingly and often.

Car Generator Maintenance:

It is of little use to have a good battery if the generator is incapable of replacing what is taken from the battery. Ordinary generators supplied with the new patrol cars were too small to handle the charging rate required. Therefore, until 1949, it was necessary to install special high-rate generators on all cars. This was inconvenient, since new engine heads and manifolds were required to make room for the generator. In 1949, however, the design of the new Ford permitted the use of the 45-ampere Lincoln generator, which is supplied by the manufacturer. They are more than adequate.

But in most other cases, especially when higher-power mobile transmitters

are used, special generators are required, such as the Bosch or Leece-Neville types. So far, there has been no generator maintenance problem beyond the regular oiling when cars are lubricated.

Power Pack Maintenance:

The vibrator power-pack is another small part of the system often neglected but extremely important to full efficiency of the whole system. Every vibrator that is at all questionable should be replaced. If the vibrator output voltage falls 15 per cent below normal, replacement is indicated also. If, upon replacement of the vibrator the output of the pack is still below normal, trouble is indicated either in the rest of the pack or in the battery.

Power packs are checked monthly, and are overhauled yearly. During an overhaul, buffer condensers are replaced and filter condensers checked for leakage, capacity, and power factor. The average life of a vibrator has been about one year. Since each car is in use about 10 hours a day, this represents a life of 3,500 hours.

These remarks apply only to the power supply for the receiver, since Connecticut uses dynamotors for the mobile transmitters. Vibrators for transmitter power supplies generally have a much shorter life as measured transmitting hours.

Car Installation:

Proper initial installation is probably the

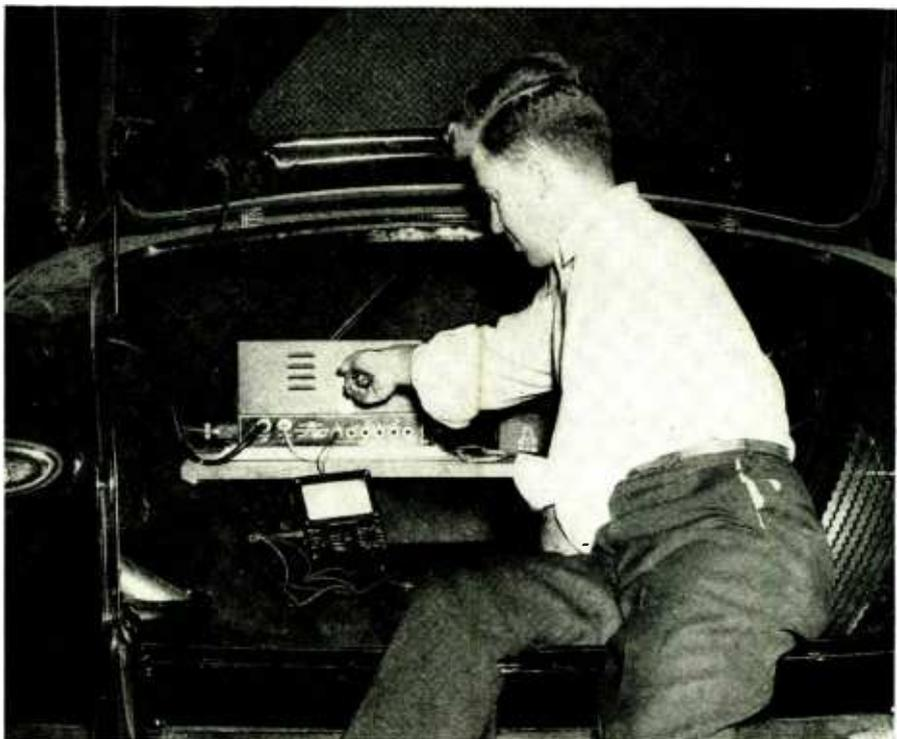

Fig. 6. Equipment is mounted above rear compartment deck as protection from water

most important item in the maintenance of a system, large or small. In mobile units, control cables must be installed in conduit. All exposed cables should be securely fastened at intervals of one foot or less to eliminate vibration. Adequate ventilation for equipment is necessary, as is freedom from excessive moisture. Fig. 5 is a phantom view of a typical car installation.

Rear luggage-compartment mounting is customary. Since it is difficult or impossible to prevent this compartment from leaking, especially during car-washing, the equipment must be mounted off the floor. In the new cars there is a raised portion of the floor above the rear axle which makes a convenient mounting-place. Fig. 6 illustrates this.

Loudspeakers are especially important. They must be mounted facing the operator, and never pointed at the floor or installed on the fire wall. Muffled, unintelligible speech will result from the latter methods of mounting. Dash or under-dash installation will provide the clear, crisp tones necessary for maximum intelligibility.

Telephone-type handsets have been found most practical. Under adverse conditions, the earphone is still better than a speaker. And when the handset is placed at the operator's ear, it brings the microphone automatically to the correct position for talking, which helps keep modulation at the proper level.

The installation of antenna base springs is recommended. Without them, the antennas will break with alarming frequency. Another good idea is to replace the flexible connection between the antenna rod and transmission line. The 1/4 in. braid supplied usually breaks with-

in 10,000 miles. By using braid sold for generator brush leads much longer life has been obtained. These are good for 100,000 miles of normal use.

Main Station Service:

Remote main stations are checked as carefully and as frequently as weather and time allow. Some of the remote stations are virtually inaccessible in severe weather, and consequently are not checked strictly according to schedule. Insofar as possible, however, every attempt is made to adhere to the following schedule:

WEEKLY

1. Listening test: volume, sensitivity, selectivity, squelch operation, tone quality.
2. Voltage measurement: receiver B, transmitter B, remote control voltage, panel meter reading.
3. Adjustments: tuning of final stage and others if necessary.
4. Cleaning: remote-control relay contacts.
5. Check of ventilation and temperature control devices.

The record form for weekly checks is shown in Fig. 7.

MONTHLY

1. Main station control units: B voltage, db output, cleaning and dusting, check of mike quality, condition of push-buttons, and adjustment of volume levels.

Fig. 8 illustrates the record form kept for each station.

QUARTERLY

1. Combined weekly-monthly check by supervisor.

SEMI-ANNUALLY

1. Cleaning of all equipment.

2. Overhaul of receivers.

Fig. 9 shows the completeness of this check.

ANNUALLY

1. Paper coupling capacitors are replaced.

In all fixed-station tests, voltage and current readings are checked carefully and recorded. Plate voltage readings on receivers are particularly important, because it has been found that many complete failures of equipment have been averted by replacement of rectifiers which do not deliver full voltage. A 10% less-than-normal plate voltage reading indicates a definite need for rectifier replacement.

For the semi-annual overhaul the receivers are brought to the shop, and a spare receiver substituted. Alignment of fixed-station receivers is a delicate, time-consuming job. New receivers are first temperature-cycled, left on all day and turned off at night. After three days of this, the first alignment is done. After running continuously again for 24 hours, the receivers are aligned for the second and last time, and then stored on the shelf. When put into use, they are not readjusted in any way. Performance may be relatively poor at first, but will improve with time to peak. Subsequent alignments do not require temperature-cycling, but are still critical.

Tube-testing is done regularly on fixed-station equipment. Whenever a tube is replaced, however, it is advisable to watch for a few hours to make sure the equipment is functioning perfectly.

The emergency generators at remote stations should give little trouble. Onan gasoline-powered generators with outputs of 3 kw. are used in this system. The rec-

Connecticut State Police
Radio Division
REMOTE BASE STATION MAINTENANCE RECORD

Date _____ Agency _____ Call Letters _____

1. Symptoms _____
2. Repairs, adjustments made _____
3. Power input to final _____ Volts Plate current _____ Ma.
Cathode current _____ Ma. Line voltage _____ Volts
4. Deviation due to modulation _____ kc. Adjustments (yes) (no)
5. Carrier deviation from center _____ % Adjustments (yes) (no)
6. Tower lights _____ Photo cell _____ Preamp. gain _____
7. Transmitter tuning: (6L6)(7C5) grid _____ Ma. 807's grid _____ Ma.
807's plate _____ Ma. 807's plate _____ Volts 250TH grid _____
8. Relays cleaned _____ Carbons inspected _____ Gas pressure _____ lbs.
Thermostat adjustment _____ Fan oil _____ Final neutralization _____
9. Base station sensitivity _____ uV. Audio level _____ db.
Squelch adjustment _____ Plate voltage _____
10. Mobile station sensitivity _____ uV. Audio level _____ db.
Squelch adjustment _____ Plate voltage _____
11. Tubes replaced _____
12. Parts replaced _____
13. Remarks _____
14. Technician's signature _____

Connecticut State Police
Radio Division
BASE STATION CONTROL POINT MAINTENANCE RECORD

Date _____ Agency _____ Call Letters _____

1. Symptoms _____
2. Repairs, adjustments made _____
3. Decibels into line _____ db. Carrier indicator reading _____ Ma.
4. Meter settings _____ Dial lights _____ Speaker quality _____
5. Cars-thru-speaker switch _____ Rec. min. vol. setting _____
6. Hangup box contacts _____ Handset cord condition _____
7. Microphone qual. and output _____ Pushbutton contacts _____
8. Squelch voltage into line _____ Transmitter voltage _____
9. Special equipment _____
10. Remarks _____
11. Tubes replaced _____
12. Parts replaced _____
13. Technician's signature _____

Fig. 7. Record form for weekly check of main station equipment. Fig. 8. Form used for monthly control point inspections

Connecticut State Police
Radio Division
MAIN STATION RADIO EQUIPMENT INSPECTION RECORD

STATION _____ DATE _____
INSPECTED BY _____ AMI _____

REMOTE EQUIPMENT:

Detector _____ Entrance Wiring _____
Phenacell _____ Relay Condition _____
Tower Lights _____ Emergency Switch _____
External Point _____ Door Lock _____
Vent Covers _____ Vent Screens _____
Door Seal _____ Phone Line Fuses _____
Phone Line Carbons _____ Record Keeping _____
Housekeeping _____ Fan _____
Heater _____ Trouble Light _____
Fan Thermostat _____ Mute _____ Cabinet _____ SVC Notes _____

RECEIVER FOR 39.5 MC. _____
Squelch Adjustment _____ Audio Level _____ db.
Sensitivity _____ Overhaul _____
Modifications _____ Plate Voltage _____

RECEIVER FOR 39.26 MC. _____
Squelch Adjustment _____ Audio Level _____ db.
Sensitivity _____ Overhaul _____ Modifications _____
Squelch Relay Mount _____ Plate Voltage _____

-2-

TRANSMITTER:

Tuning _____ Frequency _____
Neutralization _____ Power Output _____
Gas Pressure _____ lbs. Deviation _____
Line Voltage _____ Plate Current _____ 250TH Grid _____

BARRACKS EQUIPMENT:

Control Unit External Appearance _____
Meter Settings _____ Dial Lights _____
Loudspeaker Quality _____ Volume Control _____
Carburetor Switch _____ Carrier Reading _____
Received Audio Level _____ Decibels Average _____
Receiver Minimum Volume Control _____
General Overhaul Of Apparatus _____

HANGUP BULB:

Microphone Quality _____ Handset Cord _____
Pushbutton Contacts _____ Switch Contacts _____

POWER SUPPLY:

Squelch Voltage _____ Transmit Voltage _____ Overhaul _____

SPECIAL BARRACKS RADIO EQUIPMENT:

**STATEMENT REGARDING THE CALCULATION OF PLATE INPUT POWER
WHICH DERIVES FROM MEASUREMENTS OF CATHODE CURRENT**

Standard procedure in the Connecticut State Police Department, Radio Division, where one or two type 807 tubes are used in the final radio frequency stage, is to lead to 100 milliamperes cathode current per tube. Where a single tube is used, plate voltage is not over 400 volts in those models rated at 25 watts output, and not over 500 volts in those rated at 35 watts. When two type 807's are used in parallel, voltages between 400 and 600 are used. Measurements indicate that in our equipment the grid current varies between 1 and 3 mill per tube, while the screen current varies between 9 and 16 mill per tube. Since both grid and screen currents flow through the cathode they may be subtracted from the cathode current. Since we adjust cathode current to 100 mill per tube, true plate current is 10 to 17 mill less than 100, which is equivalent to 10 to 17% below measured values. We therefore deduct 10% from plate input powers calculated from measurements of cathode currents, although in some cases the actual input may be as much as 17% down from measured values.

Frank A. Bramley
SUPERVISOR OF RADIO MAINTENANCE

Connecticut State Police
Radio Division
RADIO TECHNICIAN LICENSE DATA

Frank A. Bramley, 115 Crestwood Drive, Manchester, Connecticut
Radiotelephone First Class - #P-1-2081 - Expires Sept. 19, 1949

George P. Antonastio, 51 Barber Street, Wilson, Connecticut
Radiotelephone First Class - #P-1-4561 - Expires March 29, 1953

Raymond E. Benoit, Mansfield Center, Connecticut
Radiotelephone 2nd. Class - #P-1-4423 - Expires Feb. 9, 1953

Leonard C. McFarland, 19 Sherman Avenue, East Hartford, Conn.
Radiotelephone 2nd. Class - #P-1-4422 - Expires Feb. 9, 1953

Elmer G. Nevb, Prospect, Connecticut (RFD #2, Waterbury #2)
Radiotelephone First Class - #P-1-4555 - Expires Aug. 22, 1952

Wilbur J. Richards, Hill Avenue, Yalesville, Connecticut
Radiotelephone 2nd. Class - #P-2-11088 - Expires Oct. 10, 1952

SAMPLE SIGNATURES AND INITIALS

Bramley Frank A. Bramley FAB
Antonastio George P. Antonastio GPA
Benoit Raymond E. Benoit REB
McFarland Leonard C. McFarland L.C.M.
Nevb Elmer G. Nevb EN
Richards Wilbur J. Richards WRJ

Fig. 13. FCC power calculation statement

Fig. 14. This form must be filed with FCC

-3-

GENERAL INSPECTION OF CARS:

Car Reg. _____ Condition _____
Car Reg. _____ Condition _____
Car Reg. _____ Condition _____
Car Reg. _____ Condition _____
Car Reg. _____ Condition _____
Car Reg. _____ Condition _____
Car Reg. _____ Condition _____

REMOTE EQUIPMENT:

Sparr Tubes: 250TH (1) 866A (2)
863A (2) 817A (2) 6LA (1)
TCS (1) 7C7 (2) 7AB (2) 7B7 (1)
7AG7 (2) 7B5 (1) 7C7 (2) 7AB (2) 7B7 (1)
A1J (1) 6AB6 (1) 6AR (2) 6AC7 (2)
6S17 (1) 6X4 (2) 6CG6 (1) 6V6 (1)
6SN7 (1) 6SL (1) 6Y4 (1) 923 (1)
80A (2) 816 (1)

RELAYS:

Line Relay _____ Pilot _____ Overload _____
Special _____ Antenna _____ Squelch _____

NOTES:

ord form used is shown in Fig. 10. They are started weekly and checked for gasoline, oil, and battery condition. Semi-annually they are cleaned and overhauled if necessary. An automatic signalling device has been designed and installed which sends an interrupted tone back to the control-point speakers, as an indication that the generators are in operation.

button are in constant use and are greatly subject to wear. Frequent checks and ready replacement are necessary to insure dependable operation.

Main stations use coaxial antennas mounted on 180-ft. steel masts. The antennas were fed by 7/8 in. concentric copper line, filled with nitrogen at 25 lbs. pressure. These lines developed slow leaks and were vulnerable to lightning discharges even though well grounded. As a result they are being replaced, when replacement is required, by solid dielectric line.

If the control relays, both at the control point and remote station, are not provided with dust covers, it is wise to add them. Relay troubles in this system dropped sharply after the installation of dust covers. However, the contact points should be cleaned weekly.

Frequency Checks:

Since all main stations can be picked up at central headquarters in Hartford, frequency measurements are made from that point each month. A frequency meter is calibrated against WWV, and immediately afterward the measurement is made. (Detailed instructions on making frequency checks are given in the

Lightning also damages the telephone and power lines frequently. Damage to the lines, and to the relays and transformers connected to them, has been altogether too common. To minimize this damage it has been found advisable to employ heavy grounding and to use easily-accessible plug-in relays and transformers.

Operating Point Maintenance:

Headquarters control-unit maintenance is generally limited to tube replacement, relay cleaning, and inspection of the microphone cord and control circuit push-

**STATEMENT REGARDING THE CALCULATION OF VOLTAGE EXISTING IN
CIRCUITS OF TOWER LIGHTS WHEN MEASUREMENTS ARE MADE AT PHOTOCELL**

2 lights at 180-ft. level, 100 watts, 130 volts each.
Total current equals 1.55 amperes, 2 bulbs.
Line resistance is 120/5280 = 0.53, or .184 ohms, since there is 120 ft. of line between 2nd. and 3rd. levels, and no. 12 wire is used, having a resistance of 8.38 ohm/mile @ 68 degrees F.
Voltage equals 1.55 x .184, or .28 volts.
Thus .28 is the voltage drop between 2nd. and 3rd. levels.

2 lights at 120-ft. level, 100 watts, 130 volts each.
Total current equals 3.07 amperes, 4 bulbs.
Since line between 1st. and 2nd. level is also 120 ft., resistance is same as above, .184 ohms.
Voltage equals 3.07 x .184, or .56 volts.
Thus .56 is the voltage drop between 1st. and 2nd. levels.

2 lights at 60-ft. level, 100 watts, 130 volts each.
Total current equals 4.61 amperes, 6 bulbs.
Since line between 1st. level and point of measurement is also 120 ft., resistance is again .184 ohms.
Voltage drop equals 4.61 x .184, or .85 volts.
Thus the voltage drop between point of measurement and 1st. level is .85 volts.

Voltage at 1st. level is voltage at point of measurement less .85.
Voltage at 2nd. level is voltage at point of measurement less 1.40.
Voltage at 3rd. level is voltage at point of measurement less 1.68.

The calculated voltage drops are all less than the probable error of meters it would be practical to use, so it is inferred that actual measurements could be superficial.

Frank A. Bramley
SUPERVISOR OF RADIO MAINTENANCE

Fig. 9. Complete semi-annual check form

Connecticut State Police
Radio Division
EMERGENCY POWER UNIT CHECK

Check Units Weekly _____ Report Trouble To Radio Division _____

STATION _____

Date	Meter	Battery	Water	Gravity	Started	Checked by

Fig. 12. Tower light statement for FCC

Connecticut State Police
Radio Division
STATEMENT OF FREQUENCY MEASUREMENT

This is to certify that on _____ at _____ (AM) (PM) the frequency of station _____ was measured at Hartford, Connecticut and found to be _____ megacycles, which is equivalent to a deviation of _____ % from the assigned frequency of _____ megacycles.

The above measurement was made by Radio Technician _____ using a Lampham frequency meter Type 105, serial no. 29 which has previously calibrated against station 88V.

Signed _____
Radio Technician

Date _____

The above form shall be filed with and become a part of the regular log for the day specified.
Check and make sure that an entry was made in the original log at the time the measurement was taken stating that a frequency measurement was made.

Fig. 10. Remote gasoline generator record

Fig. 11. Record form for frequency checks

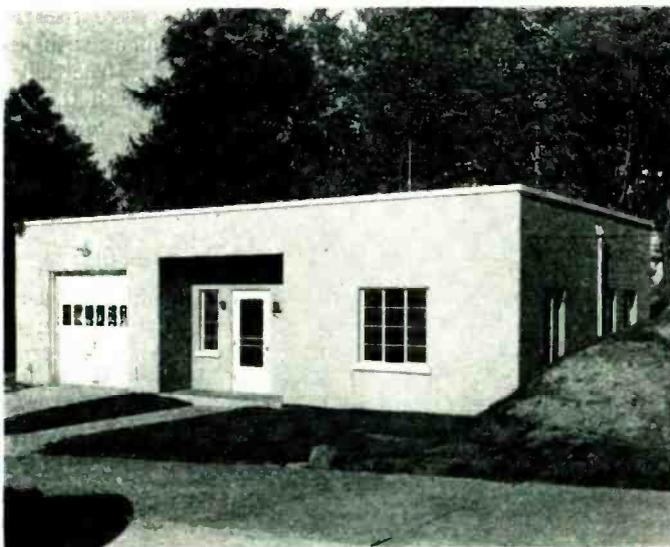

Fig. 15. Service shop and transmitting headquarters for city police system. Fig. 16. Drive-in mobile unit servicing room

latter part of this Chapter.) Signed reports of the checks are sent to each station for entry in the log, and a report is given to each technician. The form for this report is shown in Fig. 11. A master record of all frequency measurements is kept at main headquarters.

The technicians are provided with portable frequency monitors, checked periodically with headquarters equipment. This enables them to make the necessary checks on mobile units. Records of mobile equipment frequency measurements are kept by the technician, and on the service record cards in the equipment. These checks cannot be held to a rigorous time schedule in a large system, but should average about one per month.

FCC Forms:

In addition to other technical requirements, such as the frequency checks, FCC demands:

1. A statement of the exact voltage existing at tower light sockets, and how

it is calculated. A copy of the statement used at Connecticut, which has been accepted, is shown in Fig. 12.

2. A statement showing the method of calculation of declared plate input power, when calculated from cathode current. This is presented in Fig. 13.

3. A list of the names and addresses of all radio maintenance men employed to service the equipment, and samples of their signatures and signed initials. Fig. 14 shows this form as used at Connecticut.

A Modern Service Shop:

Especially to those planning service facilities for a mobile radio system, the accompanying illustrations of the police radio shop at Erie, Pa., offer some interesting ideas. It is a versatile and efficient arrangement, capable of handling a system of about 75 cars with maximum efficiency.

Fig. 15 shows the combined shop and transmitting headquarters building. Because service work on mobile units must

be done under all weather conditions, a room is provided at the left where a car can be driven inside. Fig. 16 is a view of this room, looking to the rear, and showing the ample working space. Test equipment and tools are to be seen on the bench tops. Spare parts are stored on the shelves.

To the right and in the front part of the building is the transmitter room. Directly behind it is the room shown in Fig. 17. The shelves at the left hold spare mobile equipment. Two work benches are provided, each with a built-in 6-volt DC supply. In the extreme right foreground is a corner of the second work-bench, shown in detail in Fig. 18. Here the power supply can be seen clearly beneath the bench, with the output brought up to jacks at the rear.

In the left background, Fig. 17, is a shielded servicing room. Fig. 19 reveals the complete, efficient arrangement of the test equipment. In this small space, all within easy reach, are all the instruments necessary for any servicing task.

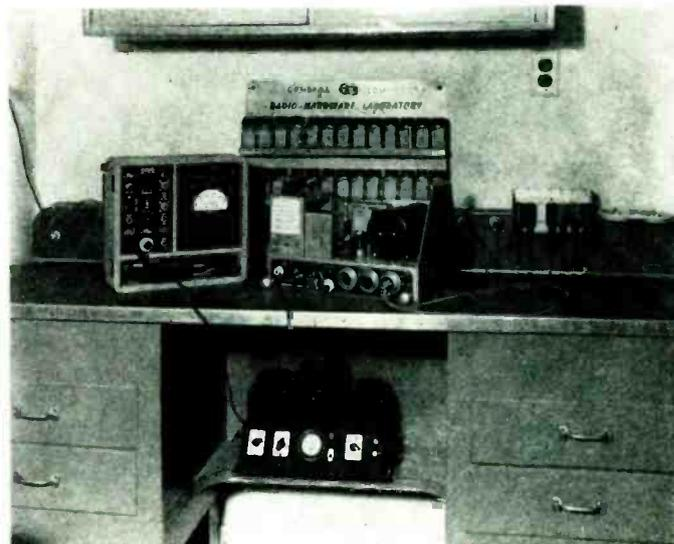

Fig. 17. Spare parts and service shop at rear of building. Fig. 18. One of the test benches. Note built-in power supply

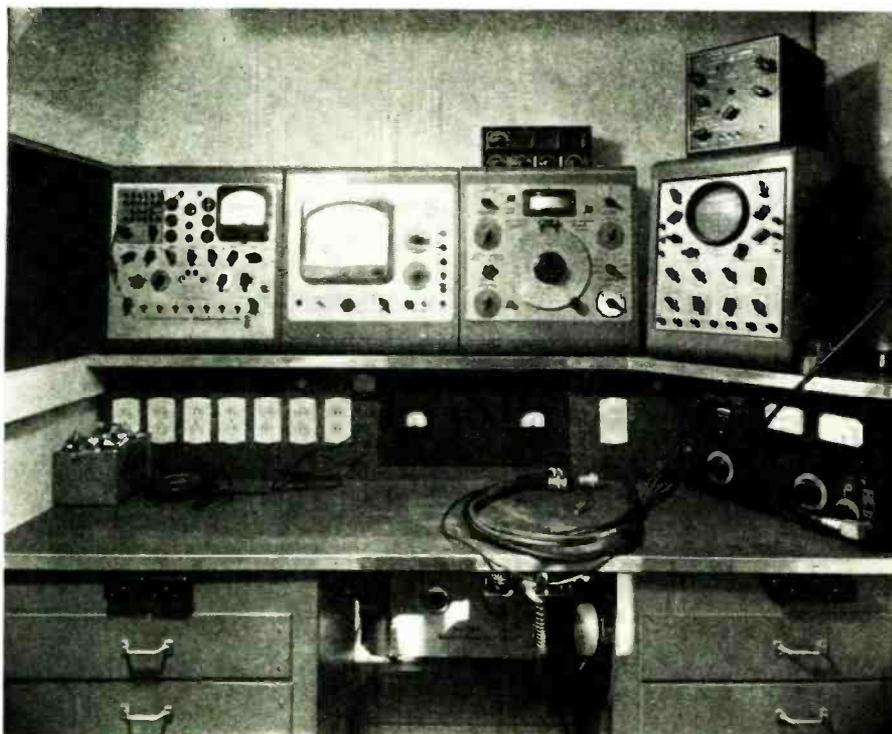

Fig. 19. Shielded servicing room contains complete facilities for all test work

On the top shelf, from left to right, are a tube tester, volt-ohm-capacity-milliammeter, microvolt generator, and oscilloscope. To the right of the oscilloscope is a whip antenna, and above the scope is a frequency meter. Grid-dip meters are above the microvolt generator.

Directly under the shelf, center, is a recessed speaker and its associated

meters. On the bench at the far right is a signal generator. A 6-volt DC power supply can be seen underneath the bench in the center. To complete the arrangement, a microphone and mobile unit control panel are mounted on the bench. This and the antenna permit tests to be made under load conditions.

It is true that many systems simply

cannot afford so comprehensive a servicing section, and can get along with less than this. Yet it is equally true that a system can be quickly crippled through seriously inadequate facilities for proper servicing, and this may prove far more costly than a reasonable, initial investment in test equipment.

FREQUENCY METERS

The increasing demand for frequency assignments in communications channels requires an increasingly closer adherence to assigned frequency by each licensee. Accurate frequency measurements are essential, therefore, to the most effective use of the all-too-limited spectrum, for if one transmitter is off frequency, its range is reduced greatly, and oftentimes serious interference is set up with adjacent-channel transmitters.

When radio supervisors fail to maintain their transmitters on the assigned frequencies, it is most often due to the fact that they are not familiar with the technique of frequency measurements. As a result, they are reluctant to make frequency checks, even though they have the instruments necessary.

With this situation in mind, the following information has been prepared for the benefit of those to whom the frequency meter and its use are still enshrouded in mystery and doubt. While the data presented concerns the Brown-ing type S4 meter specifically, a study of this article will shed much light on the use of frequency meters of any make intended for the emergency services.

Electrical Circuits:

FCC rules for the emergency services require that each transmitter be given a periodic frequency check. For use by police and other emergency stations, it is



Fig. 20. Brown-ing frequency meter, type S4. Accurate to .0025%, it exceeds requirements of FCC.

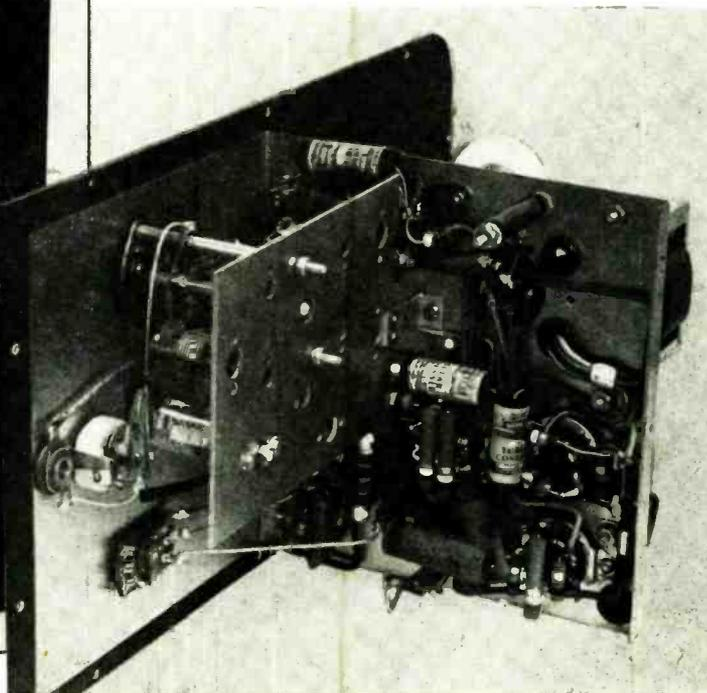

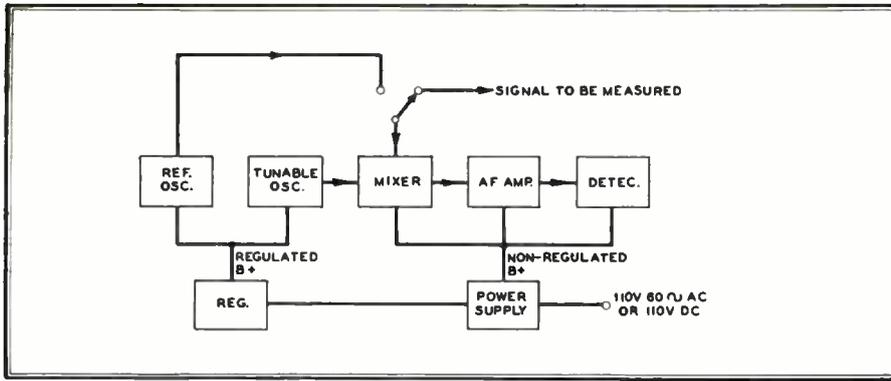

Fig. 21. Circuit elements of the Browning crystal-controlled frequency meter

advisable to use a meter accurate to plus-or-minus .0025%. Then there will be no question about meeting FCC requirements. The Browning meter illustrated in Fig. 20, is calibrated with the required precision at one to five different frequencies within the band from 1.5 to 100 mc.

The FCC restricts carrier frequency drift to .01% below 50 mc., and .005% from 50 to 220 mc. Stability above 220 mc. is specified in the authorization.

As shown in the block diagram, Fig. 21, the instrument contains two oscillators. One of these, indicated as TUNABLE OSC. in the block diagram, is adjusted by the tuning knob, and is used for making frequency measurements. Any oscillator circuit which depends on the mechanical dimensions of the components for frequency is subject to drift. Therefore, a crystal-controlled reference oscillator, indicated as REF OSC., is provided. When a measurement is to be made, the tunable oscillator is checked at two points on the dial against the crystal-controlled reference oscillator, as will be explained later. Any drift in the former can be corrected by an adjustment of the knob marked E.C.O. ADJ.

Headphone connections are provided for a rough check of the beat frequency set up between these two oscillators or between the tunable oscillator and the transmitter that is being checked. For exact adjustment, an electron eye tube is used, the beat frequency being indicated by the deflection of the eye.

A mixer tube and associated AF amplifier are used with the eye tube. The mixer circuit is of conventional design, in which the grid of a 6SA7 oscillator section remains connected to the tunable oscillator, and the grid of the pentode section is switched to the reference oscillator or to the unknown signal. A single-ended triode audio amplifier stage is coupled to the mixer output for zero-beat amplification. Good low-frequency response is provided in order to drive the triode section of the 6U5 eye tube at beat frequencies below 25 cycles. At exact zero-beat condition, the amplification is sufficient to give a 90° deflection of the eye.

Compact overall design and light weight are achieved through the use of a transformerless power supply and half-wave rectifier. Heat dissipation within the cabinet is kept at minimum by using a line-

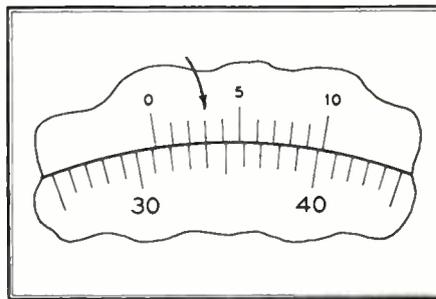

Fig. 22. The vernier fine-tuning dial

cord resistor in series with 6-volt heater-type tubes. Approximately 150 volts are delivered to the mixer and detector stages, and regulated 60 volts to each of the two oscillators.

A telescoping antenna, so mounted that it can be used as a carrying handle, provides a flexible method of coupling to the transmitter under test. A 50-watt fixed transmitter, feeding a coaxial line and located within 20 ft. of the meter, will usually give sufficient coupling through leakage if the antenna on the meter is fully extended. It will give sufficient pickup to measure the frequency of a 25-watt mobile transmitter at a distance of about 50 ft. when the antenna is pulled all the way out, although this may vary considerably under special conditions.

How to Read the Vernier:

The first requirement for using the frequency meter is an understanding of the vernier scale. The vernier, Fig. 22, simply shows the exact number of tenths of a main-scale division to be added in the complete reading. For example, the reading of the scale in Fig. 22 is 31 divisions plus a fraction to be expressed in tenths.

To determine this fraction, note which line on the vernier is exactly opposite a line on the main scale. In this case, line 3 is opposite a main scale line. Therefore, the fraction three-tenths should be added to the reading 31. Thus, the full reading of the main scale is 31.3. If line 7 on the vernier had been opposite a line on the main scale the reading would have been 31.7.

If it is desired to set the dial at a specified value, such as 47.6, the main scale should be set so that 47 is opposite 0 on the vernier. Then it should be turned just

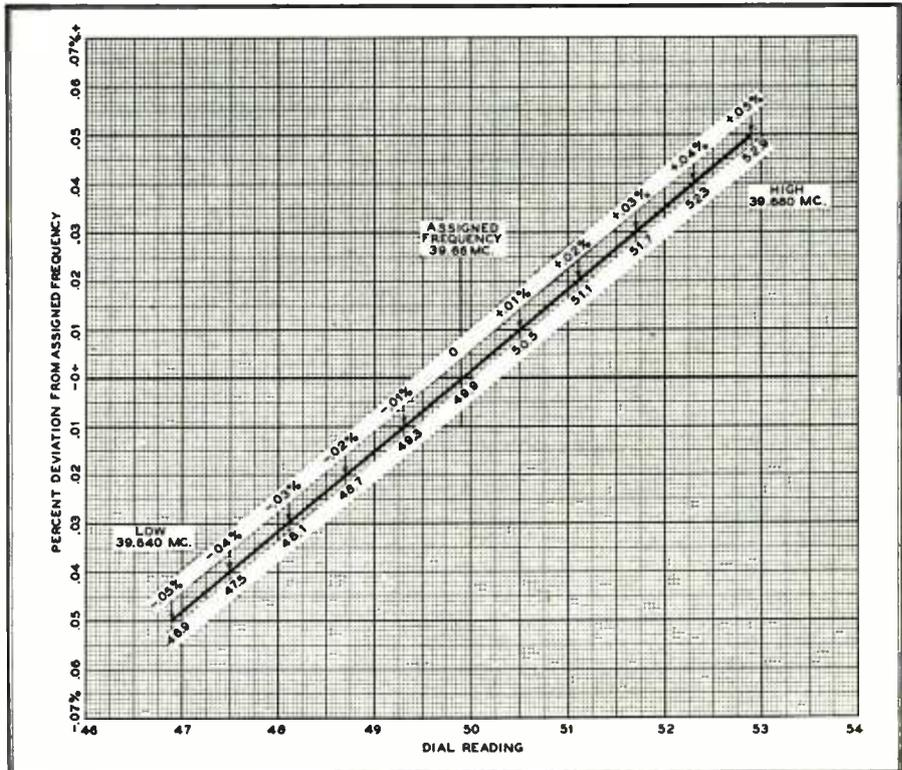

Fig. 23. Calibration curve showing percentage of error from specified frequency

BROWNING LABORATORIES, Inc.

BAND NO. 1 Type S-4 Serial No. 99

Frequency (Megacycles)	Dial Reading	Frequency (Megacycles)	Dial Reading	Frequency (Megacycles)	Dial Reading
39.810	85.3	39.725	59.5	39.540	32.5
39.805	84.5	39.720	58.8	39.535	31.9
39.800	83.6	39.715	58.1	39.530	31.2
39.795	82.9	39.710	57.4	39.525	30.6
39.790	82.1	39.705	56.7	39.520	29.9
39.785	81.4	39.700	55.9	39.515	29.2
39.780	80.6	39.695	55.2	39.510	28.6
39.775	79.9	39.690	54.5	39.505	28.0
39.770	79.2	39.685	53.7	39.500	27.4 C.P.
39.765	78.4	39.680	52.9	39.495	26.7
39.760	77.7	39.675	52.2	39.490	26.1
39.755	77.0	39.670	51.5	39.485	25.4
39.750	76.3	39.665	50.7	39.480	24.7
39.745	75.6	39.660 S.F.	49.9	39.475	24.1
39.740	74.9	39.655	49.2	39.470	23.4
39.735	74.3	39.650	48.4	39.465	22.8
39.730	73.6	39.645	47.7	39.460	22.2
39.725	72.9	39.640	46.9	39.455	21.6
39.720	72.2	39.635	46.2	39.450	20.9
39.715	71.6	39.630	45.4	39.445	20.3
39.710	70.9	39.625	44.6	39.440	19.6
39.705	70.2	39.620	43.9	39.435	19.0
39.700	69.6	39.615	43.1	39.430	18.4
39.695	68.9	39.610	42.4	39.425	17.7
39.690	68.3	39.605	41.7	39.420	17.1
39.685	67.6	39.600	41.0	39.415	16.4
39.680	66.9	39.595	40.2	39.410	15.7
39.675	66.3	39.590	39.5	39.405	15.1
39.670	65.6	39.585	38.8	39.400	14.4
39.665	64.9	39.580	38.1	39.395	13.7
39.660	64.3	39.575	37.4	39.390	13.0
39.655	63.6	39.570	36.6	39.385	12.3
39.650	62.9 C.P.	39.565	35.9	39.380	11.6
39.645	62.3	39.560	35.2	39.375	10.8
39.640	61.6	39.555	34.5	39.370	10.1
39.635	60.9	39.550	33.8	39.365	9.3
39.630	60.2	39.545	33.1	39.360	8.6

C. P.—Crystal check points.
S. F.—Specified Frequency

Fig. 24. Complete dial calibration, showing check points and specified frequency

a little farther in the direction of 48, until line 6 on the vernier is opposite a line on the main scale. This gives a setting of 47.6.

Checking the Calibration:

Always before making a measurement, the tunable oscillator must be checked against the built-in crystal-controlled reference oscillator. At first thought, the method for checking an oscillator for exact setting at, for example, 39.66 mc. from a 100 kc. crystal may not be clear. Actually, it is very simple, as will be explained:

The oscillations generated by a crystal contain a great number of harmonics which set up beat notes of various frequencies when a separate, coupled oscillator is tuned over a wide frequency band. It is possible, for example, to obtain a response from a 100-kc. crystal at 39.5 mc. and at 39.75 mc. These are not, of course, harmonics of the crystal frequency, but are responses produced by harmonics of the crystal in combination with harmonics of the tunable oscillator. Thus the tunable oscillator in the frequency meter could be checked for calibration at those two points. If it is correct at those check points, it follows that the calibration will be accurate at any intermediate point, such as 39.66 mc.

Of course, if the tuning range of the E.C.O. ADJ. condenser were wide enough, other crystal response frequencies would



Fig. 25. Browning calibrator setup for the test position of an assembly line

be reached. Since that would be confusing, the inductance used with the condenser is adjusted, during the original factory calibration, so that only two check points, on each side of the specified frequency, can be covered by the adjustment of the E.C.O. ADJ. condenser.

This can be seen in Figs. 23 and 24. Fig. 23 is an actual calibration chart for a meter designed for the specified frequency of 39.66 mc. Above the calibration line, the percentage of deviation is marked to correspond to dial settings which appear below the line. As the chart shows, a deviation of minus .05% is 39.64 mc., while plus .05% is 39.68 mc.

The complete calibration for the dial is given in Fig. 24, where the check points, indicated as C.P., appear at 39.75 and 39.5 mc., corresponding to dial settings of 62.9 and 27.4 divisions. Thus, when the E.C.O. ADJ. knob has been set to align the tunable oscillator with the crystal at those two dial settings, a frequency of exactly 39.66 mc. will be obtained when the dial is at 49.9 divisions.

Checking a Transmitter:

An FM or AM transmitter can be checked with this frequency meter in either of two ways: 1) by measuring the frequency at which a transmitter is operating, and reading the percentage deviation from the calibration chart, or 2) by setting the meter at the assigned frequency, and adjusting the transmitter to resonance with the meter. The same procedure is followed in either case. Here are the steps:

1. Plug the meter power cord into 115 volts, AC or DC. Turn the CRYSTAL switch to the ON position, and allow the instrument to warm up for at least 30 minutes.
2. Turn the BAND switch to the proper band for the required frequency.



Fig. 26. Circuits are provided for 2.5 and 5 mc., 5 and 10 mc., or 10 and 15 mc.

3. Plug a pair of phones into the jack provided.

4. Referring to the calibration chart for the tuning band to be used, find the dial setting for the check point nearer the assigned frequency of the transmitter, and set the dial to that reading by means of the vernier scale.

5. Adjust the E.C.O. ADJ. knob for zero beat in the phones. At this point, the eye will flutter. A further, exact adjustment will hold the eye open. This means that the tunable oscillator is exactly in resonance with a harmonic of the crystal. (Note: if the setting is in the range from 30 to 40 mc., the two oscillators will agree to an accuracy of at least 1 part in 5,000,000.)

6. Turn the CRYSTAL switch to the OFF position.

7. Extend the telescoping antenna. The meter should be within 50 ft. of the transmitter. Turn the transmitter on by pressing the push-to-talk switch on the microphone, but do not modulate the transmitter.

8. Adjust the transmitter frequency until a zero beat is obtained with the meter, using the phones and the tuning eye.

9. To determine the percentage of error in the transmitter, adjust the meter until zero beat is obtained with the transmitter. Then check the dial setting against the calibration curve. This will show the percentage of error.

Checking the Crystal:

Any portable meter of whatever make should be checked periodically against the standard frequency signals transmitted by the Bureau of Standards from station WWV in Washington. This is necessary because, unless a crystal is protected by a constant temperature enclosure, it is subject to drift.

For that reason, a slot adjustment below the dial knob, marked CRYSTAL ADJ., is provided. The tuning range of this

trimmer is so limited that it cannot be set to zero beat at other than 100 kc., the correct crystal frequency, when compared with WWV signals. The Browning model RH-10 calibrator is specifically designed for checking any frequency meter against the standard frequency signals from WWV.

CHECKING FREQUENCY METERS

The National Bureau of Standards provides a 24-hour broadcast service of standard frequencies from its radio station WWV at Beltsville, Md. Standard radio frequencies, standard audio frequencies, standard time intervals, standard musical pitch, and time announcements are available at all times. WWV's frequencies and time intervals are controlled by a 100-kc. standard frequency piezo crystal oscillator. The average frequency value is based upon and agrees with the average United States Naval Observatory time signals. All standards of frequency are ultimately referred to the period of rotation of the earth; this fundamental source might be referred to as one cycle per day or one cycle per 86,400 seconds.

The accuracy of all frequencies, radio and audio, as transmitted, is better than one part in 10,000,000. Atmospheric conditions may cause slight fluctuations in frequencies as received, but of course the average frequency is as accurate as that transmitted. The time intervals marked by pulses at every second are accurate to 10 microseconds. Time intervals of 5 minutes or longer are accurate to a part in 10,000,000. Following is the complete schedule of WWV transmissions:

2.5 mc.—7:00 P. M. to 9:00 A. M. EST (2400 to 1400 GWT) audio modulation 440 cps.

5.0 mc.—Continuous audio modulation only on hours indicated: 440 and 4000 cycles, 7:00 A. M. to 7:00 P. M.; 440 cycles, 7:00 P. M. to 7:00 A. M.

10.0 mc.—Continuous audio modulation, 440 and 4000 cycles.

15.0 mc.—Continuous audio modulation, 440 and 4000 cycles.

A .005-second pulse can be heard at every second except at the fifty-ninth second of each minute. Audio frequencies are interrupted precisely on the hour and each five minutes thereafter, resuming after an interval of precisely one minute. During the one-minute interval, Eastern Standard Time is given in telegraphic code. Voice announcements are made at the hour and half-hour.

WWV Calibrator:

The Browning standard frequency calibrator has been designed to provide in a single package a receiver and associated circuits for making full use of the WWV transmissions. The Calibrator consists of a receiver with two RF inputs, audio filters of 440 and 4,000 cycles, a low pass filter with a cutoff frequency at 400 cycles, and a cathode-ray tuning indicator at the output.

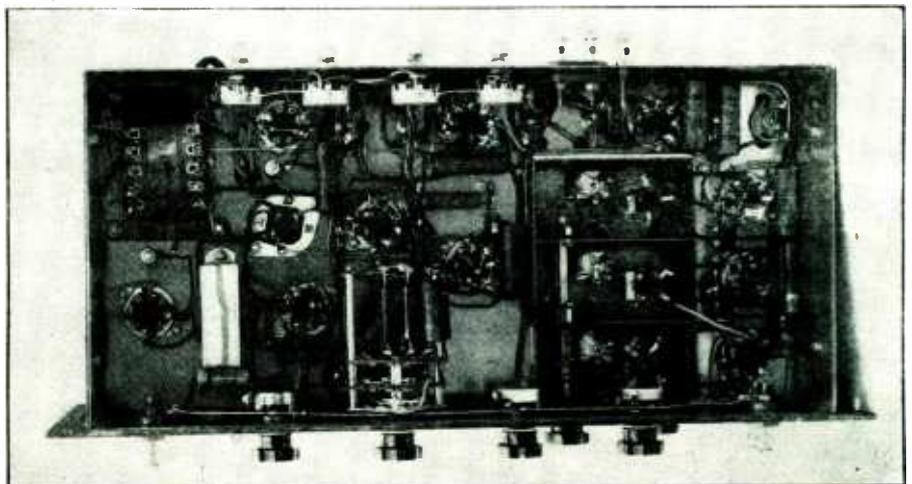

Fig. 27. Bottom view of calibrator, showing interior construction details

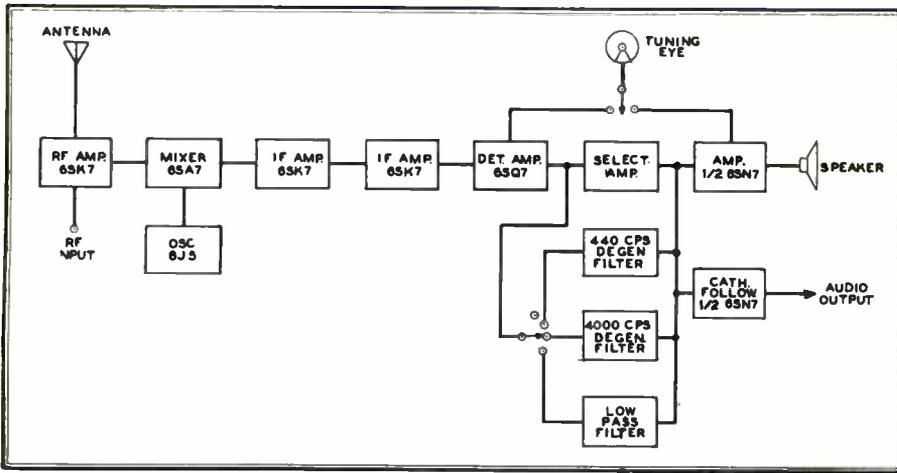

Fig. 28. Block diagram of circuits included in the Browning Calibrator

Fig. 25 shows a typical setup for this instrument at the test position of a factory production line, while Figs. 26 and 27 show the construction in detail. Circuit elements are diagrammed in Fig. 28. Three different models are available, with circuits pretuned to WWV frequencies of 2.5 and 5 mc., 5 and 10 mc., or 10 and 15 mc.

The instrument is completely self-contained. Frequencies as low as 100 kc. can be inserted directly into the RF input without the use of a harmonic generator if the amplitude is 100 microvolts or more. For audio and time interval measurements, the use of an audio oscillator and oscilloscope is necessary.

Use of WWV Carrier:

Signals which are submultiple harmonics of any of WWV's carriers can be measured to a high degree of precision. The method of measurement consists of obtaining a beat note between a harmonic of the signal under test and one of WWV's frequencies. A typical block diagram of the setup is shown in Fig. 29. The dotted lines indicate the Browning Calibrator, with the 400-cycle filter cut in.

If the purpose is to set the local signal source to a subharmonic frequency of one of WWV's carrier frequencies, it is only necessary to adjust the local signal for zero beat frequency on the oscilloscope or for no flutter of the eye of the cathode ray tuning indicator. The use of a harmonic generator, Fig. 29, is optional, but the ratio of F_w/F_x is large and sufficient harmonic amplitude is not generated in the RF amplifier grid. High orders of harmonics can be obtained easily by saturating the grid of a sharp cutoff pentode. Spurious beats caused by modulation frequencies are eliminated by use of the low pass filter in the Calibrator.

In measuring a particular frequency whose harmonics are within 10 kc. of one of WWV's carrier frequencies, the addition of a calibrated audio oscillator is necessary. The calibrated oscillator

should be connected to the horizontal plates of the oscilloscope shown in Fig. 29. A Lissajous pattern of an ellipse is seen when the calibrated oscillator is at the same frequency as the beat note. The accuracy of measurement depends very much on the accuracy of the calibrated oscillator and the frequency of the beat note. Standard oscillators are usually made to operate on submultiple frequencies of WWV, for example, 10, 50, 100,

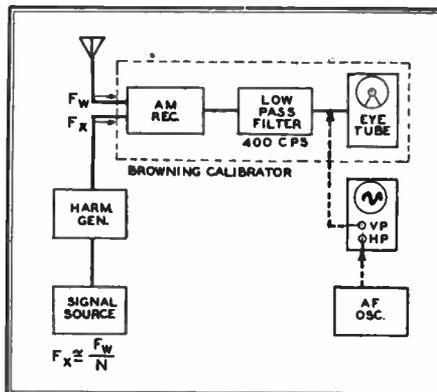

Fig. 29. Setup for RF measurements

500 kc., etc. These are seldom off in frequency more than 10 or 20 parts per 10,000,000. Beat notes of this range can be determined very accurately by a beat counter, an audio-frequency meter, a frequency bridge, or a calibrated oscillator.

Use of WWV Audio Frequencies:

By utilizing the modulation frequencies of WWV, one can compare or measure

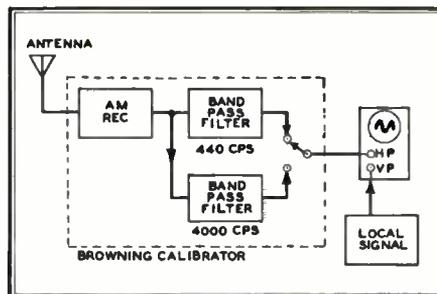

Fig. 30. Setup for AF measurements

audio frequencies which are in fractional harmonic, subharmonic, or harmonic relation. This can be better expressed by the equation:

$$f \cong \frac{K_1}{K_2} 440 \text{ or } f = \frac{K_1}{K_2} 4000, \text{ where } K_1 \text{ and } K_2 \text{ are integers.}$$

It will be noticed from Fig. 30 that this scheme requires a band pass filter to eliminate the unwanted modulation frequencies. Filtering arrangements consisting of a degenerative type of selective amplifier has proved very satisfactory.

By observing the Lissajou figures produced on the screen, the frequency relations can be determined immediately. A few examples are found in Fig. 31.

When the resulting pattern remains stationary, the ratio relations are exact. If the pattern drifts slowly, the ratio relation is not exact, but slightly higher or lower. By measuring the time required for a particular point on the pattern to travel one complete cycle along the horizontal axis, the exact ratio can be determined. The test frequency is as follows:

$$f = R \left[F_m \pm \frac{F_m}{t F_m \mp 1} \right] \approx R \left[F_m \pm \frac{1}{t} \right]$$

Approximately

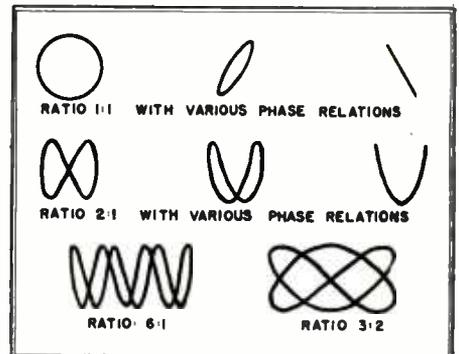

Fig. 31. Some typical Lissajous patterns

f = test audio frequency
 where F_m = WWV's modulation frequency
 t = time in seconds for a particular point to complete one cycle along the horizontal axis.

R = Ratio relation

To determine whether the local signal frequency is higher or lower than WWV's modulation frequency, the test frequency or its phase can be shifted slightly to note the direction of drift. A typical phase shift network is shown in Fig. 32. When R is increased, the direction of the travel

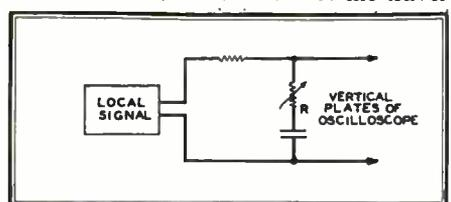

Fig. 32. A simple phase-shift network

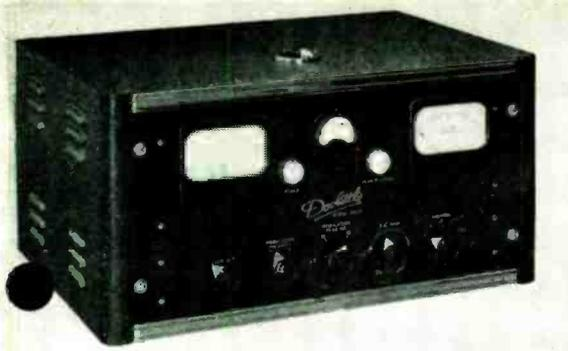

Fig. 33. Frequency & modulation monitor

taken by the pattern on the cathode-ray tube will be that of a local signal frequency higher than WWV's modulation frequency.

of this filter should be 400 cycles or less. Such a filter is provided in the Browning Calibrator.

Standard Musical Pitch:

The modulation frequency of 440 cycles corresponds to pitch A above middle C (or A4) in the Equal Tempered Chromatic Scale as adopted by the American Standards Association in 1936.

To utilize the pitch A4 to its fullest extent, it would be advisable to filter out the second pulses, 4,000-cycle modulation frequency, and noise by employing the selective amplifier at 440 cps.

interference as off-frequency operation. This monitor, illustrated in Figs. 33, 34, and 35, is intended for permanent installation at the headquarters control point of a communications system. It can be used to check frequency and modulation on any number of channels up to four, anywhere from 25 mc. to 170 mc. The number of channels and the frequency of each one must be specified when the instrument is ordered. Any channel can be shifted, but that necessitates returning the instrument to the factory.

The center-zero meter, at the left of the front panel, is calibrated in center-frequency deviation from the assigned frequency, over a range of plus and minus 15 kc. Each scale division is 1 kc. The modulation meter, at the right, is calibrated from 0 to 20 kc. A panel switch controls this meter so that it shows either positive or negative modulation. In addition, there is a peak flasher to show modulation peaks of such short duration as not to be indicated by the meter. This flasher can be set by a panel control to operate at any degree of modulation from 5 to 20 kc.

Use of the Monitor:

The monitor is operated by signals picked up from the fixed transmitter or any of the mobile units. For the former, a short length of wire is generally adequate as an antenna. However, in order to monitor mobile transmitters also, a resonant antenna should be connected to the monitor. A signal of at least 500 microvolts is necessary at the antenna terminal.

Usually, the instrument is set at the main transmitter frequency for continuous monitoring. If the mobile units are

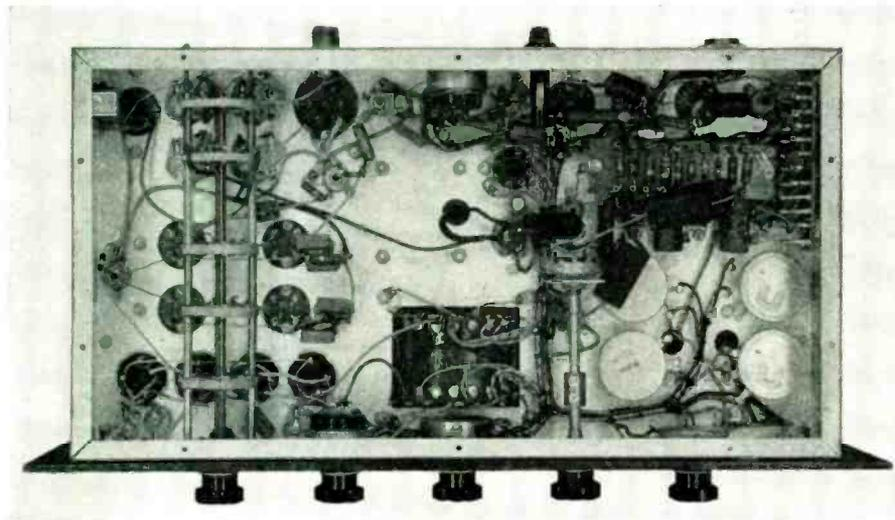

Fig. 34. Underside of monitor chassis. Band switch at left has calibrate position

Time Interval Measurements:

The accuracy of the time interval marked by a pulse every second as transmitted by WWV is better than 10 microseconds. For intervals of 1, 4, or 5 minutes the accuracy is better than one part in 10,000,000. With appropriate chronograph or oscillographic recording equipment, the second pulses can be used to measure short or long time intervals. Second pulses can also be used to control a frequency source; whether it be an electrical oscillating system or a mechanical vibration system.

Measurements of low frequencies, from 1 to 200 cycles, can be made accurately by using the second pulses. For example, assume that a test frequency of approximately 100 cycles is applied to the horizontal plates of an oscilloscope and the WWV second pulse is applied to the vertical plates. If the pulse travels along the screen and returns to its original position after three hours, or 1,080,000 cycles later, the frequency is shown to be accurate to approximately 1 part in 1,000,000.

In the foregoing operation, it is always desirable to filter out the 400- and 4,000-cycle modulation frequencies by employing a low pass filter in the audio output of the receiver. The cutoff frequency

MOBILE SYSTEM MONITORS

The Doolittle monitor, type FD-12, is designed to maintain a constant check on frequency and modulation as well, since overmodulation may cause as much

Fig. 35. This view shows the plug-in input transformer behind the filterchoke

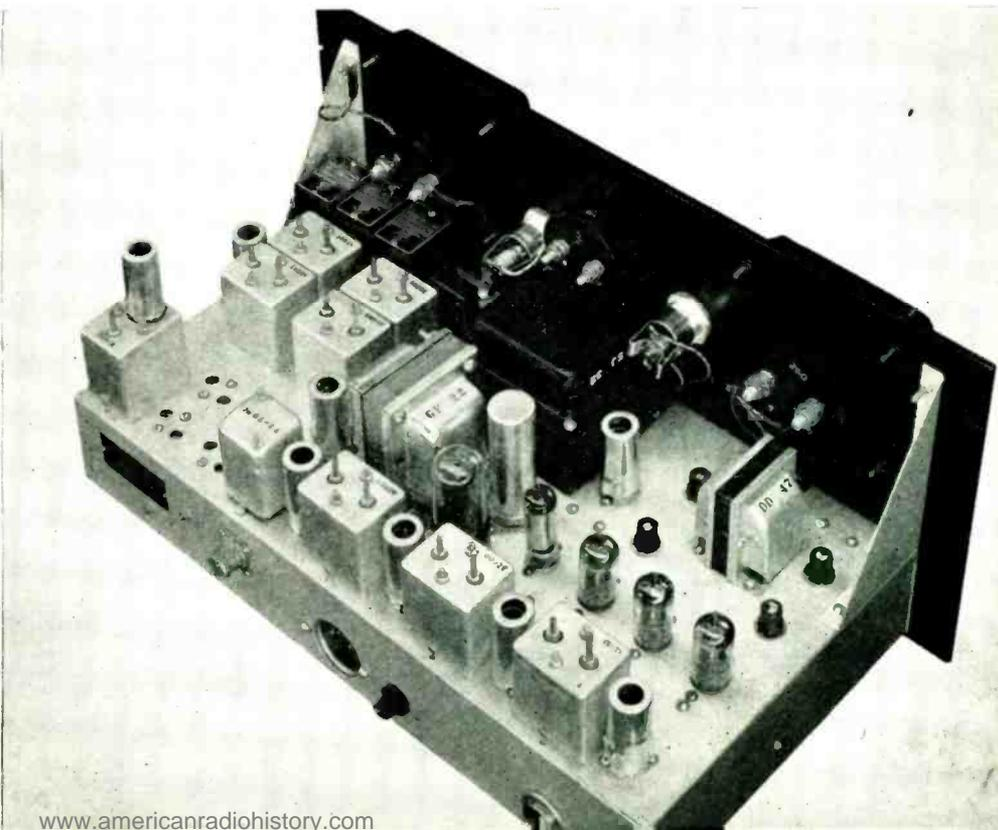

up to 65 mc. and, up to this point, no temperature control is employed for the crystals. Above 65 mc., crystals are temperature-controlled, and half-frequency injection is used above 100 mc. That is, the mixer heterodyne voltage multiplied by 2 is 5 mc. lower than the signal output frequency, or the crystal frequency multiplied by 16 is 5 mc. lower than the signal frequency.

The 5-mc. output from the converter is passed through an IF amplifier that is nearly flat for 40 kc. on each side, and on to a limiter which further smooths out the band of frequency passed.

When the frequency-modulated signal enters the discriminator, its instantaneous frequency, being displaced from the 5-mc. point, produces a voltage unbalance between the upper and lower diode resistors, Fig. 36. This upset voltage is negative or positive as the instantaneous value of frequency varies in relation to the

center frequency. The currents from both diodes pass through the carrier meter and choke in series with the center tap of the secondary of transformer T6. In this way an indication is obtained of the carrier signal applied to the diode. Finally, the net average voltage from the discriminator is fed to a 12AU7 vacuum tube voltmeter, calibrated in kilocycles deviation.

For the modulation meter, audio voltage developed across the discriminator diodes is fed through a 12AU7. One section of the tube is connected to a transformer, for aural monitoring. The other is used as a resistance-coupled amplifier to feed a 12AU7 double cathode-follower. As Fig. 36 shows, one section of this tube feeds an IN34 crystal peak rectifier for the peak voltmeter which indicates modulation in kilocycles, while the second section feeds the 2D21 gas-tube flasher circuit.

Switch S1, Fig. 36, has a calibration point marked CAL, on each contact deck. With the switch in this position, plate voltage is applied to a 6C4 oscillator using a 5-mc. crystal. This provides an accurate means for centering the tuning of the discriminator secondary. The monitor is intended for operation in room temperature of 68° F. If the temperature varies greatly from that value, it may be necessary to recenter the discriminator by this calibration method.

Equipment of this type is coming rapidly into wide use by communications systems. In fact, wherever interference conditions are serious, the first step in correcting the trouble is to determine the sources of off-frequency signals and over-modulation by careful monitoring. Field reports indicate that the cost of a precision monitor is soon offset by increased operating efficiency, both as to range and dependability of communications.

CHAPTER 11: OPERATOR LICENSES

FCC REGULATIONS CONCERNING OPERATORS IN THE MOBILE RADIO SERVICES, COMMERCIAL LICENSE REQUIREMENTS, AND INFORMATION ON EXAMINATIONS

THE number of mobile radio systems is growing much faster than the number of men qualified to operate and maintain them. This has become a serious problem to the radio manufacturers, since each new installation sold calls for the services of a licensed operator.

Also, because the FCC permits unlicensed operators to use mobile radio equipment, there has been a tendency to discount the need of engaging a licensed operator to assume full responsibility for the *adjustment* and *maintenance* of the equipment. Many local radio servicemen are capable of handling this work. Unfortunately, few of them have commercial licenses.

Because, to those not familiar with the complexities of FCC regulations, the book of Rules is highly confusing, we asked George Rollins at FCC headquarters for a simple statement on operator license requirements. In reply, we received the following official information over the signature of T. J. Slowie, Secretary of the FCC:

FEDERAL COMMUNICATIONS COMMISSION
WASHINGTON 25, D. C.

May 24, 1949

Editor, *FM-TV Magazine*
Great Barrington, Mass.

Dear Sir:

This is in reply to your letter of April 25, 1949, addressed to Mr. George K. Rollins in the Bureau of Engineering of this Commission, in which you request certain information for publication in the *Mobile Radio Handbook* regarding the operator requirements for the normal operation and servicing of mobile radio communication equipment.

As an introductory remark, it may be pointed out that any station normally transmitting telegraphy by any type of the Morse Code must be operated, during such transmissions, by the holder of an appropriate grade of radiotelegraph operator license or permit. It is presumed, however, that your inquiry relates to stations in the land mobile services which normally transmit telephony, and the balance of this discussion will have reference only to such stations.

Under the provisions of Section 318 of the Communications Act of 1934, as amended, the actual operation of all transmitting apparatus in any radio station for which a station license is required by that Act shall be carried on only by a person holding an operator's

license issued in accordance with the Act, and no person shall operate any such apparatus in such station except under and in accordance with an operator's license issued to him by the Commission; however, the Commission is authorized, under certain conditions, to waive the above requirement to the extent that public interest, convenience, or necessity would be served thereby.

The duties of a radio operator, with respect to any licensed station, include not only the handling of communications, the manipulation of on-off controls, and the keeping of station logs (if required) but also, in a larger sense, the performance of any technical duties with respect to that station which may affect the proper operation of the station and its compliance with the terms of its license and with the Commission's Rules and Regulations. By reference to Sections 13.61 and 13.62 of the Commission's Rules Governing Commercial Radio Operators,¹ it will be seen that, with respect to fixed, land, base, and mobile radiotelephone stations in the land mobile services, only the holders of radiotelephone or radiotelegraph first- or second-class operator licenses are authorized to perform all the above functions. As a condition to the authorization of holders of Restricted Radiotelephone or Radiotelegraph Permits to perform a portion of those duties, Section 13.61 specifies that:

1. Such operator is prohibited from making any adjustments that may result in improper transmitter operation; and

2. The equipment must be so designed that none of the operations necessary to be performed during the course of normal rendition of service may cause off-frequency operation or result in any unauthorized radiation; and

3. Any needed adjustments of the transmitter that may affect the proper operation of the station must be regularly made by or in the presence of an operator holding a first- or second-class license, either radiotelephone or radiotelegraph, who shall be responsible for the proper operation of the equipment.

Commission Order No. 183 and the various Parts of the Commission's Rules and Regulations which govern the land mobile services provide that certain classifications of stations in these serv-

ices, particularly mobile stations operating on frequencies above 30 mc., may be operated during the course of normal rendition of service by individuals, authorized to do so by the station licensee, who hold no radio operator license of any class, but that the same conditions apply to such operation as would apply if the stations were operated by holders of Restricted Radiotelephone or Radiotelegraph Permits. It follows, therefore, that regardless of whether a given station may be operated during the course of normal rendition of service by an unlicensed individual or whether the holder of at least a Restricted Permit is required to perform those functions, in either case any tests or adjustments coincident with the installation, service, repair, or maintenance of the transmitting apparatus must be performed by or under the immediate supervision and responsibility of the holder of a valid first- or second-class radiotelephone or radiotelegraph operator license.

In the case of a station licensee who does not have in his employ on a full-time, regular basis an operator holding a license valid for the unlimited performance of all operating duties at that station, such an operator must be available to perform those duties which only he is authorized to perform, or the station must be shut down until such an operator can be obtained, whenever conditions require any adjustments, repairs, or maintenance which might affect the proper operation of the station. It may be emphasized that the independent serviceman who may be on call or under contract to perform installation, repair, service, or maintenance duties may not perform adjustments or tests that might affect the proper operation of the station unless he holds at least a second-class radiotelephone or radiotelegraph operator license, or unless he performs those duties under the immediate supervision and responsibility of an operator holding such license. The mere fact that an operator holding this grade of license is employed by the station licensee is not sufficient; at least one such operator must be responsible for any transmitter adjustments and tests during or coincident with the installation, servicing, and maintenance of any radio station which may affect the proper operation of that station, and such properly-licensed operator must either perform those duties or they must be performed under

¹Obtainable from the U. S. Government Printing Office, Washington 25, D. C. The price is 5c. Do not send stamps.

his immediate supervision and responsibility. It is the sense of this requirement that the responsible licensed operator will be near by and within hearing and immediately available to the other person whom he is supervising. The licensed operator may not undertake to exercise his supervision and responsibility by means of telephone or similar devices.

In further connection with the above discussion, it may be well to point out that the responsible operator, in every case where service and maintenance duties are performed, is required by Section 13.75 of the Rules to sign and date an entry in the log of the station concerned, or in the station maintenance records if no log is required, giving:

1. Pertinent details of all service and maintenance work performed by him or under his supervision;

2. His name and address; and

3. The class, serial number and expiration date of his license, except that the information called for by 2. and 3. above, so long as it remains unchanged, is not required to be repeated in the case of a person regularly employed on a full-time basis at the station.

T. J. SLOWIE, *Secretary*

The important points to be noted from Mr. Slowie's letter follow:

1. Operators of mobile or portable transmitting equipment in the land mobile radio services, where frequencies above 30 mc. are used for telephone operation, need not have licenses. However, they are prohibited from making any adjustments "which might affect the proper operation of the station," except as provided in the following paragraph.

2. Any tests or adjustments concerned with installation, service, repair, or maintenance, or which affect the proper operation of the station, *must* be made by or under the direct supervision of a person holding either a first- or second-class radiotelephone or radiotelegraph operator's license. "Direct supervision" means personal presence, within voice range. Such a licensed operator must be responsible for proper operation of the station.

3. Every time service or maintenance duties are performed, the responsible operator must enter in the station log or maintenance record the details of the work done by him or under his supervision. He must also include his name and address, and the class, serial number, and expiration date of his license, unless he is regularly employed full-time at the station.

License Provisions:

Only United States citizens, who are found qualified by the FCC, are eligible for radio operator licenses. A license will not be issued to any person whose pre-

vious commercial radio operator license is under suspension, or who is involved in any litigation based on alleged violation of the Communications Act.

Commercial licenses issued by FCC are:

1. First- and second-class radiotelephone.

2. First- and second-class radiotelegraph.

3. Restricted operator's licenses in both categories.

The restricted operator's licenses are the ones which were waived by FCC by its order of June 1, 1946, for operators in mobile radio services.

Commercial operator licenses are normally issued for a term of 5 years from issue date. Only one radiotelephone and one radiotelegraph license is issued to an individual at one time.

Applications for new licenses, properly completed and signed, together with all required subsidiary papers, should be mailed or brought in person to the FCC field office from which it is desired that the license be issued. (At the end of Chapter 3 is a list of all FCC field offices and their mailing addresses.) That office will then make arrangements for conducting the required examination.

Examinations:

Written examinations are comprised of questions from one or more of the following examination elements:

ELEMENT 1. *Basic Law.* These questions are answered in essay form. There are ten questions: three on the Communications Act of 1934, two on the International General Radio Regulations (Cairo Revision), and five on the Rules and Regulations of the FCC. 10 per cent is allowed for each question answered correctly.

ELEMENT 2. *Basic theory and practice.* These are questions on basic technical matters which are required for every class of license except restricted radiotelephone. There are fifty questions, and 2 per cent credit is granted for each correctly answered. No credit is allowed for unanswered questions, or if more than one answer is given, or for partially correct answers. Slide-rule computations are allowed, and normal slide-rule accuracy is accepted.

ELEMENT 3. *Radiotelephone.* This element covers more advanced legal and technical matters. The same conditions apply to element 3 as to element 2.

ELEMENT 4. *Advanced radiotelephone.* Element 4 is composed of the same type of questions as in elements 2 and 3, and the same questions apply. However, element 4 questions are more difficult than those in elements 2 and 3, and are directed toward broadcast matters.

ELEMENT 5. *Radiotelegraph.* Legal

and technical questions, covering general radiotelegraph theory and practice. Fifty questions, given under the same conditions listed for element 2.

ELEMENT 6. *Advanced radiotelegraph.* This element covers radiotelegraph theory and practice of wider scope, emphasizing ship radio matters such as direction finders and ship radiophone stations. The same conditions apply as are listed for element 2.

Applicants for original licenses are required to pass examinations on the following elements, with the additional qualifications as noted:

1. *Radiotelephone, second class.* Must be able to transmit and receive spoken messages in English, and to pass written examination elements 1, 2, and 3.

2. *Radiotelephone, first class.* Must be able to transmit and receive spoken messages in English, and to pass written examination elements 1, 2, 3, and 4.

3. *Radiotelegraph, second class.* Must be able to transmit and receive spoken messages in English, to transmit and receive code groups at 16 code groups per minute, and to pass written examination elements 1, 2, 5, and 6.

4. *Radiotelegraph, first class.* Must be able to transmit and receive spoken messages in English, to transmit and receive plain language code at the rate of 25 words per minute, and 20 code groups per minute, and to pass written examination elements 1, 2, 5, and 6. An applicant for this class of license must be at least 21 years of age, and must have had an aggregate of 1 year of satisfactory service as a radiotelegraph operator manipulating the key of a manually-operated ship or coastal telegraph station.

Examinations are taken in English and are written in longhand. Ink must be used throughout except for diagrams, which may be in pencil.

The minimum passing mark is 75 per cent of each possible 100 per cent, on *each element* of a written examination. An applicant who fails an examination element is ineligible for 2 months to be reexamined, or to take an examination for any other class of license requiring that element. If all requirements are fulfilled and all examination elements passed, a license will be issued without further application. No fees are charged for any class of license, except the aircraft radiotelephone operator authorization issued by pilot examiners. A maximum charge of \$1.00 is permitted for these authorizations.

The FCC has prepared a pamphlet entitled *Study Guide and Reference Material for Commercial Radio Operator Examinations*, which is available from the Superintendent of Documents, U. S. Government Printing Office, Washington 25, D. C. The price is 25 cents in coin.

This pamphlet contains about 250 sample questions on each examination element, plus an appendix containing all study material necessary for examination element 1. Tables of radiotelegraph code abbreviations are also included. Since there have been revisions in recent years it should be stated, when ordering the pamphlet, which class of license or which examination elements are required. The applicable supplements will then be provided.

The FCC has set no educational standards as license requirements. There are many excellent correspondence courses in radio available, and many radio training schools throughout the country. Some schools guarantee successful license examinations after completion of their courses. Veterans can secure helpful information on approved schools from the Veterans Administration, Washington 25, D. C., or from their local VA offices.

New Class and Renewals:

The holder of a license who applies for a higher or new class of license is required to pass only the added examination elements pertaining to the new class. When a higher-class license in the same category is issued, the old license is automatically cancelled.

If the application is for a license renewal, it must be submitted during the last year of the license term, and must be accompanied by the old license. A signed copy of the application can be exhibited in lieu of the license while the application is being processed.

Station licensees or their agents are required by law to endorse the service records appearing on the licenses of commercial radio operators in their employ. This endorsement must show the call letters and types of emission of the station, the nature and period of employment of the radio operator, and the degree of proficiency with which he performs his duties.

No examination is necessary for license renewal, provided that the service record on the old license shows either 3 years aggregate service as a radio operator under that license, or 2 years aggregate service, of which 1 year must have been continuous and served immediately prior to the date of application for renewal.

If these requirements are not met, but the service record shows at least 3 months of satisfactory service during the last 3 years of the license term, a renewal examination must be taken before the license is re-issued. This examination

can be taken any time during the last year of the license term. It consists of the same elements as for the original license, but is directed toward a determination of the applicant's fitness to retain his license. However, if the service record is not acceptable, or if the renewal examination is not successfully completed before the expiration date of the license, the applicant must take an examination as for an original license.

In the event that a license is lost or mutilated, the FCC office which issued the license must be notified at once. The holder should then apply for a duplicate license, including with his application a statement of the circumstances involved. If the license has been lost, he must state further that a reasonable search has been made for it, and that if the license should subsequently be found he will return it or the duplicate for cancellation. In addition, the applicant must submit documentary evidence of his service under the original license, or a statement under oath embodying that information.

When a person holding an operator's license has legally changed his name, a corrected license is issued to him upon proper application. This must include the old license and documentary evidence of the legality of the name change.

Verification cards, which can be carried on the person, are issued upon proper application accompanied by the original license. This card can be used when operating any station at which posting of the original operator's license is not required, provided that the license is readily accessible for inspection upon demand by an authorized Government representative.

Operator Responsibility:

As stated previously, a licensed operator must be responsible for all adjustments made on transmitters which affect their proper operation.

In the land mobile radio services, the licensed operator may be on duty at any point within the communication range of the stations he is responsible for while the stations are in actual operation, provided that they are "within his effective control." A licensed operator who takes part in the actual operation of the stations, as distinguished from one who does only service or maintenance work, must post his original license in a conspicuous place at the station he operates. If he takes part in the operation of more than one station, he must post his license at one station, and verified statements, issued for this purpose by an FCC field

office, at the others. Those who do not take part in station operation may keep their licenses or verification cards on their persons.

Radio operators are forbidden to damage, or permit to be damaged, any radio apparatus in the licensed radio station. Unnecessary, unidentified, or superfluous communications may not be transmitted, or obscene or profane language. Neither may a licensed operator transmit call letters or deceptive signals not assigned to his station, nor maliciously interfering signals. It is against the law for a licensed operator to assist another person to obtain a fraudulent license, or to obtain one himself.

Authority and Privileges:

The holder of a radiotelephone first-class license may operate any station except:

1. Stations transmitting telegraphy.
2. Ship stations licensed to use telephony for communication with coastal telephone stations, if power output is over 100 watts.

The holder of a radiotelephone second-class license may operate any station except:

1. Stations transmitting telegraphy.
2. Ship stations licensed to use telephony for communication with coastal telephone stations, if power output is over 100 watts.

3. Standard broadcast stations, AM, FM, or TV.

4. Non-commercial educational FM broadcast stations with power output over 1 kilowatt.

Operators holding any class of commercial license may operate any experimental station using frequencies solely above 300 mc.

The holder of a radiotelephone operator's license may transmit telegraphy on the same station and at the same frequency on which he normally transmits telephony, under the following conditions:

1. When transmitting telegraphy by automatic means for identification, for testing, or for actuating an automatic signalling device.

2. When his station is serving as a relay, and retransmitting automatically the signals of a radiotelegraph station. This may be done only on frequencies above 50 mc.

3. When transmitting telegraphy as an incidental part of a broadcast program, intended to be received by the general public.

CHAPTER 12: GENERAL FM THEORY

SECTION 1: A DISCUSSION OF THE BASIC DIFFERENCES BETWEEN AM AND FM. THE THEORETICAL AND PRACTICAL ADVANTAGES OF FM. WAVEFORM ANALYSES.

RECENT years have witnessed the growth of a new system of radio communication, which is having a revolutionary effect upon nearly all branches of the radio art. This system, invented by Major Edwin H. Armstrong, is sometimes referred to as "Wide-Band Frequency Modulation." More often, it is simply called "FM."

Not only does FM provide transmission in which distortion is reduced to a very low order, but it virtually eliminates noise at the receiver, whether this noise be of atmospheric or man-made origin. Furthermore, uncertainties due to interference between stations and changing propagation characteristics which affect AM circuits are overcome by FM. For these reasons, FM has gained a firm foothold in radiotelephone communications as well as in the broadcasting industry. Also, FM has made possible many new services, while others have been converted from AM to FM.

The highly desirable characteristics of FM are due in part to the nature of the frequency-modulated wave and in part to the design of the FM receiver. In order to gain an insight into the methods whereby the vast improvement in reception is obtained, it is necessary first of all to understand the basic differences between the amplitude and frequency modulation

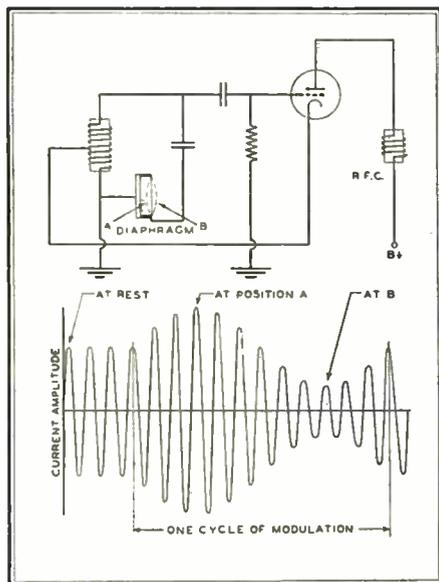

FIG. 1. ELEMENTARY AM TRANSMITTER

systems of radio telephone transmission and reception.

Modulation ★ The continuous transmission

of a radio wave of constant amplitude, or output power, and unvarying frequency conveys no information to the listener, other than that an unidentified station is on the air. It becomes possible to transmit intelligence on the wave only when one of the characteristics of the wave, such as its amplitude or its frequency, is subjected to a controlled variation at the transmitter. Modulation is the process of varying the amplitude or the frequency of the wave in accordance with the instantaneous variations of a control device, such as a telegraph key or a microphone.

Amplitude Modulation ★ When the power output of a radio transmitter is made to vary above and below an average level in keeping with the vibrations of a microphone diaphragm, as in Fig. 1, the transmitter is said to be amplitude-modulated.

The transmitter in Fig. 1 is of the most elementary type, but will serve to illustrate a method by which amplitude modulation can be accomplished. The circuit is that of a tuned-grid triode oscillator in which an inductive load in the plate circuit causes regenerative feedback by way of the plate-grid capacity of the tube. If the losses in the tuned circuit are compensated for by the transfer of energy from the plate to the grid circuits, a radio frequency current will be generated in the tuned circuit. The frequency of this current is determined by the values of inductance and capacity in the tuned circuit. The amplitude of the current will depend upon the resistance of the tuned circuit, assuming that the plate supply voltage and other factors remain constant.

Most of the resistance in the tuned circuit is introduced by the carbon-button microphone in series with the coil and the condenser. When the diaphragm is at rest, the resistance of the microphone limits the current to a definite level, and the transmitter sends out a wave of constant amplitude. As mentioned previously, the presence of the unmodulated wave can be detected in a receiver but the wave is incapable of transmitting intelligence in itself; it serves merely to establish a channel between the transmitter and the receiver, over which intelligence can be sent by modulation. The unmodulated wave, therefore, is termed the "carrier."

If a sound wave now strikes the microphone, the vibration of the diaphragm causes the carbon granules to be subjected alternately to increased and decreased pressure. The resulting respective decrease and increase of microphone resistance causes the output of the transmitter to

rise and fall in accordance with the volume and frequency of the sound, as shown in Fig. 1. The frequency of the wave remains the same since the inductance and capacity of the tuned circuit are not altered appreciably during modulation.

Frequency Modulation ★ An elementary circuit for the production of a form of frequency modulation is shown in Fig. 2. Here the carbon microphone of Fig. 1 has been removed and a condenser microphone is placed in parallel with the condenser of the tuned circuit. The oscillator generates a current of a frequency determined by the inductance of the coil and by the sum of the capacities across the coil. When a sound wave strikes the microphone, the diaphragm is first flexed toward the back plate, increasing the microphone capacity and hence also increasing the total capacity acting across the coil. This causes the oscillator to generate a lower frequency. Subsequently the diaphragm

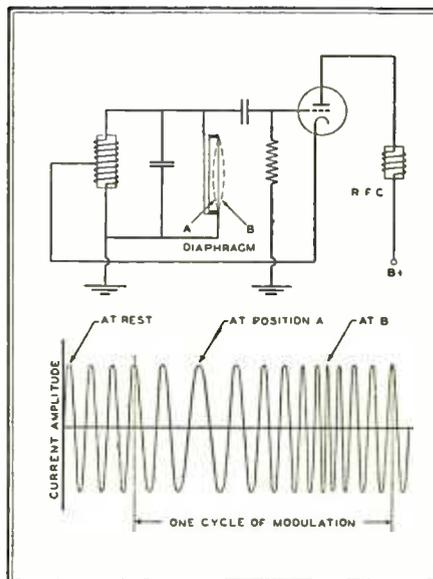

FIG. 2. ELEMENTARY FM TRANSMITTER

is flexed away from the back plate and the frequency of the oscillator is increased, because of the reduction in the amount of capacity in the tuned circuit. If a louder sound is made at the microphone, the diaphragm is flexed more in each direction, and the frequency is varied to a greater extent. In both cases, since the frequency of the generated wave has been varied above and below an average value by the action of sound waves on the microphone, a form of frequency modulation has been produced. Note that nothing

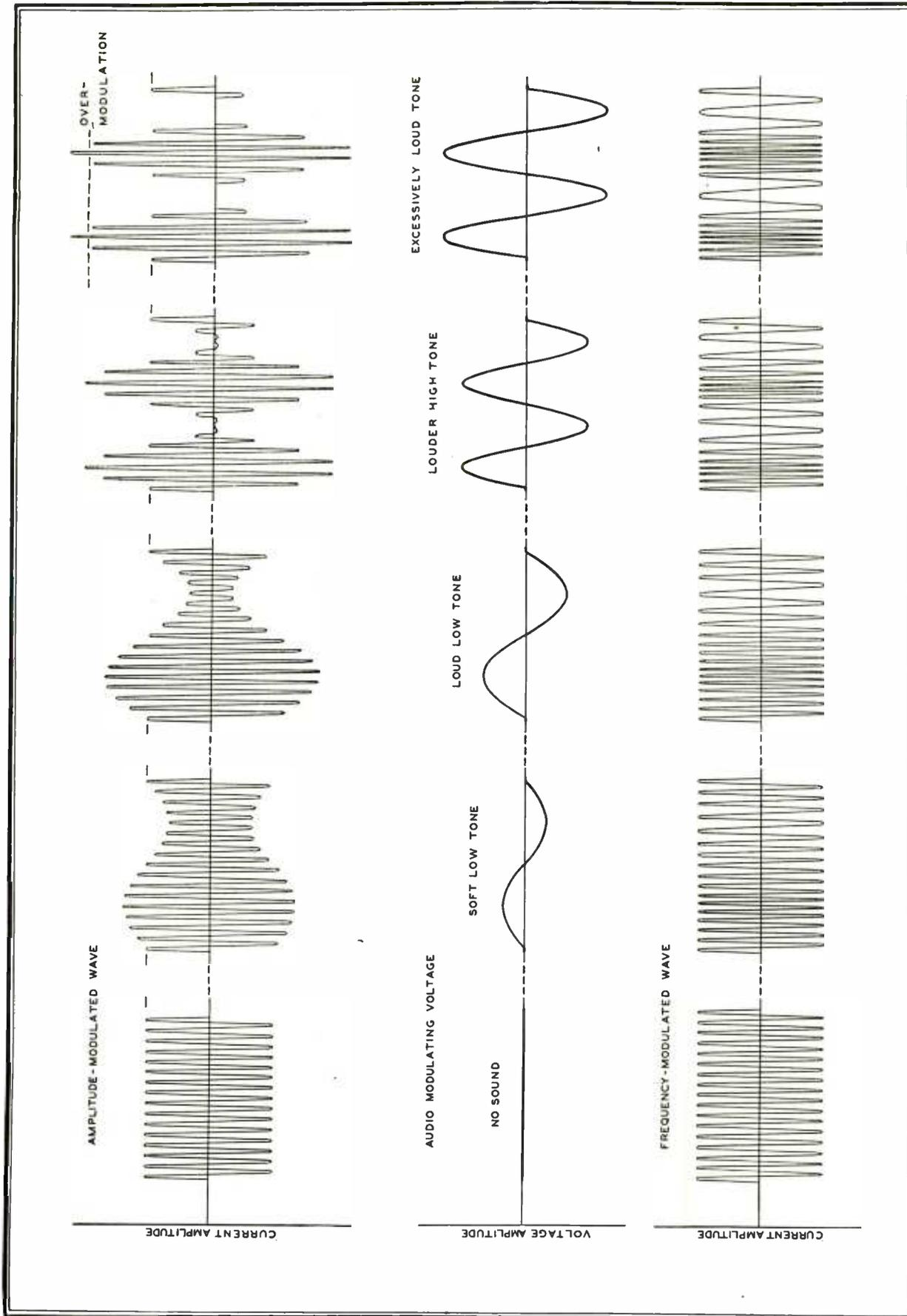

FIG. 3. CENTER, MODULATING VOLTAGE DUE TO AUDIO FREQUENCIES DIRECTED INTO THE MICROPHONE. TOP, RESULTING MODULATION OF AM TRANSMITTER OUTPUT, SHOWING THAT RF FREQUENCY IS CONSTANT, WHILE OUTPUT CHANGES. BOTTOM, RESULTING MODULATION OF FM TRANSMITTER OUTPUT. THE OUTPUT IS CONSTANT, BUT MODULATION CHANGES THE RF FREQUENCY

has occurred during modulation to affect the power output. Hence the amplitude of the generated wave is constant during modulation.

Effects of Modulating Amplitude and Frequency ★
The contrast between the amplitude-modulated and frequency-modulated carrier wave will be emphasized by a consid-

eration of what occurs when the amplitude or the frequency of the modulating voltage is changed. In Fig. 3, the audio frequency modulating voltage and the resulting am-

plitude- and frequency-modulated carrier waves are plotted to equal scales of time.

At the extreme left is illustrated the condition of zero modulation. It will be observed that the outputs of the amplitude- and the frequency-modulated transmitters are exactly identical, both being of constant amplitude and unvarying frequency.

Next to the right is shown a condition of slight modulation at a low frequency, such as would occur when a soft, low-pitched note is sounded at the microphone. In the case of the amplitude-modulated wave, the output power rises and falls over a narrow range, in keeping with the very low level of the modulating voltage. In the case of the frequency-modulated wave directly beneath, there is no change in output, but the frequency is increased and decreased slightly, at a rate corresponding to the modulating frequency, and to an extent corresponding to the low volume level.

Next to the right in Fig. 3 is shown the effect of an increase in the amplitude of the modulating voltage, the frequency of the modulating voltage remaining unchanged. This condition would be caused when the same low-pitched note is sounded at the microphone with greater intensity. The successive radio frequency peaks of the amplitude-modulated wave vary over a greater range, in accordance with the increased amplitude of the modulating voltage, but the time taken to complete cycle of variation is the same.

The frequency-modulated wave is observed to rise to a higher frequency and to fall to a lower frequency than before, but going through this cycle of change at the same rate as before.

Further to the right are shown the forms of the modulating and the modulated waves when both the frequency and the amplitude of modulation are increased. This is equivalent to sounding a louder and higher-pitched note at the microphone. In the case of the amplitude-modulated wave, the modulation peaks and troughs are more pronounced, and are created at a higher rate. The frequency-modulated wave still has no variation of its amplitude, but shifts to higher and lower frequencies than before, and completes each cycle of frequency variation at a faster rate.

If the amplitude of the modulating voltage is increased still further, as shown at the extreme right in Fig. 3, so that the negative peak of modulation would tend to exceed the carrier amplitude, then the amplitude-modulated wave is rendered discontinuous and severe distortion of the wave form of the modulation results. This limitation upon the extent of modulation is inherent in the amplitude-modulated wave. Under the same condition of modulating voltage, the frequency of the frequency-modulated wave would simply increase and decrease over a still greater range, the limitations of the range

being set by the transmitting and receiving equipment rather than by the nature of the wave.

Analysis of AM Wave * From the above physical concepts of the two types of modulated waves, certain points of contrast are already evident. Other significant differences can be discovered when each of the waves is analyzed with a view to learning the nature of its components.

At the top of Fig. 4 is shown a wave of radio frequency F that is being subjected to amplitude modulation by a modulating voltage having a sine wave form and an audio frequency F_M .

In describing the extent of the modulation, it is customary to state the percentage relationship which the maximum variation from carrier amplitude bears to the carrier amplitude itself. For example, if the amplitude of the modulated wave on a positive modulation peak is twice the carrier amplitude, then the percentage of modulation is $100(2 - 1)/1$ or 100 per cent. Similarly, if the amplitude rises to 1.5 times carrier amplitude at a positive peak of modulation, the modulation per-

centage is $100(1.5 - 1)/1$ or 50 per cent.

However, in describing the extent of modulation in equations of the wave, it is more convenient to use the modulation factor symbol M , which is the decimal equivalent of the modulation percentage. The condition shown in Fig. 4 is that of 100 per cent modulation, equivalent to a modulation factor M of 1.0.

In writing the equation immediately beneath the diagram of the wave, it has been arbitrarily assumed that the modulated wave begins (when t equals zero) at the positive maximum of the modulation cycle. This assumption has been made solely to facilitate the construction of a clear drawing, and accounts for the difference between the equation shown and other equally correct forms which may be encountered in textbooks.

By using the trigonometric identity shown (for readers who are interested in the mathematical procedure) the equation is rewritten in the form which indicates that the amplitude-modulated wave may be regarded as the sum of three components: 1) A component of the same amplitude and frequency as the unmodulated

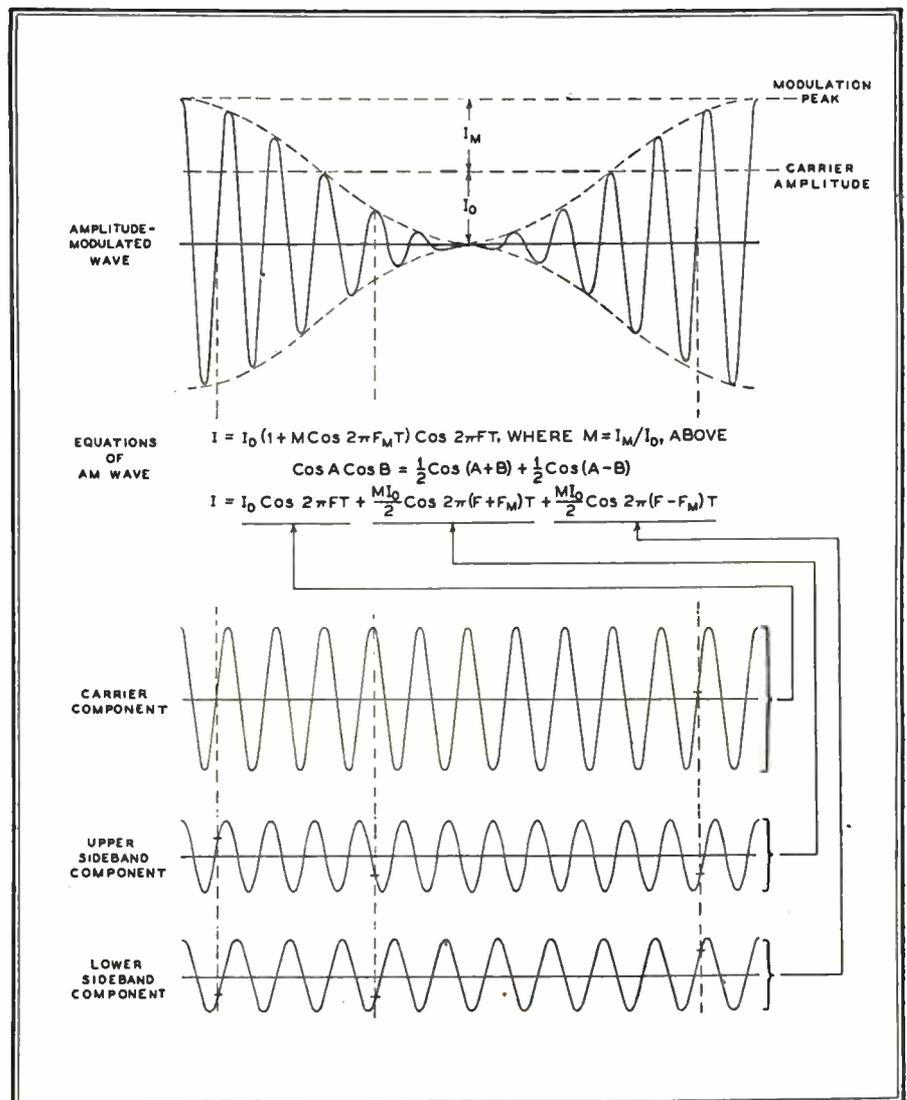

FIG. 4. THE AM WAVE AND ITS COMPONENTS AT 100% MODULATION

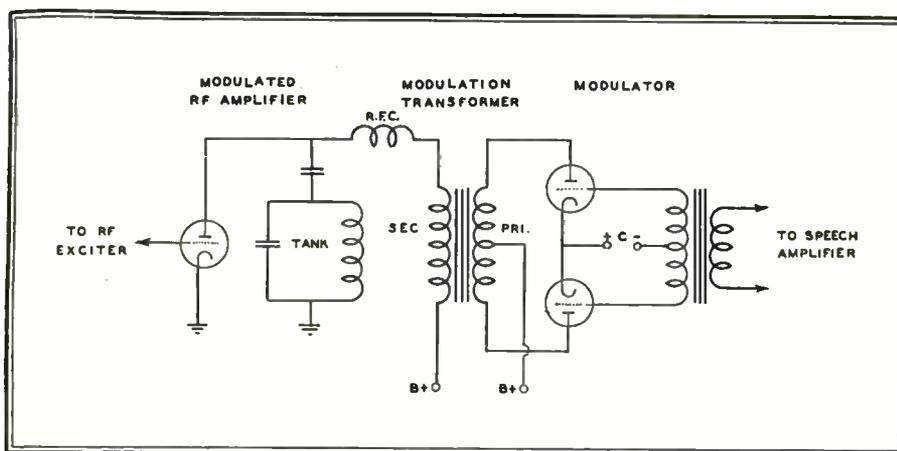

FIG. 5. THE CIRCUIT ELEMENTS OF AN AM TRANSMITTER

wave, usually termed the carrier component; 2) a component whose frequency is higher than that of the carrier by the amount of the modulation frequency, and whose amplitude is directly proportional to the modulation factor, but never exceeding half the carrier amplitude (called the upper sideband component); 3) a component whose frequency is lower than that of the carrier by the amount of the modulation frequency and whose amplitude is the same as that of the upper sideband component. This component is called the lower sideband.

The carrier and the sideband components have been drawn underneath the modulated wave to a common scale of time in order to facilitate graphical proof that the sum of the carrier and sideband components at any instant will equal the value of the modulated wave at the same instant. The vertical dotted lines representing several instants selected at random will aid in checking this point.

It may be remarked here parenthetically that many laymen unfamiliar with the methods of mathematical analysis doubt the reality of sidebands; others, acknowledging that sidebands may exist, are inclined to question the propriety of looking upon the amplitude-modulated wave as a single-frequency variable-amplitude affair in one instance and as the sum of three different frequency components of constant amplitude in another instance.

The cardinal principle that guides the mathematician in this matter is the axiom which states that the whole is equal to the sum of all its parts. Once it has been definitely established that a given whole is equal to the sum of certain components, thereafter the whole, or the expressed sum of all the components of the whole, can be used interchangeably. It is only necessary to observe all the laws of algebra and to account for all components. Whether the whole or the expressed sum of all the components of the whole will be employed is merely a choice of convenience for attacking the problem at hand.

This principle finds very wide usage in all mathematical work. For example,

to find the complement of an angle of 25° , one subtracts 25 from 90° . However, to find the complement of an angle of $37^\circ 15' 22''$, one subtracts from $89^\circ 59' 60''$.

Similarly, when describing the operation of a device that is responsive to voltage amplitude, such as a diode detector, the amplitude-modulated wave will be regarded as having a single frequency and a variable amplitude. On the other hand, when considering the effects of a tuned band pass circuit upon an amplitude-modulated wave, it is more convenient to consider the wave as the sum of a carrier component and sidebands, because the effects of the circuit upon the different frequency components may not be the same. To keep the amplitudes of the sideband components and the carrier in their original proportion with respect to each other, the band-pass circuit must pass all three frequencies with equal ease. This demands that the band width be twice the modulating frequency and that its tuning be centered on the carrier frequency. In the usual case where the wave is subject to amplitude modulation at various modulating frequencies, the band width must be twice the *highest* modulating frequency, in order that the amplitudes of the high audio frequency components of the reproduced sound at the receiver may have the same proportion with respect to the low audio frequency components as exists at the microphone.

From the analysis of the wave shown in Fig. 4, it is also evident that during modulation the amplitude of the carrier frequency component is unaffected, but two sideband components are added. This means that the power in an amplitude-modulated wave is greater than that in an unmodulated wave by the sum of the two I^2R products of the sideband currents. What is the source of this extra power? What is its significance in transmitter design?

The essential elements of a modern amplitude-modulated transmitter circuit are shown in Fig. 5. At the left is a radio frequency amplifier which is excited from an oscillator, either directly or through

one or more intermediate amplifiers. At the right in the diagram is an audio power amplifier or modulator whose output voltage is applied in series with the plate supply voltage of the radio frequency amplifier.

In the absence of modulation, the voltage across the secondary of the modulation transformer is essentially zero, and the amplitude of the radio frequency output is determined by the RF amplifier plate voltage. Power is drawn only from the DC plate voltage source and a portion of this power is converted to the RF carrier output of the amplifier.

When sound waves strike the microphone at the studio, the modulator is excited at audio frequency through a chain of speech amplifiers, and an audio modulating voltage appears across the secondary of the transformer. This voltage alternately adds to or subtracts from the plate supply voltage of the RF amplifier causing a proportionate increase and decrease in the RF amplifier plate current. The RF oscillations set up in the tuned circuit (tank) by the plate current pulses undergo the same audio frequency variation of amplitude.

During modulation the *average* plate current drawn from the DC plate supply of the RF amplifier remains unchanged, because for each pulse whose amplitude exceeds the unmodulated value by a certain amount, there is another pulse, 180° later in the modulation cycle, whose amplitude is less than the unmodulated value by the same amount. With both the average current and the voltage of the DC plate supply unchanged, this source furnishes the same amount of power as when there is no modulation. It follows that the extra power furnished to the RF amplifier for the generation of sidebands during modulation is the audio frequency power output of the modulator, derived from the DC plate supply of the modulator tubes.

Under a condition of complete or 100 per cent modulation, the amplitude of each sideband is one half that of the carrier. Since the power expended in a fixed amount of resistance varies as the square of the current amplitude, each of the sidebands represents one fourth as much power as the carrier. The total power in *both* of the sidebands may therefore be as great as one half that in the carrier. Furthermore, the modulator must also furnish the power dissipated in the radio frequency amplifier in the course of its generation of the sidebands. Suppose the rated carrier output of the transmitter is 1,000 watts, and the efficiency of the final radio frequency amplifier is 60%. At 100% modulation, the sideband power is 500 watts and the modulator is called upon to furnish $500/.6$ or 833 watts of audio power, not including modulation transformer losses!

There are several stratagems available to the designer for reducing such large

audio power requirements. For example, the final stage may be modulated in the grid circuit rather than in the plate circuit, or the stage before the final may be modulated. However, it is not practical to attempt amplitude modulation at an early, low power stage, and to employ a chain of several linear amplifiers to bring the modulated wave up to a high power level; it is too difficult to adjust linear amplifiers for good linearity. Thus in transmitters of moderate or high power output employing amplitude modulation, the modulation is effected at or near the final amplifier stage. In general, therefore, tubes of the *power* rather than the *voltage amplifier* type are used in the modulator.

Of greater importance is the fact that on peaks of 100% modulation the radio frequency amplifier must deliver four times as much power as during carrier level condition. It is necessary that the tubes have adequate filament emission to supply a momentary two-fold increase in plate current over that occurring at carrier level. Also, the *average* power delivered during a cycle of 100% modulation is half again as great as the power furnished at carrier level. Thus the output obtainable from tubes in an AM final amplifier is only about two thirds that obtainable in an application where the amplitude is constant, as in FM. Hence tubes in AM final amplifiers operate at relatively low efficiency.

Summary of AM ★ The salient points about amplitude modulation, which will presently be contrasted with conditions found in frequency modulation, may be summarized as follows:

1. The amplitude of the wave, or the radiated power, is varied during modulation but its frequency is unchanged.

2. A higher modulating frequency increases the rate at which the amplitude is varied.

3. An increase in the amplitude of the modulating voltage causes the amplitude of the transmitted wave to vary over a wider range.

4. The limits of the range over which the amplitude can be varied is determined by the carrier amplitude. If the negative modulation peak tends to exceed the carrier amplitude, it is not reproduced and the wave is rendered discontinuous, which results in serious distortion.

5. When subjected to amplitude modulation at a single modulating frequency of sinusoidal wave form, the AM wave becomes the sum of three components, a carrier identical in frequency with the unmodulated wave, and a pair of sideband components of frequencies above and below the carrier by the amount of the modulation frequency.

6. The modulation factor is defined as the ratio of the maximum variation from carrier level during modulation to the unmodulated carrier amplitude. As the modulation factor is increased, the amplitudes of the upper and lower sidebands increase in the same proportion, reaching a maximum of half the carrier amplitude when the modulation factor is at its maximum value of 100 per cent. The amplitude of the carrier component of the wave is unchanged during modulation.

7. Since only one pair of sidebands is produced during amplitude modulation, a band width of twice the modulating

frequency is sufficient for satisfactory passage of the amplitude-modulated wave under any degree of modulation.

8. Inasmuch as amplitude modulation can only be effected in or near the final stage of the transmitter, a relatively large audio output is required to obtain the considerable increase in power output during modulation peaks.

9. In order to have the margin of safety necessary for handling the highest positive peaks of modulation, the tubes in the final stage of the radio frequency amplifier must be operated at considerably less than their normal ratings during carrier-level conditions; this tends to lower the overall efficiency of the transmitter.

Analysis of FM Wave ★ At the top of Fig. 6 is shown the form of a frequency-modulated wave. In the mathematical expression for the wave immediately beneath the diagram, F represents the carrier or mean frequency of the wave, and the audio modulating frequency is designated by F_M .

The amplitude of the FM wave, of course, is constant and the extent of modulation must be described in other terms than those of the amplitude-modulated wave.

When referring to a class of stations operating in the same service, a certain maximum frequency swing may be agreed upon by engineers as representing 100% modulation. For example, in the case of FM broadcast stations, a frequency swing of ± 75 kc. from the unmodulated center frequency is commonly considered as being the equivalent of 100% modulation.

However, the more widely applicable

TABLE 1
BESSEL FACTORS FOR FINDING AMPLITUDES OF CENTER AND
SIDEBAND FREQUENCY COMPONENTS*

M	$J_0(M)$ F	$J_1(M)$ $F \pm F_M$	$J_2(M)$ $F \pm 2F_M$	$J_3(M)$ $F \pm 3F_M$	$J_4(M)$ $F \pm 4F_M$	$J_5(M)$ $F \pm 5F_M$	$J_6(M)$ $F \pm 6F_M$	$J_7(M)$ $F \pm 7F_M$	$J_8(M)$ $F \pm 8F_M$	$J_9(M)$ $F \pm 9F_M$
0.0	1.000									
0.1	.9975	.0499								
0.2	.99	.0995								
0.3	.9776	.1483	.0112							
0.4	.9604	.196	.0197							
0.5	.9385	.2423	.0306							
0.6	.912	.2867	.0437							
0.7	.8812	.329	.0589	.0069						
0.8	.8463	.3688	.0758	.0102						
0.9	.8075	.4059	.0946	.0144						
1.0	.7652	.4401	.1149	.0196						
1.2	.6711	.4983	.1593	.0329	.005					
1.4	.5669	.5419	.2073	.0505	.0091					
1.6	.4554	.5699	.257	.0725	.0150					
1.8	.3400	.5815	.3061	.0988	.0232					
2.0	.2239	.5767	.3528	.1289	.034	.007				
3.0	-.2601	.3391	.4861	.3091	.1320	.0430	.0114			
4.0	-.3971	-.066	.3641	.4302	.2811	.1321	.0491	.0152		
5.0	-.1776	-.3276	.0466	.3648	.3912	.2611	.131	.0534	.0184	
6.0	.1506	-.2767	-.2429	.1148	.3576	.3621	.2458	.1296	.0565	.0212

To find the amplitude of any sideband pair, enter the table with the modulation index M, read the amplitude factor for the sideband pair and multiply the factor by the amplitude of the unmodulated carrier. The amplitude of the center frequency component is found in the same manner, taking the factor from the $J_0(M)$ column.
* Where no value is given, the actual value is less than .005 and the sideband pair is not important.

method of describing the extent of modulation lies in stating the value of the modulation index. This index (M in the equations of Fig. 6) is simply the ratio of the amount by which the transmitted frequency swings from its average frequency to the amount of the modulating frequency. For example, if the modulating voltage has an amplitude sufficient to swing the transmitted frequency over the range ± 5 kc., and the modulating frequency is 5,000 cycles, then the modulation index, M , is 5000/5000 or 1.

It is to be carefully noted, in describing the extent of frequency modulation, that the modulation percentage and the modulation index are defined in a different manner. The modulation percentage is proportional to the frequency swing. The modulation index is not only directly proportional to the frequency swing but also is inversely proportional to the highest modulating frequency. Thus, in contrast to amplitude modulation, the modulation index of a frequency-modulated wave is not the decimal equivalent of the modulation percentage. The modulation index of a frequency-modulated wave, for example, will exceed 1 by many times when the frequency swing is large and the modulating frequency is low.

By higher mathematics, it can be shown that the frequency-modulated output is the sum of a center frequency component and numerous pairs of sideband frequency components. The center frequency component has the same frequency as the unmodulated carrier. The two components of the first sideband pair have frequencies respectively higher and lower than the center frequency by the amount of the modulating frequency, just as in amplitude modulation. In frequency modulation, however, there are additional pairs of sideband components which can have appreciable amplitude. For example, the second pair of sidebands, having frequencies that are higher and lower than the center frequency by *twice* the amount of the modulating frequency, can also be important. The same can be true of the third pair of sidebands, which is removed from the center frequency by *three* times the modulating frequency, and of higher orders of sideband pairs whose frequencies differ from the center frequency by correspondingly greater amounts.

When the modulation is slight, only the pair of sidebands nearest in frequency to the carrier frequency component will have sufficient amplitude to be important. Under this condition, the band width required is no greater than for an amplitude-modulated wave.

As the frequency modulation is increased, however, more pairs of sidebands acquire appreciable amplitude and the band width requirements are greater than for amplitude modulation.

The actual amplitudes of the various components of the frequency-modulated wave, compared to an unmodulated car-

rier amplitude of 1, may be read directly from Table I for modulation indices up to 6.

Consider the case where the modulating frequency is 5,000 cycles and the frequency swing is ± 5 kc., making M equal to 5000/5000 or 1. For M of 1, $J_0(M)$ is 0.7652, indicating that the amplitude of the center frequency component is 76.52% of the amplitude of the unmodulated carrier. Similarly, the relative amplitude of each of the first pair of sidebands, of frequencies $F + 5,000$ cycles and $F - 5,000$ cycles, is $J_1(M) = .4401$ or 44 per cent. The second pair of sidebands, of $F \pm 10,000$ cycles, has a relative amplitude of 11.5%; and the third pair, of $F \pm 15,000$ cycles, has a relative amplitude of 1.96%. The fourth pair has an amplitude of less than .01 or 1%, and hence is considered unimportant.

The components have been plotted to a common scale of time in Fig. 6, so that graphical addition can be made to check the validity of the mathematical work.

Note particularly that the band width required depends upon the number of important pairs of sidebands as well as the modulating frequency; for this reason the band width required can be greater than the overall frequency swing resulting from modulation. In the case cited above, three pairs of sidebands are important. The frequencies of the third pair differ from the center frequency by the greatest amount and hence determine what band width will be needed. One of these sideband frequencies is higher than the center frequency by the amount of three times the modulating frequency of 5 kc., and the other sideband frequency is lower than the center frequency by the same amount. Thus the difference between the frequencies of the third pair of sidebands, which establishes the band width, is six times the modulating frequency of 5 kc., or 30 kc. The extent of the frequency swing is only ± 5 kc., or 10 kc. from peak to peak.

The values of $J_0(M)$, $J_1(M)$ and $J_2(M)$ over the range $M = 0$ to $M = 16$ are plotted in Fig. 7. A study of these curves reveals some interesting facts about the composition of frequency-modulated waves.

$J_0(M)$ is less than 1 for all values of M greater than zero. This indicates that as sideband components appear with modulation, the amplitude of the center frequency component is less than its amplitude in the absence of modulation. The reasonableness of this fact is evident when it is remembered that the amplitude of the frequency-modulated wave is constant, so that the average power during each radio frequency cycle is the same as that during any other radio frequency cycle. In order that the power in the wave may not change when frequency modulation causes sideband currents to appear, the amplitude of the center frequency component must decrease sufficiently to keep the total of the I^2R prod-

ucts of *all* the components equal to the power of the unmodulated wave.

Fig. 7 also shows that at certain degrees of modulation the center frequency component disappears altogether. This fact is the basis of a certain method of modulation measurement to be discussed later. It will also be observed that at certain degrees of modulation the carrier component is negative, a reversal of phase.

When M is less than about .4, only the first pair of sidebands is important, and the relative amplitudes of sideband and carrier components can approach those of an amplitude-modulated wave. However, it should not be supposed that the two types of waves can be identical when both waves are slightly modulated. The sidebands of the FM wave are differently phased and add themselves to the carrier frequency component in a different manner from those of the AM wave.

Reference to Table I shows that for values of M between 0.4 and 3, the number of important sideband pairs is about $2M$. As M is made to exceed 3, the number of sideband pairs continues to increase but is somewhat less than $2M$. This information provides a useful rule of thumb for estimating the band width required, since the width needed is determined by the number of pairs of important sideband pairs that are present, as well as by the modulating frequency.

For example, if the amplitude of the modulating voltage of an FM station is such as to cause a frequency swing of ± 20 kc., and the frequency of the modulating voltage is 10 kc., then the value of M is 20/10 or 2. By the rule of thumb given above, the number of significant sideband pairs is $2M$ or 4. The total band width required is $4 \times 2 \times 10$ kc. or 80 kc. Again, the band width required (80 kc.) has been found to exceed the peak to peak frequency swing (40 kc.).

Suppose that while the frequency swing is maintained at ± 20 kc., the modulating frequency is reduced from 10 kc. to 4 kc. The modulation index becomes 20/4 or 5. The number of important sideband pairs can be expected to be somewhat less than $2M$ or 10. Reference to Table I shows the values of the factors for the carrier and successively higher orders of sideband pairs to range from $-.1776$ for $J_0(M)$ to $.0184$ for $J_5(M)$. For $J_5(M)$ and higher order factors, the amplitude is less than .01; hence the ninth and higher orders of sidebands are unimportant.

It is evident that the reduction in modulating frequency has caused the number of important sideband pairs to increase from three to eight. However, the band width required is now $2 \times 8 \times 4$ kc. or 64 kc., which is *less* than before.

In general, it can be said that for FM waves having the same frequency swing, the greatest spectrum area will be required by the wave having the highest modulating frequency. As the modulating frequency is lowered, more sidebands are

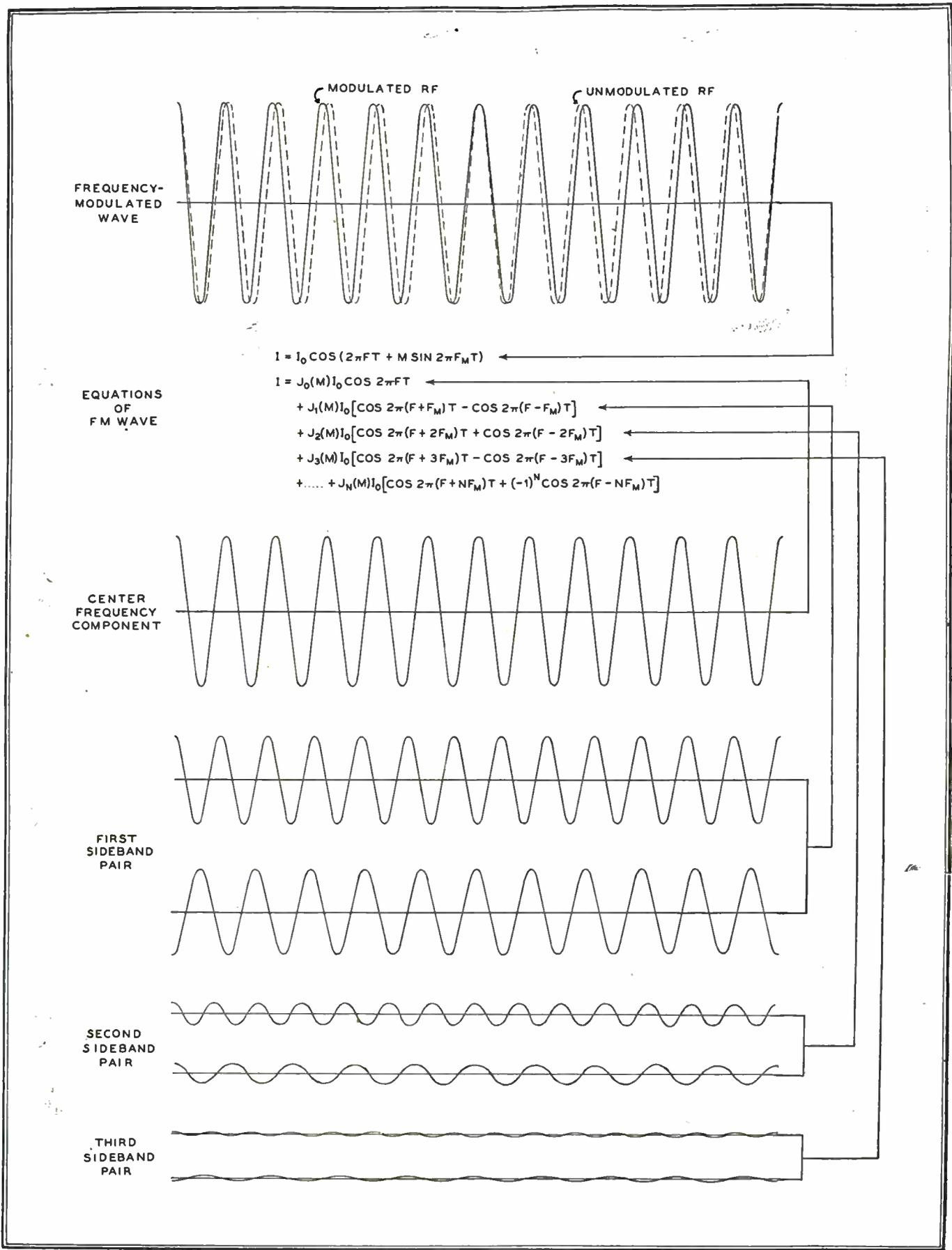

FIG. 6. THE FREQUENCY-MODULATED WAVE AND ITS COMPONENTS WHEN THE MODULATION INDEX IS 1

created, but the number of sidebands does not increase as rapidly as the frequency interval between the sidebands is reduced;

hence, the overall effect of lowering the modulating frequency while keeping the frequency swing unchanged is a reduc-

tion in the channel width.

If the modulating frequency is made very low, but the volume level is kept

constant to maintain the same frequency swing, M becomes quite high and a veritable multitude of sideband pairs are created; however, the band width required is reduced still more, although it can never be less than the peak to peak frequency swing nor twice the modulating frequency, whichever is the greater.

For example, consider the design of the output network of an FM broadcast transmitter whose maximum frequency swing is ± 75 kc. and whose maximum modulating frequency is 15 kc. The modulation factor M has a value of $75/15$ or 5, indicating that eight important pairs of sidebands are present, as explained above. The band width of the output network theoretically should be $2 \times 8 \times 15$ kc. or 240 kc. The actual width employed can be slightly less because the amplitude of the eighth sideband pair is quite small, being only 1.84% of the unmodulated carrier amplitude. The band width used may be in the order of 225 kc., or 50% greater, in this case, than the peak to peak frequency swing of 150 kc.

Summary of FM ★ Frequency-modulated waves differ from amplitude-modulated waves in the following respects:

1. During modulation the frequency is varied but its amplitude remains unchanged.

2. A higher audio modulating frequency increases the rate at which the radio frequency is varied.

3. An increase in the amplitude of the audio modulating voltage causes the radio frequency to be varied over a wider range.

4. The limits of the range over which the radio frequency can be varied is determined by the characteristics of the transmitter, rather than by the nature of the frequency modulated wave.

5. When subjected to frequency modulation at a single modulating frequency of sine wave form, the FM wave becomes the sum of a component at the center frequency, and numerous pairs of sideband components above and below the center frequency, at intervals equal to the amount of the modulation frequency. When the modulation is slight, the amplitude of the pairs of sidebands more remote from the carrier becomes so low that their presence may be ignored.

6. The extent of the frequency modulation can be described in two ways. A certain frequency swing is agreed upon as being equivalent to 100% modulation. The extent of modulation can also be specified by stating the modulation index. This index is the ratio of the maximum frequency swing (away from the center) to the highest modulating frequency. In the case of FM, therefore, the modulation index is not the decimal equivalent of the modulation percentage.

7. The band width required in FM depends upon the level of modulation and upon the modulating frequency. The

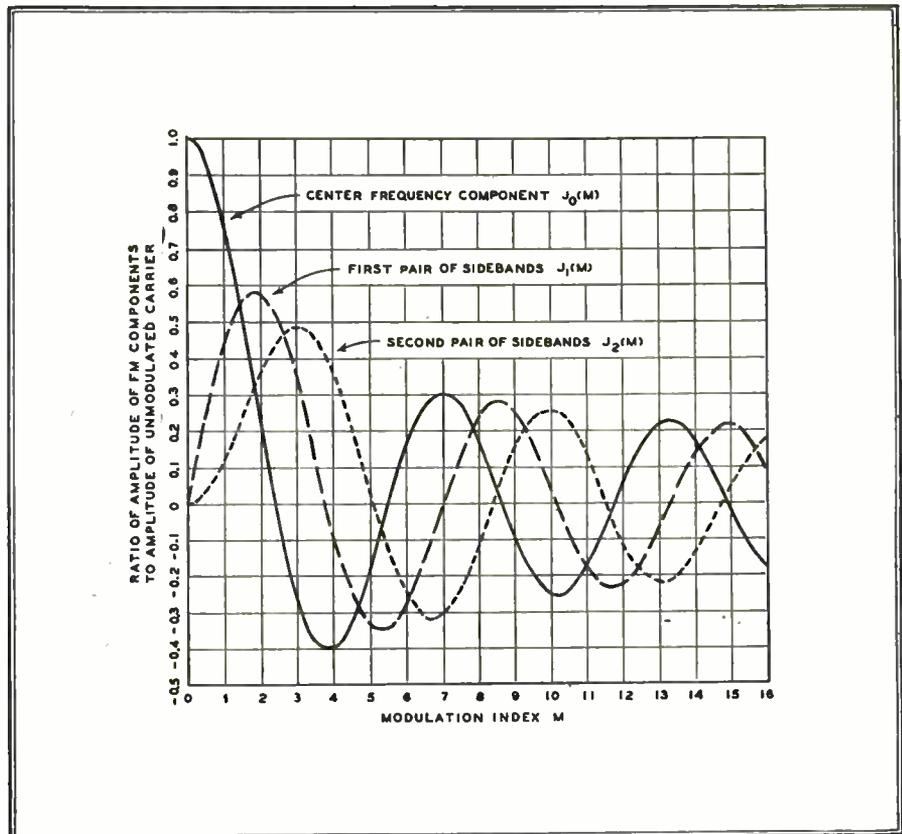

FIG. 7. HOW FM WAVE COMPONENTS VARY WITH THE DEGREE OF MODULATION

greatest channel width occurs when the wave is subjected to its maximum modulation at the highest modulating frequency; this band width may exceed considerably the peak-to-peak frequency swing. The least band width is required under a condition of slight modulation, but the channel width is never less than the amount of twice the modulating frequency.

8. Inasmuch as linearity of amplitude reproduction is not demanded of the amplifier stages of an FM transmitter, it is not necessary to introduce the modulating voltage at or near the last stage.

9. Since the RF power output of the FM transmitter is constant, modulation can be introduced in an early stage. Not only are the power output requirements for the modulator made extremely small, but also the tubes in all the stages of the transmitter subsequent to the modulated stage can be operated at their maximum Class C ratings, which makes for high overall efficiency.

REFERENCE DEFINITIONS

AMPLITUDE: The amplitude of a quantity that is varying according to a sine wave form is the maximum value which the quantity attains; the peak value of the sine wave.

AM, AMPLITUDE MODULATION: The process whereby the amplitude of a wave is caused to vary according to the instantaneous variations of another wave.

BAND-PASS CIRCUIT: A circuit having filter characteristics such that frequencies within a certain range are passed while frequencies outside the range are blocked.

BAND-WIDTH: Range of frequencies passed by band-pass circuit.

CARRIER FREQUENCY: Frequency of an unmodulated AM transmitter.

CENTER FREQUENCY: Frequency of an unmodulated FM transmitter.

CYCLE: A complete course of change, at the end of which the original state is restored.

FREQUENCY: The number of cycles occurring in one second.

FREQUENCY MODULATION: The process whereby the frequency of a wave is caused to vary according to the instantaneous variations of a modulating frequency.

FM: Abbreviation for Armstrong system of Frequency Modulation.

MODULATION: The process whereby one characteristic of a wave, amplitude, frequency, or phase, is varied as a function of the variations of another wave.

POSITIVE PEAK OF MODULATION: In amplitude modulation, the maximum of that alternation of the modulation cycle which causes the amplitude of the wave to rise above carrier level.

NEGATIVE PEAK OF MODULATION: In amplitude modulation, the maximum of that alternation of the modulation cycle which causes the amplitude of the wave to fall below carrier level.

SIDEBANDS: Frequencies higher and/or lower than the carrier frequency, produced during modulation.

TRIGONOMETRIC IDENTITY: Statement of the equivalence of two trigonometric expressions which holds for every value of the angles involved.

GENERAL FM THEORY

SECTION 2: THE OPERATIONAL ADVANTAGES OF FM CIRCUITS, CONCERNING NOISE AND INTERFERENCE SUPPRESSION, FIDELITY, AND DYNAMIC RANGE.

WHEN Major Armstrong presented his original paper on Frequency Modulation before the Institute of Radio Engineers in November 1935, he referred to his invention as "A Method of Reducing Disturbances in Radio Signaling by a System of Frequency Modulation." This description is most appropriate, for an outstanding advantage of FM is its freedom from the various types of interference that beset AM reception.

FM also has a number of other important advantages, such as the economies in transmitter design and operation which have been explained, and the improvements in fidelity that will be discussed in the latter part of this chapter and in coverage, which will be taken up subsequently. However, the initial effort which led to the development of FM was directed primarily at the problem of overcoming static and other types of radio interference.

Sources of Interference ★ The principal disturbances to AM reception can be classified as follows: 1) Interference resulting from the reception of signals from stations other than the one whose program is desired. 2) Thermal agitation noise, arising from the small potentials set up by the random motion of electrons in the conductors of the first stage of the receiver. 3) Tube noise, caused by random fluctuations in the rate at which electrons arrive at the plates of the vacuum tubes in the early stages of the receiver. 4) Static, arising from electrical discharges in the atmosphere. 5) Man-made interference, which occurs when there is spurious radiation from such sources as electrical power equipment and automobile ignition systems. 6) Hum modulation of the signal, which can take place in the early stages of AC receivers, where alternating current is used to heat the cathodes, and where the rectified DC plate supply may be inadequately filtered.

All these types of interference can be practically overcome or at least greatly reduced by the use of frequency modulation in a particular way, provided that the voltage of the desired FM signal is somewhat greater than the voltage of the disturbance. The method by which the receiver is made unresponsive to disturbances can be understood from a knowledge of the various types of disturbances.

Interference between Two Waves ★ Consider first the simple case of the interference between two waves shown in Fig. 8. Here an undesired signal *A* is present at the receiver along with the desired signal *B*. The amplitude of the desired signal *B* is twice that of the interfering signal *A*, and the frequency of the interfering signal is

slightly less, in this case, than that of the desired signal.

The voltage at the grid of the first tube of the receiver is the resultant or sum of the two signal voltages. The wave form of the resultant voltage $A + B$ is shown at the lower left of Fig. 8, and was obtained by adding the values of waves *A* and *B* from instant to instant.

It will be observed in Fig. 8 that the resultant signal has an amplitude variation between the limits of .5 and 1.5 times the amplitude of the desired signal taken alone. The form of the amplitude variation appears to approach that of a sine wave, although the negative peak is somewhat sharper than the positive peak. The frequency of the amplitude variation is the difference between the respective frequencies of the desired and the interfering signals.

In Fig. 8 it is noted that exactly the same amount of time is required for the completion of twelve cycles of the resultant as for the completion of twelve cycles of the predominant (desired) signal. Thus the *average* frequency of the resultant is the same as that of the predominant (desired) signal. However, Fig. 8 also shows that the curve of the resultant wave does not intercept its axis at equal time intervals, indicating that the resultant has a variation of frequency as well as a variation of amplitude. For example, in Fig. 8, the time taken to complete the first cycle of the resultant signal is somewhat greater than that required for the completion of the first cycle of the desired signal. To the lag acquired by the resultant during its first cycle is added a smaller amount of lag acquired during its second cycle, and so forth, until at instant T_1 a maximum amount of lag has accumulated. Thereafter, and until instant T_2 , the resultant signal shortens its time period per cycle, first diminishing the lag to zero and then causing the accumulation of a lead. At instant T_2 the lead is at a maximum, and for the remainder of the wave shown in the diagram, the periods of the cycles increase, diminishing the lead to zero.

The amount of the *maximum* accumulated lead or lag of the resultant with respect to the predominant (desired) signal is called its *peak phase deviation*. The amount of the deviation is of interest because it plays a part in determining the effectiveness of the reduction of interference in the FM receiver, as will be shown presently. The amount of the deviation depends upon the ratio of the amplitude of the desired signal *B* to that of the interfering signal *A*; in the present case, the ratio B/A is 2 to 1. It will be noted at instant T_1 in Fig. 8 that with

$B/A = 2$, the maximum lag occurs when the desired signal *B* has completed 120° more of its cycle than has the interfering signal *A* of its cycle. This agrees with the angular relationship of *A* to *B* in the vector diagram for instant T_1 , also shown in Fig. 8, for readers interested in the mathematical procedure of determining the amount of peak phase deviation. It is found that the maximum lag or lead occurs when the resultant $A + B$ is tangent to the circle described by the terminal point of vector *A* as it rotates about the terminal point of vector *B* as a center. In the present case, the side *A* opposite the deviation angle is equal to one-half the hypotenuse *B*, which makes the phase deviation equal to 30°, measured in terms of a cycle of the predominant (desired) signal as 360°. When the ratio of the amplitude of the desired signal *B* to that of the interfering signal *A* is greater than 2 to 1, the peak phase deviation is less than 30°.

It should be noted particularly that the amount of deviation depends solely upon the ratio of the amplitude of the desired signal to that of the interfering signal, and is independent of the frequencies of the two signals. As the difference between the frequencies of the two signals is made greater, the amplitude of the resultant pulsates at a higher frequency and the interval between the successive instants of maximum lag or lead is reduced; however, the *amount* of the deviation at these instants remains unchanged. For example, if the amplitude of the desired signal is twice that of the interfering signal, the resultant signal will alternately acquire lags and leads of only 30° with respect to the predominant (desired) signal, regardless of what the difference in frequency of the desired and interfering signals may be. This fact has an important bearing on the matter of how the effects of interference are overcome in the FM receiver, as will be explained later.

It has been mentioned previously that while the average frequency of the resultant is equal to the frequency of the predominant (desired) signal, the resultant is continually varying in frequency alternately above and below its average frequency value. The maximum amount of the frequency variation is called the *frequency deviation*. Unlike the phase deviation, the frequency deviation depends, in part, upon the frequencies of the desired and interfering signals. As a matter of fact, the frequency deviation is directly proportional to the amount of phase deviation, and also directly proportional to the rate at which the instants of maximum lag or lead recur, that is, to the difference of the two signal frequencies. This rela-

tionship is to be expected, for the extent to which the time periods of the cycles must be lengthened and shortened depends not only upon how much lag or lead is to be accumulated but also upon how many cycles occur during the process of accumulation.

For example, if the signal frequencies differ only slightly, then the amplitude of the resultant pulsates quite slowly and there is a long time interval between the instants of maximum lag or lead. Many cycles of the resultant wave occur during the process of accumulating the maximum lag or lead, and the amount by which the time period of any individual cycle is lengthened or shortened is quite small. Consequently, the frequency of the resultant is varied over a narrow range. On the other hand, if the signal frequencies differ considerably, the amplitude of the resultant pulsates rapidly, the time interval between the instants of maximum lag or lead is much shorter, and greater frequency deviation is required to give the same amount of phase deviation.

Overcoming Effects of an Interfering Wave ★ It has been noted that an interfering signal acts upon a desired signal of greater amplitude to create a resultant which differs from the desired signal by having variations of amplitude and frequency. It follows that to reduce the effects of the interfering signal, steps should be taken to minimize the amplitude and frequency variations of the resultant.

In the FM receiver, the amplitude variations are removed by the action of a limiter stage, located immediately after the last IF amplifier stage, as shown in the block diagram of Fig. 9. Previous to the limiter, the general arrangement of the receiver is like that of the conventional AM superheterodyne broadcast receiver, except that the tuned circuits are designed for higher RF and IF frequencies, and greater band width. Thus the amplitude and frequency variations of the resultant signal voltage at the grid of the first tube of the receiver are transferred to the IF voltage at the input of the limiter.

If, for purposes of explanation, the voltage at the input of the limiter is assumed to have the wave form shown at the lower left in Fig. 8, then the output voltage of the limiter will have the wave form shown at the lower right in Fig. 8 (assuming that the limiter output impedance is constant at all frequencies). It will be observed that whenever the instantaneous voltage applied at the input of the limiter begins to exceed a predetermined level, the limiter operates to prevent its output voltage from increasing in a like manner. If the limiting action begins at a level below the least amplitude of the applied voltage at the limiter input, then the amplitude variations are practically absent in the limiter output. Thus the limiter overcomes one of the effects of the interfering wave. The use of a circuit that minimizes the effects

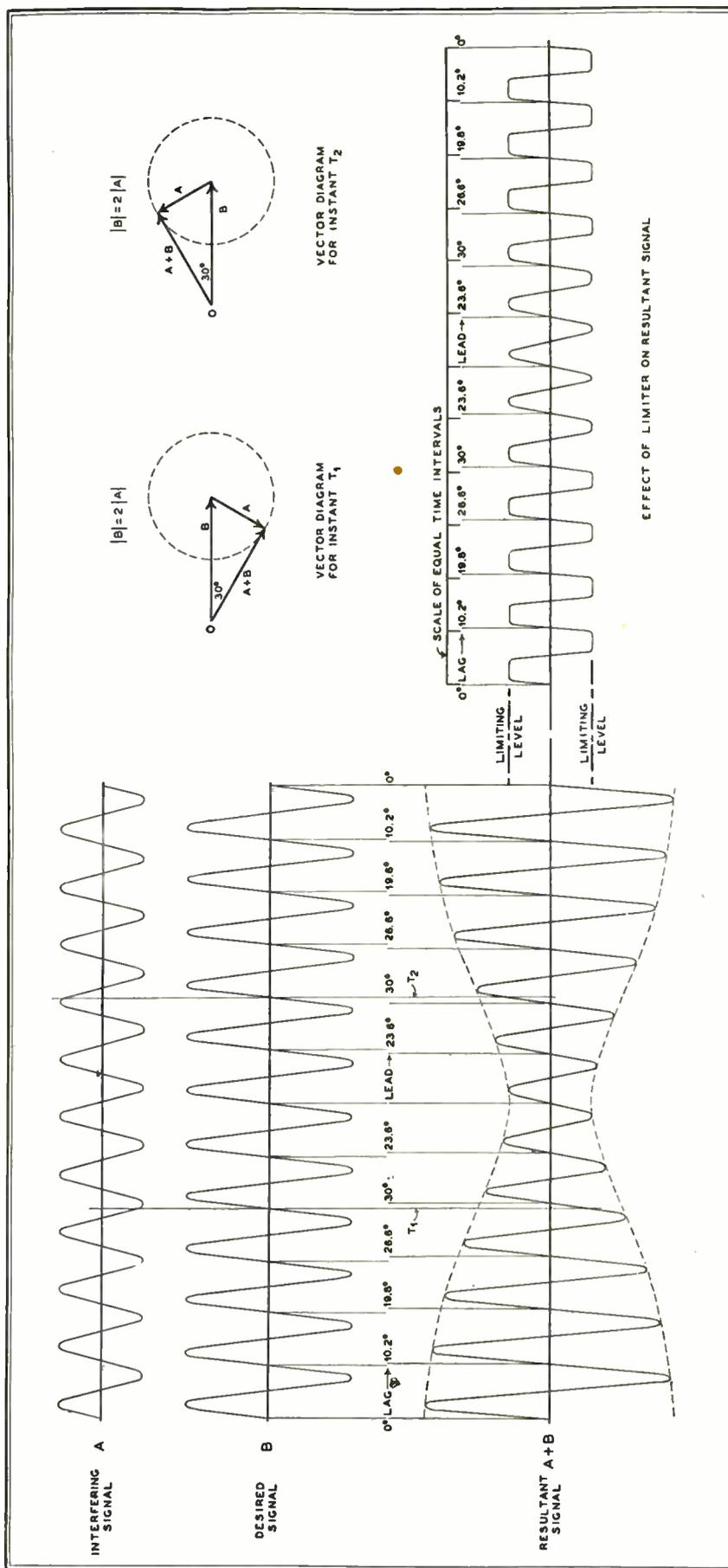

FIG. 8. EFFECT OF INTERFERING SIGNAL A UPON DESIRED SIGNAL B IS TO CREATE RESULTANT HAVING AMPLITUDE AND FREQUENCY VARIATIONS; THE LIMITER REMOVES THE AMPLITUDE VARIATIONS BUT THE FREQUENCY VARIATIONS ARE STILL PRESENT IN THE LIMITER OUTPUT

of the amplitude variation of the resultant wave, such as a limiter, is necessary for the reduction of interference in the FM receiver.

The frequency variations of the input voltage to the limiter, however, are carried over into the output, as indicated by the fact that the intercepts of the limiter out-

put voltage curve with its axis (Fig. 8, lower right) occur at unequal time intervals.

While the amount of frequency variation due to the interfering signal is not reduced in the limiter, the effects of such frequency variation can be minimized if *wide-band* frequency modulation is used for conveying intelligence on the desired signal. For example, if a sound wave striking the microphone at the studio causes the radio wave emitted by the FM transmitter to vary in frequency by thousands of cycles, then a supplementary frequency variation of, say, fifty cycles, in-

the phase deviation) of the limiter output voltage.

When the variation of frequency is sinusoidal, the frequency deviation in cycles is equal to the product of the phase deviation in radians and the number of times that a complete cycle of frequency variation recurs in one second. In the case of the FM wave mentioned above, having a phase deviation of 75 radians and a modulation frequency of 1,000 cycles, the frequency deviation due to modulation is 75×1000 or 75,000 cycles.

In the case of the resultant of the interfering wave and the FM wave, whatever

ness of the reduction of interference, especially when it is remembered that the amplitudes of the desired and interfering signals are in the ratio of 2 to 1. If the ratio were greater than 2 to 1, the disturbance of reception by the interfering wave would be even less.

Fig. 10 shows, from left to right, the voltage at the limiter input, at the limiter output, and at the discriminator output when a wide-band frequency-modulated signal is being received in the absence of interference. Any amplitude variations caused by interfering signals are removed by the limiter and any frequency variations caused by interfering signals are rendered negligible by the fact of the much greater frequency variations caused by modulation. The discriminator creates a voltage whose amplitude at any instant is proportional to the amount by which the frequency of the output voltage of the limiter differs from the frequency to which the discriminator as well as the limiter and IF amplifier tuned circuits is aligned. The polarity of the discriminator output voltage at any instant depends upon whether the frequency at the limiter output is greater or less than the alignment frequency of the discriminator tuned circuits. When the variation of the frequency of the limiter output voltage is sinusoidal about its center frequency, the discriminator furnishes a sinusoidal alternating voltage for excitation of the audio amplifier, as shown in Fig. 10.

While the essential function of the discriminator is the demodulation of the FM signal, it also serves to supplement the action of the limiter. The discriminator tends to balance out the effects of any amplitude variations that are not completely removed in the limiter, providing the discriminator is correctly tuned. A properly aligned limiter and discriminator give a very marked reduction of the effects of amplitude variation of the sig-

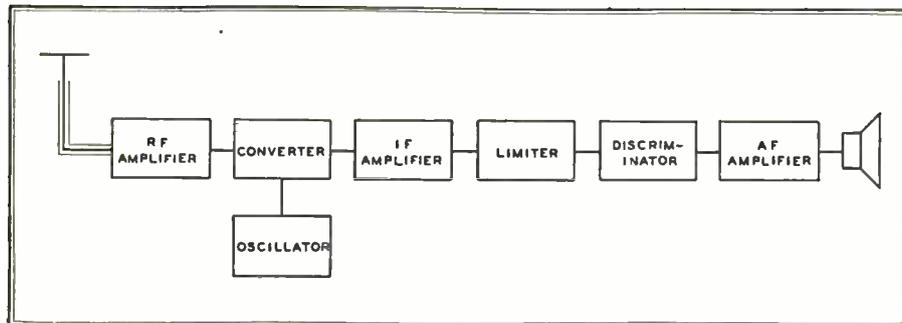

FIG. 9. BLOCK DIAGRAM OF A CONVENTIONAL FM RECEIVER

produced by the interfering signal at the receiver, is of negligible effect.

Consider the case of an FM broadcast transmitter. The maximum frequency swing away from the center frequency amounts to 75 kc., which is five times the highest modulation frequency of 15 kc. This is a wide-band FM system. Suppose that a 1,000-cycle note of sine wave form is sounded at the microphone with an intensity sufficient to cause the transmitter to be fully modulated. The frequency swing of the transmitter will be 75 kc. The modulation index is $75000/1000$ or 75. The angle of phase deviation of the transmitter in radians is equal to its modulation index. Since one radian is equivalent to approximately 57.3 degrees, the phase deviation of the transmitter amounts to 75×57.3 or about 4300° in this case!

Assume that at the receiver an interfering signal is present, having a frequency 100 cycles higher than the center frequency of the desired signal, and an amplitude one-half that of the desired signal. The ratio of the amplitude of the desired signal to that of the undesired signal is 2 to 1, making the phase deviation of the resultant with respect to the desired signal equal to 30° , regardless of the frequency of the desired signal, as explained previously.

The ratio of the phase deviation due to modulation to that caused by the interfering wave is $4300/30$ or about 143 to 1. However, it must not be concluded from this that the intensities of the 1,000-cycle and 100-cycle tones at the speaker of the receiver will be in the ratio of 143 to 1. The discriminator stage which follows the limiter in Fig. 9 produces a voltage for exciting the audio amplifier that is proportional to the frequency deviation (and not

the frequency of the latter, the supplementary phase deviation caused by an interfering wave having one-half the amplitude of the desired FM wave is 30° or .52 radian. If the frequency variation of the resultant caused by the interfering signal is assumed to be sinusoidal, then the supplementary frequency deviation caused by the interfering signal is $.52 \times 100$ or only 52 cycles!

(Strictly speaking, the value of 52 cycles must be regarded as an approximation, since neither the amplitude nor the frequency variation of the resultant caused by the interfering signal is sinusoidal. However, the variation of frequency caused by the interfering signal is suf-

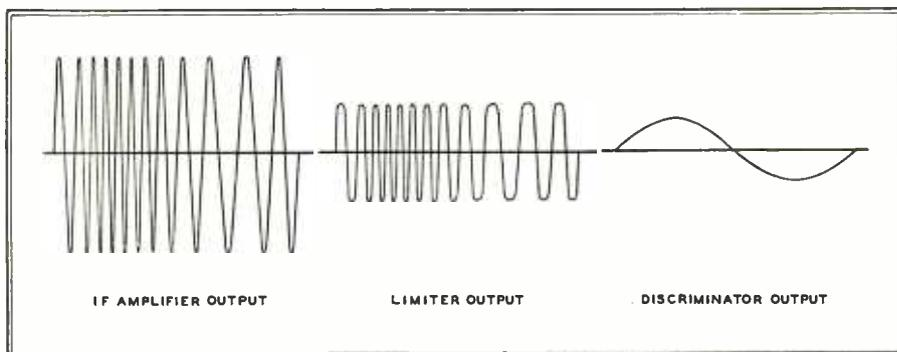

FIG. 10. WAVE FORMS OF LIMITER AND DISCRIMINATOR VOLTAGES IN RECEIVER

ficiently close to a sinusoidal form to justify the above assumption in making a rough estimate of the frequency deviation.)

A comparison of the frequency swing of 75,000 cycles caused by modulation to a swing of 50 or 100 cycles caused by the interfering wave emphasizes the effective-

ness of the reduction of interference, whether such variation be the result of noise, AM hum modulation in the early stages of the receiver, or an interfering wave.

It should be noted that the suppression of the frequency variation of an interfering wave is not always as effective as in the case for which figures were cited

above. For example, if the frequency of the interfering signal differs from the frequency of the desired signal by a greater amount, the phase swing remains unchanged but the frequency swing of the resultant is increased. Also, during much

same conditions are met, namely that: 1) The amplitude of the desired signal is two or more times the peak amplitude of the interfering signal, so that the supplementary phase swing caused by the interfering signal is never more than 30°

ters. The general term applied to such disturbances is *noise*.

Noise voltages are made up of sharp pulses of various amplitudes occurring at irregular intervals. When the voltage peaks are infrequent and sharply defined, with successive peaks clearly separated, the noise is described as being of the *impulse* type. When the peaks follow one another in such rapid succession that there is overlapping, the noise is described as being of the *random* type. Both types of noise are usually present in varying degrees at any receiver.

Impulse noises usually originate in sources external to the receiver, such as automobile ignition systems, faulty power lines, and the sparking brushes of electric motors.

Random noise can be caused by the usual form of static, arising from a more or less continuous series of electrical discharges in the atmosphere. In addition, there is always an appreciable amount of random noise originating in the early stages of all radio receivers.

One source of such random noise is the thermal agitation voltage which is developed in all conductors at temperatures above absolute zero. It is the result of the

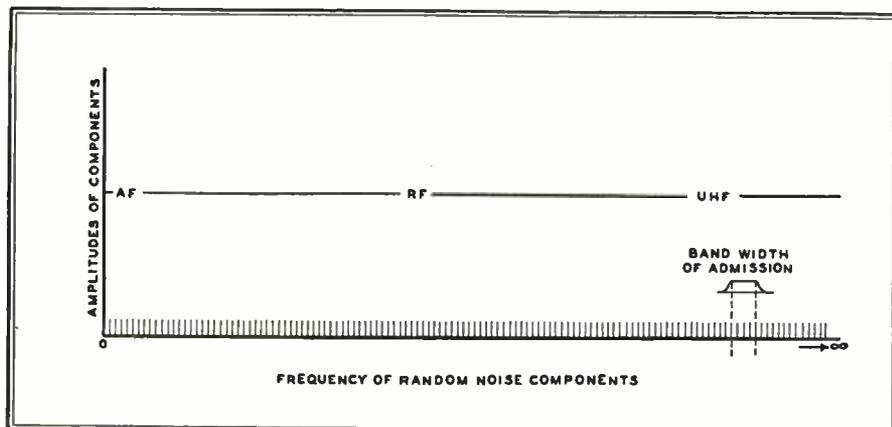

FIG. 11. APPROXIMATE REPRESENTATION OF SPECTRUM DISTRIBUTION OF RANDOM NOISE

of the time when a program is on the air, the transmitter is not fully modulated, so that its frequency swing does not overshadow the frequency deviation caused by interference at the receiver to as great an extent.

For example, if the difference in frequency of the desired and the interfering signals is increased from 100 to 10,000 cycles, the phase swing caused by the interfering signal remains at 30° or $.52$ radian, but the frequency swing caused by the interfering signal is increased to $.52 \times 10,000$ or 5,200 cycles. Such a swing is appreciable compared to a transmitter swing of 75,000 cycles. The situation is even less favorable at lower degrees of modulation where the swing of the FM wave is in the order of, say, 15,000 or 20,000 cycles. Since the higher frequency components of program material are generally of less amplitude than the lower frequency components, this characteristic might appear to be a serious obstacle to the achievement of high fidelity FM reception. However, the situation can be easily remedied by the use of pre-emphasis and de-emphasis, as will be explained later. Even without the use of emphasis networks at the transmitter and receiver, the interference is less noticeable than with AM.

When the frequency of the interfering wave differs from that of the desired signal only slightly, the disturbance is suppressed by the FM receiver more effectively than ever. This is in marked contrast to AM, where it becomes increasingly difficult to tune out the interfering signal as its frequency approaches that of the desired signal.

In the above discussion it was assumed that the interfering signal was unmodulated. Equally effective suppression of interference in the FM receiver occurs when the interfering wave is amplitude- or frequency-modulated, provided the

or $.52$ radian. 2) The least amplitude of the voltage at the limiter input is in excess of the voltage at which limiting action starts, so that amplitude variations are removed in the limiter. This explains the

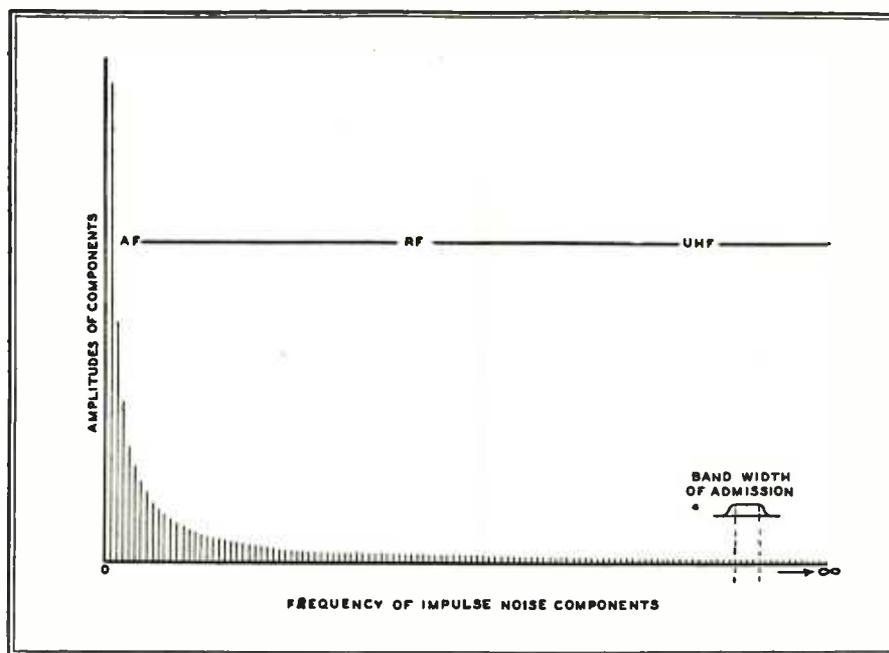

FIG. 12. APPROXIMATE REPRESENTATION OF SPECTRUM DISTRIBUTION OF IMPULSE NOISE

importance of high gain RF and IF amplifiers in the FM receiver. 3) The intelligence is conveyed on the desired signal by the use of wide-band frequency modulation, so that the frequency variations due to modulation will greatly overshadow the frequency variations due to the interfering signal.

Noise Disturbances ★ In addition to the interference caused by continuous signals picked up from undesired radio transmitters, there may be interference from voltages of a discontinuous nature arising from sources other than radio transmit-

ters. The general term applied to such disturbances is *noise*. Noise voltages are made up of sharp pulses of various amplitudes occurring at irregular intervals. When the voltage peaks are infrequent and sharply defined, with successive peaks clearly separated, the noise is described as being of the *impulse* type. When the peaks follow one another in such rapid succession that there is overlapping, the noise is described as being of the *random* type. Both types of noise are usually present in varying degrees at any receiver. Impulse noises usually originate in sources external to the receiver, such as automobile ignition systems, faulty power lines, and the sparking brushes of electric motors. Random noise can be caused by the usual form of static, arising from a more or less continuous series of electrical discharges in the atmosphere. In addition, there is always an appreciable amount of random noise originating in the early stages of all radio receivers. One source of such random noise is the thermal agitation voltage which is developed in all conductors at temperatures above absolute zero. It is the result of the haphazard motion of free electrons in the conductors, and depends upon the temperature as well as the resistance of the conductors. While thermal agitation is present in all the conductors of a receiver, only that present in the input circuit preceding the first tube is usually important because the signal voltage is at its lowest level at this point.

Another source of random noise within every receiver is a slight fluctuation in the rate at which the electrons arrive at the plates of the tubes. This fluctuation occurs continuously, regardless of whether or not there are larger variations of plate current

caused by the incoming signal. A certain amount of random fluctuation is inherent in the nature of plate current, which is a bombardment of the plate by a hail of separate particles rather than the smooth flow of a continuous fluid. This fluctuation creates a noise voltage across the output load of the tube, which is termed *shot effect*. Additional slight fluctuations of plate current are caused by variations in the rate at which electrons are emitted from the cathode of each tube and by variations of the ratio in which the electrons are divided among the collecting elements of the tube. The resultant of all these effects is called tube noise, and is of importance in the early stages of the receiver, where the signal voltage is still of relatively low amplitude.

Analysis of Noise Voltages ★ Since random noise voltages come from forces which act

equal to the sum of a component at the fundamental frequency, a component at twice the fundamental frequency having one-half the amplitude of the fundamental frequency component, a component at three times the fundamental frequency with one-third the amplitude of the fundamental, and an infinite series of higher harmonics each having an amplitude inversely proportional to the order of the harmonic. The spectrum distribution for impulse noise is approximately depicted in Fig. 12.

While noise voltages are made up of components at all frequencies, a radio receiver at any particular setting of the tuning dial responds only to frequencies within a comparatively narrow band of the spectrum. The center frequency of the band is the assigned frequency of the station to which the receiver is tuned; the width of the band, that is, the difference

From alternating current theory, it will be remembered that when two or more components of voltage, or current, at different frequencies are present in a circuit, the root mean square or RMS value of the resultant is equal to the square root of the sum of the squares of the RMS values of the components. If the components are all of equal amplitude, then the RMS value of the resultant is proportional to the square root of the number of components present. It was shown above that under conditions encountered in practice, the amplitudes of the components at different frequencies of both impulse and random noise tend to be uniform within the response band of the receiver. Thus the RMS values of random noise and of impulse noise can be expected to be proportional to the square root of the width of the radio frequency band to which the receiver is responsive at any particular

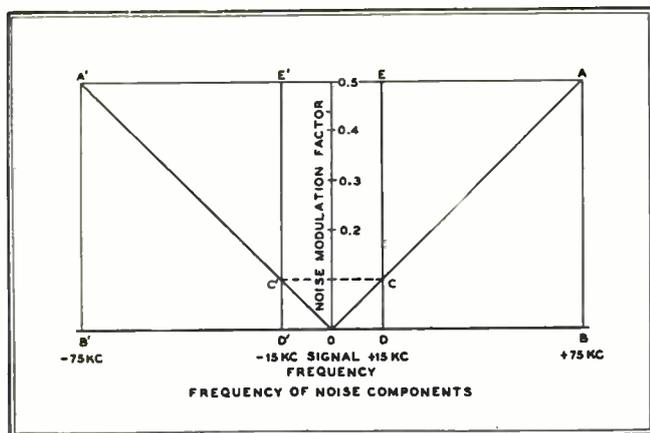

FIG. 13. CONSTRUCTION DIAGRAM OF AM AND FM RECEIVER NOISE

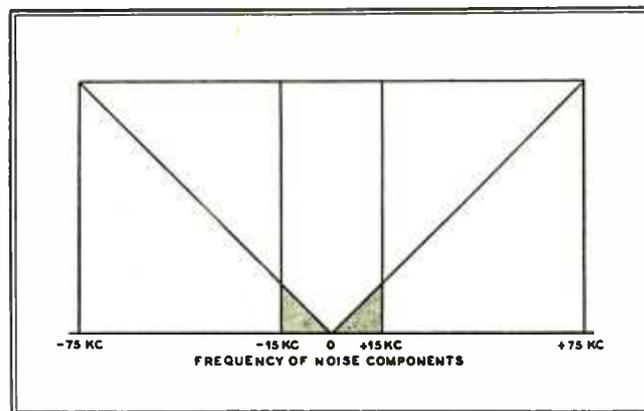

FIG. 14. SPECTRUM DISTRIBUTION OF FM RECEIVER NOISE, INDICATED BY THE SHADED AREA

in an uncontrolled and haphazard manner, it is to be expected that they will have no particular frequency. As a matter of fact, the energy of random noise is almost uniformly distributed over the spectrum from zero frequency to the highest of radio frequencies. True random noise voltage may be regarded, therefore, as consisting of an infinite number of components at different frequencies, each frequency differing from the next higher or lower frequency by an infinitesimal amount. The individual components have no specific time or phase relation with respect to each other, and the average amplitude of all the components in a frequency band in one portion of the spectrum is equal to the average amplitude of the components in a frequency band of the same width in any other portion of the spectrum. An approximation of the spectrum distribution characteristics for random noise is shown in Fig. 11.

Impulse noises are in the form of sharp peaks, occurring at irregular intervals. To analyze the spectrum distribution of energy received from a single pulse, the pulse may be regarded as one of a series of pulses recurring at a very low frequency. When a recurrent pulse of exceedingly short time duration is analyzed, it is found to be

between the highest and lowest frequencies of the band, is largely determined by the adjustments of the tuned circuits of the IF amplifier. In practice, the width of the frequency band to which the receiver responds at any particular dial setting is quite small compared to the center frequency of the band. For example, in FM broadcast reception, the band of frequencies to which the receiver is responsive when the receiver is tuned to a station is in the order of 200 kc. wide, while the frequency of the station (that is, the center frequency of the band) is in the order of tens of thousands of kilocycles. Thus the receiver band widths indicated in Figs. 11 and 12 are shown as narrow portions of the spectrum located well up the frequency scale. Note particularly that under such conditions, the amplitudes of components at different frequencies *within* the receiver response band are practically uniform. This is to be expected in the case of random noise, Fig. 11, but in the case of impulse noise, Fig. 12, the practically uniform amplitudes are the result of the location of the band in a region of the spectrum where the limiting frequencies of the band differ by only a small percentage from the frequency at the center of the band.

dial setting. That such is the case has been confirmed experimentally.

It is the peak value of a noise voltage rather than its RMS value, however, that largely determines the extent to which noise irritates the listener. In the case of random noise arising from thermal agitation, the ratio of the peak to the RMS value, called *crest factor*, is about 4 to 1. When random noise voltage arises from sources other than thermal agitation, the crest factor can assume a somewhat higher value, but will tend to be constant at that value in the presence of a strong signal. Thus the peak as well as the RMS value of random noise at the IF output of the receiver is approximately proportional to the square root of the band width of the receiver.

The peak value of the impulse noise voltage, however, varies directly as the band width, and not as the square root of the band width. The reason for this relationship is to be found in the fact that the components of the impulse noise are all in harmonic relation to the fundamental, and so timed with respect to each other that they are all in phase at the instants when the pulse starts or stops. Thus the peak value of the impulse noise voltage is the arithmetical sum of the

amplitudes of the components. In a receiver whose response band is located well up in the frequency spectrum, where the amplitudes of the impulse noise components are nearly uniform, the peak voltage is proportional to the number of components added. The number of components added varies, in turn, as the band width, since the components are located in the frequency spectrum at intervals equal to the fundamental frequency of the impulse. Therefore, the peak value of the impulse noise voltage is proportional to the frequency band passed by the receiver.

The distinction between the relationships of peak random and peak impulse

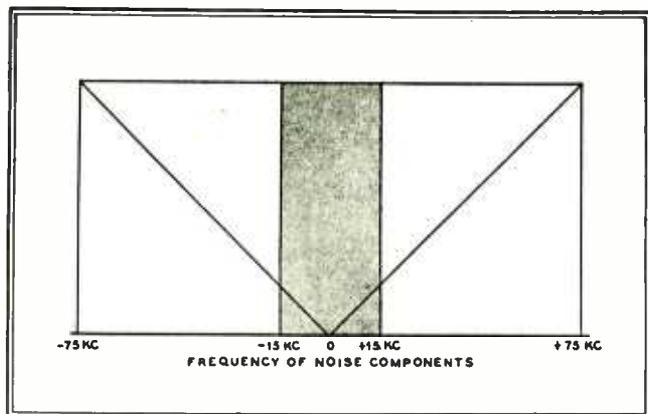

FIG. 15. SPECTRUM DISTRIBUTION OF AM RECEIVER NOISE, INDICATED BY SHADED AREA

noise to the band width accounts for a difference in the effectiveness of the FM receiver in reducing the noise, which will be explained presently.

Comparative Noise in AM and FM Receivers ★

In the discussion of Fig. 8, it was noted that the effect of an interfering signal upon a stronger desired signal is to create a resultant which has varying amplitude and varying frequency. The amplitude variation is largely removed in the limiter and the effects of any remaining amplitude variation in the limiter output are minimized in the discriminator. The frequency variation, caused by the interfering wave is not reduced in the limiter, but is rendered negligible by the much greater frequency swing of the desired signal during modulation. However, it was noted that as the frequency of the interfering signal differs from the frequency of the desired signal by an increasing amount, the frequency swing caused by the interfering wave (and hence the amount of interference in the receiver output) increases in direct proportion.

The above observations for the case of one interfering signal also hold with respect to two or more interfering signals, provided the peak value of the resultant of the interfering signals is not greater than one-half the amplitude of the desired signal. Since impulse noise can be analyzed as consisting of a series of components of practically uniform amplitude

spaced at equal frequency intervals in the response band of the receiver, it follows that reduction of this noise as well as of the interfering signals can be expected in the FM receiver. Also, it is to be expected that the noise components at frequencies nearest the signal frequency will be most effectively suppressed while those components whose frequencies are more remote from the signal frequency will cause more disturbance in the receiver output.

These anticipated effects are found in practice, so that in Fig. 13 the curve $A'OA$ shows how the radio frequencies of the noise components at the receiver input determine the amplitudes of the audio frequency components of noise at the receiver output. The diagram applies to the case of peak impulse noise and assumes that the ratio of carrier-to-noise is 2 to 1. While the amplitudes of the components of impulse noise are known to be practically uniform within the width of the receiver response band at the source, it is observed that the frequency modulation due to noise increases in direct proportion to the amount by which

the noise components are higher and lower in frequency than the signal.

The areas of triangles OAB and $OA'B'$ therefore represent noise in the discriminator output. However, all of this noise may not be passed through the audio am-

are proportional to the highest frequency passed by the audio system of the receiver. These triangles are shown as shaded areas in Fig. 14, which represents the noise output of the FM broadcast receiver. As will be explained later, by the use of pre-emphasis and de-emphasis circuits at the FM transmitter and receiver, it is possible to reduce the already small amount of FM receiver noise represented by the shaded triangles still further.

In Fig. 13, if the perpendiculars CD and $C'D'$ are extended upward until they intersect the horizontal line AA' at EE' , a means is afforded for visualizing the improvement in the signal-to-noise ratio that is effected in the FM receiver.

In an AM receiver, all the noise components at radio frequencies differing from the signal frequency by less than the highest audio frequency are amplified in the receiver equally as well as the intelligence of the signal being received. The peak impulse noise at the AM receiver output is therefore proportional to the area of rectangle $E'EDD'$ of Fig. 13. This rectangle is shown as the shaded area of Fig. 15. The ratio of the area of the AM receiver noise rectangle of Fig. 15 to the total area of the FM receiver noise triangles of Fig. 14, called the *improvement ratio*, is the figure of merit of the FM system. The improvement ratio tells how many times the signal-to-noise ratio in the output of the FM receiver is increased over that in the output of an AM receiver, where both receivers have the same carrier strength and the same carrier-to-noise ratios at their inputs.

What determines the magnitude of the improvement ratio for peak impulse noise

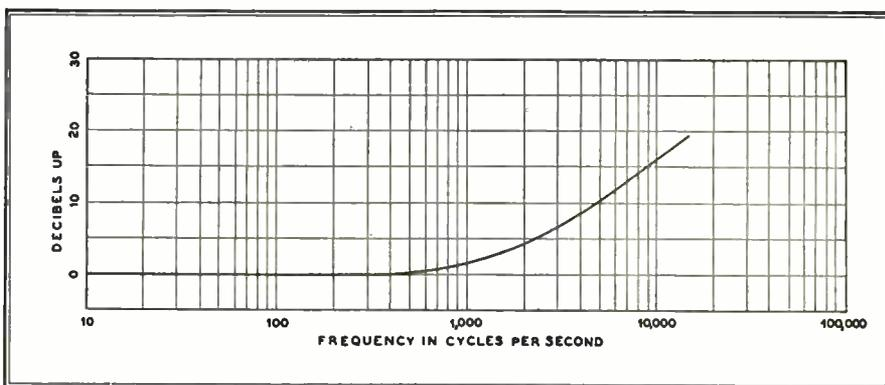

FIG. 16. STANDARD PRE-EMPHASIS CHARACTERISTIC FOR FM TRANSMITTERS

plifier. For example, in FM broadcasting the maximum frequency swing, as represented by OB and OB' is 75 kc., whereas the highest frequency that is passed through the audio system is in the order of 15 kc. The noise created in the discriminator output by noise components differing in frequency from the signal by more than 15 kc. is therefore prevented from reaching the receiver output. Thus, in the diagram of Fig. 13, the noise reaching the FM receiver output is represented by triangles OCD and $OC'D'$, whose bases OD and OD'

reduction in the FM receiver? In other words, what determines the ratio of the area of rectangle $E'EDD'$ in Fig. 13 to the area of the triangles OCD and $OC'D'$? The construction line $C'C$ aids in evaluating the ratio. The area of the large rectangle $E'EDD'$ is greater than the area of the small rectangle $C'CDD'$ by as many times as dimension ED is greater than CD , or as AB is greater than CD , or as BO is greater than DO . The ratio BO/DO makes the more useful reference, since it represents the ratio of the peak

frequency swing of the transmitted signal to the highest audio frequency handled by the audio channel of the receiver. This ratio is commonly called the *deviation ratio of the FM system*.

The ratio of the area of the large rectangle $E'EDD'$ to the small rectangle $C'CDD'$ is equal to BO/DO or to the deviation ratio of the FM system. The small rectangle $C'CDD'$ in turn has twice the total area of the triangles OCD and $OC'D'$. Thus the improvement ratio of the FM system in the case of peak impulse noise is equal to twice the deviation ratio of the FM system. In Fig. 13 the deviation ratio BO/DO is 5 to 1, making the improvement ratio for the FM receiver on peak impulse noise equal to 2×5 or 10 to 1. Thus the area of the shaded rectangle in Fig. 15 is 10 times the area of the shaded triangles in Fig. 14. The signal-to-noise ratio for peak impulse noise is ten times as great in this case at the FM receiver output than in the AM receiver output, assuming that both receivers operate with the same carrier strength and the same carrier-to-noise ratio at their inputs, and that the full noise reducing potentialities of the FM system are realized through careful design.

In the case of peak random noise, the diagram of Fig. 12 does not apply, because the components of random noise have no particular timing with respect to each other, and the peak value of random voltage is proportional to the square root of the band width, rather than to the width of the band. The improvement ratio for peak random noise is equal to the square root of the ratio of the areas that are created when each of the noise amplitudes of the triangles and rectangle is squared before plotting. By the use of calculus, the value of the improvement ratio for peak random noise is found to be the square root of 3 or approximately 1.73 times the deviation ratio of the system. Thus the improvement in the case of peak impulse noise is $2/1.73$ or 1.16 times greater in the case of peak random noise. In both cases, however, the respective improvements are proportional to the deviation ratio of the FM system. That is why it is desirable to have as large a frequency swing at the FM transmitter as feasible with a due regard for the fact that the spectrum must be shared with other stations. It is why the audio channel of the receiver should accept and amplify frequencies up to the highest necessary in the particular type of FM service involved, and should reject frequencies that are higher. When these precautions are observed in setting up the FM transmitting and receiving system, the largest possible deviation ratio will be obtained and the greatest improvement in the signal-to-noise ratio can be achieved in a well designed receiver.

For example, in the FM broadcast service, for realistic reproduction of the studio program in the home, it is desirable that the full range of audio frequencies up to 15,000 cycles be amplified in the audio

system and converted to sound at the speaker. Frequencies higher than about 15,000 cycles are inaudible to the average human ear and the audio channel should therefore cut off at about 15,000 cycles. The frequency swing of the transmitter should be sufficiently in excess of the highest audio frequency of 15,000 cycles to give a satisfactory deviation ratio. Present practice is to provide for a frequency swing of ± 75 kc. at full modulation. This gives a deviation ratio of $75/15$ or 5 to 1 with full modulation at the highest modulating frequency. Since the improvement ratio is from 1.73 to 2 times the deviation ratio, depending upon the type of noise, the signal-to-noise ratio in the FM receiver output will be 9 or 10 times greater in the FM receiver than in the AM receiver where both receivers have the same carrier-to-noise ratios and the same carrier strengths at their inputs. The background noise in the FM receiver will be of such low level as to be inaudible and the full quality of 15,000-cycle reproduction is enjoyed by the listener.

No such improvement of the signal-to-noise ratio is inherent in the AM receiver circuits. Even if AM broadcast stations transmitted with modulation frequencies as high as 15,000 cycles (most AM stations do not), the average listener could not enjoy 15,000-cycle reception, for he would be forced to use his tone control to bring the audio channel down to the order of 5,000 cycles or less in order to reduce the noise to a tolerable, but certainly not enjoyable, level!

Equally important as the frequency swing, in determining the deviation ratio, is the highest audio frequency which the receiver audio system is designed to handle. Suppose that while keeping the same frequency swing, the highest frequency transmitted by the audio system is reduced from 15,000 cycles to 5,000 cycles or in the ratio 3 to 1. The base of the AM noise rectangle $E'EDD'$ will be narrowed in the ratio 3 to 1, but its altitude will remain unchanged. The area of the rectangle representing the AM receiver noise will have been reduced in the ratio 3 to 1. In the case of the triangles OCD and $OC'D'$ however, both the bases and the altitudes will be reduced in the ratio 3 to 1, indicating that the areas of the triangles representing the FM receiver noise will have been reduced in the ratio 9 to 1. Thus narrowing the audio channel to one-third in both the AM and FM receivers reduces the noise in both receivers, but the improvement is $9/3$ or 3 times as great with FM as with AM.

The increase of the improvement ratio with larger deviation ratios is of particular interest in FM communications work. Here the fact that an audio channel of 4,000 cycles or less will suffice for the transmission of intelligible speech permits operation with a signal frequency swing of only 40 kc., maintaining a deviation ratio for the system of $4000/400$ or 10 to 1,

which yields an improvement ratio in the order of 20 to 1 for FM over AM. It is not surprising that field tests of mobile FM communications equipment have exploded the idea that "AM can do everything that FM can do at the same frequency."

Pre-emphasis and De-emphasis ★ In the above discussion of the effects of interfering signals and noise components, it was observed that the noise and interference effects in FM systems are very much less than in AM systems. However, it was also noted that the residue of these disturbances that appears in the FM receiver output is concentrated in the upper audio frequency range. Since noise frequencies in the upper register are more irritating to the human ear, the noise concentrated at high frequencies is more objectionable than the same amount of noise energy uniformly distributed over the whole audio frequency range. This unfavorable situation can be easily corrected in FM circuits by the use of pre-emphasis and de-emphasis.

Pre-emphasis refers to the use of a simple network in the audio system of the transmitter for the purpose of causing the higher frequency components of the program to be amplified much more than the lower frequency components. The R.M.A. standard of pre-emphasis calls for a gain-versus-frequency characteristic that is flat to 500 cycles, then rising to +20 db at 15,000 cycles, as shown in Fig. 16. Since a 20 db increase represents a ten-fold voltage step-up, the frequency swing of the transmitter on a soft 15,000-cycle sound is ten times as great as without pre-emphasis, so that the intelligence of the modulation overshadows noise in the receiver output far more effectively. There is no danger of overmodulating the transmitter seriously on the high frequencies with pre-emphasis because the energy content of the high frequency components of program material is much smaller than that of the low frequency components.

In the receiver, a simple de-emphasis network is used to bring the highs down to proper relation with respect to the lows. Its gain-frequency characteristic is the inverse of that of the pre-emphasis network. For example, whereas pre-emphasis causes the amplitude of a 15,000-cycle component to be stepped up ten times prior to modulation of the transmitter, the de-emphasis network following the detector in the receiver reduces the 15,000-cycle component to one-tenth, thus restoring it to a proper proportion with respect to the low frequency components. At the same time, the high frequency noise is reduced to one-tenth of the amplitude that it would have without pre-emphasis and de-emphasis.

The marked benefit obtained by the use of the emphasis networks is shown by a comparison of Figs. 17 and 18. In Fig. 17, the triangular area under the curve

represents the amount and the frequency-distribution of the noise in an FM system not employing emphasis, corresponding to the sum of the triangular areas of Fig. 14.

signed to the same frequency must have a considerable geographical separation, and that adequate service to a continental area like the United States requires a large

the amplifier gain control on weak passages and reducing the gain on the strong passages. Such compression of the volume range is necessitated by the inherent sig-

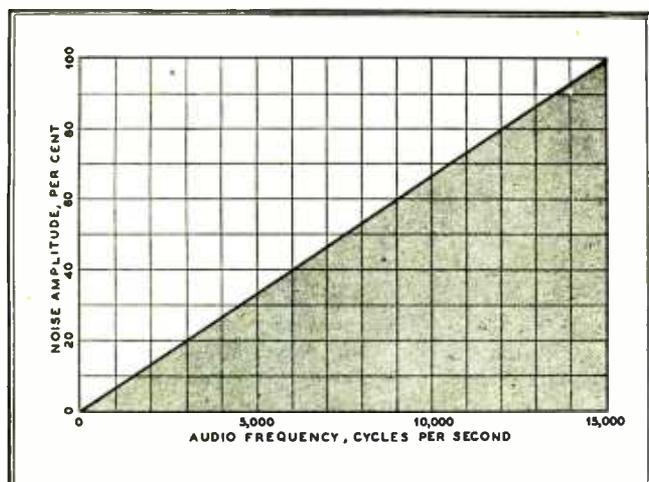

FIG. 17. FM RECEIVER OUTPUT NOISE WHEN DE-EMPHASIS IS NOT EMPLOYED

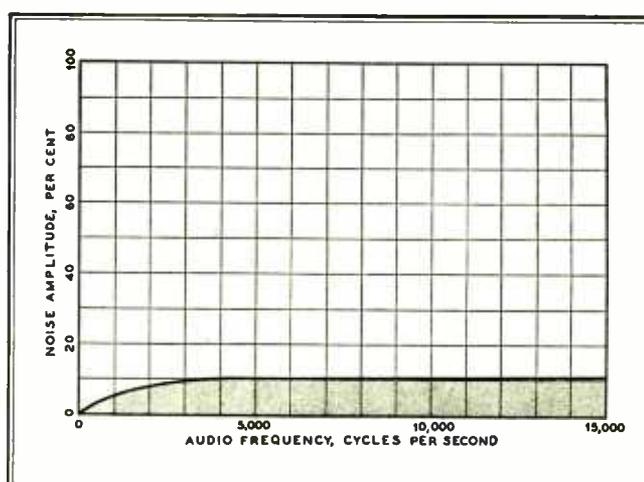

FIG. 18. REDUCTION OF NOISE INDICATED IN FIG. 17 WHEN DE-EMPHASIS IS EMPLOYED

The area under the curve of Fig. 18 represents the noise in the FM receiver when standard pre-emphasis and de-emphasis are employed. Note particularly that the greatest noise reduction occurs at the highest noise frequencies; in other words, the pre-emphasis and de-emphasis are most effective in reducing the amplitudes of the noise components at the frequencies where the noise is most likely to be annoying.

High Fidelity ★ In the discussion of noise reduction above, a typical value of 15,000 cycles was used for the highest frequency accepted by the audio amplifier of the FM receiver. This is in contrast to a value of the order of 5,000 cycles or less which is found in the typical AM receiver.

When it is remembered that the overtones of musical instruments such as the violin and flute are of appreciable amplitude in the frequency range from 10,000 cycles upward to the limits of human hearing, the importance of having noise-free reproduction of frequencies up to 15,000 cycles is evident. Why is it feasible to have an audio amplifier of greater frequency range with FM?

The reason is two-fold: 1) AM receiver circuits are not capable of increasing the signal-to-noise ratio at the receiver output over that at the input. The way in which noise can be reduced in an AM receiver is by narrowing the audio channel. In other words, the loss of the higher audio frequencies, which add so much realism to the reproduction, is the price that is paid for keeping the noise within tolerable levels. 2) AM receivers do not use a system which inherently reduces interference on frequencies very near to the frequency of the desired signal. In the AM service, the strength of the desired signal must be at least 100 times the strength of the interfering signal, if the effects of the interference are to be negligible in the receiver output. This means that AM stations as-

number of stations assigned to many different frequencies. As it has worked out, the separation between adjacent frequencies assigned to broadcast stations in the United States is only 10 kc., so that modulation at frequencies higher than 5,000 cycles produces sidebands outside of the assigned channel of the station. Receivers whose IF band width appreciably exceeds 10 kc. are therefore subject to interference whisksers from the sidebands of other stations.

The FM system, on the other hand, inherently reduces noise. It is possible therefore to widen the audio channel to 15,000 cycles and to obtain the resulting realism without raising the noise to an objectionable level. Also, in the case of FM, a 2 to 1 instead of a 100 to 1 ratio of the desired signal to the interfering signal overcomes the effects of interference, provided the FM receiver is well designed, so that the full potentialities of the FM system are realized. Thus in FM more stations can be operating simultaneously with wider (200 kc.) channels assigned to each, without creating a serious interference problem.

Dynamic Range ★ The term *dynamic* range refers to the difference in sound levels between the loudest and softest portions of program material. For symphonic music, the range may be in the order of 70 db, corresponding to a voltage ratio of about 3,000 to 1. The transmission of the full volume range makes it possible to reproduce at the receiving set the same relation between the loud and soft passages as would be heard at the studio — the relation, for example, between the spoken word and a pistol shot, or between a violin solo and the brilliant finale of a symphonic orchestra.

In AM broadcasting, the volume range is reduced by the control operator to the order of 35 db. This is done by advancing

nal-to-noise ratio in AM which, in best practice, seldom exceeds 40 db.

Even where the line characteristics are such that the full dynamic range of a symphonic program can be transmitted, the average AM receiver is incapable of giving a satisfactory reproduction of the full dynamic range because of the presence of hum and noise. If the volume control is adjusted to a setting where the loudspeaker is not overloaded on the loud passages, reception can be satisfactory at the high and medium levels of the music in spite of the presence of noise because the program energy greatly exceeds the noise energy and thereby renders the noise unnoticeable to the human ear. On the soft passages of the music, however, where the average amplitude of the music is about 1/3000th of that on the loudest passages, the hum and noise will be very apparent; in fact, the music amplitude may be well below the amplitude of the disturbances, so that the music is not even heard during the soft passages and the noise level appears to have risen. Only by narrowing the audio channel of the AM receiver to reduce the noise, and by operating with a reduced dynamic range at the AM transmitter so that the average amplitude on the weakest passages is not less than 1/50th or 1/100th of that on the strong passages, can tolerable reception be achieved in the AM receiver. Tolerable, perhaps, but not realistic!

In the FM system, the noise in a well-designed broadcast receiver is at such a low level that it is possible to hear the softer sounds satisfactorily without having the volume control advanced to the point where the speaker is overloaded on the stronger passages. Also, by employing a wide frequency swing at the transmitter, a sufficiently high deviation ratio for the FM system can be obtained to give a good improvement in the signal-to-noise ratio even with an audio channel extending as

high as 15,000 cycles. The inherent signal-to-noise ratio for best practice is 70 to 75 db. Thus full realism of reproduction can be achieved in the FM receiver.

The reproduction of the full dynamic range also adds *presence* to the program at the receiver output. The overtones of musical instruments in the frequency range above 10,000 cycles have already been mentioned. Most instruments have important overtones at lower frequencies, also — even at frequencies of less than 1,000 cycles. A listener seated near the orchestra in the studio hears these overtones better than a listener who is at a greater distance, because the soft overtones have a more favorable ratio with respect to the room noise when the listener is close to the orchestra. Similarly, a system which does not reduce the dynamic range appreciably in the course of transmission and reproduction makes the lis-

tener feel that he is present at the studio in a way that mere loudness of the reproduced sound can not accomplish.

The factor of dynamic range and high fidelity are so noticeable to the owners of well-designed FM receivers that they are able to state immediately whether a program is being originated and transmitted under circumstances that permit the realization of the full capabilities of the FM system, or whether the program has undergone a compression of its dynamic range and frequency range, as when it has been passed over an AM network line.

Duplex Operation ★ Another operational advantage of the FM system is the possibility of conducting two or more services to the public simultaneously over the same station while operating within its assigned channel width. While multiplexing of various unrelated transmissions is feasible,

the most frequent application of this feature of FM will probably come in the form of duplex operation, where a second service is offered that is complementary to the first.

For example, facsimile, the transmission of printed material and pictures, may complement the sound transmission. The broadcast receiver owner may receive his newspaper, complete with pictures, from facsimile equipment attached to his receiver, without interference to his favorite programs. Many newspaper publishers have already taken steps toward the establishment of facsimile services at a yearly cost to the listener comparable to that of a newspaper subscription.

Facsimile duplexed with sound may become an important auxiliary to the police radio systems. It is possible, for example, to transmit photographs and fingerprints rapidly.

GENERAL FM THEORY

SECTION 3: ATMOSPHERIC EFFECTS ON RADIO PROPAGATION. ADVANTAGES IN DEPENDABLE COVERAGE OBTAINED WITH OPERATION AT FM FREQUENCIES.

THE two previous sections have explained the notable improvements that are obtained when a well-designed system of FM transmission and reception is substituted for AM. The advantages in the

could furnish only 5 channels 200 kc. wide. Hence it has been necessary to assign frequencies above 40 mc. to the FM broadcast stations. For the same reason, the frequencies allocated to police radio and other emergency communication systems are considerably higher in the case of FM than with AM.

This shift to a very high carrier frequency, incidental to setting up an FM system, introduces additional advantages in terms of improved signal coverage, as will be explained in this chapter.

In particular, the FM signals suffer less from the effects of the Ionosphere than AM signals at the lower carrier frequencies. With a view to understanding the difference between the propagation characteristics of the FM and AM frequencies, it is desirable to review briefly the nature of the Ionosphere and its effects upon radio signals.

Nature of the Ionosphere ★ The atmosphere of the earth can be regarded as consisting of a number of concentric shells or layers of various thicknesses above the earth's surface, as shown in Fig. 19. Each layer has its own distinguishing characteristics and certain of the layers exercise an influence upon radio waves, as will be shown presently.

The shell nearest to the earth's surface is called the *Troposphere*, extending upward about 10 miles. It is the weather belt of the earth, with fluctuating temperatures and barometric pressures.

Above the Troposphere in Fig. 19 is shown the *Stratosphere* or Isothermal layer of thin air, whose distinguishing charac-

the Stratosphere, at night. Above the Ozonosphere is a layer about 20 miles thick, called the *Alto-troposphere*. This layer also absorbs sunlight and undergoes wide variations of temperature between day and night. The temperature varia-

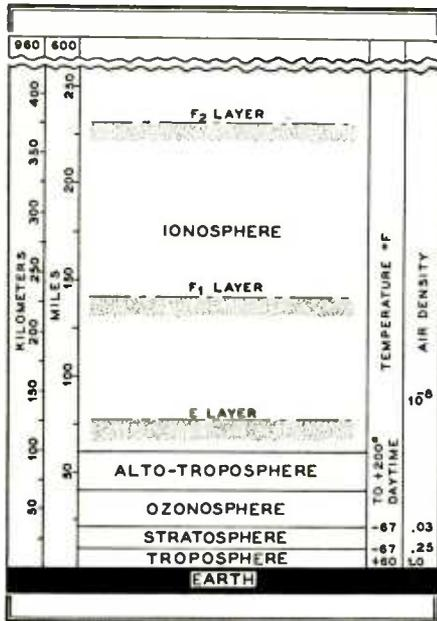

FIG. 19. ARRANGEMENT OF THE SHELLS OF THE EARTH'S ATMOSPHERE

favor of FM that were enumerated are inherent in the FM circuits, and are not dependent upon the signal carrier frequencies employed in the two systems.

As a practical matter, however, since FM requires a greater channel width than AM, FM stations must be assigned to a higher portion of the frequency spectrum,

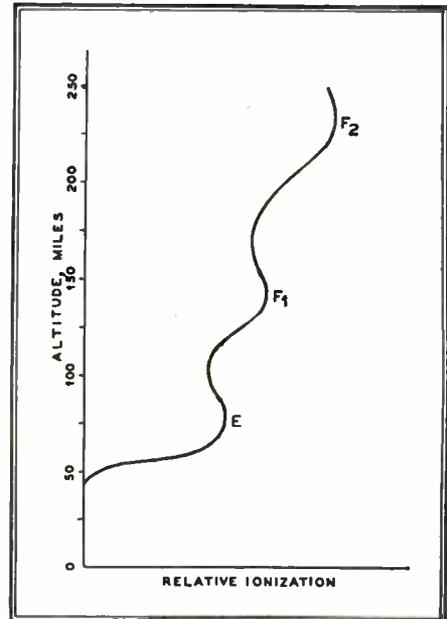

FIG. 20. DEGREE OF IONIZATION AS A FUNCTION OF HEIGHT ABOVE THE EARTH

tions cause changes in atmospheric pressure of an appreciable percentage, but the order of all pressures at these altitudes is, of course, quite low.

The fifth layer is the *Ionosphere*, beginning at a height of about 60 miles above the earth and extending upward for several hundred miles, at least. It is characterized by an air pressure as low as .00000001 of the normal pressure at the surface of the earth. The pressure within the Ionosphere is, therefore, in the order of that found within a vacuum tube.

Throughout the earth's atmosphere there is ionization, that is, radiation from the sun acting upon the molecules of the gases of the air causes the liberation of electrons and the creation of ions. The ionization is very slight in the Troposphere but tends to increase with altitude, because in regions of reduced atmospheric pressure the likelihood of a rapid recombination of electrons and ions diminishes. Particularly in the Ionosphere, where the pressure is extremely low, a liberated electron can travel for a relatively long time before encountering an ion. Thus comparatively large numbers of free electrons and ions exist at the high altitudes of the Ionosphere, as indicated by the curve of Fig. 20.

It will be noted that the ionization within the Ionosphere, Fig. 20, is not of

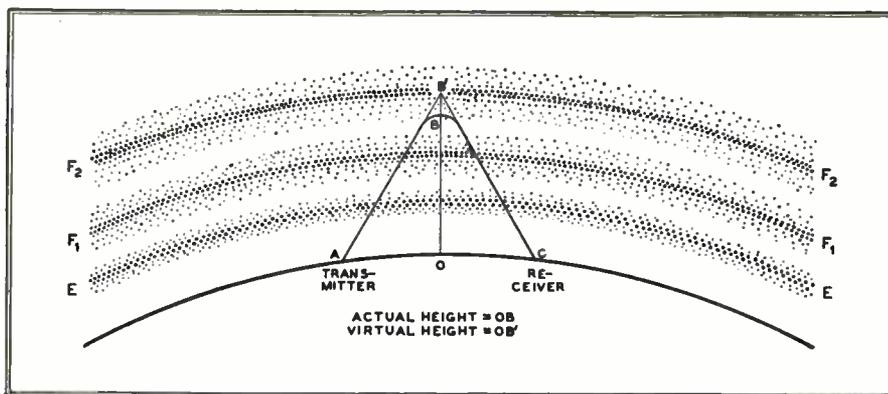

FIG. 21. TYPICAL PATH OF A WAVE RETURNED TO EARTH FROM THE F2 LAYER

where a greater band of frequencies is available.

For example, the FM broadcast station channel width is 200 kc., while the channel width of the AM station is 10 kc. The present standard broadcast band, extending from 550 to 1,600 kc., provides 106 10-kc. channels for the AM stations but

teristic is a constant temperature of about -67°F .

The *Ozonosphere*, a third layer about 18 miles in thickness above the Stratosphere, contains free oxygen which serves to absorb the actinic rays of the sun. Its temperature rises as high as 200°F . during the daytime but falls to -67°F ., like that of

uniform density but is concentrated in at least three layers, designated E , F_1 and F_2 , at various heights. This is believed to be due to a difference in the proportions of the several gases at various levels in the Ionosphere, since the gases differ in their ability to absorb energy from solar radiation.

When a radio wave from the earth approaches one of these layers of ionization, it will tend to be reflected or refracted back toward the earth, as shown in Fig. 21.

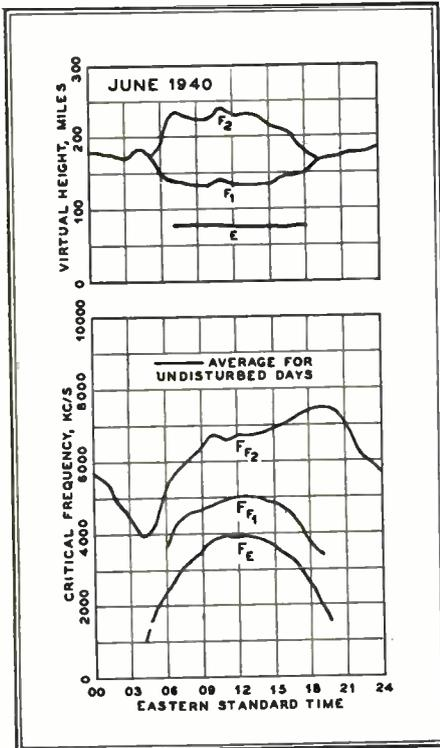

FIG. 22. VIRTUAL HEIGHTS AND CRITICAL FREQUENCIES OF IONOSPHERE LAYERS

provided the frequency of the wave is not too high. The mechanism of bending is explained as follows: When the wave enters the ionized region, its electric field sets the free electrons and ions into a vibratory motion. The movement of the heavy ions is so slight as to be unimportant, but the movement of the electrons is appreciable. The path of movement of the electrons is determined by the orientation and the direction of motion of the electric field, and by the magnetic field of the earth. The vibrating electrons represent a current that creates a reradiated field, which, together with the original field, causes a bending of the direction of motion of the wave, away from the region of more intense ionization.

As the frequency of the wave is lowered, the refraction or bending is greater. On the other hand, if the frequency of the wave is sufficiently high, the wave can penetrate one layer, but may be refracted by the next higher layer, which has a greater degree of ionization. It is also possible for the frequency of the wave to be so high that it will penetrate all layers and be lost in space. Whether or not the wave will be

bent back to earth depends, therefore, upon the frequency of the wave, the height of the refracting layer, and its density of ionization.

The density of ionization of a layer is measured by determining the highest frequency that can be returned to earth from the layer, when the wave enters the layer perpendicularly. This frequency is called the *critical frequency*.

The *virtual height* of a layer is that height at which reflection from a sharply defined plane, in the absence of ionization, would give the same transit time as is taken by the refracted sky wave in traveling over its curved path from the transmitter to the receiver. In other words, in Fig. 21, the same time would be taken to travel over the path $AB'C$ at the velocity of light as is actually required by the wave in traveling its curved path ABC at a velocity which, in the vicinity of B , is less than the velocity of light.

F_1 layer during most of the daytime in the summer, but the difference in height is not as great in the winter. The critical frequencies of both the F_1 and F_2 layers are variable, being maximum at local noon in the winter and during the late afternoon in the summer.

With the approach of sunset, the height of the F_1 layer increases while the height of the F_2 layer approaches that of the F_1 layer. At sunset, the layers merge to form a single F layer which remains throughout the night, rising to a maximum height of about 200 miles at local midnight. Shortly after sunrise, the F layer separates into the F_1 and F_2 layers previously mentioned, except on winter days during a year of great sunspot activity, when the layers do not separate appreciably.

While the virtual heights of the layers vary with the time of day and the season of the year, the cycle of variations of virtual height is repetitive with little change

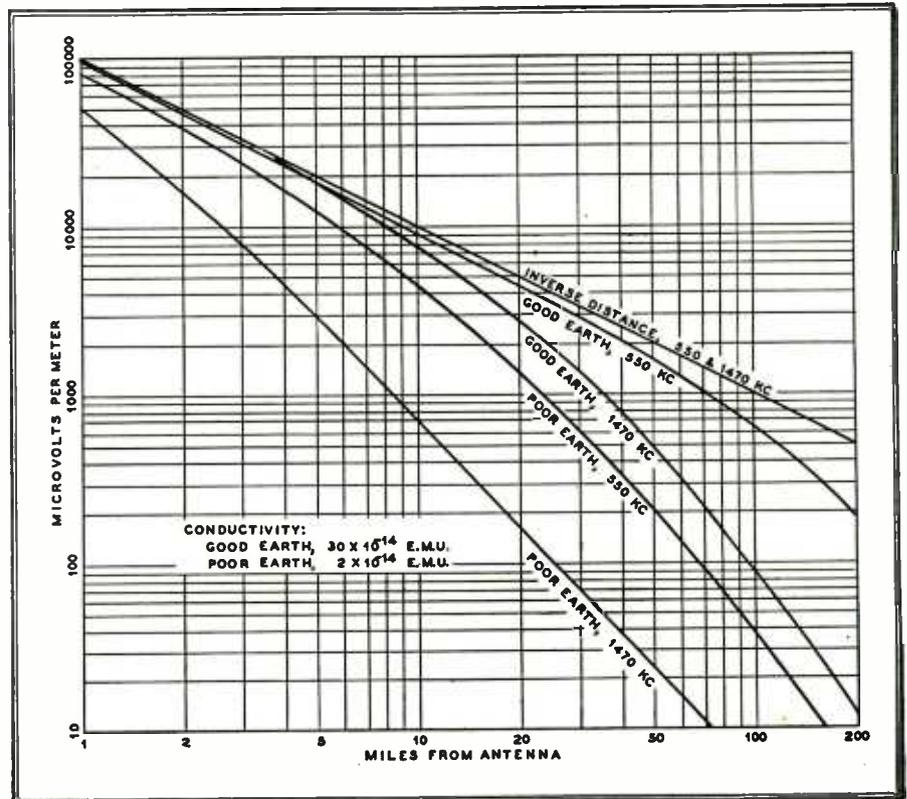

FIG 23. AM FIELD STRENGTH AS A FUNCTION OF DISTANCE AT 550 AND 1470 KC.

The lowest important ionized layer within the Ionosphere is the E layer, whose virtual height remains practically constant at 70 to 75 miles throughout the daytime during every season of the year. As shown in Fig. 22, the critical frequency of the E layer is variable, with a maximum at local noon. The maximum is higher in summer than in winter.

The next higher daytime layer is designated the F_1 layer, which, as shown in Fig. 22, has a minimum height of about 130 miles at local noon, with somewhat greater heights in the forenoon and afternoon.

The third important daytime layer is the F_2 layer. It is much higher than the

from year to year. The critical frequencies of the layers, however, are affected by the sunspot numbers, and hence are subject to variation over the period of the 11-year sunspot cycle. In a year of large sunspot numbers, the critical frequencies of all layers, particularly that of the F_2 layer at local noon in the winter, are very much higher than in the years of slight sunspot activity.

Sufficient knowledge of the general trends of the variations of the Ionosphere characteristics has been gathered during the past decade to permit the prediction of Ionosphere propagation characteristics in advance. The predictions have consid-

erable reliability, except for short periods of unusual sunspot activity.

Effects of the Ionosphere ★ It has been stated that the Ionosphere has more effect upon the radio waves of the standard AM broadcast frequencies than upon the radio waves at FM frequencies. The reason is quite simple. FM broadcast frequencies are in excess of 40 mc., and hence are greater than the maximum critical frequencies of all the ionized layers, with the exception of the F_2 layer during short

sphere is caused by collisions between the free electrons that have been set in vibratory motion by the electric field of the wave and the drifting gas molecules. Within the Ionosphere, from the E layer upward, the absorption is quite small, because while many free electrons are present, the atmospheric pressure is so low that collisions of the electrons with gas molecules are relatively infrequent. On the other hand, when the intense radiation from the sun in daytime causes the ionization to be extended downward in the E

tour, although in locations where man-made noise and interfering signals are at a minimum, it is possible to obtain satisfactory daytime service with lower field strengths.

The field strength at the receiver depends in part upon the power of the transmitter and upon the efficiency of the radiating system, since these factors determine the strength of the field that is initially established in the immediate vicinity of the transmitting antenna. However, the field strength at the receiver also depends

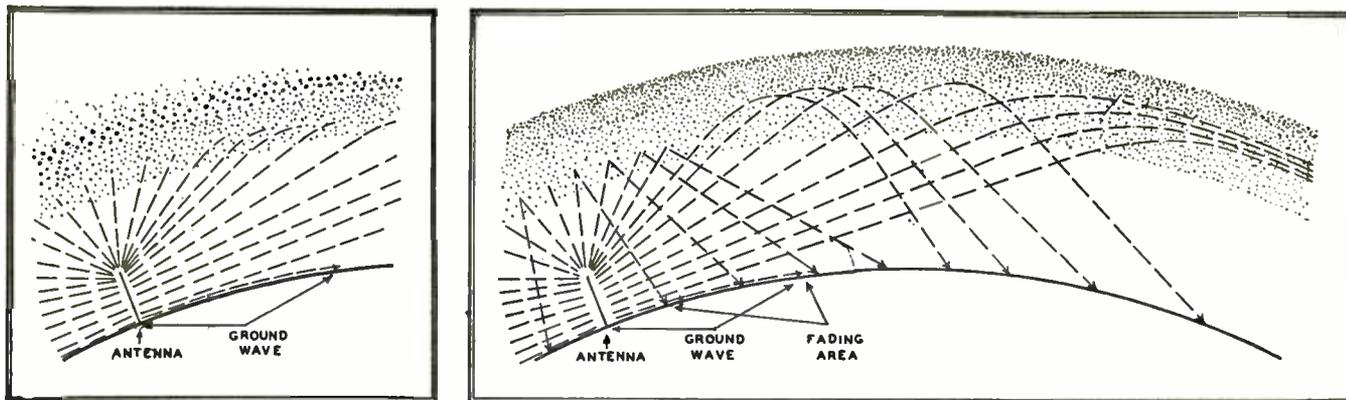

FIG. 24. LEFT: AM BROADCAST TRANSMISSION DURING DAYLIGHT HOURS IS BY MEANS OF THE GROUND WAVE. SKYWARD TRANSMISSION IS ABSORBED IN REGION BELOW E LAYER. RIGHT: AT NIGHT, SKYWAVES, RETURNED TO EARTH, GIVE LONG-DISTANCE COVERAGE, BUT CAUSE FADING IN THE OUTER PORTION OF THE AREA REACHED BY THE GROUND WAVE

periods around noon on winter days in the years of greater sunspot activity, when long distance transmission by F_2 layer refraction can occur at frequencies somewhat in excess of 40 mc. In general, however, the skyward transmissions of radio waves at FM frequencies penetrate the ionized layers and do not return to earth.

On the other hand, the frequencies of the broadcast band, from 550 to 1,600 kc.,

layer, and even to regions in the Altotroposphere, just below the E layer, then an area of high absorption characteristics is created because of the higher pressure of the gases within the area. Since waves at AM broadcast frequencies would tend to make their refractive bend largely within this area, below the E layer, they are especially susceptible to absorption and very little skywave energy is returned

upon the loss sustained by the ground wave in traveling from the transmitter to the receiver. The amount of this loss depends upon the distance traveled, the conductivity of the ground, and the frequency of the transmitter.

The field strength would vary inversely as the distance if there were no ground losses, as shown by the straight-line inverse distance curve in Fig. 23. Actually, there is a continuous loss of energy as the wave passes over the ground, which is greater when the soil conductivity is poor and the frequency is high, as shown by the other curves of Fig. 23.

For example, when the inverse distance signal strength at one mile is 100 millivolts per meter, Fig. 23 shows that the distance to the 500 microvolt-per-meter contour would be 200 miles if there were no loss in the ground.

If the radio wave from the station mentioned above has a frequency of 550 kc. and is passing over ground having relatively good conductivity (30×10^{-14} electromagnetic units), such as might be found in regions of rich soil and low hills, the distance to the 500-microvolt contour, by reference to Fig. 23, is about 115 miles. On the other hand, if the ground conductivity were rather poor (2×10^{-14} electromagnetic units), as in the regions of steep hills and rocky soil, then the distance to the 500-microvolt contour would be only about 33 miles at the same frequency. If the frequency of the station in the latter case were increased from 550 to 1,470 kc., the distance to the 500-microvolt contour would be reduced to about 12 miles!

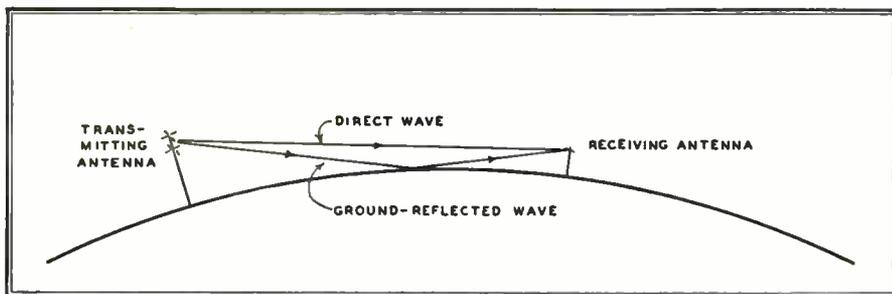

FIG. 25. TRANSMISSION AT VERY HIGH FREQUENCIES IS EFFECTED BY MEANS OF BOTH GROUND-REFLECTED WAVES AND DIRECT WAVES, AS THIS DRAWING SHOWS

are well below the critical frequencies of the F_1 , and F_2 layers, and also somewhat below the critical frequency of the E layer. It would appear at first thought, therefore, that skywave transmission would occur at the standard broadcast frequencies at all times. Actually, such transmission occurs only at night because in the daytime the absorption of energy in the regions immediately below the E layer is so great at the AM broadcast frequencies that no appreciable energy from the skyward transmission returns to the earth.

The absorption of energy from the radio wave in the upper reaches of the atmos-

to the earth at these frequencies in the daytime.

Daytime AM Broadcast Coverage ★ Since skywave transmission is not feasible on AM broadcast frequencies during daylight hours, the area that is served by an AM broadcast transmitter is that which the radio wave traveling over the surface of the earth can reach with sufficient field strength for proper operation of the average broadcast receiver.

The area of usable signal strength in the daytime is commonly assumed to be that within the 500 microvolt-per-meter con-

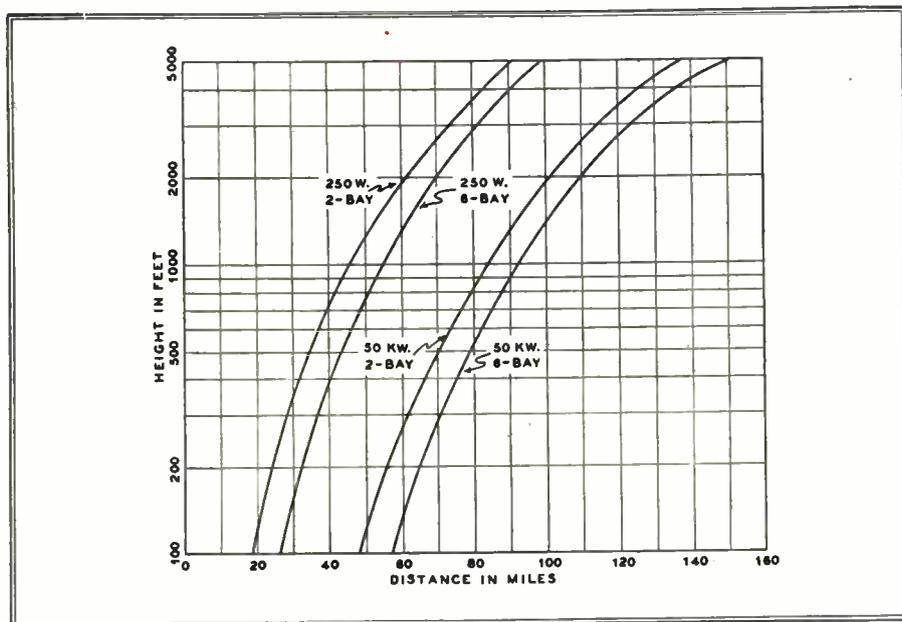

FIG. 27. RELATION OF HEIGHT, POWER, AND DISTANCE TO 50-MICROVOLT CONTOUR

Thus the range of usable signal in the daytime for broadcast stations at AM frequencies having the same field strength at one mile depends to a very great extent upon the conductivity of the earth and the frequency of the station.

Night-time AM Broadcast Coverage * The ionization in the region just below the *E* layer, where heavy absorption occurs during the day, is largely dissipated shortly after sunset. Thus energy transmitted skyward at night can be reflected back to earth with only moderate losses, as shown in Fig. 24.

Since the paths traveled by the skywave and the ground wave are unequal in length, it can be expected that they will be out of phase in the area where the sky wave returns to the earth and meets the ground wave. Furthermore, since the height of the ionized layer is not constant, the length of the skywave path is not constant. The result is a continuous change in the phase relationship between the ground wave and the returning skywave, which gives a resultant wave whose amplitude varies between the sum and the difference of the amplitudes of the two component waves. In other words, in the area where the ground wave and the sky wave are of nearly the same amplitude, the receiver responds as if it were receiving a signal of widely varying strength.

The phase relationship between the ground wave and the returning sky wave depends upon the wavelength as well as upon the difference in the lengths of the paths. Since the carrier and its two sidebands have slightly different wavelengths, different phase relationships between the ground wave and the skywave components at these three frequencies can occur at the receiving location. The cancellation or reinforcement being of unequal degree at the three frequencies, it is possible for the carrier and sideband components at the receiver to acquire a proportion, each

with respect to the others, that is quite different from that existing at the transmitter. This produces an effect which is called

selective fading, which appears as audio distortion at the receiver output.

The area of serious fading may begin at less than 75 miles from the broadcasting station and may extend to 125 miles or more, the location and the extent of the area varying with Ionosphere conditions. Thus in the case of night transmission from high-power broadcast stations, the skywave can actually reduce the area to which the ground wave delivers a good signal during the daytime.

The distance at which fading begins is somewhat greater when the frequency of the broadcast station is low and the ground conductivity is high, because the ground wave is stronger and overrides the skywave for a greater distance from the station. The use of transmitting antennas that minimize the radiation at high angles also tends to extend the distance at which fading sets in, because they diminish the strength of the skywave that returns to the earth fairly near the transmitter. However, the wavelengths at the AM broadcast frequencies are so long that it is physically impracticable to build an array

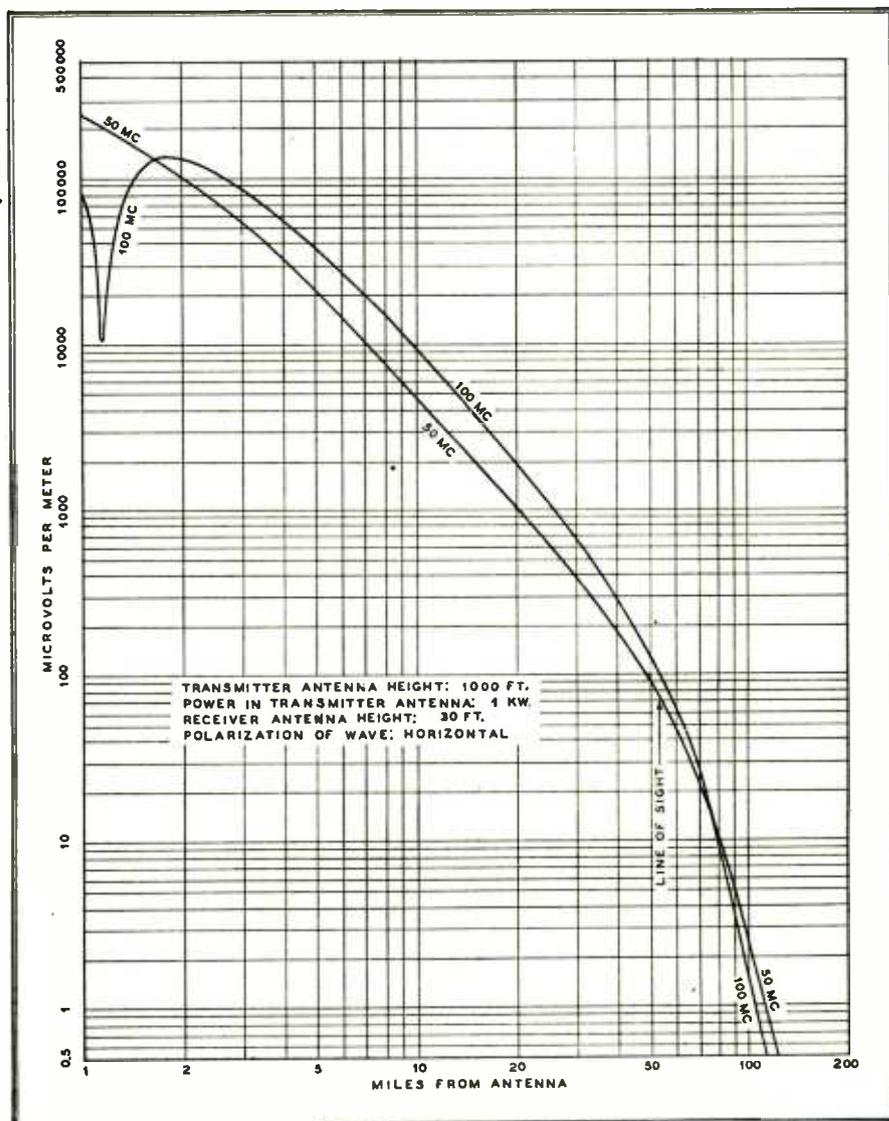

FIG. 26. FIELD STRENGTH AS A FUNCTION OF DISTANCE AT VERY HIGH FREQUENCIES

several wavelengths in height that would suppress skyward radiation altogether.

Beyond the zone of severe fading that is caused by ground and skywave interference, high-power broadcast stations are able to render a service extending over hundreds of miles at night by means of the skywave alone. This wave travels for considerable distances in the Ionosphere, where absorption is low, before it is bent back to the earth. Hence its signal strength is comparable to that of the ground wave of a nearby station.

The distant areas thus served by the skywave at night are referred to as the *secondary coverage* of the station. The quality of the service in these areas is distinctly inferior to the primary coverage by the ground wave, because the skywave is subject to slow fading and to selective

however, to cover distances more than twice the line-of-sight range when powerful FM transmitters are employed. This is due in part to the diffraction or spreading of the wave energy from a straight-line path as it passes from the transmitter to the receiver. It is also due in part to a slight bending of the path in the direction of the curvature of the earth, which is a result of the very slight decrease in the dielectric constant of the air that goes with an increase of height in the Troposphere.

It is particularly desirable to locate the FM transmitting antenna at a considerable height in order that the greatest distance to the optical horizon may be obtained. The height of the FM receiving antenna should also be made as great as practicable, in order to obtain good pick-up of signal energy, particularly if

antenna when the frequency is high, because any given change in the difference between the path lengths will then represent a larger fraction of a wavelength and a greater change in phase. In general, however, the minimum field strength in this area near the transmitter is more than adequate to operate the receiver, so that no dead spots are created.

The effect of frequency upon the field strength of stations of equal power is shown in Fig. 26. The curves represent the field strengths that will be obtained at frequencies of 50 mc. and 100 mc. from 1-kw. transmitters, using half-wave dipole antennas located at a height of 1,000 ft., and receiving antennas 30 ft. high.

In the case of the 100-mc. curve a fall and rise of signal strength with respect to distance is noted within a 2-mile radius of

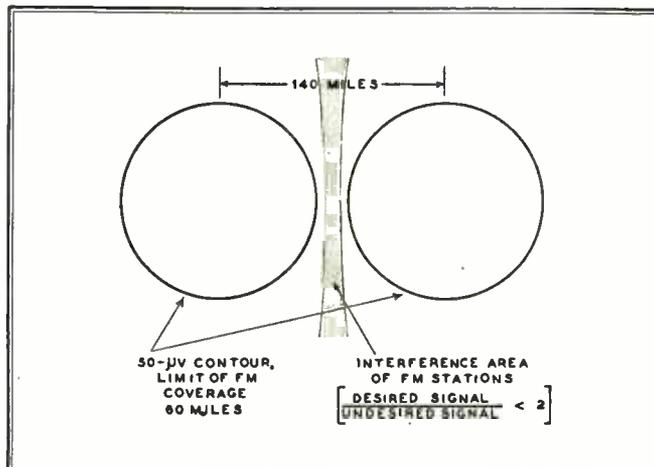
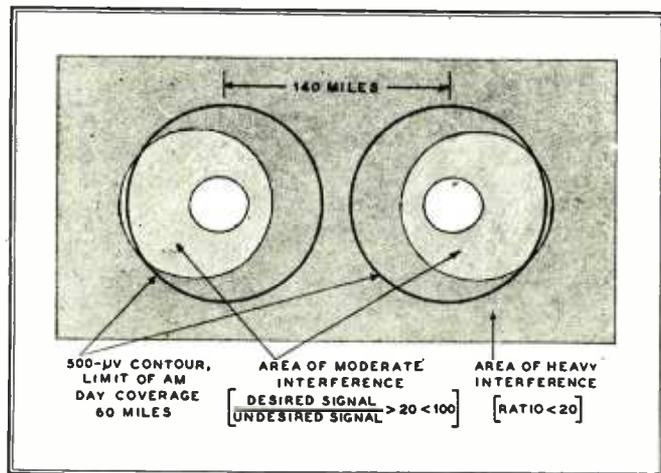

FIG. 28, LEFT: DAYTIME INTERFERENCE BETWEEN AM STATIONS 140 MILES APART, WITH 60-MILE RADIUS TO 500-MICROVOLT CONTOUR (MID-BAND FREQUENCY AND AVERAGE GROUND CONDUCTIVITY). FIG. 29, RIGHT: INTERFERENCE BETWEEN FM STATIONS 140 MILES APART, WITH 60 MILES TO 50-MICROVOLT CONTOUR (50-MC. FREQUENCY AND 1,000-FT. TRANSMITTING ANTENNA)

fading, as the radio waves follow different paths of varying length through the Ionosphere. In spite of the imperfection of sky wave propagation, however, it has been a means of serving many remote locations that are outside the primary coverage areas of all broadcast stations.

FM Coverage ★ It has been shown above that, except under special circumstances, radio waves at the FM frequencies are not returned from the ionized layers of the Ionosphere. It was noted also that the ground wave, which accounts for the primary coverage in broadcasting at the AM frequencies, is subject to increased loss as the frequency is increased. At the much higher frequencies of the FM band, the ground wave loss is so high that its intensity is negligible except in the immediate vicinity of the transmitter.

Transmission at the FM frequencies, therefore, is achieved by means of the direct wave and the ground-reflected wave. These waves tend to have straight-line paths rather than curved paths, as shown in Fig. 25.

The characteristics of propagation at FM frequencies therefore tend to approach those of light. It is entirely feasible,

the receiving location is somewhat beyond the optical horizon of the transmitter.

In general, the signal voltage induced in the receiving antenna varies inversely as the square of the distance from the transmitting antenna, and directly as the product of the heights of the two antennas, assuming that they are a fair distance apart but within line-of-sight. Beyond line-of-sight, the field strength falls off more rapidly than by the square of the distance, and it becomes especially important to have a high receiving antenna.

On the other hand, in the immediate vicinity of the transmitter antenna, where the ground-reflected wave strikes the earth at a relatively large angle, the field strength will alternately increase and decrease as a receiving antenna of fixed height is moved away from the transmitter. This rise and fall of signal strength with respect to distance is due to the relatively large change in the difference of the path lengths, whereby the phase of the reflected wave with respect to the direct wave is varied over such a wide range that alternate cancellation and reinforcement of the direct wave occurs. This effect is more pronounced and extends to a greater distance from the transmitting

the transmitter. At 50 mc., the variations are confined within a distance of one mile, so that they do not appear in Fig. 26.

It is also evident from Fig. 26 that within line-of-sight, the field strength is somewhat greater for the 100-mc. signal. For example, the distance to the 1-millivolt contour is 20 miles at 50 mc., but about 26 miles at 100 mc. The 50-microvolt contour occurs at 63 miles in the case of the 100-mc. signal and at 59 miles for the 50-mc. signal. This is slightly beyond line-of-sight for antenna heights of 1,000 ft. and 30 ft. At still greater distances, the higher frequency signal falls off more rapidly than the lower frequency signal, and at distances beyond about 78 miles, Fig. 26 shows the strength of the 50-mc. signal to be greater than that of the 100-mc. signal. It is important to note that the curves of Fig. 26 assume the existence of flat terrain. In hilly country, the signal strength suffers a much greater attenuation at 100 mc. than at 50 mc.

The signal strengths that are actually measured at various distances will vary from the values shown by mathematically derived curves of the type shown in Fig. 26.

While deviation between measured and calculated field strengths is found at the AM broadcast frequencies, the discrepancies are more often due to varying ground conductivity than to reflection or shadows. The dimensions of intervening objects in the path of a radio wave must be appreciable in terms of a wavelength before reflection from the object and reduced signal strength behind the object (shadow) will occur. Only objects of substantial dimensions, such as large buildings, power lines, or steep mountains, are capable of creating strong reflections at the low frequencies. For the most part, radio waves at AM broadcast frequencies

composed of crossed pairs of horizontal dipoles mounted above each other in layers or bays.

The concentration of the radiation in a horizontal plane by the use of an antenna of several bays is equivalent, so far as the field strength is concerned, to increasing the power radiated from a smaller, single-bay antenna. Hence multilayer turnstiles are often called *power gain* antennas. When a 2-bay antenna is employed, the same transmitter output gives a field strength at a given receiving antenna that is 1.12 times greater, equivalent to a power gain of 1.27 times. When a 6-bay antenna is employed, the field strength is

from the transmitter. For example, it has been mentioned that transmission of very high frequency signals beyond the line-of-sight is aided by the decrease in dielectric constant of the Troposphere with increase of altitude. The dielectric constant is not dependent upon altitude alone, however, but fluctuates with the weather, causing the range of the FM wave to increase and decrease.

Also, under certain conditions, a sharply defined region having an abnormal dielectric constant can be temporarily established at an altitude of 1 mile or more in the Troposphere. Such regions cause *Tropospheric reflections* of very high frequency waves back to earth. The strength of the tropospheric wave is variable, since it is related to the weather. Its general effect is to make it possible to detect signals from FM stations somewhat beyond their normal range at times, and to cause moderate variations of signal amplitude toward the outer limits of the normal range.

Another transmission vagary results from cloud-like areas of intense ionization floating within the *E* layer. These can cause sporadic skywave transmission to distant areas. Such sporadic-*E* transmission can occur at any time, but is more prevalent in the summer. Whether or not interference to local reception will be experienced in the distant areas will depend upon the ratio of the amplitudes of the desired signal from the local station and the interfering sporadic-*E* signal from the distant station. If the ratio is 2 to 1

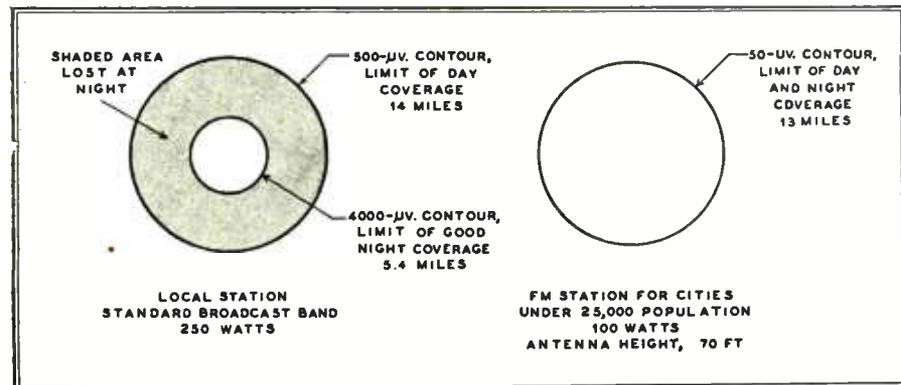

FIG. 30. DAY AND NIGHT COVERAGE OF LOW-POWER AM AND FM TRANSMITTERS

readily flow around intervening objects.

On the other hand, when the wavelength is in the order of a few meters, as at FM frequencies, reflections from objects are much more noticeable. Particularly in cities remote from the transmitter and over rough terrain, signal strength will vary over a wide range from one antenna location to another. Areas of shadow may also be created behind reflecting objects, although within city areas this is not a serious problem, if the transmitting antenna is high, because reflections from nearby buildings usually raise the signal strength within the shadow area.

While such multipath transmission is a source of concern in television reception, where differences in the path lengths cause multiple images to appear on the viewing screen, it is of little concern in FM under the receiving conditions usually encountered within cities, because the differences in the times required for the radio waves to reach the receiver via the various paths are small compared to the time of a cycle in the audio frequency range. Also, since the positions of the reflecting objects are fixed, multipath transmission of this type is not of itself productive of such fading.

The fact that the wavelength of a radio wave at FM frequencies is quite short makes it entirely practicable to build transmitting arrays of several wavelengths in height for the purpose of concentrating toward the horizon the power that otherwise would be radiated at very high and very low angles. An example of such an array is the multilayer turnstile antenna,

increased 2.04 times, equivalent to a power gain of 4.15 times.

The curves of Fig. 27 show the distance to the 50-microvolt contour for a .50-kw. transmitter when 2-bay, and 6-bay turn-

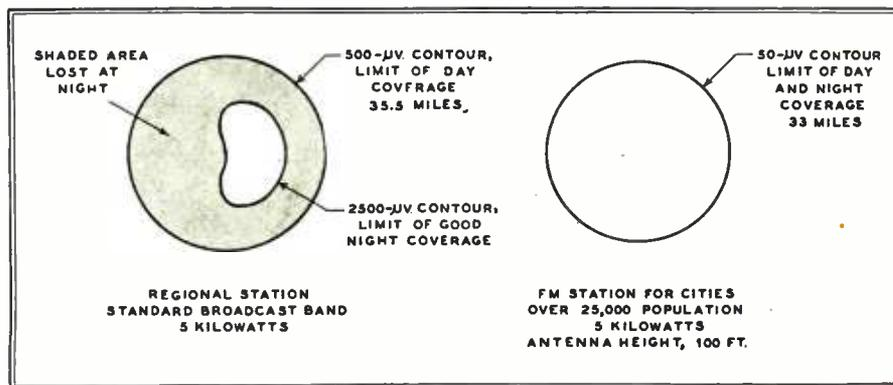

FIG. 31. DAY AND NIGHT COVERAGE OF MEDIUM-POWER AM AND FM TRANSMITTERS

stile antennas of various heights are employed. For example, when the transmitting antenna is located at a height of 1,000 ft., the distance to the 50-microvolt contour is 84 miles when a 2-bay antenna is employed, but is increased to 93 miles with a 6-bay antenna.

At considerable distances, for example, well beyond the 50-microvolt contour of an FM broadcast station, signals at very high frequencies are subject to fluctuation of amplitude. So long as the least amplitude is sufficient to operate the limiter of the receiver, satisfactory reception can be obtained.

Several factors operate to cause variation of signal strength at great distances

or greater, the interference will not be noted. Sporadic-*E* transmissions of appreciable strength are experienced for such a small fraction of the total time, that this type of interference is not considered important to FM reception. Their effect is very slight.

Bursts, which are sudden increases in the signal strength of a distant station, lasting from a fraction of a second to one or two seconds, appear to be related to sporadic-*E* transmission, and are likewise of little concern. The average owner of a well-designed FM receiver, incorporating a limiter, is entirely unaware of the existence of these vagaries of propagation.

Interference Considerations ★ In this discussion of the effects of the propagation characteristics upon coverage, the presence of signals from stations other than the desired station was not considered. However, satisfactory radio reception depends not only upon having a signal strength at receiving location sufficient to operate the receiver. It is also necessary that the strength of signals from other stations on the same frequency be of such low amplitude that they are not heard by the listener.

In the matter of such interference, the FM system possesses a considerable advantage over the AM system, as explained in the previous chapter. The ratio of the amplitude of the desired signal to that of the interfering signal must be 100 to 1 for good AM reception, whereas a ratio of 2 to 1 is adequate in a well-designed FM system.

Fig. 28 shows the area of daytime interference between two AM stations of the same power and the same frequency, located 140 miles apart, each having a distance of 60 miles to its 500-microvolt contour. In other words, within the shaded area of Fig. 28, the field strength of one station is less than 100 times the field strength of the other. The loss of primary coverage for each station caused by the presence of the other station is shown by the portion of each circle that is shaded.

In Fig. 29 is shown the area of interference between two FM stations located 140 miles apart, having the same coverage as the primary coverage of the AM stations represented by Fig. 28. The interference area, in which the field strength of one FM station is less than twice that

of the other, lies entirely outside the 50-microvolt contours.

A comparison of Figs. 28 and 29 shows why, even if only daytime operation were to be considered, it would be possible to operate many more FM stations on the same frequency, with less geographical separation between stations, than in the case of AM.

With the advent of nightfall, the AM interference problem is vastly complicated by the presence of the sky wave, which causes the signals of AM stations to be heard for distances of hundreds of miles. On the other hand, the maximum range of the signals from an FM station is practically the same at night as during the daytime, so that no new source of interference is introduced. Every effort has been made to reduce the AM interference problem. Standard stations in the same locality have a frequency separation of at least four channels (40,000 cycles) to minimize adjacent channel interference; many local stations are required to reduce power after sunset; other stations are required to use directional antennas at night to minimize radiation in the direction of distant stations on the same frequency. In spite of these precautionary measures, the interference problem on the AM frequencies is serious, and a much stronger signal from the desired station is required at night to override interference than is necessary in the daytime. Since the power radiated from the desired station can not be increased, the area of satisfactory coverage of the station is reduced by the sky wave interference at night.

For example, the effects of night inter-

ference upon the typical local AM station operating with a power of 250 watts is shown at the left in Fig. 30. At night, a signal strength of at least 4,000 microvolts per meter is required to override the increased interference. This means that the effective range of service is reduced from 14 miles for the daytime limit of the 500-microvolt contour to about 5.4 miles for the nighttime limit of the 4,000-microvolt contour. An FM station operating on 100 watts with an antenna 70 ft. high can give essentially the same radius of coverage in the daytime, assuming flat terrain, with no reduction of coverage at night.

Fig. 31 shows the additional loss of coverage which occurs when a regional AM station is required to use a directional antenna after sunset. The 5-kw. AM station has a service range of about 35 miles in the daytime, but this range is severely curtailed after nightfall. An FM station of the same power with an antenna 100 ft. high gives the same radius of coverage in flat country by day or by night, and is less subject to the effects of interference from other stations.

Thus the use of FM at very high frequencies offers the solution for the interference problem encountered in AM broadcasting. With only about a thousand transmitters in operation, the present AM broadcast band in the United States is overloaded seriously. On the other hand, it is estimated that several thousand transmitters in continuous operation can be accommodated in the FM band, without requiring the range of any of the transmitters to be reduced during the night hours.

GENERAL FM THEORY

SECTION 4: INTRODUCTION TO FM TRANSMITTER CIRCUITS. THE REACTANCE-TUBE MODULATOR. MECHANICAL METHOD OF FREQUENCY DEVIATION CONTROL.

THE preceding Sections have described the differences that exist between FM systems operating at very high carrier frequencies and AM systems operating at frequencies of a much lower order. It was noted that FM has a number of distinct advantages over AM, the most important being the inherent ability of a well-designed FM system to reduce greatly the effects of interference and noise, provided that the strength of the desired signal at the limiter of the FM receiver is two or more times the strength of the disturbances.

Other important advantages of FM were also explained, such as the improved efficiency obtainable in the FM transmitter, and the greater realism of reproduction found in a properly engineered FM receiver. Moreover, it was shown that at the very high frequencies employed with FM, better and more consistent coverage is obtained within the intended service area than with AM, and that the FM service area is the same after nightfall as during the daylight hours.

It is proposed next to describe the actual methods whereby FM signals can be generated, transmitted, and detected. While the discussion to follow will give primary attention to the basic principles of different methods, additional details of circuit arrangements will be given in later chapters, where the features of commercial transmitters and receivers will be described. The present and following Sections will deal exclusively with methods for generating FM signals.

FM Transmitter Design Considerations ★ In order to obtain the full benefits of the FM system and to minimize the possibility of interference between stations, it is necessary that the FM transmitter output have a wide frequency deviation during modulation and a stable center frequency. Specifically, the output of the FM transmitter must have the following characteristics:

1. The amplitude of the output must remain constant during modulation.
2. The radio frequency of the output must be varied at a rate corresponding to the frequency of the audio modulating voltage.
3. The frequency deviation of the output must be proportional to the *amplitude* of the audio modulating voltage, but independent of the *frequency* of the audio modulating voltage.
4. The accepted compromise value for maximum frequency deviation of the output, occurring at the highest peaks of audio modulating voltage, is five times the

highest modulating frequency. In FM broadcast service, where the highest modulating frequency is 15,000 cycles, the FCC specifies a maximum frequency deviation of 75,000 cycles and, in communications services, where the highest modulating frequency used in speech transmission is 3,000 cycles, the specified maximum frequency deviation is 15,000 cycles. If the maximum frequency deviation is less than five times the highest modulating frequency, the channel assigned by the FCC is not entirely utilized, and full advantage is not taken of the noise and interference reduction made possible by the FM system. On the other hand, if the deviation exceeds five times the highest modulating frequency, there is danger of creating interference with stations on adjacent channels.

5. The frequency deviation must be symmetrical about the assigned carrier frequency and the center frequency stability must meet the following FCC requirements: For FM broadcasting the center frequency of the transmission shall at all times be within 2,000 cycles of the assigned carrier frequency of the station. For mobile communications transmitters, the maximum permissible drift of the center frequency from the assigned value is .01% below 50 mc., and .005% from 50 to 220 mc.

In view of the fact that Frequency Modulation involves a continual variation of the frequency of transmission, the center frequency stability requirements mentioned above are quite exacting. However, an equally high degree of frequency stability is necessary with FM as with AM, in order that interference will not be created in adjacent channels, and that receivers, once they are tuned, will give satisfactory reception continuously, without requiring readjustment to compensate for center-frequency drift at the transmitter.

There are a number of methods whereby frequency-modulated signals can be generated. The methods in common use, however, may be divided into two distinct systems. The first, which involves the use of the reactance modulator, will be described in this Section. The frequency stability of this system in its most simple form is relatively poor, but the stability can be improved greatly by the use of auxiliary frequency-correction circuits. The second system employs the Armstrong phase-shift modulator, and will be described in Chapter 5. The Armstrong system has inherently good stability, since the center frequency is established by a crystal-controlled oscillator.

Reactance Modulation ★ In the reactance modulation method of generating FM signals, the frequency of the oscillator is varied by the direct action of an associated tube and circuit called the reactance-tube modulator. Before considering the manner in which the variation of the oscillator frequency is effected by the modulator, it is advisable to review briefly the factors which govern the natural frequency of an RF oscillator.

Strictly speaking, the operating frequency of an oscillator is not exactly the resonant frequency of its tuned circuit. However, there is only a slight difference between the resonant frequency of the oscillator tank and the actual frequency generated by the master oscillator circuit of a transmitter, where low-loss coils and condensers are used in the tank and where the load of the following buffer stage is relatively light.

It is customary, therefore, to speak of the inductance and capacity of the oscillator tank as comprising the *frequency-determining circuit*, and to regard the oscillator frequency as being the resonant frequency of the oscillator tank.

The resonant frequency of the oscillator tank depends on the product of the tank inductance and the tank capacity. If either the inductance or capacity is increased, the *LC* product is increased, and the period of oscillation is made longer, so that the oscillator operates at a lower frequency. On the other hand, if either *C* or *L* is decreased, the *LC* product is decreased, and the oscillator operates at a higher frequency.

The exact manner in which the resonant frequency is related to the *LC* product will now be examined, with a view toward finding a way in which the frequency of the oscillator can be varied without changing the inductance of the tank coil and without readjusting the capacity of the tank condenser.

At the resonant frequency, the opposition to the flow of alternating current offered by the tank coil, called the *inductive reactance*, is equal to the opposition to the flow of alternating current offered by the tank condenser, called the *capacitive reactance*.

Inductive reactance, the opposition found in coils, has the effect of limiting the current flow and causing the current to *lag behind* the voltage applied to the coil by 90°. Inductive reactance varies directly as the frequency and directly as the inductance of the coil, according to the relation:

$$X_L = 2\pi FL \quad (1)$$

in which X_L represents the inductive reactance in ohms, F the frequency in cycles, and L the inductance in henrys.

Capacitive reactance, the opposition found in condensers, also limits the current for any applied voltage, but causes the current to *lead* the applied voltage by 90° . Capacitive reactance varies inversely as the frequency and inversely as the capacity, as shown by the expression:

$$X_C = \frac{1}{2\pi FC} \quad (2)$$

in which X_C represents the capacitive reactance in ohms and C the capacity in farads.

At the resonant frequency, the inductive and capacitive reactances are equal.

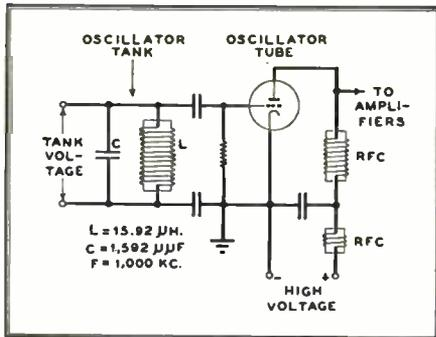

FIG. 32. CIRCUIT OF CONVENTIONAL UNMODULATED OSCILLATOR

That is, at the resonant frequency:

$$2\pi FL = \frac{1}{2\pi FC} \quad (3)$$

or $X_L = X_C$ (4)

The resonant frequency, in terms of L and C , is found by solving equation (3) for F , which gives the familiar relation:

$$F = \frac{1}{2\pi\sqrt{LC}} \quad (5)$$

Thus, for any given values of circuit inductance L and capacity C , there is but one resonant frequency, regardless of whether large L is used with small C or small L with correspondingly large C .

Consider now the oscillator circuit of Fig. 32. The inductance of the tank coil in this particular case is 15.92 microhenrys (.00001592 henry) and the tank capacity is 1,592 micromicrofarads (.00000001592 farad). By the use of equations (1), (2), and (5), it is found that the resonant frequency of the tank is 1,000 kc., and that the values of capacitive and inductive reactance offered by the tank coil and condenser are 100 ohms each, as noted in Fig. 33.

Therefore, if voltage at a frequency of 1,000 kc. is present across the tank, the current in the inductive branch will be equal to the current in the capacitive branch of the tank. However, the current in the capacitive branch will lead the voltage by 90° while that in the inductive branch will lag by 90° , as shown by the small vector diagrams in Fig. 33.

Now suppose that a variable capacitive reactance of 1,000 ohms at 1,000 kc. is connected in parallel with the tank condenser, as shown in Fig. 34 at the left. The *net* capacitive reactance offered by two capacitive reactances in parallel can be determined by

$$\text{net capacitive reactance} = \frac{X_C \times X_{C_1}}{X_C + X_{C_1}} \quad (6)$$

This is similar to the procedure employed to find the net resistance offered by two resistors in parallel. It is found in this case that the equivalent capacitive reactance of 1,000 ohms in parallel with 100 ohms is 90.9 ohms.

Thus at 1,000 kc., the net capacitive reactance of the variable capacitive reactance in parallel with the tank condenser (90.9 ohms) is less than the inductive reactance of the coil (100 ohms). Also, the 90° leading current in the capacitive branch will be greater than the 90° lagging current in the inductive branch by the amount of current flowing in the extra path provided by the variable capacitive reactance. In short, when the variable capacitive reactance is connected across the oscillator tank condenser, the resonant frequency is no longer 1,000 kc., and the oscillator adjusts itself to a new frequency.

The frequency to which the oscillator adjusts itself in this case is 953 kc. At this frequency, the inductive reactance of the tank coil, which varies directly as the frequency, is decreased from 100 ohms at 1,000 kc., to $953/1000 \times 100$ or 95.3 ohms at 953 kc. The combined capacitive reactances, which offer a net capacitive reactance of 90.9 ohms at 1,000 kc., vary inversely as the frequency and therefore assume a value of $90.9 \times 1000/953$, or 95.3 ohms at 953 kc.

Thus the oscillator, by adjusting itself to a lower frequency, brings the capacitive and inductive reactances into equilibrium, as shown in the right-hand diagram of Fig. 34. The total 90° leading current will equal the 90° lagging current and operation at the resonant frequency is maintained.

If the value of the variable capacitive reactance in parallel with the tank condenser is changed to less than 1,000 ohms at 1,000 kc., the oscillator will adjust itself to a frequency lower than 953 kc. to restore operation at the resonant frequency. On the other hand, if the value of the variable capacitive reactance is greater than 1,000 ohms at 1,000 kc., the oscillator will shift to a frequency higher than 953 kc.

Now, if the capacitive reactance shunted across the tank condenser is varied at an audio rate, the oscillator frequency will also vary at the same rate in order to maintain continuous operation at resonant frequency. In this manner frequency modulation of the oscillator output can be obtained.

The shunted capacitive reactance varying at an audio rate can be in the form of a condenser microphone upon whose dia-

phragm sound waves are impinging. Such an arrangement was mentioned in Section 1, but it is hardly practical for most applications because the microphone must be part of the oscillator circuit.

The effect of varying capacity can be produced artificially, without actually varying a condenser, by introducing a variable capacitive reactance across the oscillator tank condenser, as shown in the preceding paragraphs. Such a variable capacitive reactance can be furnished by the reactance-tube circuit, which is shown connected to the oscillator in Fig. 35.

The tube used in the reactance-modulator stage is of the variable- μ type, whose gain can be varied by changing the grid bias. The tank voltage of the oscillator is applied to the series network RC and also to the cathode and plate of the reactance tube. The capacitive reactance of C at the oscillator frequency is very much greater than the resistance of R . Hence the current through RC leads the tank voltage by 90° . The voltage across R , in phase with the current through it, also leads the tank voltage by practically 90° . Thus the grid of the reactance tube receives an excitation voltage from R that leads the tank voltage applied to the plate and cathode of the tube by practically 90° .

If the reactance tube were biased so negatively that no plate current whatever could flow in the tube, the frequency of

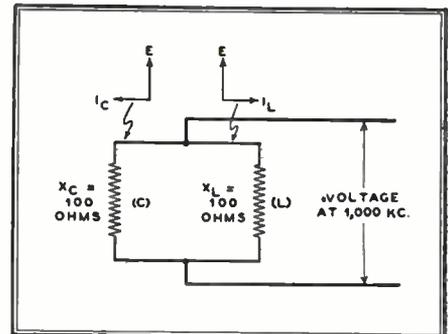

FIG. 33. REACTANCE RELATIONS OF CIRCUIT SHOWN IN FIG. 32

the oscillator would be unaffected by the presence of the reactance-tube circuit. (The impedance of the voltage-dividing phase-shift network RC is too high to affect the oscillator frequency appreciably.) Thus, the oscillator frequency would be determined by the tank coil inductance and the tank condenser capacity.

If the negative bias should be reduced sufficiently to permit a small plate current to flow in the reactance tube, and if there were no RF voltage on the grid of the tube, the effect would be that of shunting the plate resistance of the tube across the oscillator tank. Since the plate current of the pentode is relatively insensitive to small changes in plate voltage, the RF resistance shunted across the oscillator by the tube would be of relatively high order. The frequency of the oscillator would not be affected appreciably.

Actually, however, the resistor R of the RC network furnishes an excitation to the grid of the reactance tube at the frequency of the oscillator, but leading the oscillator tank voltage by 90°. Since the plate current is much more sensitive to a change in grid voltage than in plate voltage, the tube permits the flow of a 90° leading current through it with much greater ease than an in-phase current. Thus, with respect to the oscillator tank voltage, the reactance tube of Fig. 35 provides a capacitive reactance

current in C would lead the voltage across C by 90°. In other words, the voltage across C will lag the oscillator tank voltage by 90°, thus giving a 90° lagging current in the tube. The tube will therefore look like an inductive reactance to the oscillator tank voltage.

Whatever the type of reactance furnished by the reactance-tube circuit, the carrier frequency of the oscillator, in the absence of modulation, depends upon the constants of the oscillator tank, and the

to the oscillator, the oscillator frequency also becomes dependent upon the gain of the reactance tube, since it determines the magnitude of the RF component of plate current that is allowed to flow in the tube at a 90° angle of lead. The gain of the tube in turn depends upon its mutual conductance, upon the characteristics of the associated circuits, and especially upon the voltages applied to the tube elements. Thus the center frequency of the generated wave is affected by such factors as

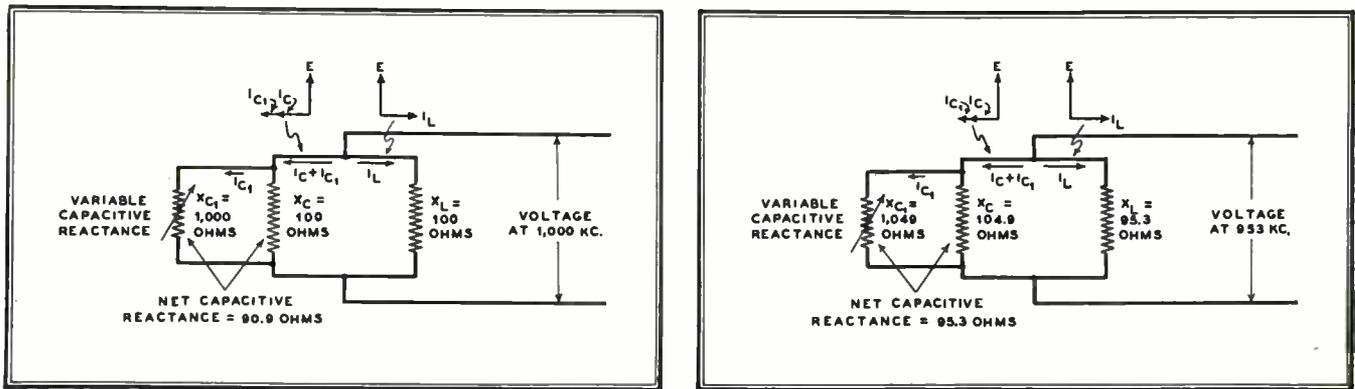

FIG. 34. EFFECT OF PUTTING VARIABLE CAPACITIVE REACTANCE ACROSS OSCILLATOR TANK CONDENSER. LEFT: NON-RESONANT CONDITION AT ORIGINAL FREQUENCY. RIGHT: CONDITION AFTER OSCILLATOR HAS SHIFTED FREQUENCY

across the oscillator tank condenser, the effect of which is to cause the oscillator to adjust itself to a lower frequency in order to maintain resonant operation.

Moreover, the magnitude of the 90° leading current allowed to flow in the reactance tube depends on the mutual conductance of the tube, that is, on the sensitivity of the plate current to a change in grid voltage. When the negative bias is reduced, the mutual conductance of the tube is increased, and a larger 90° leading current flows in the tube, so that the effective reactance of the tube is reduced. This causes the oscillator to adjust itself to a still lower frequency. Conversely, when the bias is made more negative, the 90° leading current is reduced and the effective reactance is increased.

It is feasible, therefore, to vary the reactance of the tube at an audio rate simply by introducing an audio voltage in the grid bias of the reactance tube from the output of an audio amplifier, as shown in Fig. 35. The varying reactance, in turn, causes the oscillator frequency to shift at an audio rate, giving frequency modulation of the oscillator output equivalent to actually varying the capacity of an auxiliary condenser across the tank condenser.

By a simple circuit rearrangement, the reactance tube circuit can be made to furnish a variable inductive reactance across the tank circuit for reactance-modulating the oscillator frequency. For example, suppose that the positions of R and C in the RC network are interchanged, and that the resistance of R is made very much greater than the capacitive reactance of C at the oscillator frequency. The current in RC would then be nearly in phase with the tank voltage of the oscillator. The

amount of reactance shunted across the tank by the reactance tube. The amount of reactance offered by the tube, in the absence of modulation, depends in turn upon the DC grid bias. Thus the center frequency of the FM signal generated by the oscillator can be adjusted to the assigned carrier frequency simply by an adjustment of the DC bias on the grid of the reactance tube.

the constants of the reactance tube and the voltage regulation of the power supply. In particular, a very slight variation in the grid bias of the reactance tube causes a considerable shift of the oscillator frequency.

In general, therefore, the primary difficulty that arises in the use of a reactance-tube modulator for the generation of FM signals is that the center frequency of the

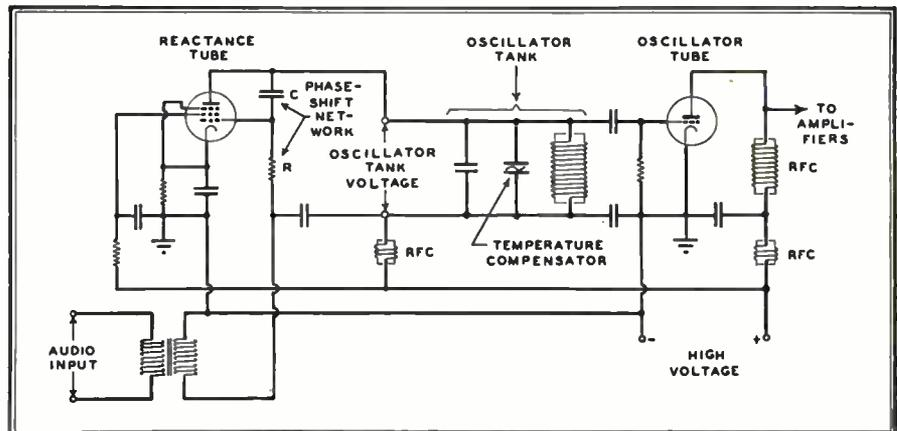

FIG. 35. THE VARIABLE CAPACITIVE REACTANCE SHOWN IN FIG. 34 IS HERE REPLACED BY A REACTANCE TUBE TO VARY THE OSCILLATOR FREQUENCY

The center frequency stability of the simple reactance modulator circuit of Fig. 35 is relatively poor. In the first place, the center frequency cannot be crystal-controlled. The natural frequency of the oscillator, even in the absence of the reactance tube, is affected by variations of the voltages on the oscillator tube elements, by the effects of temperature changes upon the inductance and capacity of the tank, and by the resistance reflected from the coupled load.

When the reactance tube is connected

generated wave depends upon the voltages on the reactance tube as well as upon the constants of the oscillator. The frequency stability can be improved by the use of a voltage-regulated power supply for the reactance modulator. However, even with this precaution, the drift at the very high frequencies is too great to meet the stability requirements of the FCC.

It is necessary, therefore, to employ auxiliary circuits to maintain the center frequency at the assigned value. The principle commonly employed is to compare

the center frequency of the transmitter output to that of a crystal oscillator. When the center frequency departs from its correct value, the stabilization circuits operate upon the reactance tube or the oscillator to bring the center frequency back to its correct value.

The Crosby System ★ The circuit diagram of a transmitter employing the frequency stabilization circuit developed by Murray G. Crosby is shown in Fig. 36. The oscillator in this particular case operates at one-ninth of the assigned transmitting frequency. In the circuit of Fig. 36 the 4.7-mc. oscillator frequency is passed through two tripler stages to produce a

to 1,800 kc.¹ The discriminator, in the absence of modulation, produces a DC voltage whose *magnitude* is proportional to the amount by which the frequency applied to the discriminator differs its resonant frequency. For example, if the discriminator produces 20 volts when the applied frequency is 1,820 kc., it will produce 50 volts when the applied frequency is 1,850 kc.

The polarity of the voltage at the discriminator output depends on whether the applied frequency is greater or less than the frequency of the discriminator circuit. Thus, when the applied frequency is 1,750 instead of 1,850 kc., the same voltage is produced but in opposite polarity.

change in frequency, whether in the form of a slow drift or a rapid variation, an audio voltage appears across the discriminator output during modulation in addition to the DC voltage. However, the *average* value of the voltage across the discriminator output will be proportional to the drift of the center frequency of the output, and the polarity of the average voltage will depend on the direction of frequency drift.

An example will serve to make this action clear. Suppose that the transmitter, having an assigned frequency of 42,300 kc., is actually operating at a center frequency of 42,350 kc., and that the frequency deviation during modulation is 75

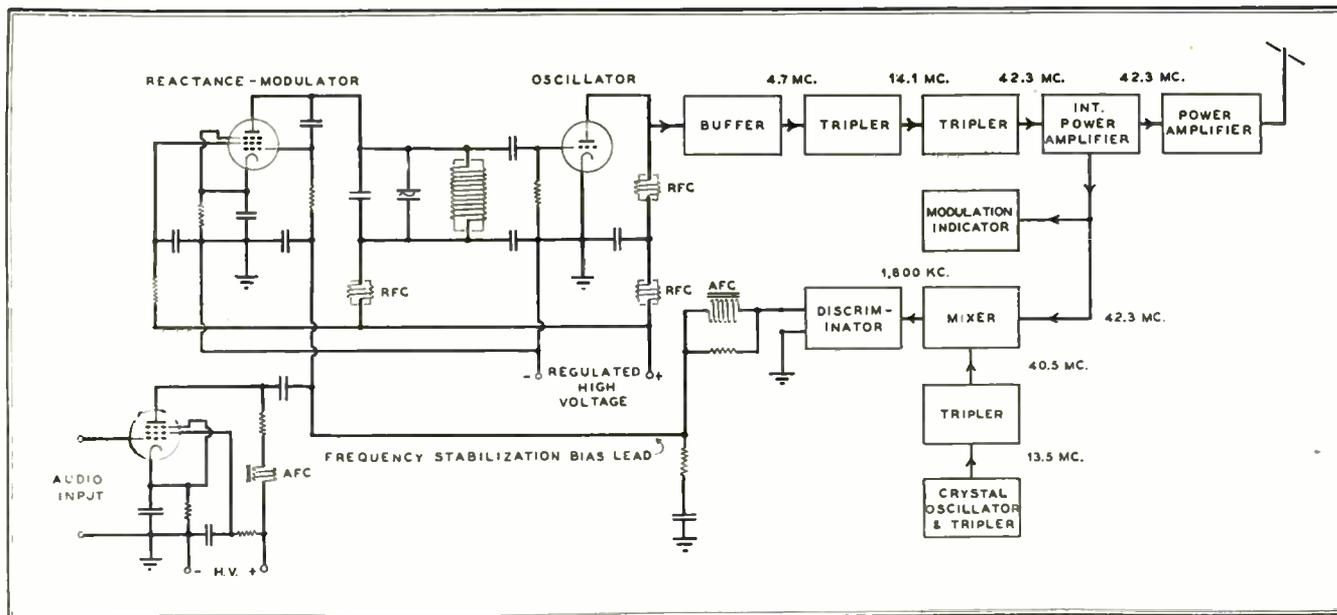

FIG. 36. FM BROADCAST TRANSMITTER EMPLOYING BIAS-CONTROL METHOD OF MINIMIZING FREQUENCY DRIFT

frequency of 42.3 mc. The oscillator is frequency-modulated by the reactance tube, a frequency deviation of 75/9 or 8.33 kc. being required at the oscillator for full modulation of the transmitter.

In the frequency stabilization circuits, a crystal oscillator operates at a frequency that differs from the correct center frequency of the reactance-modulated oscillator by a known amount. For example, the frequency of the crystal oscillator may be 4.5 mc. which, after being tripled twice, gives a reference frequency of 4.5×9 or 40.5 mc.

The reference frequency of 40.5 mc. is applied to a mixer tube along with a voltage at the transmitter output frequency, taken from the intermediate power amplifier stage. If the center frequency of the transmitter output is correct, a beat frequency of 42,300—40,500 or 1,800 kc. will appear at the output of the converter. If the center frequency of the transmitter output is greater or less than 42,300 kc., the beat frequency will be greater or less than 1,800 kc. by the same amount.

The converter output is applied to a discriminator having a temperature-compensated circuit very accurately tuned

The voltage output of the discriminator is used for frequency correction and is applied to the grid of the reactance-modulator tube in addition to the bias contributed by the cathode resistor of the modulator tube. If the transmitter output frequency is exactly correct, the DC output voltage of the discriminator is zero, and the bias on the reactance tube is that developed by the cathode resistor alone. When the transmitter output frequency differs from the correct value, the discriminator produces a DC voltage of such polarity that the bias of the reactance tube is varied in a direction to shift the output frequency toward its correct value. When the frequency is very nearly correct, and only a very small correction voltage remains at the discriminator output, the frequency correction action ceases.

In the above explanation of the frequency stabilizing action, it has been assumed that no modulation is present. Actually, of course, a frequency-modulating audio voltage is being applied to the grid of the reactance tube during most of the time that the transmitter is on the air. Since the discriminator is responsive to

kc. The transmitter output frequency is varying between 42,425 kc., and 42,275 kc. The voltage applied by the mixer in the frequency correction circuit to the discriminator will vary in frequency between 42,425—40,500 or 1,925 kc., and 42,275—40,500 or 1,775 kc. This is 125 kc. above and 25 kc. below the 1,800 kc. reference frequency to which the discriminator is tuned. The voltage across the discriminator output will vary, therefore, between +125 and -25 volts, the average of which is +50 volts, the same voltage that would be obtained for an unmodulated transmitter output frequency of 42,350 kc. Thus the center frequency of the output during modulation can be corrected as easily in the absence of modulation, by employing the DC component of the discriminator output voltage.

Actually, the audio voltage of the discriminator is sometimes only partially filtered at the lower audio frequencies, in order to obtain some degenerative feedback at these frequencies. This gives the transmitter a pre-emphasis characteristic that improves the signal-to-noise ratio at the higher audio frequencies.

The stability of the carrier frequency in the circuit of Fig. 36 depends on: 1) the

¹ The operating principle of the discriminator will be explained in a later chapter.

stability of the reference crystal oscillator; 2) the gain of the mixer tube, and 3) the stability of the tuned circuits of the discriminator. Also, the frequency stabilization circuit does not remove all the drift of the output frequency, although the drift can be reduced by as much as 100 to 1 as compared to the drift of an unstabilized reactance-modulated transmitter.

Western Electric System ★ A different frequency stabilization system, developed by J. F. Morrison of Bell Laboratories, is employed in Western Electric transmitters. In this system, drift of the center frequency is automatically corrected by means of a small, reversible motor that readjusts the settings of variable condensers in the oscillator tank circuit. This motor, and the compensating condensers which it adjusts, are shown in Fig. 37.

A simplified diagram of the oscillator and reactance-tube modulator appears in Fig. 38. The oscillator is of the push-pull type, employing two tubes. Energy is fed back to the grids from the plate circuits through small coupling condensers C_C in such polarity as to sustain oscillation. The reactance-modulator also employs two tubes, the plates being connected in push-pull to opposite ends of the oscillator tank. The grids of the tubes in the modulator are connected in parallel, and are excited by a voltage taken from the oscillator tank through a 90° phase-shifting network.

Since the plates of the reactance tubes are connected to opposite ends of the oscillator tank, the direction in which the oscillator frequency will be shifted by the modulator depends on which of the tubes in the modulator passes the greater reactive current. By applying the audio voltage to the control grids of the reactance tubes in push-pull, during the first alternation of the audio voltage, the bias on one tube is reduced while the bias on the other tube is increased. Thus one tube is made to pass a greater reactive current than the other, so that the oscillator frequency is shifted. During the next alternation of the audio voltage, the grid biases are unbalanced in the opposite direction. The tube which passed the greater reactive current in the first alternation now passes the lesser current, and the oscillator frequency is shifted in the opposite direction.

As the audio voltage alternately favors the flow of reactive current first in one tube and then in the other, the oscillator frequency is increased and decreased at the same audio rate. Thus frequency modulation of the oscillator output voltage is obtained.

The balanced reactance-tube modulator circuit employed here has the advantage over single-tube modulators of balancing out the effects of ripples and fluctuations in the grid bias and plate voltages which are applied in parallel to the reactance-tubes.

The oscillator tank capacity consists of

fixed condensers C_F and variable condensers C_V . The variable condensers are ganged and mechanically linked to a synchronous motor, controlled by the frequency stabilization circuit. When the center frequency of the transmitter drifts away from the assigned carrier frequency, the motor rotates in the proper direction and to the extent necessary to readjust the tank capacity of the oscillator to the correct center frequency.

Fig. 39 shows, in block diagram form, the arrangement of this system of frequency stabilization. The frequency of the reactance-modulated oscillator in this case is $\frac{1}{8}$ of the transmitter output frequency. For example, if the assigned carrier frequency is 42.3 mc., the oscillator operates at 5.2875 mc. The oscillator output is passed through a buffer and three doubler stages to give the assigned carrier frequency. It is then amplified to give the required power output.

A portion of the output voltage of the reactance-modulated oscillator is applied to the input of a chain of ten frequency dividers, each of which gives an output having one-half the frequency of its input. Thus the center frequency at the output of the last frequency divider is $1/1,024$ of the frequency of the modulated oscillator. Hence, if the reactance-modulated oscillator is furnishing the correct frequency of 5.2875 mc., the frequency at the output of

the frequency-divider chain is $5,287,500/1,024$ or 5,163.5 cycles. This is the frequency at which the reference crystal oscillator is designed to operate.

The output of the reference crystal oscillator and the output of the frequency-divider chain are combined in the motor-control circuit. This circuit determines the magnitudes of the currents that flow in the four windings of the synchronous motor that adjusts the oscillator tuning condensers.

If the output frequency of the transmitter has the correct value of 42.3 mc., the frequencies applied from the reference oscillator and the frequency-divider chain are the same. The resultant magnetic field set up between the poles of the motor by the currents in the windings is stationary, so that the armature of the synchronous motor does not rotate.

Suppose, however, that the output frequency of the transmitter drifts to 42.4 mc., so that the frequency at the output of the frequency-divider chain becomes 5.175.7 cycles. When this frequency is applied to the motor control circuits along with the reference frequency of 5,163.5 cycles from the crystal oscillator, the magnetic field set up between the motor poles is made to rotate at the difference frequency of 12.2 electrical cycles per second. Accordingly, the armature of the motor rotates and increases the capacity of the

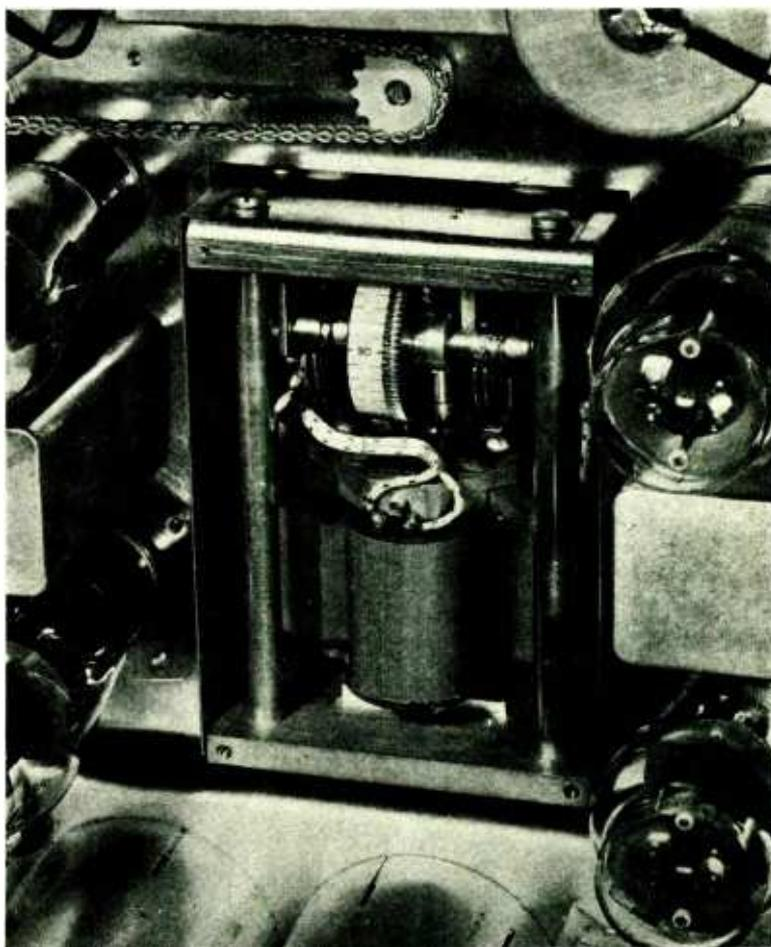

FIG. 37. CLOSE-UP OF WESTERN ELECTRIC FREQUENCY COMPENSATING CONTROL

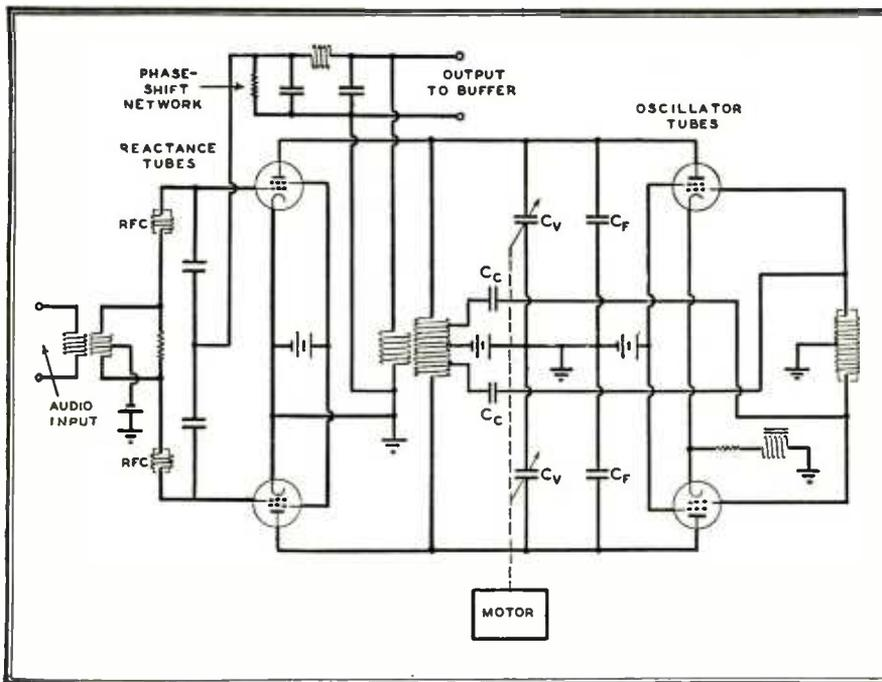

FIG. 38. REACTANCE-MODULATED OSCILLATOR OF WESTERN ELECTRIC FM TRANSMITTER, USING MOTOR-DRIVEN FREQUENCY-CORRECTION CONDENSERS

variable condensers, C_v , Fig. 38, thereby lowering the oscillator frequency toward the correct value. As the amount of the frequency drift is reduced, the difference frequency at the motor-control circuit is reduced, and the magnetic field rotates more slowly. The armature likewise revolves at a slower rate, in keeping with the field, and comes to rest when the field is stationary, that is, when the transmitter drift has been corrected, and the frequency at the output of the frequency-dividing chain is exactly equal to that furnished by the reference oscillator.

If the transmitter output frequency should drift to a value *lower* than the assigned carrier frequency, then the rotation of the magnetic field is in the opposite direction.

In this way, if the transmitter output frequency drifts, no matter how slowly, the magnetic field of the motor starts to revolve and the armature of the motor turns with the field, applying a correcting adjustment to the oscillator tank.

The question naturally arises as to whether or not the frequency variations occurring during modulation will disturb the operation of the motor. Also, as explained in Chapter 1, in frequency modulation the center frequency component varies in amplitude and even disappears at certain percentages of modulation. What will be the effects of such variations in the center frequency component of the modulated oscillator output upon the operation of the motor-drive circuits?

Neither of these factors affects the operation of the motor. Each of the frequency-dividing stages halves the frequency deviation as well as the frequency of the voltage applied at the input. In the present case, when the transmitter output frequency is being fully modulated, the

frequency deviation is ± 75 kc. The frequency deviation of the reactance-modulated oscillator is $\frac{1}{8}$ of the output deviation, or ± 9.375 kc. The frequency deviation at the output of the frequency-dividing chain is $9,375/1,024$ or ± 9.14 cycles. At the lowest audio frequency, say 30 cycles, the modulation index is $9.14/30$ or about 0.3. Reference to the table of Bessel factors (Section 1) shows that, with this modulation index, the frequency-modulated voltage is composed of a center frequency component having 97.7% of the amplitude of the unmodulated carrier and only one important pair of sidebands, having an amplitude of less than 15% of the unmodulated carrier.

At modulating frequencies greater than 30 cycles, that is, over the entire audio range, the modulation index is still smaller, and the center frequency component is greater than 97.7%, while each of the two sideband components has an amplitude of less than 15%. Thus the

process of frequency division concentrates the energy of the frequency-modulated wave into the center frequency component. At the output of the frequency-dividing chain, the amplitude of the center frequency component during modulation is never less than 97.7% of the amplitude of the carrier in the absence of modulation. Large variations in the amplitude of the center frequency component at the transmitter output during modulation, therefore, do not affect the operation of the motor-control circuits.

The FM voltage from the frequency-dividing chain, which has been described as having a frequency deviation of 9.14 cycles at full modulation, will cause a slight oscillation of the motor field at the modulating frequency. The angle in radians of alternate advancement and retardation of the field in the motor at the modulating frequency of 30 cycles per second would be equal to the modulation index, that is, to .3 radian or about 17° . In other words, the rotating or stationary field of the motor has a superimposed oscillation over a range of $\pm 17^\circ$ when the transmitter is fully modulated at 30 cycles. That represents the most extreme condition of oscillation. When the modulating frequency is higher than 30 cycles and the transmitter is being modulated at less than 100%, the oscillation range is less than $\pm 17^\circ$.

For all the modulating frequencies from 30 to 15,000 cycles, the inertia of the armature element and the friction in the motor is sufficient to prevent any response to the slight, rapid oscillations of the motor field at the modulating frequency. The motor is only responsive to slow rotation of the mean position of the motor field, which occurs when the transmitter output frequency starts to drift from the correct value.

Since positive synchronism is maintained between the subharmonic of the transmitter output frequency and the reference crystal oscillator, the carrier frequency stability is that of the crystal oscillator. The stability is not affected by fluctuations of power supply voltages, nor

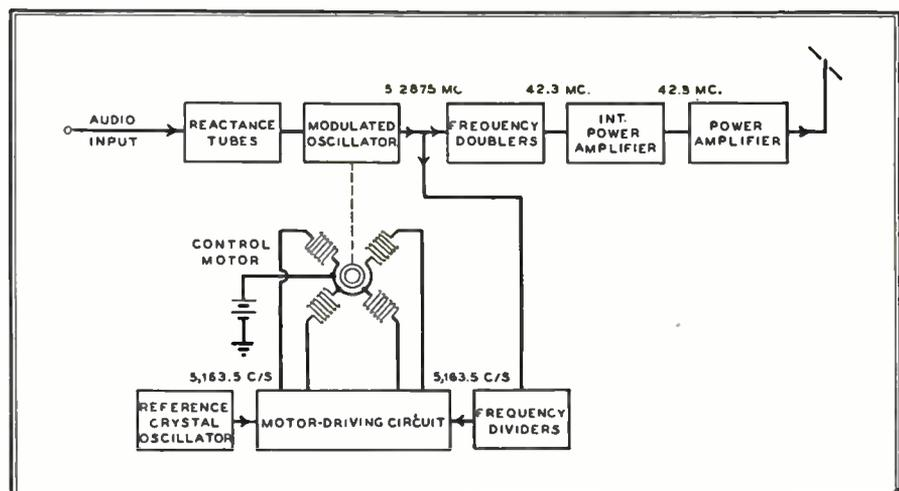

FIG. 39. BLOCK DIAGRAM OF W.E. SYNCHRONIZING MOTOR CONTROL CIRCUIT

does it depend on the maintenance of the constants of a tuned circuit, nor upon the stability of gain in any tube.

The frequency correction is applied in the oscillator by electro-mechanical means so that the design of the reactance-tube

modulator does not involve considerations of frequency stabilization, and failures in the frequency stabilization circuit cannot affect the process of modulation. If the frequency stabilization circuits fail, the motor ceases to revolve and the transmit-

ter frequency will drift slowly. There will not be a sudden change in the transmitter output frequency as would be the case where frequency stabilization is obtained by means of bias applied to the reactance-tube modulator.

GENERAL FM THEORY

SECTION 5: FM TRANSMITTER CIRCUITS CONTINUED. PHASE MODULATION IN THE ARMSTRONG PHASE-SHIFT CIRCUIT, LATER IMPROVEMENTS. PRE-EMPHASIS.

IN THE preceding section, the generation of FM signals by the use of reactance-tube modulators was discussed. It was noted that the reactance-modulated oscillator cannot be crystal-controlled because, during modulation, the reactance variation must cause the oscillator frequency to swing over a considerable range. Lacking crystal control or other means for frequency stabilization, the average or center frequency generated by the oscillator is subject to drift which may extend beyond the frequency stability limits established by the FCC.

The drift can be minimized by the use of frequency stabilization circuits in which the center frequency of the transmitter output, or a subharmonic thereof, is compared to the frequency of a reference crystal oscillator. When the center frequency drifts away from the assigned value, the stabilization circuits exert corrective measures upon the reactance-tube modulator, or upon the modulated oscillator, to bring the center frequency back to the correct value.

However effective, such circuit arrangements represent an indirect solution to the problem of maintaining the frequency stability, because the center frequency component is compared with the reference following its generation.

The direct solution lies in having the center frequency component of the signal under crystal control during its generation. With the stability of the center frequency established at the source, auxiliary frequency stabilization circuits, together with their potential troubles, are eliminated from the transmitter.

The Armstrong phase-shift modulator circuit provides a direct solution to the problem of maintaining the frequency stability of an FM transmitter. The center frequency component of the FM wave is generated by an oscillator that is crystal-controlled and therefore of very high frequency stability. Thereafter, the sideband components, which are generated in a modulator that is excited by the same oscillator, are combined in such phase with the center frequency component as to produce a voltage having a slight degree of frequency modulation. The frequency-modulated voltage is then passed through a multiplication system which increases the center frequency and the slight frequency deviation by such factors as will give the desired transmitter output frequency and frequency deviation. Finally, the voltage is used to excite a series of power amplifier stages to raise the

power to the required level for the transmitter output.

To present a clear picture of the operation of the Armstrong phase-shift modulation system, the creation of the frequency-modulated wave will be described graphically and with reference to the original simple form of the Armstrong modulator. Thereafter, the features of the new and improved Armstrong modulator circuit will be explained.

Slightly Modulated AM and FM Waves ★ Before considering the method by which FM waves are produced by the Armstrong modulator, it is well to review the points of similarity and difference of slightly modulated AM and FM waves.

In Section 1, AM and FM waves were analyzed and shown to be comprised of components at the carrier frequency and at sideband frequencies. The amplitudes of these components were found to depend upon the amplitude of the modulated

wave and upon the degree of modulation.

It was noted that with modulation at a single modulating frequency, the AM wave has only one pair of sideband components, regardless of the degree of modulation, up to 100%. The FM wave, on the other hand, can have a large number of sideband components, depending upon the modulation index. However, when the modulation index is less than 0.2, that is, with very slight frequency modulation, only one pair of sidebands has sufficient amplitude to be significant, and the amplitudes of these sidebands are proportional to the modulation index.

It was further pointed out, in Section 1, that the center frequency and sideband components of a slightly modulated FM wave can be the same in amplitude and in frequency as the components of a partially modulated AM wave. It was stated, however, that this does not mean that the two waves are identical. In the case of the FM wave, the sideband components are differ-

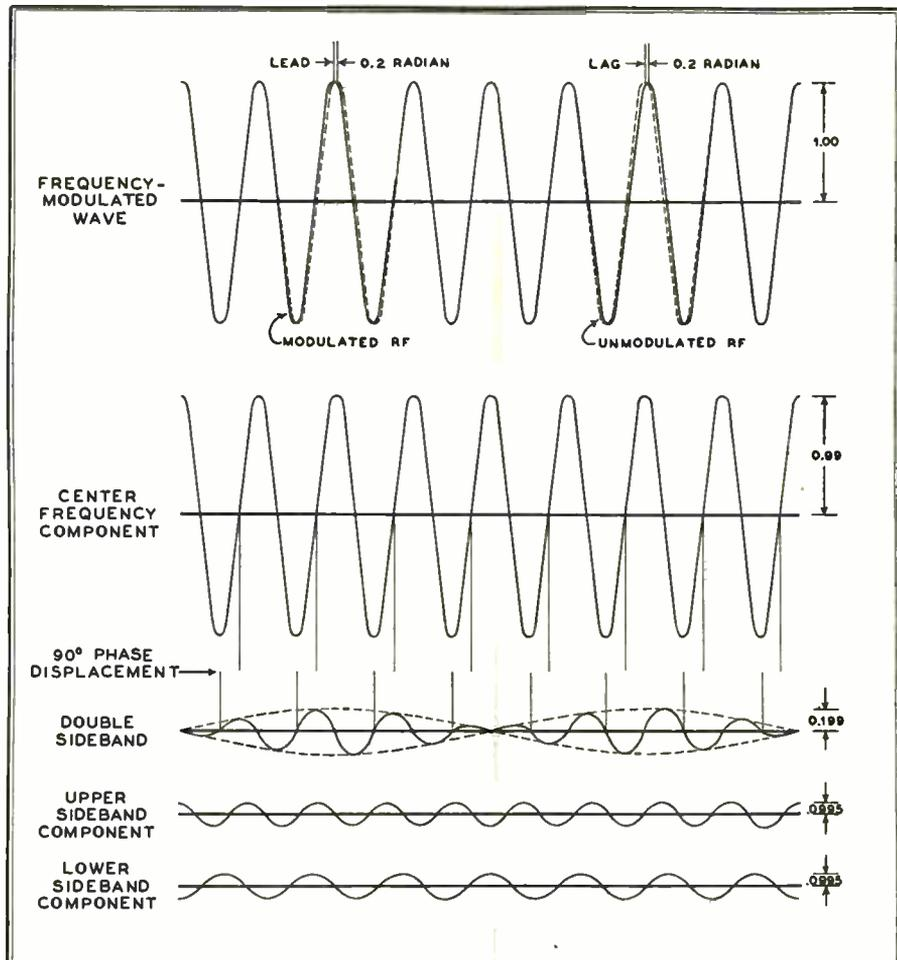

FIG. 40. COMPONENTS OF FM WAVE HAVING AMPLITUDE OF 1.00 AND MODULATION INDEX OF 0.2. NOTE 90° PHASE DISPLACEMENT OF DOUBLE SIDEBAND

ently phased with respect to the carrier, so that when they are added to the carrier, a wave of constant amplitude and varying frequency is produced, rather than a wave of varying amplitude and constant frequency.

Figs. 40 and 41 offer specific examples of the condition mentioned above. At the top of Fig. 40 is shown the wave form of an FM current having an amplitude of 1 ampere and a modulation index of 0.2. At the top of Fig. 41 is shown the form of an AM current having an average am-

plitude of 1 ampere and a modulation index of 0.2. sidebands are shown beneath the carrier frequency components in Figs. 40 and 41.

In spite of the fact that the amplitudes and the frequencies of the components of the wave in Fig. 40 are the same as the respective components of the wave in Fig. 41, it is found that the sum of these components produces a frequency-modulated wave in Fig. 40 and an amplitude-modulated wave in Fig. 41. Why?

The answer lies in the phase relationship of the sidebands with respect to the carrier. It will be observed that in the case

41. The double sideband current of Fig. 41 is created in a special type of AM modulator, excited at the carrier frequency but employing a circuit which suppresses the carrier frequency component in the modulator output. The double sideband is then displaced along the time axis, to the extent of one-quarter cycle, by a 90° phase-shift device. The phase relationship between the carrier frequency and the double sideband then becomes that shown in Fig. 40. If the double sideband component and carrier component are now combined in the proportions of amplitude shown in Fig. 40, the frequency-modulated wave at the top of Fig. 40 is produced.

Excellent frequency stability of the carrier component is assured by the use of a crystal-controlled oscillator for generating the original carrier frequency component.

Of course, only a slight degree of frequency modulation is obtainable, because only one pair of sidebands is added to the carrier. However, if the carrier frequency is made low, so that a sufficient number of frequency multiplying stages are employed in raising the frequency to the assigned transmitting frequency, the frequency deviation is increased by the same factor as the frequency is increased in each multiplier stage. Thus a large frequency deviation can be obtained from a frequency-modulated wave whose initial frequency deviation is quite small.

Original Armstrong Phase-Shift Modulator ★ A block diagram of original arrangement of the Armstrong modulator is shown in Fig. 42. The elements involved in the creation of waves having a slight frequency modulation at a given modulating frequency are enclosed within the dotted line. The circuit diagram for these elements is shown in Fig. 43.

It will be seen that the output of a crystal-controlled oscillator at a frequency in the order of 200 kc. is applied simultaneously to the carrier frequency amplifier stage and to both grids of the balanced modulator.

The balanced modulator serves to produce the double sideband illustrated in Fig. 41. The grids of the modulator tubes in Fig. 43 are connected in parallel to the oscillator, but the plates are connected in pushpull to the load circuit $C_1L_1L_2C_2$. The condensers C_1 and C_2 serve to neutralize the reactances of L_1 and L_2 , giving a purely resistive path for the RF components of the modulator plate current. This brings the RF components of the plate currents into phase with the common grid voltage, and hence into phase with each other.

Since the RF components of the plate currents flow toward the common junction of L_1 and L_2 from opposite ends of $C_1L_1L_2C_2$, it follows that when the tubes are well matched and operating with equal voltages on the tube electrodes, the RF voltage induced in coil L , equally coupled

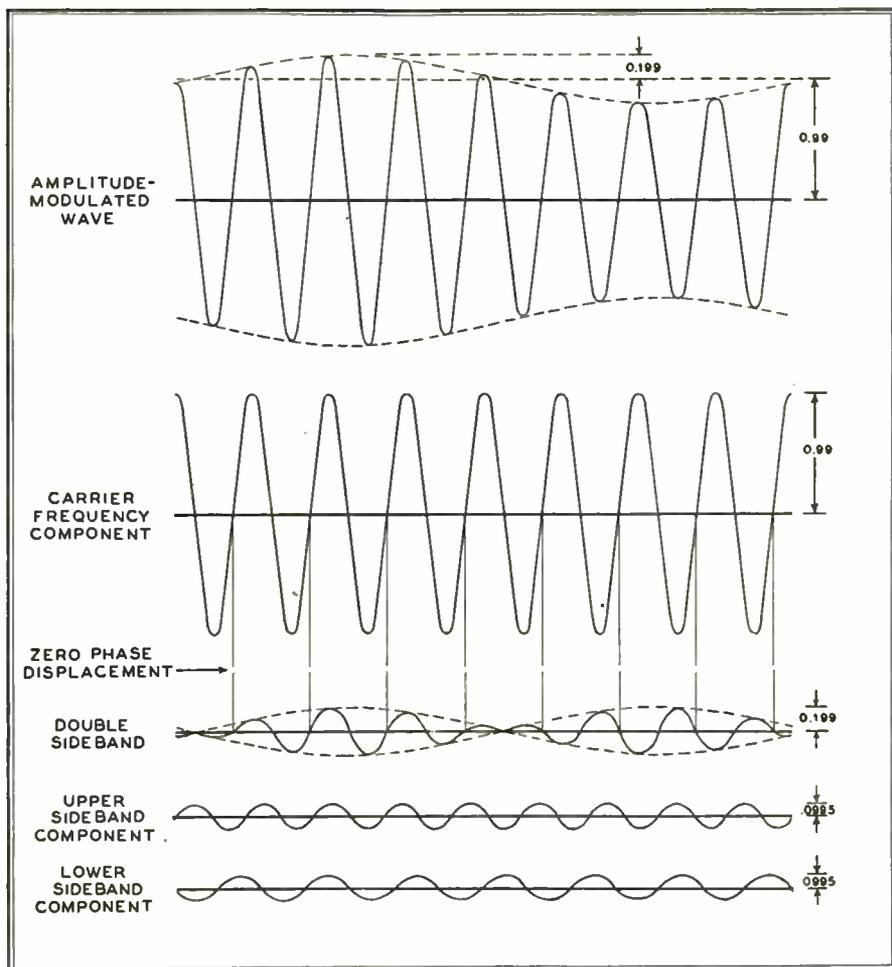

FIG. 41. AM WAVE HAVING SAME COMPONENTS AS FM WAVE IN FIG. 40. NOTE, HOWEVER, THE ZERO PHASE DISPLACEMENT OF DOUBLE SIDEBAND

plitude of 0.99 ampere and a modulation percentage of 20.1.

When these waves are analyzed by the methods given in Section 1, it is found that both waves have 1) a carrier frequency component with an amplitude of 0.99 ampere, 2) a lower sideband component, at carrier frequency minus modulating frequency, with an amplitude of .0995 ampere, and 3) an upper sideband component, at carrier frequency plus modulating frequency, also having an amplitude of .0995 ampere.

In Figs. 40 and 41 the carrier frequency components are shown immediately below the modulated waves. When the carrier frequency component is subtracted from the modulated wave, the remainder is the sum of the two sideband components, called the double sideband. The double

of the amplitude-modulated wave, Fig. 41, the intercepts of the double sideband wave with the time axis occur simultaneously with the intercepts of the carrier frequency component. On the other hand, in the case of Fig. 40, the intercepts of the double sideband occur at instants differing by one-quarter cycle from the instants of the intercepts of the carrier frequency component. In the case of Fig. 41 the summation of the components gives an amplitude-modulated wave. In Fig. 40 the summation of the same components, but with the sidebands shifted 90° along the time axis, gives a frequency-modulated wave.

Principle of Armstrong Modulator ★ The scheme of operation of the Armstrong modulator can be understood by reference to Figs. 40,

to L_1 and L_2 , will be zero, because the effects of the field created about L_2 are cancelled by the effects of the field created about L_1 .

However, if the tubes are not well matched, or if the voltages applied to the tubes are not equal, then the RF component of the plate current of one tube will be greater than that of the other tube. The net RF field set up around L_1L_2 , which sweeps coil L, will then have a polarity dependent upon which tube has the larger RF component of plate current. The strength of the net RF field will vary as the degree of unbalance between the two tubes.

In the modulator of Fig. 43, the tubes are deliberately unbalanced during modulation by applying the audio modulating voltage by applying the audio modulating voltage at the primary of transformer T₁.

the wave form of the double sideband illustrated in Fig. 41. Moreover, the field has the same phase relation with respect to the carrier voltage on the modulator grids as that shown for the double sideband with respect to the carrier frequency component in Fig. 41.

The voltage induced in coil L, however, has a phase displacement of 90° with respect to the inducing field. This is inherent in the process of induction. For example, the maximum induced voltage occurs at the instants when the inducing field is changing most rapidly. Similarly, the voltage induced in L is zero at the instant when the inducing field has reached a condition of maximum expansion and is stationary for an instant before contracting. Thus there is a 90° phase displacement between voltage induced in L and

The greater the ratio of the amplitude of the double sideband component to the amplitude of the carrier component, the greater the phase deviation of the wave created by combining the two components. However, if the amplitude of the double sideband is made greater than about one-fifth of the amplitude of the carrier, so that the phase deviation is greater than about 0.2 radian, then two undesirable effects will become evident. 1) The wave will have appreciable amplitude variation as well as frequency variation, and 2) the phase deviation will no longer be proportional to the amplitude of the double sideband, as determined by the amplitude of the modulating voltage.

Thus only a slightly modulated FM wave should be produced in the phase-shift modulator. As long as the amplitude

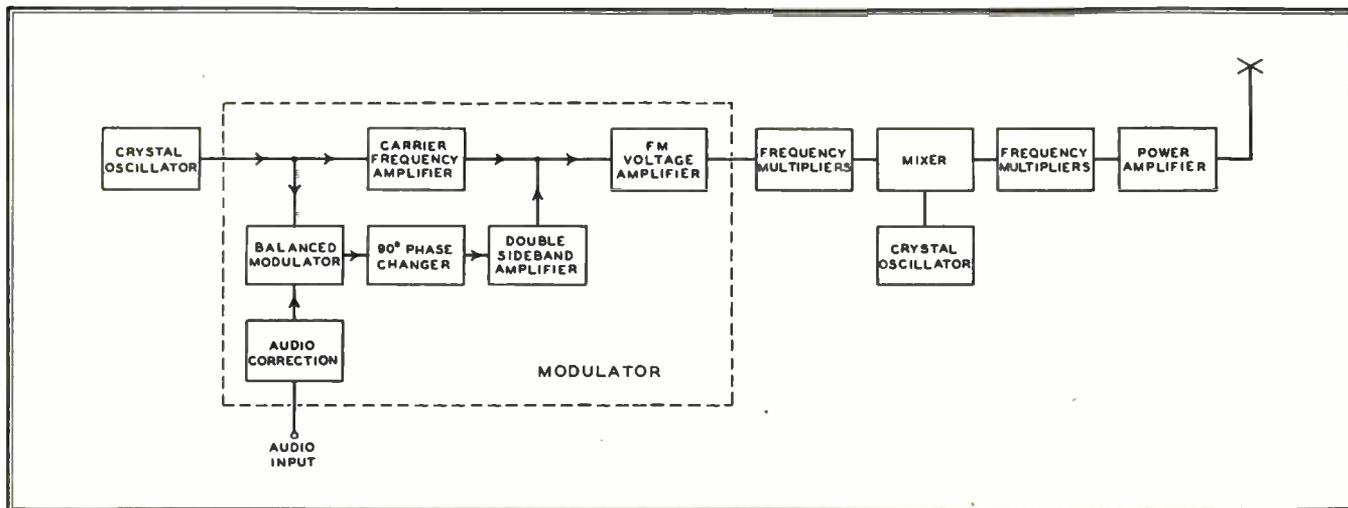

FIG. 42. A BLOCK DIAGRAM OF THE ORIGINAL ARMSTRONG PHASE-SHIFT MODULATOR CIRCUIT

The voltages appearing across the two halves of the secondaries of the transformer are inserted in opposite polarity in the screen grid returns of the two tubes. Thus during the first alternation of the audio modulating voltage, one screen is rendered more positive by the voltage across one half of the transformer secondary, while the other screen is rendered less positive by an equal voltage across the other half of the secondary.

This creates an unbalance such that the net RF field sweeping the coil L has a polarity determined by the predominant RF component of plate current, and a strength dependent upon the degree of inequality of the RF components of the plate currents of the two modulator tubes.

During the second alternation of the modulating voltage, the unbalance is shifted in the opposite direction, and the net RF field sweeping coil L is reversed in polarity.

In this way the net RF field sweeping coil L changes polarity as the audio modulating voltage changes its polarity, and the strength of the net RF field varies as the instantaneous value of the audio modulating voltage. Hence the balanced modulator produces a field about L_1L_2 that has

the net RF field about L_1L_2 . Since L is untuned, no further phase shift occurs before the voltage induced in L is applied to the grid of the sideband amplifier stage. In view of the 90° phase shift of the modulator output, the phase relationship of the sideband amplifier and the carrier frequency amplifier, Fig. 43, will be that shown for the double sideband and center frequency components, Fig. 40. If the amplitudes of the RF currents are also in the proportion shown in Fig. 40, then when the currents are drawn through a common load resistor R_L , the voltage wave across R_L will have a slight frequency modulation as shown at the top of Fig. 40.

Comparison of the frequency-modulated wave in Fig. 40 with the dotted curve of an unmodulated wave of the same average frequency shows that the effect of adding the double sideband component (after 90° displacement along the time axis) to the carrier component is to create a wave that is alternately advanced and retarded in phase with respect to the carrier. Hence the circuit of Fig. 43 is called the Armstrong phase-shift modulator.

of the double sideband is less than one-fifth of the carrier amplitude, making the modulation index less than 0.2 and the phase deviation less than 0.2 radian, then the phase deviation will be proportional to the amplitude of the audio modulating voltage, and an essentially distortionless modulated wave will be produced.

Alternate Circuit Arrangements ★ There are a number of alternate arrangements of the Armstrong phase-shift modulator, all operating on the same principle of combining the double sideband with the carrier frequency component in *phase quadrature*, that is, after displacement by 90° along the time axis. For example, the grids of the balanced modulator tubes may be excited by voltages 180° out of phase with each other, while the plates are connected in parallel to a common load. The same suppressed-carrier double sideband output will be obtained. Another arrangement commonly employed is to insert the 90° phase-shift in the excitation of the modulator rather than at its output. Various other devices can be used for obtaining the 90° phase-shift.

A simple alternate arrangement of the Armstrong modulator is shown in Fig. 44.

Here the oscillator output is applied to three voltage dividers in parallel. The first of the dividers is purely resistive throughout and the portion of the oscillator voltage tapped off the divider is applied without shift of phase to the carrier frequency amplifier tube. The RF current passed through the plate load resistor R_L by this tube is therefore in phase with the oscillator voltage.

The second of the voltage dividers consists of an RC network in which the resistance of R very greatly exceeds the reactance of C at the oscillator frequency. The current in this branch therefore is practically in phase with the oscillator voltage applied to it but the small voltage across C lags the current by 90° . Hence it also lags the oscillator voltage by 90° . The voltage across C is used to excite one of the modulator tubes.

The third of the voltage dividers consists of an RL network in which the resistance of R very greatly exceeds the reactance of L. Again, the current in the network is practically in phase with the applied voltage from the oscillator but the voltage taken from L for excitation of the modulator tube leads the current and the oscillator voltage by practically 90° .

Thus the grids of the balanced modulator are excited by voltages which respectively lag and lead the oscillator voltages by 90° , and are therefore 180° out of phase with each other. In effect, the grids of the modulator tubes are excited in pushpull, while the plates are connected in parallel. If the tubes are balanced, the RF components of the plate currents are equal and opposite at every instant. Under a condition of balance, no RF current flows in the common lead of the two modulator tubes to the load resistor R_L , and the only RF voltage appearing across R_L is that created by the flow of the carrier frequency amplifier RF plate current.

On the other hand, if the modulator tubes are alternately unbalanced in one direction and then in the other by an audio voltage applied in pushpull to their screen grids, the flow of RF current is alternately favored in one tube and then in the other. The net RF current in the common lead from the plates of the modulator tubes to the load resistor R_L will no longer be zero. The net current will have a polarity dependent upon which of the modulator tubes has the predominant RF component of plate current, as determined by the polarity of the audio voltage. The net current will have an amplitude dependent upon the degree of unbalance existing between the tubes, as determined by the amplitude of the audio voltage. Thus the wave form of the net RF current of the two modulator tubes will be that of the double sideband illustrated in Fig. 40. In view of the 90° phase shift introduced in the excitation, the relation of the double sideband current in R_L to the carrier current in R_L will also be that shown in Fig. 40. If the peak amplitude of the

double sideband is one-fifth of the amplitude of the carrier, the voltage drop across resistor R_L will have the wave form of the frequency-modulated wave shown at the top of Fig. 40.

Audio Frequency Correction ★ In the preceding discussion, a single fixed modulating frequency has been assumed. During the transmission of speech and music, however, the modulating frequency is varied, and components at several frequencies are often present at the same time. What effect will a change in modulating frequency have upon the wave produced in the circuits of Figs. 43 and 44?

changing the amplitude, more cycles of the modulating voltage occur within any given time period, and the time interval between the successive instants of maximum lead and lag is reduced. This causes the time periods of the cycles of the FM wave to change by a greater amount from one cycle to the next so that the same maximum amount of lead or lag is produced in the shorter time interval.

Hence the modulator circuits of Figs. 43 and 44 have the characteristic of giving a frequency deviation that is proportional to 1) the amplitude of the modulating voltage applied to the screen grids of the modulator which determines the maxi-

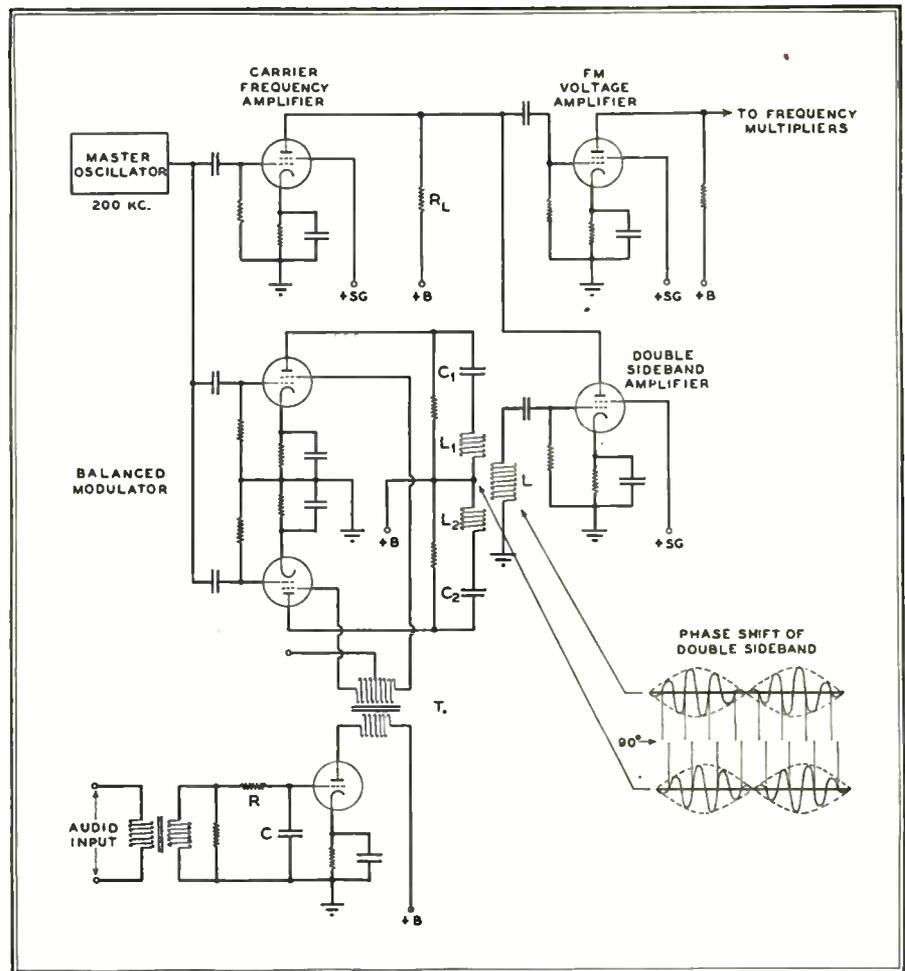

FIG. 43. CIRCUIT FOR PRODUCING SLIGHTLY MODULATED FM WAVES

It is noted in Fig. 40 that there are two instants of peak phase deviation for each cycle of the modulating frequency. In other words, during each cycle of the modulating frequency, the FM wave alternately acquires a maximum amount of lead and then a maximum amount of lag with respect to an unmodulated carrier of the same average frequency. The amount of the maximum lead or lag that is acquired depends upon the ratio of the peak amplitude of the double sideband to the amplitude of the carrier component, and does not depend on the modulating frequency.

When the frequency of the audio voltage at the modulator is increased without

maximum amount of lead and lag acquired, and 2) the frequency of the modulating voltage, which determines how many times per second the output wave alternately acquires the lead and lag.

In Section 4, however, it was stated that the FM wave must have a frequency deviation that is proportional to the amplitude of the modulating voltage but independent of its frequency.

To meet this specification for the transmitter output, it is necessary to counteract the characteristic of the modulator circuit whereby an audio modulating voltage of a given amplitude having a high frequency would cause a greater frequency deviation

than an audio modulating voltage of the same amplitude having a lower frequency.

The problem is handled quite easily by inserting an audio frequency correction network in the audio channel before the audio voltage is applied to the screen grids of the balanced modulator.

The circuit of a typical correction network is shown at the lower left of Fig. 43. In this case, a series RC network is connected across the loaded secondary of an audio transformer. The resistance of R is quite high compared to the reactance of C so that, for any given *amplitude* of the applied voltage, practically the same current flows in the RC network regardless of the *frequency* of the applied voltage. Since the reactance of C varies inversely as the frequency, the voltage taken from C for excitation of the correction amplifier tube is

FM waves that are modulated over a range of audio frequencies.

Frequency Deviation Multiplication ★ In order to obtain distortionless modulation from the phase-shift modulator, it has been stated that the maximum phase deviation of the FM voltage at the output should not exceed 0.2 radian. In other words, the modulation index of the FM voltage across R_L in Figs. 43 and 44 should not exceed 0.2.

A maximum modulation index of 0.2 for a transmitted FM wave would, of course, be quite insufficient to permit realization of the noise and interference reduction characteristics of the FM system. However, the modulation index of an FM signal can be increased, after generation and before transmission, by passing the signal through a series of frequency

and a maximum phase deviation of 5 radians.

However, the largest modulation index and phase deviation of the transmitted wave occur with full modulation at the *lowest* modulating frequency. For example, if the lowest audio frequency in the FM broadcast service is taken as 50 cycles, then with a deviation of 75 kc. at full modulation, the modulation index becomes $75,000/50$ or 1,500, equivalent to a phase deviation of 1,500 radians.

Hence, in FM broadcast service, where the range of modulating frequencies is 50 to 15,000 cycles and the maximum frequency deviation is 75,000 cycles, the transmitter should incorporate sufficient multiplication to raise a maximum phase deviation of 0.2 radian at the output of the phase-shift modulator to 1,500 radians at the transmitter output. This calls for a multiplication of at least $1500/.2$ or 7,500.

If doubler stages are used throughout the multiplication system, 13 stages are necessary, giving an overall multiplication of 2^{13} or 8,192. A combination of 5 doubler and 5 tripler stages can be employed, giving an overall multiplication of $2^5 \times 3^5$ or 7,776.

In the latter case, for a condition of full modulation at 50 cycles, the phase deviation at the output of the phase-shift modulator is $1,500/7,776$ or .193 radian, corresponding to a modulation index of 0.193. At modulating frequencies higher than 50 cycles, the phase deviation at the transmitter output is less than 1,500 radians, making the phase deviation at the output of the phase-shift modulator less than 0.193 radian. Thus at all modulating frequencies in excess of 50 cycles, the phase-shift modulator is operated within the phase deviation limit of 0.2 radian, while at frequencies somewhat lower than 50 cycles, the maximum phase deviation of the modulator is not sufficiently in excess of 0.2 radian to cause serious distortion.

Center Frequency Multiplication ★ Where the highest modulating frequency is 15,000 cycles, as in FM broadcasting, the frequency of the crystal-controlled oscillator used to excite the modulator should be in the order of 190 to 200 kc. If a much lower oscillator frequency were employed, such as 50 kc., the sideband frequencies would differ from the carrier by such a large percentage that the modulator circuits would discriminate somewhat against one sideband or the other, thus causing distortion. In fact, sideband correction networks were required in some of the earlier modulators operating at frequencies considerably less than 200 kc., in order to overcome this effect.

If the oscillator frequency is taken at about 200 kc., and if straight frequency multiplication of at least 7,500 is employed to hold the phase deviation of the modulator within 0.2 radian, then the center frequency after multiplication will

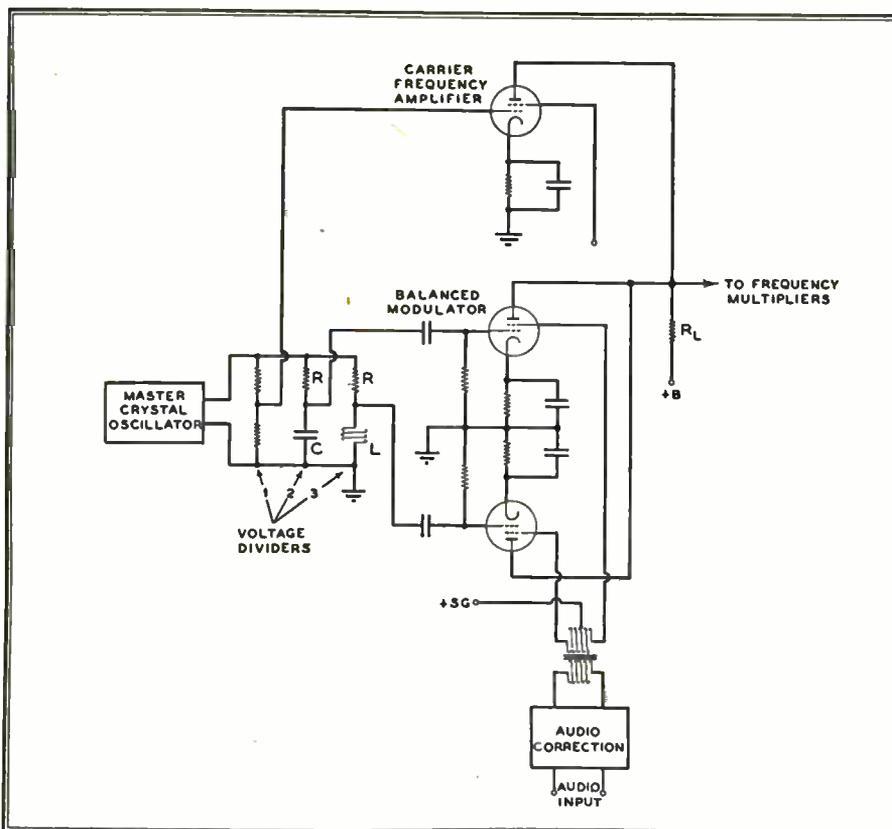

FIG. 44. AN ALTERNATE FORM OF THE ARMSTRONG MODULATOR

practically inversely proportional to the frequency.

By rendering the amplitude of the modulating voltage inversely proportional to its frequency before applying the voltage to the screen grids of the balanced modulator, by which a greater frequency deviation is produced at higher modulating frequencies is *discounted in advance*.

Thus, the maximum frequency deviation of the output wave is made proportional to the *amplitude* of the audio modulating voltage before correction, but independent of the *frequency* of the modulating voltage. The audio frequency correction network is an essential element of the phase-shift modulator designed to produce

multipliers. Each multiplier stage increases the frequency deviation and the modulation index of the signal by the same factor as the center frequency is increased.

How much frequency multiplication will be required to obtain a frequency deviation at the transmitter output sufficient to realize the benefits of the FM system?

The accepted ratio of the maximum frequency deviation of the transmitter output wave to the highest modulating frequency is 5 to 1. For example, in FM broadcast service, the maximum frequency deviation is 75 kc. for a highest modulating frequency of 15 kc., equivalent to a modulation index of $75/15$ or 5,

be at least $7,500 \times 0.2$ or 1,500 mc., or far beyond the band of frequencies assigned to FM broadcasting.

It is clear, then, that the center frequency can not be multiplied by as many times as the frequency deviation. Yet each multiplier stage increases the center frequency by the same factor as the frequency deviation.

The problem is easily solved by the use of a converter, or mixer stage, inserted in the chain of frequency multipliers, as shown in Fig. 42. The multiplied frequency at the point of insertion is applied to the mixer, along with a fixed frequency from a crystal-controlled oscillator, differing from the multiplied frequency by a known amount. The center frequency of the mixer output is the difference of the two frequencies at the input, producing a new center frequency of a much lower order. The frequency deviation at the mixer out-

If the master oscillator has a frequency of 200 kc., and if this frequency is multiplied 81 times before application to the mixer, then the multiplied frequency at the mixer input is 16,200 kc. To obtain a frequency at the mixer output of 440.6 kc., the frequency of the crystal-controlled oscillator should then be $16,200 - 440.6$ or 15,759.4 kc.

While the frequency of the crystal-controlled oscillator used with the mixer is chosen with the thought of obtaining a particular output frequency from the transmitter, it must not be assumed that the frequency stability of the transmitter, Fig. 42, is determined by the second oscillator alone. As a matter of fact, the stability depends on the frequency stability of both oscillators.

The stability of the transmitter arrangement illustrated in Fig. 42 is less, theoretically, than if the frequency were

phase-shift network CRRC. At this multiplied frequency, about 200 kc., the reactances of CC very greatly exceed the resistances of RR, so that the current in CRRC leads the applied voltage from coil L by practically 90° .

The voltage drops across the resistors RR are therefore practically 90° out of phase with the voltage across the input coil L. The common cathode lead from the modulator tubes is connected to the common junction of RR, while the grids of the tubes are connected to the extremities of RR. Thus the grids are excited in opposite polarity by voltages across RR that have been shifted 90° along the time axis with respect to the voltage across the input coil L.

The modulator operates on the same principle as the modulator shown in Fig. 44, the carrier component being balanced out because the plates are connected in

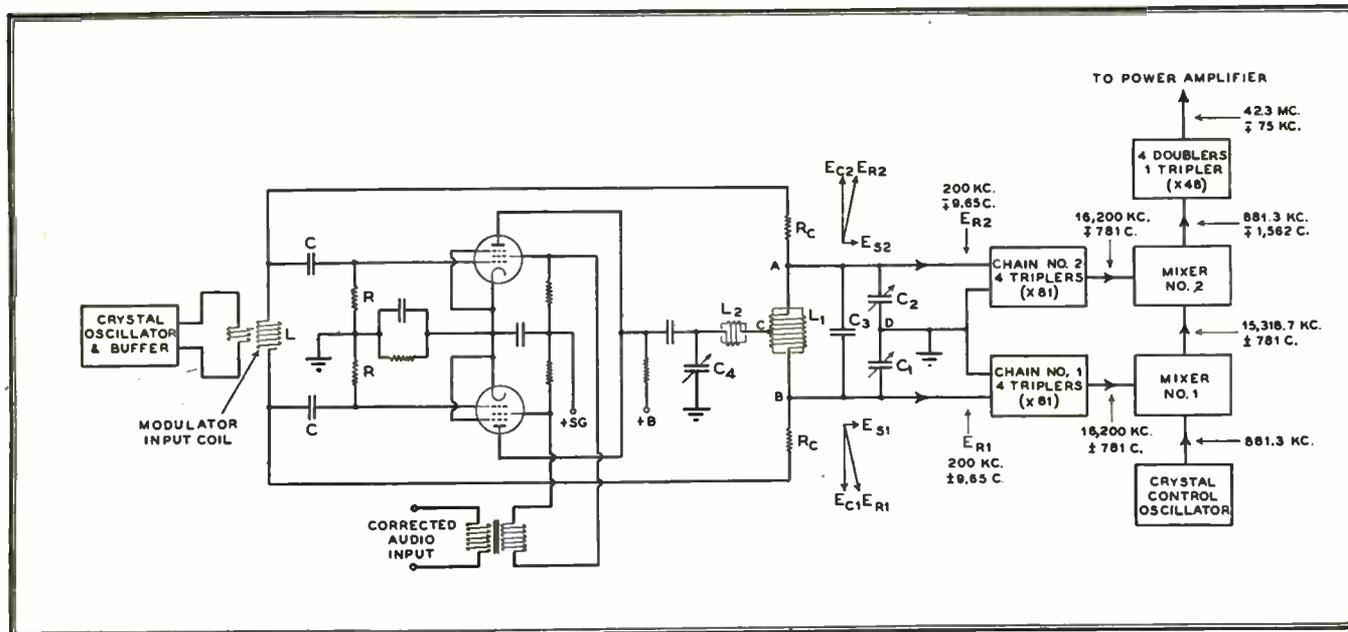

FIG. 45. CIRCUIT OF THE IMPROVED ARMSTRONG MODULATOR OF THE TYPE USED IN THE LATEST PHASE-SHIFT TYPE OF FM BROADCAST TRANSMITTER INSTALLATIONS

put, however, is just as great as that of the multiplied frequency fed to the mixer.

Thus, by the use of the mixer stage and crystal-controlled oscillator, it becomes possible to multiply the frequency deviation by more than 7,500 times, while multiplying the center frequency by a factor in the order of 200 or 250.

The frequency of the crystal-controlled oscillator is made such as to yield a beat frequency at the output of the mixer stage that can be multiplied to give the exact assigned carrier frequency.

For example, if the assigned frequency is 42.3 mc., and there is multiplication of 96 times between the output of the mixer and the input of the power amplifier, then the frequency at the output of the mixer is $42,300/96$ or 440.6 kc. The frequency of the crystal-controlled oscillator must be 440.6 kc. less than the multiplied frequency applied at the mixer input.

determined by a single crystal-controlled oscillator. In practice, the output frequency drift with both oscillators under crystal control is a small fraction of that allowed under FCC regulations. Furthermore, a new Armstrong modulator circuit has been designed, in which the frequency stability is determined entirely by the crystal-controlled oscillator at the mixer.

Improved Armstrong Phase-Shift Modulator ★ The circuit of the improved Armstrong phase-shift modulator, employed in broadcast transmitters, is shown in Fig. 45.

The output of a crystal-controlled oscillator operating at a frequency in the order of 200 kc., is passed through a buffer amplifier whose tuned output circuit is inductively coupled to the input coil L of a balanced modulator.

The voltage appearing across the modulator input coil L is applied to the 90°

parallel while the grids are excited in push-pull. The net RF current drawn by the modulator plates has an amplitude proportional to the amplitude of the audio modulating voltage and a polarity dependent on the polarity of the modulating voltage. The current drawn through the load by the modulating tubes has the wave form of the double sideband in Fig. 40. The phase relation of this current to the voltage across the input coil L is the same as that shown between the double sideband and the carrier component in Fig. 40.

The manner in which the double sideband current and the carrier current are combined in the improved modulator, Fig. 45, differs from that employed in the circuits of Figs. 43 and 44. It will be observed that no carrier frequency amplifier tube is employed in the new circuit. The center frequency voltage at the modulator

input coil is led through resistors $R_C R_C$, around the modulator, and is applied to the opposite terminals A, B of the tuned circuit $L_1 C_1 C_2 C_3$.

With respect to the center frequency voltage applied at points A, B, the tuned circuit $L_1 C_1 C_2 C_3$ is at parallel resonance, so that the current drawn from the input coil L through $R_C R_C$ is in phase with the input coil voltage. The center frequency voltage appearing across points A, B by virtue of the currents drawn through $R_C R_C$ is therefore in phase with the voltage at the modulator input coil. By grounding the common junction of condensers C_1 and C_2 , equal center frequency voltages of opposite polarity are applied to the tripler grids, as shown by vectors E_{C1} and E_{C2} in the small vector diagrams.

The above condition occurs in the absence of modulation. Actually, of course, during most of the time the transmitter is on the air, audio voltage is applied to the modulator screen grids and a double sideband is created. The manner in which the double sideband is added to the carrier by way of network $L_2 C_4$ will now be explained.

The coil L_1 , Fig. 45, has two terminals and a center tap, and can be regarded as a 3-terminal network. This is illustrated in Fig. 46, at (A). Each half of coil L_1 represents inductance in itself. This type of inductance is termed self-inductance, and is the amount of inductance offered by the turns in each half of the coil when the other half is disconnected. The self-inductances are denoted by L_A and L_B in diagram (B) of Fig. 46.

When both sections of the coil are connected in series, the field set up about each section sweeps across the turns of the other section. This effect is called mutual induction, and causes the inductance of the entire coil to be increased. The inductance of the coil becomes the sum of the self-inductances of its sections, increased by twice the amount of mutual inductance M . Thus, in diagram (B) of Fig. 46, the inductance offered by the coil between terminals A, B is $L_A + L_B + 2M$.

This leads to the three-terminal network of diagram (C), Fig. 46, which is the equivalent of the coil in diagrams (A) and (B). The equivalence can be easily checked by adding the inductances between each pair of terminals.

Between terminals A, C, the inductance is $L_A + M - M$ or simply L_A , the self-inductance of the turns in the upper section. Between terminals C, B, the inductance is $-M + L_B + M$ or simply L_B , the self-inductance of the turns in the lower section. Finally, between terminals A, B, the inductance is $L_A + M + L_B + M$, or $L_A + L_B + 2M$, that is, the sum of the self-inductances increased by twice the mutual inductance, or again the value to be expected.

Coil L_1 of Fig. 45 can be replaced by the mathematically equivalent network of diagram (C) Fig. 46. This substitution

has been made in Fig. 47, in which the circuits to which the output of the balanced modulator is delivered have been redrawn. In Fig. 47, the generator represents the double sideband voltage developed by the modulator. The capacity across L_1 of Fig. 45 has been assumed in Fig. 47 to reside entirely in two series variable condensers C_A and C_B , rather than in the form of a fixed capacity C_3 and two variables, C_1 and C_2 , as in Fig. 45. This change has been made to simplify the explanation of circuit operation, since the fixed condenser C_3 of Fig. 45 is employed solely to avoid the use of excessively large variable condensers.

The tuned circuit $L_1 C_1 C_2 C_3$, Fig. 45, is resonant to the center frequency voltage applied at terminals A, B. Thus, in Fig. 47, the total capacitive reactance of C_A and C_B in series is equal to the total inductive reactance of $L_A + M$ in series with $L_B + M$. Because of the circuit

and C_B are equal to each other, and both of the voltages lag the branch currents by another 90° . Thus the double sideband voltages appearing across C_A and C_B are equal in magnitude, of the same polarity with respect to ground, with the phase of both voltages differing by $90^\circ + 90^\circ$ or 180° with respect to the sideband voltage at the balanced modulator output.

Since a 90° phase shift was introduced in the excitation of the balanced modulator which carried over into the modulator output, the subsequent shift of 180° degrees leaves the double sideband voltages appearing across C_A and C_B in phase quadrature with respect to the center frequency voltage appearing across the modulator input coil.

The center frequency voltage is applied in diminished amplitude at points A, B, causing center frequency voltages to appear across C_A and C_B in opposite polarity with respect to ground. The double side-

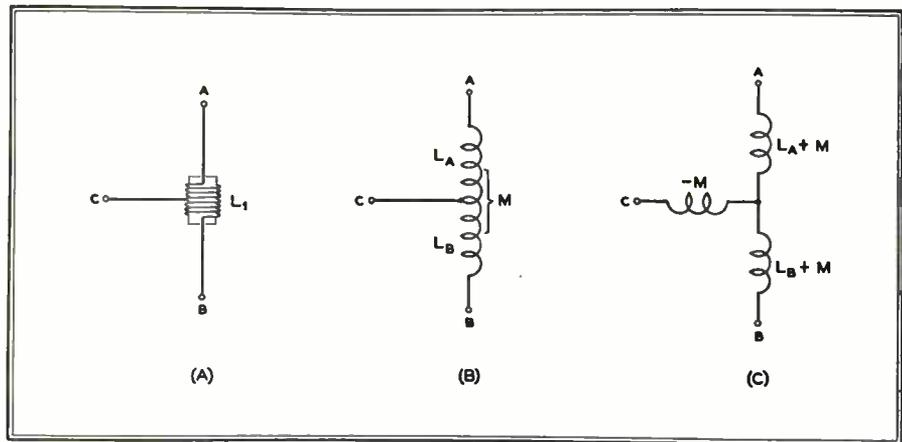

FIG. 46. COIL L_1 OF FIG. 45, AND ITS EQUIVALENT NETWORKS

symmetry, the inductive reactance of $L_A + M$ equals the capacitive reactance of C_A , and the inductive reactance of $L_B + M$ equals the capacitive reactance of C_B . Therefore, between point E in Fig. 47 and ground, the parallel branches C_A , $L_A + M$ and C_B , $L_B + M$ are series resonant at the center frequency. The only opposition to current flow at the center frequency between point E and ground is the low resistance of the coil sections.

The inductance of coil L_2 is sufficiently in excess of the negative inductance $-M$ between points C and E to cancel $-M$ and to leave a positive remainder of inductance that can be tuned to parallel resonance at the center frequency by means of condenser C_4 . In this way, the balanced modulator delivers its output to a resistive load.

The current in the inductive branch, comprised of L_2 , $-M$, and the low resistances between point E and ground, lags the voltage applied from the double sideband generator by practically 90° . At point E, the current divides equally between the series resonant paths to ground. The voltages across the condensers C_A

and C_B are in the same polarity with respect to ground. It follows that the phase difference between the carrier and double sideband voltages across one condenser will be in the form of a 90° lead at the same time as the phase difference across the other condenser is in the form of 90° lag.

This is illustrated by the small vector diagrams in Fig. 45. The sideband voltages E_{S1} and E_{S2} , created across condensers C_1 and C_2 , are in phase and equal. The center frequency voltages E_{C1} and E_{C2} , across the same condensers, are equal but of opposite polarity, each differing in phase from the sideband voltage by 90° .

The resultant frequency-modulated voltage E_{R1} appearing across C_1 leads the center frequency component E_{C1} at the same time as the resultant voltage E_{R2} across C_2 lags the carrier component E_{C2} . The resultants are therefore frequency-modulated voltages that are alike except for the fact that the frequency of one voltage is increasing at the same time as the frequency of the other voltage is decreasing.

Readers unfamiliar with vector diagrams will understand the situation by

considering what would happen if the center frequency component in Fig. 40 were reversed before being combined with the double sideband. The summation would give a frequency-modulated wave having its maximum lag at the instant when a maximum lead is shown in Fig. 40, and its maximum lead at the instant when the maximum lag is shown.

Thus the frequency-modulated voltage E_{R1} across C_1 is increasing in frequency while the frequency-modulated voltage E_{R2} across C_2 is decreasing in frequency. If the frequency deviation of the voltage is, say, 9.65 cycles, then the frequency-modulated voltage across C_1 can be described as having the frequency $200 \text{ kc.} \pm 9.65$ cycles, while that across C_2 can be described as $200 \text{ kc.} \mp 9.65$ cycles.

Frequency Multiplication System ★ Each of these two output voltages of the modulator, Fig. 45, is passed through its own chain of four triplers, giving a multiplication of both the center frequency and the frequency deviation by a factor of 3^4 or 81.

If the frequency at the input of tripler chain No. 1 is $200 \text{ kc.} \pm 9.65$ cycles, then the output of the chain will have a frequency of $16,200 \pm 781$ cycles. Because of the opposite frequency deviation of its

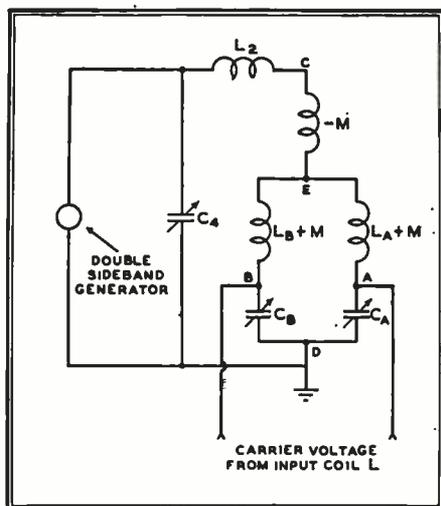

FIG. 47. OUTPUT OF BALANCED MODULATOR REDRAWN FROM FIG. 45

input, tripler chain No. 2 will deliver an output of $16,200 \text{ kc.} \mp 781$ cycles.

The output of each tripler chain is applied to a mixer stage. Tripler chain No. 1 delivers a frequency of $16,200 \pm 781$ cycles to mixer No. 1. This mixer also receives a voltage from the crystal-controlled control oscillator, which has a frequency equal to the assigned carrier frequency of the transmitter divided by the overall frequency multiplication that follows the mixer stages. In the transmitter shown in Fig. 45, four doublers and a tripler follow the mixers, giving an overall frequency multiplication of $2^4 \times 3$ or 48. If the carrier frequency assigned to the transmitter is, say, 42.3 mc. , then the

frequency of the control oscillator is $42,300/48$ or 881.3 kc.

With the control oscillator frequency of 881.3 kc. applied to mixer No. 1 together with the output of tripler chain No. 1 at $16,200 \text{ kc.} \pm 781$ cycles, the difference frequency appearing in the output of mixer No. 1 is $15,318.7 \text{ kc.} \pm 781$ cycles. This frequency is applied to mixer No. 2 along with the output of the tripler chain No. 2 at $16,200 \text{ kc.} \mp 781$ cycles. The difference of the center frequencies is $16,200 - 15,318.7$ or 881.3 kc. The difference of the frequency deviations, which at any time are of opposite sign, is twice the deviation of each frequency, or $2 \times 781 = 1,562$ cycles.

The frequency at the output of mixer No. 2 may therefore be described as $881.3 \text{ kc.} \mp 1,562$ cycles. After passing through four doublers and a tripler, in which multiplication of 48 is obtained, the frequency becomes $42.3 \text{ mc.} \mp 75 \text{ kc.}$, which is suitable for excitation of the power amplifier of the FM broadcast transmitter.

Advantages of the Improved Modulator ★ The most notable differences between the improved modulator and the earlier types arise from the use of two chains of triplers excited by the voltages from the phase-shift modulator.

When the outputs of the chains of triplers are combined with the output of a crystal-control oscillator in the two mixers, as described above, the center frequency of the output of mixer No. 2 is the same as that of the control oscillator, regardless of any small variations in the frequency of the oscillator used to excite the modulator.

Suppose, for example, that the frequency of the oscillator which excites the modulator drifts from 200 to 201 kc. , that is, to a frequency 1 kc. too high. The center frequencies of the voltages at the inputs of the tripler chains will also be 1 kc. high, while at the output of the triplers, the voltages will be 81 kc. high. The output of mixer No. 1 will have a center frequency that is 81 kc. high, but the frequency at the output of mixer No. 2 will not contain the 81 kc. error, because it is the difference between two frequencies, each of which is 81 kc. high.

The frequency stability of the output frequency of the transmitter is therefore dependent on the stability of the control oscillator alone, and is independent of the first oscillator, used to excite the modulator. It is not imperative that the first oscillator be crystal controlled, although a crystal is usually employed as a matter of convenience, since it insures that the tripler chains will not be detuned by a large drift in the oscillator frequency.

Just as the effects of drift, or *slow* variation in the frequency of the oscillator used to excite the modulator, is balanced out, so also *rapid* variations are balanced out. Thus the improved modulator tends to overcome any slight noise or hum modulation that occurs in the first oscillator. Al-

though earlier types of Armstrong modulators were remarkably free from hum and noise as early FM listeners will remember, the noise level in the new Armstrong modulator is still lower, being in the order of -70 db.

The incorporation of sufficient multiplication to give frequency deviation equivalent to full modulation, while requiring a phase deviation of not more than 0.2 radian at the output of the phase-shift modulator at the lowest audio frequency, obviates the possibility of distortion in the modulator.

For a modulation index of 0.2 , the distortion inherent in the modulator is about 1% . This distortion occurs only with full modulation at the lowest audio frequency. At higher audio frequencies, and/or with less than full modulation, the modulation index is less than 0.2 and the inherent distortion disappears.

Pre-emphasis Network ★ It has been stated that the frequency deviation of the modulated wave should be proportional to the amplitude of the modulating voltage but

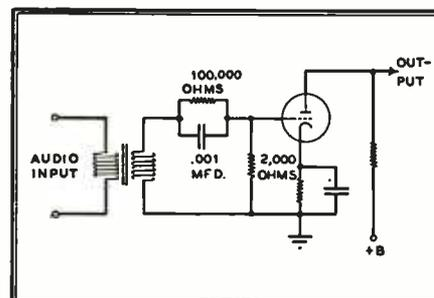

FIG. 48. NETWORK FOR INTRODUCING PRE-EMPHASIS

independent of its frequency. This is the basis upon which all FM transmitters are originally designed and upon which they are adjusted in service.

In the FM broadcast service, as explained in Section 2, it is desirable in the interest of noise reduction at the high frequencies to employ pre-emphasis networks so that the frequency deviation is increased when the modulating frequency is increased, assuming that receivers incorporate de-emphasis networks to bring the high frequency components of the detected signal back into proper amplitude relation with respect to the low frequency components.

Fig. 48 shows a circuit which will permit the correct amount of pre-emphasis to be introduced. A $.001\text{-mfd.}$ condenser in parallel with a $100,000\text{-ohm}$ resistance is inserted in series with the lead to the grid of the audio amplifier tube, and a $2,000\text{-ohm}$ resistor is connected between grid and cathode. As the frequency is increased, a larger current flows through the condenser, producing a higher voltage across the $2,000\text{-ohm}$ resistor, so that the amplitude of the audio modulating voltage at the transmitter is increased.

GENERAL FM THEORY

SECTION 6: INTRODUCTION TO FM RECEIVERS, COVERING RF & IF AMPLIFIERS, OSCILLATORS AND MIXERS, AND DISCUSSION OF LIMITER OPERATION

IN THE preceding Sections, it has been emphasized that the *amplitude* of an FM signal remains constant during modulation, while the *frequency* is alternately increased and decreased in accordance with the variation of the audio modulating voltage at the transmitter.

It follows that the first requirement to be met in the design of FM receivers is that the detector be capable of giving a change in its output voltage proportional

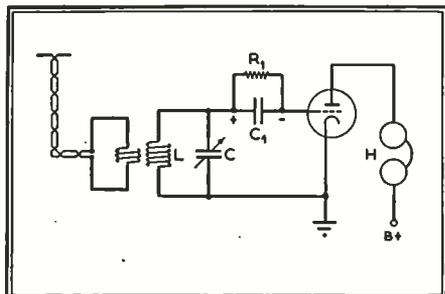

FIG. 49. ELEMENTARY TYPE OF FM RECEIVING CIRCUIT

to a change in the *frequency* of the input signal. When an FM signal is applied to a detector that meets this specification, the detector yields an audio output voltage having the same wave form and frequency as the audio modulating voltage at the transmitter.

Elementary FM Receiver ★ An FM receiver, in its simplest form, could consist of such a detector alone, as shown in Fig. 49. Here the input signal causes a voltage to be induced in coil L that sets up a radio frequency current in the tuned circuit LC. The current flowing in the tuning condenser C establishes an RF voltage across this condenser that is applied to the grid-leak and grid-condenser combination R_1C_1 by way of the grid and cathode of the tube. The grid and cathode operate as a diode rectifier and cause a DC voltage to be established in grid condenser C_1 very nearly equal to the amplitude of the RF voltage across tuning condenser C. The DC voltage established in grid condenser C_1 acts as a negative bias on the grid of the tube and limits the flow of plate current.

If the amplitude of the RF voltage across tuning condenser C is increased, the negative bias developed across C_1 is increased and the plate current of the tube is reduced. Conversely, if the RF voltage across C is decreased, the bias across C_1 is decreased, and the plate current is increased. Now, if the amplitude of the RF voltage across C increases and decreases at an audio rate, then the bias established in C_1 will vary in like manner. The resulting audio variation of the plate

current will cause the diaphragms of the headphones H to vibrate.

In fact, old timers will recognize the FM detector circuit of Fig. 49 as being exactly like that of a non-regenerative grid-leak detector for receiving AM signals. In the case of AM reception, the circuit LC is tuned exactly to the carrier frequency of the AM signal. This insures the maximum RF current flow in the tuned circuit LC and the maximum RF voltage across tuning condenser C. During modulation, the amplitude of the voltage across tuning condenser C is varied because the amplitude of the voltage induced in coil L by the AM signal is varied. The detector translates the amplitude variations of the voltage across C into variations of plate current, as explained.

For the reception of FM signals, however, the circuit LC is not tuned to exact resonance with the carrier or center frequency of the FM signal. In fact, the circuit LC is detuned until the amplitude of the voltage across C, produced by an unmodulated signal, falls off to about one-half that at resonance. A typical adjustment for the reception of FM signals is

frequency somewhat lower than the center frequency of the signal.

The waveform of the incoming FM signal is shown at the lower center in Fig. 50. Since the detector is responsive to a change in *frequency* of the signal, the frequency of the signal is plotted to the same scale of time, at the lower left in Fig. 50. The curve of the signal frequency variation is then projected upward against the selectivity curve of the tuned circuit, the area of impingement being centered about point A on the curve in Fig. 50.

It is noted that in the immediate vicinity of point A, the selectivity curve in Fig. 50 is steep and nearly straight. This means that when an FM signal is inducing voltage of constant amplitude but varying frequency in coil L, Fig. 49, the *amplitude* of the voltage built up across tuning condenser C will vary over a wide range, and the change in the amplitude of the voltage across C will be practically proportional to the change in the frequency of the voltage induced in L.

Thus a tuned circuit adjusted to a frequency somewhat higher or lower than the center frequency of an FM signal

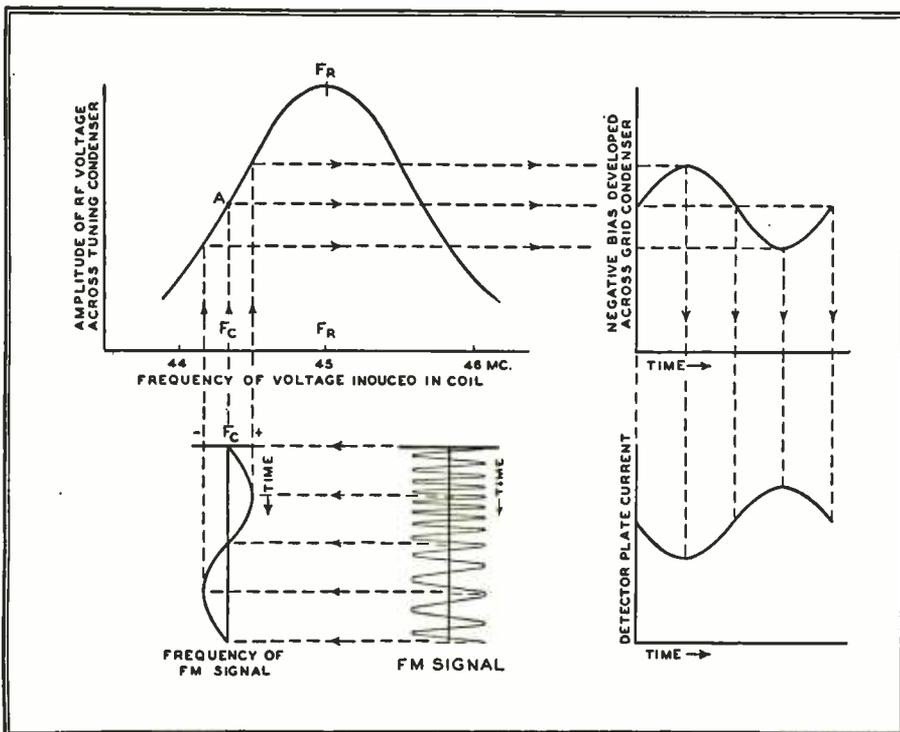

FIG. 50. TUNED-CIRCUIT DETECTION FROM ELEMENTARY RECEIVER, FIG. 49

indicated at point A on the selectivity curve of the tuned circuit, at the upper left in Fig. 50. In this case, the resonant frequency F_R of the tuned circuit is higher than the center frequency F_C of the signal. It would also be possible to obtain FM detection by tuning LC to a

has the property of translating the frequency variations of the signal voltage induced in the coil into amplitude variations of voltage across the tuning condenser. As the frequency of the signal swings toward the resonant frequency of the tuned circuit, the voltage across

the tuning condenser increases. As the frequency of the signal swings away from the resonant frequency of the tuned circuit, the voltage across the tuning condenser decreases. By careful adjustments, the amplitude variations of the voltage across the tuning condenser can be made nearly proportional to the variations of the signal frequency. The grid-leak detector converts the changes in amplitude of the voltage across the tuning condenser to corresponding changes in grid-condenser bias, as shown at the upper right in Fig. 50. The changes in grid-condenser bias, in turn, cause proportionate changes in plate current, as shown at the lower right in Fig. 50. Thus a voltage is built up across the load in the plate circuit having nearly the same wave form as the audio modulating voltage at the FM transmitter.

While an FM receiver can thus be constructed with a minimum of parts, it can hardly be claimed that such a single-tube detector would give satisfactory reception. The operation of this simple receiver has been described in order to illustrate the principle of an FM detector in terms familiar to all. It also explains why AM communications receivers, covering frequencies above 40 mc., can, with careful tuning, achieve poor but intelligible reception of FM signals. Finally, a consideration of the shortcomings of the simple circuit described will point out the characteristics required of a genuine FM receiver, capable of delivering the type of performance that distinguishes FM from AM.

FM Receiver Design Considerations ★ In the first place, the receiver of Fig. 49 would be very insensitive. The FCC considers the service area of usable signal of an FM station to extend to the 50-microvolt contour. Therefore, the receiver should incorporate sufficient RF gain to give satisfactory operation at input voltages in the order of 5 to 40 microvolts. This calls for high RF amplification before the detector, a requirement that can be met most satisfactorily by the use of the superheterodyne circuit, indicated in Fig. 51. The reduction of adjacent-channel interference (interference from FM stations operating on channels adjacent to the channel of the desired station) is made more effective by the use of the superheterodyne circuit.

Secondly, while the detector shown in Fig. 49, can be made to give an output nearly proportional to the change in frequency of the applied FM signal, it would still be responsive to changes in amplitude of the detector input voltage. Thus noise and other interference would not be eliminated nor reduced in the circuit of Fig. 49. In the superheterodyne, changes in amplitude due to interference and noise pass through the IF amplifier. In order to prevent these amplitude variations from being impressed on the

second detector, it is necessary to employ an effective amplitude limiter, as indicated in Fig. 51. The use of the limiter is required to reduce noise and interference, regardless of the type of detector employed. Sufficient gain must be provided in the receiver to insure that the weakest signal it is desired to receive without interference noises is amplified to a level sufficient to cause amplitude limiting action in the limiter.

A third deficiency of the detector shown in Fig. 49 is that in order to obtain reasonably linear conversion of input signal frequency variations into output voltage amplitude variations, the tuned circuit LC must be very carefully adjusted to the frequency at the mid-point of the straight portion of the selectivity curve, indicated by point A in Fig. 50. Even so, if the swing of the transmitter frequency is too great, operation in the curved portions of the curve will result, causing distortion of the detector output waveform. Also,

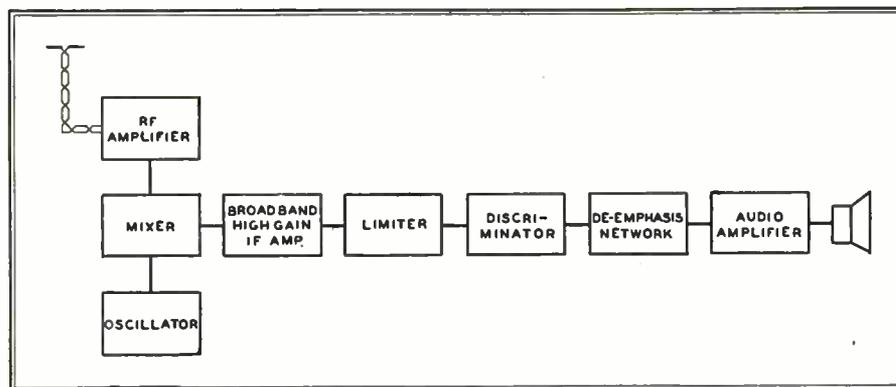

FIG. 51. BLOCK DIAGRAM SHOWING ELEMENTS OF A GENUINE FM RECEIVER

since the detector plate current decreases as the voltage across the tuning condenser increases, excessive input voltage may drive the plate current beyond cutoff, with resulting harmonic distortion. Genuine FM receivers have special FM detector circuits called *discriminators*, designed to handle large input voltage and to give essentially linear response over a wide frequency range.

It will also be noted that the circuit in Fig. 49 contains no de-emphasis to compensate for the pre-emphasis characteristic introduced at FM transmitters. Thus a de-emphasis network is inserted immediately after the discriminator, as indicated in Fig. 51.

Finally, if the full advantages inherent in FM broadcasting are to be realized, it is especially important to employ an audio amplifier having a wide frequency range and minimum harmonic and cross-modulation distortion. The noise and hum level of the audio amplifier should be very low. A high quality speaker system is also necessary, to obtain realistic reproduction.

In this Section, it is proposed to discuss only the circuits of the conventional superheterodyne that amplify and limit FM signals. The following Section will take

up discriminators, de-emphasis networks, audio systems and special FM circuit arrangements.

Superheterodyne FM Receiver ★ It will be observed in Fig. 51 that the arrangement of the superheterodyne FM receiver, from the antenna to the input of the limiter, resembles that of a conventional AM receiver. However, even in this area, there are certain important differences between FM and AM circuits.

For example, an automatic volume control acting upon all the RF and IF amplifier stages, as commonly employed in AM receivers, is neither necessary nor desirable in FM circuits. It is unnecessary because the FM limiter maintains the amplitude of the signals applied to the discriminator at a fixed level. It is undesirable because, in general, any system which reduces the RF gain preceding the limiter tends to lower the signal-to-noise ratio at the limiter. However, a few receivers

have been designed in which a limited amount of automatic or manually adjustable volume control is incorporated in order to prevent the signal amplifier grids from being driven positive on very strong signals.

Another difference between FM and AM superheterodyne receivers lies in the comparative band width of the IF amplifier system. In AM, at any one modulating frequency, there is but one pair of sideband components, having frequencies respectively higher and lower than the carrier by the amount of the modulating frequency. If the highest modulating frequency is 10 kc., a band width of 20 kc., centered at the intermediate frequency, will be adequate. On the other hand, in the case of FM signals, a large number of pairs of sideband components of appreciable amplitude may be present along with the center frequency component. As was noted in Section 1, the maximum band width is required when the FM signal is fully modulated at the highest modulating frequency. For example, in FM broadcasting, if the frequency is varying over the full range of plus or minus 75 kc., at 15 kc. per second, it was shown that eight important pairs of sidebands are present,

requiring a theoretical band width of 16×15 or 240 kc., centered at the intermediate frequency. Actually, the band width is not made as wide as theoretically required, because 1) sideband components at frequencies near the limits of the theoretical band are of rather small amplitude and appear only when the transmitter is strongly modulated at the higher audio frequencies, 2) a worthwhile increase in RF gain per amplifier stage is obtained as the band width is decreased, and 3) with a somewhat narrower band, adjacent-channel interference is reduced.

form amplification of all sideband components on the other. As will be explained later, this comparatively narrow IF band width can cause appreciable distortion when the incoming FM signal is strongly modulated at high audio frequencies. Thus well-designed post-war receivers have IF band widths somewhat greater than those of pre-war receivers, in order to realize the full advantages of FM.

In general, FM receivers should have a higher overall RF gain than AM receivers. This is necessary in order that the weakest signal from which satisfactory reception

should amount to at least $4/.00001$ or 400,000. Such a gain at the high order of RF and IF frequencies involved, together with greater band width in the IF stages, makes the design of the signal amplification section of the FM superheterodyne considerably more difficult than that of AM receivers.

The RF Amplifier ★ All FM receivers should incorporate a radio frequency amplifier preceding the mixer or converter stage. The advantages gained more than justify the extra expense involved.

In the first place, the RF amplifier supplies additional RF gain. With a well-designed coil, the voltage step-up in the coil at resonance is in the order of 3 to 5. By careful circuit design and choice of the RF tube, the tube gain may be in the order of 6 to 10, thus giving an overall gain in the RF amplifier of about 20 to 50. While a really large gain is not obtainable in the RF amplifier at frequencies in excess of 40 mc., the gain of the RF amplifier does serve to reduce materially the amount of gain required of the mixer and IF amplifier stages.

The introduction of gain *before* the mixer stage is especially desirable because it serves to improve the signal-to-noise ratio of the receiver. Most of the noise due to tube hiss is introduced by the mixer. Thus if the amplitude of the signal can be raised before reaching the mixer grid, the usable sensitivity of the receiver can be improved.

As in the AM superheterodyne, the tuned input circuit of the RF amplifier also serves to reject signals on the image frequency which might otherwise cause serious interference. The image frequency is that frequency which differs from the signal frequency by twice the intermediate frequency and which lies on the same side of the signal frequency as the oscillator frequency.

For example, suppose that the intermediate frequency of the receiver is 4 mc., and that the desired signal has a frequency of 48 mc. If the receiver is one in which the oscillator frequency is higher than the signal frequency, the oscillator frequency would be $48 + 4$ or 52 mc., and the image frequency would be $48 + 8$ or 56 mc. If the receiver is one in which the oscillator operates at a frequency lower than the intermediate frequency, the oscillator frequency would be $48 - 4$ or 44 mc., and the image frequency would be $48 - 8$ or 40 mc. If the image frequency reaches the grid of the mixer tube, the mixer responds as readily to image frequency interference as to the desired frequency.

In receivers which do not have RF amplification before the mixer stage, signals at the image frequency are attenuated only in the one input tuned circuit of the mixer. If they are of sufficient strength at the mixer grid, they create a component at the intermediate frequency in the mixer output which interferes seri-

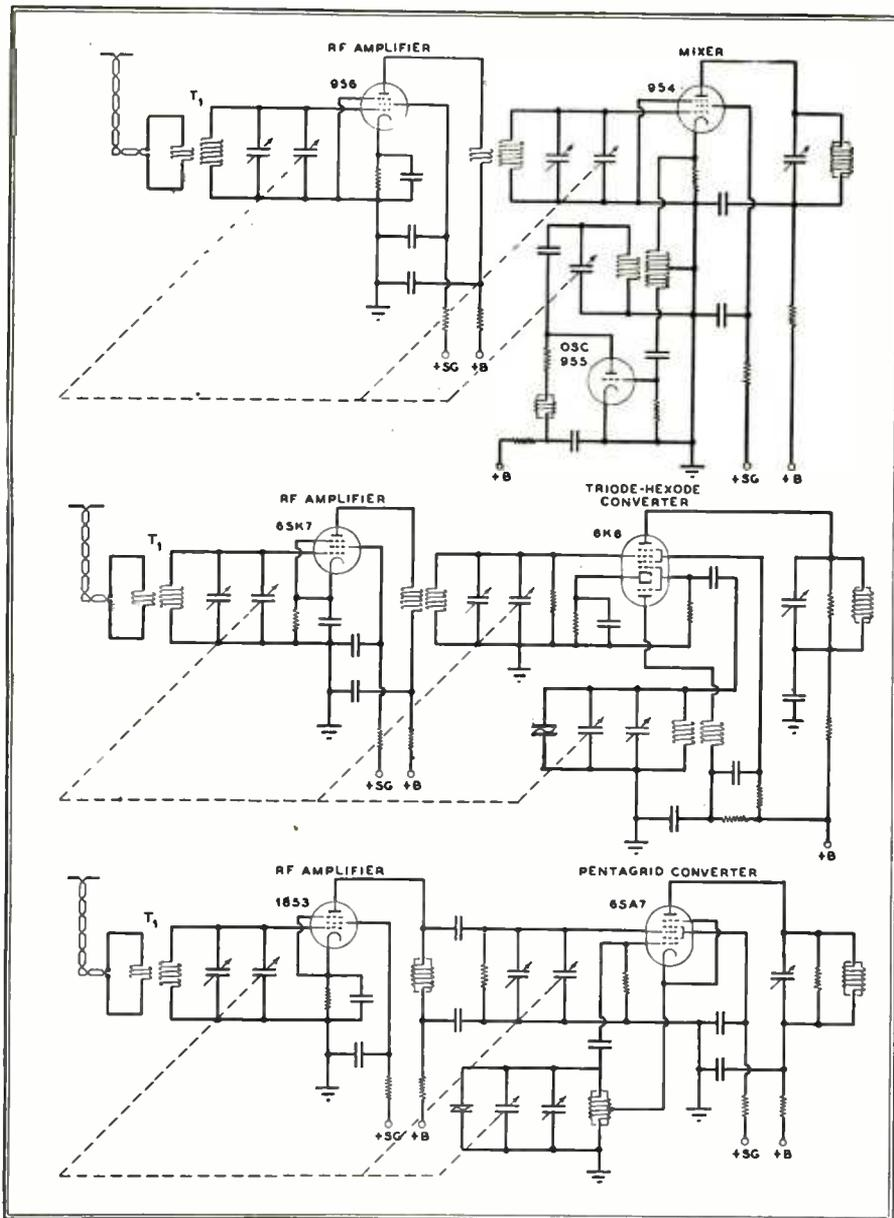

FIG. 52. THREE DIFFERENT TYPES OF MIXER CIRCUITS FOR FM RECEIVERS

The selectivity curves of IF amplifiers commonly employed in prewar FM broadcast receivers are down about 6 db at 75 kc. above and below the intermediate frequency. This represents a compromise between the opposing aims of obtaining maximum gain per stage and excellent suppression of adjacent-channel interference on the one hand, and of having uni-

form amplification of all sideband components on the other. As will be explained later, this comparatively narrow IF band width can cause appreciable distortion when the incoming FM signal is strongly modulated at high audio frequencies. Thus well-designed post-war receivers have IF band widths somewhat greater than those of pre-war receivers, in order to realize the full advantages of FM.

ously with, or even over-rides, the component created by the desired signal.

On the other hand, if a tuned radio frequency amplifier precedes the mixer, signals at the desired frequency and the image frequency are passed through two independent tuned circuits and the rejection of the image frequency is more pronounced. For example, if one tuned circuit, resonant at the desired signal frequency, is capable of reducing the strength of signals at the image frequency by a ratio of 50 to 1, then two independent tuned circuits of the same characteristics will reduce the image frequency signal by the ratio of 2,500 to 1.

Similarly, the use of a tuned RF amplifier stage gives valuable additional protection against interference from strong signals at the intermediate frequency, which might otherwise reach the mixer grid in sufficient strength to cause serious interference at the mixer output.

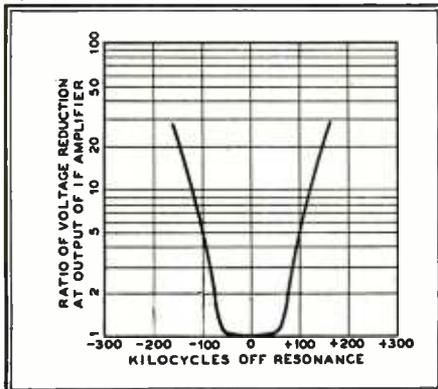

FIG. 53. TYPICAL CHARACTERISTIC OF IF CIRCUIT IN FM RECEIVER

Typical RF amplifier circuits are shown at the left of the circuit diagrams of Fig. 52. The input transformer T_1 in each case is designed to permit the use of a dipole antenna for picking up signals. The low impedance input winding matches the low impedance line from the dipole, so that efficient transfer of signal energy to the tuned input circuit will be obtained.

A low-loss coil is employed in the tuned circuit and in view of the high frequencies involved, it is especially important to use short leads between the coil, condenser and tube. The tuned input circuit should be carefully shielded from the remainder of the receiver. A direct lead should be employed between the low-potential terminals of the coil and condenser, instead of grounding both terminals to the chassis to complete the circuit. It is best to make all grounds in the RF amplifier stage at a common point on the chassis. This minimizes stray inter-stage coupling, and helps to avoid regeneration or degeneration in the RF amplifier stage. Degeneration would result in loss of gain, while regeneration may lead to oscillation in the amplifier.

The tube employed in the RF amplifier should be one which will give high gain

at high frequencies. RF pentodes are usually employed for their high mutual conductance and low grid-to-plate capacity. The tube chosen should be one which has low input capacity and high RF resistance between the grid and cathode. Acorn and button type pentodes are especially suitable because of their high gain, low input capacity and short leads to the tube electrodes, but the less expensive conventional types of pentodes have often been used.

mechanically one grid is the extension of the other to the opposite side of the flat cathode, as previously explained. The FM signal voltage is applied to grid No. 3 of the hexode, which is shielded from the plate and from grid No. 1 by grids Nos. 2 and 4, both of which are held at ground RF potential by means of a bypass condenser. Thus both the oscillator and the signal voltages modulate the electron stream, while there is a minimum of electrostatic coupling between the oscillator

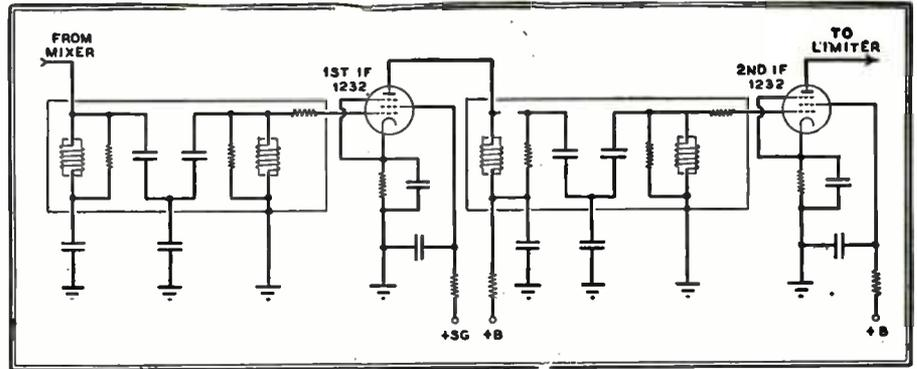

FIG. 54. CIRCUIT FOR TYPICAL TWO-STAGE IF AMPLIFIER FOR FM SET

The Oscillator and Mixer ★ In accordance with the superheterodyne principle, signal voltage from the RF amplifier and constant-amplitude RF voltage from a local oscillator are applied to separate control elements of the mixer tube. The component of plate current at the difference frequency is utilized to excite the high gain IF amplifier which follows the mixer stage.

Three types of circuit arrangements for mixer and oscillator are shown in Fig. 52. The circuit at the top employs acorn tubes throughout, with a separate tube for the oscillator. This arrangement permits each tube to be operated with maximum efficiency and good stability, and relatively high gain is obtained in the RF amplifier and mixer. The expense of this arrangement is high, however, because three special types of tubes are employed.

The circuit shown at the center of Fig. 52 is an alternate arrangement in which a triode-hexode converter tube is used. Hexode is the name applied to a six-electrode tube containing a plate, a cathode, and four grids, grid No. 1 being nearest the cathode and grid No. 4 nearest the plate. The triode-hexode tube contains the elements of a triode in addition to those of the hexode, within the same tube envelope. In the triode-hexode converter, the plate currents of the hexode and triode are taken from opposite sides of the flat rectangular cathode. Only one grid encircles the cathode, and this grid serves both as the control grid of the triode and as grid No. 1 of the hexode.

The constant-amplitude RF voltage is generated by the triode elements in a simple feed-back oscillator circuit. The RF voltage on the grid of the oscillator is likewise on grid No. 1 of the hexode, because

the signal input, and the mixer output circuits.

The third circuit arrangement, shown at the bottom of Fig. 52, employs a pentagrid converter tube, type 6SA7. This tube functions as both oscillator and mixer. Grid No. 1 serves as the grid for the oscillator while grid No. 2 serves simultaneously as the oscillator anode and as a shield between oscillator grid No. 1 and signal grid No. 3. For efficient shielding, grid No. 2 must be at ground RF potential, which requires that the oscillator cathode be operated at an RF difference of potential with respect to ground, as shown.

The 6SA7 is constructed with two deflecting plates connected to grid No. 2, so arranged that they collect most of the electrons which are repelled by voltage on the signal grid, No. 3, and which would otherwise fall back toward the cathode and affect the cathode current. The plates also serve to improve the shielding effect of grid No. 2 between the signal and oscillator circuits. These improvements of the 6SA7 over earlier pentagrid converters have made it possible to employ this simple, less expensive tube and circuit arrangement with reasonably satisfactory results at the FM frequencies.

Whatever tube and circuit arrangement is employed, it is important that the mixer tube furnish as much signal gain as possible and that there be a minimum of interaction between the oscillator and signal circuits. For example, adjustment of the trimmer condenser in the tuned signal input circuit should not affect the oscillator frequency.

The output voltage of the oscillator should be as large as possible without overloading the mixer and should be fairly constant over the frequency range. In the

design of the receiver, the frequency of the oscillator may be made either higher or lower than the signal frequency. Both arrangements were used in pre-war receivers.

With the oscillator frequency higher than the signal frequency, it is easier to obtain good tracking over the tuning range. In other words, it becomes possible to select coil and condenser values for the oscillator and signal circuits such that at all settings of the tuning dial the difference between the oscillator frequency and the resonant frequency of the signal circuits is equal to, or very closely approximates, the intermediate frequency of the receiver. When the oscillator frequency is lower than the signal frequency, deviation from perfect tracking is likely to be somewhat greater in a practical receiver design.

On the other hand, with the oscillator frequency lower than the signal frequency, it is easier to obtain good frequency stability from the oscillator. In broadcast reception, where the maximum transmitter deviation is 75 kc., it is found that the maximum permissible receiver oscillator drift, after the oscillator has completed its warm-up, is 10 kc. For an oscillator at a frequency of 45 mc., this represents a maximum percentage drift of .022%, whereas for an oscillator at 55 mc., 10 kc. represents a maximum drift of .018%. While the difference in these percentages appears small, it was found difficult to obtain a frequency stability in low-band receivers greater than .02%, even with temperature-compensated oscillators for home use. The majority of receivers were built with oscillators operating at the lower frequency for this reason.

A third factor which affects the choice between oscillator frequencies higher or lower than the signal frequency is the matter of image frequencies. The image frequency lies on the same side of the signal frequency as the oscillator frequency. Thus, if the factors of good tracking and high oscillator frequency stability are discounted against each other, the choice between a higher or lower oscillator frequency would be strongly influenced by the presence of interfering signals, immediately above or below the FM band.

The IF Amplifier ★ The intermediate frequency amplifier in an FM receiver, as in an AM receiver, contributes the major part of the RF gain and provides the selectivity necessary to avoid adjacent-channel interference.

From the standpoint of obtaining good selectivity and high gain per stage, a low intermediate frequency would be desirable. It would also give a more sensitive discriminator, since any given frequency deviation, such as 75 kc., becomes a comparatively large percentage of the IF frequency at the discriminator.

However, consideration of interference from signals at the image frequency demands that a fairly high intermediate fre-

quency be employed. The image frequency, which differs from the desired signal by twice the amount of the intermediate frequency, will then be effectively suppressed in the tuned RF amplifier and mixer circuits. The intermediate frequency should preferably be equal to at least one-half of the width of the FM receiver tuning band, so that all the image frequencies will lie outside the FM band. However, the intermediate frequency should not itself be a frequency on which strong signals are encountered.

In prewar broadcast receivers, the intermediate frequency most often employed was 4.3 mc. The width of the FM broadcast band, extending from 42 to 50 mc., was 8 mc., indicating that an intermediate frequency of 4 mc. would place all image frequencies outside the 42- to 50-mc. range. However, a frequency of 4 mc. was undesirable because of the possibility of interference from strong signals in the 80-meter phone band. The somewhat higher frequency of 4.3 mc. was, therefore, generally used.

Some receiver engineers have advocated the use of a still higher intermediate frequency in order to avoid any interference between two FM stations separated by the amount of the intermediate frequency. In such a case, each station may act as an oscillator for the other, and the two stations may be heard over the entire tuning range of the receiver. This condition has not been encountered frequently in the past, but may become more serious as

an intermediate frequency of 18 mc. or more would be required to obviate all possibility of experiencing this type of interference!

Whether or not such high intermediate frequencies will be employed eventually, the fact remains that the trend in receiver design is toward the use of higher intermediate frequencies.

IF Amplifier Characteristics ★ As previously explained in this Section, the band width required by FM signals is greater than that for AM signals. Fig. 53 shows a typical selectivity curve for the IF amplifier of an FM broadcast receiver. It is observed that at frequencies 75 kc. above and below resonance, the voltage reduction ratio is 2 to 1, equivalent to 6 db down. At frequencies 100 kc. removed from resonance, the ratio is 5 to 1 or about 14 db down.

This represents a considerable narrowing of the band width over the theoretical ideal of a band flat to 120 kc. above and below resonance. As previously explained, the narrowed band represents a design compromise in favor of greater gain per stage and improved adjacent-channel selectivity.

The argument in favor of such a compromise is that although the amplitude of a fully modulated FM broadcast signal will be cut down to one-half as the frequency of the signal swings toward the limit of plus or minus 75 kc., as long as the least amplitude of the signal is sufficient

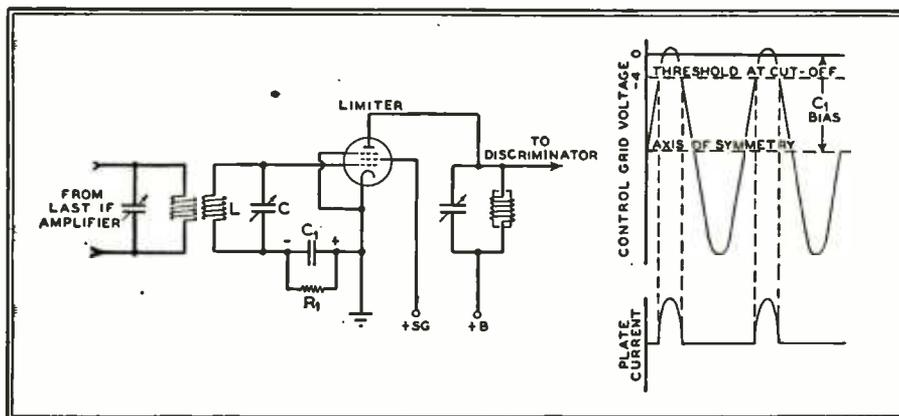

FIG. 55. ONE-STAGE AMPLITUDE LIMITER CIRCUIT, SHOWING HOW GRID LEAK BIAS ALLOWS GRID TO SWING TO ONLY A SLIGHTLY POSITIVE VALUE

additional stations are put into operation. While the use of a tuned RF amplifier and the choice of an intermediate frequency having an odd number of tenths of a megacycle will tend to minimize this type of interference, the more effective solution would lie in having the intermediate frequency equal to at least the entire width of the FM band, assuming that excessively strong signals are not present in the spectrum area adjacent to the band. For the 42- to 50-mc. band, an intermediate frequency of at least 8 mc. was found necessary to avoid this type of spurious response. With the wider band assigned to postwar FM broadcasting,

to saturate the limiter, the amplitude variations will be removed by the limiter.

A point not so frequently considered is the fact that as the frequency swings into the curved regions of the IF amplifier selectivity curve, the currents and voltages in the band pass circuits undergo a shift of phase as well as a variation of amplitude. For a given deviation of the signal frequency during modulation, the rate of change of phase in the band pass circuits is proportional to the modulating frequency. In other words, the band pass circuits introduce a variation in the frequency of the signal currents, in addition to the frequency variation due to modula-

tion, that is proportional to the modulating frequency.

This frequency variation is too small to be of consequence at low modulating frequencies, but as the modulating frequency is increased, the time rate of phase change in the tuned circuits is increased, meaning that the frequency variation superimposed on the FM signal by the tuned circuits is increased. These frequency variations produce amplitude distortion at the receiver output. For example, when the signal is fully modulated at 5,000 cycles, distortion in excess of 2% will be caused by phase shifts in an IF amplifier having a characteristic that is down 6 db at frequencies 75 kc. above or below resonance.

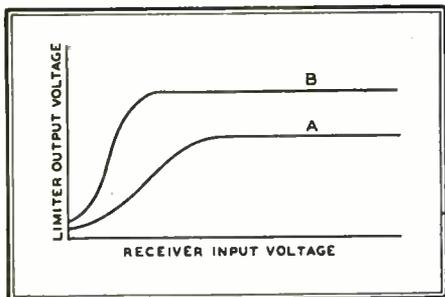

FIG. 56. CHARACTERISTICS OF ONE- AND TWO-STAGE LIMITERS

Set designers particularly interested in obtaining the highest degree of fidelity over the entire audio range are inclined to favor an IF characteristic in which the signal is down only 1 or 2 db at 75 kc. deviation, although it is more difficult to obtain adequate RF gain with the broader band. The broader selectivity curve also allows signals whose level is somewhat below limiting to be received without distortion, thus increasing the usable sensitivity of the set in locations where the noise level is very low.

As shown in Fig. 54, the wiring diagram of the IF amplifier of an FM superheterodyne is fairly conventional. It will be noted that loading resistors may be used across the coils to broaden the characteristics of the band pass circuits. These resistors may range in value from 10,000 to 100,000 ohms. Decoupling circuits are employed in both the screen and plate circuits to improve the stability of the high gain amplifier.

Three stages of IF amplification are all that can be used at these frequencies without encountering instability. Experience indicates that, from the production standpoint, the maximum gain that can be safely obtained in the mixer and IF amplifier is about 70,000. The RF amplifier is required to furnish the remainder of the RF gain necessary to bring the weakest signal it is desired to receive up to a level that will saturate the limiter.

The Limiter ★ From the standpoint of the reduction of noise and interference, the

limiter stage is the most important component of the FM receiver, because all types of FM detector circuits are responsive to amplitude as well as frequency variations of the detector input voltage, during the reception of FM signals.

With a really effective limiter located immediately ahead of the detector, and with sufficient RF amplification in the receiver to raise the signal level up to that necessary to obtain limiting action, amplitude variations due to noise and interference will be removed, and the detector output voltage will vary only in proportion to the frequency variation of the signal at the output of the IF amplifier.

Fig. 55 shows a simple one-stage limiter of the grid leak type, employing a 6SJ7 or similar tube. The tube is operated with low plate and screen grid voltages so that cut-off occurs with relatively small grid bias, such as -4 volts.

The control grid and cathode of the limiter tube act as a diode rectifier, so that with the grid driven only slightly positive with respect to the cathode, a charge is stored in the grid condenser C_1 , Fig. 55, such that the DC voltage across C_1 is very nearly equal to the amplitude of the IF voltage across the tuning condenser C . Thus the voltage set up by the charge in C_1 increases and decreases with the amplitude of the input voltage across tuning condenser C , thereby biasing the grid negatively to the amount necessary to prevent the grid from swinging more than slightly positive, regardless of how the amplitude of the input voltage varies.

The characteristic curve of a single-stage limiter is shown at A in Fig. 56. It is essential that the horizontal portion of the input characteristic be flat, and it is desirable that the horizontal portion extend to a low value of input voltage, so that a more definite limiting action will set in at low signal levels. Curve B of Fig. 56 shows the improvement obtained by the use of a two-stage limiter, also known as the dual or cascade limiter.

The circuits of two types of two-stage limiters are shown in Fig. 57. Both stages in each of these limiters are of the grid-leak type, the grid leaks being shunted from grid to ground rather than across the grid condenser as in Fig. 55. The operation of each of the limiter stages is like that of the single-stage limiter, the second stage simply serving to remove any small residual amplitude variations remaining in the output of the first limiter, thus flattening the characteristic and extending it down to lower input voltages. The lower circuit differs from the upper by having a tuned circuit for coupling between the limiters rather than a resistor. This is a more expensive arrangement but gives somewhat improved performance.

The time constants of the grid-condenser and grid-leak combinations in the limiter are of considerable importance in the suppression of impulse noise. The time constant is a means of stating the rate at which a condenser will discharge through a resistance. Theoretically such a discharge continues indefinitely because as the discharge takes place the condenser

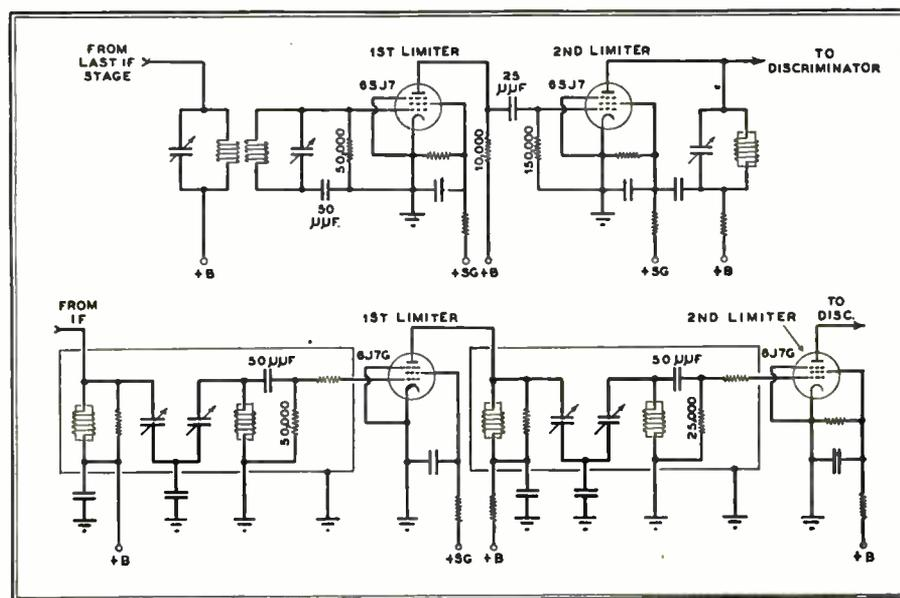

FIG. 57. CIRCUITS OF TWO TYPICAL TYPES OF DUAL LIMITERS

The result, as shown at the right in Fig. 55, is that the plate current varies between two fixed levels, namely, that corresponding to a slightly positive grid voltage and that of cut-off, regardless of variations in excitation voltage across tuning condenser C , assuming only that its peak amplitude is in excess of the 4 volts necessary to give cut-off

voltage falls off, reducing the discharge current and prolonging the discharge period. Practically, in most RC circuits, the discharge current falls to a less than measurable value in a short period of time, the discharge time being greater when the condenser capacity is large or the resistance of the discharge path is high or both.

The time constant is defined as the amount of time required for the voltage of a condenser discharging through a resistance to fall off to 36.8% of its initial value. The time constant in seconds is equal to the product of the condenser capacity in farads and the grid leak resistance in ohms. The time constants in the limiter circuits should not exceed 10 microseconds, shorter time constants being indicated when automobile ignition interference is anticipated. The time constants of the grid-leak and grid-condenser combinations of the circuits in Fig. 57 range from 1.25 to 4 microseconds.

Short time constants make it possible for the grid bias to follow, almost instantaneously, an impulse so phased as to remove the signal voltage from the grid. Thus the time required to recover normal bias is less than the time of one cycle at the highest audio frequency, and the grid leak bias system does not increase the amplitude nor prolong the effect of an individual impulse. However, since the grid-leak limiter operates from an artificial threshold that is near the positive peak of the input signal, as shown in Fig. 55, it is sensitive to more and smaller impulses than would affect an ideal limiter whose threshold corresponds to the axis of symmetry of the signal voltage.

When two tubes are used in cascade, it becomes possible to rearrange the limiter circuit so that the condition of such an ideal limiter is approached. In Fig. 58, there is no self bias on the first 7C7, and the plate and screen voltages are so chosen that the plate current drops to cut-off when the instantaneous value of the input signal is more than 1 volt negative. The

tive voltage to the second tube. Thus both peaks are limited while the threshold is maintained near the axis of symmetry of the input signal, so that this limiter is responsive to but few small impulse peaks.

By a proper choice of the resistors R_1 and R_2 , it is also possible in this limiter circuit to obtain some decrease in the out-

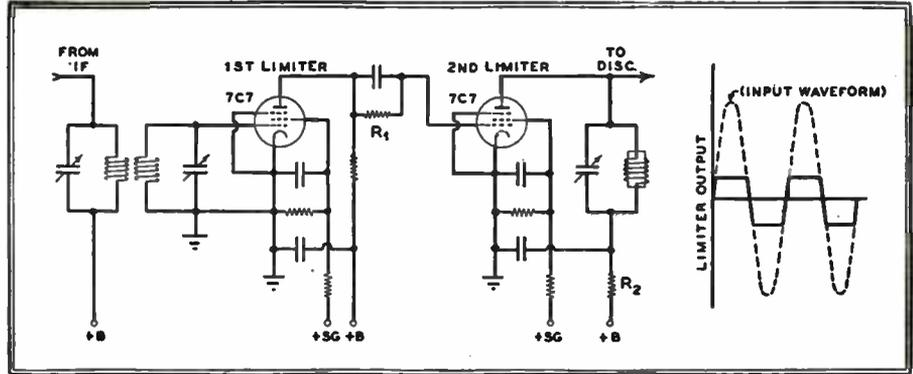

FIG. 58. CIRCUIT NOT EMPLOYING GRID LEAK IN THE FIRST STAGE. RIGHT, CURVE SHOWING THE INPUT WAVE FORM AND RESULTING OUTPUT

positive peak of signal voltage is reproduced without limiting in the first tube, but by means of resistance coupling, it is reversed in phase and applied as a nega-

put sensitivity when there are no input signals strong enough to suppress the noise, so that a partial squelch is obtained while tuning from one station to another.

GENERAL FM THEORY

SECTION 7: FM RECEIVERS CONTINUED. DISCRIMINATORS AND RATIO DETECTORS, AUDIO SYSTEMS, DE-EMPHASIS, SQUELCH, OTHER SPECIAL CIRCUITS

IN THE preceding section, it was shown that a conventional triode AM detector can be made to respond to FM signals by detuning the tuned input circuit slightly, so that operation occurs on the steep and nearly linear portion of the selectivity curve of the input circuit, either above or below the resonant frequency. The principle involved is that as the frequency of the FM signal swings *toward* the resonant frequency of the tuned circuit, the current in the tuned circuit and the voltage across the tuning condenser increases, and as the frequency of the FM signal swings *away from* the resonant frequency of the tuned circuit, the current in the tuned circuit and the voltage across the tuning condenser decreases. In this way the selectivity characteristic of the tuned circuit serves to translate the *frequency* variations of the FM signal into *amplitude* variations of the voltage across the tuning condenser, so that the detector responds to the FM signal.

It was pointed out, however, that the detuned AM triode detector would not be suitable for use in a high fidelity FM receiver because 1) it is incapable of handling strong signal voltages without introducing distortion, 2) the detuning adjustment, for operation at the mid-point of the most nearly linear portion of the selectivity characteristic, is quite critical, and 3) even at the optimum detuning adjustment, there is some departure from true linearity in the detector output, causing harmonic distortion. This distortion would be particularly severe on strongly modulated FM signals, where the frequency swings over a wide range.

The problem of overloading encountered with triode detectors can be obviated by using a diode detector. In so doing, the advantage of obtaining amplification in the detector is lost, but the amplification can be readily made up in the stages preceding and following the detector. By using a detector which has the property of rectification only, a much higher order of signal voltages can be handled without introducing distortion. Practically all modern FM broadcast receivers employ diode detectors.

The problem of critical detuning adjustment, and the problem of distortion resulting from operation at the curved portions of the characteristic arise from the fact that the characteristic is practically linear over only a narrow range of frequencies. The solution to these problems would seem to lie either in 1) using a system of coupled tuned circuits in the detector that will give an overall characteristic that is approximately linear over a much wider frequency range, or 2) devising a system of FM detection which does

not depend in any way upon the selectivity characteristics of tuned circuits.

The solution which lends itself more readily to FM receiver design is that in which tuned circuits are coupled in such a way as to give a straight-line characteristic over a wide frequency range. Detectors of this type usually employ two diodes arranged to deliver an output voltage whose polarity depends upon whether the applied frequency is higher or lower than the mean frequency of the input tuned circuits, and whose amplitude depends on the extent by which the applied frequency differs from the mean frequency. Since these detectors are able to discriminate between frequencies above and below the mean frequency of the coupled tuned circuits, they are called *discriminators*.

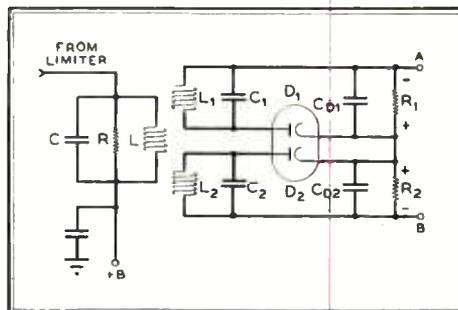

FIG. 59. DETUNED-CIRCUIT TYPE OF DISCRIMINATOR CIRCUIT

Two types of discriminator circuits have been employed in receiver design, namely the detuned-circuit discriminator and the center-tuned discriminator. Both of these types were employed originally in AM receivers for automatic frequency control, but since they can be adjusted to give an overall characteristic having a uniform slope over a relatively wide frequency range, they are especially suited for use as FM detectors.

De-tuned Circuit Discriminator * The circuit diagram of the detuned-circuit discriminator, or amplitude discriminator, is shown in Fig. 59. The limiter output circuit LC is tuned to the intermediate frequency F_C of the superheterodyne receiver. The input circuit L_1C_1 for diode detector D_1 is inductively coupled to LC but is resonant to a frequency F_{R1} , somewhat *lower* than the intermediate frequency F_C of the FM receiver. The input circuit L_2C_2 for diode detector D_2 is also inductively coupled to LC but is resonant to a frequency F_{R2} , somewhat *higher* than the intermediate frequency F_C of the FM receiver. The coefficients of coupling of circuits L_1C_1 and L_2C_2 to circuit LC are equal, and each circuit is detuned from the resonant frequency of LC by the same amount.

If a signal current, modulated or unmodulated, flows in the tuned circuit LC, the expanding and contracting field about L induces equal voltages in coils L_1 and L_2 , because of the equal degree of coupling.

When the signal is unmodulated and has a frequency equal to the resonant frequency of circuit LC, then the amplitude of the RF currents in the detuned circuits L_1C_1 and L_2C_2 , set up by the induced voltages, will be essentially equal and the RF voltages established across the tuning condensers C_1 and C_2 will also be equal. Thus, the DC voltages produced across R_1C_{D1} and R_2C_{D2} by the diodes, which are very nearly equal to the respective amplitudes of the RF voltages across C_1 and C_2 , will be essentially equal to each other. As shown in Fig. 59, the diode connections are such as to place the two DC output voltages of the diodes in opposite polarity between the discriminator output terminals A, B. Thus, zero *net* voltage is produced across terminals A, B of the discriminator when it is excited by an unmodulated signal at the resonant frequency of the tuned circuit LC, that is, at a frequency mid-way between the resonant frequencies of tuned circuits L_1C_1 and L_2C_2 .

When the signal is frequency-modulated, its frequency is alternately increased and decreased with respect to the average or center frequency. If the center frequency of the FM signal is equal to the resonant frequency of LC, then, during the period when the instantaneous frequency of the FM signal is greater than its center frequency, the RF voltage established across the tuning condenser C_1 is decreased because the frequency of the voltage induced in L_1C_1 circuit is farther from the resonant frequency of that circuit. Conversely, when the instantaneous frequency is less than the center frequency, the RF voltage across C_1 is increased, because the applied frequency is nearer to the resonant frequency of L_1C_1 .

This action is illustrated in Fig. 60. Here the FM signal is shown at the lower left and its frequency is shown as a function of time to the right of the signal. The frequency curve is projected upwards against the characteristic curve for the RF voltage across condenser C_1 . Since the DC voltage established across R_1C_{D1} is very nearly equal to the amplitude of the RF voltage across C_1 , this curve also represents the output voltage of diode D_1 as a function of the input frequency. It is observed that as the frequency of the input signal is increased during the first alternation of modulation, the frequency of the voltage induced in L_1 is farther from resonance and the DC output voltage across R_1C_{D1} is decreased. In the second

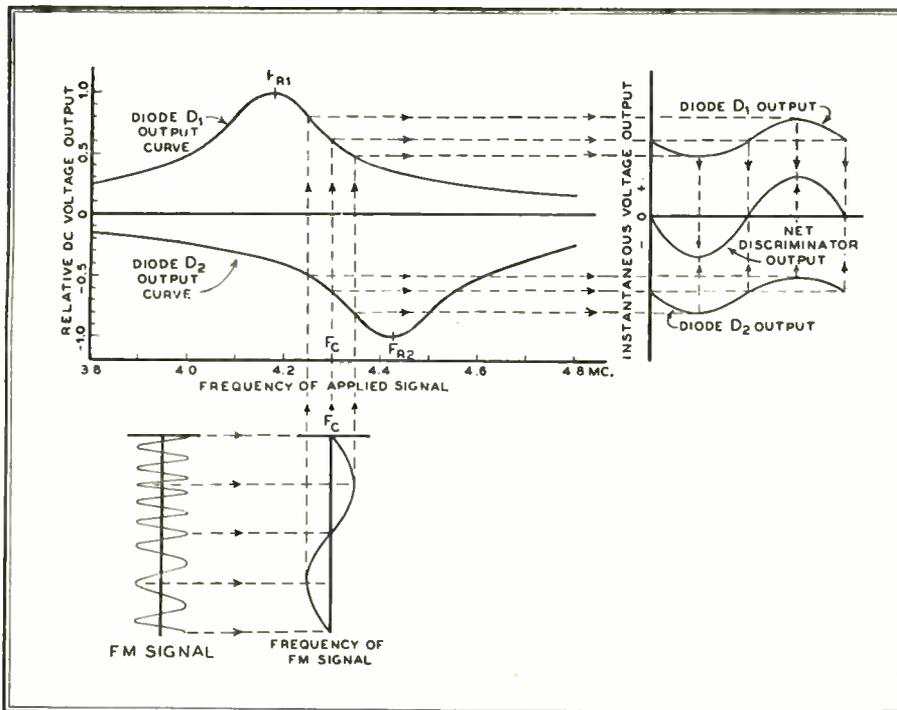

FIG. 60. DETECTION OF FM SIGNAL IN DETUNED-CIRCUIT DISCRIMINATOR. THE INDIVIDUAL DIODE OUTPUT VOLTAGES COMBINE TO PRODUCE AN AUDIO VOLTAGE HAVING THE SAME WAVE FORM AS THE MODULATING VOLTAGE AT THE TRANSMITTER

alternation of the modulation, where the instantaneous frequency of the voltage induced in coil L_1 is nearer to the resonant frequency of L_1C_1 than the center frequency, the DC output voltage across R_1C_{D1} is increased. The wave form of the output voltage variation of diode D_1 is shown at the upper right in Fig. 60.

Since the tuned circuit L_2C_2 of diode D_2 is resonant to a frequency F_{R2} that is higher than the center frequency F_C of the input signal, the selectivity curve for the tuned circuit L_2C_2 would occupy a position to the right of the curve for tuned circuit L_1C_1 in Fig. 60. However, since the characteristic being plotted is that of the DC output voltage of diode D_2 rather than the amplitude of the RF voltage across tuning condenser C_2 , the curve is plotted in the negative direction from the horizontal axis to take into account the opposite polarity of the DC output voltage of diode D_2 .

It is observed in Fig. 60 that in the case of diode D_2 , an increase in the instantaneous frequency during modulation produces an increase in the magnitude of the negative voltage developed across R_2C_{D2} . A decrease in the instantaneous frequency during modulation produces a decrease in the magnitude of the negative voltage across R_2C_{D2} . The variation of the output voltage of diode D_2 during modulation is shown at the right of the negative characteristic curve for diode detector D_2 .

The output voltage of the discriminator is the algebraic sum of the positive and negative output voltages, respectively, of diodes D_1 and D_2 from instant to instant. The curve of the net discriminator output voltage is shown in Fig. 60 between the

curves for the individual diode output voltages. It is observed that the DC components of the individual diode voltages have been balanced out and that an audio

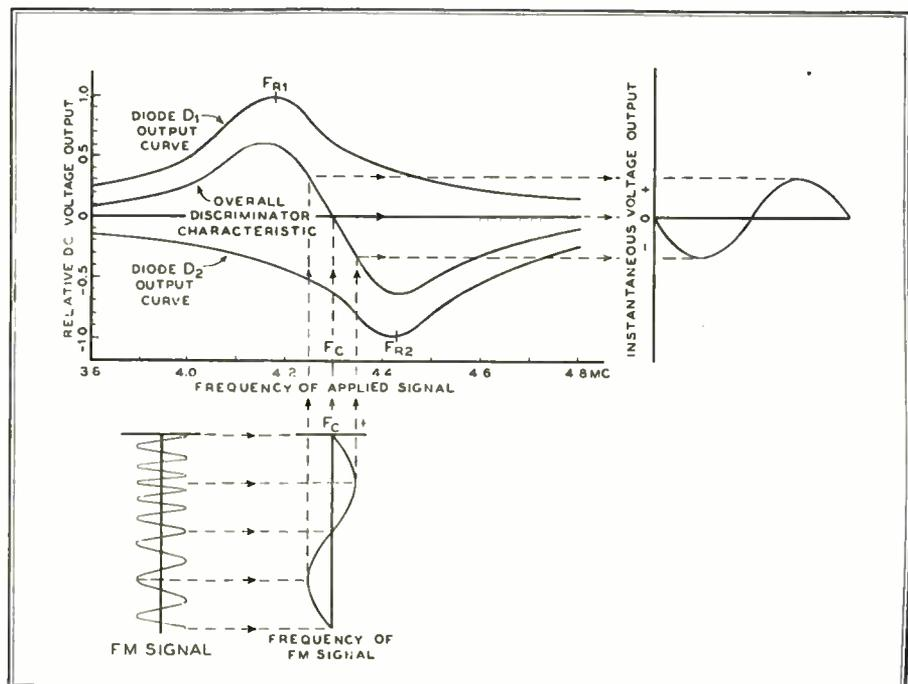

FIG. 61. THE OVERALL CHARACTERISTIC OF THE DISCRIMINATOR IS PLOTTED BY ADDING THE DIODE OUTPUTS ALGEBRAICALLY AT EACH FREQUENCY. THE COMPOSITE CHARACTERISTIC IS ESSENTIALLY LINEAR OVER A WIDE FREQUENCY RANGE

voltage is delivered by the discriminator which has an amplitude roughly twice that of the audio components of the individual diode output voltages.

The marked improvement in the quality of FM detection, obtained by combin-

ing the outputs of two detuned detectors in pushpull in the manner described above, is made evident by comparing the overall characteristic of the discriminator with the curves of the individual diode detectors, as shown in Fig. 61. Here the curves for the individual detectors are the same as those shown in Fig. 60, but the composite characteristic has been plotted by taking the algebraic sum of the positive and negative diode voltages at each frequency.

It is observed that the composite characteristic for the discriminator is essentially linear over a much wider frequency range than either of the individual diode detector characteristics. Thus the discriminator can be made to deliver essentially distortionless audio voltage on strongly modulated FM signals and requires only moderate care in tuning the receiver.

As shown in Fig. 59, the primary circuit LC should be loaded by means of shunt resistance R so that the effective ratio of reactance to resistance, or Q , of the primary is about one-third of the ratio of the resonant frequency of the primary circuit to the maximum frequency deviation of the signal to be detected. The Q of the secondary circuits L_1C_1 and L_2C_2 should be twice that of the primary circuits. The diodes serve to load the secondary circuits. The secondary coils L_1L_2 are so placed that each has a coupling to the

primary coil L much greater than their coupling to each other.

It is evident from Fig. 61 that the linearity of the discriminator depends not only upon the sharpness of the selectivity curves of the tuned circuits, as deter-

mined by their respective Q 's, but upon the separation of the resonant frequencies of the circuits as well.

The condition for best linearity is that at which the resonant frequencies of the tuned circuits L_1C_1 and L_2C_2 are separated by 1.225 times the band width between the half-power points (or 70.7%-voltage points) on the curves of the tuned circuits. The band width between half-power points, in turn, is equal to the resonant frequency of each circuit divided by its Q . Fig. 61 illustrates the condition for best linearity.

Center-Tuned Discriminator ★ The circuit of the center-tuned or phase discriminator is shown in Fig. 62. In this circuit only two tuned circuits are employed and both are resonant to the intermediate frequency of the receiver. As will be explained presently, the signal voltage is conveyed from the limiter output circuit to the discriminator circuit by direct and inductive coupling. The diode detectors are connected in pushpull across the center-tapped secondary coil. By careful adjustment of the tuning and coupling it is possible to obtain the same overall characteristic as is shown for the detuned-circuit discriminator in Fig. 61.

The operation of the center-tuned discriminator depends upon the change that occurs in the phase relations of the voltages in the tuned circuits as the applied signal frequency varies from the resonant frequency of the tuned circuits during modulation. It is first necessary, therefore, to consider the phase relations of the voltages and currents in coupled tuned circuits for conditions of resonance and non-resonance.

Consider the coupled tuned circuits L_1C_1 and L_2C_2 at the upper left in Fig. 63. If an RF voltage E_1 is present across L_1C_1 , the resulting current I_1 that flows in the turns of coil L_1 will lag voltage E_1 by nearly 90° , since the reactance of coil L_1 very greatly exceeds its resistance.

This relationship is shown in the top row of three vector diagrams in Fig. 63, representing, from left to right, the conditions of operation at resonance, above resonance, and below resonance. The vector for voltage E_1 serves as a reference, and is assigned the position representing 0° in each of the three diagrams. The vector representing current I_1 is 90° clockwise from, or lagging, the applied voltage vector E_1 .

The current I_1 in the turns of coil L_1 creates a magnetic field about L_1 that expands, collapses, and changes polarity in phase with the increase, decrease, and reversal of the RF current in coil L_1 . The vector for current I_1 can, therefore, also be regarded as representing the field about coil L_1 .

The expanding and collapsing field about L_1 sweeps the turns of L_2 and induces therein a voltage E_2 proportional at every instant to the *rate* at which the

lines of force of the field above L_1 are cutting the turns of coil L_2 . When the field about L_1 is changing most rapidly, that is, when the current in coil L_1 is falling through zero, the voltage E_2 induced in coil L_2 is at a peak. On the other hand, at the instant when the field about L_1 has reached a condition of maximum expansion and is about to contract, its *rate of change* is zero and zero voltage is induced in coil L_2 .

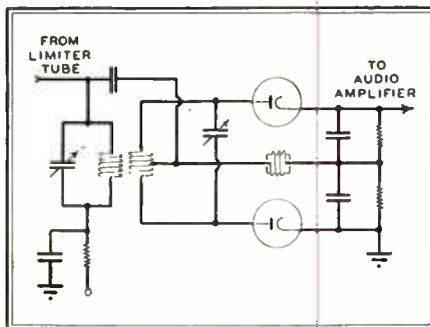

FIG. 62. CENTER-TUNED TYPE OF DISCRIMINATOR CIRCUIT

Thus the voltage induced in coil L_2 is 90° out of phase with the inducing field and inducing current I_1 . This is shown in the top row of vector diagrams in Fig. 63, where the vector for the induced voltage E_2 appears at a position 90° clockwise from, or lagging, the vector for the inducing current I_1 .

It is very important to note that the voltage E_{AB} which appears across the tuning condenser C_2 is *not* the induced voltage E_2 . As shown in the diagram of the equivalent circuit, the induced voltage E_2 simply acts as a generator in series with coil L_2 and tuning condenser C_2 , causing a current I_2 to flow in circuit L_2C_2 which establishes a *reactive voltage drop* E_{AB} across the tuning condenser C_2 . Since the condenser C_2 offers a practically pure capacitive reactance, the voltage E_{AB} across condenser C_2 will lag the current I_2 by very nearly 90° , regardless of whether the circuit is resonant or non-resonant to the applied frequency.

At resonance, the reactances of L_2 and C_2 cancel each other and the current I_2 in the secondary circuit is in phase with the induced voltage E_2 . This is shown in the vector diagram for the resonant condition which appears just to the right of the tuned circuits at the top of Fig. 63. It should be observed that the vector for current I_2 coincides with that for induced voltage E_2 . The reactive voltage E_{AB} across tuning condenser C_2 is 90° lagging the current I_2 . As shown in the vector diagram, at resonance the voltage E_{AB} across tuning condenser C_2 differs in phase by 90° with respect to the reference voltage E_1 applied across circuit L_1C_1 .

Consider next the phase relations which exist when the applied frequency F_A exceeds the resonant frequency F_R of the tuned circuits. At the higher frequency,

the inductive reactance of L_2 exceeds the capacitive reactance of C_2 , thereby causing the current I_2 in circuit L_2C_2 to lag the induced voltage E_2 . This is shown in the center vector diagram at the top of Fig. 63. The vector for current I_2 lags the vector for the induced voltage E_2 by an acute angle. The reactive voltage E_{AB} across tuning condenser C_2 lags current I_2 by the fixed angle of 90° . As a result, the voltage E_{AB} differs in phase from the reference applied voltage E_1 by *less than* 90° .

Conversely, when the applied frequency F_A of voltage E_1 is less than the resonant frequency F_R of circuits L_1C_1 and L_2C_2 , current I_2 in circuit L_2C_2 leads the induced voltage E_2 , as shown in the vector diagram at the top right of Fig. 63. This causes the voltage E_{AB} across condenser C_2 to differ in phase with respect to the reference input voltage E_1 by *more than* 90° .

Consider next the voltages that will be obtained when a center tap is placed on coil L_2 , as shown in Fig. 63. Since the voltage at terminal A with respect to terminal B of the tuned circuit L_2C_2 is shown by vector E_{AB} in the top row of vector diagrams, then the voltage at terminal A with respect to the center-tap terminal C is shown by vector E of half the length in the second row of vector diagrams. The angular position of vector E_{AC} in the second row of vector diagrams is the same as that of vector E_{AB} in the top row.

The voltage of the *center-tap terminal C with respect to the lower terminal B* or voltage E_{CB} could also be represented by a vector in the position of vector E_{AC} . However, the voltage of *lower terminal B with respect to center-tap terminal C*, or voltage E_{BC} , is a voltage taken in the opposite direction and must be represented by a vector having the opposite polarity from vector E_{AC} , as shown in the second row of vector diagrams.

As the next step, a condenser C_C is connected between the high potential terminal of circuit L_1C_1 and the center-tap terminal C of tuned circuit L_2C_2 , as shown at the left of the third row of vector diagrams in Fig. 63. At the same time, an RF choke RFC is connected between center-tap terminal C and terminal D. Terminal D is held at ground RF potential by condenser C_{D2} . The reactance of RFC at the applied frequency is too high to affect appreciably the tuning of circuit L_1C_1 across which it is shunted. The reactances of C_C and C_{D2} are quite low at the applied frequency. Thus the voltage E_1 across L_1 also appears across RF choke RFC, with practically no change in magnitude or phase. Hence, the vector E_{CD} in the third row of vector diagrams is drawn in the same position as vector E_1 in the first row.

The final step in the evolution of the discriminator circuit is the connection of two diode detectors at terminals A, D, B. The output circuits of the detectors are connected in pushpull as shown.

Diode D_1 is connected to terminals A and D so that the voltage applied to the diode D_1 is the sum of voltages E_{AC} and E_{CD} . The voltage applied to the lower diode D_2 is the sum of voltages E_{BC} and E_{CD} , since this diode is connected to terminals B and D.

The sums of these respective pairs of voltages are obtained vectorally by completing the parallelograms and drawing in the diagonal resultants, as shown in the bottom row of vector diagrams in Fig. 63.

for E_{CD} than the vector for E_{BC} . As a result, the sum vector E_{AD} has a greater magnitude than the sum vector E_{BD} . Therefore diode D_1 delivers a greater DC voltage than diode D_2 . With the diode DC output voltages adding in opposite polarity, the net voltage delivered by the discriminator is positive when the applied frequency exceeds the resonant frequency.

Conversely, when the applied frequency is less than the resonant frequency, the voltage E_{AC} differs in phase from voltage

nately positive and negative. This is the case when an FM signal is tuned in, so that the discriminator produces an audio voltage having the same wave form as the audio modulating voltage at the FM transmitter.

Readers unfamiliar with vector diagrams will understand the operation of the discriminator by reference to the wave diagrams shown in Fig. 64. The left hand column of wave diagrams applies to the condition of resonance. The voltage E_{CD}

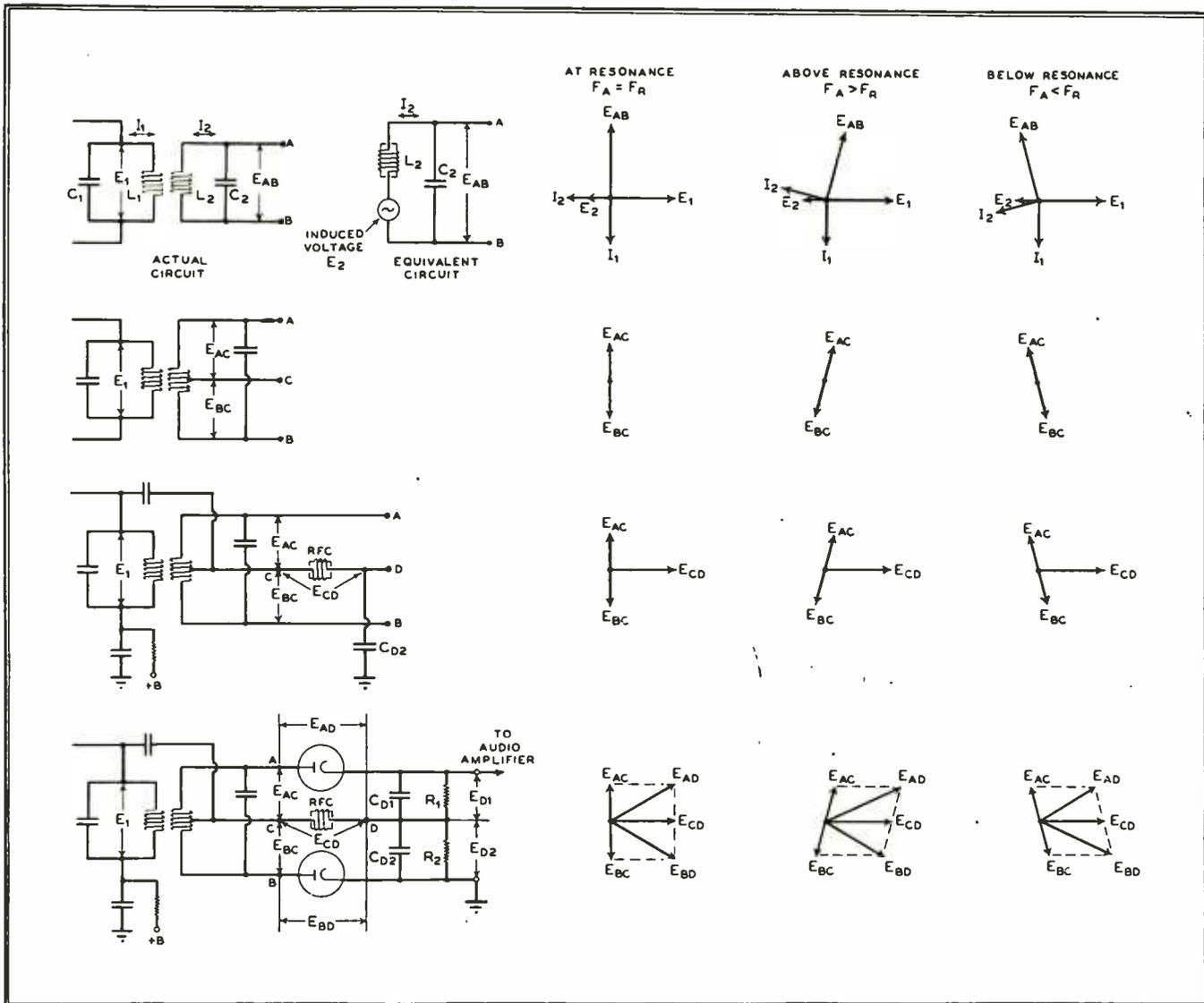

FIG. 63. EVOLUTION OF THE CENTER-TUNED DISCRIMINATOR CIRCUIT. STARTING WITH THE SIMPLE COUPLED TUNED CIRCUITS, TOP LEFT: CIRCUIT ELEMENTS ARE PROGRESSIVELY ADDED UNTIL THE COMPLETE DISCRIMINATOR CIRCUIT IS OBTAINED. PHASE RELATIONS OF VOLTAGES AND CURRENTS ARE SHOWN IN THE VECTOR DIAGRAMS TO THE RIGHT OF EACH CIRCUIT

At resonance, where a 90° difference of phase exists between the directly coupled voltage E_{CD} and the reactive voltages E_{AC} and E_{BC} , the resultant or sum vectors E_{AD} and E_{BD} are of equal magnitude. At resonance, therefore, the individual diode output voltages E_{D1} and E_{D2} are equal, and since they are added in opposite polarity the net output voltage of the discriminator is zero.

When the applied frequency F_A exceeds the resonant frequency F_R , the vector representing E_{AC} lies closer to the vector

E_{CD} by more than 90° , while voltage E_{BD} differs in phase from voltage E_{CD} by less than 90° . As a result, the sum voltage E_{BD} has a greater magnitude than the sum voltage E_{AD} , as shown in the vector diagram at the lower right of Fig. 63. Diode D_2 delivers a greater DC voltage than diode D_1 and the net output voltage of the discriminator is negative.

If the frequency of the applied signal is alternately greater and less than the resonant frequency of the discriminator, the discriminator output voltage is alter-

nately positive and negative. This is the case when an FM signal is tuned in, so that the discriminator produces an audio voltage having the same wave form as the audio modulating voltage at the FM transmitter.

Since the tuned circuit L_2C_2 , Fig. 63, is operating at resonance, the reactive voltages E_{AC} and E_{BC} established across coil L_2 will respectively lead and lag the limiter output voltage E_{CD} by 90° . The voltage waves of E_{AC} and E_{BC} are shown immediately above and below the wave of E_{CD} in Fig. 64. It is noted that the three waves have the same frequency but

there are 90° phase displacements between them. When the wave of E_{AC} is added to that of E_{CD} from instant to instant, the resultant is a wave E_{AD} of

nant frequency F_R of the tuned circuits is shown in the center column of waves in Fig. 64. In this case, the voltage E_{AC} across the upper half of the tuned circuit

put voltage should be proportional at every instant to the frequency deviation of the signal being received. By careful circuit design and coupling adjustments, the characteristic of the tuned-circuit discriminator can be made linear over a wide frequency range, similar to the characteristic of the detuned-circuit discriminator shown in Fig. 61.

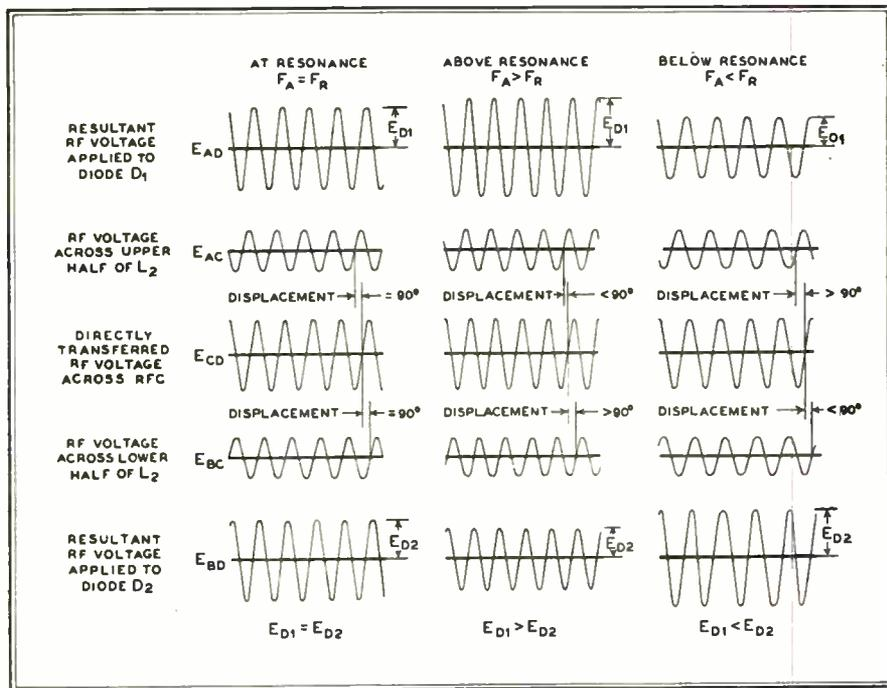

FIG. 64. WAVE DIAGRAMS OF VOLTAGES IN THE CENTER-TUNED DISCRIMINATOR CIRCUIT. THE VOLTAGES ARE TAKEN AT THE POSITIONS SHOWN IN THE CIRCUIT DIAGRAM: BOTTOM LEFT, FIG. 63

greater amplitude than E_{AC} , shown at the top left in Fig. 64. Similarly, E_{BC} added to E_{CD} yields a wave E_{BD} of greater amplitude than E_{BC} , shown at the bottom left in Fig. 64. Since the two waves E_{BC} and E_{CD} added to E_{CD} are equally displaced in phase from E_{CD} , equal reinforcements of E_{CD} are obtained from the addition. The amplitude of the sum resultant voltage E_{AD} equals that of the sum resultant voltage E_{BD} . When these voltages are applied to diodes D_1 and D_2 , equal DC output voltages E_{D1} and E_{D2} are obtained. Since these diode output voltages of equal magnitude are added in opposite polarity, the discriminator out-

L_2C_2 leads the directly coupled voltage E_{CD} by less than 90°, while the voltage E_{BC} across the lower half of the tuned circuit L_2C_2 lags the directly coupled voltage E_{CD} by more than 90°.

When E_{AC} is added to E_{CD} , the amplitude of the sum voltage E_{AD} is found to be greater than the amplitude of the sum voltage E_{BD} , obtained when E_{BC} is added to E_{CD} . This is to be expected, since E_{AC} is more nearly in phase with E_{CD} than E_{BC} and, therefore, affords greater reinforcement of E_{CD} than E_{BC} . Since the voltage E_{AD} has a greater amplitude than E_{BD} , diode D_1 delivers a greater output voltage than diode D_2 and the net discriminator output voltage is positive.

Conversely, when the applied frequency F_A is less than the resonant frequency F_R , the phase displacement between E_{AC} and E_{CD} is greater than 90°, while that between E_{BC} and E_{CD} is less than 90°. This condition is shown in the right hand column of waves in Fig. 64. E_{BC} offers a greater reinforcement of E_{CD} than E_{AC} , so that E_{BD} exceeds E_{AD} . As a result, diode D_2 delivers a greater DC voltage than diode D_1 and the discriminator output voltage is negative.

During the reception of an FM signal whose center frequency equals the resonant frequency of the tuned circuits, the discriminator output voltage changes polarity as the frequency alternately exceeds or is less than the center frequency. The magnitude of the discriminator out-

put voltage should be proportional at every instant to the frequency deviation of the signal being received. By careful circuit design and coupling adjustments, the characteristic of the tuned-circuit discriminator can be made linear over a wide frequency range, similar to the characteristic of the detuned-circuit discriminator shown in Fig. 61.

Counter-Circuit FM Detector ★ While the use of discriminator circuits, as described above, presents a convenient and practical means for detecting FM signals of relatively large frequency deviation with minimum distortion, there are a number of other methods for detecting FM signals. For example, it has been suggested previously in this section that a solution to the problem of overcoming the inherent non-linearity of tuned-circuit detectors might lie in the use of a detection system whose operation does not depend in any way upon tuned circuits. The counter-circuit shown in Fig. 65 is an FM detector of this type. Because of its very low distortion, it has been employed in precision FM monitors for checking FM modulation systems.

The first tube in the circuit shown in Fig. 65 is a beam pentode, operating with a low value of load resistance, R_L , adjusted to give plate-current saturation when the excitation voltage is not quite sufficient to draw grid current. The excitation voltage has a center frequency in the order of 100 to 300 kc. and its peak-to-peak value is at least 20% greater than the cut-off bias of the beam pentode. The plate current of the pentode swings between cut-off and saturation level, as determined by the pentode characteristic. The pentode therefore squares off the positive and negative peaks of the plate current variation, and delivers a square wave pulse of practically uniform amplitude at the frequency of the excitation signal, regardless of any amplitude fluctuations that are present in the excitation signal.

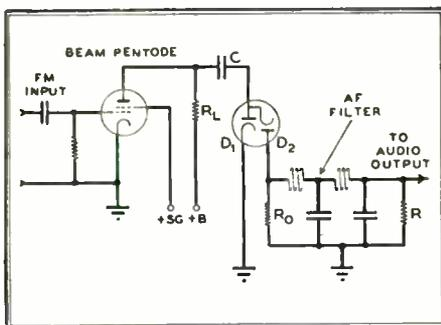

FIG. 65. COUNTER CIRCUIT TYPE OF FM DETECTOR

put is zero when the applied frequency F_A equals the resonant frequency F_R .

The voltages for the condition of applied frequency F_A exceeding the reso-

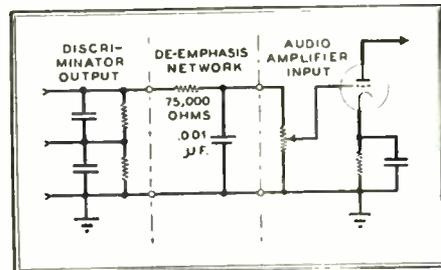

FIG. 66. POSITION OF DE-EMPHASIS NETWORK IN FM RECEIVER

The peak value of the output voltage pulse of the pentode is equal to the plate supply voltage, because there is zero drop in resistor R_L during the interval when the plate current is cut off. During the interval when the voltage pulse is maximum positive, condenser C therefore charges through the low cathode-to-plate resistance of diode D_1 to a voltage very

nearly equal to the plate supply voltage. During the interval when the pentode output voltage is minimum positive, the charged condenser C cannot discharge through diode D_1 because the cold plate of diode D_1 does not emit electrons. Condenser C will discharge through the cathode-to-plate path of diode D_2 and R_0 to ground. The capacity of the condenser C and the resistances of the charge and discharge paths are so small that the condenser acquires a voltage of at least 99.9% of the plate supply voltage by the

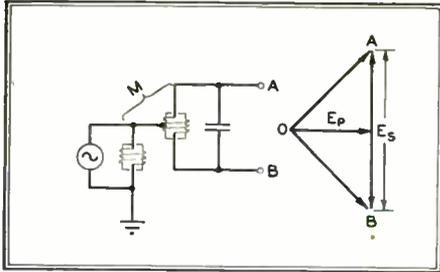

FIG. 65A. BASIC DISCRIMINATOR CIRCUIT

end of the charge interval and discharges to within 0.1% of the minimum voltage at the pentode plate by the end of the discharge interval. Since the condenser voltage varies over a fixed range, the number of electrons moved through resistor R_0 during each discharge period is fixed. The number of electrons passed through R_0 per second is directly proportional to the number of discharge periods per second, that is, to the frequency of the excitation voltage at the grid of the pentode. Thus, it is said that this type of detector circuit counts the pulses and pro-

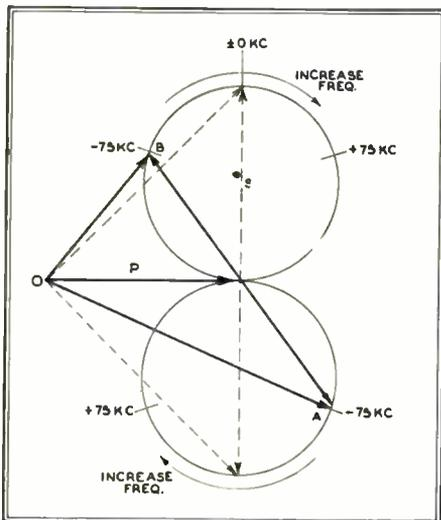

FIG. 65B DOTTED LINES SHOW NO DEVIATION

duces an average voltage across R_0 directly proportional to the input frequency.

If the input frequency increases and decreases at an audio rate, then the voltage across R_0 will increase and decrease at the same audio rate. The low-pass audio filter smooths out the RF fluctuations in the voltage across R_0 and allows only the DC and audio components of the voltage

across R_0 to appear across the filter terminating resistor R. It is important that the filter be of the choke input type, so that no residual voltage will be maintained across R_0 . Such a voltage would bias diode D_2 and prevent condenser C from discharging completely on each cycle. The linearity of this detector, when properly adjusted, is said to be excellent.

It will be noted that the input frequencies at which this detector operates are of a low order. This permits the detector to deliver a larger audio voltage, since the frequency deviation is then a larger percentage of the center frequency. Moreover, a relatively low order of input frequencies is mandatory, since condenser C must very nearly acquire its full charge and must discharge to its residual voltage level, each within the half-cycle periods of the input voltage. The internal resistances of the diodes limit the extent to which the time constants of charge and discharge can be shortened. In view of the low input frequencies required, and other practical considerations, the use of the counter type of FM detector has been limited to special applications, such as checking the performance of FM signal generators, monitoring frequency-modulation systems in transmitters, and studying the distortion produced by the tuned stages in FM receivers.

Principle of the Ratio Detector ★ In the last few years several types of detectors with a high degree of immunity to amplitude variations have been developed. One of these, which has recently come into rather wide use, is called the Ratio Detector. This circuit has many variations and has been applied in many different ways, but the most common application utilizes the phase-shift discriminator network. The description which follows is devoted to that form of the circuit.¹

The basic connections of a phase-shift type of discriminator network are shown in Fig. 65a. In this circuit a single-ended primary and a balanced secondary are loosely coupled and the voltage end of the primary is connected to the midpoint of the secondary. If the frequency of the voltage impressed upon the primary is equal to the resonant frequency of the secondary, two potentials of equal magnitude are developed. The voltage between ground and the end of the secondary marked A, consisting of the primary voltage and one half the secondary voltage, will be equal in amplitude to the voltage between ground and the point marked B, made up of the primary voltage plus that of the other half of the secondary. The vector relations are shown in Fig. 65a.

If the frequency of the generator is decreased by, say, 75 kc. below the resonant frequency of the secondary, the secondary voltage will no longer be in exact quadra-

¹ For a more detailed discussion, see "The Ratio Detector" by Stuart Wm. Seeley and Jack Avins, RCA REVIEW, June, 1947.

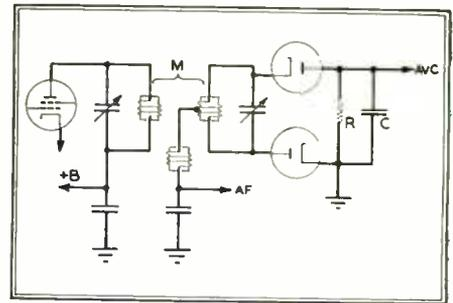

FIG. 65C. RATIO DETECTOR CIRCUIT

ture with the primary. The vector voltages will then be as indicated by the solid lines of Fig. 65b. Notice that the length of the vector O-B, which consists of the primary plus one-half of the secondary, is less than that of O-A, which is made up of the primary plus the other half of the secondary.

If the frequency of the generator of Fig. 65a were raised above the resonant frequency of the secondary, the secondary vector A-B of Fig. 65b would swing in the opposite direction so that O-B would be longer than O-A. Notice that the loci of

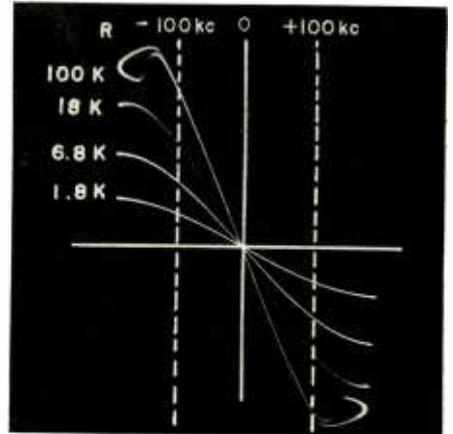

FIG. 65D DEVIATION SENSITIVITY, FIG. 65C

the ends of the secondary vector form perfect circles. As the frequency of the applied energy is varied either above or below the secondary resonant frequency, the magnitude of the total secondary voltage is altered at the same time that its phase is shifted.

In the description so far, we have assumed that the primary voltage is constant regardless of the frequency. This has been done in order to emphasize the fact that it is the phase shift of the resonant secondary voltage which produces the variations in the magnitude of the

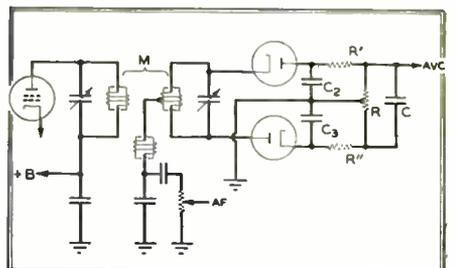

FIG. 65E. PHASE-SHIFT DISCRIMINATOR

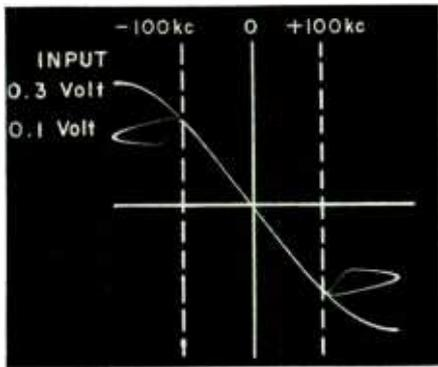

FIG. 65F. CHARACTERISTIC OF CORRECTLY DESIGNED RATIO DETECTOR CIRCUIT

voltages between ground and the two ends of the secondary. If, instead of being delivered by a constant voltage generator, the primary energy is derived from a tuned circuit in the plate circuit of an amplifier stage, that energy may also have variations in amplitude with frequency. However, those amplitude variations will in no way affect the vector relations as shown in Fig. 65b as long as the secondary Q remains constant. The secondary voltage will grow and diminish in exact conformity with the primary changes, while always maintaining the *relative* magnitude and angular phase position as shown.

In other words, we might say that the only effect of primary amplitude changes would be to enlarge or reduce the vector diagram of Fig. 65b exactly as though by photographic processes. This again emphasizes the dependence of the ratio of the lengths of O-A and O-B upon the phase shift of the secondary. Then, since we know that the phase of the secondary voltage in coupled tuned circuits is a function of the Q of the secondary, it is easy to see that the higher the Q of the secondary, the more the ratio of O-A to O-B will depart from unity with a given departure of the applied frequency from resonance.

A basic ratio detector circuit is shown in Fig. 65c. Here the primary voltage is derived from a small winding tightly coupled to the tuned primary in the plate circuit of an IF amplifier stage. The voltage

across this auxiliary or tertiary winding is always directly in phase with, and proportional to, the voltage developed across the tuned primary. The center-tapped secondary is loosely coupled to the primary and develops the resonant quadrature voltage. Half of this is added to the tertiary voltage for the upper diode, the other half being added to the same tertiary voltage for the lower diode.

Effects of Loaded Rectifiers ★ Before proceeding further it is well to review the effects of loaded rectifiers on resonant circuits. If a diode with an RF bypassed load resistor is shunted across a tuned circuit, and the diode has 100% rectification efficiency, the damping produced by the combination will be exactly equivalent to that which would have been produced if a resistor of one-half the value of the diode load resistor had been shunted directly across the resonant circuit. In the circuit of Fig. 65c, the diode load resistor is not only by-passed for RF energy, but also for variations which might otherwise occur at an audible rate. In other words, the condenser C (usually an electrolytic) is sufficiently large so that if any signal amplitude variations occur at an audible rate, the voltage across the condenser is not altered. However, the rectified current flowing into the R-C combination will increase materially with increases in signal level and will decrease, even to zero, if the applied voltage is materially decreased. If the DC voltage across the R-C combination remains fixed, but the direct current flowing into that circuit is increased, the effect is exactly as though the value of the load resistor had been decreased insofar as its effect on the resonant secondary is concerned. Conversely, if the voltage remains fixed and the current decreases, the action simulates an increased value of load resistance. From this step it is easy to see that the effective resistance shunted across the resonant circuit will vary as an inverse function of the amplitude of the applied voltage, and by the same token the Q of the secondary will be altered as the amplitude is varied.

If there is a momentary increase in the signal amplitude applied to a ratio detector circuit such as that of Fig. 65c, the diode current will increase, but the large condenser will prevent the diode load voltage from increasing. This will simulate a decreased diode load resistor which will cause a decrease in the Q of the resonant center-tapped secondary. This decreased Q will, in turn, decrease the phase shift sensitivity of the circuit and thus momentarily provide a detector of less deviation sensitivity during the period of the increased amplitude.

Other Effects ★ Other effects take place at the same time. The ratio of primary to secondary voltage is increased and the series resistive component of the impedance introduced into the primary by the

mutual coupling between the circuits is decreased. This latter effect would, of itself, tend to increase the grid-plate gain of the IF driver tube, and thus enhance the increase in signal amplitude. However, part of the increased diode current is derived from the tertiary winding voltage, so there is increased damping of the primary which tends to counteract that effect.

The curves of Fig. 65d were taken with an oscilloscope by applying the audio sine wave modulating voltage of an FM signal generator to the horizontal plates, with a ratio detector output voltage applied to the vertical plates. The signal from the generator to the ratio detector driver tube

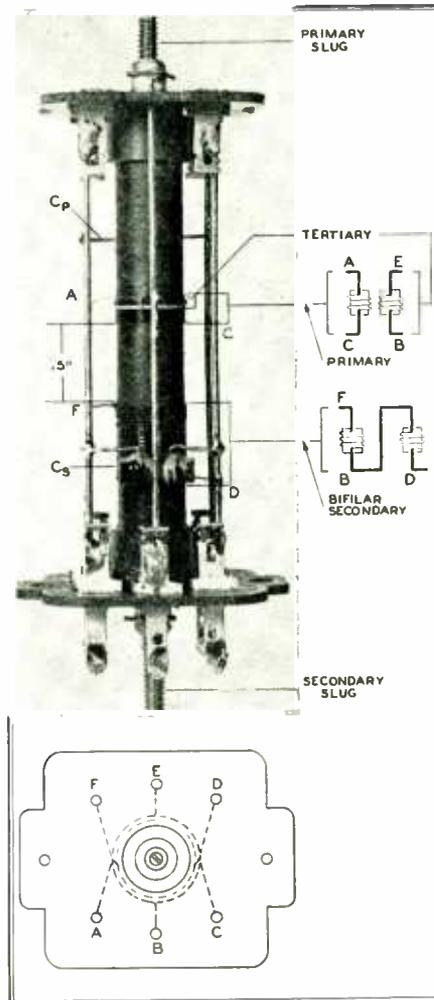

FIG. 65H. DETAILS AND CONNECTIONS OF A RATIO DETECTOR TRANSFORMER

was held constant and the diode load resistance adjusted to the several values indicated. These curves demonstrate the dependence of detector sensitivity upon the value of the diode load resistance.

The simulated inverse load-resistance variation with amplitude, in a correctly designed ratio detector, might be somewhat in excess of the amount necessary to provide amplitude variation immunity. In other words, the simple circuit of Fig. 65c might give decreased output with increased input. This would be almost as objectionable as a corresponding increase in sensitivity with amplitude. The resistors R' and R'' of Fig. 65e may be added

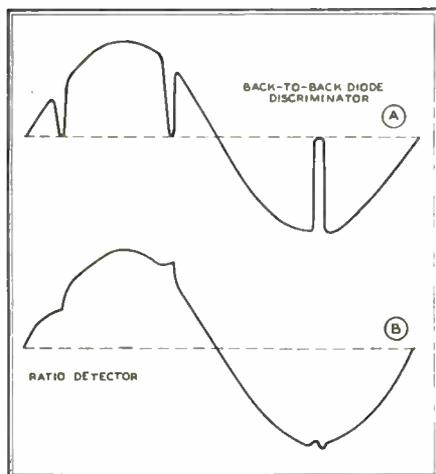

FIG. 65G. RATIO DETECTOR, B, TENDS TO SMOOTH OUT LOSS OF SIGNAL

ate frequency of the receiver, to which the IF amplifier, limiter, and discriminator circuits are resonant. This causes the RF voltage across the limiter tuned circuit condenser C to rise, creating a large DC voltage across grid leak R₁. This DC voltage is applied by way of DC filter R₂C₂ to the grid of the tuning-eye tube in negative polarity, and causes the shadow angle to diminish.

If the receiver dial is tuned beyond the setting for the station, the beat frequency created by the signal and oscillator frequencies draws away from the intermediate frequency of the receiver to which the tuned circuits are resonant. The RF voltage across the limiter tuning condenser C decreases, thereby reducing the negative bias applied by grid leak R₁ to the limiter tube, and causing the shadow angle to increase.

At the correct tuning adjustment, the maximum negative voltage is developed in the limiter grid leak and applied to the grid of the tuning eye, so that the least shadow angle is obtained.

voltage of the tuning-eye from the discriminator, since this is the receiver stage in which exact tuning is very important.

Fig. 68 (B) and 68 (C) show two tuning indicator circuits actuated by the DC component of the discriminator output, which appears whenever the center frequency of the signal applied at the discriminator differs from the resonant frequency of the discriminator tuned circuit.

In Fig. 68 (B), the DC component of the discriminator output voltage is isolated by means of a DC filter RC, and is applied to the grid of a tuning-eye tube. The tuning-eye is adjusted by means of a variable cathode resistor R_C, so that the eye just closes when there is zero voltage at the discriminator output. A convenient way to make this preliminary adjustment is to remove the last limiter tube temporarily, while adjusting R_C to make the eye close.

In the case of the circuit shown in Fig. 67 (B) it will be found that when no signal is tuned in, the eye is closed. When the dial is tuned past the setting at which a

ated from the discriminator stage, an objection may be raised because, during tuning, the shadow angle of the eye varies in a manner that may puzzle the uninformed operator who has been accustomed to seeing the eye open above and below resonance in his AM receiver. Thus the use of a tuning rectifier, as shown in Fig. 64 (D), is favored by some set designers.

In this circuit, when the applied frequency exceeds the resonant frequency and the voltage at the discriminator output terminal A is, say, positive with respect to ground, the current drawn through tuning rectifier diode D₃ produces a voltage drop in the rectifier level resistor R_L of such polarity as to reduce the negative voltage on the grid of the tuning-eye, thereby opening the eye. When the applied frequency is less than the resonant frequency and terminal A is negative with respect to ground, then current is drawn in the same direction through R_L as before, but by way of diode D₄. Again a voltage is applied to grid of the tuning-eye in such polarity as to open the eye. Therefore, the eye closes at the correct dial setting of the receiver and opens above or below the correct setting, similarly to tuning-eyes in AM receivers.

Double Superheterodyne FM Receivers ★ In the preceding section, stress was laid upon the need for high RF and IF gain in FM receivers, in order that weak signal voltages can be brought up to a level sufficient to saturate the limiter. Moreover, it was stated that a gain of 70,000 represented about the maximum that could be obtained safely from the mixer and IF stages in the factory production of receivers without running serious risk of encountering instability in the IF amplifier because of regenerative coupling between stages. This condition demands a large gain in the first RF amplifier stage; in fact, a larger gain than can be obtained easily at FM frequencies

One solution to this problem of obtaining large overall gain without requiring excessive gain at one intermediate frequency lies in the use of a special circuit arrangement called the *double superheterodyne* or *triple-detector superheterodyne*. Here, two intermediate frequencies are employed, thus reducing the amount of gain that is required at each frequency.

The logical circuit arrangement for a double superheterodyne would appear at first thought to include a variable-frequency oscillator to reduce the signal frequency to the first intermediate frequency in the first mixer, and another oscillator, of the fixed-frequency type, to lower the frequency to the second intermediate frequency in the second mixer. Actually, such an arrangement causes serious difficulty because of spurious signals produced by beating together the fundamentals and harmonics of the oscillator.

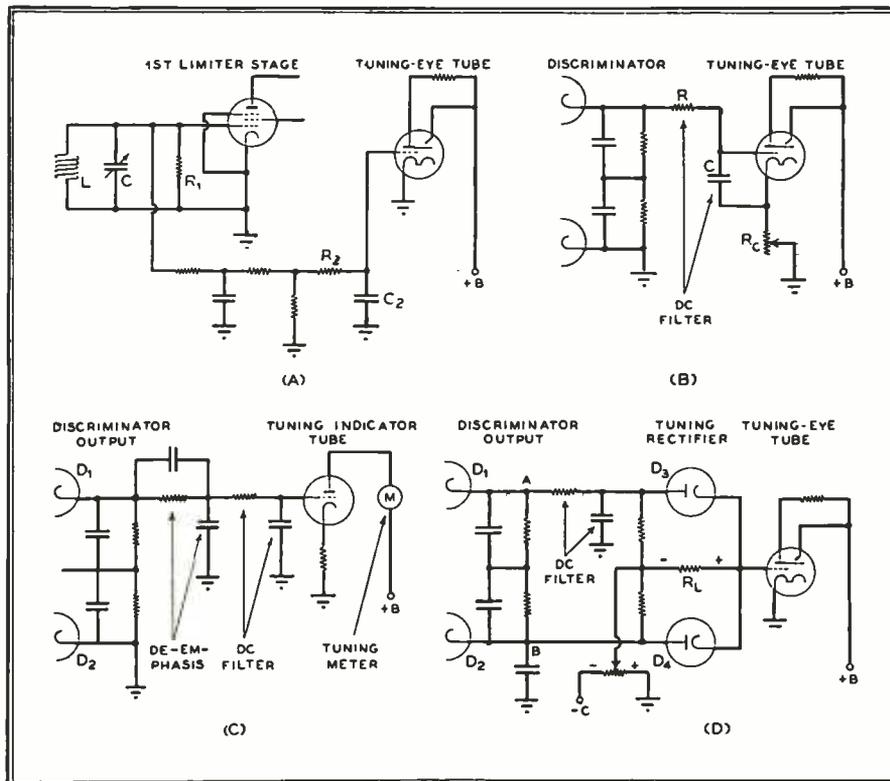

FIG. 68. FOUR TYPES OF TUNING INDICATOR CIRCUITS USED IN FM RECEIVERS

As stated previously, the condition to be satisfied for correct tuning adjustment is that the applied frequency at the discriminator be equal to the resonant frequency of the discriminator input circuit. The above method of tuning assumes that the alignment of the limiter, IF amplifier, and discriminator tuned circuits will be maintained exactly at the intermediate frequency of the receiver.

Actually, in view of the high order of the intermediate frequency involved, it can be expected that the circuits may be slightly out of alignment at times. Some set designers prefer to obtain the control

station is heard, the eye first opens and then closes and overlaps, or vice-versa, depending upon the direction in which the dial is turned. The correct tuning adjustment is at the transition point between an opening and an overlap, where the eye is just closed.

Fig. 68 (C) shows a circuit operating on the same principle as that of Fig. 68 (B), except that a tuning meter is employed instead of a tuning-eye. Tuning is accomplished by bringing the meter indicator to a reference mark on the meter scale.

While the indicator circuit in Fig. 68 (B) has the advantage of being oper-

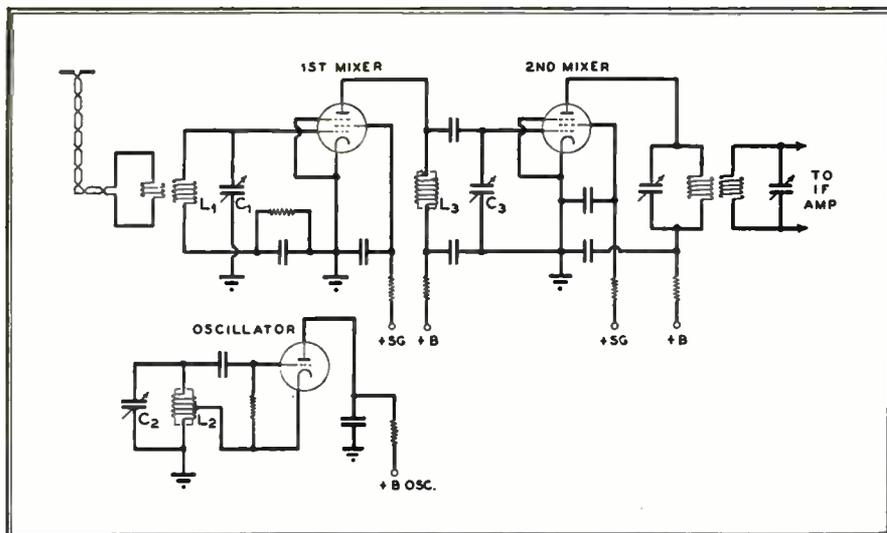

FIG. 69. FUNDAMENTAL CIRCUIT OF DOUBLE SUPERHETERODYNE RECEIVER, WHICH PROVIDES LARGE RF GAIN WITH GOOD STABILITY

A practical circuit arrangement employed in FM receivers designed to tune over a range of frequencies is shown in Fig. 69. Here the oscillator frequency at any particular dial setting is half the difference between the signal frequency for that dial setting and the second IF.

For example, in Fig. 69, assume that the second intermediate frequency is 4.3 mc. and the signal frequency is 45.5 mc. The input tuned circuit of the first mixer is resonant at 45.5 mc. and the oscillator tuning circuit constants L_2C_2 are such as to give an oscillator frequency of $(45.5 - 4.3)/2$, or 20.6 mc.

The oscillator is coupled inductively or capacitively to the first mixer and causes a beat component to appear in the output at the difference frequency of $45.5 - 20.6$ or 24.9 mc. The tuned parallel circuit L_2C_2 is resonant at this difference frequency, causing a voltage of the difference frequency to be established across L_2C_2 .

The plate current of the first mixer also contains a strong component at the oscillator frequency. The impedance offered by L_2C_2 to the oscillator frequency of 20.6 mc. is less than that offered to the first intermediate frequency of 24.9 mc. However, the strong component at the oscillator frequency of 20.6 mc. is able to build up an appreciable voltage across the small impedance of L_2C_2 , and this voltage is applied to the grid together with the voltage at the first intermediate frequency of 24.9 mc. This, a difference frequency component at $24.9 - 20.6$ or 4.3 mc. appears in the plate circuit of the second mixer, and serves to excite the IF amplifier.

Since the output circuit of each mixer tube is tuned to a frequency other than that of its input circuit, high-gain tubes can be employed in both mixer stages without risking oscillation. Since the conversion transconductance of a tube used as a mixer is from one-third to one-half of the mutual conductance of the same tube used as an amplifier, reasonably good

gain can be obtained in the two mixer stages. The use of a single oscillator for both mixer stages overcomes the difficulty with spurious responses that is encountered when two oscillators at different frequencies are employed.

Where still greater receiver gain is desired, as in FM mobile communications services, an additional stage of amplification at the first intermediate frequency may be employed. The selectivity of the IF amplifier between the first and second mixers would be too great to permit a component of voltage at the oscillator frequency to reach the second converter grid by way of the first converter as in Fig. 69. However, where reception at only one frequency is desired, the circuit can be designed so that only one crystal oscillator is employed. The fundamental of the oscillator is applied to the second mixer and a higher harmonic is coupled to the first mixer.

The Beers Receiver ★ Fig. 70 shows a block diagram of a special receiver circuit arrangement devised by G. L. Beers of RCA, in which the conventional limiter and discriminator are respectively replaced by a locked-in oscillator and a reduced-range discriminator. The circuit of the oscillator and discriminator are shown beneath the block diagram.

The locked-in oscillator employs a pentagrid-converter type of tube. The plate circuit L_1C_1 of the oscillator is tuned to a frequency that is one-fifth of the nominal intermediate frequency of the receiver. For example, if the intermediate frequency is 4.3 mc., circuit L_1C_1 will be tuned to $4.3/5$ or .86 mc.

Energy is transferred by inductive feedback from the oscillator plate circuit L_1C_1 to circuit L_2C_2 , which is connected to grid No. 3. In order to accentuate the even harmonic content in the oscillator output, grid circuit L_2C_2 is tuned to the second harmonic, 1.72 mc., instead of the oscillator fundamental, .86 mc.

The FM signal is applied to grid No. 1 by way of tuned circuit L_3C_3 , which is coupled to the IF amplifier. Grids Nos. 2 and 4 are held at RF ground potential and serve to minimize electrostatic coupling between the signal input and oscillator circuits.

When no signal is being received, the oscillator operates at the frequency of its tank circuit, 860 kc. Under this condition the discriminator output voltage is zero.

If a signal voltage having a frequency near the intermediate frequency of 4.3 mc. is applied to grid No. 1 of the oscillator tube, it will modulate the electron stream and will combine with the fourth harmonic of the oscillator frequency, 3.44 mc., to give a component of oscillator plate current having the difference frequency of nearly $4.3 - 3.44$ mc., or .86 mc.

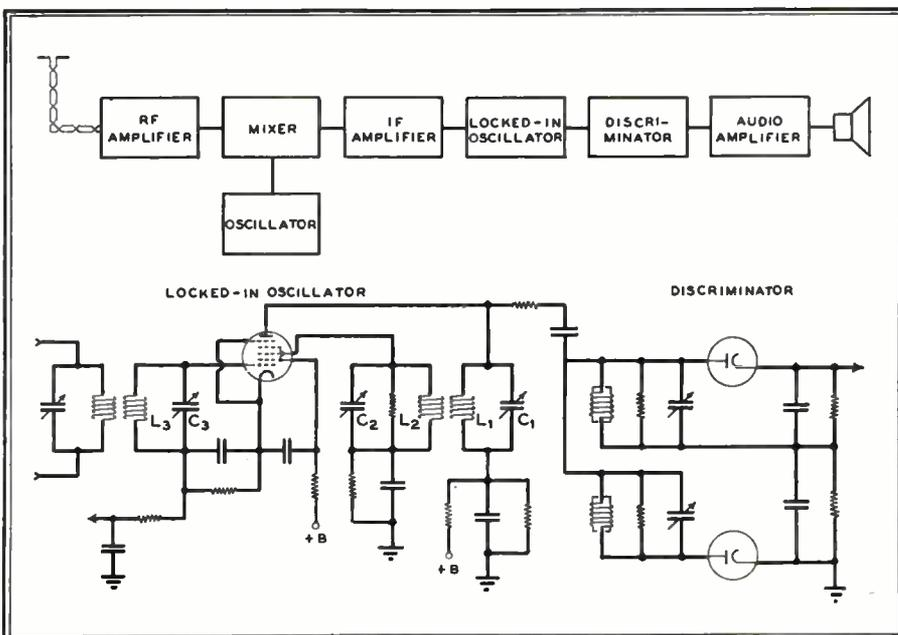

FIG. 70 BLOCK DIAGRAM OF BEERS FM RECEIVER WITH CIRCUIT DIAGRAM OF LOCKED-IN OSCILLATOR AND DISCRIMINATOR

Such a component of plate current can produce a voltage across the tank circuit L_1C_1 , resonant to 860 kc. that is appreciable compared to the voltage set up across this circuit by the oscillator alone. The result is that the oscillator will *lock-in* at one-fifth of the signal frequency and *will follow any small variations in the signal frequency* that may occur. For example, if the FM signal at the oscillator input is 4.3 mc. \pm 75 kc., the signal at the oscillator output will be .86 mc. \pm 15 kc. The oscillator output signal is demodulated in the discriminator, which is designed to have a linear characteristic over a range somewhat in excess of 2×15 or 30 kc.

The sixth harmonic of the oscillator frequency may also combine with the signal frequency to produce a component

in the plate current having a frequency nearly equal to the natural frequency of the oscillator. Whether the fourth or the sixth harmonic will be the one which causes the locking-in effect will depend on which of the harmonics predominates. The end result is essentially the same. The oscillator operates at one-fifth of the instantaneous signal frequency at the IF amplifier output, and the amplitude of the oscillator output voltage is substantially independent of signal amplitude.

The frequency range over which lock-in control of the oscillation frequency will be maintained is limited. In fact, the discriminator input circuit constants are so chosen as to tend to keep the oscillator tank circuit impedance essentially resistive over a wider range than would be obtained if the discriminator were not

coupled to the oscillator. In this manner, lock-in operation can be obtained over a range of about \pm 110 kc. with a 1-volt signal on the No. 1 grid of the oscillator. This is sufficiently in excess of the \pm 75-kc. deviation of an FM broadcast signal to allow for slight mis-tuning and for oscillator drift.

When the applied frequency differs from the intermediate frequency by appreciably more than 110 kc., say by 200 kc., a voltage very much in excess of 1 volt is necessary on the No. 1 grid of the oscillator to obtain lock-in operation. Thus the oscillator is prevented from responding to signals on channels adjacent to the one occupied by the desired signal. In fact, the improvement in the suppression of adjacent channel interference is the primary advantage claimed.

GENERAL FM THEORY

SECTION 8: PRINCIPLES OF AUTOMATIC FREQUENCY CONTROL, ALIGNMENT PROCEDURES, CIRCUIT DESIGNS, AND THE APPLICATIONS TO FM RECEIVERS

UNLESS a radio receiver is tuned accurately to the frequency of the incoming signals, the audio quality is distorted and there may be heavy background noise. Slight mistuning may result from careless manual adjustment or lack of precise resetting in the mechanisms of automatic tuning devices. Even when the initial tuning is accurate, variations in line voltage or thermal drift in circuit components which are affected by changes in ambient temperature may result in mistuning.

Automatic frequency control circuits for AM receivers were introduced about 1936 on remote-controlled models to compensate for errors in the tuning mechanism. For this purpose, AFC proved highly satisfactory. It is doubtful, however, if the use of AFC is justified on manually-operated broadcast receivers as a substitute for accurate adjustment by hand.

Application of AFC to FM Sets ★ On FM receivers, AFC has two useful applications:

1. It is practically a requirement on broadcast receivers which employ automatic tuning of the mechanical type. At least, no mechanical device has been perfected so far to the point where it is accurate enough to reset a tuning condenser repeatedly at exact resonance. Also, in the band from 88 to 108 mc., it may prove less expensive to employ AFC than to compensate for drift due to thermal changes.

2. In communications services operating at 152 to 162 mc., and perhaps in the 70-mc. band, AFC will be used to compensate for drift in both mobile and remote relay installations.

Some engineers have expressed the opinion that AFC cannot be used successfully on FM receivers. However, such receivers were developed by Freed Radio Corporation early in the last war, and were produced in great numbers for the U. S. Navy.¹ The circumstances which called for this development are extremely interesting.

In 1942, engineers of the NDRC Underwater Sound Laboratory at New London, Conn., conceived the idea that sounds from a submarine could be picked up in patrol planes by parachuting a radio telephone transmitter down to the surface of the water. The plan was to equip the transmitter with a microphone and a length of cable to be released upon contact with the water. A crude model of the device was built at New London, and a

¹ It should be noted that this was one of the first, if not the very first, uses of FM in Navy radio equipment. Considerable pressure was brought to bear on the Underwater Sound Laboratories to use AM, but in exhaustive comparative tests, FM was found to be so much superior to AM in performance that the FM design was finally adopted.

contract was awarded Freed Radio to design and perfect the transmitter and a suitable receiver to pick up the signals.

Transmitters of several different frequencies were used, identified as to their frequency by colored bands. Corresponding color markings were put on the receiver dial to facilitate tuning.

Because the transmitters were not crystal-controlled, they drifted considerably in frequency after they were dropped into the water. And because the aircraft receiver could not be adjusted constantly to follow the transmitter drift, it was necessary to use AFC in the receiver.

The successful operation of this equipment is indicated by the high score of submarines sunk and captured through their use, particularly by planes from the baby flat-tops.

It was possible to observe the AFC action in the tuning eye with which this receiver was equipped. As the tuning was

heterodyne frequency produced by mixing the incoming signals with the local oscillator frequency.

2. A control circuit to which is applied the direct current or voltage from the discriminator, and which serves to shift the oscillator frequency enough to bring the heterodyne frequency into resonance² with the IF circuits.

The use of AFC in FM circuits is somewhat simplified, since the discriminator is an essential part of an FM receiver. This is illustrated in Fig. 71, which shows the elements of AM and FM superheterodyne receivers employing AFC. The chief difference, then, between the AM and FM systems is that the FM discriminator stage which is required to demodulate the incoming signals also furnishes the voltage to operate the AFC control on the oscillator.

AFC Control Circuit ★ Before discussing the

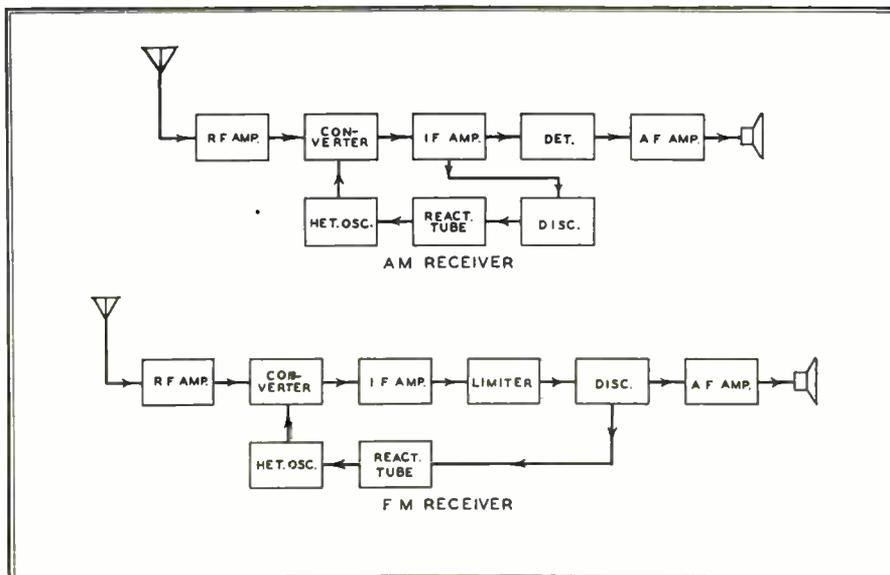

FIG. 71. BLOCK DIAGRAMS SHOWING THE DIFFERENCE BETWEEN AUTOMATIC FREQUENCY CONTROL CIRCUITS FOR AM RECEPTION, ABOVE, AND FOR FM, BELOW

varied, and the circuits were brought near the point of resonance with the incoming signals, the eye closed suddenly and remained closed even beyond the resonance point. There was no critical frequency adjustment, since the AFC action produced a response curve with steep sides and a relatively wide, flat top.

Elements of the AFC System ★ An automatic frequency system for AM receivers consists of two major networks. These are:

1. A frequency discriminator which produces a direct current or voltage whose polarity and magnitude are determined by the degree of difference between the nominal IF frequency of the receiver and the

control circuit itself, it might be well to consider first the heterodyne oscillator and to determine just how to best accomplish the desired control of its frequency adjustment. One commonly-used oscillator circuit is the Hartley type, shown in Fig. 72. The frequency of oscillation is determined by the tuned circuit LC. Grid excitation voltage of the proper phase is obtained by connecting the grid and plate of the tube to the ends of inductance L, and connecting the cathode to a tap on the coil. The ratio of the RF plate voltage E_p to the

² Absolute compensation is impossible because the correcting voltage results from off-resonance tuning. However, a correction ratio of 100 to 1 or better can be obtained in commercial practice.

rection of the heterodyne oscillator frequency.

A complete circuit, combining a discriminator and control, is shown in Fig. 74. The discriminator transformer is tuned to the IF frequency, and the oscillator is adjusted to the proper frequency to produce the IF beat frequency when heterodyned with the incoming signal.

When the receiver is correctly tuned and there have been no changes in com-

ponents or adjustments due to thermal effects, the IF signal applied to the discriminator transformer primary produces equal and opposite voltages across the secondary. The primary voltage appears, with essentially the same magnitude and phase, across the RF choke. One secondary voltage leads this primary voltage by 90° , the other secondary voltage lags the primary voltage by 90° . The total voltage applied to each diode rectifier consists of the voltage across the RF choke, i.e., the primary voltage, plus the voltage across the corresponding half of the secondary. Since the secondary voltages are equal, and the primary voltage is common to both diodes, the DC output voltages across the load resistors are equal and opposite, hence, there is zero voltage applied to the grid of the reactance tube.

as though an inductive reactance were shunted across its tuned circuit. However, these conditions are termed quiescent, or normal, stable conditions, and the apparent reactance produced by the reactance tube has already been taken into account in designing the tuned circuit for proper frequency range.

Now, if the receiver is tuned slightly below the desired frequency, so that the signal applied to the IF amplifier is slightly

higher in frequency than the amplifier resonant frequency, it will be necessary for the AFC system to retune the oscillator. The same requirements would exist if thermal changes caused the oscillator to drift to a lower frequency.

With the applied frequency higher than the resonant frequency, the inductive reactance of L_S will exceed the capacitive reactance of C_S , hence the voltages across L_S will lag. The AC voltage applied to diode D_1 will be greater than that applied to diode D_2 , and the DC voltage across R_1 will then be the larger, applying a positive bias to the reactance tube grid. A less negative total bias will cause an increase in the reactive plate current flowing in the oscillator tuned circuit, the total effective inductive reactance will be reduced, and the oscillator will increase frequency to balance the tuned circuit reactances and restore the IF signal to the resonant frequency of the amplifier.

If the receiver is off-tune on the high side of the desired signal, so that the signal is lower in frequency than the resonant frequency of the IF amplifier, or thermal changes in the oscillator circuit cause the oscillator frequency to increase, the ca-

pacitive reactance of C_S will predominate over the inductive reactance of L_S . Thus, the secondary voltages will lead, making the voltage across R_2 the larger, and a negative bias will be applied to the reactance tube. The increase in negative bias reduces the reactive plate current, and therefore increases the apparent reactance shunted across the oscillator tuned circuit. To restore reactance balance and bring the IF frequency signal to the proper frequency, the oscillator will lower its frequency.

Circuit Design Considerations ★ For proper results an AFC system should not be considered as an accessory to be added to an existing receiver design. Rather, the receiver with the AFC system should be regarded as a unit to be designed for the desired end result.

An FM receiver in which an AFC system is to be used must have good stability of alignment in the various tuned circuits, as the proper operation of the control system depends upon the maintenance of alignment, especially in the discriminator network. It is desirable to include two IF amplifier stages, as well as two limiter stages, to obtain as much over-all sensitivity as possible. The IF stages must be designed in accordance with the best practice as to amplification, and band-pass characteristics.

Generally, it is desirable to supply the local heterodyne oscillator and the reactance tube with regulated plate voltage, to aid in controlling the oscillator. Tuning drift, due to thermal causes, should be made as small as possible by using temperature compensated components. The use of short leads is especially important in AFC systems, and the reactance tube and its associated components should be so installed that the coupling leads to the local oscillator will be as short as possible.

It may sometimes be desirable to use the second harmonic of the local oscillator for reasons of stability. Under this condition the reactance tube circuit would still be connected across the oscillator tuned circuit, but its holding action range would be doubled, since the plate circuit of the oscillator is tuned to the second harmonic. If insufficient reactive plate current is developed, it can be increased in the usual manner by means of an additional linear amplifier, as shown in Fig. 75.

Discriminator Sensitivity ★ In a discriminator of the Foster-Seeley type — that is, one using a center-tapped secondary with both primary and secondary tuned to the same frequency — the sensitivity of the device to changes in frequency of the applied signal is equivalent to the slope of the discriminator characteristic curve at resonance. The sensitivity of the discriminator is an important factor in the design of an AFC system, since it determines the control voltage developed for a given frequency shift. Foster and Seeley

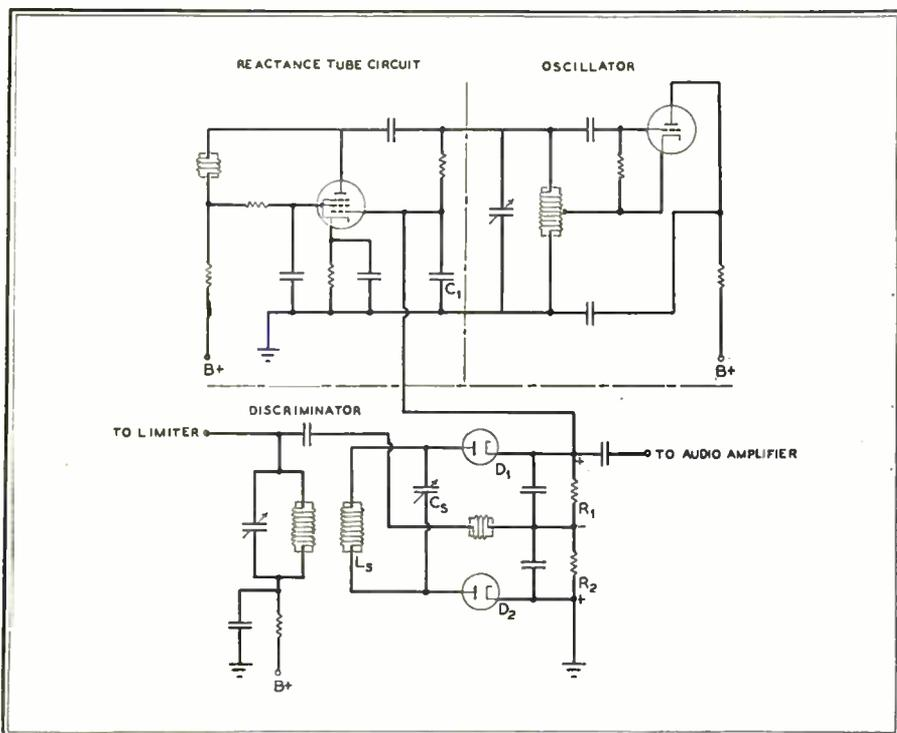

FIG. 74. COMPLETE AFC CIRCUIT, SHOWING THE FM DISCRIMINATOR WHICH SUPPLIES A VOLTAGE TO THE REACTANCE TUBE ACROSS THE OSCILLATOR CIRCUIT

give the following formula for calculating sensitivity:

$$S = 8\pi LQ^2G_m \frac{(AK)^{1/2}}{(1 + K^2) \left(1 + \frac{AK^2}{4}\right)^{1/2}}$$

where L = primary inductance
 Q = quality factor of primary
 G_m = transconductance of tube preceding discriminator transformer
 A = ratio of total secondary inductance to primary inductance
 K = ratio of actual to critical coupling between primary and secondary. $2\pi fM = K\sqrt{r_1}\sqrt{r_2}$. (r = apparent primary series resistance, which includes the effect of the tube, the natural primary series resistance, and any other resistive load other than the secondary, and r_2 = apparent secondary series resistance.)

In deriving this formula the apparent Q values of primary and secondary (when in circuit) were assumed to be equal. It is apparent that the sensitivity is independent of frequency, proportional to L , Q^2 and G_m , and a function of the ratio of inductances and the percent of critical coupling. It can be shown that, for any ratio of secondary to primary inductance, the optimum coupling will be less than the critical value.

The separation of the two peaks of the discriminator characteristic may be increased to increase the band width, either by raising the value of coupling above optimum, or by reducing the Q of the circuits. In either case the sensitivity will be reduced; however, changing the coupling will affect the sensitivity the least for a given change in the peak separation. If the coupling between the primary and secondary of the discriminator transformer is not greater than 75% of the critical value, the peak separation of the discriminator characteristic will be approximately equal to f_0/Q_B , where f_0 is the carrier frequency and Q_B is the effective Q of the secondary with diode loading considered.

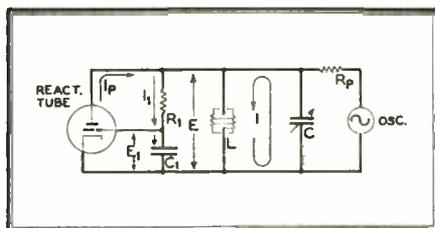

FIG. 76. RC PHASE-SHIFT NETWORK

Time Delays ★ Attention must be given to the relative time delays of the discriminator output filter system and the power supply filter. The discriminator filter should have a smaller time constant than that of the power supply, in order

that the AFC system may prevent changes in the oscillator frequency due to line voltage variations.

Discriminator Filter ★ It is necessary to insert a low-pass filter in the discriminator output line to the reactance tube, in order that the reactance tube will not be affected by low frequency audio voltages.

taken into account, ordinary coupled-circuit theory can be used in calculating the primary, secondary and output voltages.

Reactance Tube ★ The maximum amount of control or holding action is proportional to the product of the transconductance G_m of the reactance tube,

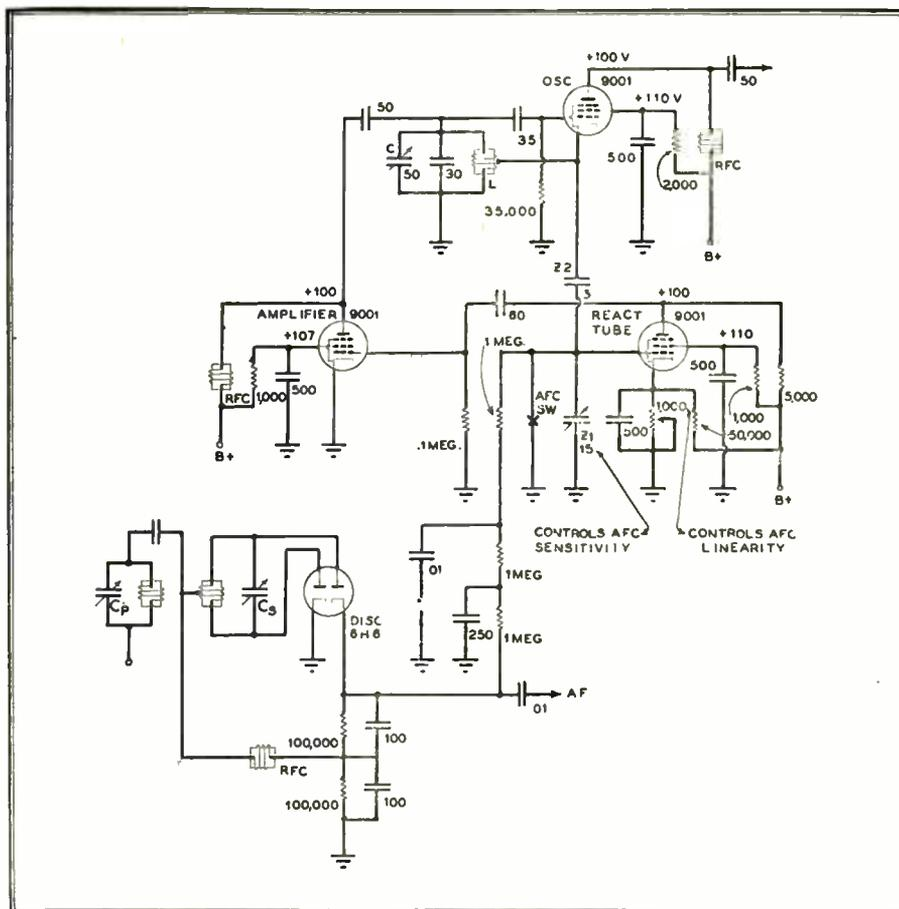

FIG. 75. WHEN THE SECOND HARMONIC OF THE LOCAL OSCILLATOR IS USED FOR STABILITY, A LINEAR AMPLIFIER MAY BE NEEDED TO INCREASE THE REACTIVE PLATE CURRENT

Polarity ★ The polarity of the voltage developed at the ungrounded output terminal of the discriminator network, with respect to ground, is determined solely by the sign of the coupling between the two tuned circuits. It is desirable to so phase the inductive coupling as to compensate for capacitive unbalances existing in the circuit. Then the polarity of the output voltage may be changed, when necessary, by interchanging the grounded and ungrounded terminals.

In the discriminator circuit shown in Fig. 75, the diode rectifiers produce a loading effect on the discriminator transformer. In the case of the primary, the load is equivalent to a shunt resistance equal to the diode load divided by four times the efficiency of rectification, $R_1/4\eta$. For the full secondary, the load is equivalent to a shunt resistance equal to the diode load divided by the rectification efficiency, R_1/η . Providing the effect of this loading on the Q 's of the circuit is

and the grid bias E_c . Since it is desired in practice that the range of holding action be as large as possible for a given change in bias, a sharp cutoff tube should be selected. The transconductance of the tube should change linearly with variations in grid bias. These requirements are satisfied by pentodes that produce substantial power amplification. Such tubes, besides having high transconductance, also isolate the plate current from the plate voltage, if the screen grid is operated at a lower voltage than the plate. In addition, since the plate current depends to a great extent upon the screen voltage, the discriminator output voltage can be impressed on the screen rather than on the control grid, thus reducing back actions.

By proper choice of the values of capacitor C_1 and resistor R_1 in the phase shift network, the amount of holding action obtained can be varied to meet requirements. The oscillator tuned circuit voltage is affected by the resistive branch of the

phase shift network; therefore, this resistance value should be selected first to give the proper tuned circuit voltage over the desired frequency range. The capacitive branch has little effect on the tuned circuit voltage; it does, however, govern the amount of holding action of the reactance tube, since it determines the alternating voltage applied between grid and cathode of the reactance tube. When the peak value of this alternating grid voltage exceeds the negative grid bias, the holding action ceases.

Therefore, the oscillator tuned circuit voltage appearing across the phase shift network limits the value of the resistive and capacitive branches which can be used without exceeding the negative grid bias. Reducing the tuned circuit voltage across the phase shift network increases the range of control, but the voltage must be sufficient to result in adequate translation. Since the impedance of the capacitive branch varies inversely with frequency, the tuned circuit voltage should vary reciprocally and directly with frequency, in order that a uniform holding range will be realized. The tuned circuit voltage should also remain as nearly constant in magnitude as possible over the entire frequency spectrum for best results.

The holding action limit is governed by reactance tube plate current cutoff with negative discriminator output voltage, and by reactance tube grid current with positive discriminator output voltage. The oscillator tuned circuit voltage affects the grid current cutoff point, but does not determine the plate current cutoff point. Hence, when the tuned circuit voltage does not vary inversely with the impedance across the reactance tube, the holding action range will not be symmetrical about the zero discriminator voltage axis.

A simple method of determining the relative merits of tubes, with regard to holding action, is shown in the tables following. The tables illustrate variations in control possibility, using four common pentodes that can be used to develop a reactive plate current. The tubes selected for the examples are the 9001, 6AK5, 1852, and 12SH7. Plate and screen voltages are based upon the manufacturer's recommended values; however, these values can be varied to satisfy particular requirements.

An RC type of phase shift network is used in the example, as shown in Fig. 76. The value of the resistive branch R_1 is selected first so that the proper tuned circuit voltage E is realized over the desired range. The capacitive branch C_1 , which has little effect on the tuned circuit voltage E , governs the amount of control. For purposes of illustration, an arbitrary peak value of 25 volts is assigned to the voltage E , which also appears across the phase shift network R_1C_1 . The resistor R_1 has a value of 50,000 ohms.

Cutoff in the positive direction can be

determined by using trial impedance values of 1,000 ohms and 5,000 ohms for capacitor C_1 . When the capacitive reactance is 1,000 ohms, cutoff in the positive direction will be 0.5 volt; a capacitive reactance of 5,000 ohms will give a cutoff value of 2.5 volts.

The transconductance of a 9001 tube is approximately 2,000 at 0.5-volt bias, and 1,600 with a bias of 2.5 volts. Thus, for a change in the reactance of capacitor C_1 from 1,000 ohms to 5,000 ohms, a change in transconductance from 2,000 micromhos to 1,600 micromhos occurs. This five-to-one change in bias, from 0.5 volt to 2.5 volts, results in a 25% change in the transconductance of the tube.

Using the 6AK5 tube, since its control possibility is highest, circuit values which result in a peak bias of 2.0 volts on the reactance tube will give maximum control. The normal operating bias applied to the reactance tube should be midway between the 2.0-volt IX₀ drop and the negative bias necessary for plate current cutoff. Since the cutoff bias is approximately -6.0 volts, the operating bias on the 6AK5, with zero discriminator voltage applied, should be about -4.0 volts.

VARIATION OF CONTROL POSSIBILITY WITH BIAS CHANGES

9001			6AK5		
E_m	G_m micromhos	$G_m E_m$	E_m	G_m micromhos	$G_m E_m$
-6.5	cutoff	0	-6.0	cutoff	0
5.0	300	1500	5.0	900	4500
4.0	800	3200	4.0	1500	6000
3.0	1400	4200	3.0	3000	9000
2.0	1800	3600	2.0	5000	10000
1.0	2000	2000	1.0	—	—
E_p 250 volts, E_{sc} 100 volts			E_p 180 volts, E_{sc} 120 volts		

12SH7			1852-6AC7		
E_m	G_m micromhos	$G_m E_m$	E_m	G_m micromhos	$G_m E_m$
-4.0	cutoff	0	-4.0	cutoff	0
3.0	900	2700	3.0	1000	3000
2.0	2700	5400	2.0	4000	8000
1.0	4000	4000	1.0	8000	8000
E_p 250 volts, E_{sc} 100 volts			E_p 300 volts, E_{sc} 100 volts		

Holding Action ★ Fig. 77 shows the holding action of a typical reactance tube circuit, where the shaded portion represents the area of instability. When the signal intensity decreases, due to fading, the control action is lost and is not regained unless the receiver is retuned. A sudden drop in line voltage could also reduce the holding action sufficiently that the desired signal would be completely lost. As shown in Fig. 77, the AFC circuit takes control at mid-frequency and holds the output substantially flat until the signal is detuned 200 kilocycles, at which point the AFC loses control and the output drops rapidly to zero. To regain the signal, the receiver must be retuned to nearly the mid-frequency, since the AFC system will not take control again to restore the signal unless this is done. This effect occurs both above and below the mid-frequency. The FM receiver should be tuned so that it is not operating at the outer edge of the control range, i.e., within the shaded areas shown. Whenever the receiver is tuned within this area it

is in an unstable condition and, in addition to possibly introducing unnecessary distortion, the signal may disappear abruptly.

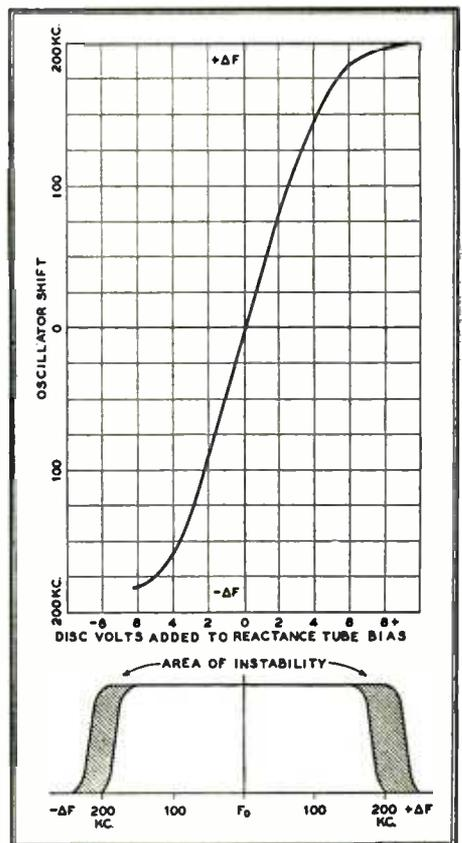

FIG. 77. HOLDING ACTION OF A TYPICAL AFC REACTANCE TUBE CIRCUIT

Design Equations ★ The maximum plate current developed by the reactance tube occurs when the discriminator output voltage reaches a positive maximum.

$$I_p \text{ max} = \omega CE + G_m E_m + G_m E_i, \quad (\omega t = 90^\circ).$$

Minimum plate current occurs when the discriminator output voltage reaches a negative maximum,

$$I_p \text{ min} = \omega CE - G_m E_m + G_m E_i, \quad (\omega t = 270^\circ).$$

These values are shown in Fig. 76, where the peak amplitude of the oscillator frequency voltage E_1 applied to the grid of the reactance tube is fixed, since this value,

$$E_1 \text{ peak} = \omega CE + G_m E_i,$$

exists with zero discriminator voltage E_m . In the circuit of Fig. 76, the grid exciting voltage E_1 lags the small exciting current I_1 by an angle of 90 degrees, and the resultant plate current I_p , flowing through the oscillator tuned circuit L-C, also lags the tuned circuit voltage E by the same angle. The total peak current I through the frequency-determining elements L-C is, therefore, no longer ωCE , but for zero discriminator voltage E_m becomes

$$I_s = \omega CE - G_m E_1,$$

or approximately

$$I_s = \omega CE - G_m \frac{E}{\omega C_1 R_1},$$

since, for a 90-degree lagging current I_p , the phase shift network in the circuit shown consists of a capacitive branch

$$Z_1 = \frac{1}{\omega C_1}$$

and a resistive branch

$$Z_2 = R_1,$$

where, in practice the value of R_1 is selected equal to or greater than five times the value offered by the capacitive branch Z_1 , or

$$R_1 \geq \frac{5}{\omega C_1}.$$

The current I_1 flowing through the phase shift network $Z_1 - Z_2$ is practically equal to

$$I_1 = \frac{E}{R_1}.$$

The grid exciting voltage E_1 applied to the reactance tube is

$$E_1 = \frac{I_1}{\omega C_1} = \frac{E}{\omega C_1 R_1},$$

and the resultant reactive plate current is

$$I_p = E_1 G_m = \frac{E G_m}{\omega C_1 R_1}.$$

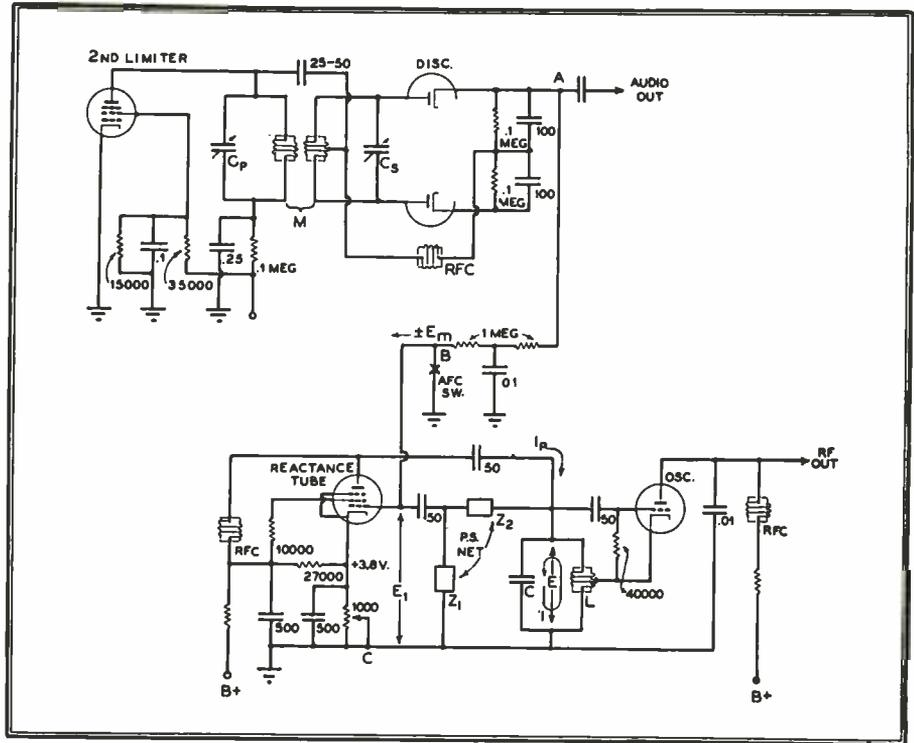

FIG. 79. COMPLETE AUTOMATIC FREQUENCY CONTROL SYSTEM FOR AN FM RECEIVER

The effective impedance applied to the oscillator tuned circuit L, C is then

$$Z_e = \frac{E}{I_p} = \frac{\omega C_1 R_1}{G_m} = \frac{E}{G_m E_1}.$$

Because this impedance varies directly with frequency, it appears as an in-

ductance L_q . This apparent inductance can be computed from the equation

$$L_q = \frac{C_1 R_1}{G_m} \text{ henrys,}$$

where the units are farads, ohms, and mhos. Consider, for example, the following values:

$$G_m = 5 \times 10^{-3} \text{ mho}$$

$$R_1 = 50,000 \text{ ohms or } 5 \times 10^4 \text{ ohms}$$

$$C_1 = 2 \times 10^{-13} \text{ farad.}$$

$$L_q = \frac{2 \times 10^{-13} \times 5 \times 10^4}{5 \times 10^{-3}} = 2 \times 10^{-3}$$

henrys,

or 20 microhenrys. The apparent inductance L_q developed by the circuit of Fig. 76 is shunted across the tuned circuit inductance L . Hence, the total effective inductance in the oscillator circuit becomes less as L_q is decreased, resulting in an increase of the oscillator frequency from its nominal value. The effective inductance in the oscillator circuit is

$$L_o = \frac{C_1 R_1 L}{C_1 R_1 + G_m L},$$

and the operating frequency f will be

$$f = \frac{1}{2\pi\sqrt{C L_o}}.$$

The oscillator frequency, if no inductance were introduced by the reactance tube circuit, would be

$$f = \frac{1}{2\pi\sqrt{C L}}.$$

These equations apply only to static conditions, which exist when zero discriminator voltage E_m is developed, i.e.,

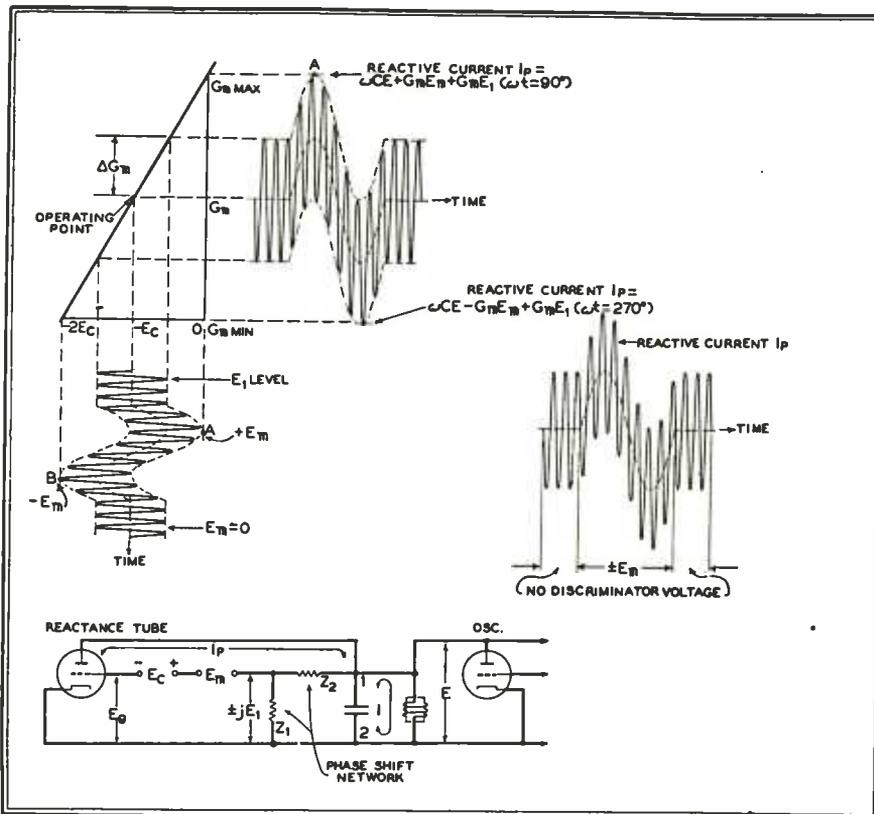

FIG. 78. GRAPHIC REPRESENTATION OF THE EFFECT OF VARIATIONS IN DISCRIMINATOR OUTPUT ON REACTANCE-TUBE PLATE CURRENT

intermediate frequency carrier at mid-frequency f_0 . With changes in intermediate frequency, the discriminator develops direct voltages of $\pm E_m$, which cause variations of the inductive reactance about the quiescent value, as shown in Fig. 78. Since the phase shift network shown in Fig. 76 draws a current I_p which leads E by 90 degrees, the alternating voltage applied to the grid of the reactance tube is jE_1 , i.e., the $\cos \omega t$ function when the oscillator voltage E is a $\sin \omega t$ function. Because of the linear transconductance curve, the variations in the plate current I_p caused by the discriminator voltage E_m no longer equal $G_m E_1$, but rather

$$I_p = G_m E_1 \pm G_m E_m$$

when maximum values of discriminator voltage are developed. Therefore, a peak voltage of

$$E_g = E_1 \pm E_m$$

appears on the grid of the reactance tube,

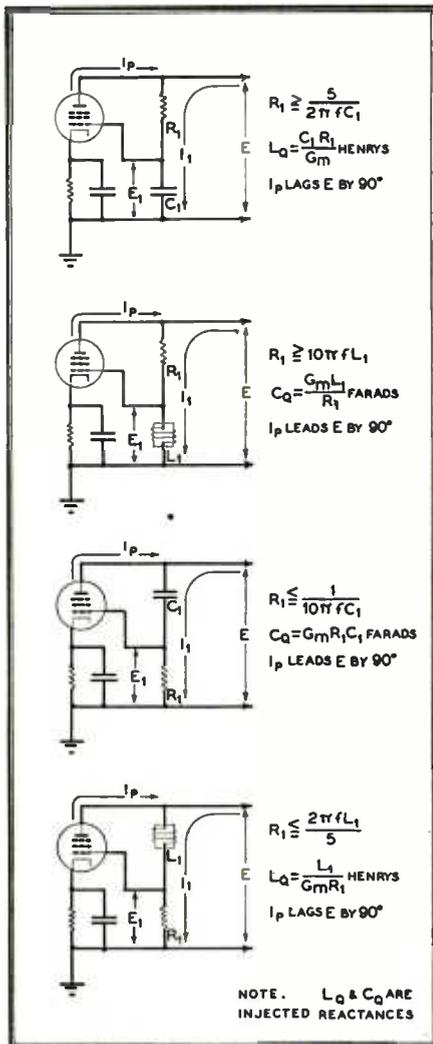

FIG. 80. REACTANCE TUBE ARRANGEMENTS

which causes the variation of the grid voltage time axis shown in Fig. 78.

Optimum conditions are realized when the alternating grid voltage E_1 and the discriminator voltage E_m are each ad-

justed to one-half the grid bias E_g . This results in an effective total grid voltage E of $1.5E_1$, instead of E_1 , when zero discriminator voltage E_m is developed. The total grid voltage E_g draws a plate current

$$\text{Peak } I_p = G_m E_1.$$

When an inductance is substituted for the capacitance in the phase shift network the following equation can be used to calculate the oscillator frequency when the discriminator voltage is zero:

$$f = \frac{1}{2\pi \sqrt{\left(C + \frac{G_m L_1}{R_1}\right) L}}$$

All values are in cycles per second, ohms, henrys and mhos. The effective oscillator frequency is governed not only by the L , C branches, but also by the capacitance C_Q supplied by the reactance tube circuit and L_1 in the phase shift network. The static value of C_Q is

$$C_Q = \frac{G_m L_1}{R_1}.$$

When the oscillator frequency f shifts by an amount Δf , a voltage $\pm E_m$ developed by the discriminator, causes the reactance tube to inject a reactance L_Q or C_Q into the oscillator tuned circuit L , C , which returns the oscillator to the original frequency f . The pull-back action created by the injected reactance is then

$$f_p = f \pm \Delta f.$$

This change in frequency, or pull-back action, is caused by the voltage $1.5E_1 - E_1$, or $0.5E_1$, applied to the grid of the reactance tube. The current $0.5G_m E_1$, with respect to the normal circulating tuned circuit current

$$I = \omega C E,$$

represents the change of current for the shift of the frequency from the nominal value to its maximum deviation. The bandwidth equals twice the frequency deviation, or

$$W = 2\Delta f.$$

Since

$$\Delta f = 39.83 \frac{G_m E_1}{C E} \text{ kc./sec.},$$

$$W = 79.7 \frac{G_m E_1}{C E} \text{ kc./sec.}$$

G_m is given in micromhos, and C in microfarads. E_1/E , being a numerical ratio, requires no units.

Complete Circuit * The complete system shown in Fig. 79 is an application of the principles already discussed. The discriminator is of the conventional type, and the Hartley oscillator requires no special comment. The reactance tube, using a combination fixed- and self-bias circuit, merits mention. The self-bias is developed across the cathode resistor, while the fixed bias is obtained across the screen-to-

cathode resistor. The self-bias improves stability, and the fixed bias increases the sensitivity of the reactance tube action, because degeneration due to the voltage

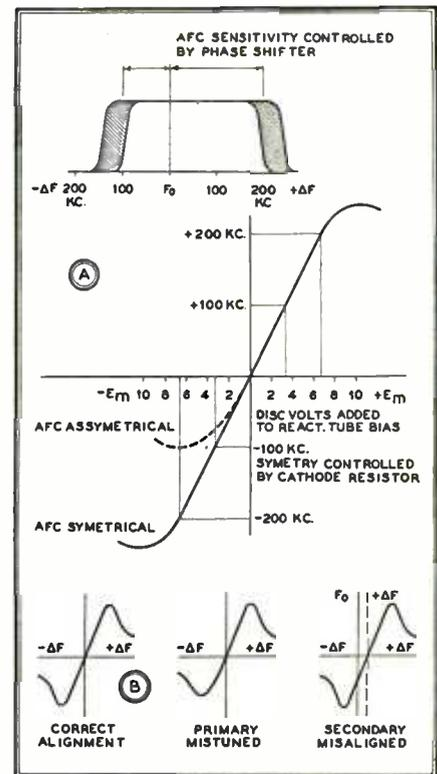

FIG. 81. EFFECTS OF CONTROL VOLTAGE

drop across the cathode resistor is reduced. Such a combined bias arrangement results in stable reactance tube action without sacrificing sensitivity.

The excitation voltage applied to the grid of the reactance tube is obtained from a phase shift network consisting of impedances Z_1 and Z_2 , where Z_1 is 5 mmf. , and Z_2 is $50,000 \text{ ohms}$. Four different reactance tube arrangements and their design equations are shown in Fig. 80.

A variable cathode resistor is used in the reactance tube circuit to permit adjustment of the cathode voltage. The resistor is adjusted for an initial bias in the center of the reactance tube characteristic, so that a symmetrical oscillator frequency control is realized for equal positive and negative changes in discriminator control voltage. The effect of this adjustment is shown in Fig. 81A. When the discriminator develops a positive voltage, a limiting point is reached in which the reactance tube biases itself by grid current through the filter resistor system. The bias attained is nearly equal to the peak value of impressed oscillator frequency control. Since the tube may operate under this condition for long periods, the screen voltage must be reduced to avoid excessive plate current and consequent shortened tube life. When the discriminator develops a negative voltage, control action is limited by plate current cutoff. With sufficient signal input to the discriminator rectifiers, the total

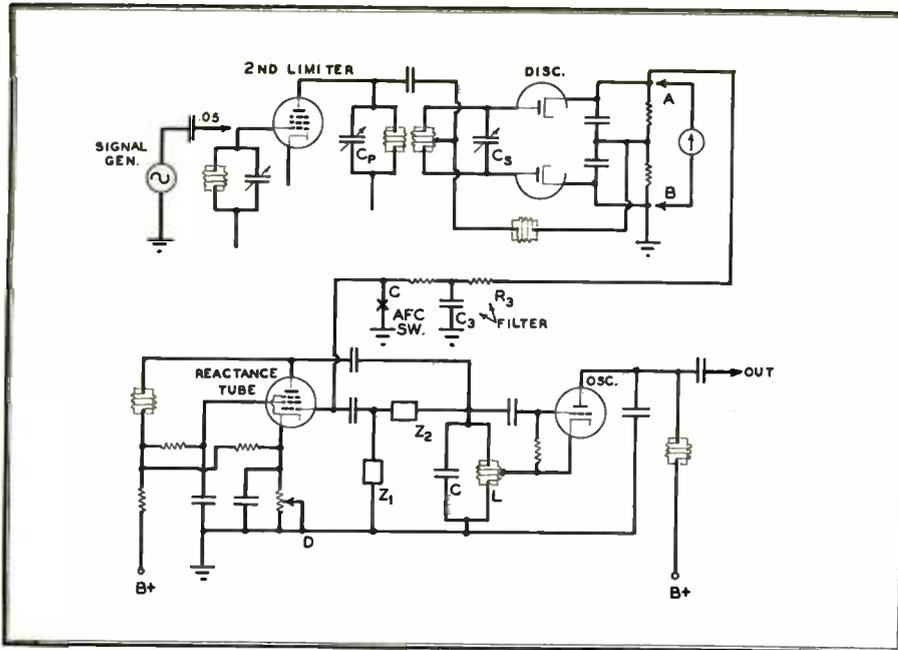

FIG. 82. SETUP FOR ALIGNING THE DISCRIMINATOR CIRCUIT FOR AFC

range of control is thus independent of the maximum value of voltage generated by the discriminator.

Equipment for Aligning ★ The process of aligning the discriminator and AFC networks in an FM receiver requires several pieces of equipment. A good signal generator which covers the frequency range with fundamental frequencies is necessary. In addition, a vacuum tube voltmeter with a center-zero scale, or some suitable substitute, such as a vacuum tube voltmeter with a left-zero scale combined with a polarity-reversing switch or a center-zero DC microammeter, must be at hand. If a DC microammeter is to be used, it should have an external series resistor of about 100,000 ohms to reduce the circuit loading. Visual alignment equipment, with a modulated signal generator, will facilitate the alignment process, but quite satisfactory results can be obtained with the equipment enumerated.

Aligning Discriminator ★ For aligning the discriminator circuit, the unmodulated output from the signal generator, adjusted to intermediate frequency, is applied to the grid of the limiter. The vacuum tube voltmeter, or microammeter, is connected to A and B, Fig. 82, and the signal generator is adjusted for maximum output. Adjust the secondary trimmer C_B of the discriminator transformer to exactly zero deflection. When making this adjustment, three positions of the trimmer will indicate zero deflection. One of these indications occurs when the trimmer capacity is at minimum; the second occurs at maximum capacity, while the third occurs at a position approximately midway between the first two. The minimum and maximum capacity adjustments of the trimmer are incorrect, and should be

avoided. The correct adjustment can always be recognized easily because of the fact that the indicator deflection changes rapidly from plus to minus, or vice versa, for a slight change in the trimmer setting.

When the secondary trimmer is adjusted properly, the primary trimmer C_P must be adjusted for maximum deflection of the meter. This is accomplished in the following manner: Increase the frequency of the signal generator to 75 kc. above the intermediate frequency. As this shift is being made, the meter will indicate an

not again be adjusted after the zero deflection is obtained.

The adjustment of the discriminator should now be tested for linearity. With the signal generator returned to the exact intermediate frequency, the indicating meter should again read zero if the secondary trimmer was not readjusted. Then tune the signal generator to 75 kc. below the intermediate frequency. As the signal frequency decreases, the meter will indicate an increasing negative voltage until the frequency shift is completed. At 75 kc. below the intermediate frequency, the indicated voltage should be exactly the same value as that at 75 kc. above the intermediate frequency, but of opposite polarity. If these voltages are unequal, it is necessary to retune the primary trimmer until the voltages are distributed equally on both sides of zero deflection. When this equality is achieved, the discriminator is properly aligned. Discriminator alignment curves are shown in Fig. 81B.

The alignment of the secondary branch of the discriminator network is very important, since the correct operation of the entire system depends upon it. The alignment determines the polarity and magnitude of the control voltage developed by the discriminator circuit. While the alignment of the primary branch is not critical and does not affect the phase relationship of the induced and coupled voltages across the secondary branch, it does determine the magnitude of these voltages. Hence it should be adjusted carefully. The tuning capacitor across the secondary winding controls the frequency at which zero control voltage occurs, and the primary tun-

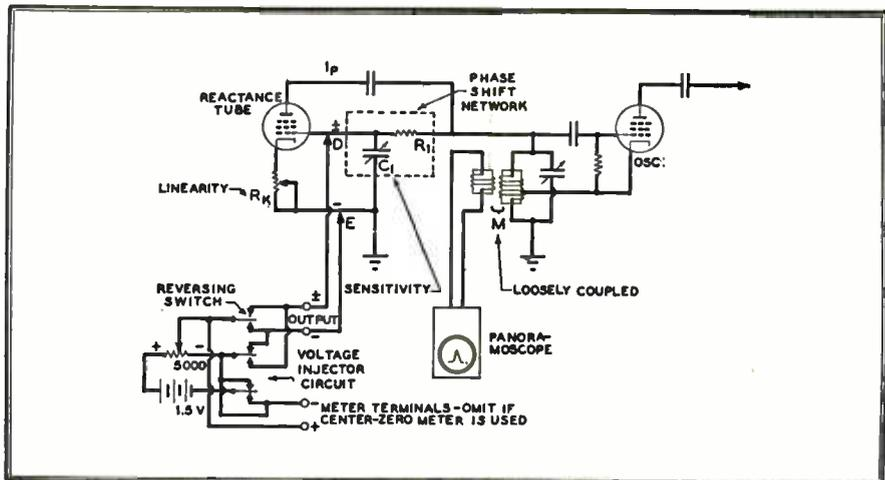

FIG. 83. CIRCUIT USED WITH PANORAMSCOPE FOR BALANCING THE AFC SYSTEM

increasing positive voltage until the frequency shift is completed. At the +75-kilocycle deviation, adjust the primary trimmer for maximum meter deflection. Should the meter pointer tend to move off-scale as this is done, it will be necessary to reduce the output from the signal generator. The adjustment of C_P is completed when the greatest deflection is obtained. The secondary trimmer C_B must

ing capacitor determines the amplitude and symmetry of the two peaks of the discriminator characteristic curve.

Holding Action ★ The holding action of the reactance tube can be ascertained in the following manner: Apply the signal generator output to the antenna terminals of the receiver, and adjust both the generator and receiver to the same frequency

in the desired spectrum. Short point C in Fig. 82 to ground so that no discriminator voltage will be applied to the grid of the reactance tube during this tuning adjustment. Leave the indicating meter connected to A and B, as for alignment of the discriminator.

Zero deflection of the meter should result when the signal generator and receiver are tuned to the same frequency. Then remove the shorting conductor from point C, so that the discriminator voltage will control the reactance tube. If the circuits are properly aligned the meter deflection will remain zero.

Increase the signal generator frequency by small increments, while noting the meter deflection. The meter will indicate an increasing positive voltage, until a point is reached where the indicator will abruptly return to a value slightly above zero. This near-zero deflection indicates that the reactance tube no longer controls the oscillator. The signal generator frequency should then be decreased slightly to the point of maximum meter deflection, i.e., just before control is lost, and the deviation in frequency from the center value should be noted. This frequency deviation represents the limit of the holding range in the positive direction.

Next, readjust the signal generator frequency to the original center value, decreasing it by small increments to the value which gives maximum meter deflection, as before. The frequency deviation at the point of maximum deflection, just before control is again lost, should be noted. This deviation represents the limit of holding range in the negative direction.

The positive and negative AFC holding limits should be symmetrical; however, any asymmetry can be corrected by varying the cathode resistor in the reactance tube circuit. The holding range will become broader as the signal input level is increased, as illustrated in the following table, data for which was taken on an experimental receiver using a 12SH7 reactance tube:

SIGNAL INPUT	AFC LIMIT
15 microvolts . . .	± 150 kc.
50 microvolts . . .	± 250 kc.
100 microvolts . . .	± 300 kc.

Balancing * To balance the AFC system, when necessary, a simple circuit consisting of a battery and a double-pole, double-throw switch is very helpful. The circuit is shown in Fig. 83. The output terminals D and E are connected to the reactance tube grid and ground. When balancing is necessary, the receiver and signal generator are adjusted to the same frequency f_0 , after shorting point C, Fig. 82, to ground. The meter across the discriminator output will indicate balance, or zero deflection. The artificial discriminator voltage supplied by the battery is applied between the reactance tube grid and ground. This battery voltage is adjusted by means of the potentiometer to deflect the meter to some positive value, for example, 100 kc. The switch is then snapped over, reversing the polarity of the voltage applied to the grid of the reactance tube. The meter will now be deflected in the opposite direction. If the positive and negative deflections are not symmetrical, the cathode resistor R_K in the reactance tube circuit is adjusted while alternately applying positive and negative voltages to the grid, until a point is reached where symmetrical deflection takes place. The battery circuit is then disconnected and the AFC holding action is determined as outlined in the preceding paragraphs. Should the AFC action be such that the reactance tube pulls away from the desired mean frequency f_0 , it will be necessary to reverse the discriminator cathode leads.

Linearity and Sensitivity * The adjustment of AFC linearity and sensitivity will be facilitated if a panoramoscope is available. The output of the signal generator is reduced to zero and a voltage injector circuit, similar to the one shown in Fig. 83, is connected to the reactance tube. A

20,000-ohms-per-volt voltmeter, or a microammeter, is connected across the voltage injector as shown. The receiver is tuned to a desired frequency f_0 , and the panoramoscope is loosely coupled to the receiver oscillator tuned circuit and adjusted to the frequency f_0 of the receiver. This adjustment is made so that the resultant "pip" is centered on the screen of the panoramoscope, indicating that both equipments are tuned to the same frequency. The voltage injector is adjusted to 1 volt output, and the reversing switch is moved to the positive position. The pip on the panoramoscope screen will shift to the right of the center reference line, representing an actual shift in the oscillator frequency due to the action of the reactance tube. The injector switch is then reversed to apply 1 volt negative to the grid of the reactance tube. The pip on the screen of the panoramoscope will shift to the left of the center reference line, indicating a frequency deviation in the negative direction.

If an applied injector voltage of one volt is insufficient to deviate the receiver local oscillator ± 75 kilocycles, the sensitivity capacitor C_1 , Fig. 83, must be adjusted with a non-metallic alignment screwdriver to add sufficient sensitivity to the AFC circuit to produce the required control range. The receiver tuning control is adjusted to give zero deviation, as indicated on the panoramoscope, each time the capacitor C_1 is changed. The linearity of the AFC circuit can be determined by varying the injector voltage in steps of 0.25 volt from 0 to 1 volt. For a given voltage, the difference should not exceed 1 kc. between the positive and negative frequency deviations shown on the panoramoscope. If the AFC is non-linear, the cathode resistor R_K must be adjusted until equal positive and negative frequency deviations are obtained with a given injected voltage. The alignment of the receiver oscillator should be re-checked, since the adjustment of the AFC sensitivity capacitor C_1 will vary the frequency.

ACKNOWLEDGED STANDARD OF FM PERFORMANCE

A Truly Universal FM Receiver

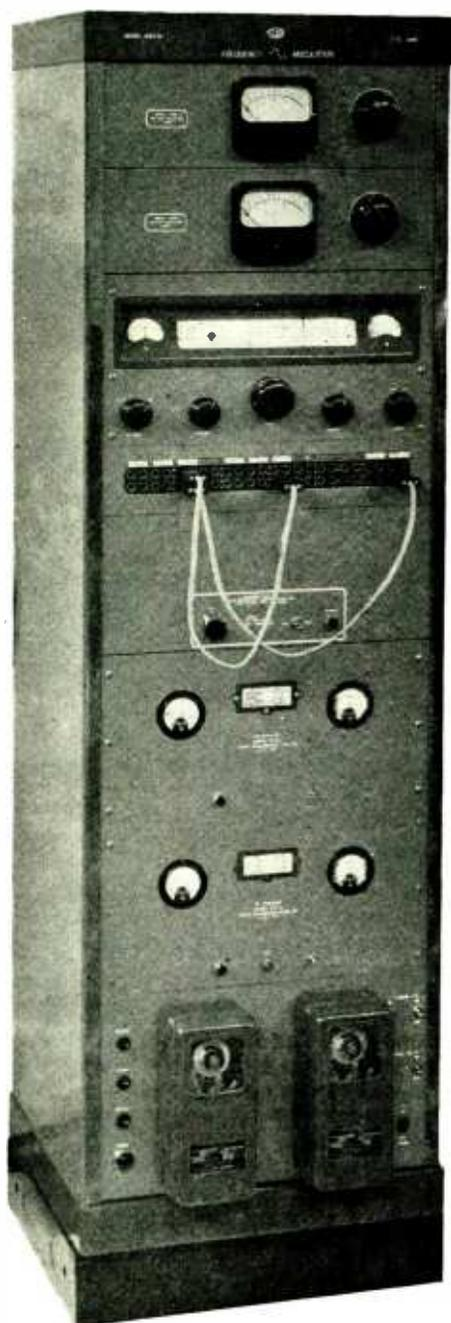

\$345 646-B ONLY, WITH 19-IN. PANEL OR IN METAL CASE

OF all radio receivers, only the REL 646-B is equally at home in research laboratories, broadcast stations, and private residences. You might say that it is a highly versatile piece of scientific apparatus. You'd be equally correct in calling it a home receiver of such precision design that it is also used in Government, college, and commercial laboratories, and sound studios.

The particular 646-B in the accompanying illustration—third panel down from the top—was installed as a repeater in an FM radio relay station. But it might have been shipped to the home of a listener who had decided to own the finest receiver that money can buy.

The most amazing things are done with these REL receivers. Sound studios and broadcast stations use them for off-the-air-disc and tape recordings of live talent shows carried on FM. In private homes, too, an increasing number of people use the 646-B with a Magnecord tape unit to record and play back radio programs, or to record speech and music from a microphone in their own homes.

Many people who have these receivers and special speaker installations are now using them in place of the audio circuits in their television sets. Others buy TV chassis, such as the Radio Craftsmen type, with require external

audio amplification. The 646-B has the necessary connections and a switch at the left of the panel to change from FM reception to any source of external modulation.

Sales records show that these receivers are also going into a great variety of installations for hotels and other public buildings where both static-free FM reception and recorded music are required. The 646-B delivers 10-watts of clean audio output. If additional power is necessary a Brook, McIntosh, or other power amplifier can be added. Such a system is ideal for driving a Klipschorn, or any of the other extra-quality speakers.

Sometimes we are told: "The REL receiver costs a lot more than any other." Well, while you are making comparisons, try lifting each receiver with one hand. Be careful of the 646-B, though. It weighs 35 pounds!

If you are handling equipment of this quality, either as a dealer or a professional custom set-builder, write for information as to the trade discount and deliveries.



RADIO ENGINEERING LABORATORIES, Inc.

35-54 36th STREET,
LONG ISLAND CITY 1, N. Y.

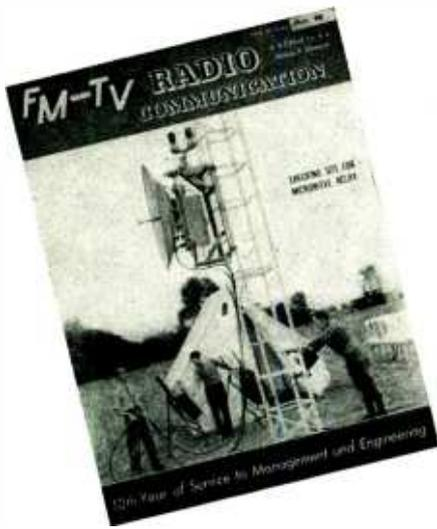

Established 1940
Subscription rate \$3 per year

The only complete source of information on mobile and point-to-point equipment and systems — Published for those engaged in the field of Radio Communications

Radio Communication Magazine serves the essential purpose of presenting complete, authoritative, and well-illustrated information on developments in the entire communications field. For the past ten years, this Magazine has devoted more editorial pages to this subject than all other radio publications combined. It covers not just one particular service, but all the common carrier, industrial, safety, and transportation services.

IF you remember when the Connecticut State Police went on the air with the first FM mobile radio system, then you know when Radio Communication Magazine started. That was back in 1940 when "mobile radio" was limited to a few one-way AM police installations.

Month by month, *FM-TV* or, as most people call it now, Radio Communication Magazine, has had the leading part in making information on new developments available to communications engineers, supervisors, operators, and maintenance men.

To take one example: We published a detailed account of the successful operation of Miami's 118-mc. police installation at a time when most engineers were convinced that 70 mc. was about the top operating frequency for mobile units, and that the proposed band of 152 to 162 mc. was virtually worthless!

The rapid and continuous progress of radio communication makes it necessary for every man engaged in this field to keep himself posted on new types of

systems, new transmitters, receivers and test equipment, antennas, progress in the use of higher frequencies, and in the more effective use of channels assigned to these services.

You'll notice that articles in Radio Communication are all written by leading authorities, the very men responsible for the work they describe. These are exclusive articles, presenting information that can be obtained from no other source. A monthly feature is Jeremiah Courtney's "Mobile Radio News and Forecasts," and twice a year detailed specifications are published on all standard mobile and fixed transmitters and receivers. This data is complete right down to current drain and tube types and functions.

The cost is small—only \$3.00 a year (12 issues) or \$6.00 for three years (36 issues). The value to you will be many times this amount. Use the subscription order form bound into this copy of the Mobile Radio Handbook.

ANNUAL COMMUNICATION SYSTEMS REGISTRIES

AS an added service, we publish the only annual Registries of Communication Systems. These listings include the name and address of each licensee, location of the transmitter control, frequency, call letters, number of mobile units, and make of equipment used.

Originally, these Registries were carried in the Magazine. Now, however, the number of listings has grown to the point that they are published separately, in book

form. Each Registry is revised annually, and new editions are printed as follows:

- No. 1. Common & Miscellaneous Carriers and Industrial ServicesJanuary
 - No. 2. Public Safety ServicesJuly
 - No. 3. Transportation ServicesNovember
- Copies of these Registries are available at \$1.00 each, postpaid. Orders should be placed in advance of the dates shown, as each edition is limited.

RADIO COMMUNICATION MAGAZINE

SAVINGS BANK BUILDING, GREAT BARRINGTON, MASSACHUSETTS

HICKOK

MOBILE RADIO

Test Equipment

COMPLETE MATCHED BENCH

534BD

209AD

292XD

505AD

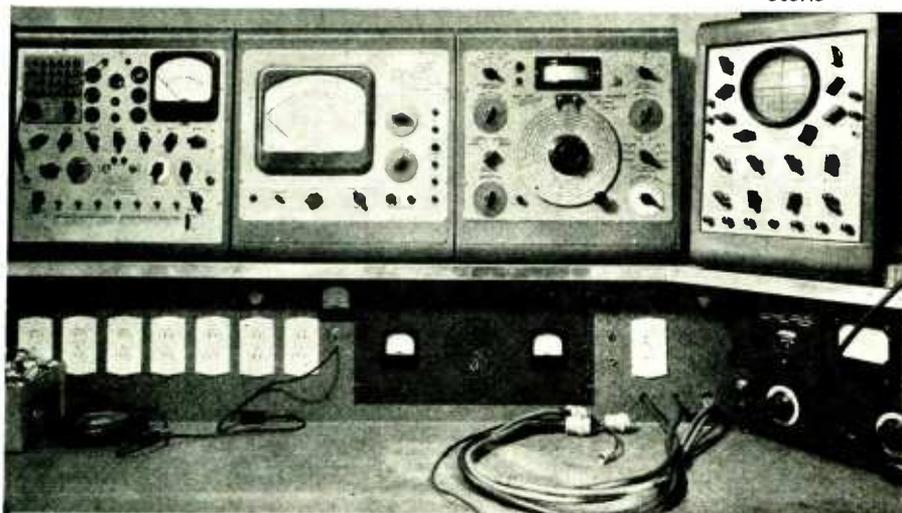

Mobile Radio Service Center, Erie, Pa.

**NEW FCC DECISION
LAST MAY CAUSED
MOBILE RADIO BOOM**

Many additional systems
have been licensed with
hundreds of new units
already in operation.

Safeguard your reputation and build sound service profits in this fast-growing mobile field. Start now, with a completely equipped HICKOK bench.

See the HICKOK "Mobile Matched Set" at your jobber's today.

With HICKOK equipment you can consistently do better work in less time. HICKOK instruments are used by thousands of top-grade servicing technicians the world over.

ELECTRICAL INSTRUMENT COMPANY
10530 DUPONT AVENUE CLEVELAND 8, OHIO
Finer Testing Instruments Since 1910

HICKOK

NOTES ON FM HISTORY

HIGHLIGHTS FROM THE STORY OF FM'S PROGRESS, FROM INVENTION TO FINAL HARD-WON ACCEPTANCE

WHILE the technical details of Major Armstrong's invention of Frequency Modulation were told in his original I.R.E. paper, the story of his work was described only in terms of measurements and apparatus.

However, every engineer who has worked over the solution of problems that required original thinking knows that the facts of science are only the out-

ward manifestations of the very human struggle by which they are produced.

Research which has an end in itself is rare. There is usually some good incentive for it, some problem for which a solution is needed. A scientific definition of research might be, "The correlation of previously unrelated facts, through reason and experiment, to discover new facts." It should be quite obvious that

inventions are not created by mathematics and equipment. They are only tools. They are merely the means to the end sought by the man who uses them. They are of value only as he can relate what they show to other knowledge, and thus find the path which leads to ultimate success.

To many an inventor, there is satisfaction enough in finding the way to the solution of a problem. But that is purely selfish satisfaction for, if effort stops at that point, there is no benefit to society, and nothing real has been gained. Indeed, the work is wasted, and the invention is lost if it is not carried on to a state of reality to provide useful service.

It is very interesting to see how these two phases in the invention of the FM system were marked by log book entries in the records kept at Westhampton Beach, Long Island, and at Alpine, N. J.

The former was the location of the receiving equipment used for the first long-distance tests of FM transmission from the NBC station at the Empire State Building. Alpine was the site of FM broadcast station No. 1, set up by Major Armstrong.

The Westhampton tests, proving that the FM system did show a tremendous reduction of static over AM *on the same frequency*, represent the completion of the first phase of this invention.

Exactly what took place on this occasion is described in the entries reproduced here from the original log. The first part is in the handwriting of C. R. Runyon. Entries from 11:15 to 11:45 were made by George E. Burghard, at whose home the equipment was set up. The conclusion was written by Major Armstrong.

Log—

Westhampton Beach, L. I.

June 9, 1934—Daylight Saving.

9:10 A. M. Received carrier from W2-XDG (W2XF)—on amplitude—1,000 cycle tone.

9:57 A. M. Frequency Modulation system on at Empire State no modulation.

10:07 A. M. 1,000 cycle tone, frequency modulation.

10:17 A. M. Music — freq — modulation.

10:23.5 A. M. Perfect!

11:15-11:30 A. M. Changing from frequency to amplitude modulation full carrier — half carrier — Hundreds or thousands (of times) more noise on amplitude.

These tests made with half wave vertical pick up capacity coupled to 2nd rf stage. Also coupled same antenna to detector and still got perfect reception.

11:45 A. M. Put on V antenna and listened to organ recital from chain. Low notes fully reproduced.

(Continued on page 170)

... for the best reception of both FM and AM

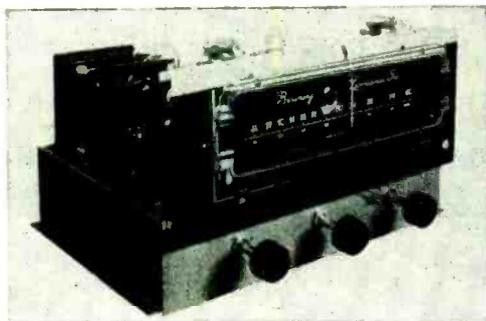

BROWNING RV-10 FM TUNER

High-sensitivity FM reception can be added easily to any AM receiver. The moderately-priced **BROWNING RV-10** tuner is designed for that purpose. A tuned RF stage with an Armstrong dual limiter and discriminator produce complete noise limiting with signals of less than 10 micro-volts. This is the same FM section as in the RJ-12A and RJ-20. Controls: phono switch, radio-phono volume, and tuning. Tubes: three 6AU6, one 7F8, two 6SJ7, one 6H6, one 5Y3 rectifier, and 6AL7 tuning eye. As illustrated, or on a 19-inch rack panel.

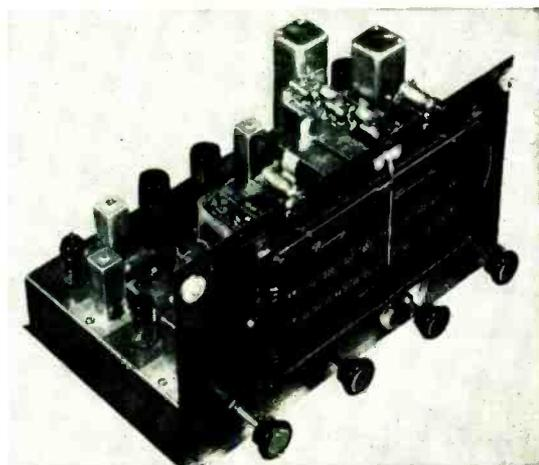

BROWNING RJ-12A FM-AM TUNER

This model combines high-sensitivity FM reception from an Armstrong circuit that limits noise completely on signals of less than 10 microvolts, with the best reception of AM broadcasting. FM and AM circuits are completely separate. FM audio response is flat within 1½ db from 20 to 15,000 cycles. No drift after 2-minute warming. AM is flat within 3 db from 20 to 6,600 cycles. Front phono switch and combined radio-phono volume control. Tubes: three 6AU6, one 7F8, one 6SK7, one 6SG7, two 6SJ7, one 6H6, one 6SA7, one 1N34 detector, one 6AL7 tuning eye. Operates from separate PF12 power supply with one 5Y3GT. As illustrated, or on a 19-in. rack panel.

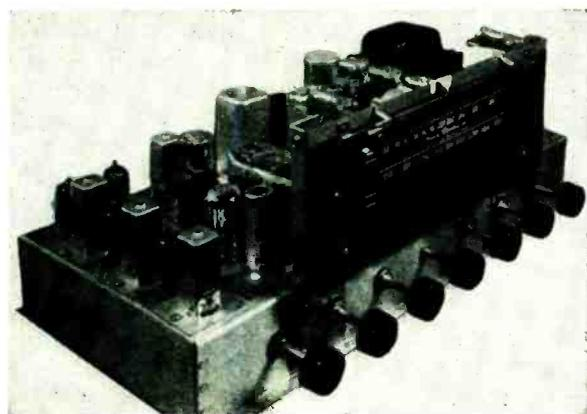

BROWNING RJ-20 FM-AM TUNER

The RJ-20 is intended particularly for those who require superlative reproduction quality on both radio and records. Armstrong circuits, incorporating every refinement, deliver the full promise of FM's interference-free performance with maximum receiving range. Variable IF bandwidth allows AM selectivity adjustment from 4 to 9 kc. A 2-stage audio system is built in to provide separate treble and bass boost up to 20 db for record reproduction. Tubes: Five 6AU6, one 7F8, one 6SG7, one 6SA7, one 6SK7, two 6AL5, one 6NS7, 6AL7 tuning eye, 5Y3GT rectifier. As illustrated, or on a 19-in. rack panel.

For Complete Technical Data on These FM and FM-AM Tuners, Address:

BROWNING LABORATORIES, Inc.

700 Main Street, Winchester, Massachusetts

FM HISTORY

(Continued from page 168)

1:00 P. M. W2XDG signed off. All tests performed exactly according to Hoyle. This experiment concludes just twenty years of work on this problem. It is with the deepest gratification that I record here that my two oldest friends, George Burghard and Randolph Runyon, old timers who saw the genesis of regeneration, took part in the culmination of this work. An era new and distinct in the radio art as that of regeneration is now upon us.

After ten years of eclipse, my star is again rising.

Edwin H. Armstrong

The "culmination of this work" represented only the inventor's personal satisfaction over the evidence that he had truly overcome static and that, in so doing, had not sacrificed but had improved the quality of reception.

He might very well have stopped at that point, for the system and its performance were received by the industry with complete indifference. Actually, on June 9th, 1934, while he was recording the conclusion of the first phase of his work, the log shows that he was preparing to bring about that "era as new and distinct in the radio art as that of regeneration."

The second phase extended over a period of five years, spent in laying the groundwork for the commercial application of FM in the service of public interest, convenience, and necessity.

A year's work at the Empire State Building transmitter brought no progress in the adoption of FM, and in the summer of 1935 he was asked to remove his apparatus to make room for television. Comments on Major Armstrong's paper at the November, 1935 meeting of the I.R.E. with a few exceptions, generally expressed the feeling that the system was "a visionary development many years in advance of broadcasting's capacity to utilize it."

The exceptions were limited to engineers whose experience dated back to the days before broadcasting began, for they had seen other revolutions take place. Those who had come into radio with the advent of broadcasting were unable to visualize a revolutionary change.

Some engineers expressed surprise that the man who had made such practical contributions to the art as regeneration, the superheterodyne, and super-regeneration should propose the use of a system so radical that it would require revision of the entire broadcasting structure. Nor did these engineers foresee that future circumstances would bring about the

(Continued on page 172)

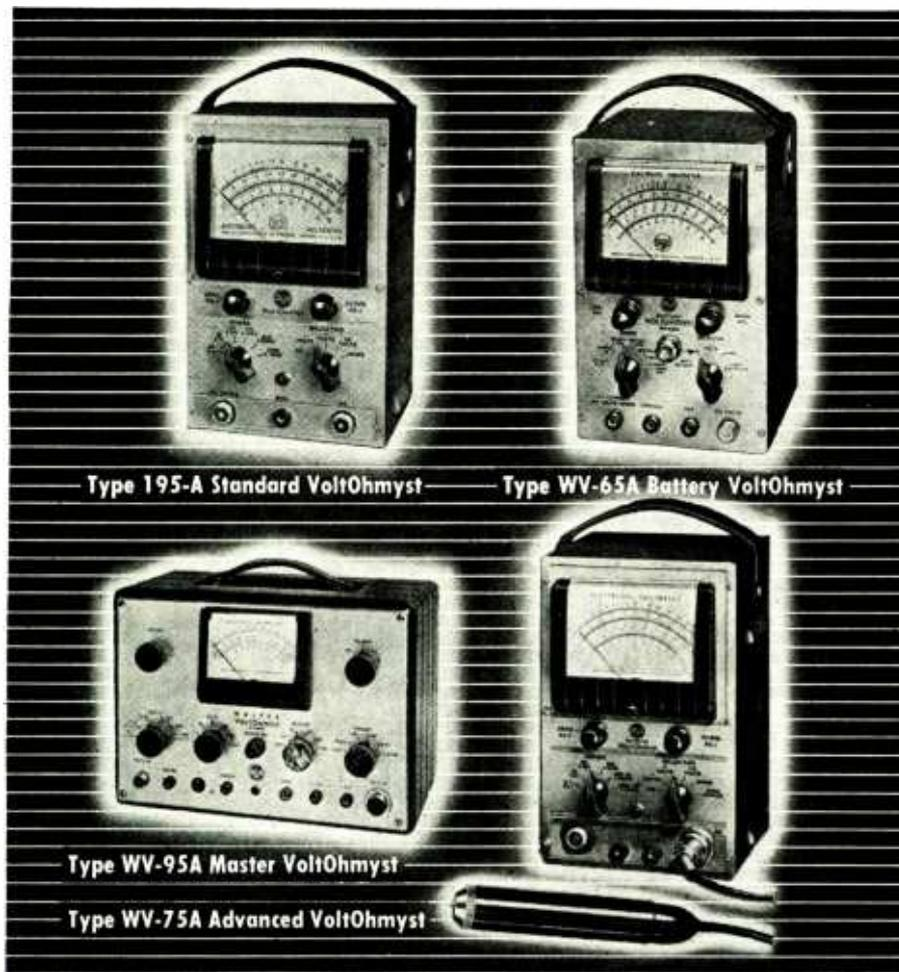

ONLY RCA MAKES THE VOLTOHMYST*

For high input resistance . . . accurate readings despite line voltage changes . . . full overload meter protection . . . stability under all conditions of operation . . . buy an RCA VoltOhmyst!

Type 195-A Standard VoltOhmyst: The "work horse" of electronic meters. Measures ac and dc voltages to 1000 volts, resistance to 1000 megohms, in six ranges. Reads db at all audio frequencies. Has zero-center scale for discriminator alignment. 10-megohm dc input resistance insures good accuracy. WG-263 accessory Crystal Probe permits ac voltage measurements to 100 Mc.

Type WV-95A Master VoltOhmyst: Truly the "master" electronic multimeter, this versatile instrument measures ac and dc voltages to 1000 volts, dc current from 1 microamp. to 10 amps., resistance from 0.1 ohm to 1000 megohms, and capacitance from 4 μf to 1000 μf . Pointer may be zero-centered for discriminator alignment. WG-275 Diode Probe accessory available to extend ac voltage measurements to 250 Mc.

Type WV-65A Battery VoltOhmyst: The completely portable instrument that

works anywhere. Batteries last up to 10 months. Measures ac and dc voltages to 1000 volts, resistance to 1000 megohms, and direct current to 10 amps. WG-263 accessory Crystal Probe permits ac voltage measurements to 100 Mc.

Type WV-75A Advanced VoltOhmyst: A versatile instrument for TV and HF measurements. Reads flat to 250 Mc. Measures peak-to-peak voltages. Measures ac and dc voltages to 1000 volts, resistance to 1000 megohms. Complete with diode probe.

Ask about the new High-Voltage Probes WG-284 and WG-288 to extend the dc voltage range of these instruments to 30,000 volts.

Get further details on the RCA VoltOhmyst of your choice from your RCA Distributor, or write RCA, Commercial Engineering, Section A65X, Harrison New Jersey.

*Trade Mark "VoltOhmyst" Reg. U. S. Pat. Office

Available from your RCA Test and Measuring Equipment Distributor



RADIO CORPORATION of AMERICA

TEST AND MEASURING EQUIPMENT

HARRISON, N. J.

HAMMARLUND P-B

The Perfected System of SELECTIVE CALLING and SUPERVISORY CONTROL

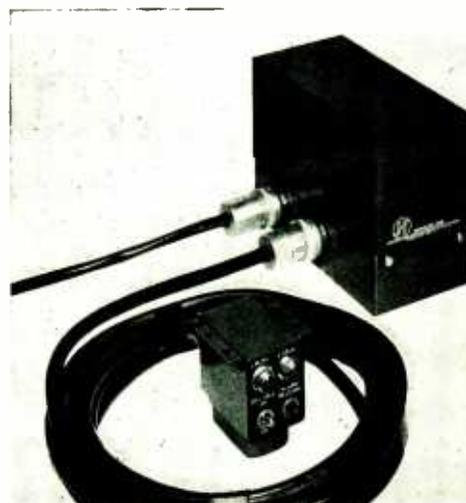

MOBILE DECODER AND CONTROL UNIT

The new Hammarlund Push Button system of Selective Calling, perfected after five years of research, is ready for the instantaneous operational requirements of mobile radio. Loudspeaker and transmitter lockout, with an accompanying busy signal, provides the only "privacy" system available at a moderate price. Extensively field tested by such exacting users as the independent telephone companies in their urban operations, the equipment has proven trouble-free and easily maintained. The simplicity provided by single tone sequential pulse counting makes possible the use of economical band pass filters with sharp-skirt, flat-top characteristics. These filters (selective enough for 75-cycle operation without adjacent tone-channel interference) eliminate false calls due to noise or voice triggering. The Ham-

marlund system is unsurpassed for versatility. In addition to mobile radio, it is used for remote signalling or switching by radio. Engineers are available for consultation on your system requirements.



INSTANTANEOUS 40-BUTTON SELECTIVE CALLING UNIT AND AUTOMATIC CODER

Address inquiries to:

HAMMARLUND MFG. COMPANY, INC.

460 WEST THIRTY-FOURTH STREET, NEW YORK CITY, N. Y.

Requested by
**MAINTENANCE
 ENGINEERS...
 OPERATORS...**

Recommended by
**COMMUNICATIONS
 MANUFACTURERS...**

**SHURE
 MICROPHONES**
 are the "FIELD PROVED"
**STANDARD in MOBILE
 COMMUNICATIONS**

SHURE

At the Transmitter.....

Here's the famous "55" Unidyne Dynamic—the favorite microphone of police forces... taxis and trucking lines... government agencies... radio stations throughout the world. There must be a reason for its amazing popularity. Year in—year out dependable performance of the highest standards.



Shure "55"
 Unidyne Dynamic
 List Price **\$67.50**



"100" Series
 Carbon Microphone
 List Price **\$30.00**

.....In the Car.....

This is the "old faithful" Shure "100" Series Carbon—a microphone that can take it under the most severe handling and "knocking around" a microphone could get. Under any and all circumstances the mighty "100" Series Carbon will "get the message through."

SHURE BROTHERS, Inc.

Microphones and Acoustic Devices

225 West Huron Street

Chicago 10, Illinois

Cable Address: SHUREMICRO

The Original
Carter
 Genemotor



for TAXICAB, MARINE
 and Police
 Mobile Radios

Unequaled performance and dependability are assured when you specify Carter Genemotor Power Supplies. The favorite for over 15 years.

***** SPECIFICATIONS *****
 Frame capacity 80 watts cont. 150 watts int. (up to 400 watts, on Marine models only.)
 Input volts DC—3.5 to 115
 Input current DC—up to 50 amps.
 Output volts DC—up to 800 volts
 Output current DC—up to 500 MA.
 AC ripple content—1% or less
 Overall efficiency—50-75% average
 Output regulation—20% no load to full load
 Starting time—300 milliseconds average



2641 N. MAPLEWOOD AVENUE



Carter Genemotor 7-1/16" long, 4-1/8" wide, 3-1/2" high. Weight only 10 lbs.

Check These features

- Small size—Can be mounted on its side.
- Reliable—100,000 transmissions without servicing.
- Armature triple insulated. Transformer grade laminations. Static and dynamically balanced. Precision ball bearings require NO lubrication.
- Super Precision—Frames line reamed to .0001 accuracy.

WRITE

New 24 page Dynamotor catalog No. 649 just released. Genemotors, Magnomotors, Dynamotors and complete technical information. Write today.

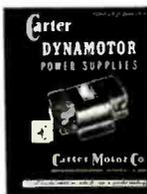

FM HISTORY

(Continued from page 170)

widespread use of FM in the police and emergency fields, or that it would serve on every front of a total war! Particularly notable was the use of FM relays for communications over the English Channel.

Since the demonstrations of transmission from the Empire State Building had reached an inconclusive end in the spring of 1935, so far as commercial application was concerned, Major Armstrong set about planning a 20 kw. FM transmitter of his own. During this period, he had recourse to amateur station W2AG, owned by C. R. Runyon, at whose home an FM transmitter was installed. This was used for the demonstration at the November, 1935 I. R. E. meeting, and for scores of other demonstrations up to the time Alpine went on the air. The log of W2AG is highly interesting, and its story may be told some day.

There was opposition to this idea in the engineering department of the FCC, but in July, 1936 he was granted a construction permit for such a station to be erected at Alpine, N. J. The permit did not become effective until the end of 1936. In the spring of 1937, construction was started.

(Concluded on page 174)

ONLY THE DOOLITTLE **FD-12**

gives you all these features

IN ONE DIRECT-READING

Frequency and Modulation Monitor



Handles up to 4 Frequencies Anywhere Between 25 Mc. and 170 Mc. Checks Frequency Deviation and Percentage of Modulation.

The FD-12 is a direct-reading device for checking frequency deviation and percentage of modulation for the emergency services employing the narrow band of transmission in the frequencies between 25 Mc. and 170 Mc. and is designed to operate on one, two, three or four frequencies. It is possible to use two frequencies in the 30-50 Mc. band, one frequency in the 72-76 Mc. band and one frequency in the 152-162 Mc. band, or any combination of frequencies up to four.

When the equipment is provided for operation on frequencies occurring in different bands the unit is provided with plug-in type antenna coils for those frequencies which are in different bands. No adjustments are necessary when changing bands other than to change the position of the selector switch and change the antenna coil.

The unit employs crystals which are thermally controlled for all frequencies. The accuracy is guaranteed to be $\pm .0015\%$ over the range of 15° to 50°C.

IF and discriminator are calibrated and centered by means of a local oscillator. This oscillator may be directly compared with WWV with the aid of a communication receiver. The unit has self-contained means for setting IF and discriminator.

Direct reading of modulation up to 20 Kc. on positive or negative peaks and the peak flasher to

show over-modulation can be set at any value from 5 to 20 Kc. for either positive or negative peaks.

The sensitivity for measuring is 1000 microvolts or less across the antenna terminals. Twelve miniature and one GT tubes of the most advanced design are used in a proven circuit that has won wide acceptance in the field.

Construction of the unit is all aluminum, with baseplate provided to prevent dust collection. The entire equipment is mounted on a panel measuring 8 $\frac{3}{4}$ " x 19" and is 14" deep. It can be rack mounted or provided with a cabinet. The panel is handsomely engraved and is furnished in black anodized finish.

A 500 ohm output is provided for audio monitoring and the circuit is so designed that it is possible to measure distortion in a transmitter with an external distortion meter. Power consumption is 80 watts. Operates on 110 volts 60 cycle AC. Shipping weight is 60 lbs. Meets all FCC requirements.

Doolittle
RADIO, INC.

Builders of Precision Communication Equipment

7421 SOUTH LOOMIS BLVD., CHICAGO 36, ILLINOIS

RCA TUBES ...

The complete line
for mobile
communication



RCA-2E26
Beam Power Tube

... available from your
local RCA Tube Distributor

The quality and ruggedness of RCA tubes are your best insurance against service failures in mobile equipment.

Your local RCA Tube Distributor carries a complete stock of RCA tubes to give you fast, local service.

For data on any specific tube type, see your RCA Tube Distributor, or write RCA, Commercial Engineering, Section A65T, Harrison, New Jersey.



RADIO CORPORATION of AMERICA

ELECTRON TUBES

HARRISON, N. J.

FM HISTORY

(Continued from page 172)

Here were new difficulties to be overcome, but the log of station W2XMN was finally opened, and this entry was made on page 1:

April 10, 1938

4:10 P.M. Frequency — Carrier on — 43.7 mc/600 watts input to transmitter (Using temporary antenna).

This was not for purposes of transmission, but only to test for the proper termination of the transmission line.

Subsequent entries were made during the further progress on the installation until, on page 132, the start of the first regular schedule of FM broadcasting was recorded:

Tuesday, July 18, 1939

First day — regular schedule on the air at 10:50 A. M. — 80-kw. input. Programs consisted of records played at Alpine.

4:01 P.M. WQXR programs 11:00 P.M.

Thus the second phase of the invention of FM drew to a close, for the performance of the Alpine station was conclusive and convincing evidence to broadcasters and manufacturers alike that a new era had come to radio.

The manner in which it came about, however, was not anticipated at that time. While the early commercial stations were being installed, and receivers for home use were started in production, a state-wide, 2-way FM communications system was going into service for the Connecticut State Police. Also, the performance of FM, successful even beyond the hopes of its sponsors, attracted the attention of the Signal Corps, and led to a gruelling series of AM vs. FM tests of communication with tanks. When the scores were added, FM was found to be far in the lead, and orders were placed for quantities of FM tank installations.

In the midst of all this activity came the attack on Pearl Harbor, followed by the freeze order which stopped all production of civilian military radio equipment. This did not stop the progress of FM. On the contrary, it was accelerated immediately, for the war brought a heavy demand from police departments, particularly in cities along our coasts, for 2-way FM apparatus.

At the same time, the mobile nature of the fighting created the need for radio equipment in every type of military vehicle. FM equipment to the value of over ½ billion dollars was produced for our Armed Forces. Col. Grant A. Williams, Chief Signal Officer of the 1st Army, said this of its performance: "Wherever FM and AM equipments are used for the same purpose, FM proves distinctly superior."

MORE *Andrew* FIXED STATION ANTENNA EQUIPMENT IS USED THAN ANY OTHER KIND!



HERE'S WHY: The topnotch engineering that only the world's largest antenna equipment specialists can give . . . the uniform dependability of Andrew equipment . . . its superior performance . . . the fact that only Andrew makes a complete line of fixed station antenna equipment.

But that's not all. An imposing parade of "firsts" maintain Andrew leadership. Some current Andrew "firsts" are 1) the exclusive Folded Unipole Antenna, 2) the new Hurricane Models, 3) the Corner Reflector Antenna, and 4) a Very High Gain Communications Antenna soon to be announced.

COAXIAL CABLE, Type 737. Significantly, there is more of this Andrew 7/8" diameter cable now in use than all similar makes combined! You get a bonus of extra miles added to your service radius because loss characteristics are exceptionally low.

FOLDED UNIPOLE ANTENNAS. Another Andrew "first" and made only by Andrew. Thousands of these popular antennas are in use at fixed stations throughout the world. More new stations are using it than any other antenna. Users acclaim 1) its quieter reception produced by the grounded radiating element, 2) the excellent impedance match, and 3) its greater transmitting coverage.

Extra! Now available in Hurricane Models to insure uninterrupted operation when you need it the most.

COAXIAL ANTENNAS. Most economical where signal-to-noise ratio is high. Above 108 MCS only.

CARDIOID ANTENNAS. If you operate along a shore or border line and want your signal to cover only a certain 180° area, this rugged antenna is made to order for you. It concentrates your signal where you want it and doesn't waste radiation where you don't want it.

CORNER REFLECTOR ANTENNAS. For narrow angle coverage or point-to-point relaying. Concentrates your signal in the exact area where you want it, using a 60° beam. Avoids interference to and from the remaining area. For the 72-76 and 148-174 MCS bands. Only Andrew makes a commercial model of this special purpose antenna—another Andrew "first."

It will pay you, too, to use Andrew fixed station equipment. Write for further information—today!

VERY HIGH GAIN COMMUNICATIONS ANTENNA (soon to be announced)

The highest gain antenna in mobile communications history. It actually delivers the full gain of 6.5 db as claimed—the same as increasing your power 4½ times! Think of the economy. Now, for the first time, you can cover areas you couldn't reach before! It's another pace-setting Andrew "first." Frequency range is 148-174 MCS.

Andrew

CORPORATION

363 EAST 75th STREET · CHICAGO 19

World's Largest Antenna Equipment Specialists





RF CABLES AND CONNECTORS
for Instruments and Test Equipment

The proof of the instrument is in the using!
And instruments are no better than their components. That's why Amphenol's perfected RF Cables and Connectors are chosen again and again to meet today's demand for accurate and proven material for instruments and test equipment.

In all types of highly-perfected RF Connectors, as well as in all RF Cables, materials are precision-manufactured to pass rigid inspections . . . top quality and performance is assured through exhaustive, regular tests conforming to Amphenol's usual high standards.

In addition to Amphenol's standard line of RF Cables and Connectors, various modifications and special types can also be supplied on special order. Whether you need one small part or a million complete assemblies, Amphenol's vast research, testing, and engineering experience is at your service.



Send for Amphenol Catalog D-1 providing a ready reference to the regular line of Amphenol RF Cables and Connectors, plus functional illustrations and tabulated data showing connectors needed for selected cables. Write to Dept. G on company letterhead for your copy.



AMERICAN PHENOLIC CORPORATION

1830 SO. 54TH AVENUE • CHICAGO 50, ILLINOIS

**POINT · TO · POINT
COMMUNICATIONS
SYSTEMS**

Engineered by



70 to 1,000 Mc.

Frequency-Modulated
C W Carrier

50 to 120,000 Cycles
Modulating Frequencies

Multiplexed by
Frequency Division

ONLY **REL** CAN

Supply the Famous
SERRASOID

Unmatched in Linearity,
Low Noise & Stability



Packaged communications, designed for long tube life and unattended operation, includes finest channellizing, and telemetering equipment by the world's first and foremost FM equipment manufacturer.

**WRITE · WIRE · PHONE · OR TWX
US TODAY FOR COMPLETE DETAILS**

**RADIO ENGINEERING
LABORATORIES, Inc.**

36-40 37th St., Long Island City, N. Y.

Telephone Stillwell 6-2101 Teletype N. Y. 2816

GENERAL ELECTRIC

Electronics Department Offices in:
 Atlanta 3, Ga. • Boston 1, Mass. • Chicago 54, Ill.
 • Cincinnati 2, Ohio • Cleveland 4, Ohio • Dallas
 2, Texas • Denver 2, Colo. • Detroit 26, Mich. •
 Kansas City 6, Mo. • Los Angeles 14, Calif. •

**ELECTRONICS PARK
 SYRACUSE, N. Y.**

Minneapolis 2, Minn. • New York 22, N. Y. •
 Philadelphia 2, Pa. • Salt Lake City 9, Utah •
 San Francisco 4, Calif. • Schenectady, N. Y. •
 Seattle 4, Wash. • Syracuse 1, New York •
 Washington 5, D. C.

In Canada, Canadian General Electric Company, Ltd., Toronto, Ont.

Outside the U. S. A. and Canada, by International General Electric Company, Inc., Electronics Dept., Schenectady, New York, U. S. A.

2-WAY RADIO for time-saving communication



25-50 MC MOBILE—General Electric Mobile Combination for operation in the 25-50 mc band. These combinations consist of the receiver, 30 (or 50) watt transmitter, loud speaker, microphone with retractable cord, antenna cables, control unit, antenna, and power and control cables. Designed to withstand the grueling road-shock of day-in, day-out operation.



GENERAL ELECTRIC MOBILE COMBINATION MC-201 for dependable operation in the 152-162 mc band. Features single unit design with receiver, transmitter and power supply mounted mechanically on one main chassis. Electrical connection is made instantly through G-E special-design plug-in feature. MC-201 consists of receiver, transmitter, power supply, loud speaker, microphone with retractable cord, antenna, control unit, power and control cables.

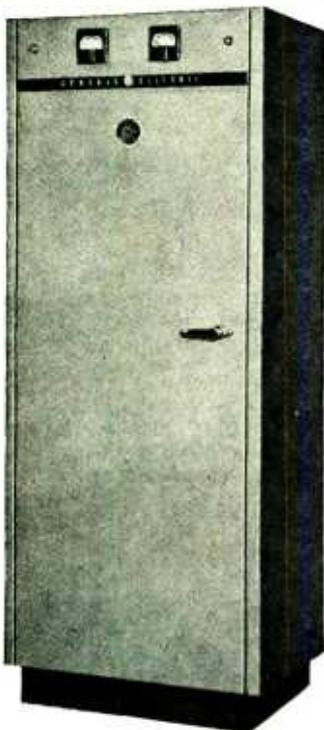

◀ **GENERAL ELECTRIC 50 WATT STATION COMBINATION** for use in the 25-50 mc or 152-162 mc band. Consists of 50 watt transmitter, receiver, local or remote control terminal equipment and extra space for additional receivers or accessory equipment. Height, 66 inches; width, 24 inches; depth, 20 inches. Designed for "block-building" so that the simple addition of a 250 watt amplifier will boost the power output rating.

▶ **GENERAL ELECTRIC 250 WATT TRANSMITTER-RECEIVER STATION COMBINATION** for the 25-50 mc or 152-162 mc bands. The cabinet contains a 250 watt power amplifier, 50 watt exciter, receiver, local/remote control equipment and ample space for additional receivers or accessory equipment. Height, 66 inches; width, 48 inches; depth, 20 inches.

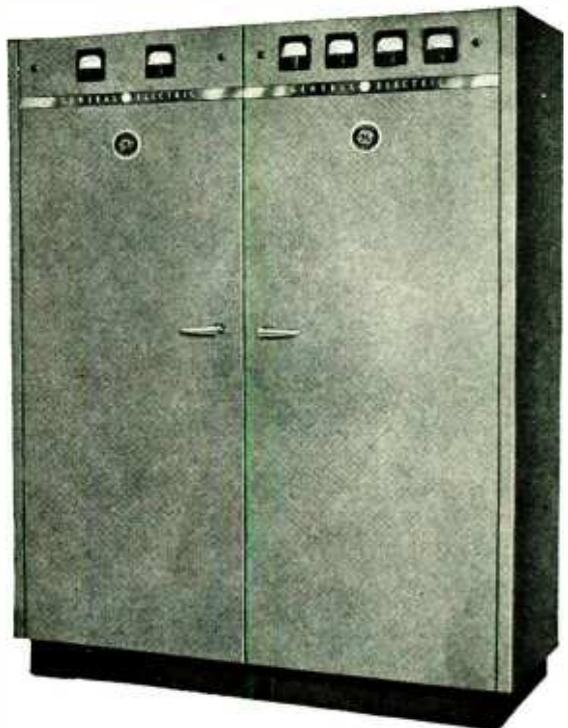

General Electric manufactures a complete line of radio communication equipment and accessories.

In addition to the combinations shown on this page, and of special interest, are a desk cabinet 50 watt station, a polemounted outdoor type station, a portable trunk unit and a weather proof housing for vehicular mounting. For complete information, call your nearest G-E office or write: *General Electric Company, Transmitter Division, Electronics Park, Syracuse, New York.*



Microphones **BY TURNER**

TURNER Microphones are the result of years of development and research by a pioneering leader specializing in microphone manufacture. Discriminating users the world over praise their performance, efficiency, modern design, ruggedness and **DEPENDABILITY**. Turner engineers are constantly developing new types and models to meet every microphone need. Write for information on latest developments.



Model S20X

For sound performance it pays to Turn to Turner

Crystals licensed under patents of the Brush Development Company

THE TURNER COMPANY
932 17th St., N. E., Cedar Rapids, Iowa



Complete COMCO 2-Way mobile unit for installation in cars or trucks.

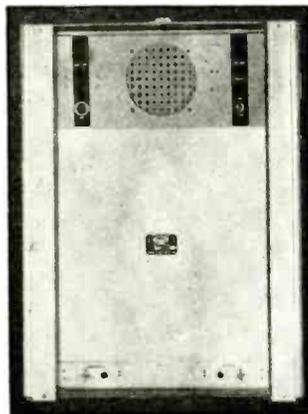

COMCO main station transmitter-receiver unit. Designed especially for dispatch systems.

COMCO VHF FM 2-Way RADIO

For Economical, Trouble-Free Communications

A COMPLETE LINE OF RADIO COMMUNICATION EQUIPMENT

Communications is our business! . . . Swift, dependable radio communications. The advanced design and rugged dependability of COMCO equipment is the result of many years of unceasing development and research by COMCO engineers.

Throughout the United States and abroad . . . in the biggest cities, in the smallest towns, in the oil fields, on ships, trains and planes . . . you'll find COMCO. And where you find COMCO, you'll find smooth, trouble-free radio communications.

Individual units or complete systems for . . .

- TAXIS
- POLICE & FIRE DEPARTMENTS
- OIL FIELD & UTILITY VEHICLES
- RAILROADS
- BUSSES
- AIRPLANES
- BOATS
- TRUCK LINES

If communications is a problem in YOUR business, COMCO has the practical, PROFITABLE answer! Write, wire, cable or telephone COMCO TODAY for engineering counsel and estimates. No obligation, of course.



Manufacturers of Radio and Electronic Equipment
COMMUNICATIONS COMPANY, Inc.
CORAL GABLES, MIAMI 34, FLORIDA



Mobile Antennas



Premax Mobile Antennas meet the most rigid requirements for Police, Fire, Municipal, Public Utility, Transportation, Commercial, Governmental, Amateur and other installations. They have the stamina to withstand hard usage and their engineered designs and careful treatment assure the trouble-free performance these important services demand. Various types are available, each designed to meet some particular need and supplying that fatigue and corrosion resistance so important to satisfactory communications. Premax Antennas and mountings are standard equipment in many diversified fields.

WHIP ANTENNAS

One-Piece Tapered "Whip" Antennas

Designed for maximum strength consistent with the required flexibility to meet the most exacting transmission and reception requirements.

One-Piece Tapered Aluminum Antennas—Type EA

Of a newly developed aluminum alloy of exceptionally high yield strength, more than double as compared to former alloys. Very light and strong with high corrosion resistance. 5/16" diameter at base tapering to 1/8" at tip. Adaptor supplied to fit all Premax mountings.

One-Piece Tapered Stainless Steel Antennas—Type ES

Of special formula stainless steel with tensile strength about double that of any grade previously available—approaching spring temper. Corrosion-resistant. 1/4" diameter at base tapering to 3/32" tip. Will fit any Premax mounting.

One-Piece Tempered Steel Antennas—Type EC

Spring steel "whips" in every way suited to rugged service. Of one-piece, tapered ground chrome-silicon steel alloy having high fatigue values. Cadmium-plated. Base 1/4" tapering to 3/32" at tip.

Graduated Diameter Steel Antennas—Types AS and AC

Rods of varying diameters, cold-drawn to carefully develop physical properties, are joined securely and permanently into a single graduated length which provides high flexibility, minimum wind resistance and long life. Will flex under severe strains and immediately return to normal position when obstacle is cleared. In solid steel heavily cadmium plated or in highly-polished stainless steel. 1/4" base diameter.

(All "whip" type Antennas available in 6' to 8' lengths and specials)

BASE LOADED ANTENNAS

For 75-meter band, this Mobile Base-Loaded Antenna insures a 6 db. increase equal to quadrupling transmitting power and greatly increases effectiveness and range of both transmission and reception. Has unusually long, space-wound, base-loaded inductor, topped by a special Premax whip. Solves many of the usual difficulties encountered in Mobile 75. Also supplied with auxiliary to make Center-Loaded Antenna.

HEAVY DUTY VERTICAL TYPES

Premax Telescoping Tubular Vertical Antennas are available for heavy-duty use on truck, mobile transmitters, etc. Marine Antennas for every purpose. Write for details.

MOBILE MOUNTINGS

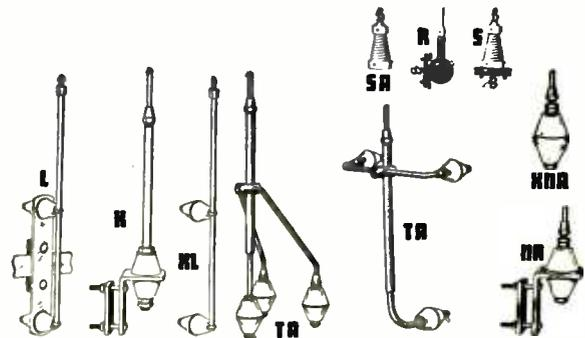

Premax presents a complete line of special insulated Mountings for "whip" type antennas, designed to meet every requirement for location on vehicles.

Types K, L, N and NA are bumper mountings; XL and TA are panel mountings (TA can also be used as roof or flat surface mounting); R is an adjustable Universal mounting; S is a spring-type mounting and SA is a Spring Adapter which can be used with any Premax Mounting.

Send for special Mobile Antenna Bulletin and complete details of Premax Equipment.

PREMAX PRODUCTS
DIVISION CHISHOLM-RYDER CO., INC.

5012 HIGHLAND AVE., NIAGARA FALLS, N. Y.

160 MC ROOF ANTENNA

An exceptionally satisfactory roof-top Antenna that one man can install, suitable for 152 to 162 mc. Widely used by taxi owners. Has stainless steel antenna 18" long, mounted on special plastic plate with rubber gasket. A single hole 1 3/4" in diameter is cut thru metal roof, the coax cable run between upholstery and roof and is fished thru the hole and connected to insulator mounting. Complete unit is then anchored to roof by four screws.

MOTORCYCLE ANTENNA

Due to special hinge-lock mounting, rider cannot break or loosen antenna by striking it with leg in mounting or dismounting from cycle. Coax cable is grounded through the bracket which prevents breakage due to vibration. Fits standard 3/4" horizontal or vertical frame. Whip easily replaced.

CHOOSE YOUR RAYTHEON ^{two}_{way} RADIOPHONE

**From this Complete Line of Low Cost,
High Performance, Easy-to-Operate Equipment**



Whatever the need, whatever the service, Raytheon can supply the one best radiophone system.

Fixed station and mobile equipment with all accessories, available at low cost as a complete package. Highest standards of performance are insured by the Raytheon reputation for excellence in electronics,

backed by a nationwide sales and service organization.

Write today for complete information on Raytheon Radiophone Equipment to suit your special needs. Raytheon representatives will gladly discuss your problems and make recommendations without obligation.



25 TO 50 MC

152 TO 174 MC

25 TO 50 MC		152 TO 174 MC		
MOBILE	FIXED	MOBILE	CENTRAL STATION UNITS	
MODEL VM 30-1	MODEL VS 50-1.	MODEL UM 30	MODEL US 60	MODEL US 400-1
<ul style="list-style-type: none"> ● Designed for two-way dependable communication (police, fire, forestry, public utility, oil and pipe line, long-haul trucks, busses, etc.). ● Low drain 6-volt battery operation. Low maintenance cost. ● 30-watt output. Highly selective, low noise FM reception. ● Compact, shockproof, of rugged construction, 5" x 6$\frac{3}{4}$" x 15" transmitter-receiver installs anywhere in vehicle. ● Power supply and control unit fits easily under dash. ● Furnished with mobile whip antenna, cable and fittings, microphone or telephone handset. ● Available for single or two-channel transmission. 	<ul style="list-style-type: none"> ● A complete 50-watt central station transmitter-receiver available for single or two-channel transmission. ● Operates on standard 117-volt, 60 cycle AC power source. ● Installs easily anywhere. ● Transmitter-receiver only 5" x 6$\frac{3}{4}$" x 15". Power supply fits easily under dash. Universal mountings. ● Furnished with antenna, remote control units, loudspeakers, microphone or desk set. 	<ul style="list-style-type: none"> ● Designed for two-way local communication. (Taxi, local trucking, pickup-delivery service, ambulance, police patrol, power and utility maintenance, construction fleets, doctors, engineers, reporters, executives, etc.) ● 6.3-volt power supply operates from standard truck or car battery. No special battery or generator required. ● 30-watt output. Requires only 28 amps when transmitting; 6.1 amps in "standby". ● Compact 5" x 6$\frac{3}{4}$" x 5" transmitter-receiver unit ideal for under seat, cab side, overhead or trunk corner installation. ● Combined control unit and power supply mounts under dash. ● Accessories include car top or tripod (truck roof) antenna, press-to-talk microphone or phone handset, extra speakers. 	<ul style="list-style-type: none"> ● A complete 60-watt central station for greater-than-average coverage. ● 117-volt, 60 cycle AC operation. ● Transmitter-receiver may be centrally located for maximum coverage with control station remotely located for greatest convenience. ● Exciter-receiver, power amplifier, and power supply-remote control unit each require only minimum space. ● Furnished as a complete package with necessary antenna, speakers, handset, etc. 	<ul style="list-style-type: none"> ● 400-watt output provides complete coverage of large areas with a single transmitter. ● Provides multiple channel reception and automatic selection of up to three remote receivers. ● 115 or 230-volt, 60 cycle AC operation. Less than 1000 watts required for receiver and transmitter. ● Complete equipment includes line amplifiers and remote control units required to operate station from dispatching centers many miles apart. ● All circuits accessible and individual units removable through door of handsome, rugged, 79" x 30" x 16" welded steel cabinet. Safety engineered throughout.

RAYTHEON MANUFACTURING COMPANY
WALTHAM 54, MASSACHUSETTS

SHURE Microphones are the "Field-Proved" Standard in Safety Communications from Coast to Coast

At the Transmitter- the "UNIDYNE"

In the Field- the "100" Series Carbon



The Shure Unidyne Dynamic, Model "55," is used for more "fixed station" applications than any other microphone made. Pictured above is the radio room of the transmitter station of the Miami Police. Two Shure "UNIDYNES" are used, one for AM, one for FM Broadcasts.

The Shure "100" Series Carbon Communications Microphone is used for more mobile applications than any other microphone made. Pictured above is the "Megacycle Motorcycle" with the first two-way FM radio installed on police Servi-Car by Harley-Davidson Motor Co. Shure "100" Series Carbon Microphone is an integral part of the unit.

Patented by Shure Brothers, Inc.

Model "55"
List Price
\$67.50

SHURE BROTHERS, Inc.
Microphones and Acoustic Devices
225 West Huron Street Chicago 10, Illinois
Cable Address: SHUREMICRO

Model "100" Series
List Price
\$30.00

**FCC REQUIRES
Mobile Radio
to be LICENSED**
Installers & Servicemen

*How We Train Your Employees to Get an
FCC Commercial RADIO TELEPHONE LICENSE
IN A FEW SHORT WEEKS!*

**It's EASY With CIRE Simplified Training
and Coaching AT HOME IN SPARE TIME**

FCC rules require that mobile radio installers and servicemen must be licensed. Your greatest problem is finding licensed operators. CIRE's simplified training and coaching can, in a few short weeks, train your experienced employees to pass the FCC Commercial Radiotelephone License Exam. Here's how you gain: (1) your men study at home in spare time—there is no loss of working time (2) you get a trusted, experienced man licensed—he knows your business and is familiar with your type of operation. CIRE training is the only planned course of coaching and training that leads directly to an FCC License. Get your experienced men licensed now! Write for FREE Information today!

Here's Proof

**CIRE GETS MEN
LICENSED FAST**

"On March 4, I stood my examination for Radiotelephone 2nd and received my license on March 5. Since then I've accepted a job installing and servicing Police and taxi two-way systems throughout the State of Georgia. Your course has been an invaluable aid to me in both this work and in passing my exams."

Student #387N12

"I am working at the present time with the Southern Railway System in the communication department. They have just recently completed the installation of Two-Way Radio on some of their switch engines. This is the type of work that I enjoy doing, and I am very grateful to you and the fine staff of instructors for everything that you have done for me in helping me to obtain my Second Class License."

Student #2303N12

**HERE IS YOUR
GUARANTEE**

CIRE guarantees to continue the training of every student until he obtains his FCC Commercial License.

**NEED A LICENSED MAN
IN A HURRY?**

We may have an experienced, newly licensed graduate student in your area that is available for employment. If you need one in a hurry, write.

MAIL COUPON NOW!

CLEVELAND INSTITUTE OF RADIO ELECTRONICS, DESK MR-2
4904 EUCLID AVE., CLEVELAND, OHIO

Address to Desk No. to Avoid Delay
Please rush me, FREE OF CHARGE, information how my men can get their FCC Commercial License in a few short weeks.

Name
Address
City State

Write or Mail Coupon for FREE Information

CLEVELAND INSTITUTE OF RADIO ELECTRONICS
4904 EUCLID AVE. DESK MR-2 CLEVELAND, OHIO

Approved for Veteran
Training Under G.I. Bill

THE **NEW Improved**
MODEL 3HW-A
Workshop Antenna
 will . . .

More than triple the effective power of the transmitter.

Increase the effective power of the mobile transmitter.

Increase the operating area.

Permit the use of low power, low cost equipment.

Workshop High-Gain Beacon Antennas are designed specifically for the 152-162 megacycle band —taxicab, fire, police, and private fleet communications.

Design Features

- Low angle of radiation concentrates energy on the horizon.
- Symmetrical design makes azimuth pattern circular.
- Can be fed with various types of transmission lines. Special fittings are available for special applications.
- Enclosed in non-metallic housing for maximum weather protection.

Available for immediate delivery through authorized distributors or your equipment manufacturer.

—THE—
WORKSHOP ASSOCIATES
 INCORPORATED

Specialists in High-Frequency Antennas
65 NEEDHAM STREET
Newton Highlands 61, Mass.



PAT. APP. FOR



for
INDUSTRIAL,
PUBLIC-SAFETY,
 and **LAND-**
TRANSPORTATION
 radio communication services

MICROMETER FREQUENCY METER

- an instrument for measuring the carrier frequencies of any number of radio transmitters, AM or FM, 100 kc. to 175 mc.
- employs aural indication, with headphones; accuracy can be checked in the field against Bureau of Standards station WWV.
- calibration charts show percentage deviation from assigned frequencies, comparable with FCC tolerances.
- four models, with or without quartz crystal calibrator; accuracy 0.005%, prices \$129.00 to \$202.00; prompt delivery.

— wire or write today —

LAMPKIN LABORATORIES, INC.
 —Bradenton, Fla.—



how to keep your
“PLUG-INS” plugged in

THE TOP HAT RETAINER

Four standard sizes fit most tubes and components. Special types also available.



New stainless steel clamp for plug-in units subject to vibration.

Materials and finishes comply with Armed Forces specifications.

Recommended for use in military electronic equipment.

Please state in your inquiry the type of tube or component to which the retainer is to be applied, or supply sample or outline drawings with pertinent dimensions.

TIMES FACSIMILE CORPORATION

A Subsidiary of The New York Times Company
 229 West 43rd Street, New York 18, N. Y.



***Link* FM—With Sylvania Lock-Ins— Covers New Jersey For Its State Police Radio System**

Automotive equipment of the New Jersey State Police includes vehicles always on the alert to deal with every emergency. Fleet is spearheaded by 180 patrol cars of the department in addition to 42 patrol cars of the State Motor Vehicle Department which is served by the State Police. These vehicles are constantly in touch with fixed FM stations located at 26 strategic points throughout the state. In addition, emergency trucks carry complete radio equipment equivalent to that of a fixed station!

Link Radio Corporation, manufacturer of the communications equipment, makes extensive use of Sylvania Lock-In tubes to assure unfailing efficiency of this statewide network. Lock-In tubes stay put through vibration and jarring. They have few welded joints . . . no soldered ones. Elements cannot warp or weave . . . connections are short and direct. Top location of getter reduces losses . . . separation of getter material from leads cuts down leakage.

See Sylvania Distributors—or write Radio Tube Division, Emporium, Pa.

SYLVANIA ELECTRIC



Drivers of both emergency trucks and patrol cars can maintain two-way communication with fixed stations.



Radio equipment in emergency trucks duplicates the set-up used in fixed transmitting stations.

The superior mechanical and electrical features of Sylvania Electric's famous Lock-In tube make it the ideal choice for equipment on the road, in the air, on the rails, marine radar, FM and television.



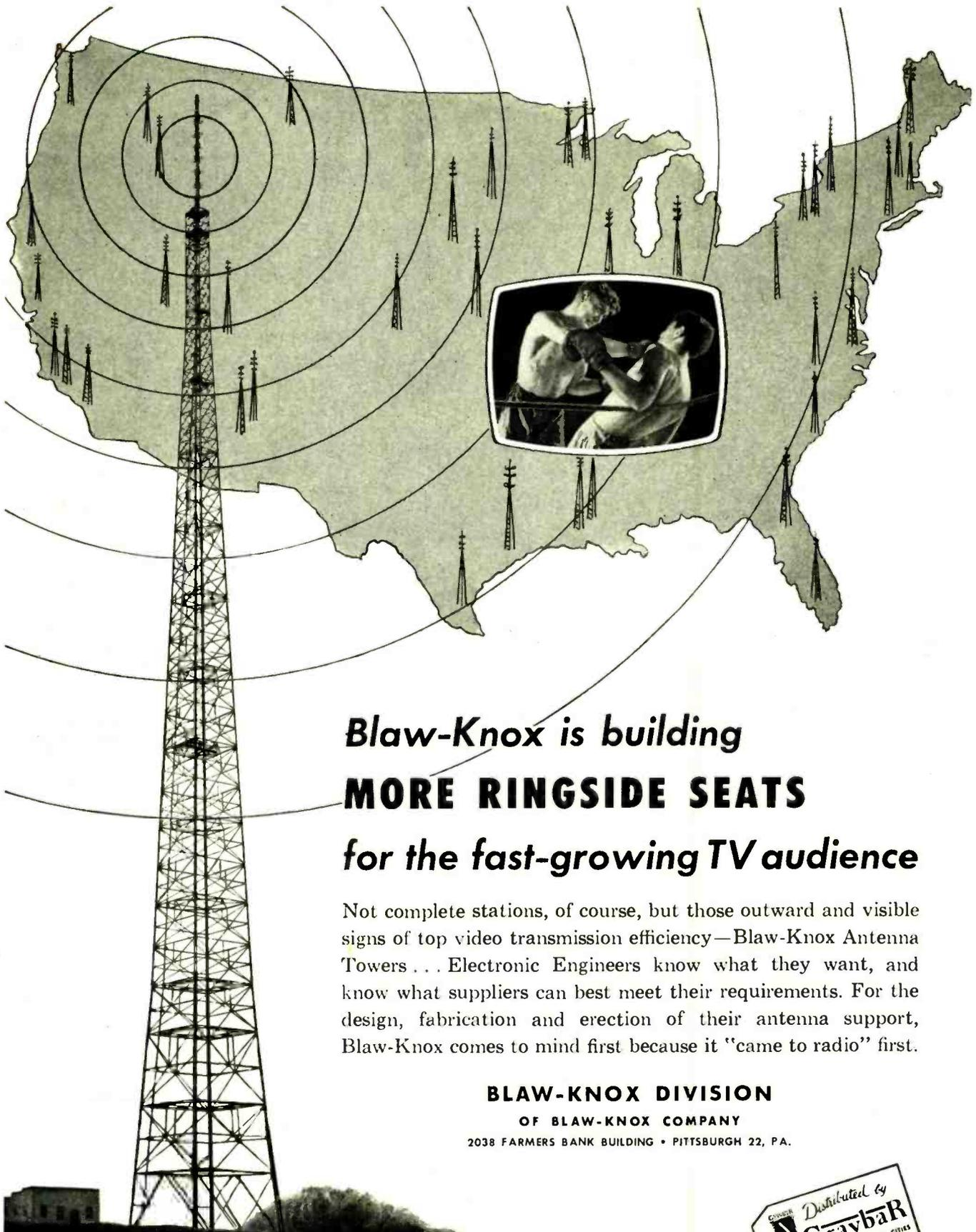

Blaw-Knox is building
MORE RINGSIDE SEATS
for the fast-growing TV audience

Not complete stations, of course, but those outward and visible signs of top video transmission efficiency—Blaw-Knox Antenna Towers . . . Electronic Engineers know what they want, and know what suppliers can best meet their requirements. For the design, fabrication and erection of their antenna support, Blaw-Knox comes to mind first because it "came to radio" first.

BLAW-KNOX DIVISION

OF BLAW-KNOX COMPANY

2038 FARMERS BANK BUILDING • PITTSBURGH 22, PA.

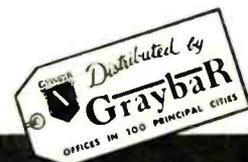

BLAW-KNOX *ANTENNA* **TOWERS**

*When seconds mean lives
and dollars - you can
depend on Ward Aerials ---*



Fire fighting efficiency has been increased by the use of mobile 2-way radio in dispatching equipment. Ward Products Corporation is proud of America's heroic fire fighters.

And we are proud of the part Ward antennae play in the transmission and reception of messages when seconds saved mean lives and dollars.

Most fire companies rely on Ward aerials because they are ruggedly constructed to withstand the abuse to which they are subjected.

Ward whip rod aerials are made of a special alloy to provide the greatest possible durability and resilience.

Model SPP-3 is a non-rusting alloy swivel base for mounting at any point desired.



Model SPP-3A is a shock mounting spring for fullest protection against impact damage.

Model SPP-3B is an 84 1/2" stainless steel whip rod, shown here attached to Model SPP-3 swivel base and Model SPP-3A shock mounting spring.



*Ward is the largest and oldest
exclusive maker of auto radio
and television aerials.*

WARD

World's Finest

Aerials

WARD PRODUCTS CORPORATION

1523 E. 45th STREET

CLEVELAND, OHIO

Division of the Gabriel Company

Motorola "RESEARCH" LINE...the only 2-way radio equipment incorporating the amazing

**SENSICON RECEIVER CIRCUIT FOR
MOBILE RADIO COMMUNICATIONS**
100,000 TIMES IMPROVED SELECTIVITY—
MAXIMUM INTELLIGIBILITY—MINIMUM MAINTENANCE

ENGINEERING LABORATORY C 15344
MOTOROLA RESEARCH LABORATORIES

CE-127 PA-8433 SENSICON UNIT
REPORT TO MANAGEMENT

STATUS: NOW IN PRODUCTION !
DESIGN: FOR PRACTICABLE ADJACENT CHANNEL APPLICATIONS AT MINIMUM OPERATING EXPENSE.
PERFORMANCE:
FREQUENCY • 25-50 MC. AND 152-174 MC.
SELECTIVITY • BROAD NOSE - STEEP SKIRTS (SEE CURVE ATTACHED)
INTERMODULATION • EXCELLENT SUPPRESSION OF SIMULTANEOUS ALTERNATE & ADJACENT CHANNEL SIGNAL MIXING.
FREQ. STABILITY • MAINTAINED TO WITHIN ± 1 KC. OF ASSIGNED CENTER FREQUENCY FROM -30°C TO $+60^{\circ}\text{C}$.
FIELD TEST • OUT PERFORMS ALL OTHERS !

[Signatures]

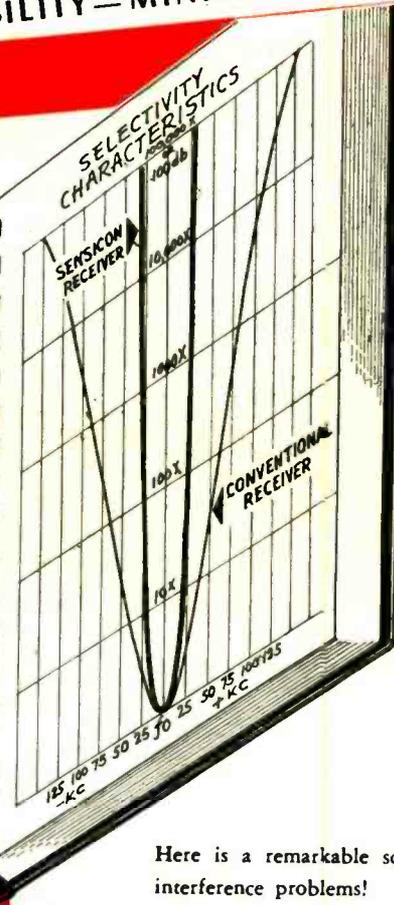

FINER
communications than ever before with this new
ADJACENT CHANNEL EQUIPMENT

ALL IN ONE PACKAGE, THESE ENGINEERING ACHIEVEMENTS SET NEW PERFORMANCE STANDARDS

- Sensicon Circuit
- Static Oscillator
- ISO-Q Cavities
- Differential Squelch System
- Permaky I.F. Wave Filter
- Capacitance Discriminator
- Bridge Balanced Crystal Oven
- Instantaneous Deviation Control

Here is a remarkable scientific solution to communications interference problems!

Here is the radio equipment guaranteed to beat all the "bugaboos" in adjacent channel operations!

Here is super-precision selectivity, 100 db. rejection at the near edge of adjacent channels, along with positive control of intermodulation interference, desensitizing, frequency drift, spurious responses and nuisance noise.

Here is a vital part of all modern mobile communications systems—a product of the MOTOROLA Research Laboratories, the world's largest laboratories devoted exclusively to the development of F.M. 2-way radio equipment. Precision equipment and precision systems that will be YEARS AHEAD FOR YEARS TO COME.



the BEST is now BETTER than ever before...

Motorola
"RESEARCH" LINE
FM 2-WAY RADIO

Compare Feature for Feature

WITH ANY OTHER EQUIPMENT ON THE MARKET .
GET THE COMPLETE STORY . . . WRITE TODAY.

MOTOROLA INC. Communications Division
4545 W. Augusta Boulevard, Chicago 51, Illinois