

Designing and
Building

HI-FI
FURNITURE

Jeff Markell



*designing and
building*

HI-FI FURNITURE

By Jeff Markell

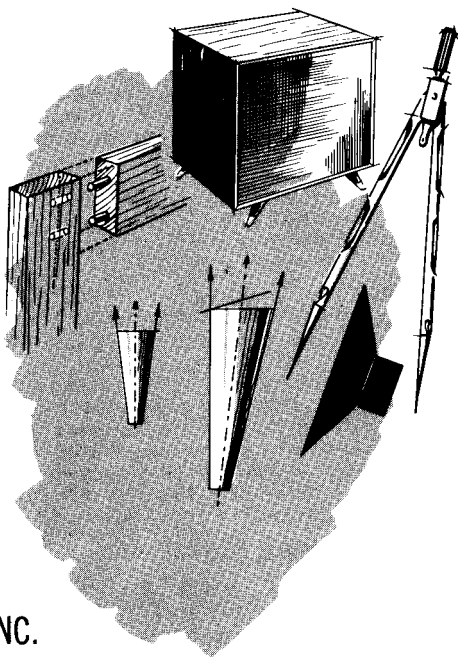

GERNSBACK LIBRARY, INC.
NEW YORK 11, N. Y.



© 1959 Gernsback Library, Inc.
All rights reserved under Universal
International, and Pan-American
Copyright Conventions.

Library of Congress Catalog Card No. 59-8914

contents

CHAPTER

1

Equipment

Tuners. Tuner dimensions. Vertical and horizontal mounting of tuners. Ventilation. Turntables. Leveling the turntable. Mounting level of changers and turntables. Tape decks and recorders. Amplifiers. Stack mounting. Construction of a tuner-amplifier compartment. Speaker enclosures. Infinite baffle. Bass reflex. Horns. Stereo equipment.

page

7

2

The room

Choosing the room. Placing the speaker. Room shapes. Room acoustics. Sound distribution from a speaker. Room traffic patterns. The scaled floor plan. Making room measurements. Scale dimensions. Making scale cutouts of furniture. Stereo effect. Room with an alcove. Positioning tweeter and midrange speakers.

37

3

Fundamentals of design

Good design. Visual order. Static and dynamic order. Basic lines. Designing a cabinet front. Cabinet front variations. Three-dimensional relationships. Adding a speaker enclosure. Cabinet shelf. Depth as a dimension. Dynamic planes. Creation of dynamic lines by static shapes. The scalloped edge. Spiral forms. Categories of curves. Proportion and balance.

65

4

Furniture styles

Modern style. Contemporary styling. Asymmetrical design. Examples of contemporary styling. Traditional and period styles. Hepplewhite. Directoire style. French provincial, English styles. Empire style. Chippendale. Chinese Chippendale. Sheraton. Adams brothers. American styles. Regency. Early colonial. Selection of style.

95



Materials

Woods. African and Honduras mahogany. Luan. Walnut. Birch. Comb-grain, plain sliced and quartered oak. Avodire. Blond limba. Chen Chen. Sapele. Teak. Birdseye and curly maple. Fruitwoods. Gum. Knotty pine. Fir. Veneer cuts. Lumber cuts. Plywood construction. Graining standards for veneer faces. Fir plywood. Special surface veneers. Hardware.

127

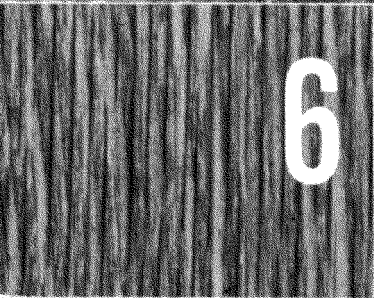

Construction

Layout. Cutting. Table saw. Overarm saw. Portable rotary saw. Band saw. Sabre saw. Power jig saw. Jointing. Butt joint. Shoulder butt. Double-shouldered butt joint. Mitre joint. Mitre and spline. Lock mitre. Mitred shoulder butt. Partitions. Doweling. Mortise and tenon. Assembly. Gluing. Fitting and edging. Hardware. Legs and bases. Kit construction.

163



Finishing hi-fi furniture

Sanding. Types of sanding. Machines. Orbital and belt sanders. Finishing curved and carved portions of the cabinet. Precoloring. Staining. Water, alcohol and oil stains. Bleaching. Removing filler. Filling. Pickling. Sealing. Final finish coats. Using a spray gun. Lacquer and shellac. Rubbing. Retouch. Reassembly. Oil finish.

193



Retouch, repair and refinishing

Burns. French polishing. Water and beverage stains. Scratches. Nicks and gouges. Crushes. Loose or broken hardware. Cracked, crazed or alligatored finishes. Grille cloth. Loose, peeling or blistered veneer. Open joints. Cabinet clamping tools. Pipe or bar clamps. Rope as a clamp. Loose legs. Broken dowels. Loose molding. Refinishing. Paint removers.

211

The author gratefully acknowledges the cooperation of these companies: Cassard & Walker, Inc.; Charak Furniture Co.; Colby Associates; De Walt Inc., Division AMF; Douglas Fir Plywood Assoc.; Electro-Voice Inc.; General Cement Manufacturing Co.; Grand Rapids Varnish Corp.; Grosfeld House, Inc.; Hardwood Plywood Institute; Herman Miller Furniture Co.; John Scalia Inc.; John Stuart Inc.; L. & J. G. Stickley Inc.; Museum of Modern Art; Porter Cable Machine Co.; Rockwell Manufacturing Co., Delta Power Tool Div.; Schmeig & Kotzian Co.; U.S. Plywood Corp.; University Loudspeakers, Inc.; Widdicomb Furniture Inc.; Wood & Hogan Inc.

introduction

I have long contended (sometimes rather noisily) that a hi-fi system can, and should be, as pleasant to see as it is to hear. Subjects that have been amply treated elsewhere are treated lightly, if not downright summarily: in connection with speakers and enclosures their exterior design, styling and construction are treated, not acoustical principles.

Step-by-step do-it-yourself instructions on how to make a Chippendale sideboard out of three grapefruit crates and a grandfather's clock won't be found in this book—there is already a lot of information of this kind around, but there is very little *design-it-yourself* literature. Therefore, I have tried to point up some of the most important principles of design and construction as related to hi-fi furniture.

Because a pleasing end result is impossible unless the furniture housing the equipment is properly related to the room, both as to placement and styling, these aspects of the problem are discussed. And styling itself is a relatively meaningless term unless you are acquainted with the basic elements which, through various permutations and combinations, make up style.

The materials available for the construction of furniture are numerous and varied. Wood is the primary material and by becoming acquainted with the woods available you are likely to come up with some encouraging design ideas. Too, an extensive explanation of construction methods, types of jointing, and types and capabilities of tools is needed if you are to know which design ideas are practicable and which, though pretty on paper, would be difficult or impossible to build.

To make an intelligent choice of materials a knowledge of finishing methods and procedures is a necessary prerequisite. Knowing methods of repairing, retouching and refinishing will be of incalculable value, not only for maintaining your hi-fi housings, but also any of the other furniture you have that may fall into disrepair. It is likely that you will use this information most often on your standard furniture, although it is not unusual to find that someone has used the top of a speaker enclosure for a not very efficient ashtray.

As you go through the pages of this book, remember that it is not the last word on the subject. I sincerely hope that after you have read it, you will be able to prove that.

JEFF MARKELL

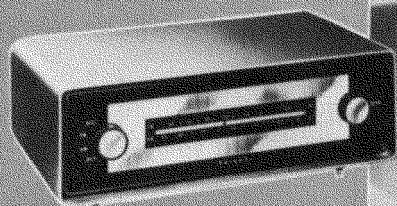
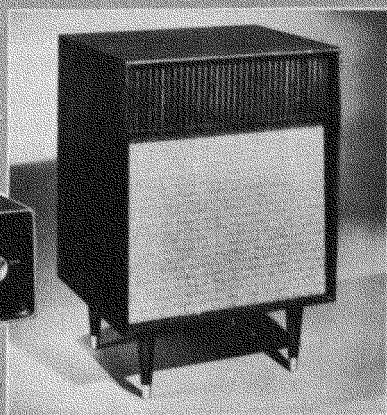

CHAPTER 1

equipment

PEOPLE can be rather strange. We pride ourselves on being logical, and then, time after time, we fail to follow a technological advance to its logical conclusion. A fairly good example of this was the early development of the automobile. Remember those photographs of the first cars? They took the “surrey with the fringe on top,” got old Dobbin off the front of it, cut him down in size and put him on the inside, leaving the remainder of the carriage just about as it had been before. They even called the thing a “Horseless Carriage.” In those days, they didn’t seem to realize that they were dealing with something that was essentially new and should be designed new from the ground up.

In many ways, the contemporary hi-fi system is about as different from the radio and radio-phonograph of a few years ago as the internal combustion engine was from old Dobbin. Possibly this is why a good many people who have been trying to put hi-fi systems into a housing equivalent to the “surrey with the fringe on top” have been dissatisfied with the results.

To carry the analogy a little further, both the automobile and the “one-horse shay” had the same original basic purpose—getting people and things from one place to another. But through development and refinement, the automobile became transformed into a completely new object that does a far better, faster and more comfortable job of transportation than would ever have been possible with the “one-horse shay.”

Similarly, the basic purposes of the older radios and phonographs were the same as that of present-day hi-fi—the transmission

of a sound from one place to another. But here the parallel ends. High-fidelity is the result of continuous advances in the science of electronics and ever present refinements in the art of audio reproduction. But, as in all arts, the final word has not been said.

One of the areas where considerable refinement must still occur lies in that of the furniture in which the equipment is housed. After all, you've probably spent a good deal of time, effort and money in making a pleasant and comfortable living room, and you are therefore understandably reluctant to admit a Frankenstein's monster to a permanent place in it. Before you can intelligently decide what kind of furniture you want to put into your living room to house the hi-fi set, you must first examine the system itself to see what it requires in the way of space. To exhume an old cliché, "You can't put a quart in a pint bottle." So, let's take a look at the equipment and see how big a bottle you do need.

I shall not discuss the relative merits of different kinds or makes of equipment; a tremendous amount of information of this kind is already available in magazine articles, consumer reports, books and manufacturers' specs. For our purposes, your system, no matter how big or how small it may be, breaks down into three main divisions: the first of these is a group of parts we will classify as the *signal sources*; the second, *amplifiers*, and the third, *speakers*.

Signal sources are pieces of equipment from which the program material running through the system originates. The various types of equipment that you might have in this category are: 1) the tuner; 2) record player; and 3) a tape machine.

Tuners

There are three types of tuners in common use: the FM, or *frequency modulation* type; AM or *amplitude modulation*, and AM-FM, which combines the two in a single unit.

Most hi-fi units that include radio reception are equipped to cover the FM band, either in the form of a straight FM tuner or an AM-FM combination. Since FM reception is so far superior to AM, AM tuners as separate entities are relatively uncommon. Consequently, an AM tuner as an individual unit is most likely to show up on the AM side of a two-channel stereo receiver system.

In recent years, due to the widespread use of printed circuits, miniature tubes and miniaturized parts, the size of tuners has been considerably reduced over the early models. In the early days of hi-fi, it was not uncommon to find a tuner measuring 13 to 15 inches wide, 7 to 10 inches high and 10 to 12 inches deep. Any

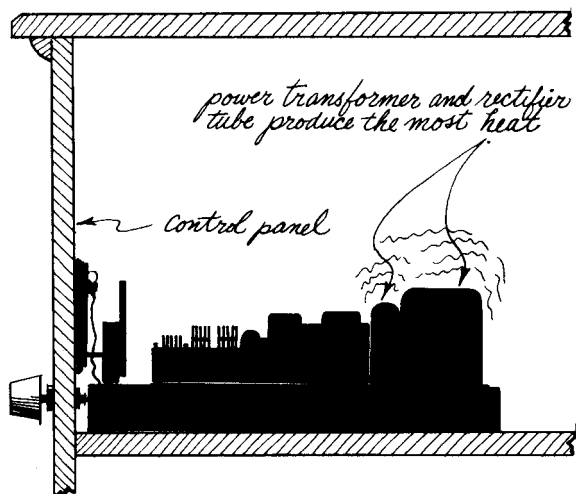

a

Fig. 101. There are two basic ways of mounting a tuner within a cabinet: (a) tuner mounted horizontally; (b) tuner mounted vertically.

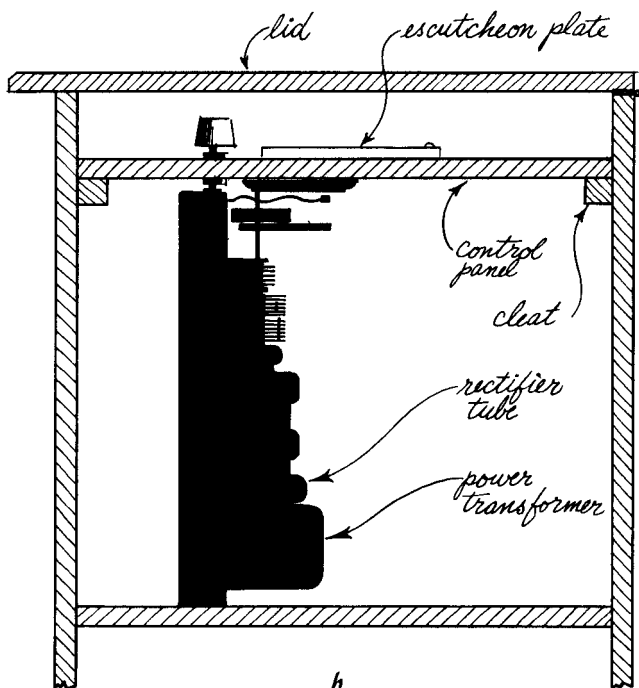

b

reduction in height or width of tuners simplifies cabinet installation since it reduces the amount of control panel space required by the unit. Considerable reductions, particularly in height, have been made in the physical size of tuners. Tuners are now made in such a way that heights of over $4\frac{1}{2}$ inches are relatively uncommon. This has made it possible to stack tuners and amplifiers, resulting in extremely compact control panels.

Tuners tend to get warm in operation. This is normal and does no harm as long as adequate ventilation is supplied. In most cases, providing adequate ventilation for a tuner is not an elaborate procedure. Try to allow about 1 inch between the tuner and any other electronic part next to it in the same compartment or, if other parts are to be mounted over the tuner, try to allow approximately 3 inches. Preferably, leave the back of the cabinet compartment housing such parts open so that air can circulate in and out freely. It is also a good idea, where possible, to drill a series of holes, say 1 to $1\frac{1}{2}$ inches in diameter in the shelf on which the tuner is mounted to allow air to circulate up from underneath.

Most manufacturers state that their tuners can be mounted either horizontally or vertically; that is, with the controls facing either front or up (Fig. 101). However, my experience indicates that horizontal mounting, where possible, is definitely preferable. It seems to me that when I have mounted tuners vertically, they tended to burn out tubes a bit more rapidly. This apparent shortening of tube life is probably caused more by what the vertical mount does to the ventilation than by what it does to the tube orientation, since the vertical mount obviously requires that the tuner be brought up very close to the top panel, where there is very little space for air to circulate adequately. And, to make matters worse, generally the hottest parts such as the power transformer and rectifier are at the back of the chassis which in the vertical position becomes the bottom (Fig. 101-b). Their heat will therefore rise all the way up the chassis when it is placed vertically.

It makes no difference from the point of view of furniture installation whether the tuner is FM only or AM-FM except that the AM-FM tuner is generally somewhat larger than the FM only, has more tubes, generates more heat and therefore requires a bit better ventilation than the FM.

It would seem to be so transparently obvious as to be unworthy of mention that a tuner and its associated control panel should be placed in the cabinet in such a fashion that the tuning dial can easily be read, but you'd be surprised how often this little consideration is ignored. Easy visibility of the dial is one of the major

reasons advanced in favor of the vertical mount for a tuner. Personally, I feel the disadvantages outweigh the advantages in this case.

Record players

Your second important signal source is the record playing device. It may be a record changer, a manual record player or a transcription-type turntable with a separate arm.¹ Unless you have a large tape recorder, the record-playing mechanism is likely to be the largest single component in the entire system in terms of the

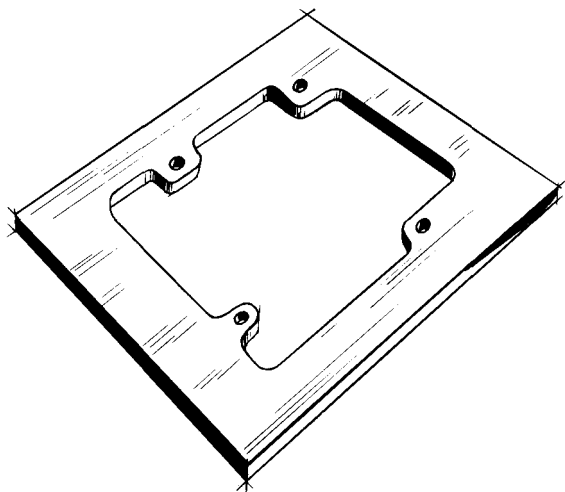

Fig. 102. For fixed installation of a record changer, a mounting board is used. It can be obtained precut for various makes and models of changers or can be made with templates supplied by the manufacturer.

cubic volume of space required for installation. It will therefore influence the overall dimensions of your cabinet more than any other single part. Although a number of manufacturers (both domestic and foreign) have record changers on the American market, the overall sizes are remarkably close. They will vary in height from about $7\frac{3}{4}$ inches overall to about $8\frac{1}{2}$. In width they will range from $14\frac{1}{2}$ to as much as $15\frac{1}{2}$, and the largest variations will occur in depth, which may be from $13\frac{1}{2}$ to $15\frac{1}{2}$ inches.

¹ Do not confuse the transcription turntable and the manual record player. The turntable is a high-quality professional unit. The manual record player is considered by many to be more suitable than the changer, but it nevertheless cannot be classed with a true turntable.

Record changers can be installed in cabinets using a mounting board in which an irregularly shaped hole is cut (Fig. 102). The record changer is passed into this hole from above in such a fashion that the main plate, turntable, spindle and arm stand above the mounting level, while the motor and various levers and cams associated with the change mechanism hang down below (Fig. 103). Record changers are supplied with either three or four spring shock mounts through which they are bolted to the mounting board. Every model of record changer requires a different

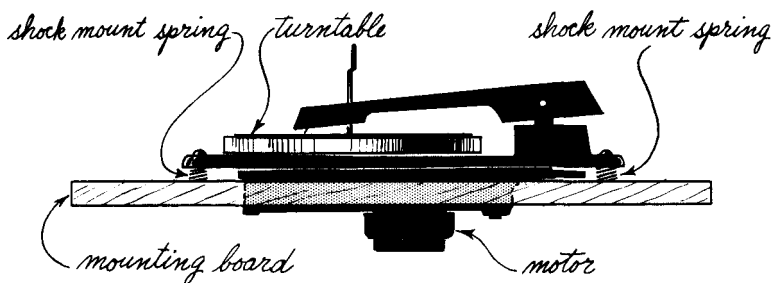

Fig. 103. Side view of a typical changer on a mounting board. Note the spring shock mounts.

shaped hole in the mounting board, but this constitutes no problem since every changer comes from the manufacturer accompanied by a template showing the shape of the hole required. The changer, on its mounting board, is installed in the cabinet by being set at an appropriate depth under a lid in a fixed position or attached to the top of a sliding drawer (Fig. 104).

The clearances required above mounting level for record changers vary between $5\frac{1}{4}$ and $5\frac{3}{4}$ inches. I generally allow a flat 6 inches. The clearance required below varies from $2\frac{1}{4}$ to $2\frac{3}{4}$ inches. I generally allow a flat 3 inches, or a total of 9 overall.

Record changers, when not in use, must be kept covered by closing the lid or drawer, as the case may be. If they are left open, dust will accumulate on the turntable and be transferred from there to your records, causing unpleasant popping sounds as the record is played and also excessive wear on both the stylus and record.

When record players of any kind are installed in a fixed position under a lid, it is wise to allow a little extra space around the machine, if possible, so that it is easy to reach the controls, to place the stylus in playing position and to get records on and off the machine. In the case of a record changer placed in a drawer,

be sure that you have a long enough traverse so that it will pull out far enough for convenient operation.

Beyond being sure that you've allowed enough space around the machine for convenient operation, a record changer requires no particular consideration in connection with cabinet installation. However, it must be fairly easy to remove for servicing.

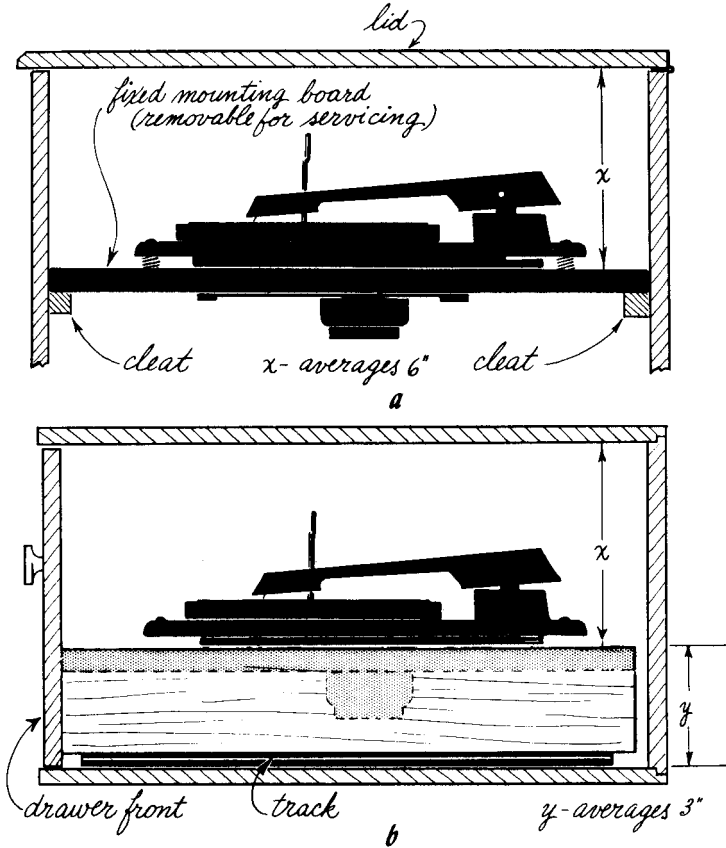

Fig. 104. Two ways in which a changer can be installed in a cabinet: (a) mounted under lid; (b) mounted in drawer.

Turntables

The transcription turntable and arm will require more space in either length or width (or both) than a record changer or manual player. It will not usually require any more height. A turntable is a considerably more precise instrument than a record changer in that it keeps more accurate speeds and it requires somewhat more careful installation.

Turntables are generally accompanied by a separate tone arm which holds the cartridge. This arm is often made by a manufacturer other than the one who made the turntable. It is essential in mounting an arm that the manufacturer's instructions as to the

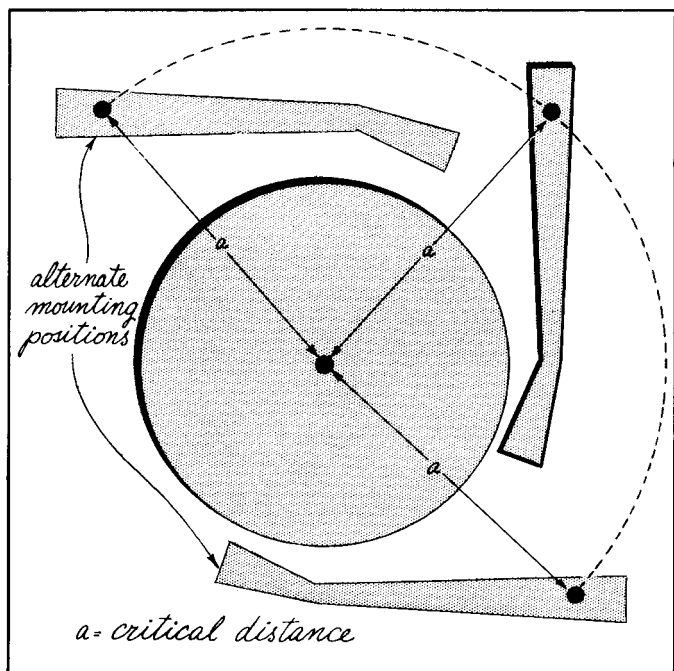

Fig. 105. When mounting a turntable and arm, the distance between the pivot point of the arm to the center of the turntable is critical.

distance required between the center of the spindle of the turntable and the pivot point of the arm be followed with extreme accuracy. Where the arm is placed relative to the turntable is not usually important so long as the critical distance between the center of the spindle and the pivot point of the arm is observed (Fig. 105).

Since most floors are not quite level, it is necessary to level the turntable mounting board after the cabinet has been put in its position in the room. This leveling becomes particularly important due to the fact that most turntable and arm assemblies utilize much lighter stylus pressure on the record than changers and, if the turntable is not level, the stylus and arm will not track accurately (Fig. 106).

While the overall height required for mounting a turntable and

arm is no greater than that required for a changer, the heights above and below mounting level are different. Much less height is required above mounting level, and more below, than for the

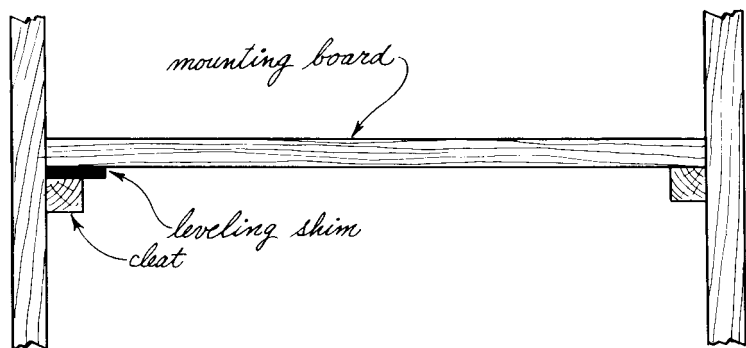

Fig. 106. When a cabinet is not level, the turntable can be adjusted by inserting a shim between the mounting board and the cleat supporting it.

changer (Fig. 107). I generally average them out at 3 inches above and 6 below instead of the 3 below and 6 above that I use for the

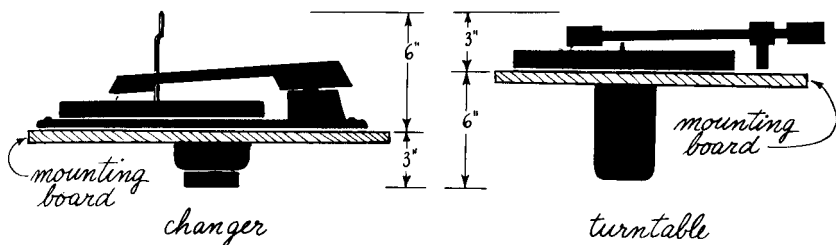

Fig. 107. Because of their construction there is a difference in the mounting level of changers and turntables: (a) room required for changer; (b) depth needed for turntable. Note that the overall depth is the same for both.

changer. The actual depth below mounting level required for a turntable may vary from 4 to $5\frac{3}{4}$ inches, and the height above from 2 to $2\frac{3}{4}$ inches.

When some low level magnetic cartridges are used (particularly stereo) annoying hum can be induced in the pickup by power transformers up to 18 inches away. Make sure that the turntable and amplifier (or any other equipment using a power transformer) are far enough away from each other to prevent hum pickup.

Occasionally a turntable with a particularly large motor may require a little more depth below mounting level than the average 6 inches, so it would do no harm for you to check the one that you have in mind to be sure that it will fit in the average space and, if not, allow the additional depth required.

The length and width requirements of a turntable and arm assembly are determined partly by the size of the turntable and by the length of the arm being used. Some of these arms have an overhang of 3 to 5 inches beyond the pivot point, so you have to be sure that you have sufficient space for this arm overhang to swing freely to allow the cartridge to traverse the entire playing area of the record (Fig. 108). A fairly good average space for turntable and arm assembly would be a surface about 18 x 22 inches. A large number of the various possible combinations will fit on this space; some will require less and a few odd ones will require more. The space requirements for these units are far more varied than for record changers, and you should check in each case to find out what your exact needs will be.

The one other remaining consideration in connection with turntables is that, since they have considerably larger motors than record changers, they require better ventilation. It is advisable to have either 2 or 3 inches of air space below the motor in the cabinet, or to open the back of the cabinet from the level of the mounting board down to allow air to enter and circulate around the motor. Some turntables have a small fan either inside or outside the motor, attached to the lower end of the drive shaft. If your motor happens to be one of this type, you can get away with a bit less space in the motor compartment. But, in general, too much space is far preferable to too little.

Tape decks and recorders

Quite a few tape mechanisms are available, both of domestic and foreign manufacture. Many are made for tape playback only, others with both record and playback functions. You may or may not have tape at the present; the chances are good that, in the future, you will want it. It gives a kind of flexibility to your musical library that you can't get any other way and, of course, affords you an opportunity of recording miscellaneous material not commercially available that is of particular interest to you.

Unfortunately, however, tape machines are rather difficult to deal with in a general way as regards dimensions and cabinet mountings. They vary considerably in size, and they also differ in that some can be mounted vertically while others must be mounted horizontally. The size range runs from quite compact units that will fit in approximately the same space as a record changer, to the large, professional type units, some of which are pretty huge.

A good many tape recorders come in luggage cases, and a lot of

people leave them in these cases with the idea in the back of their minds that they're going to carry the thing around a great deal to record material outside the home. It usually turns out that they don't but, by the time they find this out, they've already housed the rest of their equipment and their tape machine sits around the living room in its luggage case, becoming a bit of an eyesore. One solution, if you really think you're going to carry your tape machine around very much, is to provide a space in your cabinet

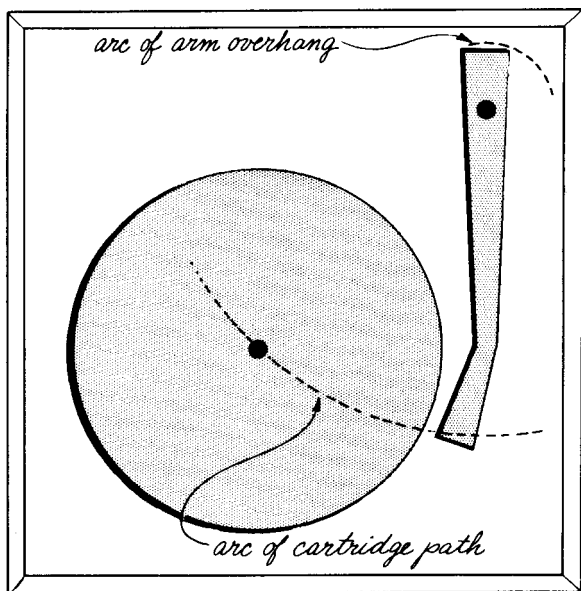

Fig. 108. Because the pivot point of the tone arm is several inches from its end, allow room so that the arc of the overhang does not hit the cabinet side before the cartridge arc can traverse the playing area of a record.

where you can put it, luggage case and all. If you decide to do this, the whole procedure is quite simple. All you'll have to do is measure the outside dimensions of the case and these will be the inside dimensions of the compartment you'll need. And you don't have any installation problems except to leave holes in the compartment for leading wires to and from the rest of your system.

Many, but not all tape machines come in cases; a number are made specifically for mounting in furniture. The procedure for mounting is very similar to that for mounting a turntable. You have a mounting board set at the proper height. In most cases 2 or 3 inches above and 6 or 7 inches below mounting is plenty of room. You can cut a hole in the mounting board to the proper shape, as shown by the template supplied, drop your tape machine

through the hole, and bolt or screw it in place. If you have a unit that is cased, but you are willing to admit at the outset that you really aren't going to carry it around, then the best thing to do is to take it out of the case and proceed in the same way as for an uncased unit. Your system as a whole is generally cleaner and better-looking this way, and it usually gets better ventilation.

When you start measuring the unit to find out how much space you need, don't make the mistake that is often made—of measuring it without the reels. Before you start, put on a pair of the largest reels that the machine will take, and measure your dimensions outside of those reels. Otherwise the reels will get in the way every time you try to close the lid or drawer.

Most tape machines have a fan attached to the lower end of the drive shaft of the motor to provide air circulation. If your machine has more than one motor, this fan will be at the bottom of the main drive motor. If there is a panel of any kind close below the motor, try to cut a hole in the panel about the size of the fan. This will greatly facilitate the cooling of the entire unit.

If you have a machine that mounts vertically, just leave the back off. In this way you will get excellent ventilation with no trouble at all. In general, plan to give a little more consideration to ventilation of a tape recorder than is necessary in the case of a turntable. The machine is more complicated and generally has electronic parts closely associated with the mechanical parts, thus generating more heat.

The last signal source that we will note is the audio end of your TV. Why many people insist on piping their TV sound into the hi-fi system is more than I can quite understand. Most of what you listen to on TV is speech, and it doesn't require a very high fidelity system to reproduce intelligible speech. After all, the telephone company reproduces an awful lot of intelligible speech through equipment with a frequency response range running from 100 to 3,000 cycles. On hi-fi, you're shooting for frequency response ranges of about 20–18,000 cycles. It seems to me that to use your hi-fi system for TV sound is a bit like shooting cannon balls at flies, but there are those who insist on doing it. If all you want to do is run your TV sound from the TV receiver, wherever it now is in the room, into your system, that, of course, does not involve any cabinet considerations. All you have to do is have an audio takeoff installed in the TV set, and run a cable over to your amp or preamp.

Where you run into cabinet considerations is when you have decided to put your TV in the same cabinet with your hi-fi system.

Unless you have one of these new little portable jobs, your TV is probably a pretty large unit. It will considerably increase the overall dimensions of your cabinet not only in length, but very likely in depth. Often a system that normally requires a cabinet about 18 inches deep overall, suddenly becomes 24 inches deep when you add the TV. This is the point where you should stop and consider

Fig. 109. Modern amplifiers of moderate power are much more compact than their older brothers: (a) an old-style amplifier and preamp; (b) the new flat look. (Lower photo courtesy Allied Radio.)

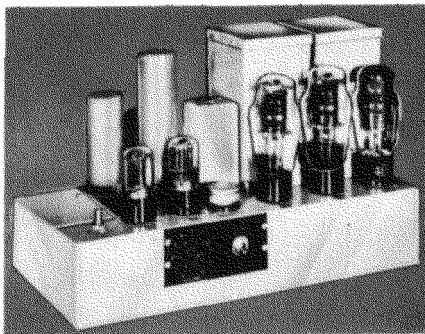

whether your room is big enough to take a cabinet of that size and depth. I have often seen rooms completely overpowered by the size of the cabinets that resulted from the incorporation of TV's with complete hi-fi systems. I cannot caution strongly enough against this way of doing things, except in very spacious rooms.

Amplifiers

Your amplifier will generally consist of two main sections. The first is the preamplifier or control amplifier and the second is the power amplifier. Depending on size, power and type of construction, these two may be together in one unit or physically separated. Today, amplifiers of medium power (10–20 watts) are generally on one chassis while the larger, more powerful ones come in two parts or sometimes even in three (Fig. 109).

Let's look at the smaller amplifiers first. In general, combination preamp–amplifiers are now being made in sizes and propor-

tions roughly similar to those of tuners. They may be fairly wide and deep, but not very high. As with tuner construction, this type of amplifier represents a considerable departure from earlier models which had more height. This change in construction tech-

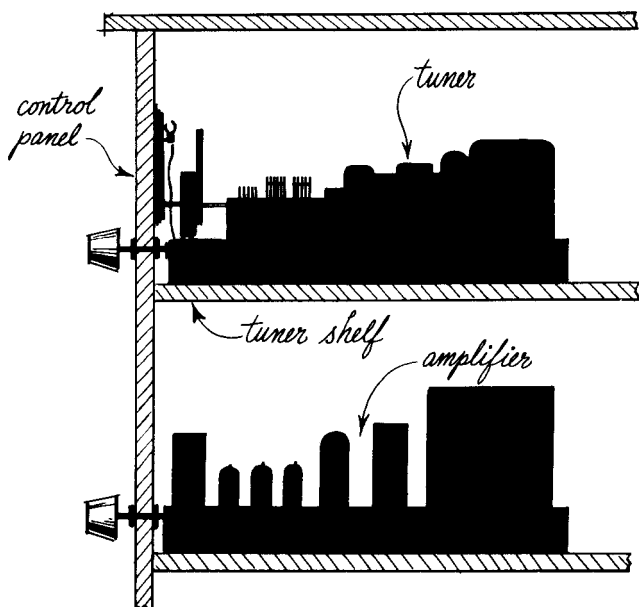

Fig. 110. Pancake type tuner and amplifier mounted horizontally in a cabinet. Stacked mounting is one of the conveniences provided by flat construction.

niques tends to make both tuners and amplifiers much easier to mount in cabinets. In a slightly larger space than was formerly required by either a tuner or an amplifier, it is now possible to stack both of them, one on top of the other, making the entire equipment compartment modest in size and the control panel quite compact (Fig. 110).

A large number of the smaller amplifiers can be easily accommodated on a control panel no more than $16\frac{1}{2}$ inches wide by 12 inches high, with space to spare. Actually, very few of the flat amplifier chassis run more than $13\frac{1}{2}$ inches wide, and a few of the smaller ones are as narrow as 9 or 10 inches in width. Heights range from $3\frac{1}{2}$ to $4\frac{1}{2}$ and in depths range from 9 to 12 inches.

Where flat tuners and amplifiers are mounted one over the other in a compact compartment, it doesn't matter which one you put on the top. That is determined by your own taste. Installation of parts in such cases is very simple. Templates for the holes to be

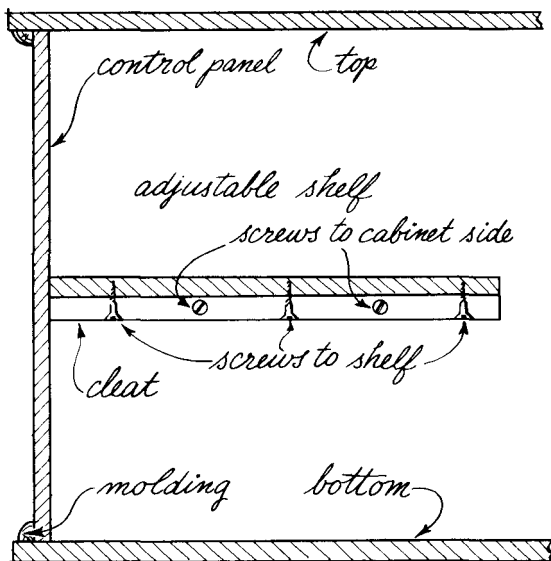

Fig. 111. Construction of a tuner-amplifier compartment.

cut in the control panels are supplied with each component. For whichever unit you have decided to put on the bottom, use the bottom of the compartment as the mounting level. Then, a couple of inches above that unit, so that there will be air around it, fix an internal shelf inside the compartment and behind the control panel. This gives you your mounting level for the upper unit. Cut the proper holes for both units in the control panel, as designated by the templates supplied. Place your components in position, plug them together and you're in business.

To mark the holes from the templates and make your cutouts, first mark the level of the top of the internal shelf on the inside face of the control panel. Then take the control panel out of the cabinet. Next, using the bottom and the shelf level as references, mark the cutouts from the templates and cut as required. In general, the control panels in cabinets designed to house high-fidelity equipment are made removable so that this can be done.

If you design your own cabinet, be sure to include provision for making this panel removable. As far as that goes, while you're at it, make the mounting board for the record changer or the turntable removable also.

One simple way to arrange a removable control panel is to fix a frame of thin molding in the front of the compartment, then push the control panel in from behind, and screw it down to the

frame from inside (Fig. 111). Be sure that you can get that internal shelf out, too. If the control panel is removable but the shelf is fixed, you'll obviously never get the control panel out. This also is very easy to arrange. Merely fix the shelf to a pair of cleats, which in turn screw to the sides of the cabinet but are not glued. The whole business can then be easily removed and replaced by taking out a few screws.

Instruct your cabinetmaker specifically on these points, otherwise he will follow normal furniture-making procedure and fix these parts in place permanently when he assembles the cabinet.

There is still one other consideration. People have been known to buy hi-fi equipment and then find later that they want to change it. If you change your equipment, you can be absolutely sure that the new units will *not* fit into the old cutouts. You've got to take the old control panel out and replace it with another. If your control panel is permanently fixed in place in the cabinet, instead of being removable, you'll have a rough time getting it out and you may well have to do considerable damage to the cabinet in the process.

In the case of the larger amplifiers consisting of a preamplifier and a separate power amplifier, the only part that has to come through the control panel is the preamp. These preamps are generally, if anything, smaller than the flat amplifiers discussed earlier. To install one, follow the same procedure as for the flat amplifier, except that you have a good deal less worry about ventilation of a preamp only, since it generates less heat than the combined preamp and amplifier. Once the preamp and tuner are taken care of, the only thing left to worry about is what to do with the possibly quite bulky power amplifier. Sometimes it will fit at the rear of the compartment in which you already have the other two parts. This is an excellent place for it, because it is likely to be the hottest unit you will have and, at the back of the compartment, it will be in a position to get the most air. If it hangs out the back an inch or so, that doesn't do any harm. In fact it does a little good as far as ventilation is concerned.

Don't push cabinets containing electronic equipment up tight against the wall. Set them out an inch or two so that air can readily get in and out of the compartments where the most heat is generated.

If your power amplifier is too big to fit in the same compartment with the other units, you will have to give it a separate compartment of its own somewhere else in the cabinet. But again, be sure that it is adequately ventilated. The more air it gets, the bet-

ter. Leave the back off such a compartment and, if you find that you have to cut it down in size to where the amplifier is a very close fit, cut intake holes in the bottom of the compartment to improve air circulation.

Speaker enclosures

At first glance, the subject of speaker enclosures seems like a gigantic and impenetrable wall comprised entirely of utter confusion. Acoustical engineers are in unanimous and happy agreement on one point and one only: to operate properly, a high-fidelity loudspeaker system must be enclosed or placed behind a baffle. From here on, the disagreements range from mild to positively vitriolic, as to what the size, type, form and composition should

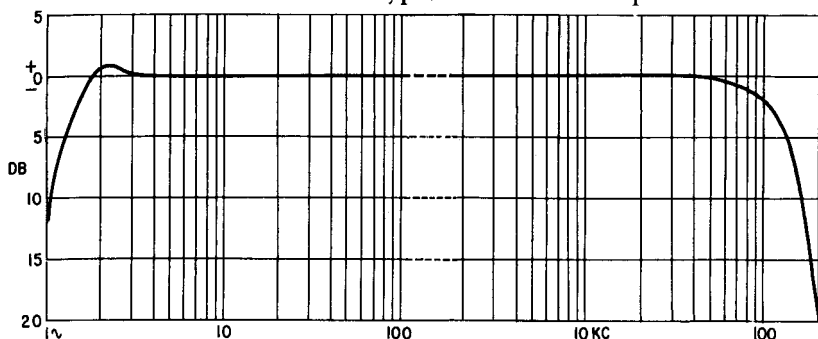

Fig. 112. Typical response curve for a high-quality amplifier. Note the flat top.

be. To avoid having my head chopped off at the ankles, I shall evade any evaluation of the various principles in current use. We will discuss types of cabinets utilizing different acoustical principles, but primarily from the point of view of the resulting external appearance.

Decide intelligently what kind of speaker cabinet you want, listen to a number of speakers in a number of different types of enclosures and determine which one suits your ears the best. After all, your like or dislike of the various tonal qualities produced by different speakers enclosed in different ways is a highly personal matter. True, there is perfectly good sense, from the point of view of the engineers, in discussions of comparative specifications and frequency response curves. But, for the nontechnical person, this type of data provides, albeit precise, a fairly meaningless description of a result that either feels good or doesn't feel good to our ears. We each hear with a pair of ears that is a little bit different from the next fellow's.

You will hear a lot of talk about flatness of frequency response

in the system, from some unusably low frequency at the bottom to some other equally unusable high frequency at the top. If you're technically minded—or just plain curious—take a look at the response curve of a decent amplifier (Fig. 112). It *will* be pretty flat. But then take a look at the response curve of a pretty good speaker (Fig. 113). By comparison, it looks like the path of an alcoholic trying to get home from the corner saloon—it wobbles all over the place. What you may not know is that the frequency response of your ears is likely to be pretty wobbly, too. Now, if you happen to come across a speaker that dips in its response where your ears peak, and peaks where your ears dip, it's going to sound pretty flat to you—but it might sound pretty frightful to your next-door neighbor, whose hearing response is likely to be quite different from yours.

To complicate matters further, take the same speaker and house it in several different ways. You'll change its response each time you change the housing. On top of that, take the same speaker, in the same enclosure, and put it in three or four different rooms. You'll change its response every time you change rooms.

Actually, if you want to delve into the technical aspects of speakers and their cabinets, there's a considerable amount of literature available on the subject in the form of books and articles. Also, there's a huge amount of material published by speaker manufacturers.

The infinite baffle

Now, as I have already said, engineers are agreed on one point—your speaker system should be in a housing. Without going into the whys, the reason for this is to improve the bass response of the speakers. There are a large number of different speaker enclosures and speaker systems on the market, but most of them will fall into one of three main categories:

1. Infinite baffle
2. Reflex baffle
3. Horn

Of these, the infinite baffle is probably the simplest and technically the most foolproof. In theory, an infinite baffle would consist of a plane surface of infinite height and infinite width with a speaker mounted through a hole in this surface. In such a situation the front radiation of the speaker would be completely isolated from the back radiation, and the air pressure or loading on the cone would be the same on both front and back. These conditions can be approximated by mounting the speaker through a

hole in a wall between two rooms of roughly the same volume. In such a case the room that has the back of the speaker facing into it is, in its entirety, effectively a speaker enclosure.

This kind of thing has been done on occasion, but obviously it

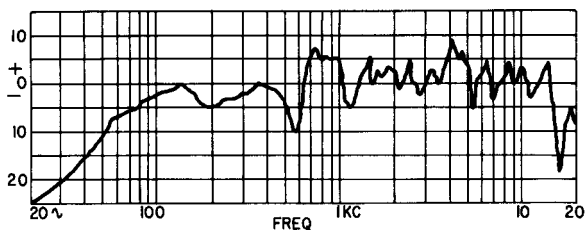

Fig. 113. Speaker response curves are quite different from those of amplifiers. The hill-and-valley nature of a speaker's response is shown in this typical curve.

is not a very practical approach. Therefore, the conventional infinite baffle, so called, is quite another thing. It consists simply of a box, fully enclosed on all sides, made as airtight as possible, with one hole in the front for the speaker. The only thing that's critical

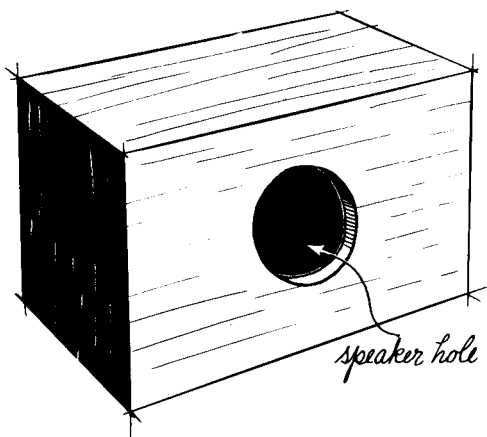

Fig. 114. The conventional infinite baffle is primarily a big closed box.

about it is that it be large enough in cubic volume for the size speaker that you're using (Fig. 114). The relative proportions of height to width to depth seem to have very little effect as long as you somehow get the necessary cubic volume inside the enclosure. But there's a rub. The infinite baffle, for a speaker of given diameter, is larger and more cumbersome than enclosures based on the other widely used principles.²

²There are other shortcomings inherent in infinite baffles. One of the most striking is the development of a single note bass resonance. When not properly designed the resultant bass-boom can be annoying. However, some ears find this juke-box-effect quite pleasant.

The table shows the recommended cubic volumes of conventional infinite baffles for speakers of various diameters.

Speaker (inches)	Volume (cubic feet)
8	5½
10	6¾
12	8
15	10

Remember, these are recommended averages. Speakers vary quite considerably in response curves, range and cone resonance. With some speakers, you can get away with a good deal less cubic volume than the recommended figure, particularly if it's a speaker with a very low cone resonance. In general, if you've got room enough to stick to the recommended sizes, do so. If you have space sufficient to allow you to exceed the volumes recommended, this is all to the good. If, on the other hand, you find you haven't got the space necessary for the recommended volume and have to pare it, be careful of what speaker you use. You could conceivably cheat the speaker. The speaker won't mind—but you might.

From the point of view of cabinet design, the infinite baffle, outside of its bulk, is a rather nice type of enclosure to work with because its relative proportions of height, width and depth are *not* critical³. Depending on the space you have available to allot to it, you can make it either long and low or narrow and high. You can put it on the wall, or you can put it in a corner. You can use a closet or you can build it into a skew-shaped space—as under a stairway—or some other odd-shaped niche for which you have no other use. It is entirely conceivable that, in your particular residence, you might have no place where you could put a speaker enclosure of even quite modest size if it has to be a regular parallelepiped shape, but yet you have a much larger area of irregular shape that could be used for the purpose. Some speaker manufacturers specifically recommend that their speakers be used in infinite baffles. In such a case, you would be wise to find some way of following the manufacturer's recommendations, since otherwise you will not get the sound from the speaker that the manufacturer intended and which was probably the sound that you heard demonstrated when you decided on it in the first place.

³ The air-loaded enclosure, which can be considered a variety of the infinite baffle, is another matter entirely. This type of unit is designed for specific make and model speakers and its dimensions are critical. The enclosure and speaker are frequently sold as a unit. They are available in a utility finish for custom installation. The enclosure is quite small—2.5 cubic feet being a typical internal volume.

A few words of caution regarding infinite baffles are in order. Because the infinite baffle is quite flexible as to shape and proportion, this sometimes leads people to put the speakers either too low or too high from the floor, particularly speakers that handle high frequencies. Low-frequency tones tend to disperse through the room reasonably readily, but high-frequency tones are directional, and dispersion becomes more and more difficult the higher

Fig. 115. *The sides of a speaker enclosure are stiffened with battening to prevent untoward resonance. They all strengthen the enclosure.*

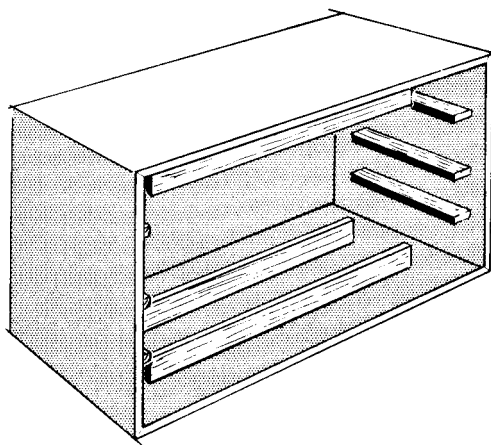

the frequency. Wherever possible, try to get whatever speaker or speakers are handling the high end at about the same height off the floor as your ear will be when you are seated to listen. The overall result will be much more satisfactory. Due to the fact that conventional infinite baffles are pretty big boxes, the individual panels of which they are composed are pretty good sized. It is a good idea to stiffen them internally by adding battens, approximately $\frac{3}{4}$ x $1\frac{1}{2}$ inches to 2 inches, edge-glued and screwed on the inside of the panels to aid in damping panel resonance (Fig. 115).

In the larger cabinets housing 15-inch systems or multiple 12-inch systems, it is often desirable to add cross-braces from top to bottom, side to side and front to back, made of stock as heavy as 2 x 4 inches, for the same purpose—damping panel resonances. Lining the inside faces, top, bottom, sides and back of an infinite baffle with acoustical absorptive material such as 2-inch Fiberglas damps standing waves which will otherwise cause some quite annoying sound effects that have nothing to do with the program material you want to listen to.

Bass reflex enclosures

The next important type of speaker enclosure is known as a phase inverter or bass reflex. This type of unit is almost a sealed enclosure like the infinite baffle, except that it has an opening or port in the front, in addition to the speaker opening (Fig. 116). The purpose of this port is to utilize cabinet resonance along with speaker resonance, to extend the bass response downward and at the same time equalize it over a wider range. An advantage inherent in the phase-inverter or bass-reflex cabinet is that it allows you to use smaller dimensions for a speaker of given diameter than

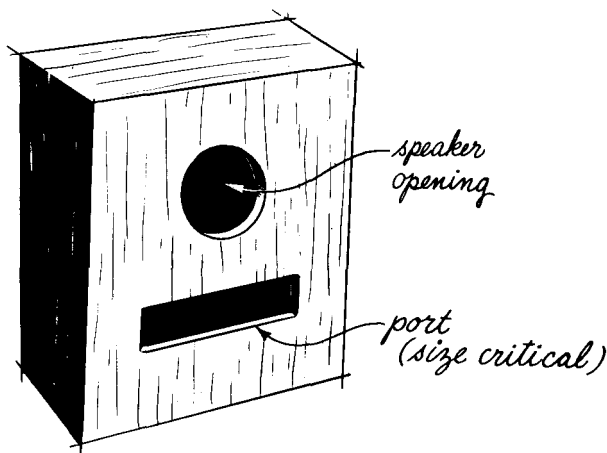

Fig. 116. The reflex baffle is a popular enclosure. The port actually tunes the enclosure.

would be possible with an infinite baffle. A 12-inch speaker can be reflexed in a cabinet as small as 4 cubic feet, and a 15-incher can be put in one as small as 6 or 6½ cubic feet.

In the case of the reflex baffle (as for the infinite baffle) some manufacturers specifically recommend that their speakers be used in this type of enclosure. Among the advantages claimed by those who advocate the reflex baffle are that it will damp the peak that occurs at the speaker's resonant frequency, at the same time extending the bass response of the speaker below the point that would be achieved with an infinite baffle. In addition, the speaker's efficiency is increased since the back wave is utilized as well as the front wave at low frequencies.

To get back to our primary concern, which is the external aspects of the cabinet, a reflex enclosure, like an infinite baffle, is quite flexible as to shape. It can be a regular parallelepiped, a

corner cabinet or an irregular shape. If you use an irregular shape, you're sort of looking for trouble because you're liable to have an awful time computing the cubic volume to get the port size right. But, if you have no other choice, go ahead and do it that way but be very careful with your volume computations, or the whole thing is liable to come out sounding a bit off. Considering

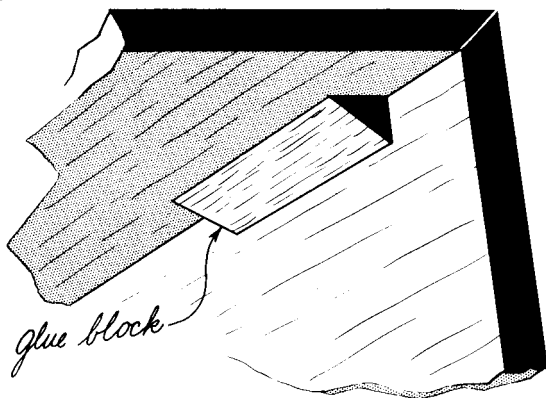

Fig. 117. Speaker enclosures have been known to come apart from vibration and air pressure caused by a speaker working at high levels. Brace the joints with glue blocks.

the necessity for accurate volume computations, the regular parallelepiped is by far the easiest shape to work with. However, it's not critical whether the shape is made long and low or high and narrow. And it doesn't make much difference whether the port is alongside the speaker hole or below, as long as the area is right and it is not too close to the speaker opening. So actually you do have a high degree of flexibility in working out the lines and proportions of the reflex enclosure.

As with the infinite baffle, internal battering of the panels is a good idea. In this case, you're utilizing the cabinet resonance which you don't want mixed up with spurious panel resonances, if you can help it. In the reflex cabinet you don't use as much absorptive material as in the infinite baffle. Generally, absorptive material is applied to the inside of the back and then to either the top or the bottom and the right or the left side, but not both.

Both infinite and reflex baffles should be made of good, solid $\frac{3}{4}$ -inch plywood, preferably with the joints reinforced internally with glue blocks (Fig. 117). Both baffleboards and backs must be firmly screwed in place with screws spaced not more than 6 inches apart all the way around. Grille cloth should be as acoustically

transparent as possible, otherwise you will attenuate the highs. The best materials for this purpose are woven of monofilament plastic yarn. Several companies specialize in the manufacture of cloths specifically for this purpose. Such cloth should be readily available from your components dealer. One rule-of-thumb test for the acoustical transparency of a piece of proposed cloth is to hold it up to the light in an otherwise darkened room and see how transparent it is (Fig. 118). The reason for darkening the room is so that the color of the cloth will not affect your judgment.

Horns

The other type of cabinet of major importance, the horns, tend to get rather complicated. In fact, before even starting to describe them, I feel that I cannot caution you too strongly against attempting to do the acoustical design of a horn yourself. This is not a job for an amateur. Even if you have enough acoustical engineering knowledge to design a horn, the chances are that you do not have the extensive and expensive instrumentation necessary to test what you're doing. If you want a horn and don't like the appearance of the ones you've seen, stick to the internal specifications of the one you like and change the outside appearance to suit yourself. If you take a cabinet of fixed dimensions, you can change its exterior appearance by varying external details. By adding, subtracting or changing moldings, legs, grille cloth, bases, etc., you can get immense flexibility in external appearance without changing internal specifications one bit. But stop right there. Don't try to change dimensions or proportions.

It is almost impossible to describe the design of horns in simple terms. The whole subject very soon becomes unwieldy. Horns can be classified in one way according to the type of curve upon which the flair of the horn is based. The curve most often used is an exponential one. However, another type of curve, the catenoid, has also been used fairly extensively.

A horn type speaker cabinet should not properly be called an enclosure, because a true horn operates as an extension and additional part of the speaker. Therefore, the speaker and its associated horn must be considered as a single integral unit. For this to happen the speaker must be specifically designed for the horn, or vice versa. Therefore, if you intend to use a horn type speaker system, be sure to use the right speaker in the horn you've picked or, alternately, the right horn for the speaker you have.

In addition to the three major types of speaker enclosures already mentioned, a number of other principles have been utilized

for forming speaker enclosures. I shall not attempt to deal with them in any detail, but refer you to existing literature.

One device used strictly for reproducing basses and requiring separate arrangements for mid-range and treble is called an air coupler. These tend to be rather bulky and, from our point of view, rather limited as to the flexibility of proportion, making them a little difficult to design around.⁴

You may very well come across types of enclosures not mentioned—it is impossible in a limited space to try to cover them all. But no matter which you like and want to adopt, just be sure to

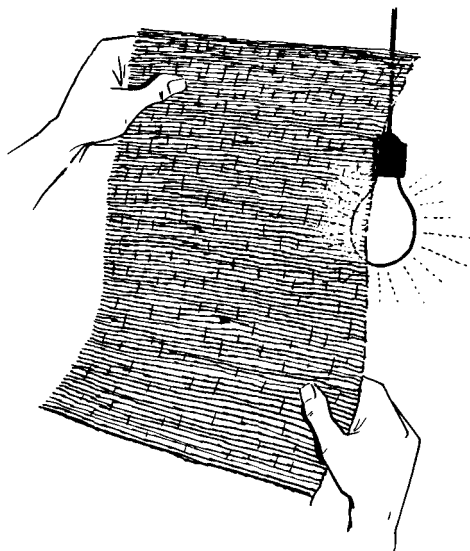

Fig. 118. *The grille cloth must be acoustically transparent. One test is to hold a piece up to a light. If you can see through it, chances are that you can hear through it.*

check the possible effect of changes in size and proportion before you decide to make any such alterations. It is no great effort to inquire and a good deal better to do so than to suffer needlessly with unsatisfactory results.

Stereo equipment considerations

Because there has been so much hoopla about stereo recently, no discussion of components in relation to furniture could be

⁴ Do not confuse the air coupler with the air loaded low-efficiency enclosure. The latter units are small and extremely compact.

considered complete without mentioning the questions and problems stereo can raise.

Tuners

Although methods are being developed to broadcast stereo by FM multiplexing, as of this writing the only generally available stereo broadcasts are AM-FM; that is one channel is on AM, the other on FM. To receive and reproduce such broadcasts in stereo you need either an AM-FM tuner that can tune each band separately and has separate outputs for each band, or you'll need two entirely separate tuners, one for each band.

Stereo AM-FM tuners are available, and, while they are sometimes slightly larger than their nonstereo counterparts, if you have allowed adequate space for a monophonic AM-FM tuner, you won't have trouble getting a stereo unit to fit the same space.

Visibility of tuning dials may be more of a problem with stereo—you'll have two of them to tune instead of one—but, you ought to be able to see a tuning dial reasonably readily anyhow.

Ventilation is just as important to a stereo tuner as to any other. Stereo equipment won't run any cooler; on the other hand, it will not run much hotter either. Venting adequate for a straight AM-FM tuner is not likely to stifle a stereo unit.

If, for any reason, you are committed to keeping a nonstereo tuner, but still want stereo, then you may have a bit of trouble. You have to get another tuner, and the second one must be treated with just as much courtesy and consideration as the first.

Record changers

Here we find a very happy situation. There is no difference at all in the physical size of a record changer, be it mono or stereo. Be a bit more careful about the mechanics of mounting the changer, however. If the shock mounts are very springy, as they often are, put in a bit of steel wool to damp them. Be rather more careful to level the changer when it is to be used for stereo. Remember, in stereo you are getting information from both sides of the record groove so you don't want to start off with the stylus tending to lean more toward one side than the other.

Turntable and arm

Here again, from the point of view of the space required for housing in furniture, there is no difference between a monophonic table and arm and a stereo unit. When playing stereo records, the stylus pressure must be as well centered as possible

in the record groove. All considerations previously discussed relating to turntables and arms still hold true.

Tape machines

The extent to which stereo will affect the housing of your tape machine depends largely on the type of machine. This does not mean the make, but rather what it is intended to do. Some tape machines are set up to record monophonically only, but will play back either mono or stereo. Others will perform both recording and playback functions in either mono or stereo.

The units that play stereo but will record only mono differ in physical size very little, if at all, from their strictly monophonic equivalents. They, therefore, introduce no problems. However, the machine that will both record and play back stereo will, of necessity, be somewhat bulkier than its simpler mono brother. This is primarily because of the unavoidable addition of a second complete record preamp. In machines designed so that the electronic parts are mounted in one integral unit with the mechanical parts (the tape transport), the additional space may be taken in any direction, length, width, depth or any combination of these. As a result, the only solution is to measure the make you want to use, and revise as necessary the space you have allotted to tape in your cabinet plans.

If, however, your tape equipment is designed with the electronic parts completely separate from the tape transport, the transport space will be unaffected by a stereo conversion. But the preamp space will be nearly doubled, because now you must have two of them.

Preamps and Amplifiers

For stereo, as for mono, amplifiers are sometimes designed with the preamplifiers on the same chassis, and other times separately. High-powered amplifiers will generally be separate from the preamps while the ones boasting, say, 10 to 20 watts per channel, are likely to combine both functions on one chassis. This is actually quite a trick, if you will just stop to think about it. Two independent amplifiers plus two independent preamps have been piled on a single chassis, and in the process they have been kept down to remarkably manageable size. The average stereo combination preamplifier—amplifier delivering up to 20 watts per channel will measure 15 to 16 inches wide, 4½

to 5 inches high and 10 to 12 inches deep. This is very compact considering what is included in the package! Yes, it's bigger than

Fig. 119. *The simplest stereo setup, but the least desirable acoustically, is to have both speaker systems in a compartmented enclosure.*

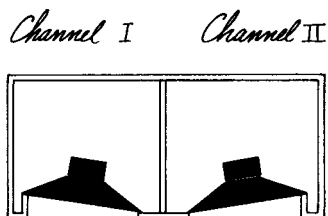

a monophonic amplifier of comparable power per channel, but it is nowhere near twice as big.

The preamp will approximate the size of the complete amp—preamps we've been discussing. You may be able to pare an inch

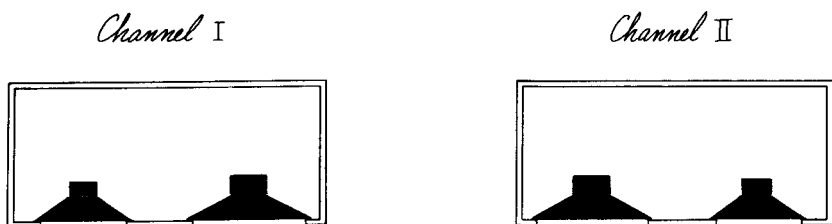

Fig. 120. *Identical speaker systems in identical enclosures.*

or two from the width or the depth, but the height won't come down much. The main difference in size between the mono and the stereo preamp will usually show up in the depth.

Speakers

Actually you have four alternatives to choose from in setting up stereo speakers. The first, and least desirable for reasons that will be dealt with in the next chapter, is to mount two separate speaker systems at either end of a single enclosure that is partitioned down the middle to divide it into two entirely separate compartments (Fig. 119). By least desirable is meant least desirable *acoustically*. From the furniture point of view, this is by far the simplest method.

The second method is to use two identical speaker systems in two identical enclosures (Fig. 120). This method is generally the best because the speakers can be placed at whatever distance and angle from each other that is best. The obvious disadvantage is that, first, you've got to have a second box, and also you must find space somewhere for it.

The third method is a good compromise when there isn't space to put two complete speaker systems in the room. For one channel set up a complete speaker system as you would



Fig. 121. Stereo setup using different speaker systems.

for mono, but cut the woofer off at 250 to 350 cycles, the lower the better. Don't let it get up into the mid-range. Use a separate speaker or speakers for mid-range and high-frequency speakers

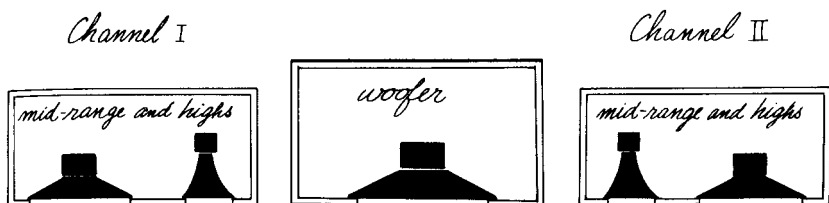

Fig. 122. Putting the woofer in the center gets rid of the apparent dead spot in the middle.

of this system only and put them in a small box for the second channel (Fig. 121). Since the stereo effect is achieved primarily in the mid- and high-ranges, and since the speaker systems are separated in these ranges, things will work out well.

If you like cabinets and in addition have a huge room, the fourth alternative is for you. Put your woofer in one cabinet in the middle and set up two mid-range and high-frequency systems in two separate cabinets spaced out on either side (Fig. 122).



CHAPTER 2

the room

IN the preliminary planning of a hi-fi system, the need for considering the room in which it is to be placed is self-evident. The question is not whether you've thought of the room but, rather, whether you've analyzed it in such a way as to get the optimum results from both the hi-fi system and the room.

From the system you have every right to expect the best sound quality it is capable of producing, coupled with the greatest possible ease and convenience of operation. At the same time, unless you are quite affluent, you will not be in a position to set an entire room aside for listening to music. The chances are that whatever room you place your system in will be used for other purposes too, and you will want to continue these activities without interference. Thus, it's not at all surprising that from time to time conflicts of interest arise. They require a bit of careful thought to solve. Actually, you are asking quite a bit of both your hi-fi system and your room.

Even without stopping to think of the room, you can go out and get a hi-fi system, put it in a room and put the two to work together, because that is the way of it. They must work together inevitably.

By means, say, of records, you will expect this combination to sound at one moment like a half-dozen jazzmen blowing their tops in a smoke-laden cellar saloon and, at another, you may want the whole thing to sound like four dignified gentlemen in black ties and frock coats, playing string quartets in an eighteenth-century drawing room, and then you may call for the entire New York Philharmonic batting out Beethoven's *Ninth* in some concert hall.

In addition, you confidently expect this combination of system and room to reproduce everything from a piccolo to a contrabass double-bell euphonium with equal clarity. This is asking a good deal of a few electronic parts and an average living room, even in this age of technological miracles.

Let's see if there aren't some ways in which we can plan things so that we get out of the sound system something somewhere near what we ought to, without at the same time ruining the room for its various other uses.

Choosing the room

Realizing that you can run secondary speakers to any place in the house you may choose, the first question is to decide what room you intend to use to house the main system. We can eliminate the kitchen and the bathroom without any difficulty. Since the control center should be handy to the most commonly used listening area, we can also eliminate a separate dining room, if you have one, from consideration and likewise the bedroom. This leaves us with really only three likely possibilities—the living room, or combination living–dining area, study, and game or rumpus room.

In the largest number of instances, the living room will be the natural choice as the control center for the system and listening center for the home. For listening, it is generally the best choice of any room in the house in terms of size and acoustics. At the same time, it is also the most difficult room to deal with in terms of noninterference with other activities since it is the normal center of the various goings-on that take place in the home and family.

Depending upon the inclinations and interests of those in the household, it is quite possible that the living room might be a bad place to house the system. If there are only one or two avid listeners in the house and they continually occupy the living room, this might constitute quite a nuisance to the others. In such cases, possibly the den or study might be chosen; there the listener can be reasonably undisturbed and undisturbing to others. The problem with a den is that it is smaller in size and acoustically not as favorable to your reproducing equipment. You just have to decide what is most important to you. Perhaps the rumpus or game room will be the most logical place in your case. If so, you are back to a room size roughly comparable to that of the living room, which acoustically is a good thing. On the other hand, you probably will not have drapes or carpeting in such a room and therefore it may be a bit live acoustically and require some treatment to cut down reverberation.

Placing the speaker

Assuming that you have carefully deliberated and have chosen the most desirable room in the home for your system from the point of view of the various activities of your particular household group, it is time to consider the specific room chosen in some detail to determine the best location in that room for your speaker and other associated equipment, and the approximate size and kind of housing you want to use.

The first and, from the point of view of sound, the most important consideration is acoustical. A system can be housed in any manner ranging from lovely to loathsome in *appearance* without

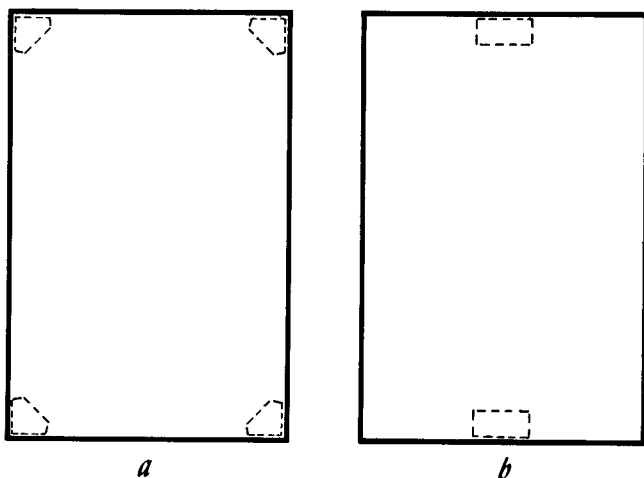

Fig. 201. There is a rule of thumb for speaker placement in rectangular rooms: (a) corner speakers work well in any corner; (b) wall enclosures function best when centered on either short wall.

causing one iota of change in the *sound* quality, provided the same acoustical considerations have been followed. The first acoustical consideration has been discussed in some detail in the previous chapter—getting a happy match, acoustically, between the speaker you have chosen and the *type* of cabinet in which you want to put it.

Room shapes

The next thing is to determine where to place it in the room to get the best results. Probably the room you have chosen will be rectangular or possibly L-shaped. I once had a client who had built a house that was S-shaped, with the result that two walls in every room were curved, but this was rather unusual. This S-shaped house, by the way, raised some rather interesting technical

problems. If you've an S-shaped house, call in an acoustical consultant—you'll need one; if you can afford the house, you can afford the consultant.

The rule of thumb for a rectangular room is that a corner enclosure can be placed in any of the four corners and work equally well, while a wall enclosure will function best if placed in the center of one of the short walls (Fig. 201).

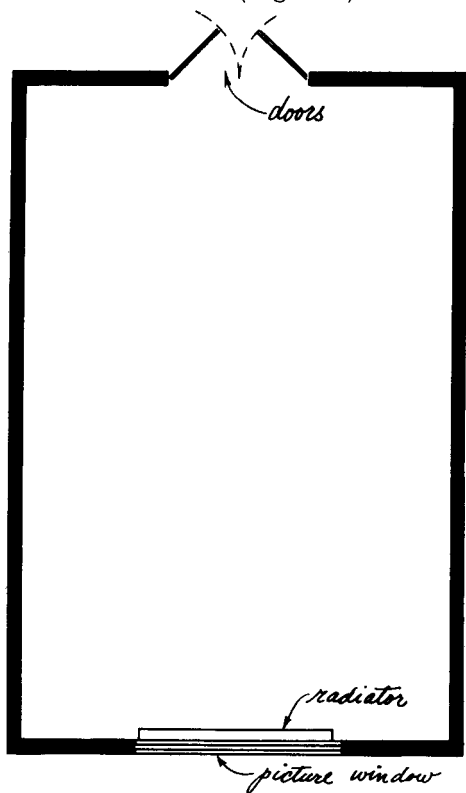

Fig. 202. Most rooms are not just four walls.
Doors and windows can be a problem.

This rule is a fine thing, except that it will leave you at a complete loss in a good many situations. It doesn't account for the fact that rooms have things like doors and windows and radiators in them. Suppose, for example, you have a perfectly good rectangular room and you intend to put in a wall speaker. The only trouble is that in your room you have a door in the middle of one of the short walls and in the middle of the other one a great big picture window with a radiator under it (Fig. 202). You obviously can't get that speaker centered against *either* of the short

walls. If you put it in front of the window, you can't get it under the sill without taking the legs off to get it low enough and, besides, it's right in front of the radiator, which is a bad place to put any piece of furniture because the heat will damage it. Besides, the cabinet will block the heat from the radiator and make it in-

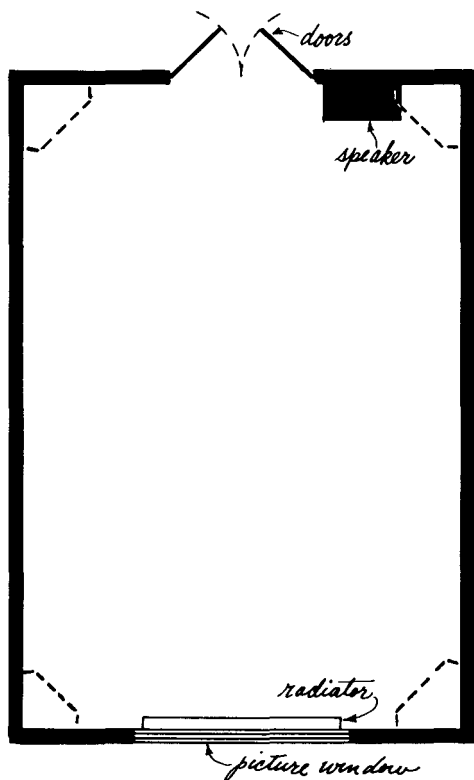

Fig. 203. When the short walls are not available corner enclosures can be used. If a wall enclosure is desired it may be placed off center on one short wall.

efficient. At the other end of the room, you obviously don't intend to put the speaker in the middle of the doorway, so what do you do?

What can you do but the next best thing? Since the speaker will operate better if it is somewhere on the short wall than if it's on a long wall, put it off center on the wall with the door as shown in Fig. 203.

Let's take another case that's even worse. Suppose you wanted to put a corner speaker in a room but you find that in one corner

you have a door, in the next a radiator, in the third a curved sofa running around the corner and in the fourth a built-in china closet (Fig. 204). You haven't got a corner, so you just cannot use a corner speaker in this room. You'll have to go back and rethink your whole speaker system. In this case, you have a short wall where you could center a wall enclosure, so the best place for the speaker system will be in the center of the short wall farthest from your curved sofa (Fig. 205).

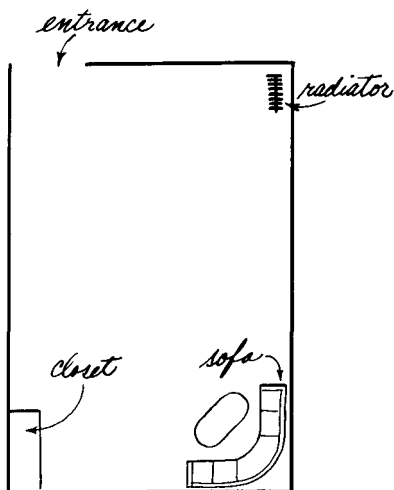

Fig. 204. Since the corners of this room are occupied a corner speaker cannot be used.

Unfortunately, no one book can give you enough examples of different arrangements of doors, windows, radiators and so on to cover all the possibilities that might be encountered, and to give you the best solutions in each case. You must rely on your own good common sense in arriving at the best possible compromise where one is possible. And also to recognize an impossibility when you see one.

In an L-shaped room, your best location for a wall speaker will generally be in the middle of the short wall forming the end of the largest part of the L (Fig. 206). If both parts of the L are of equal size, flip a coin. In the case of a corner speaker in an L-shaped room, the corner of the wall just mentioned that points diagonally toward the smaller part of the L would be the best location (Fig. 207). Another good location would be the corner forming the junction of the two parts of the L.

So much for speaker placement, except for one other matter. You don't want to be too close to the speaker when you are listening. You certainly don't want to be any closer than 6 to 8 feet, preferably more. It's not invariably true that the farther you are from the speaker, the better, because there are special cases where this doesn't work, but *usually* you can figure that the farther away

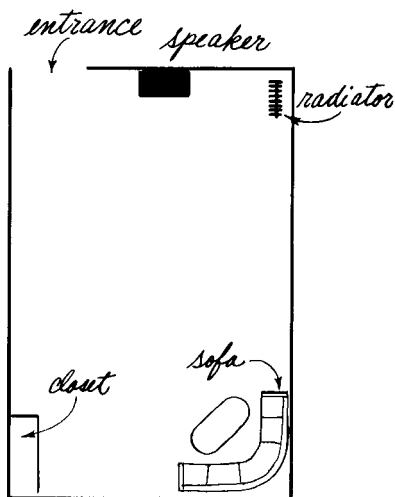

Fig. 205. Short of throwing out the sofa the only practical solution to the problem of Fig. 204 is to use a wall enclosure.

you are the better dispersion and balance will be. Also, don't sit in a location that is at a very great angle away from the direction in which the speaker itself is pointing. Try to stay within at least a 45° angle from the center line of the speaker (Fig. 208). Since high-frequency sounds are very directional, they move in straight lines, absorb easily and therefore don't diffuse well throughout the room. With most speaker systems, as you move off to the side, the highs tend to drop out.

Room acoustics

In addition to the position in which you locate the speaker in a room, other factors tend to affect the kind of sound that a given speaker will produce. For example, in a room that is too live, i.e., one where sounds will reverberate readily, a note that has just been played will still be reverberating in the room when the next one is played, with the result that the two mix and give a muddy

effect. Often this kind of muddiness is blamed on the system, when actually the room is at fault.

There are ways of both testing and calculating the exact rever-

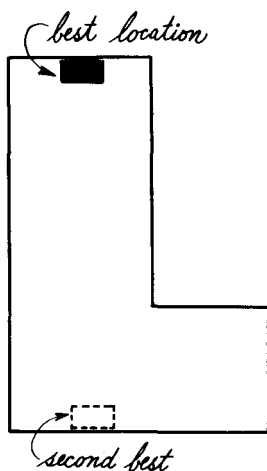

Fig. 206. The best and next-best locations for a wall enclosure in an L-shaped room.

beration time in a given room and of checking this time against a graph of optimum reverberation times for rooms of various cubic

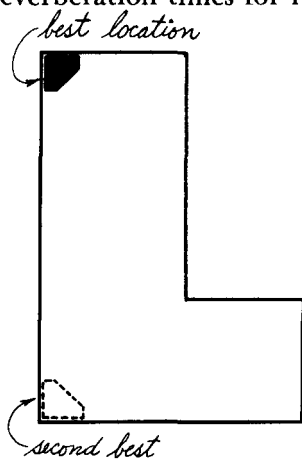

Fig. 207. Two locations for a corner speaker in an L-shaped room.

volumes to see what you've got and what you ought to have. This is a rather elaborate procedure to get mixed up in for dealing with

music reproduction in the average home. If you're getting muddy sound from your system and you think it might be the room, you can usually tell by standing somewhere near the middle of the room and clapping your hands. If the sound rings in the room for several seconds after, the room is too live. If, in addition to this, you look around the room and find that there is very little upholstery and a lot of reflective surfaces like uncarpeted hard floors and smooth plaster walls, you have another clue that indicates an excessively live room.

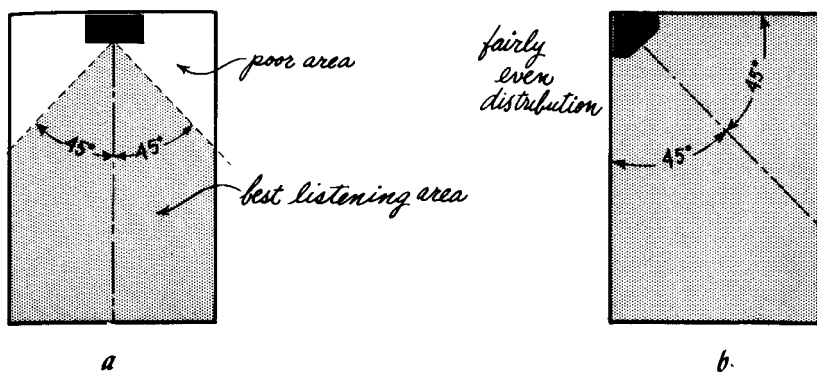

Fig. 208. Approximate sound distribution from a speaker: (a) wall enclosure; (b) corner placement.

If this looks like your problem, make one more test, just to be sure. Get a lot of heavy blankets, strew them all over the floor and hang them up on the walls. Now try your system and see if the muddiness is reduced. If it is, you've proved excessive reverberation.

If you do have this trouble, it can be solved by introducing enough sound-absorbing material to damp the reverberation to an acceptable point. These absorptive materials could be carpeting, drapes, acoustical tile or acoustical plaster. You'll be amazed at how much reverberation will be sopped up merely putting a carpet on the floor.

The average living room, is more likely to be too dead rather than too live. Nowadays, many people are using wall-to-wall drapes and wall-to-wall carpets. If your room should be a bit dead and you can easily get rid of some of the absorptive material, perhaps by taking out a drape or an overstuffed chair, fine. If not, then all you have to do is to crank up the treble tone control on the amplifier a bit to compensate for the highs that are being absorbed and forget about the whole thing.

Traffic patterns

The next factor to be considered, particularly in relation to equipment enclosures, is the traffic pattern in the room. Where do people most often enter or leave the room, and where do they move within the room in the performance of their normal activities while there? At first this may sound like a silly thing to consider in connection with a hi-fi set, but an amazing number of people have knocked their shins against an open cabinet door or tripped over a changer drawer while it was open (incidentally, often ruining the changer or the drawer) merely because no one stopped to notice where people walked most frequently. Any equipment cabinet that is to have swinging doors, drop fronts or drawers must be located where room traffic is light. Particularly if children are rushing in and out, a little thought to the traffic pattern can save a lot of cabinet doors from being knocked off their hinges.

How do you determine the major traffic pattern in a room? There are a couple of ways, and one of the simplest is merely to look at the floor. Do you see more signs of wear in some parts of the floor or carpet than others? Do you find that some parts of the floor get dirty faster than others? The parts that get the dirtiest are the parts that get the most traffic.

Another trick is to look at the doors in the room. How many ways are there to get from one to another, and which are the routes most often used?

If you really want to be a stickler about it and find out in real detail what the traffic pattern of the room is, make a scaled floor plan. Then for a couple of weeks keep track of who goes where in and through the room, and mark the routes and frequency of use on the plan (Fig. 209). However, to get enough of an idea to serve your purposes, you probably will not have to go into this much detail.

A little later on when we discuss possible shifts in the location of your furniture, remember that there are two aspects of the room traffic pattern. One is primarily influenced by the location of fixed structural features such as doors, windows, fireplaces, stairways or what have you. These cannot be moved and should not be obstructed.

Other parts of the traffic pattern are as they are because of the location of movable objects—chairs, tables, lamps, cabinets, etc.—and these patterns not only can but will be changed by moving these objects.

Next, the types of activities for which the room is used and, at the same time, where in the room these most commonly occur. For example, do you have a favorite chair to which you retire to read the paper after dinner and do you prefer to keep the chair exactly where it is? Does the lady of the house have a favorite spot where she likes to read or sew or relax? Do the children have favorite areas in the room for their activities? Is the room used as a gathering place for the entire family?

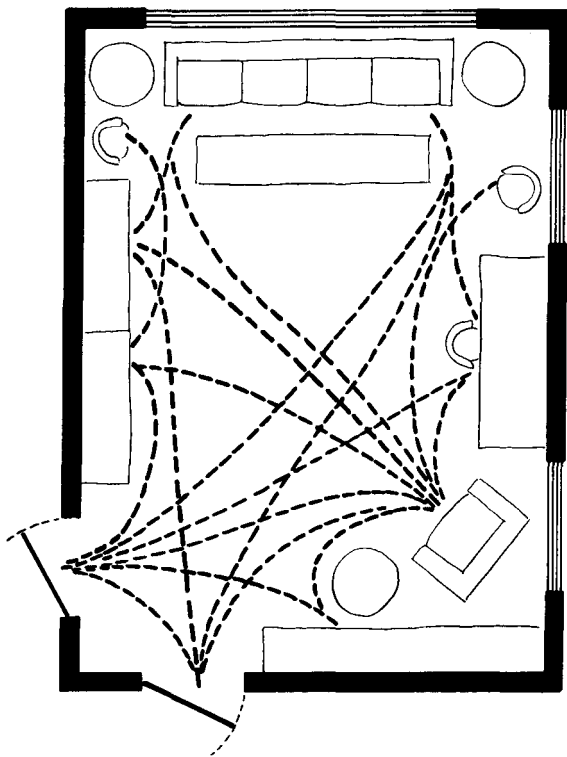

Fig. 209. The chicken scratches indicate the traffic pattern in a living room. This pattern is a variable one and must be plotted for individual rooms.

What kind, frequency and size of entertaining is done? Do you occasionally have a few friends in for an evening of cards or conversation, or is this a frequent occurrence? Do you have large parties often, or does this happen very seldom? Does the man of the house have any occasion to do a little, a lot or no business entertaining?

These questions and any others that apply specifically to your

particular circumstances must be answered to determine where the speaker (or speakers) and equipment housings can be located.

For example, if the lady of the house wants to listen to music while her husband reads the evening paper, it would seem only logical to locate the speaker so that it will not blast right in his ear while he sits in his favorite chair. On the other hand, if he is the avid listener, the same consideration applies to the wife. It might also be desirable to locate the equipment so that the controls are convenient to the favorite seat of whoever uses the system most.

If you do mainly small group entertaining, you are likely to want your equipment controls conveniently located to your main seating area so that you can change records or radio stations with a minimum of disturbance to the conversation. The equipment could be put in a cocktail or end table. If, on the other hand, you do large group entertaining, the controls for your system probably ought to be in a relatively inaccessible place where your guests will not be tempted to fiddle with them.

Service outlets

Another group of factors that should come in for consideration is the location of various types of service outlets around the room. For example, how many, what kind and where are they in relation to radiators or other heating elements? A cabinet should not be set in front of a major source of heat. Putting it there will materially reduce the efficiency of the heating element and, at the same time, do no good to either the cabinet or the equipment in it. Equipment generates a fair amount of heat itself and should have an opportunity to ventilate with some reasonably cool air. Placing *any* cabinet, hi-fi or not, too close to a heating element is a bad idea. The combination of heat and dryness can cause all sorts of grief. It can dry the glue, split joints, warp panels, check the veneer, split solid wood parts and damage the finish. However, the location of electrical outlets isn't too critical since, if the equipment is too far from the nearest outlet you can always use an extension cord. But these cords should be run carefully, to avoid the possibility of tripping.

Ventilation

Ventilation of the room is another factor. Possibly no one has ever succeeded in blocking a window with a system, but I do know of a number of cases of interferences with *access* to the window. Having to reach over a large cabinet to get to a window can make opening and closing it quite difficult.

Do not block the opening of an air-conditioning unit. A blocked air-conditioner, like a blocked heater, will be far less efficient than it should be.

The scaled floor plan

If you really want to plan a room properly, do what professional interior decorators and designers do—make a scaled floor plan first. This way you can get a sort of bird's-eye view of how things are going to shape. Granted there is a bit of work involved, but a floor plan is not difficult and can save you a good deal more trouble than it can cause. Professionals have found that this device greatly helps them to visualize and plan the relationships of the different things in a room. You will too!

Here's how you go about making a simple scaled floor plan. The first things needed are the basic measurements of the room, the

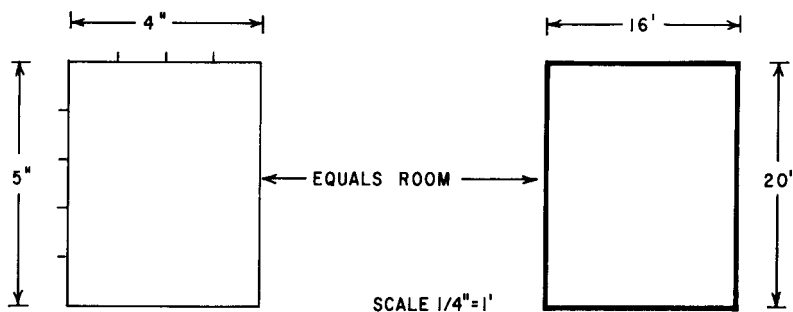

Fig. 210. One of the most important tools is a scale plan of the room.

length and the width. Also measure any L or alcove jutting out from the main area or any closet, stairway or other construction projecting into the main area.

Next, start the scaling. All this means is that you will proportionally reduce all the measurements you have taken by the same factor and then draw them on paper. The result will be a miniature version of the room, in which all lengths and distances will have exactly the same relationship to each other that they have in actuality.

How to scale

Let's take a very simple example and see how it works. Suppose you have an absolutely plain rectangular room 16 by 20 feet with no constructions projecting either in or out of it. There are windows and doors, of course, but no alcoves or L's. The floor is a simple rectangle. How would you show this in scale?

First, you decide what scale you want to use (theoretically, the

number of possibilities is infinite). In practice, very few are convenient. For example, 1 foot could equal 1 inch in your scaled drawing, or you could use a scale of 1 foot equals 1½ inches or 1 foot equals 3 inches. Actually, you can use a scale of 1 foot equals 1¾ or 7/16 inches, if you choose, but odd fractions such as these are very clumsy to work with. Use the ones that lend themselves to simple arithmetic and which will supply you with convenient sized drawings.

Architectural drawing is often done to a scale of 1 foot equals ¼ inch so, for the moment, let's use that. To get back to our example, we want to show a simple rectangular room 16 by 20 feet in a scale of 1 foot equals ¼ inch. We draw a rectangle 16 quarter

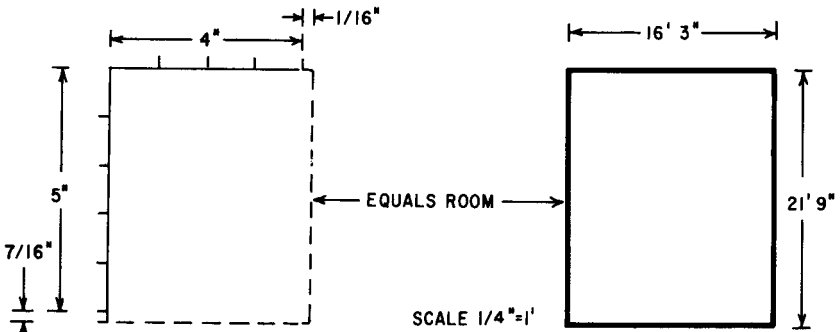

Fig. 211. When the room measurements are in fractions the job of scaling becomes a little tougher.

inches wide by 20 quarter inches long. Since 16 quarters equal 4 inches and 20 equal 5 inches, a 4 by 5-inch rectangle represents our 16 by 20-foot room (Fig. 210).

Fractional dimensions

That was an easy one because it came out even. But suppose the room measured 16 feet 3 inches by 21 feet 9 inches. We know from the last example what to do with the 16 feet and the 21 feet. Since ¼ inch equals 1 foot we have 16 quarters or 4 inches by 21 quarters or 5¼ inches. But what do we do about the 3 inches over on the width and the 9 inches over on the length? Because 3 inches is ¼ foot, to represent it we need a quarter of ¼ inch or 1/16 inch. Our scaled width is then 4-1/16 inches. On the length, 9 inches is ¾ foot or, in scale, ¾ of ¼ inch or 3/16 inch, so our scaled length becomes 5-7/16 inches (Fig. 211).

If you come up with measurements still more fractional than those given in these examples, let's say, a room with a wall 16 feet 17/8 inches, round the fraction to the nearest ¼ foot. In this

case you would round off at 16 feet 3 inches, which would give you a line length in scale of $4\text{-}1/16$ inches.

If this is still a little hazy to you, here is a practice column of measurements in feet and inches (room dimensions) and a column of line lengths in inches and fractions that represent these measurements in a scale of $1/4$ inch to the foot (scale dimensions). Cover the second column and calculate from the first what you think the line lengths should be.

Room dimensions	Scale dimensions
18' 10 $\frac{1}{4}$ "	4 11/16"
6' 4 $\frac{1}{4}$ "	1 9/16"
19' 2 $\frac{1}{2}$ "	4 13/16"
37' 6 $\frac{1}{4}$ "	9 3/8"
2' 5 $\frac{1}{2}$ "	5/8"
12' 9 $\frac{1}{2}$ "	3 3/16"

All you need is a little practice to get used to the method and you'll have no trouble scaling anything you want.

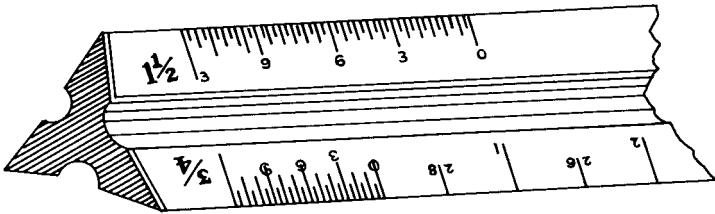

Fig. 212. A triangular scale ruler such as used by architects helps make the toughest scaling job easy.

If a scale of $1/4$ inch to the foot seems too small for what you want, use a larger scale ($1/2$ or 1 inch to the foot). The method is exactly the same.

If you have a large room and go up to a scale of 1 inch to the foot, you will end up with a rather large drawing. But it is easier to visualize things from a large drawing than a small one. Just don't make the drawing so large that it is too cumbersome to handle.

A regular architect's scale ruler will cost about \$3 or \$4, at a local art supply store, but it will save you the operation of transposing feet and fractions into inches and fractions. Get the triangular type. It has six scales on it and between them they'll cover everything you are likely to need (Fig. 212).

In any event, we'll assume now that by one method or another the basic shape of your room has been laid out in scale, showing any important projections into or out of the main area. These

projections naturally are scaled in the same manner as the main part of the room (Fig. 213).

Now measure and locate on the drawing such fixed features as windows, doors, fireplace, electrical outlets, columns, etc. Keep to scale when marking in these elements on the drawing. A window 3 feet wide and 8 feet out from a corner in a scale of $\frac{1}{4}$ inch to the foot will be 2 inches from the corner and $\frac{3}{4}$ inches wide on the drawing (Fig. 214).

Take the length and width measurements of all of the furniture already in the room. Using these measurements, lay out each piece

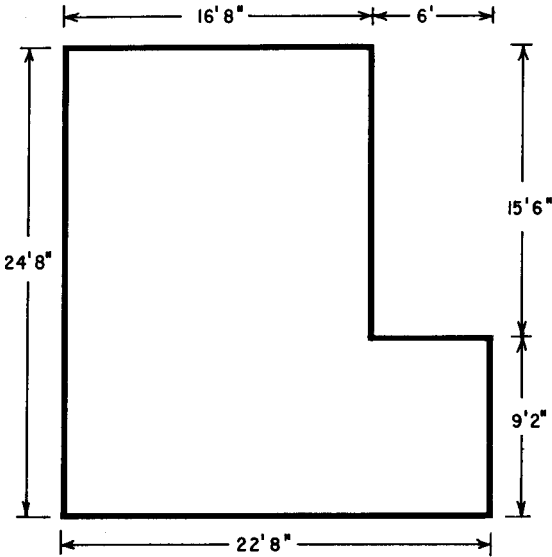

THIS DRAWING NOT $\frac{1}{4}$ " TO 1' SCALE DUE TO SPACE LIMITATIONS

Fig. 213. *The shape of the room really doesn't make scaling any more difficult.*

of furniture to scale on a separate piece of paper and cut each one out so that they can be laid on top of your main drawing and moved about at will (Fig. 215). If the paper cutouts have a tendency to curl, make them of light cardboard.

By placing these cutouts in their appropriate positions on your drawing, you will be able to represent your room as it is at present, and also try various alternate arrangements. By using watercolors, crayons or colored pencils, you can play around with color schemes too, if you like.

On the basis of your equipment and what we've discussed in Chapter 1 regarding the amount of space required by it, you

should be able to approximate the amount of space your hi-fi cabinets will require. Scale them and make cutouts for them in the same manner as for your other furniture. You may, by now, have two or more alternate arrangements in mind, in which case scale them all so that you can try them on the floor plan to see which fits best (Fig. 216). You can now juggle things around to see how you can best arrange them.

As you experiment with various arrangements of the room and furnishings, remember to keep in mind everything we've been

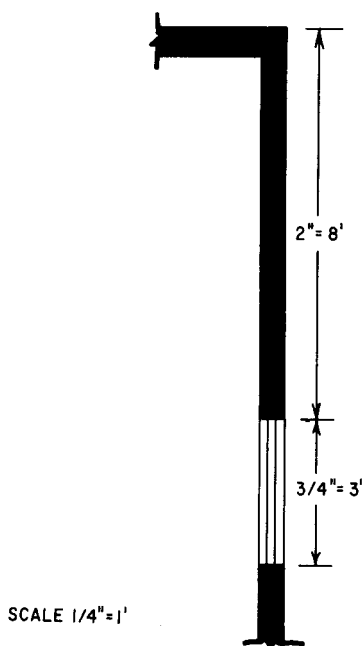

Fig. 214. Because of their small size scaling details can seem like a problem.

discussing. Your speaker cabinet should be in an acoustically favorable place, but not interfering with the traffic pattern. And recall that, as you move things from present locations to new positions, you will inevitably alter that pattern.

If everything looks OK, you are ready for the acid test, which is to try out the setup that you now have on the drawing. We'll assume you haven't got the hi-fi cabinets yet so you cannot try them in place. But you can try what you have got.

It may be that in laying things out you discovered that it was impossible to keep everything and still add a hi-fi rig. You have

had to eliminate something to clear the necessary space. Before you get in too deep take out of the room whatever has to go and see if you are going to be comfortable without it. On paper you may have eliminated the wrong things. Perhaps you really need what you had planned to take out. It is also possible that you can perfectly well dispense with something else you hadn't thought of in order to make things as comfortable as they ought to be. Now that you are looking at things more critically, you may see that a lamp here or perhaps a little table over there would certainly be very helpful.

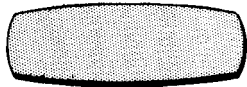

coffee table 60"x20"

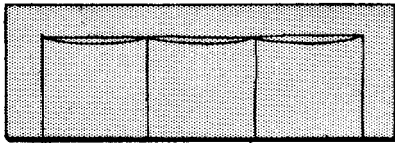

sofa 96"x34"

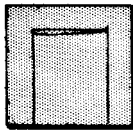

club chair 32"x32"

scale 1/4" = 1'

Fig. 215. To make the scaled drawing of the room complete small scale cut-outs of the furniture are needed. It is easier to shove pieces of cardboard around than it is to shuffle the furniture.

It would be surprising if you do not find that you have done yourself a big favor by critically examining your room and your use of the space in it. Whether you own or rent, a good deal of money is involved in that space. If you are not using it to the best advantage, if you are not able to do the things you want to do in it comfortably and easily, you are a long way from getting your money's worth out of it. And in many cases, the fault lies with you, not with the way in which the architect designed the space. Granted there are both houses and apartments that make one wonder how anybody with all of his senses intact could have seriously intended them to be used as human habitations, but you'll be

pleasantly surprised at what can be done in the way of gaining good space utilization if you are willing to use a little ingenuity and make a moderately educated effort.

Stereo and the room

If you are considering stereo at all, and these days who isn't,

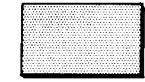

equipment cabinet 36"x18"

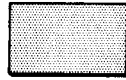

speaker cabinet 30"x18"

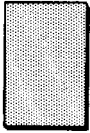

equipment table 20"x30"

scale 1/4" = 1'



corner speaker 24"x24"

Fig. 216. Tentative cutouts of the hi-fi cabinet possibilities make the job of scaling complete. Now you can see what you have and what you want at a glance. If it isn't right, tear up the cutouts. This is easier than making a mistake and being caught with cabinets that are good only for firewood.

start thinking now about how stereo will affect your room planning, and also how certain unalterable features of the room may

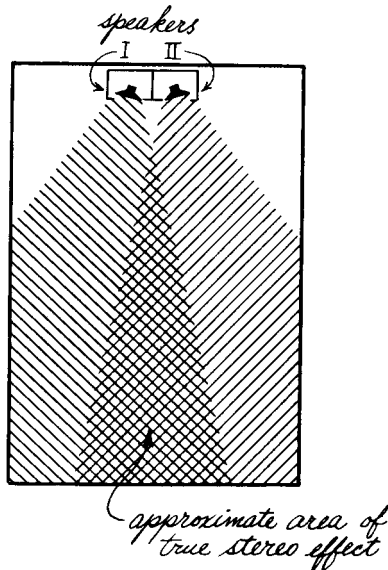

Fig. 217. Sound distribution pattern in a rectangular room.

affect your plans to set up a stereo system. This is equally true whether you intend to start now from scratch with a completely new stereo system, to modify an existing system to handle stereo or to install monophonic equipment for the present with intent to alter to stereo in future.

Neither stereo signal sources (tuner, record player, etc.) nor amplifiers and preamps are likely pose problems of finding housing space. Stereo components in these categories do not differ significantly from monophonic ones in size or mounting require-

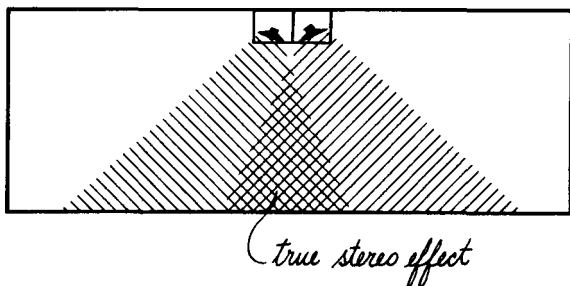

Fig. 218. *The center of a long wall is not a good position for the enclosure.*

ments, with the exception of high-powered amplifiers and the larger tape machines. If you have been able to allocate space in the room to their monophonic counterparts, you may not have to alter your present allowances by more than a few inches here and there to accommodate the stereo units. While it is entirely possible that in some cases no increase at all will be necessary, you will probably find that you will require additional space for the speakers.

Stereo speaker placement

As far as room space and placement are concerned, there is a big difference between monophonic and stereo. So let's take a second look at the four basic types of stereo speaker arrangements, this time with an eye to seeing under what room conditions each can be expected to operate successfully, and at the same time note what conditions might impair proper operation.

The first arrangement, discussed in Chapter 1, is to enclose two matched speaker systems in opposite ends of a single cabinet that has been divided internally into two separate compartments. This method works best when the enclosure is placed in the center of a short wall in a rectangular room. The approximate sound distribution pattern (Fig. 217) shows why. The true stereo effect

occurs only in the area where the individual distribution patterns of the two speakers overlap.

This center-of-the-short-wall location, incidentally, is also the location of choice for a monophonic wall speaker. If you had already planned to place your mono speakers there, it will be no hardship at all to switch to stereo.

You may remember that the middle of the long wall was considered no good for your mono speaker, and it is no good for stereo either. Fig. 218 shows why—and it is the same basic reason. The area of balanced sound is small relative to the entire room.

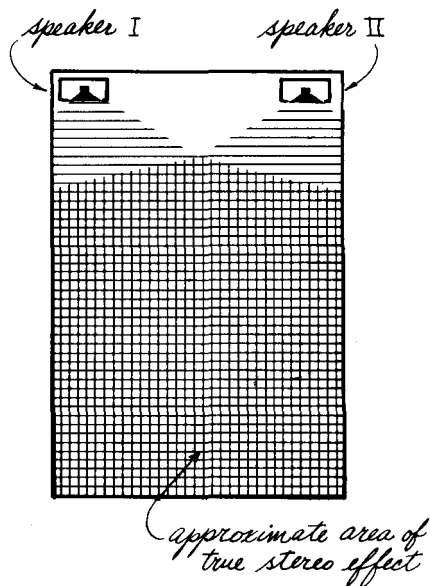

Fig. 219. Enclosure positioning to get a large stereo area.

Moving the speaker back and forth along this wall will do no good either, unless you want to tolerate a relatively small listening area.

Looking at Fig. 217 again, you can see that, if the enclosure is moved very far off center on a short wall, you'll soon start reducing the area of true stereo—which is no good either. Therefore, if the enclosure cannot be kept fairly near the center of a short wall, do not use this single-cabinet method of housing stereo speakers.

The single-cabinet system is not much good in L-shaped rooms. Add an L anywhere you like in Fig. 217 and you still won't get any appreciable stereo effect in the short arm of the L. Of course,

L's are rather difficult to drive anyway, and stereo only compounds the problem.

Let's look at the second alternative, twin speaker systems in

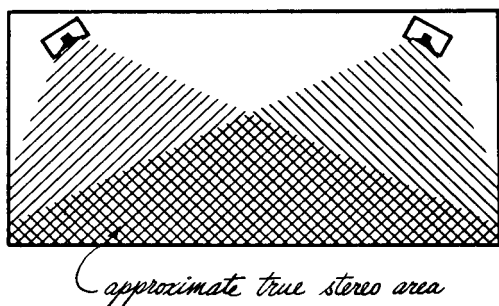

Fig. 220. Enclosures can be used against a long wall to supply a moderately-sized stereo area.

twin cabinets. Acoustically, this is a good solution. It generally works best if the two systems are placed in the corners of a short wall in a rectangular room (Fig. 219). In this way an extremely

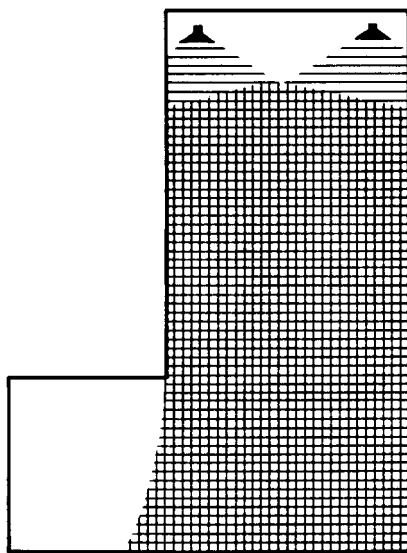
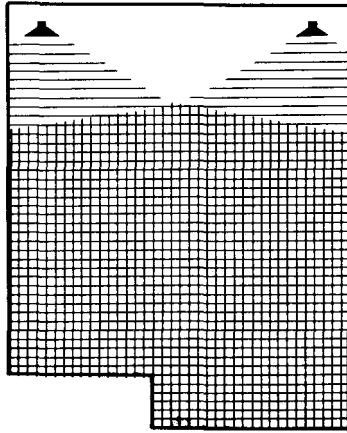

Fig. 221. Stereo effect in a room having an alcove.

large area of the room gets a true stereo effect. Obviously, the area receiving this effect is vastly larger than when the preceding positioning is used. If for one reason or another the speakers are

not right *in* the the corners, you can still get true stereo throughout a substantial part of the room as long as they are well sepa-



alcove

Fig. 222. In this arrangement the alcove forms part of the listening area.

rated. In any particular room, once the spacing between the speakers has been fixed, you may have to experiment to arrive at

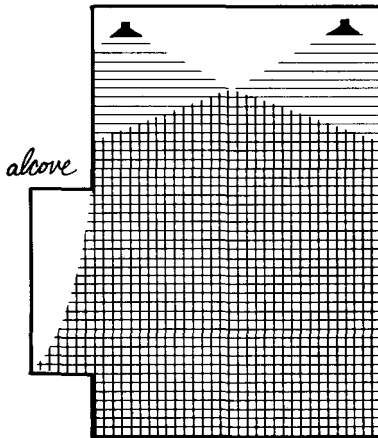

Fig. 223. In this room only a part of the alcove is in the stereo-effect area.

their optimum angle from the wall to get the best sound over the largest possible area.

The glaring disadvantage of this approach is the need to find

space for two speaker boxes instead of only one, but on the plus side you do have a reasonable amount of flexibility as to placement. For example, if you have no choice but to place the speakers on a long wall, you'll still get decent stereo over a fair area (Fig. 220).

The L-shaped room still presents a nasty problem, and the best solution is often to treat it as though the larger arm were a plain rectangular room (Fig. 221). The "true-stereo" area will

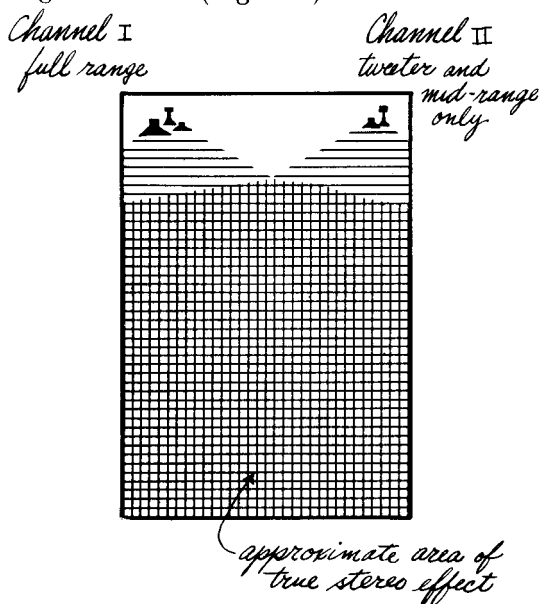

Fig. 224. The best position for the tweeter and mid-range speakers is in one corner of the short wall.

overlap a bit into the short arm, but generally not very much. So you'll do your stereo listening in the large arm.

In a room with an alcove at the far end of what will be the true stereo area, the alcove will form an extension of that area (Fig. 222). But alcoves off to the sides are likely to act like L's acoustically, particularly if they get very deep. The stereo effect is likely to be lost in a good part of the alcove (Fig. 223). Very little can be done about this, except to deplore it and stay out of the alcove.

A number of extremely compact full-range speaker systems suitable for stereo use are presently available, but you may not have the space for them. Or perhaps, with a sizable investment in

one big-full range system, you are reluctant to cut it back so that you can match it with a second one or cannot afford to match it as it is.

Then, the third alternative may be for you. Keep the big system as it is, but for your second channel, get a small system for just mid-range and highs. That is the range in which the stereo effect lies anyway, so very little will be lost by omitting the bass end of the second channel.

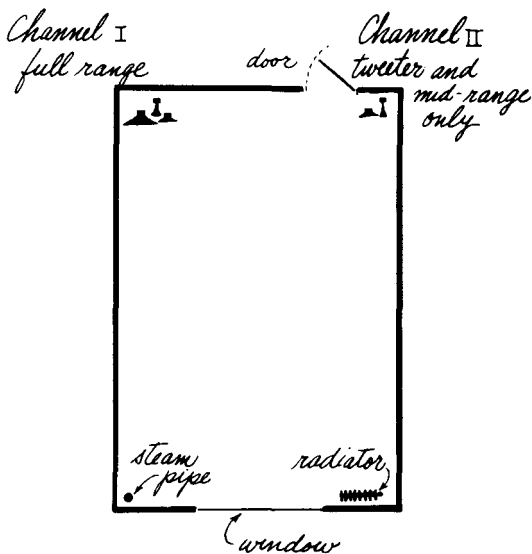

Fig. 225. In this room arrangement only one short wall is available for a two-channel system.

In a rectangular room, treat this setup much as if it were composed of two matched speaker systems. The best position will again be the corners of a short wall (Fig. 224).

There is another instance when this arrangement might be particularly desirable. Suppose you have a rectangular room such that one of the short walls is completely out of the question as a speaker location because of other furniture, traffic, radiators, wife's flat refusal or other reasons, and the other short wall has a door close to one corner (Fig. 225). Perhaps you couldn't get the full-range system you'd prefer into the space available, but a mid-range and tweeter setup will fit next to the door with the full range system in the other corner.

Try not to use this unbalanced arrangement on the long walls

of rectangular rooms. If the full-range system gets too far away from the tweeter–mid-range system, you are likely to start missing the bass that’s out of the second channel.

In an L-shaped room, the same old problem that stereo won’t bend around corners very well is still there.

Alcoves, too, will behave about the same now as they did when both speaker systems were matched, and for the same reason.

The final alternative in speaker arrangements consisting of a woofer in the center flanked by two independent tweeter–mid-range systems is primarily for use in quite large rooms. If the shortest wall of a room is 20 or 30 feet, twin matched-speaker systems—even quite large ones—can be troublesome. If twin speakers are too far apart, you are likely to get the effect of a dead spot or “hole” in the middle. In such cases, putting the woofer in the center fills the hole quite successfully and evens the sound distribution quite considerably. But the woofer, must be fairly well centered to get proper results. You can take a little leeway either side of dead center in placing the woofer, but don’t take very much or you won’t get the effect you are after.

In fact, this kind of stereo setup is considered by some to be one of the more economic ways of coming close to the ideal stereo speaker arrangement. Some speaker manufacturers are marketing special units for this purpose. A centrally located woofer which cuts off above 300 cycles is used in conjunction with tweeter–mid-range units which are precisely matched. At least one manufacturer uses horns for the balanced upper ranges. The result is that the two side units are in narrow, easily placed enclosures.

Illusory effects

It has been suggested that the so-called hole-in-the-middle effect is simply a visual–aural illusion. Several experimenters feel that they have proved this point. A properly positioned two-channel speaker system was set up behind an acoustically transparent but visually opaque curtain. Almost all of the listeners reported that what they heard was a remarkably full performance without the ping-pong effect that was one of the bugs in a two-channel system. When the curtain was removed, however, the hole-in-the-middle made a remarkable reappearance.

This doesn’t mean that you should howl “eureka!” and run out to buy yards of drapery material. You’ll need special cloth, and the visual effect on the room may not be what you want anyway.

Enclosure shapes

Aside from the necessary differences between the shapes of a wall and corner enclosure, the boxes which hold your stereo speakers can be long or short, lean or squat, or any other combination you desire.

Having the proper balance between speakers is one thing and having identical enclosures is another. If you already have a speaker system housed in one of the larger enclosures, it does not mean that your stereo addition must be its twin.

Provided you have amplifiers capable of driving one of the low-efficiency bookshelf units, there is no reason why you cannot use it to provide the second channel for a stereo system.

Don't get me wrong! From an esthetic point of view it's often a good thing to have similar enclosures as far as size and shape go. But if your tastes run to asymmetrical arrangements you can use a tall narrow unit near a wide squat one and still get acceptable stereo.

Sometimes the very nature of the room will exclude all possibility of using matched enclosures, particularly if the furniture used for an original system is large. Again, the problem must be approached intelligently—if you have to sacrifice a comfortable chair in order to squeeze another large enclosure into the room, when you have space for one of the compact ones, then it would seem only sensible to keep the chair and not worry about the David and Goliath atmosphere of the cabinetry.

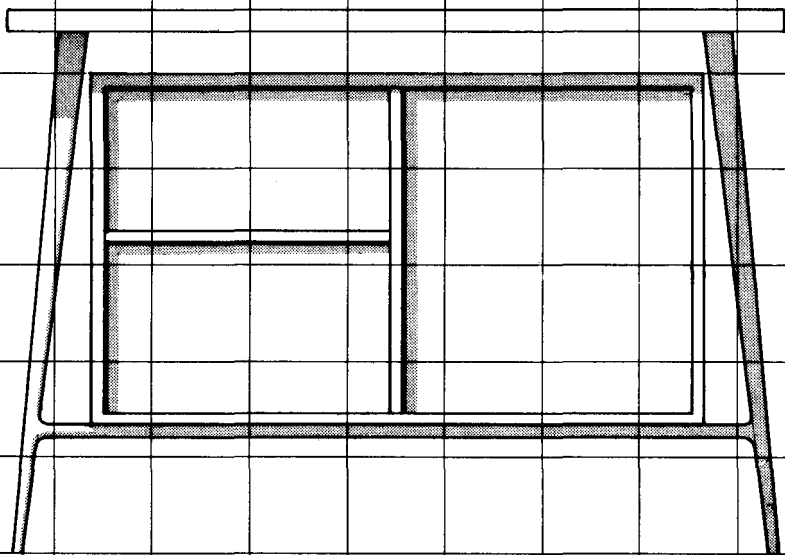
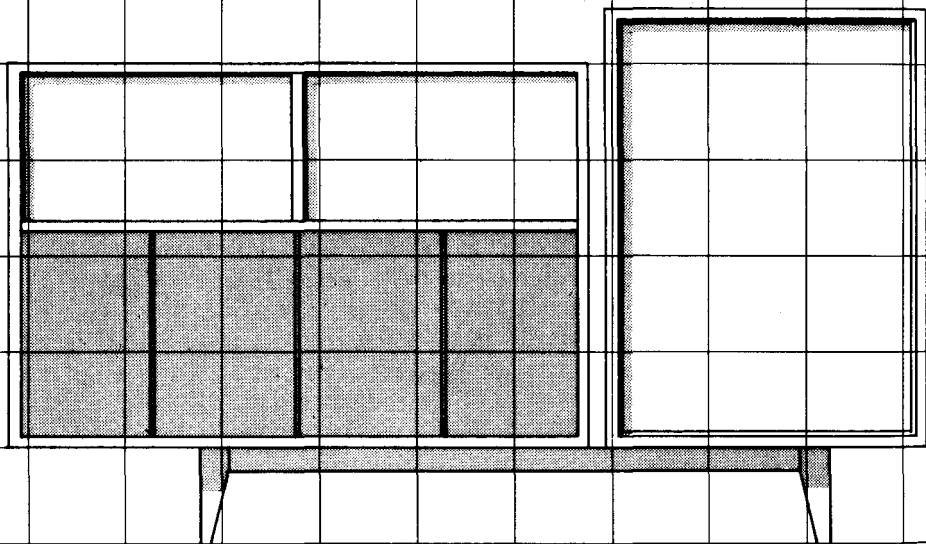

JEFF
59

fundamentals of design

BEFORE you can successfully house anything—a dog, a chicken, a car, or hi-fi system—you must examine it to find out how it operates and what limitations it imposes on the design of its housing. We have already done that for various types of audio equipment. We have also taken a look at the room in which the system is to go.

There is one more factor which must be considered before the specific design ideas for your system can be put into concrete form. That is the question of what is *good* design.

Elements of good design

A good design is one that functions properly. That is to say, it serves adequately the purpose for which it was built. But what

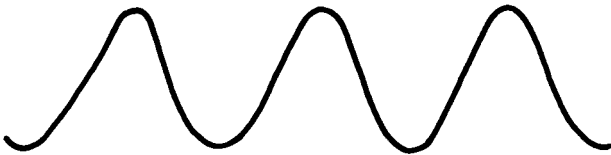

Fig. 301. *The sine wave is the simplest regular waveform.*

makes it pleasant or unpleasant to look at, proportionate or disproportionate within itself? This is a question that is difficult to answer, because there is so much of individual taste and judgment involved. However, certain basic principles underlie the whole question and knowing a little about them will help you formulate opinions more clearly.

That you have this book in your hands indicates that you're interested in high fidelity, which in turn shows that you know something about music. Since some useful analogies can be drawn



Fig. 302. *When a wave contains a harmonic it becomes complex. Although this waveform is not smooth it repeats at regular intervals.*

between music and design, let's start from something you already know and work out from there. In the area of auditory sensations, what distinguishes music from noise? Music has a type of order about it that noise does not. If, for example, you feed into an



Fig. 303. *Noise is characterized by its random irregularity.*

oscilloscope a single musical tone without harmonics, you will see regular and orderly repetitions of the same waveform (Fig. 301). Adding a harmonic changes the shape of the wave. You'll have a more complex curve, but the wave will remain regular in that you

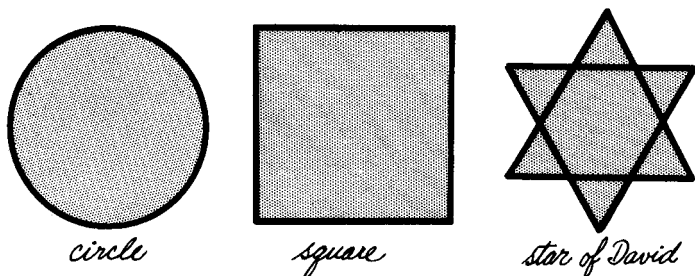

Fig. 304. *These simple shapes illustrate visual order.*

will see now repetitions in an orderly fashion of a more complex waveform (Fig. 302). Now feed some noise into the same scope. You'll see waveforms, but they will be neither regular nor orderly (Fig. 303). Perhaps you're thinking—and rightly, "that's all well

and good, but I've heard musical sounds that pretty well approximate noise." In some of the more modern compositions dissonances do sound close to noise. And by the same token there are noises, such as the whistle of a steamship, that are definitely musical.

In the field of design we can take this same basic proposition practically verbatim. Design is an ordered form of visual experience whereas that which is not design is a non-ordered or disordered form of visual experience. A random outcropping of

Fig. 305. *A magnified view of the crystalline structure of a snowflake showing a complex example of visual order.*

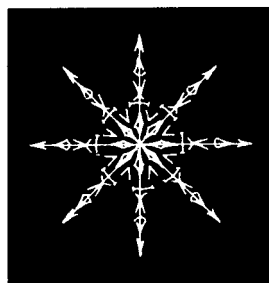

rocks on a Vermont hillside is not design but the shapes of the leaves of, say, an oak tree on that same hillside are. They have a regular pattern and order in their shape. The simplest designs

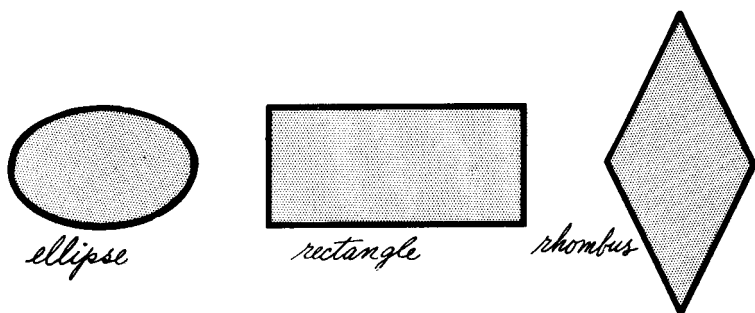

Fig. 306. *The ellipse, rectangle and rhombus illustrate order.*

that we can recognize, whether man-made or natural in origin, are those based upon geometric shapes. The circle, the square, the six-pointed Star of David, all have a regularity that constitutes visual order (Fig. 304). The same is true of more complex geometric forms such as those in a microscopic view of a snowflake (Fig. 305), or the patterns seen in a kaleidoscope. These more complex and decorative patterns, are still based upon the simple geometric forms of regular five- or six-sided figures. The ellipse, the rectangle and the rhombus (Fig. 306), exhibit a

slightly different formal order from the geometric figures mentioned. The familiar parallelogram is also an ordered shape (Fig. 307). But the basis of its orderliness is not quite as obvious as that of the previous examples.

Static and dynamic order

There are *two types* of order. One is static and the other is dynamic. Let's go back to music again for a moment, for an

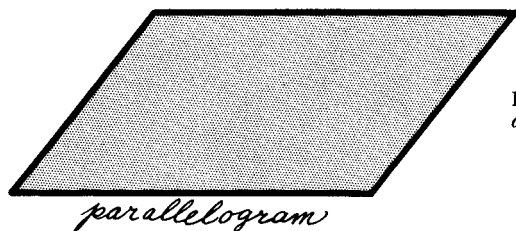

Fig. 307. The parallelogram is a simple figure which contains the elements of movement.

analogy. The asymmetrical dominant seventh chord is just as much music as the balanced and static tonic chord from which it is derived and into which it ultimately resolves. The dominant seventh is just as orderly as the tonic chord but it exhibits a different *kind* of order. The same thing is true in visual design.

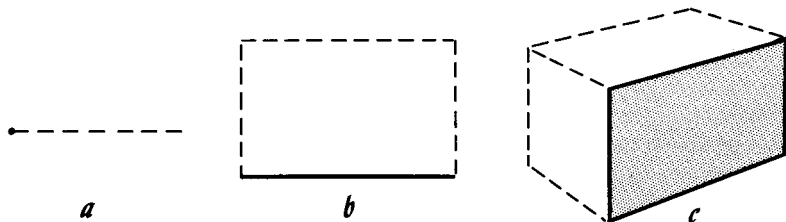

Fig. 308. Dynamic effects can be produced by static elements: (a) a point generates a line; (b) a line generates a plane; (c) a plane generates a solid.

Some designs show a static kind of order and others obtain their order from the balancing of a number of dynamic forces within the design. To understand how this happens, let us go back to the simplest component element that one can use to construct designs. You may recall from elementary geometry that a point generates a line, a line generates a plane, and a plane generates a solid (Fig. 308). Much the same thing is true in design except that the mathematical point has no relevance for our purpose and we begin with the line. If you stop to think about it, there are only two fundamental kinds of lines: straight and curved (Fig. 309). There are only two kinds of straight lines. One is the

static line which is either horizontal or vertical. The other, the dynamic line, is at any angle in between (Fig. 310).

The horizontal or vertical line has force and direction along

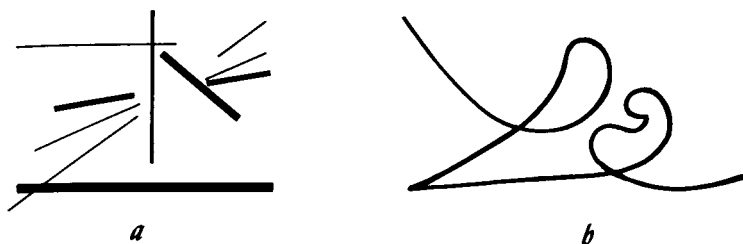

Fig. 309. There are only two basic kinds of lines: (a) straight; (b) curved. However, these simple elements can be used to create patterns which imply movement.

its own length but that is all (Fig. 311). Like the tonic chord in music, it is at rest. It doesn't feel as if it wants to go anywhere

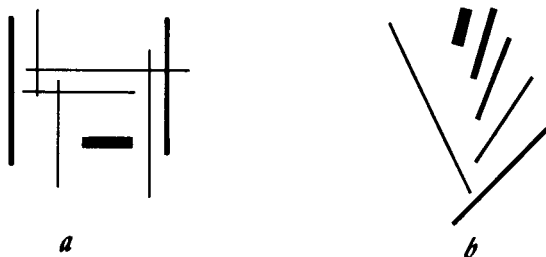

Fig. 310. Lines of force, dynamic lines, are produced by angular conformations: (a) although a static composition the vertical and horizontal lines produce areas of force; (b) the simple angled lines produce a greater feeling of movement.

beyond where it is. By contrast, the angled line is similar to the dominant seventh in music. It has its own internal force along

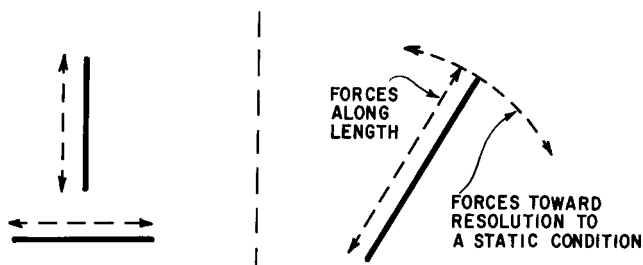

Fig. 311 (left). Visual forces (arrows) produced by static lines.
Fig. 312 (right). Dynamic lines produce stronger and more varied forces.

its length, as do horizontals and verticals, but like the dominant seventh it seeks resolution. The eye wants to resolve it to the nearest horizontal or vertical (Fig. 312). The angled line in design calls for another to counter the force with which it seeks

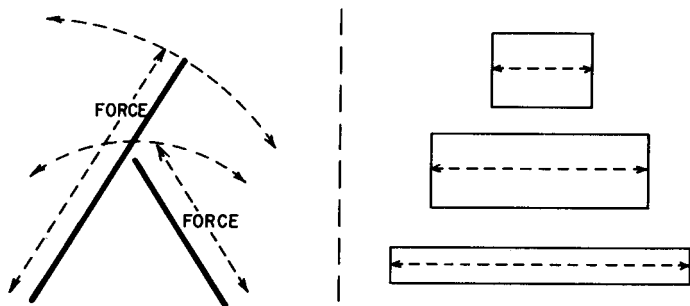

Fig. 313 (left). Converging dynamic lines produce an even greater number of visual forces. The result is an enhanced sense of motion. The figure seems to be poised, ready to move. Fig. 314 (right). Horizontal rectangles have a basic direction along their long axis. They "want" to spread.

resolution (Fig. 313). In this way it begins to find balance in the forces inherent in the directions of the two lines. In the

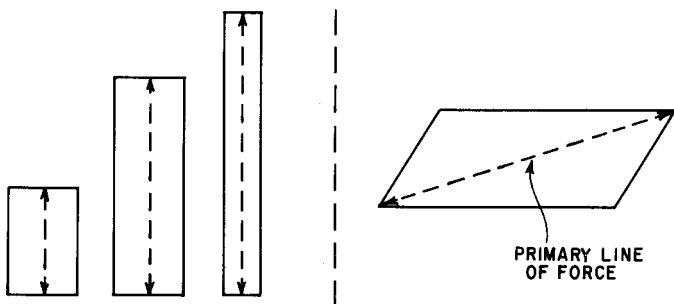

Fig. 315 (left). Vertical rectangles also seem to want to move along the long axis. Because of their upright form they seem to try and stretch. Fig. 316 (right). The direction of a parallelogram is along the primary line of force. It seems to want to resolve back into a straight line.

design of furniture, angled lines can be brought into balance against horizontals or verticals or, occasionally, be left in an unbalanced condition. It is on the basis of the inter-relationships between the forces and directions of lines that a full-grown design is finally developed. By using groups of connected lines, we can begin to develop planes and these planes, like lines, will give the eye a feeling of force and direction. For example, a low, wide

rectangle will partake of the feeling of a horizontal line. The lower and wider it is, the more it will assume horizontality (Fig. 314). A high, narrow rectangle will feel strongly similar to the vertical line and, again, its verticality will be strengthened by an increase in its narrowness relative to its height (Fig. 315).

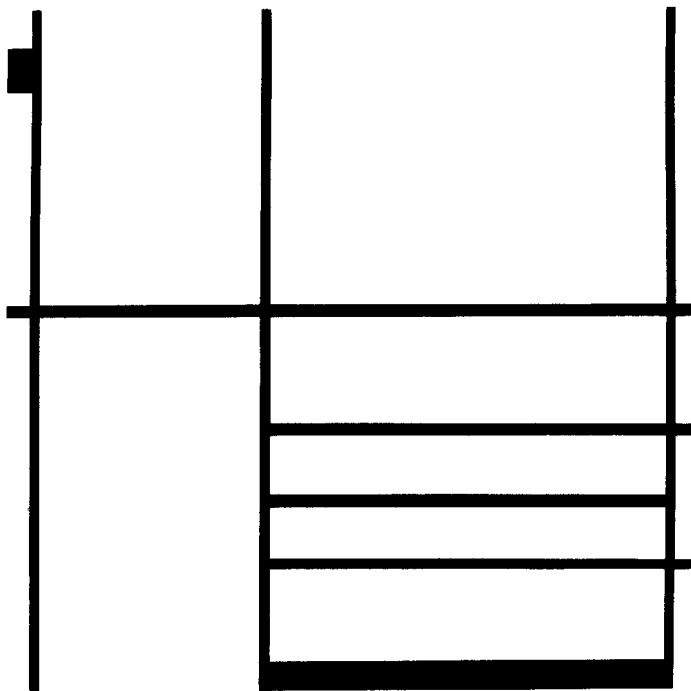

Fig. 317. Piet Mondrian pioneered in producing a sense of movement through the use of static lines. Shown is "Composition in White, Black and Red." (Collection, Museum of Modern Art.)

The planes formed by horizontal or vertical rectangles or squares, since they give the same general feeling as a static line, would be considered static planes. Compare this with the feeling you would get from a plane in the shape of a regular parallelogram. The main feeling of direction in such a plane would be along a diagonal through the two acute angles of the parallelogram (Fig. 316). This in turn is a dynamic line, and the entire plane partakes of the feeling of restlessness inherent in the dynamic line forming its main direction.

Probably you have already anticipated the reason why so much furniture, both historically and in modern times, has been designed around solid masses which, in turn, were constructed

from combinations of static planes. If a home or the furniture in it were designed on a basis of dynamic planes, perhaps parallelograms or, worse yet, completely irregular figures of one sort or another, it would be an unnerving place in which to live. If there were no repose or resolution in the design of one's surroundings, the visual influence could have quite profoundly disturbing emotional effects.

Dynamic lines in furniture

Does this mean, then, that the only satisfactory lines for furniture are static ones? Not by any means. To return to our musical analogy, this would be the same as attempting to compose a piece

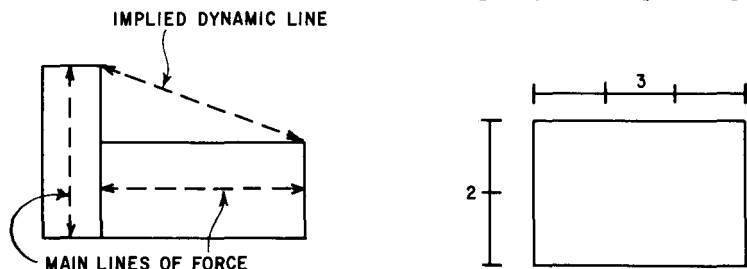

Fig. 318 (left). Horizontal and vertical rectangles imply a diagonal dynamic line. The static forms create dynamic forces. Fig. 319 (right). Horizontal rectangle proportioned two to three.

of music using nothing but the tonic chord. The dreadful dullness of such a composition is not difficult to imagine. But, fortunately, here our analogy between music and design breaks down a little. In music we have only one tonic chord in a given key; in design we have two tonics, the horizontal and the vertical, and they can interrelate with each other in interesting ways. The interrelationships between horizontal and vertical lines were extensively explored in recent years by the painter Piet Mondrian, and many fields of design, furniture included, have benefited greatly from his explorations. Among other things, he demonstrated that it is possible to organize a series of rectangular areas which are inherently static in such a manner as to create a dynamic whole (Fig. 317). This dynamism results from diagonals or, if you please, dynamic lines that are *implied* rather than expressed directly.

Actually, only the terms, not the reasoning, are unfamiliar. Suppose you have a horizontal rectangle and at the end of it you join on a vertical rectangle (Fig. 318). It doesn't matter whether this drawing is an end in itself or a sketch for a piece of furniture

or a building. You've implied a diagonal running down from the vertical to the horizontal rectangle.

This is exactly the sort of thing that is done by a designer when he works out an interesting pattern of doors and drawer fronts, on a cabinet with a front plane that is a simple horizontal or vertical rectangle. Let's demonstrate this by taking a simple horizontal rectangle with a relationship of height to width of 2 to 3. This happens to coincide exactly with a standard cabinet's case dimensions of 2 feet by 3 feet wide.

We'll assume that this 2 by 3 rectangle forms the outline of the front plane of a cabinet that will be used to house hi-fi equipment (Fig. 319). Let's look at some of the ways in which the plane can be subdivided to make it visually more interesting and, at the same time, subdivide it in such a way that adequate spaces for equipment inside the cabinet will be provided. All the arrangements inherent in even such a simple appearing problem as this are too numerous to cover here. So we'll stick to some of the simpler possibilities and see why they were used. After you've seen the how and why of these, you'll possibly think of some solutions of your own that you like better.

The simplest thing possible is to make a vertical division of the space right down the middle. In practice, a pair of doors could be hung at the sides and meet in the middle. Behind these doors you would make internal subdivisions in the cabinet for your various pieces of equipment and perhaps record storage.

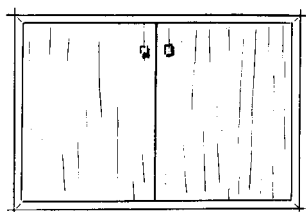

Fig. 320. *A cabinet front designed to the proportions of Fig. 319.*

Right off, thinking in terms of a cabinet, there are many ways in which even a simple subdivision of a space can be accomplished, each of which will result in a slightly different appearance. One way is to hang the doors flush with, but inside the front edges of both the sides, the top, and the bottom. This in effect doubles the outline and strengthens the shape of the original horizontal rectangle relative to the two new vertically created rectangles (Fig. 320).

There are also three other immediate ways of achieving substantially the same functional effect with a slightly different

visual effect in each case. First, let's bring a center partition through between the doors (Fig. 321-a). This doubles the center vertical line and increases the feeling of verticality as against the horizontality of the outline. Now let's try letting the doors overlap the sides but not the top and bottom (Fig. 321-b). And, finally let's try letting the doors overlap both sides and the top and bottom so that all that is seen from the front are two vertical rectangles comprising the doors (Fig. 321-c). Each of these varia-

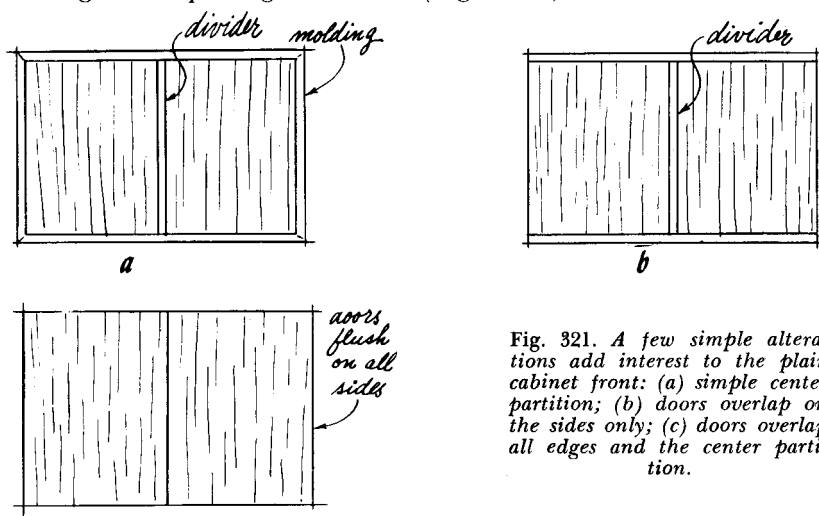

Fig. 321. A few simple alterations add interest to the plain cabinet front: (a) simple center partition; (b) doors overlap on the sides only; (c) doors overlap all edges and the center partition.

tions has a slightly different visual effect. And, remember, we've been talking only about what is really one basic kind of subdivision of a rectangle as applied specifically to our audio cabinets.

Still talking only about possible subdivisions of a 2 by 3

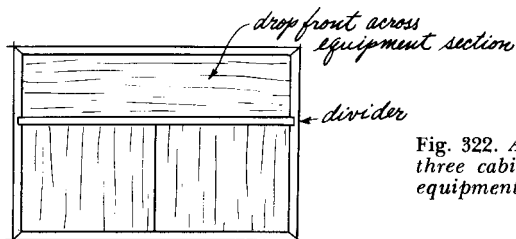

Fig. 322. Another variation of the two by three cabinet. The drop front across the equipment section produces the low long look.

rectangle for the front of an audio cabinet, let's look at a few more possibilities. We could have a drop front clear across the upper portion of the cabinet over the equipment, and doors opening over the lower section for record storage (Fig. 322). Or, leaving the lower section as it now is, we could divide the

upper portion into two parts, one opening over the equipment controls and the other opening for the record player (Fig. 323). We could split the cabinet in half vertically and use one half for the equipment and record player, each opening separately, and leave the other half in a single unit for storage (Fig. 324).

This is just a sampling of the variety of ways in which a simple

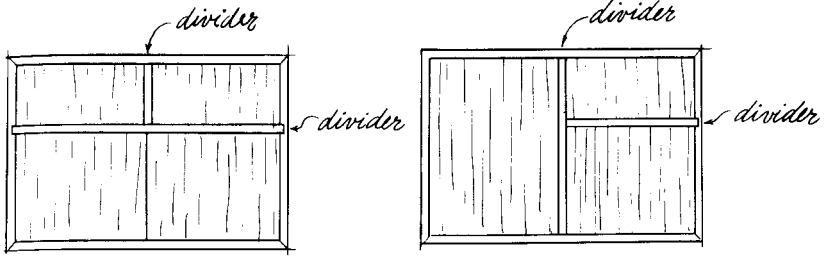
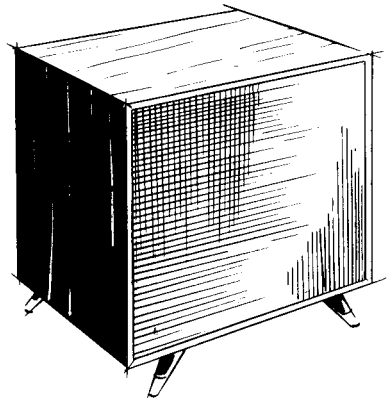

Fig. 323 (left). The upper portion of the basic cabinet can be divided for equipment controls and the changer compartment. Fig. 324 (right). The section on the left is for storage. The two sections on the right are for equipment.

2 by 3 rectangle representing the front of an audio cabinet can be subdivided to allow for the mounting of the equipment and at the same time vary the space relationships within the plane of that front.

Up to this point, we have studied two methods of enlivening a simple, rectangular plane—either adding onto it from without

Fig. 325. Although the tapered legs add to its appearance the cube form contains no dominant forces to create visual interest.



or subdividing it from within. In the process of working out a design for a piece of furniture, these devices can be used singly or in combination. And we have not by any means exhausted the possibilities inherent in internal subdivision. We haven't mentioned grain, color, texture or various types of decorative detail, all of which can be used to increase visual interest. However, let's

leave these matters in abeyance for the moment. We'll come back to them later.

So far we've been dealing with lines and planes without assembling them into the solid three-dimensional objects of furniture. Select a piece of furniture in your living room and try to get it into such a position that you can see only the front or one side. It's a bit difficult, isn't it? This points up the fact that you see any piece of furniture, not as a single plane at a time, but as at least two or more planes forming the surfaces of a solid. This solid is pleasing or not in its proportions, depending upon how these planes relate to each other.

Three dimensional relationships

Suppose you were to design a piece of furniture in the shape of a cube; that is, all the surfaces are squares. A square is a shape that has no dominant direction and, if all of the sides of an object are square, the whole piece has no dominant direction (Fig. 325). It would be dull and very difficult to liven up even by judicious use of interesting grains or decorative detail.

Now let's go back to our 2 by 3 proportioned front and develop it into a solid by giving it a depth of half the width. The resulting object will have a front wider than it is high with sides higher than they are wide. The front then will have a predominantly horizontal direction while the sides will have a vertical one (Fig. 326). As we look at our object, the interplay of these two

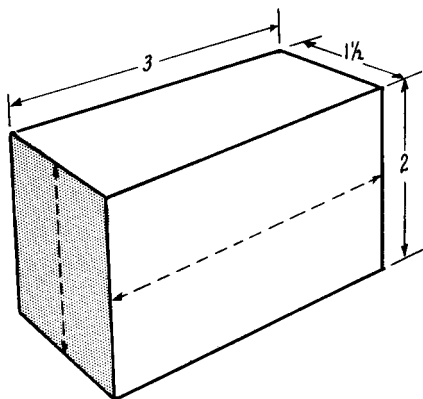

Fig. 326. *Rectangular solid; two by three by one and one-half.*

dominant directions vastly increase the visual interest of the object as a whole compared to, say, that of a cube. In the same ways that we found we could add to the interest of a plane, we can increase the interest of a solid object by adding onto it externally or subdividing it internally.

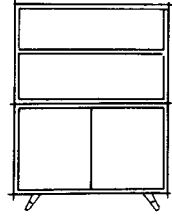
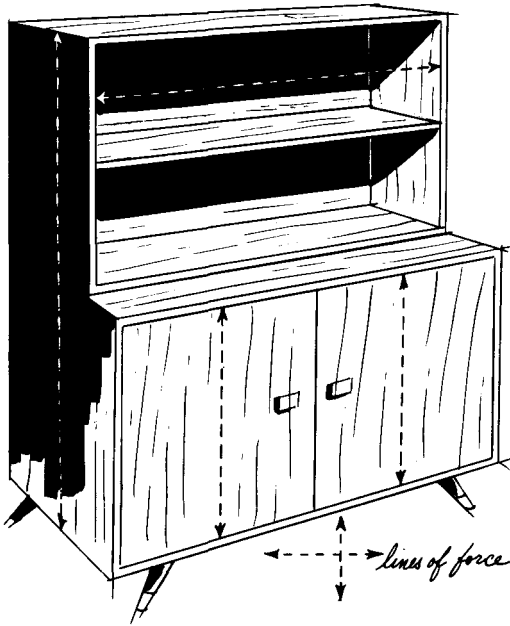
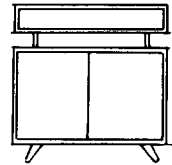
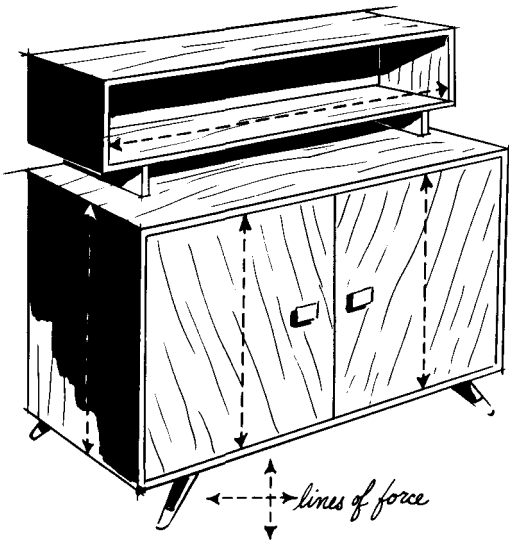

Fig. 327. Variations in depth add interest to a basically simple design.

Fig. 328. By setting back the top shelf and raising it on spacers the design of Fig. 327 takes on a fresh modern look.



Returning to our simple $2 \times 3 \times 1\frac{1}{2}$ case, let us try a few three-dimensional variations. The simplest subdivision of the unit was to split the front down the center into two swinging doors. We'll start with that arrangement and try some external additions. One of the simplest and most useful would be to place a couple of open shelves on top for either books or records. By looking at the front planes or front elevation of this variation, we don't appear to have made a very interesting change. But let's look at it in perspective. By making the shelf section approximately one-third shallower than the main cabinet and leaving

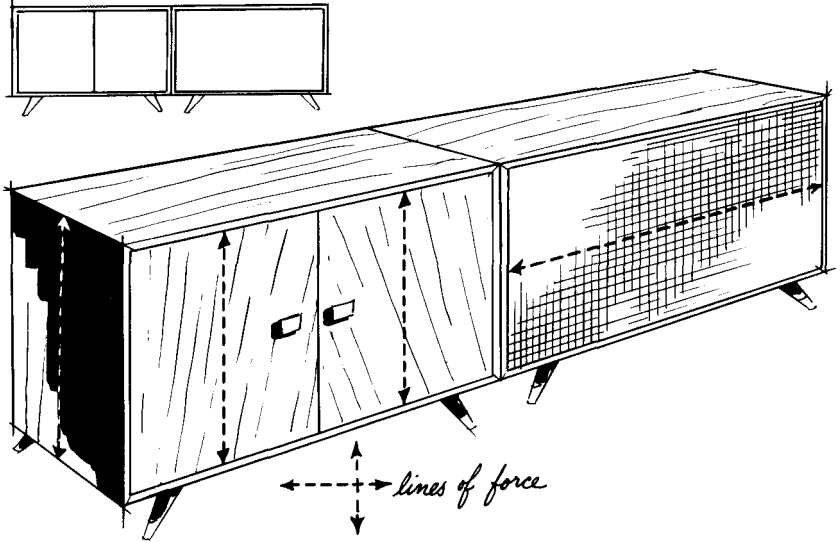

Fig. 329. Adding a speaker enclosure of the same size and shape to a simple cabinet produces a functional unit.

the front of the shelf open, we have introduced variations in depth that add new interest (Fig. 327). Now let's cut the shelf section down from two compartments in height to only one and we'll raise that one compartment about 3 inches above the main cabinet on a pair of runners. In both front elevation and perspective, this arrangement gains a good deal in terms of interest over our first try (Fig. 328). Next, let's add, alongside our original cabinet, a cabinet matching it in size to be used as a speaker enclosure. This is a very common and not very inspired type of addition. On the other hand, it's certainly not *unpleasant* and has the undeniable virtue of being highly functional (Fig. 329). At this point, we've added to our original cabinet both vertically and horizontally. Now let's try combining the two

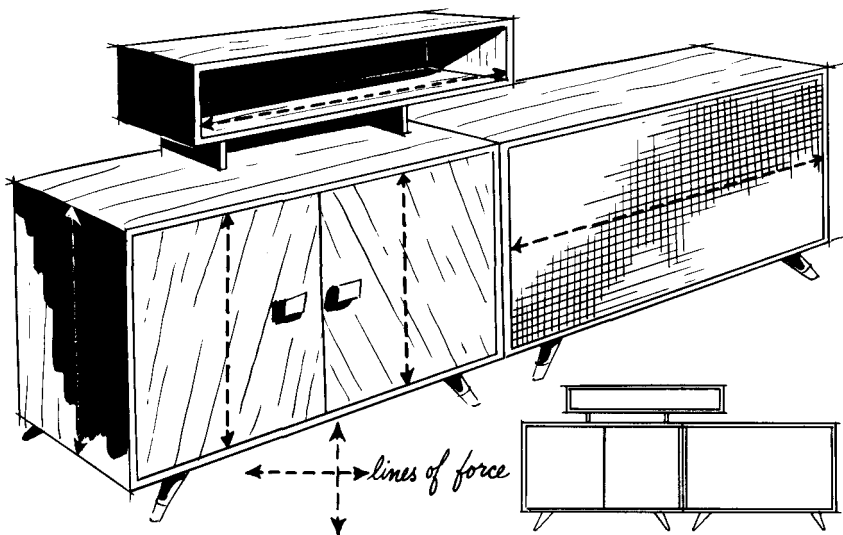

Fig. 330. *Placing a shelf on the original cabinet of Fig. 329 produces a much more interesting total grouping.*

movements. We'll add both the bookshelf and the speaker and we'll move the bookshelf off center on the original cabinet so that it's cantilevered out over the speaker cabinet (Fig. 330). Again we've added to the number of visual movements and directions and to the visual interest of the whole. Remember that the illustrations we've examined are not intended as original or brilliant design contributions. Quite to the contrary, they are the simplest possible examples of certain principles. They are intended to resemble things you've seen before, so that you'll be able to visualize readily. Studying them is an exercise in looking at familiar objects from a slightly more analytical viewpoint.

Variations can be made to a three-dimensional shape by either external additions, which we've just discussed, or by internal subdivision or combinations of both. To keep it simple, we'll stay with our $2 \times 3 \times \frac{1}{2}$ case, and this time try adding a third dimension to a couple of variations we have found we could make on its front. Let's try the one that had a drop front across the top over the equipment and a horizontal record-storage section below. This time we'll take the doors off the record-storage section so that the lower section will now recede in depth. Fig. 331 shows it in perspective both with and without the doors. Another variation of this same arrangement would be to put the

lower doors back on but inset them by about 2 inches. Still another would be to leave the lower doors flush and inset the drop front at the top by about $\frac{1}{2}$ inch (Fig. 332).

There is, as we have found out, quite a wide range of measures that can be taken to enliven what is basically an extremely simple

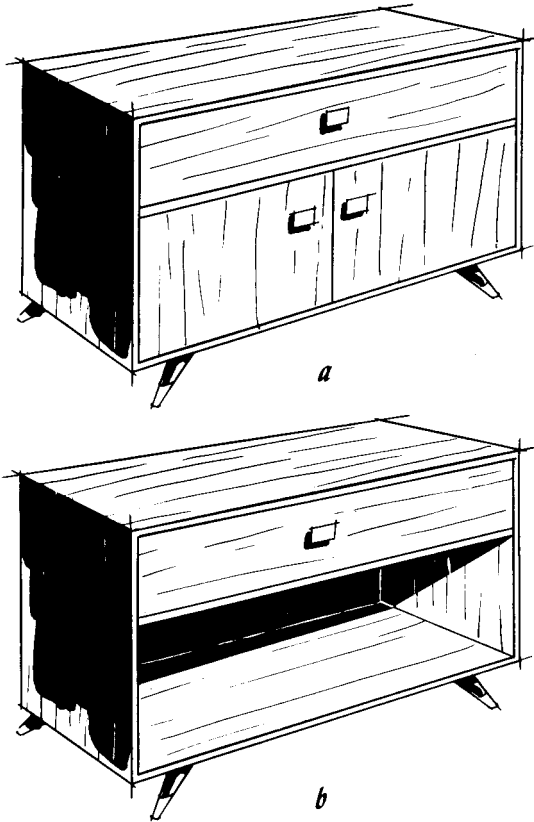

Fig. 331. *The use of depth as a dimension: (a) simple drop front cabinet with storage space; (b) removing the lower doors makes the bottom section recede, changing the character of the piece.*

design but before we move on to other things, let's look at one example of a combination of external addition and internal subdivision. We'll take one of the examples of subdivision that we have already used and add to it the matching speaker enclosure plus the floating storage shelf on top (Fig. 333). There are many more possibilities inherent in mere static lines, static planes and static solids than might have seemed possible at first.

Dynamic planes

Happily, however, these elements are not, by any means, all we have available. We can imply dynamic lines by the way in which static shapes are used. There are also occasions when dynamic lines and dynamic planes can be used directly. One of

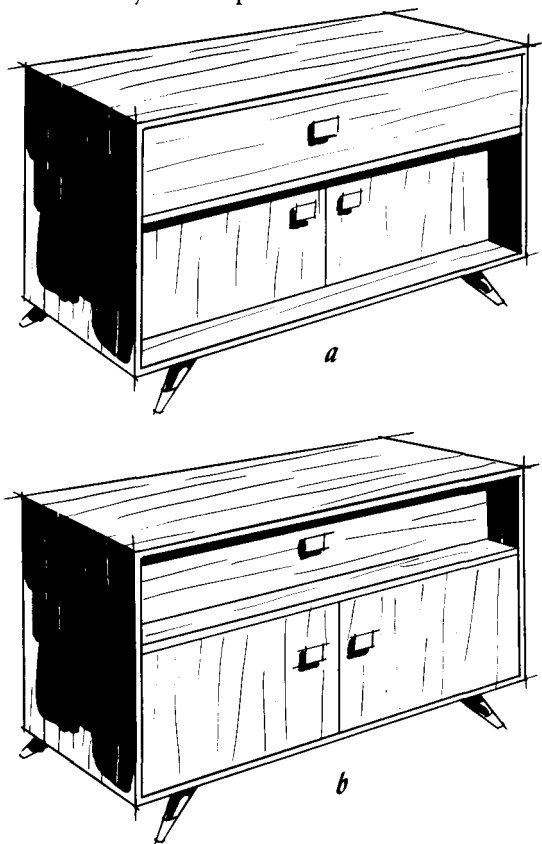

Fig. 332. Depth can be used with greater subtlety than shown in Fig. 331: (a) the lower doors of the unit are inset; (b) inseting the drop front seems to reduce the mass of the unit.

the first applications is leg treatment. Think about it a moment and you'll discover that practically all of the furniture leg shapes you see around involve the use of dynamic lines in one form or another.

By trying several different legs under our standard cabinet we can see how this works out. First, the straight, round, tapered leg. Although the central axis of the leg is vertical, the actual

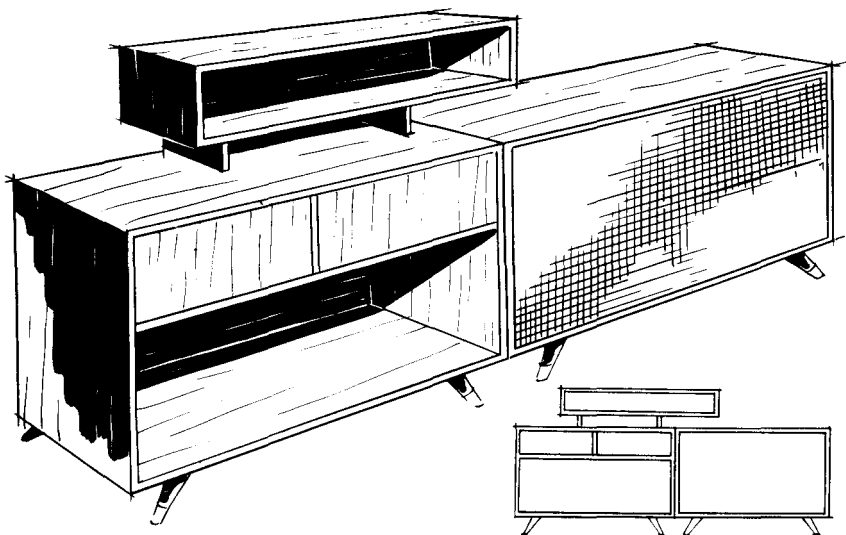

Fig. 333 (above). By combining a number of features a stimulating effect can be produced.

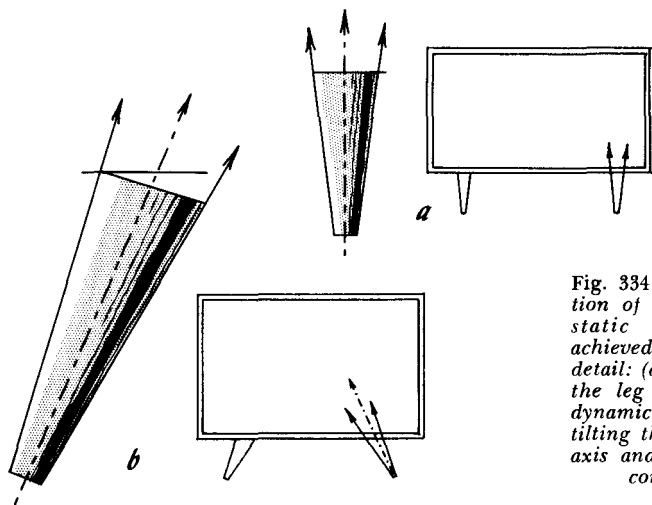

Fig. 334 (left). The creation of dynamic lines by static shapes can be achieved through simple detail: (a) the tapering of the leg makes it into a dynamic element; (b) by tilting the leg the central axis and the outline become dynamic.

outlines, since the leg is tapered, are angled and therefore dynamic (Fig. 334-a). Next take the same leg and angle it. This time both the central axis and the outlines are dynamic (Fig. 334-b). For another try, let's make a base using a square tapered leg at the corners. If we keep both the axis of the leg and its outside outline vertical, we'll still end up with a dynamic line on the inside to form the taper (Fig. 335-a). We can, of course,

take the same base and cant the whole leg so that we have both a dynamic axis and a dynamic outline (Fig. 335-b).

To introduce a dynamic plane, the baffleboard, for example, of a speaker enclosure can be tilted in at the top, thus making the entire front surface a dynamic plane (Fig. 336). As a matter of fact, in some cases, the acoustical people recommend doing

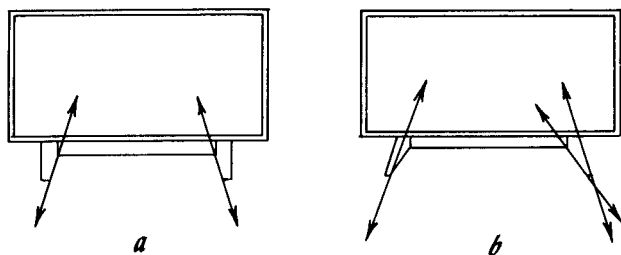

Fig. 335. Keeping the axis of the leg and its outside outline vertical does not necessarily make it static: (a) the inner taper produces dynamic lines; (b) canting the whole leg relative to the base produces much more vitality.

this with speaker enclosures to improve the balance of sound distribution throughout the room.

If you want to cant a baffleboard or a control panel for reasons either of function or appearance, go ahead; you can come up

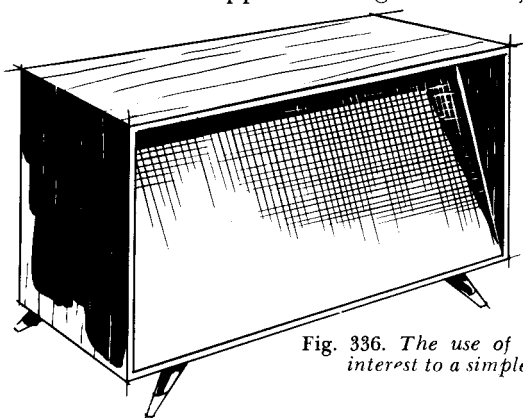

Fig. 336. The use of a dynamic plane adds interest to a simple rectangular form.

with perfectly good results this way. But don't try canting in the sides of the whole cabinet. The results are likely to be weird and difficult to live with (Fig. 337).

Use of curves

Another very important area of design is the subject of curved lines and curvilinear shapes. We have discussed straight-line and flat plane shapes first because these are properties inherent in

our main raw material, wood, as it comes ready for fabrication into cabinets. Plans that do not take into account the inherent properties of the materials to be used are more than likely to come to grief. Wood can be carved, edge-cut, edge-shaped, or turned to curved lines with reasonable facility but to bend a curve into the length or width of a plank or panel is well nigh impossible. Keep these factors in mind while looking at the

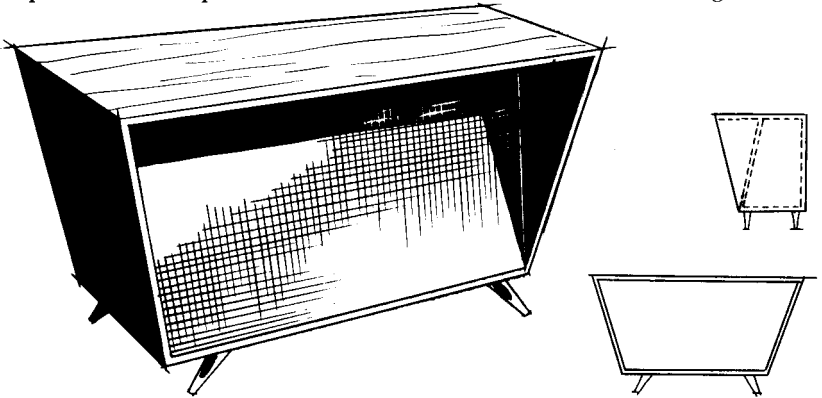

Fig. 337. *Dynamic planes are dangerous to handle and sometimes the results are disappointing.*

design effects of curved lines and curved shapes to relate such elements usefully to our specific subject.

One of the most common complaints heard from those who prefer traditional furniture styles is that the moderns, having

no dominant direction

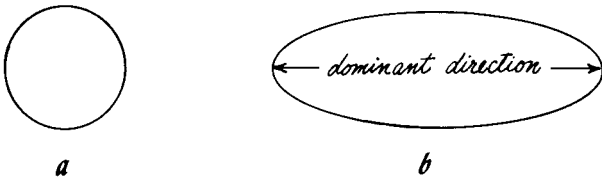

Fig. 338. *The circle and the ellipse are the ancestors of curved lines; (a) the circle is as static a plane as you can get—it has no dominant direction; (b) the ellipse does a little better in that some line of force is implied.*

removed the curvilinear carvings, moldings and turnings of the earlier styles, have ended up with a style that is too rectangular, too straight, too boxy and, therefore, lacking in the warmth and grace of the more traditional designs. There is unquestionably some merit to this argument; how much depends on individual taste. The inclusion of curvilinear lines and shapes in the design

of cabinets can add a gracefulness and flow that will endow them with a character and distinction absent from designs comprised entirely of straight lines and angular masses. Let's examine some curved lines and curvilinear shapes as such and then we'll see how they apply to cabinet design.

There is no such thing as a static curved line in the same sense

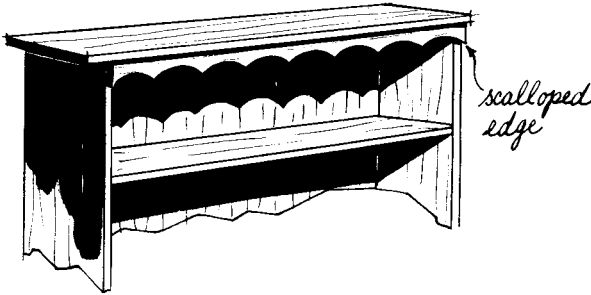

Fig. 339. *The scalloped edge is a regular waveform and consequently is fairly static.*

that we have a static straight line. The nature of a curve makes this impossible. It is never at rest but is constantly changing in direction and therefore *cannot* become static. There is a feeling of constant movement about a curved line, and this restlessness

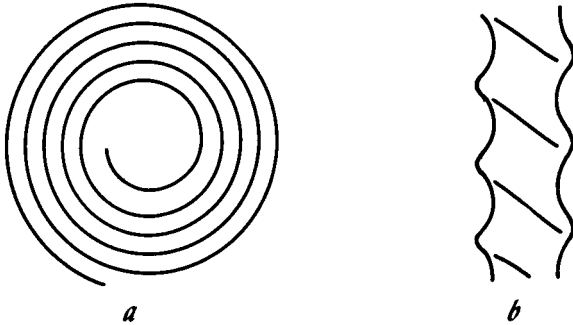

Fig. 340. *The spiral form is more dynamic than the regular waveform: (a) spiral in a plane; (b) the solid spiral. Fluting of this kind was often used on furniture legs.*

constitutes its vitality. Certain curves are more nearly static than others. The circle is the most static possible (Fig. 338). Although it is continually changing in direction, its rate of change is absolutely constant. The circle, like the square, having no predominant dimension, has no predominant line of force. This makes it not quite as interesting as it might be. On the other hand, it is for the same reason immensely flexible, often taking on what-

ever axis may be desired from its relationship to other elements. Similar to the circle in many respects is the ellipse or oval. It has much of the same character as the circle except that it does have a main axis and, in consequence, a main direction. Another of the more static types of curves would be any of the variations of the regular waveform pattern (Fig. 301). Although constantly in movement and constantly changing direction, it is also endlessly repeating itself. A variant of this would be the type of

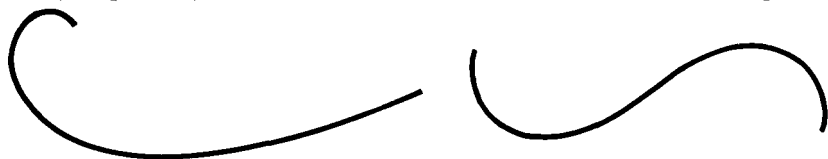

Fig. 341 (left). The curve of force illustrated is remarkably similar to the cross section of an airplane wing. Fig. 342 (right). The reverse curve starts to go in one direction and then changes its mind. It is widely used in period furniture.

repeated arc of a circle that forms the scalloped edges on many early American cabinet and table aprons (Fig. 339). Somewhat more fluid but still partaking strongly of a feeling of regularity is the spiral (Fig. 340-a). It has been used in the form of either a linear surface decoration or fluting as on the legs of some Spanish-Moorish furniture (Fig. 340-b).

The curves we've studied thus far, along with their variations and combinations, fall into two classifications. The first is the

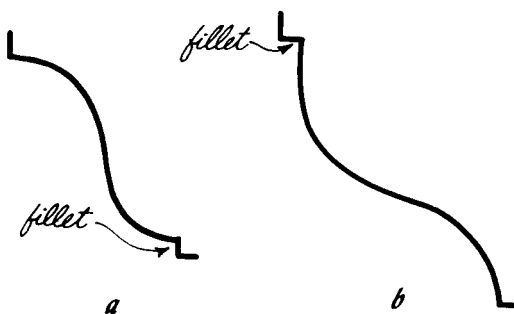

Fig. 343. Reverse curves are often used in moldings: (a) the cyma recta; (b) the cyma reversa.

geometric curve. The circle, the ellipse and any variations based upon them fall into this category. Certain other geometric curves such as the parabola, the hyperbola, the catenary and exponential curves have not been discussed because they do not occur in furniture. While the catenary and exponential curves appear in engineering computations on which the inside partitioning of

certain speaker enclosures is based, we are not going that deeply into acoustical design and these curves do not concern us. The waveform, the spiral and their variants form our second category, that of repetitive curves.

Categories of curves

Three additional types of curves can be applied to furniture. The first of these is the one-direction curve or, as it is sometimes called, the curve of force (Fig. 341). The one-direction curve starts with a slow, gentle sweep and ends with a quick curl. It is the simplest of the free hand curves. Sometimes it bears a close resemblance to a spiral and at other times is quite distinct. In period styles, it is sometimes encountered in decorative carvings and in the outlines of cornices on tall cabinets or in the outline of a scroll-cut apron at the bottom of a cabinet.

The reverse curve is far more common, recurring constantly in many period styles. It starts off curving in one direction and part

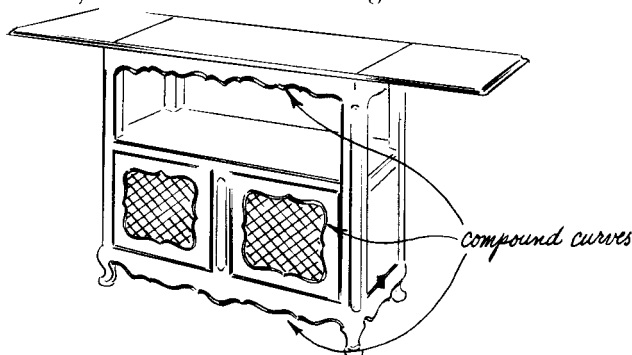

Fig. 344. *Compound curves are used extensively in French Provincial furniture.*

way along reverses itself and swings off the other way (Fig. 342). It sometimes terminates in a tight curl at one end, sometimes at both ends or sometimes at neither. It is found on the legs of Chippendale, Hepplewhite, French Court, and French Provincial styles and in many styles as an outline curve for aprons, cornices and door panels. It is also used as the basis for moldings such as the *cyma recta* and the *cyma reversa* (Fig. 343).

Compound curves are actually combinations of curves. The complete outline, for example, of a French provincial apron might be a compound curve composed of a number of reverse curves tied end to end (Fig. 344). Compound curves also turn up continually in the cross-sections of many types of moldings (Fig. 345).

The free-form curves of modern design are not particularly

new. They are combinations of one-direction and reverse curves but are far less regular and often tend to be totally asymmetrical. The popular kidney-shaped or amoeboid-shaped cocktail tables are unhappy examples of the free-form curve carried to its most uninspired conclusion.

Proportion and balance

Before proceeding further, let's summarize briefly. With reference to furniture, design starts with line. Lines combine to form planes and planes combine to form masses. All of these elements have readily discernible visual forces and directions. The manner in which these directions and forces relate to each other to form visually satisfactory unity in a piece of furniture falls under the headings of *proportion* and *balance*. These are difficult subjects to discuss in a general way because any individual's sense of proportion and balance is likely to be largely influenced by his own conditioning and what he has been accustomed to seeing.

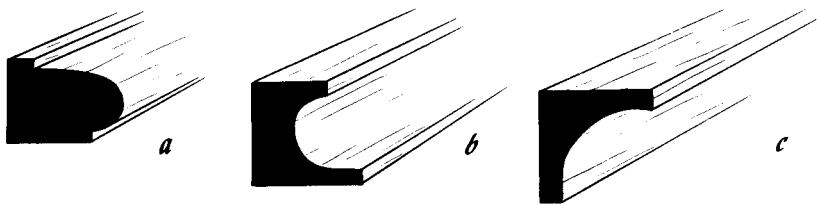

Fig. 345. Compound curves form the basis for many types of molding: (a) thumb-nail; (b) scotia; (c) cove.

There are many in the fields of art and design who would start a lively argument on this point, claiming that there are definite canons of proportion and balance they can prove. Looking back historically, one can find that a number of such canons have been proclaimed at different times. From the numerology of the pyramids to the dynamic symmetry of the Greek vase and on up to the present day, individuals and schools of thought have tried to establish the Divine Proportion. The fact that the various rather dogmatically proclaimed canons do not too often agree with each other tends merely to strengthen a conviction that visually satisfying balance and proportion are largely influenced by individual and cultural considerations and are not the result of some eternal and divine law or mathematics that can be discovered and promulgated once and for all. No one would claim for a moment that the architects of the Parthenon and the Cathedral of Notre Dame followed the same divine proportioning. Yet each is an object of

beauty in its own right despite the easily established fact that each is based upon a totally different concept.

The same kinds of comparisons can be made in furniture. The neo-classic simplicity of the Directoire style (Fig. 346) has a beauty

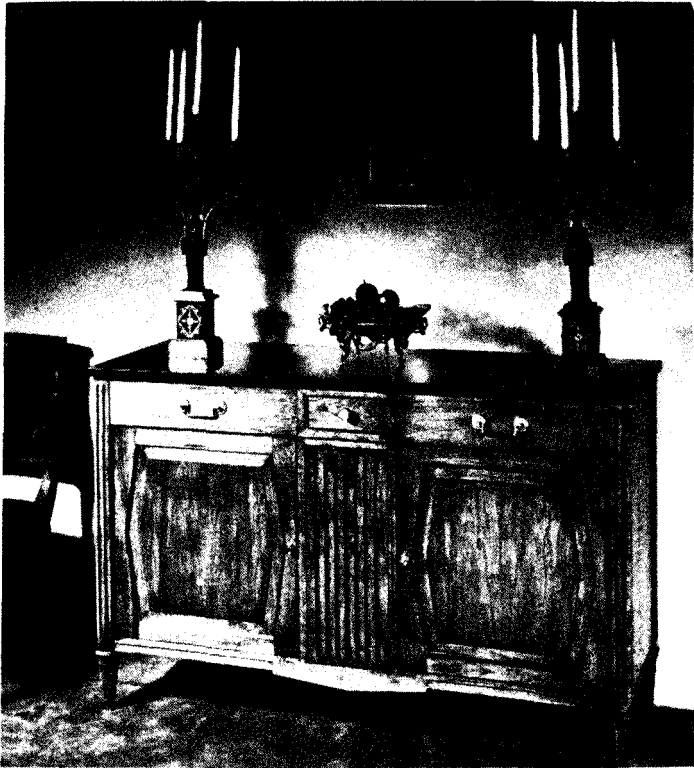
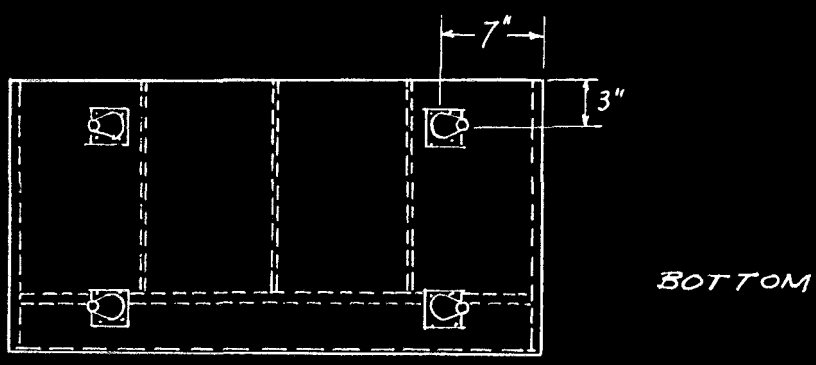
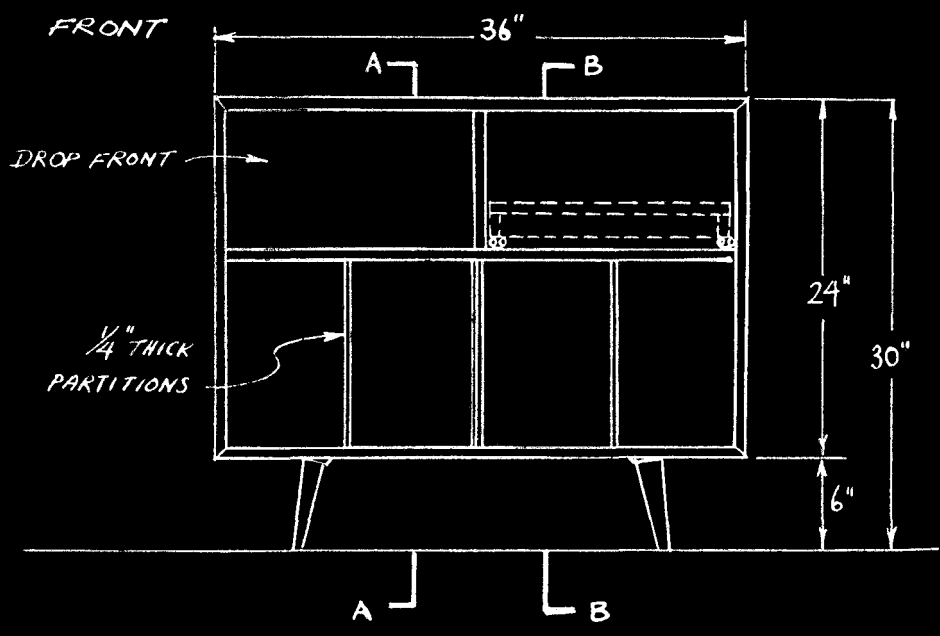
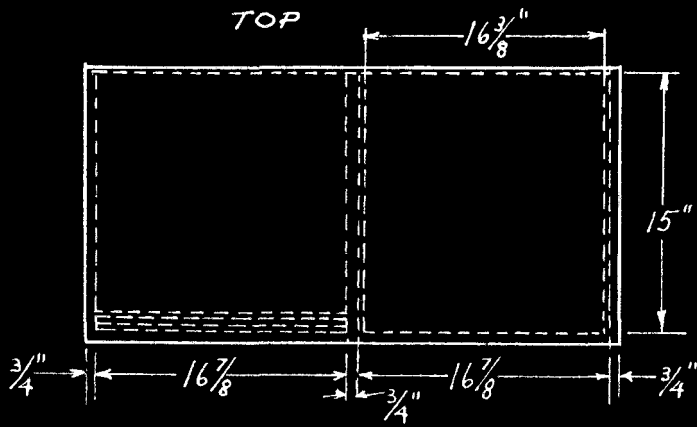

Fig. 346. *The Directoire is an example of the almost spartan Neo-classic simplicity.*

of its own but one that is quite at variance with that found in the Baroque-influenced furnishings of the French Provincial style. (See Fig. 344.)

Although in good conscience we cannot set down rules to determine balance or proportion, a few pointers can be used as guides. Proportion and balance are so closely related to one another that it is difficult to tell where one leaves off and the other begins. The simplest way to obtain balance in a design is by means of symmetry. This is a 25-cent word meaning that, if you draw a line down through the middle of the piece, the right-hand side would



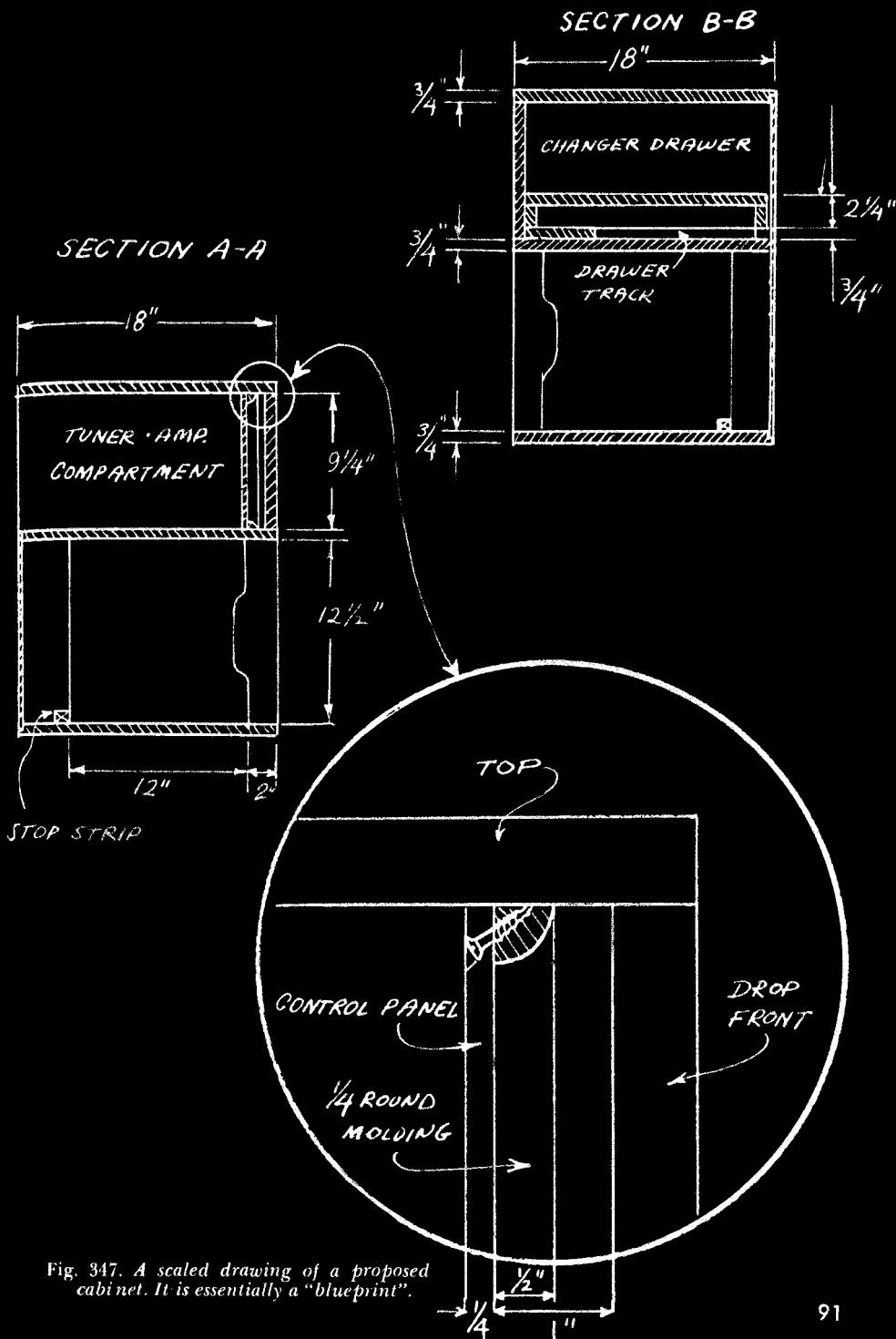

Fig. 347. A scaled drawing of a proposed cabinet. It is essentially a "blueprint".

be a mirror image of the left-hand side. This type of balance is used in practically all traditional styles.

In a sense, this would be the same as if you put two equal weights on a seesaw, equally distant from the center pivot point. They'll balance each other exactly. But you'll undoubtedly also recall that, if you decrease one of the weights and move it further out or increase one and move it further in, the two weights will still balance. This is the basis of the asymmetrical design often seen in modern furniture.

Actually there are only two ways to get balance in a design, either symmetrically or asymmetrically. If you have symmetry, by definition you have balance. It's that simple. You may or may not have good proportions, but you will inevitably have balance. Asymmetrical balance is another thing, and not as simple. There's a great deal more latitude here for personal interpretation. Here, too, is where proportion and balance become inextricably snarled. As long as you're using symmetrical balance, you can have a poor relationship of height to width without destroying the balance. You could also have other unattractive proportions without destroying balance. For example, the cabinet might be top heavy because the legs are too light or too high. Or, it might seem bottom heavy because the legs are too big. For this reason, symmetrical design is easier to work with because you can isolate the two problems of balance and proportion.

But leave symmetry behind and you're in the wide open spaces. Both questions must be dealt with at once. Here's where you've got to rely on your feelings for the forces and directions of the planes and masses involved, to achieve satisfying proportion and balance in asymmetrical designs.

The scaled drawing

When you get ready to start finalizing your ideas about hi-fi cabinets, the only way you can reasonably check the proportion and balance of what you have in mind is to make a scaled drawing. The basic procedure for scaling a cabinet is no different from that used to scale a floor plan except that the scale units will have a different meaning. Whereas $\frac{1}{4}$ inch equals 1 foot is a common scale for floor plans, in scaling a cabinet $\frac{1}{4}$ inch generally equals 1 inch, except for very large units where such a scale might result in an inconveniently large drawing (Fig. 347).

Graph paper can be used for scaling. It is quite convenient—no ruler is necessary—just count off squares. But the squares may tend to confuse your overall view of what has been drawn. Unless you

are used to visualizing three dimensions from two, the linear pattern of the paper may be distracting. To avoid this disadvantage, use tracing paper with graph paper underneath to get your scaling, and then take the graph paper away to see what you've got.

But however you do it, and no matter what scale you use or how you arrive at it, make a scaled sketch of your ideas before proceeding with the construction of any cabinetry. Adjustments of as little as an inch or two can make vast differences in balance and proportion. A change of an inch in the height of a drop front or even as little as $\frac{1}{2}$ inch in the thickness of a leg can bring an entire cabinet into or out of proportion.

Color

Before leaving the generalities of design to discuss specific styles, let us touch upon one other subject briefly. That is color. The range of the colors for a cabinet is actually quite limited. But within that range the color chosen can have quite a considerable influence on the success or failure of the effect of the total unit.

The colors you are likely to use will range from off-white blonds to yellow, tan blonds to ambers and from there to various greens, red-browns and grays down to dead black. The most important factor influencing the choice of color for cabinets should be the other colors in the room. If you have light-colored woods, fabrics and walls, the chances are you won't want a big black hunk of hi-fi cabinet. Conversely, if the wood pieces already in the room are largely medium to dark, you won't want a massive blond unit.

If you are using a period style, the color of the unit should conform, in general at least, with the colors historically used for that style. For example, a bleached, mahogany Heppelwhite sideboard or an ebony black French Provincial one would be an anachronism. The colors just don't agree with the styles. A very dark brown Chippendale piece or a very light gray French Provincial one would be appropriate. These colors were used.

There are tricks in the use of color. Against a light wall, a cabinet will look smaller if it is also light in color and larger if it is dark. Against a dark wall, the reverse is true. (The piece will look smaller if dark and larger if light.) In general, a piece will look a little larger if light in color than it would seem if it were dark. Dark colors tend to show dust more readily—light colors reveal imperfections. Dark colors can obscure the effect of decorative detail, carvings and moldings. Medium-value colors will enhance them.



JEFF
59

CHAPTER 4

furniture styles

TO determine the most appropriate style for your home, it is necessary that you have at least a nodding acquaintance with the more important historical styles still in use. But first let us have a mutual understanding of what is meant by *style*.

Man has had furniture, chairs, tables, cabinets, chests, and so on, among his utilitarian artifacts for almost as long as he has had history.

The chair, for instance, has consisted for an incredibly long time of three basic elements: a platform on which to sit, an arrangement to hold the platform between 15 and 17 inches off the floor, and a back. The variations that have been made on these three elements are endless. Chairs have been huge and very tiny; high-backed and low-backed; with or without arms, with wide seats or narrow, deep or shallow seats. They have been profusely decorated or completely undecorated. And all manner of materials from the animal, vegetable and mineral kingdoms, ranging through shells, bones, leather, stone, metal, wood, cloth, plastics and even cardboard, have been used in their construction.

It might seem odd, in view of the number of great minds that have appeared in the course of some 5,000 years of recorded history, that man hasn't achieved a reasonably ideal solution to the question of providing himself with a place to sit. He *has* solved the problem time and again, but only for a particular society, culture and technology.

Style

Man has changed very little physically during the entire period that we know anything about so the three basic elements of a chair haven't changed either. But the manner in which the function of a chair has been obtained has varied considerably with the needs and desires of different cultures, the materials available to them, and their technologies.

The chair in which Louis XIV of France sat had to be, not only a place to rest his weary bones; but an expression of his opinion of himself and his regal position. The desired effect had to be achieved in terms of the materials and skills of the artisans of the time, and furthermore, these were used by the designer in such a way that the resulting object was a universally understood symbol.

This is an example of the real meaning of style in the best and fullest sense of the word. Style is an integrated expression of the culture, technology and philosophy of the time.

Unfortunately, this perfectly good word has become bastardized in recent years. Style has come to be used to refer to such things as a minor change in the tail fins of this year's car, or a change in the color name of a lipstick. Streamlining everything, from an automobile, where it may do some aerodynamic good, to an electrified egg beater, does not quite constitute style. Style refers to something with deeper roots.

In the field of furniture, looking back historically, we find a number of distinctive and distinguishable styles. Some of them are still in widespread use today while others have all but disappeared. A society can agree with and retain the values of its past or it can disagree with them, but it cannot wipe them out entirely and start over as though they had never existed.

A philosophical, religious, political or technical revolution often carries within itself the necessary definitions for a new style in the arts. At such times it is not unusual to see a new style of furniture emerge quite suddenly.

Something of the sort has been going on in our own time. It is our fatuousness as it has been the fatuousness of people at all times that our styles and tastes are "Modern". It is a safe bet that the American of 1860 considered himself "Modern" and thought of the American of 1760 as pretty old fashioned. By now a good many consider both rather quaint.

Students of economics, technology, history, politics and art all offer different explanations for the development of the thinking that has resulted in our modern style of design.

The chances are, too, that each of them would have a piece of the truth, but to discover how big a piece and how it relates to the others will require the perspective of a good deal more time.

In part this is because our "Modern" style is not yet fully developed and defined. A society that is well integrated and settled in its cultural, philosophic, and ethical values will produce a coherent iconography and concurrently integrated and well defined

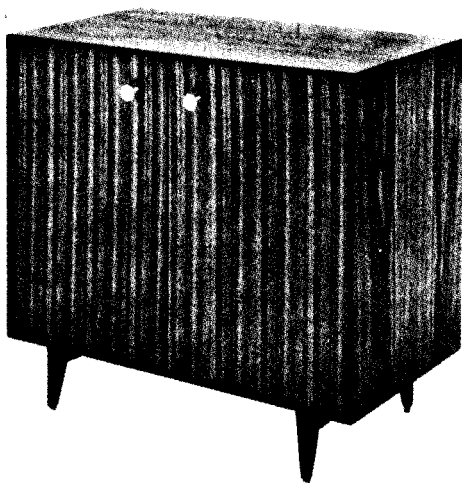

Fig. 401. *A recent Modern unit. Wood grain and texture provide visual interest rather than decorative detail.* (Courtesy Herman Miller Furniture Co.)

styles of art and design. In a changing society individuals seek in several ways for values around which to base their lives, and in exactly the same way artists and designers search for values.

One method is for the designer to look to the past for a time and style with which he can identify, and to reproduce it in the present. Another approach is to find in the past, elements of more than one style, and then recombine them. The result is an eclectic design that for lack of a better term is called Traditional.

What is called Contemporary is yet another kind of eclectic design, but it is arrived at in a different way. You can either take something that is basically modern and soften it with period elements, or you start with a period piece and modernize it by stripping off most of the period elements. In either event the

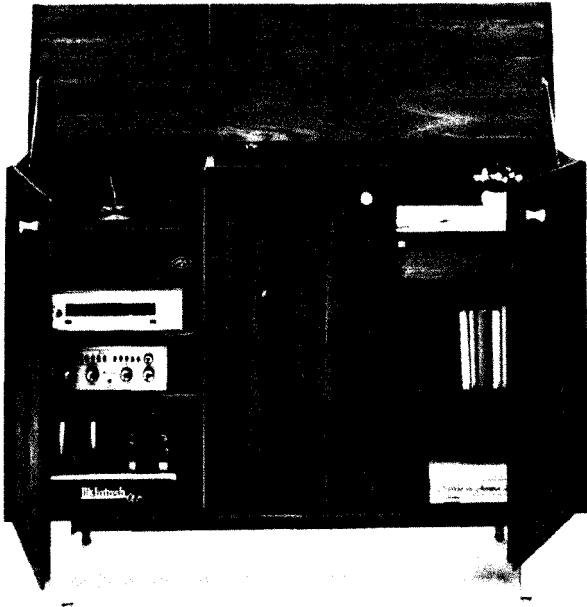

Fig. 402. *The exterior of a Modern cabinet often conceals a complex internal division of space. (Courtesy Herman Miller Furniture Co.)*

results are similar. You have a thing that feels largely modern but yet smacks definitely of the past.

The difference between traditional and Contemporary design is one of emphasis rather than approach. Both seek areas of inspiration in the past for adaptation to the present. The difference lies in the manner of adaptation.

America lacks a long and continuous cultural tradition in the sense that, say, England and France have one, and we have long tended to look to Europe for our esthetic standards. This has undoubtedly something to do with the popularity here of Traditional and Contemporary styles based upon English and French motifs.

Another approach to the problem of styling is that of the Modernist. He starts with an analysis of the present and tries to anticipate the future. He is the experimenter, the innovator, the developer of a new style. He is the one who will pioneer the use of a new material, a new use for an old one, or a different construction technique.

His experiments and innovations result in new lines and forms that quite often jar the senses of his contemporaries. But if his

analysis of his society and its technology were sound to begin with, there will be inevitable logic to his work that will make it gradually understandable and acceptable.

Modern Style

Now let's sift through some examples of Modern, Contemporary and Traditional styling and try to reach a point where we can begin to tell which from t'other.

The single most obvious characteristic of Modern styling is the reduction and simplification of decorative detail. This factor alone does not constitute a full formulation of style, but it is a characteristic that serves as a ready means of identification. For example, furniture of no prior periods exhibits as little decorative detail as the Modern unit illustrated in Fig. 401.

Although all Modern designs are not as chaste and stripped of decorative detail as this one, it is a good example of one of the main influences in the style.

Fig. 402 is a larger, more complex unit by the same designer. While there is considerable interior subdivision of space, the exterior gives little hint of it. In both this and the preceding example the natural wood grain and overall proportioning are relied upon to provide visual interest. The simple door pulls on both units

Fig. 403. *An example of the long low look which characterizes many Modern pieces.*
(Courtesy Gordon Brothers)

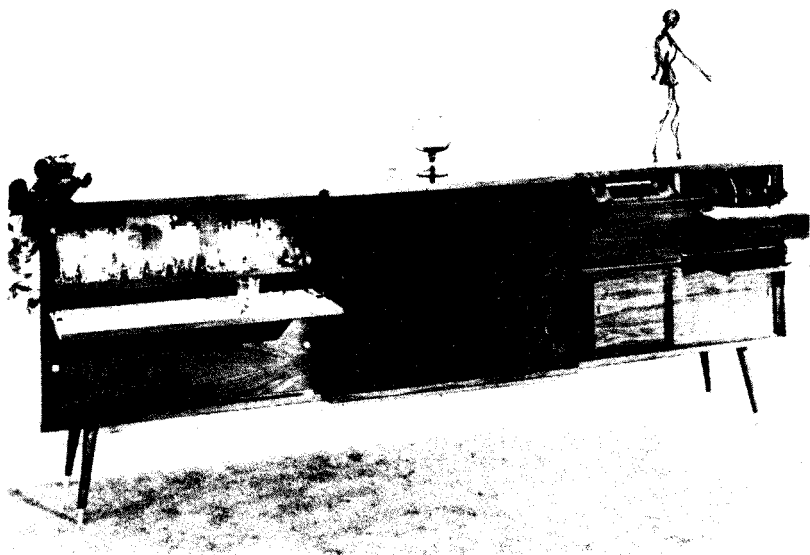

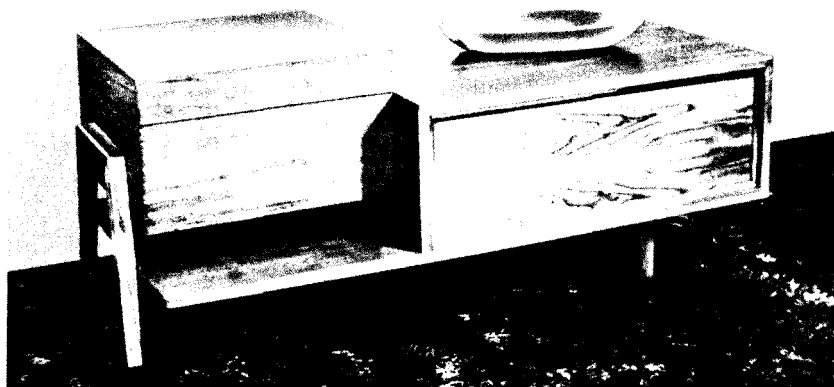

Fig. 404. *The use of the step-up setback record-player compartment adds interest to this piece. (Design by the author.)*

can hardly be called decorative and the leg treatments are simple and unobtrusive.

Another characteristic of Modern styling that, while by no means universal, is certainly widespread, is the emphasis on the horizontal line, the so-called "long low look." (Fig. 403).

This look has been encouraged by the current trend toward

Fig. 405. *Although this cabinet is raised, a basically horizontal feeling is retained. The base and the use of various materials produce a high interesting effect. (Courtesy Herman Miller Furniture Co.)*

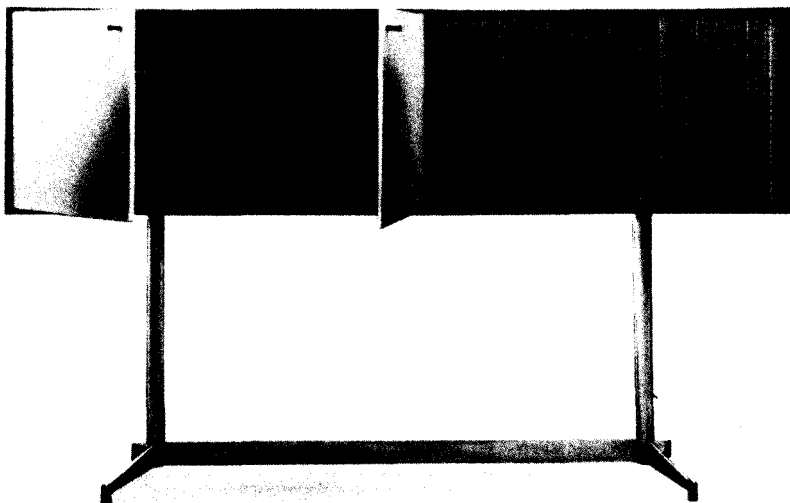

low ceilings in modern dwelling spaces. Standard ceiling heights nowadays range around 8 to 8½ feet, and in such surroundings the 6- and 7-foot high breakfronts, cupboards and highboys of former days look out of proportion. They were intended for rooms with 9–12-foot ceilings.

The same horizontal line emphasis is shown in Fig. 404. Here visual interest has been added by the stepup and setback of the record-player compartment at the left and the outside leg at the

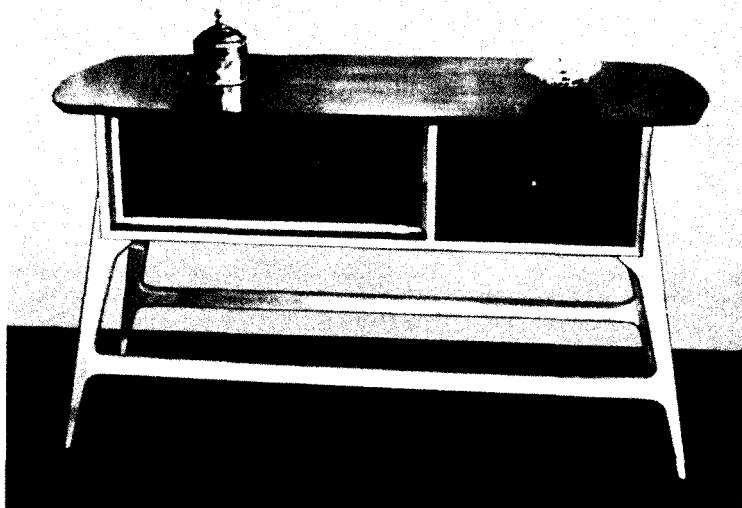

Fig. 406. *The use of contrasting woods and a curved top gives this Modern piece a look of lightness and warmth.* (Design by the author.)

same end. Again decorative detailing is conspicuously absent. The molding around the control panel could hardly be called decorative and the end leg, while emphasized, shows itself clearly as a structural element. The design relies entirely upon shape, proportion and wood grain for effect.

A design need not necessarily be extremely low to retain the feeling of horizontality, as evidenced by Figs. 405 and 406. In both instances a unit with a basically horizontal feeling has been raised well off the floor.

Again note the sparseness of decorative detail, but a new element has been included. In both cases additions to visual interest were attempted by variations in material or surface texture or both. In Fig. 405 the walnut case is varied by using white plastic and cloth on the front, and by the unusual base. The unit in

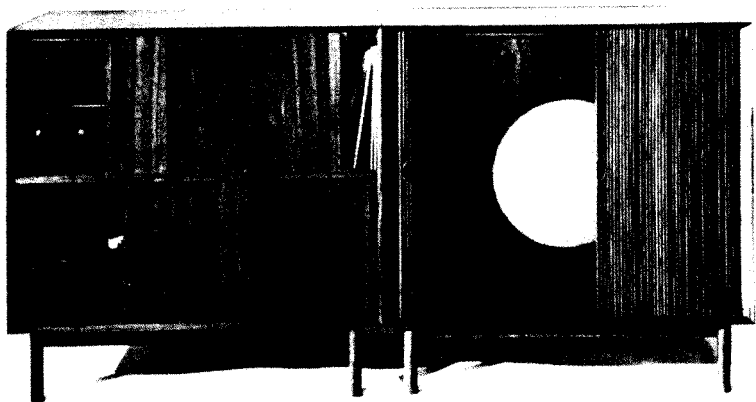

Fig. 407. Variation in surface texture is achieved in this piece by the use of lambours on the speaker front in contrast to the smooth leak sliding doors. (Courtesy John Stuart, Inc.)

Fig. 408. The rectangular form of this cabinet is softened by the use of the curved corners and by some curved lines in the leg treatment. (Design by the author.)

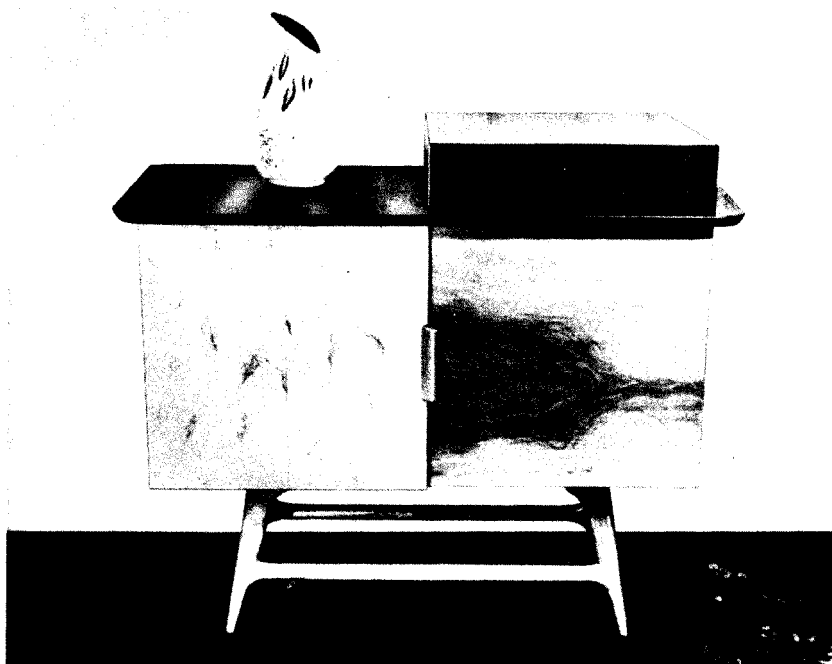

Fig. 406 gains variety by mixing different woods, walnut top and fronts with birch case and legs.

The design in Fig. 407 introduces variation in surface texture too. Both cabinets are teak throughout, but this material is utilized in two contrasting ways on the cabinet fronts. The speaker front has a ridged texture produced by the tambours contrasting with the flat, smooth texture of the sliding doors over the equipment section.

In the examples given thus far of Modern style cabinets, with one lone exception the outlines consist of unbroken rectangles. The unit shown in Fig. 406 has a curved top that overlaps the sides, thus breaking up the strict rectangulation of outline, but the other cabinets illustrated aim at visual interest through means other than variation of outline. This uninterrupted rectangular outline is a characteristic that, like the long low look, is by no means universal, but at the same time it is certainly extremely widespread among examples of Modern cabinet styling.

Of the objections voiced against Modern styling, a good percentage could be traced back to just this characteristic. It seems to give some people the feeling that Modern is "cold" or "harsh" or "severe," that it lacks the "warmth" of Traditional or period stylings. While this feeling may often be traceable in part to a lack of familiarity with *good* Modern styling, rectangles and more rectangles can be tiresome.

The cabinet shown in Fig. 408 is another attempt to break and soften rectangular lines with an overlapping top with curved corners and some curved lines in the leg treatment.

Another characteristic of Modern that is common but not universal is asymmetrical design. Fig. 409 is a strong example of this as are Figs. 404 and 408. Milder examples are Figs. 402, 405 and 410. The unit shown in Fig. 410 consists of two completely separate cabinets mounted on a single base $\frac{3}{4}$ inch apart. The speaker enclosure is shock-mounted to the base, isolating it from the equipment cabinet on the right.

To sum up Modern cabinet styling, we find very simplified decorative detailing, strong emphasis on natural wood colors and grains, use of contrasts in materials and surface textures, frequent use of strongly horizontal shapes and the common use of asymmetry. Modern cabinetry is often raised off the floor on legs to imply a feeling of lightness and airiness. Most finishes are of the matte or satin variety with considerable emphasis on natural wood colors. Staining and bleaching are largely avoided.

Contemporary

Contemporary styling draws a good deal from Modern and is

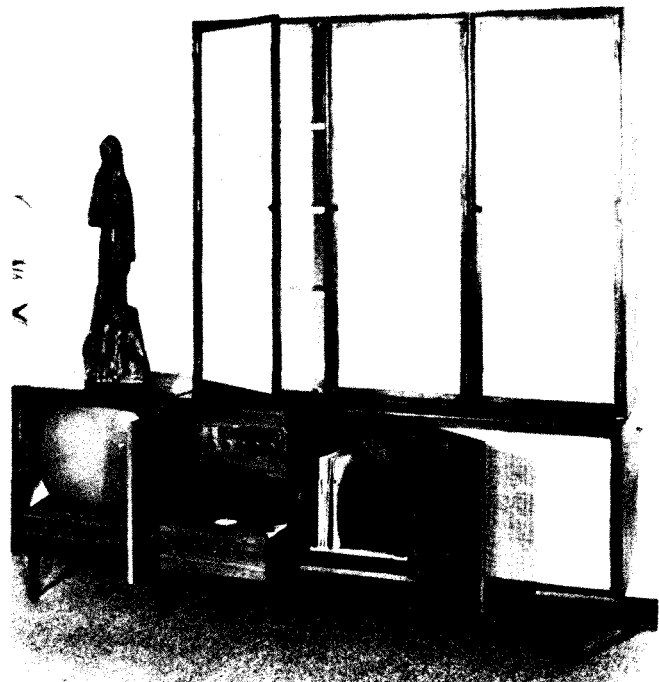
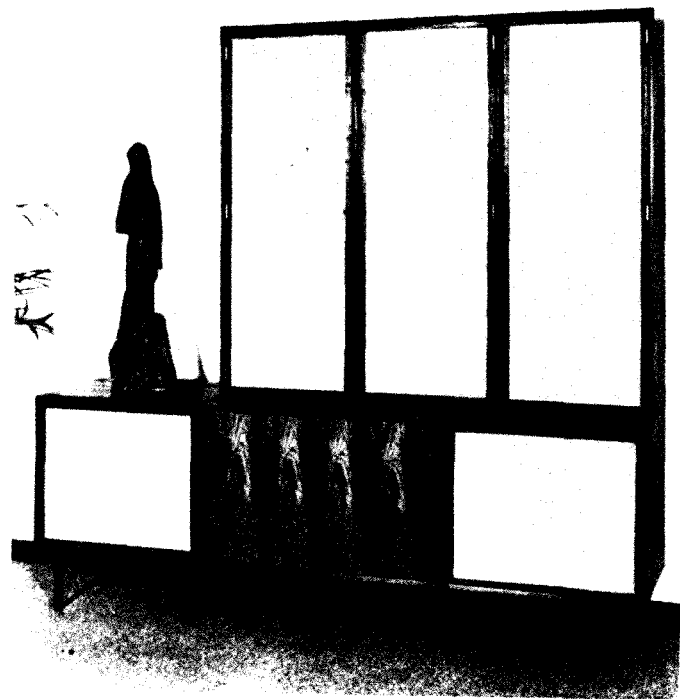

Fig. 409. *This Modern unit is a good example of asymmetric design.* (Courtesy Cassard & Walker, Inc.)

similar in many respects. In fact the dividing line between Modern and Contemporary is sometimes rather hazy. Contemporary cabinets carry more decorative detail than Modern units, the horizontal effect is generally not as pronounced, and asymmetry in design disappears. Contemporary units will run down close to the floor on 2-4-inch bases more often than Modern ones. Variation of colors by bleaching and staining is more common, and a high



Fig. 410. *Asymmetry is fairly subtle in this hi-fi unit. It consists of two separate cabinets mounted on a common base (Design by the author.)*

gloss finish is frequently used. But most important, Contemporary designs always include some reference to or suggestion of a period style. At times this reference may be very subtle; at others it will be obvious to an untrained eye.

Unfortunately some "Contemporary" design is just plain bad design. It too often tries to be "all things to all men" and succeeds only in producing a rather insipid effect.

An example of good Contemporary styling is shown in Fig. 411. It would appear to be based upon neo-Classic models from the early 19th century, and has retained a kind of grace and elegance.

The cabinet in Fig. 411 was not made specifically to house hi-fi equipment, but can be adapted for this purpose. The same is true of many of the illustrations following. Very little good Traditional or period furniture is being made for hi-fi.

The wall unit in Fig. 412 is an example of good Contemporary styling. It exhibits an admirable subtlety of proportion and re-



Fig. 411. *This example of Contemporary styling is based upon neo-Classic designs from the early 19th century. (Courtesy Charak.)*

straint in the use of decorative inlay. The period influence appears to be neo-Classic, probably late 18th- or early 19th century Italian.

In those whose tastes run toward more ornate styling Fig. 413 might strike a responsive chord. The design of this piece, though definitely Contemporary, is influenced by Oriental sources.

In contrast Fig. 414 is a good example of highly simplified Contemporary. This piece comes very close to the hazy borderline between Contemporary and Modern, but in the author's opinion belongs with Contemporary even though it reveals no specific period source.

Traditional and period styles

At times Traditional and specific period pieces are a bit difficult to separate too. A Traditional design will contain elements of more than one period; it will not be an authentic reproduction of any specific period. For example, it may contain elements such as the legs and curved front of Hepplewhite, fluting at the sides which looks like Sheraton, and have doors and hardware which

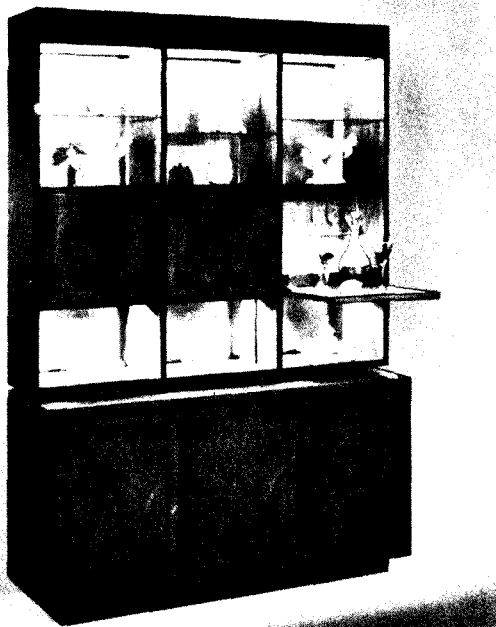

Fig. 412. *This wall unit exhibits late 18th-century Italian neo-Classic influence.* (Courtesy Grosfeld House.)

look like neither. It would be safe to say that a piece such as this is derived from late 18th century English styles, but you cannot be more specific than that—it is just Traditional.

Fig. 415, on the other hand, while simplified from the originals, would appear to be a direct descendant of Hepplewhite. So would you rather call it simplified Hepplewhite or throw it in the rather amorphous hopper labeled “Traditional”? The flat top cornice, the curve of the front and the inlay pattern of the doors are consistent. Hepplewhite would have used more surface decoration and considerably subdivided the glass doors, but this does not destroy the feeling that the piece has a specific style.

It is really a question of emphasis again—does a given piece

seem to be pretty much of a specific style? If so, that is what you call it. Or does it contain period elements but is not consistent with a particular style? Then it is just Traditional.

It will take a while before you will be able readily to distinguish Traditional from the various individual period styles. To do so you will need first to become familiar with some of the period styles and their identifying characteristics. However, it is well beyond the scope of the present work to attempt anything resembling a full-scale history of furniture styles. We shall limit



Fig. 413. *Oriental influences can be detected in this contemporary piece specifically designed for hi fi.* (Courtesy John Stuart, Inc.)

our discussion, therefore, to general trends from approximately 1700 to 1820. This will cover most of the styles in use today, and consequently most of the ones you are likely to encounter.

At the start of this period the hereditary royalty of Europe was at the height of its pomp and power. The furniture styles of the times were developed for and around the courts of the royalty and nobility. In France, Louis XIV reigned in complete autocracy at Versailles, surrounded by furnishings that fully expressed the authority of his throne. This was a period of pageantry and show, reflected in the heavy formality of the furniture and in its profuse ornamentation. This ornamentation was based largely on curvilinear floral motifs inspired in turn by Baroque Italian decoration.

Furniture of this type is seldom reproduced today, but one does occasionally encounter simplified reproductions of the somewhat lighter, more sophisticated styles of Louis XV and Louis XVI. Fig. 416 is an extremely simplified version of a



Fig. 414. *Although this piece exhibits no specific period source, it is nevertheless an example of Contemporary style.* (Courtesy John Widdicomb.)

design derived from Louis XVI models. By this time, the neo-Classic influence that was to prevail in France through the remainder of the period being discussed had already begun to make itself felt.

Although very little in the styles of Louis XIV, XV and XVI survives in reproduction at the present time, a great deal of reproduction is done in the French Provincial style that developed in the outlying districts during the early and mid-1700's.

Fig. 417 is an example based upon attempts of the bourgeoisie to imitate the court style, necessarily in simplified form. The compound curves of the cabinet tops, aprons and inset door

panels as well as the reverse-curved cabriole type legs are typical of the court style from which they were derived. If you will notice particularly the curves of the lower apron and the manner in which its curves blend into those of the legs at the corners, you will not be likely to confuse this style with any other.

Although reproductions in this style are most often finished



Fig. 415. *This piece, although simplified, would be considered as an example of Hepplewhite.* (Courtesy Grosfeld House.)

in medium amber brown colors, the surviving originals are quite as often painted cream, tan, gray or blue-gray with painted ornamentation that is usually omitted on reproductions.

With the abrupt demise of Louis XVI and the subsequent rise of the Directory to power as a result of the popular revulsion against the excesses of the monarchy, a new style of furniture also appeared. It contrasted sharply with that of the preceding periods. A style in keeping with the mood of the times developed that exhibits a classic simplicity, dignity and restraint in ornament and decoration that is quite at variance with frivolous, dainty and slightly effeminate court styles.

With the resurgence of French influence on the Continent this

style, known as Directoire, became widespread not only in France but also in Italy and Germany.

Fig. 418 shows an example of current reproductions in Directoire style based on both French and Italian models. These, like other present-day reproductions, are simplified but carry on the feeling of the original style. The emphasis on straight lines and geometric shapes, the elimination of decorative moldings

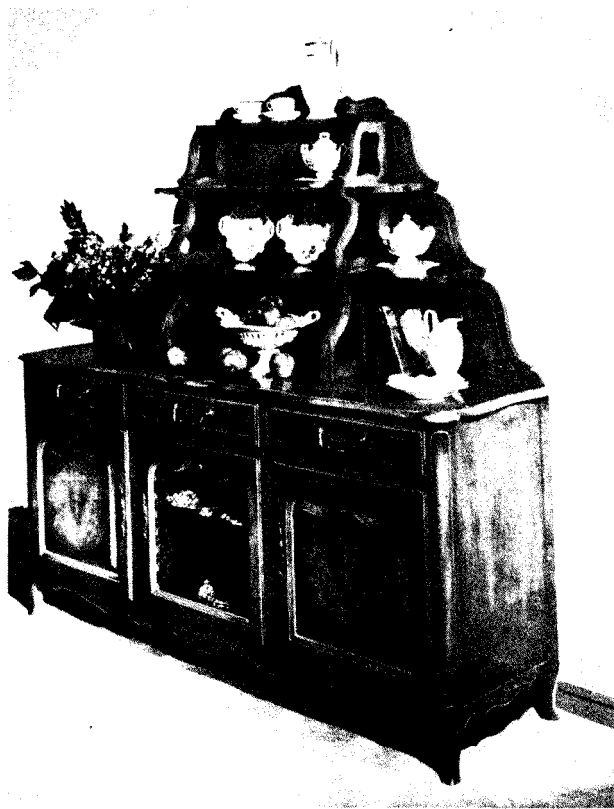

Fig. 416. This design in Provincial style is derived from the more ornate style of the contemporary French court. (Courtesy Grosfeld House.)

around the tops and the application of pilasters or fluting reminiscent of Greek columns alongside the doors are characteristic.

As the Directoire evolved into the Empire, the Directoire style also evolved into the somewhat more ornate and pretentious Empire style. But although Empire style is more ornate, it retains the

classical feeling of the Directoire in its basic lines and forms. Ornamentation is added in the form of inlays and ormolu rather



Fig. 417. *French Provincial style developed during the early 18th century. Note the use of compound curves.* (Courtesy Grosfeld House.)

than molding and carving (Fig. 419). This is a serious and somewhat self-conscious and humorless style that remains at odds with the frivolities of the earlier court styles even as Napoleon, who in large measure gave rise to it, was a serious, self-conscious and humorless man. (Another example of Empire style is shown in Fig. 420.)

English Styles

The English styles of the period under discussion at no time reach the excesses of the French court styles, nor do they at any time revert as sharply to classical simplicity. Although English furniture does not necessarily lack gracefulness and charm, the

British in general do lack the decorative flair and sophistication of the French. The British are a stolid and serious people and their furniture, like their other arts, reflects their outlook.

The greatest English styles were developed by individual designers and are named after them. The three most important



Fig. 418. The rectangular simplicity of the Directoire style lends itself to adaptation for hi-fi purposes. (Courtesy Charak.)

were Chippendale, Hepplewhite and Sheraton, with the brothers R. & J. Adam running them a close fourth. These, plus the neo-Classic Regency style that followed them, constitute the important English styles for our purposes.

At the present time considerable Traditional cabinetry is being made based upon English motifs, but very little in the way of authentic reproduction is available. This would seem to be a result either of changing tastes or of mere fashion of the moment. For many years reproductions in the English styles were in great demand here, but recently the demand has shifted to French

Provincial and the neo-Classic styles. French and Italian Directoire, Empire and Beidemeier, an early to mid-19th-century style developed in Central Europe, primarily Germany and Austria, and based upon the Empire style of France.

Furniture manufacturers are rather sensitive to such changes

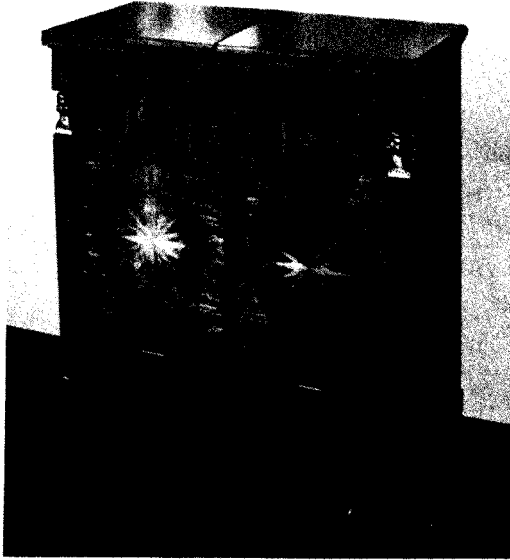

Fig. 419. *The Empire style maintains the classic feel of the Directoire in its basic lines.* (Courtesy Grosfeld House.)

in taste, making authentic English reproduction rather hard to find at the moment, but this situation is not likely to continue for long.

Chippendale was the first of our important English stylists. Actually, very little in the way of authentic Chippendale reproduction is being done today. Most of his style was rather heavy and a bit too richly carved for modern tastes. The cabriole leg with a carved ball and claw foot, richly carved aprons and imposing pediments on his high cabinets are identifying characteristics of Chippendale's style.

This heavy, ornate style is no longer being reproduced, but pieces such as Fig. 421, simplified but bearing a strong Chippendale influence, are being made.

Another style originated by Chippendale and having a strong

Oriental influence is also still alive today. Fig. 422 shows a reproduction of this Chinese Chippendale style.

Far more important than Chippendale, in terms of their continuing influence today, are the Hepplewhite and Sheraton styles. In terms of refinement of proportion, delicacy and restraint in decoration, and richness of feeling without exaggeration,



Fig. 420. Another example of Empire style. Note the typical brass ornamentation. (Courtesy Grosfeld House.)

pretension or opulence, they are unsurpassed in the history of furniture making. They somehow express perfectly a feeling of the cultured English gentleman in his best aspects.

Fig. 423 shows an example of Hepplewhite; Fig. 424 is Sheraton. Here is the finesse and sophistication of the well-bred without the smugness and self-satisfaction that are so often corollaries. The quiet richness of the inlaid decoration, delicately refined moldings, simplicity of outline and nicety of proportion are the identifying characteristics of these styles.

It is not always easy to distinguish the cabinets of these two

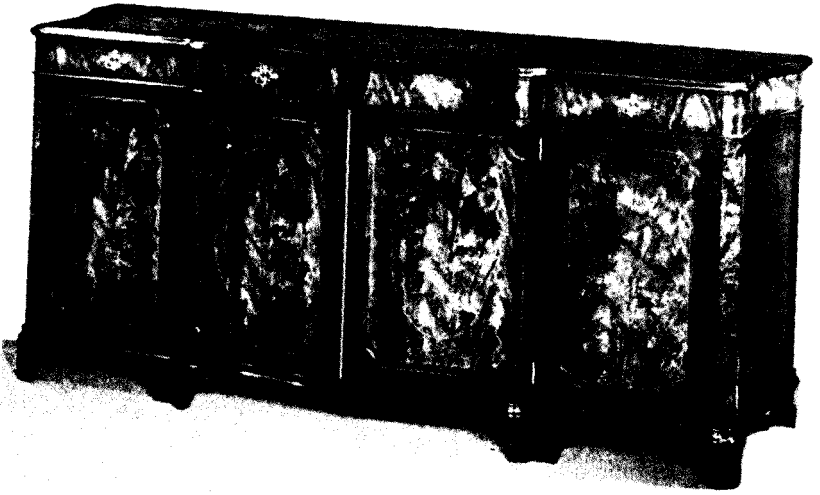
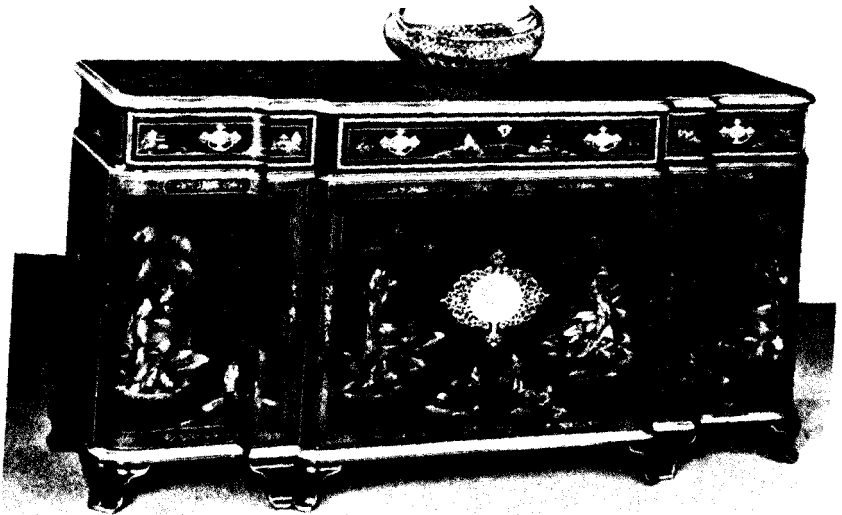

Fig. 421. *A highly simplified version of Chippendale. (Courtesy Schmieg & Kotzian, Inc.)*

Fig. 422. *Many forms and variations of his basic ideas were produced by Chippendale. This piece shows strong Oriental influence and is aptly called Chinese Chippendale. (Courtesy Schmieg & Kotzian.)*



styles from each other, particularly in Modern reproductions where characteristic details may have been simplified and thus obscured. There are characteristic differences in the inlay patterns used by the two designers. Hepplewhite tended to use the oval motif in inlays more often than Sheraton, who rather preferred the rectangular. Sheraton liked somewhat more contrasting figured woods in his inlays than Hepplewhite and leaned toward more



Fig. 423. Another English style named after its originator is the *Hepplewhite*. (Courtesy Schmieg & Kotzian.)

elaborate pediments on his high pieces. Also, his proportioning tended to be somewhat narrower, giving his pieces more of a feeling of verticality.

The work of the brothers Adam never achieved the popularity of the preceding English designers. They were actually architects

rather than furniture men and their furniture reflected a formal architectural approach that it not as livable as the others and perhaps explains why it was not as popular.

An example of their style (Fig. 425) shows this approach quite clearly. They were notable because they introduced classical

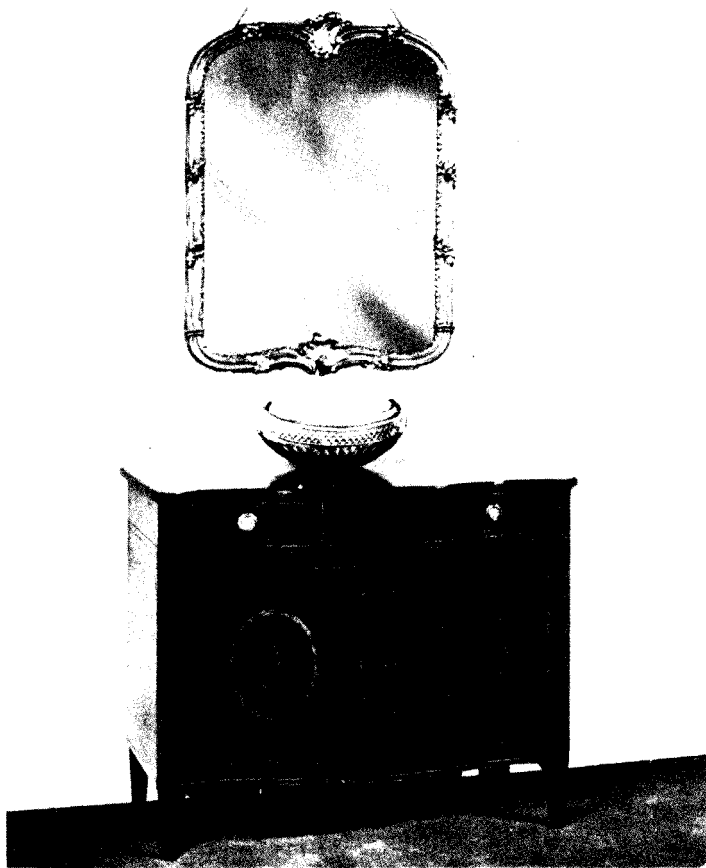

Fig. 424. Hepplewhite and Sheraton are sometimes hard to distinguish. Note the curvature of this example of Sheraton as compared with that of Fig. 423. (Courtesy Schmiege & Kotzian.)

decoration into English furniture design and also because, being architects, they thought of and designed furniture as an integral part of architecture.

The only other English style of importance to us is that of the Regency. This followed those previously mentioned and was greatly influenced by the Empire style of France. Compare Fig. 426, an example of Regency, with Fig. 424, of Sheraton. Dis-

regarding the shelves added on top, Fig. 426 seems to have lost some of the carefully refined grace of the Sheraton and picked up traces of the pomposity of the Empire. This is typical of Regency as compared with the Hepplewhite–Sheraton styles. Regency never approaches the heights of pretentiousness reached

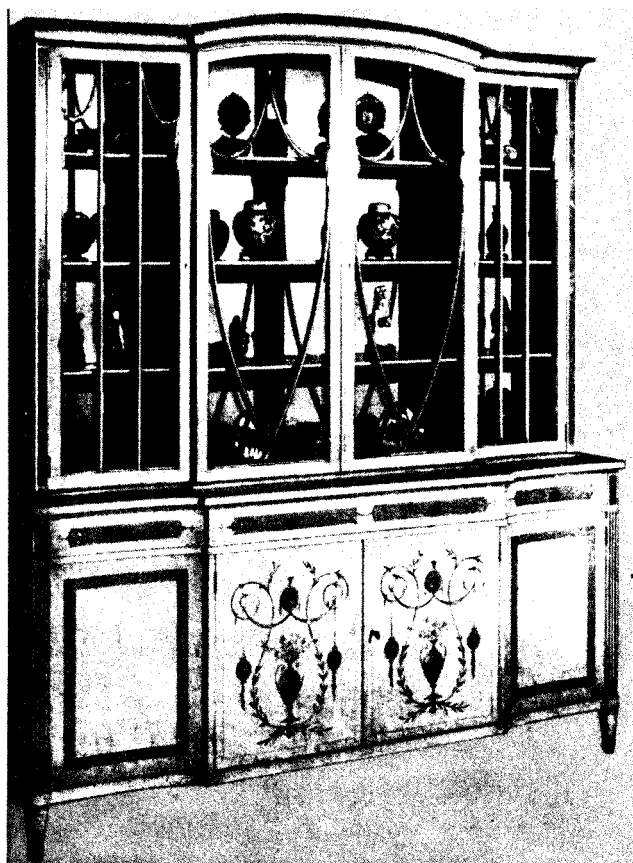

Fig. 425. *The Adam brothers were architects first and furniture designers second. This piece shows the introduction of Classical decoration into English furniture.* (Courtesy John Scalia, Inc.)

by the Empire style, but it does reflect the neo-Classical influence that was so widely felt throughout Europe at the time.

American Styles

American furniture is for the most part not as original and distinct in style as our national pride would lead us to believe.

Through most of our history our styles have followed English ones some 10 to 20 years after they had become popular in England.

In the very early days of this country we did have a Colonial style that, while drawn largely from English prototypes, became sufficiently distinct to constitute almost an American Provincial style, although it is never called that. By about the 1720's we had become enamored with aping English styles as quickly as we could and our own Early Colonial style pretty much disappeared.

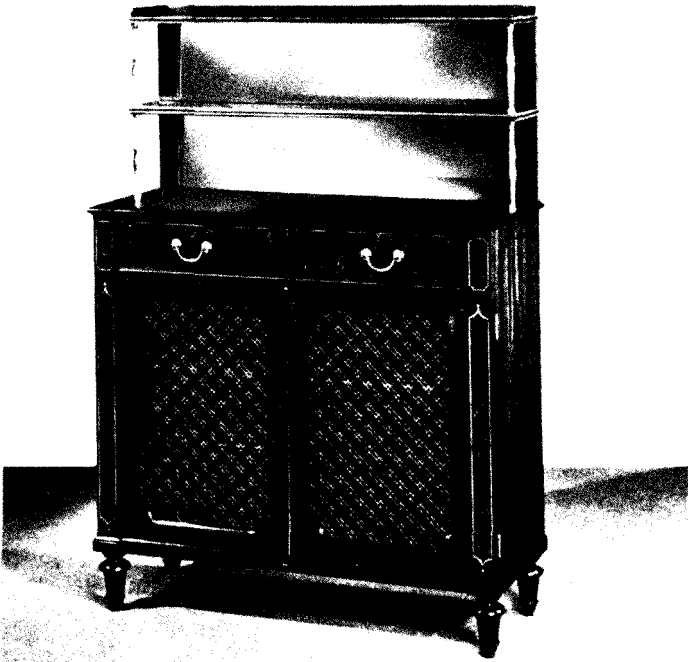

Fig. 426. *The Regency style shows the neo-Classic influence felt throughout Europe during the Napoleonic period.* (Courtesy Schmieg & Kotzian, Inc.)

When it originated, our Early Colonial style was derived from the Jacobean English style current in the home country at the time the early colonists left. It was considerably simplified as much by necessity as by intent, and it was further altered by the functional needs of the colonists. New pieces were developed and old models altered to meet the needs of frontier living.

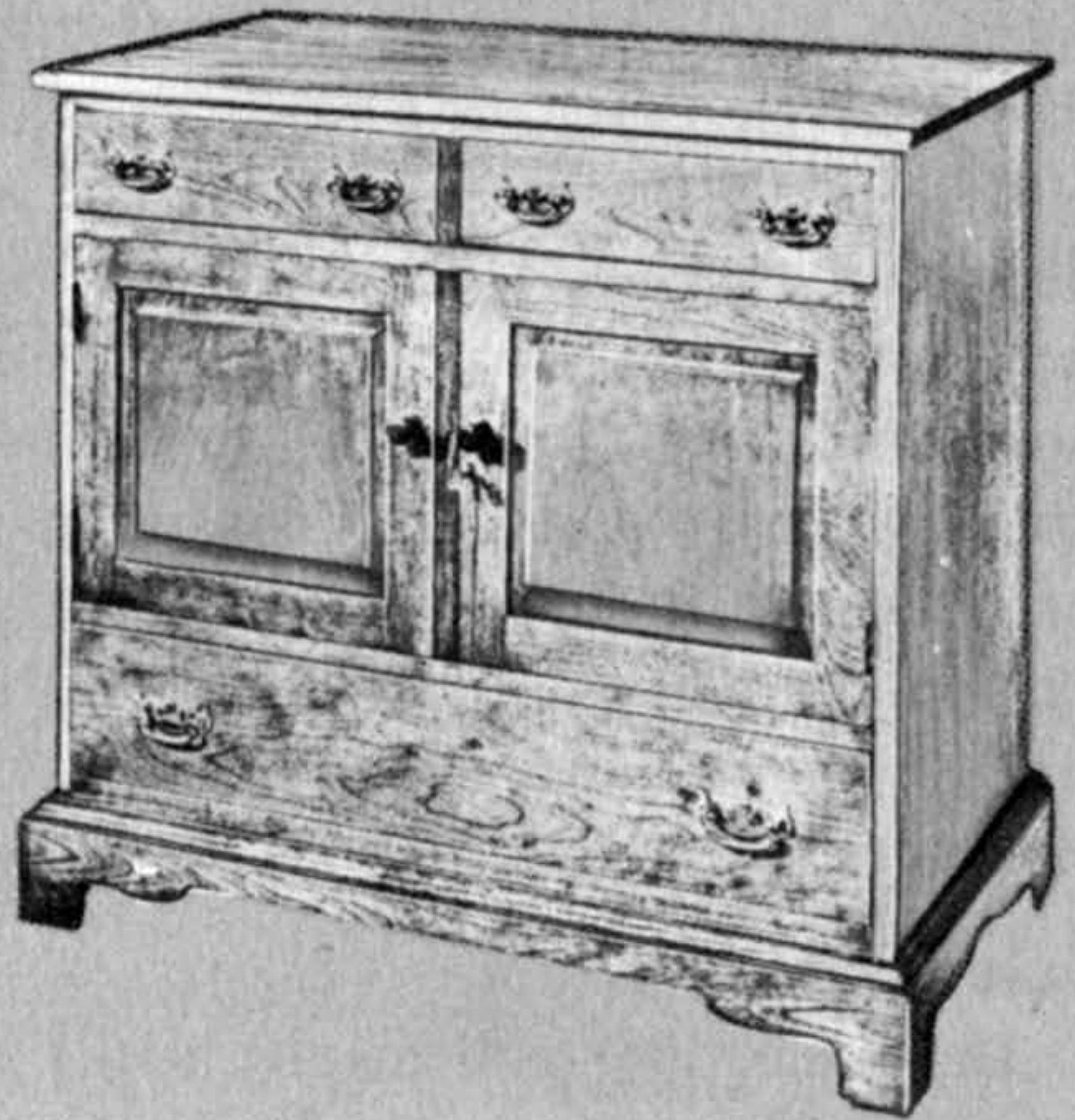
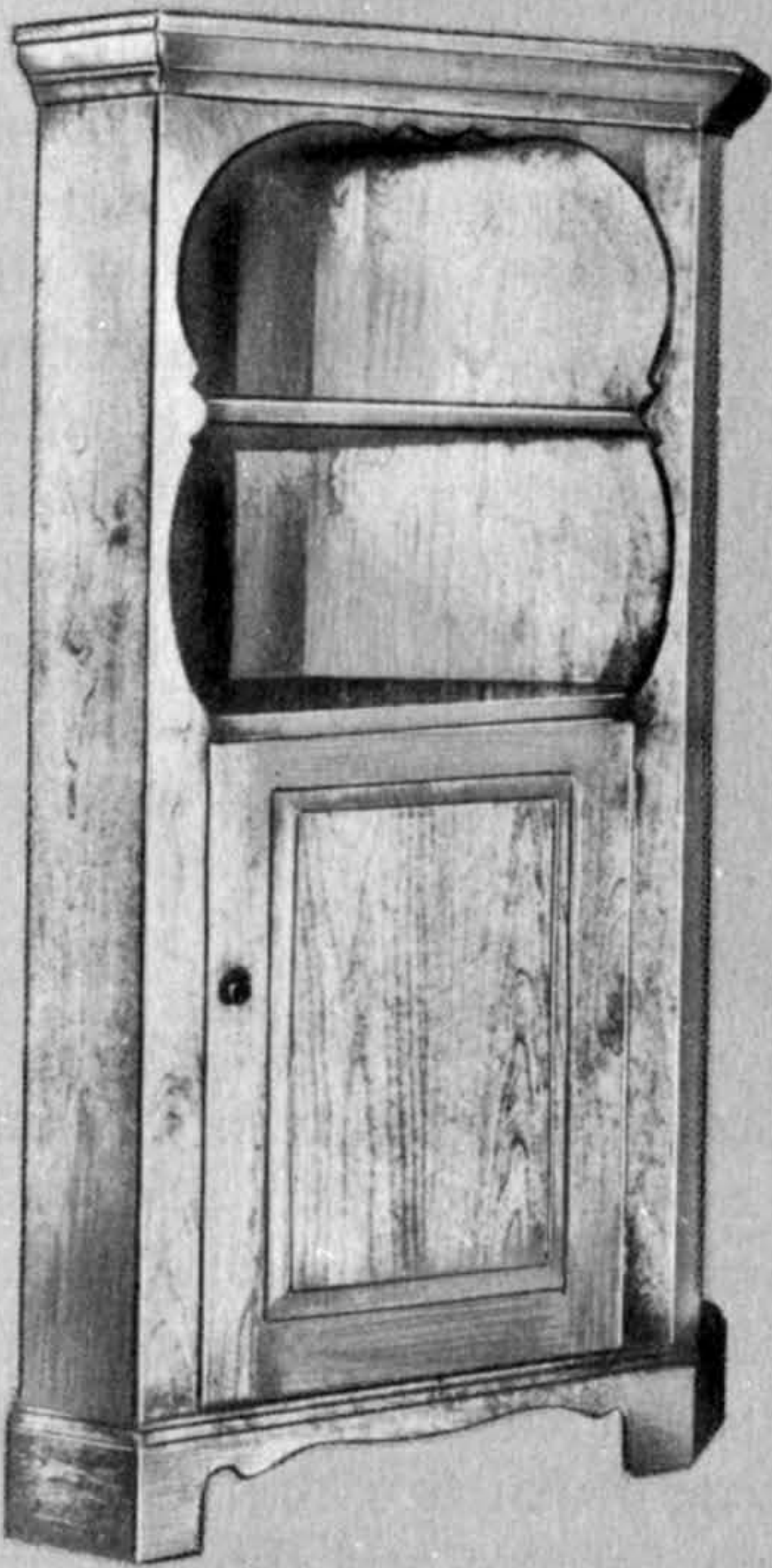

Fig. 427. This grouping illustrates the Early Colonial style popular in America prior to 1720: (a) sideboard; (b) a corner cupboard; (c) cupboard. (Courtesy L. & J. G. Stickley, Inc.)

The colonists had neither the tools nor the materials that had been available in England nor, for that matter, had they the time for the niceties of furniture craftsmanship. They built their furniture solidly so they wouldn't have to do it twice, and they made it simply because they had other things to do and could not afford to dally over time-consuming details.

Early Colonial is perhaps crude, but at the same time it has a charm in its simplicity, directness and functional ingenuity that is not to be found in the more sophisticated styles. A few pieces in early Colonial style that could be used to house hi-fi systems are shown in Fig. 427. The short heavy curved legs, plain rectangular inset door panels, simple straight cabinet lines, scroll sawn sides and shelf aprons in the upper shelf sections of sideboards and cupboards, and the typical knotty pine material are characteristic of this style. Other commonly used woods were cherry and maple. Pine was probably favored because, in addition to being in plentiful supply, it is soft and therefore easily and rapidly worked with the simplest of tools.

From the time that the Early Colonial style faded away into a Late Colonial style based on slightly belated copies of current English models, little original appears in America until Duncan Phyfe at the end of the 18th century and the beginning of the 19th. Until modern times Phyfe was the only American furniture designer and style setter of any real importance. His early work was largely derivative from Sheraton and Hepplewhite. Later however, he was considerably influenced by the French Directoire and Empire pieces then being imported from Paris. He discarded or changed much of the ornament of the French models, but retained the neo-Classic feeling of the originals. Phyfe's own originality shows more in his tables and seating pieces than in his cabinets, which stayed rather close to Sheraton.

Selection of style

Let's see how you might apply this knowledge of styles to some useful end in your own living room. Let us assume that a room X will accommodate an equipment cabinet of between $3\frac{1}{2}$ and 4 feet in length, 18 to 20 inches deep and 30 to 35 inches high. Due to a low ceiling, a cabinet of greater height will not look well in the room, and because of other existing furniture the length is restricted. Because of the size of your equipment and the fact that you want to include as much record storage as possible in the cabinet, you have no desire to reduce the dimensions, so they are settled, and with them you have also settled the basic shape of

the design. It must be a horizontal shape overall. The next question, then, is to determine the predominant style of the existing furniture to decide on the most desirable styling for the cabinet.

This is merely a matter of looking over the present furniture and comparing it with the styles we have discussed. In the majority of cases it will be one of them. If it should be in a style that has not been mentioned or if you are in doubt, perhaps a friend versed in these matters or the dealer from whom you purchased your furniture can identify it for you.

To achieve a pleasing and satisfactory overall room arrangement from both the visual and functional points of view, it is not at all necessary that all of the furniture in the room be of a single style.

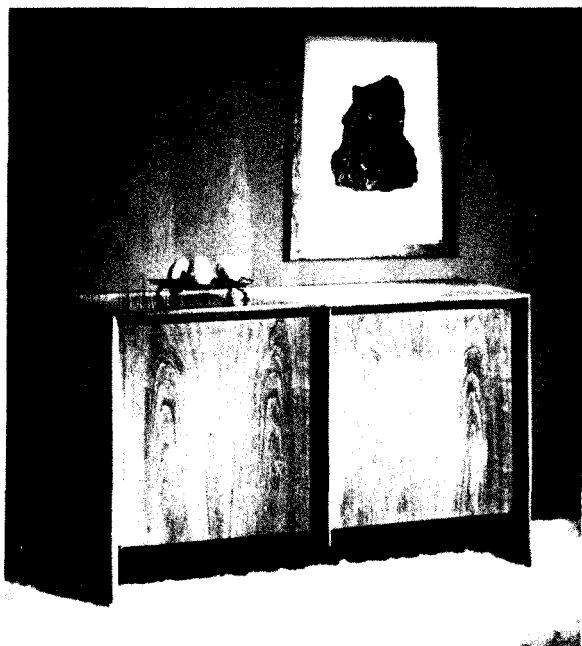

Fig. 428. *A Contemporary cabinet.* (Courtesy Widdicomb-Mueller Corp.)

Often pieces of varied, but similar, styles are blended with excellent results. Hepplewhite, Sheraton, Duncan Phyfe and perhaps even Chippendale could be mixed without visible conflict. Then again the neo-Classic styles could be mixed, Directoire, Beidermeier, Empire and perhaps Regency or Adam. And appropriate Contemporary can be mixed with any of them. Mr. Emerson's

statement that “consistency is the hobgoblin of little minds” is perfectly true of interior decoration.

Another trick that requires a bit more thought, care and taste but which, when well done, produces extremely interesting results is a restrained mixture of strongly contrasting styles. Some very distinctive and sometimes delightfully humorous effects can be achieved in this way. One Modern room of the strictest and most severe character was “made” by the incongruity and frivolity of one large Louis XV cabinet. By itself it was an absolute fright but so was the room without it. However, the combination of these two extremes in the same room lent a subtle touch of humor to both, and a happy, comfortable atmosphere to the entire room.

Unless you are sure of yourself, you will probably not want to try contrasts quite as strong as this. Just remember the main point of the story: if you use contrasts instead of blends, be sure the contrasts are strong enough to leave no question in anybody’s mind that you intended a contrast, not a blend that didn’t quite come off.

Unfortunately, very little guidance can be given as to whether contrast or blending is the right solution. It is primarily a matter of individual taste. There is, however, one good bit of negative advice. If you already have a mixture of styles, the chances are that the contrast technique won’t come off well. It works best when the rest of the styling is quite consistent.

To get back to the hypothetical case of the cabinet mentioned earlier, let’s see how this might be worked out in a few different styles. The cabinet in Fig. 428 is an excellent piece of Contemporary styling that also fits within the range of the dimensions we have allowed. By going to the limit of our permissible length, while staying under the height limit, the long low Modern effect is achieved while the heavy front molding adds the slightly softer feeling of Contemporary.

To get a Sheraton styling in the same space change the dimensions, within the given limits, to conform to Sheraton proportioning. This time the length can be cut back to the minimum and the height raised to maximum, and the piece would then be detailed in a manner characteristic of Sheraton’s style.

In step by step order it is really quite simple to adjust style, room space and equipment requirements to each other.

First: determine the minimum space required by your equipment.

Second: determine the maximum space you can allow in the room, and be sure that this maximum exceeds by a little all around

the minimums required by the equipment. This should leave a range in all dimensions within which you can,

Third: adjust your final dimensions to conform to the proportions that would be correct for the style you wish to use.

Fourth: add the correct characteristic detailing (legs, moldings, inlays, hardware or what have you) for the chosen style, and your basic design will be complete.

Your design, at this point, will lack only one thing before you can proceed to build it. Until you have worked out such things as what types of joints are to be used where, material specifications, finish specifications, types and locations of fastenings—in other words the details of how the unit is to be built, you'll still have only a pretty picture but not quite yet a complete design.

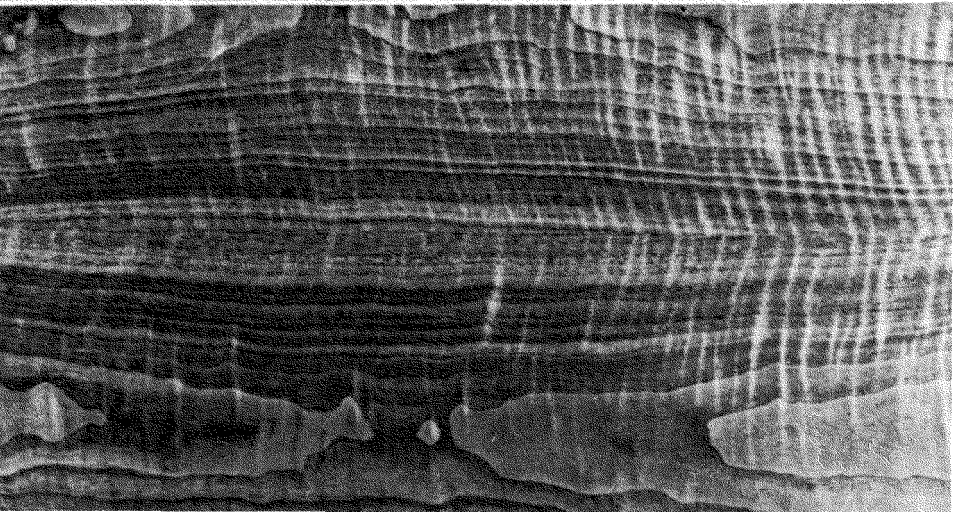
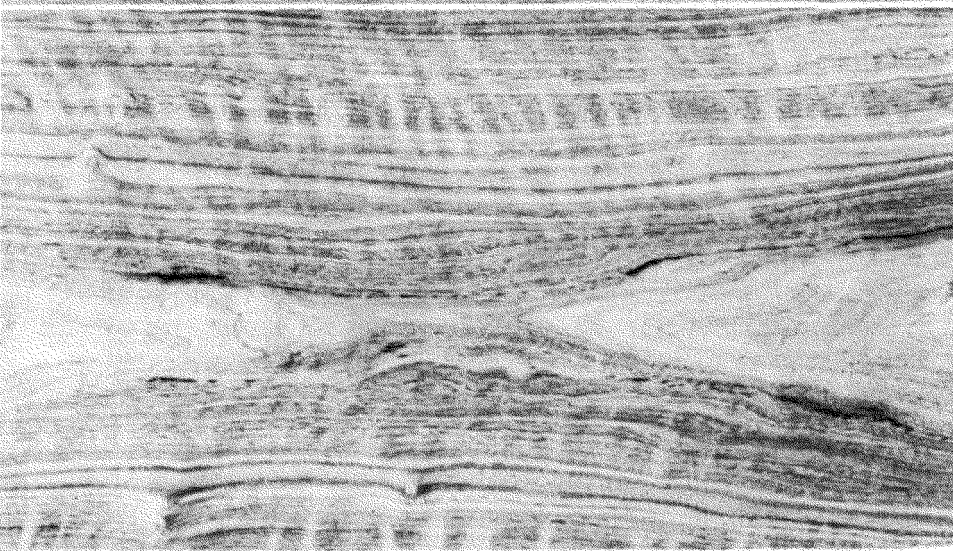
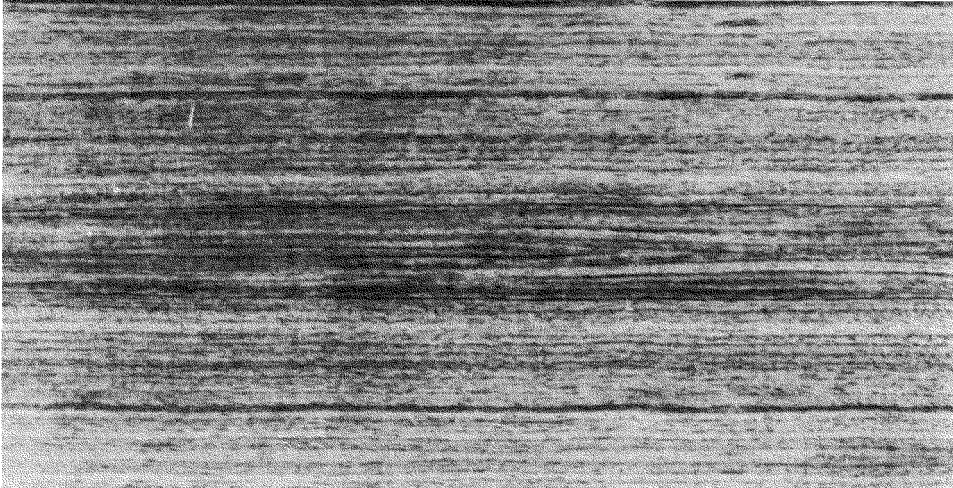

CHAPTER 5

materials

THE materials you choose for the construction of your furniture will have a considerable influence on the total effect. Basically excellent designs can be ruined by an inappropriate choice of woods, hardware or finish. On the other hand, designs of mediocre character can gain a great deal of distinction through an imaginative choice of materials. A well chosen knob, a brass ferrule, a beautifully figured piece of wood, a cane door, a plastic or marble top, can often enliven an otherwise pedestrian design and make an object of great beauty from a very simple set of lines and proportions.

Actually a design and the materials from which it is made are inseparable. Woods, metals, plastic, glass, etc., are the things of which furniture is constructed. It is very easy to fall into the trap of becoming fascinated with a set of lines on paper and lose sight of the final object. Many find that until they've had a little practice at it, visualizing a three-dimensional object from a few two-dimensional lines is difficult. To help yourself get to a point where you can visualize the shape of the finished product reasonably well from a two-dimensional sketch, try working the whole thing backward once or twice. Take some object of furniture that you already have in the house and reduce it to the type of working sketch that you will be making of your new hi-fi cabinet. It takes a bit of practice to be able to visualize this transformation in advance. But you'll find it isn't too difficult after you've tried it a few times.

The list of materials and chemical compounds used at one time

or another in the manufacture of furniture is practically endless. In addition to wood, what with varied metals, plastics, fabrics, ceramics, glass, leather, etc., the list encompasses practically everything known in the animal, vegetable and mineral kingdoms. However, the greater part of the material in any given cabinet will be wood.

Woods

There are a tremendous number of species and varieties of woods. They range in color from bone white, through pinks, grays, greens, tans, browns, reds and violets, to jet black. They vary in hardness from woods like lignum vitae or ironwood, which can ruin the edge of an ax; to soft woods like balsa which will crumble in your fingers.

You could easily spend the rest of your life studying woods and still not know them all. The study becomes more fascinating the deeper you get into it. For example, some of the names are amusing. A tropical American wood is called bleeding heart and another called stinking toes. One from Honduras is called billywebb, and one from Australia woolybutt. There's a South American wild dilly and one from Australia called messmate stringybark. India has dhup and hnaw. There are others named ita, oro and uhu and one called hooboballi!

Characteristics of woods

However, for the most part we use a fairly limited number of woods for our furniture work because of economic considerations, lack of supply, or because many do not have the right properties.

Certain characteristics should be kept in mind when choosing woods for cabinet work. The wood must be reasonably hard so that it will withstand normal use without chipping, denting, splitting and otherwise deteriorating before its time; and also so that it will accept fastening and jointing.

A good cabinet wood should have an interesting grain pattern. This is particularly important in Modern designs where the visual interest is so dependent upon the figure of the wood, rather than decorative details.

Texture and grain

A wood that has too strong a figure in its grain will tend to obscure the basic lines and proportions of the cabinet. Still another desirable feature in cabinet wood is that the texture be even and the pore structure be reasonably small and uniform so that the wood will take a stain, and finish to a fine, smooth surface.

Very often it is necessary to stain, bleach or tone a piece of furniture to the final color desired. This can be done only if the wood you choose has a sufficiently even pore structure to accept the stain evenly, and preferably without excessively obscuring the

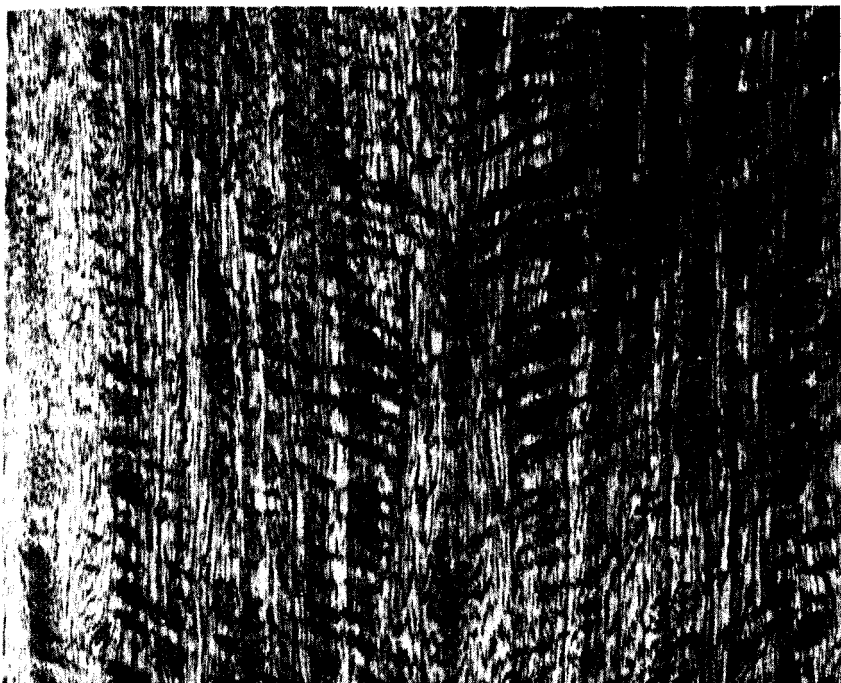

Fig. 501. *African mahogany is a widely used wood with a fairly pronounced grain.*
(Courtesy Hardwood Plywood Institute.)

figure of the grain. A suitable wood should not be subject to much warpage once it is seasoned. It should not have a high content of oils or resins or it will not glue satisfactorily, nor will it finish well.

Since wood is a product of nature, no two trees are exactly the same, not even two of the same species. Therefore different pieces of wood of the same species will not exactly match each other. This is nothing to be worried about, since it is in the variations of grain and color that much of the beauty of wood is to be found. Gross mismatches in color can generally be toned to a pleasing blend in the finishing process. Let's look at a few of the species commonly used for furniture at the present time, and see if you don't find one among them that will serve your purposes admirably.

Mahogany

Mahogany is actually a family name for a group of closely related tropical woods—at least 37 of them. They grow over quite widespread areas, including parts of Central and South America, India, the Malay States, Indochina and the East Indian Islands



Fig. 502. Honduras mahogany, although not as widely used as the African, is nevertheless a popular wood where cabinetry is concerned. (Courtesy Hardwood Plywood Institute.)

such as New Guinea, Borneo, Java, etc., and the continent of Australia. The trees are fairly large; a trunk diameter of a couple of yards is not uncommon.

More furniture is made of mahogany than any other single kind of wood. In all probability, more furniture is made of mahogany than all other species put together. Why this particular wood has become so popular among makers and users of furniture begins to be understandable when we compare its properties with those listed as being desirable in a furniture wood. It has just about all of them.

Ideal cabinet wood is rather like Socrates' ideal man, moderate in all things, and mahogany fairly well fills the bill. It is moderately hard: tough enough for adequate durability, yet not too hard to be easily worked with hand or machine tools. It has a beautiful

striped grain that provides the visual interest necessary to break up the large planes so often necessary in hi-fi furniture. At the same time the figure is sufficiently subdued and orderly so that it will not overpower the more important lines and proportions of your design. In mahogany of a given type, there is a good deal less variation of grain and color than in many other types of woods, making it easy to match one piece to another.

Often two or more pieces of furniture must be built at the same time to go reasonably close together in the same room. The colors of the finished units must match each other closely. In these circumstances, the relative color uniformity of mahogany is a great boon. It is much easier to get several pieces of furniture

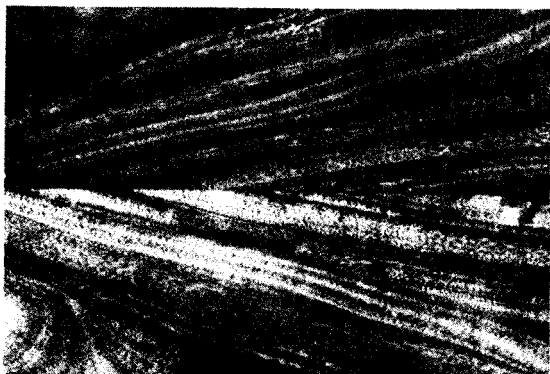

Fig. 503. Luan or Philippine is not a true mahogany. Some resemblance is there, but the pore structure, coarseness of grain and other disadvantages are sometimes outweighed by its economy. (Courtesy Hardwood Plywood Institute.)

to match each other after they're finished if the wood from which they are constructed is close in color to start with. By the way, the natural color of mahogany is not the rather dark red-brown that many people think but a fairly light pinkish color. The traditional deep red-brown color so often associated with mahogany is a stained color—not the natural color of the wood at all—which brings us to another favorable aspect of mahogany. It can be finished in an extremely wide range of colors varying from a blond, which is practically white, to a jet black.

The most commonly used varieties are African, and Honduras mahogany. African mahogany (Fig. 501) has a more pronounced and evenly ribbon-striped grain than the Honduras (Fig. 502) and for this reason it is the preferable of the two. In addition, African mahogany tends to have a somewhat finer pore structure.

There is another wood variously known as Luan or Philippine mahogany (Fig. 503) which is sometimes classed with mahogany. This covers a group of trees that are *not* true mahogany but have a similar grain. It is much coarser than mahogany and, although



Fig. 504. Walnut, because of its workability, durability, color and beautiful grain structure, is the choice of furniture makers. Never out of favor, a close look at this piece shows why. (Courtesy Hardwood Plywood Institute.)

it is sometimes available in ribbon-striped grain, most of it does not have this characteristic. The wood tends to chip rather easily. The coarseness of the grain and softness of the wood also make it much more difficult to finish. It will take stains reasonably uniformly and is satisfactory for dark-colored work. Although some lumber people claim it will bleach well, experience with it has been uneven and bleaching is not recommended. Its natural color is very similar to the medium light pink of true mahogany. The main reason for the use of Philippine mahogany is the price differential—it costs about two-thirds as much as true mahogany.

Walnut

Walnut (Fig. 504) is an extremely beautiful wood. A Temperate Zone plant, the tree is plentiful both in this country and in Europe. Compared to the mahoganies the walnut tree is a pigmy. The trunk size of walnut (2 to 2½ feet) is a bit deceiving, how-

ever, since there is a band of sap wood several inches thick around it which must be cut away before the darker heart wood, used for furniture work, can be obtained.

Walnut shares many of the desirable features of mahogany. As a result, it has enjoyed extremely high favor among furniture makers for literally hundreds of years. Walnut is a wood of medium hardness, giving it the same combination of workability and durability found in mahogany. It has a strongly pronounced and very beautiful grain, sometimes appearing as a pencil stripe, or series of narrow lines of light and dark close together, or in large swirling patterns, or combinations of the two. Its grain pattern is generally far less regular than that of mahogany, introducing matching problems at times. But they are more than balanced by

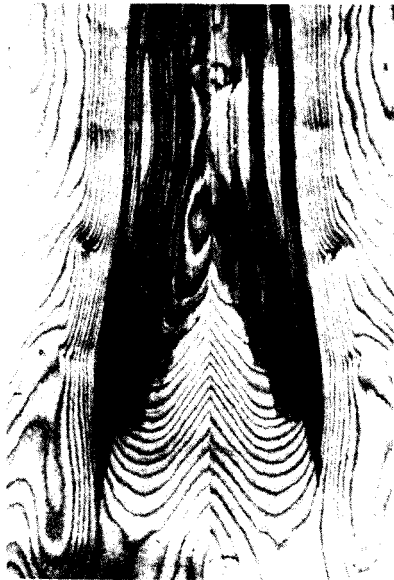

Fig. 505. *Despite the difficulties encountered when working with birch it is one of the finest natural blond woods available.* (Courtesy Hardwood Plywood Institute.)

the visual interest and beauty of the swirling figures, particularly in Modern designs.

Although walnut will accept a wide range of finishing colors, it has been used mostly in its natural unstained color, which, when finished, becomes a rich medium-dark brown. Like mahogany, walnut has a fine pore structure, allowing easy filling and a smooth, highly polished surface.

Birch

Birch (Fig. 505) is another Temperate Zone tree, most of the American furniture grade material coming from eastern Canada and northeastern United States. The tree is small as lumber trees go. White birch is extremely light blond in color, hard, tough and springy, with a very smooth even grain. Red birch is the

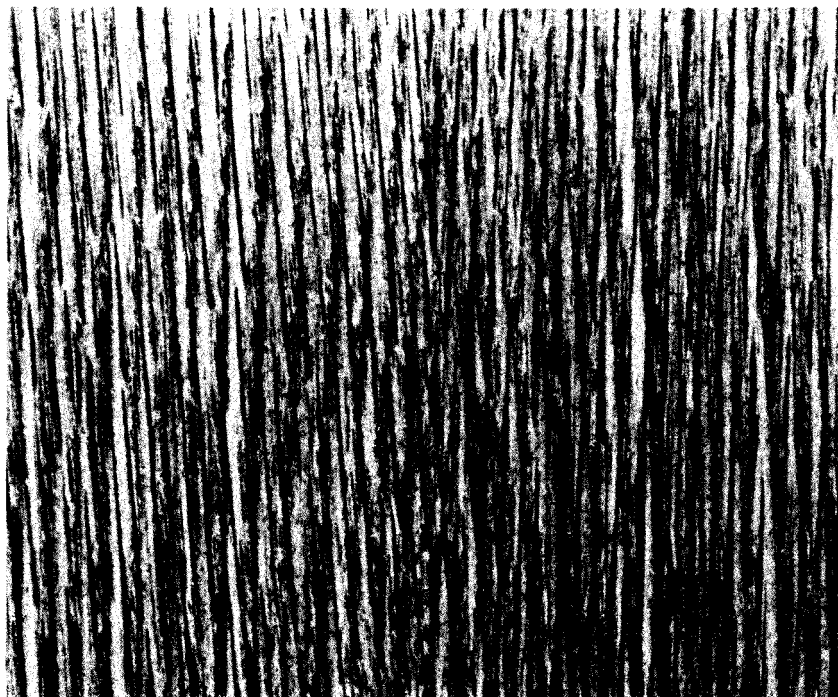

Fig. 506. *Comb-grain oak is one of the faces presented by this ever popular furniture wood.* (Courtesy Hardwood Plywood Institute.)

heart wood of the same tree and is of a light red-brown color. Birch is far harder than mahogany or walnut, which makes it more durable, but also harder to work. If you're going to make something in birch, keep the design simple so that most of it can be done with machines. If you insist on having a birch French Provincial breakfront with the carving necessary to make it authentic, hire someone else to carve it.

However, birch is an excellent cabinet material. It has most of the advantages we want. Extremely durable, it will take a wide range of finish colors with excellent uniformity. It has a figure in its grain, particularly when lightly stained, that resembles the swirls of walnut. And it has such a fine pore structure that in

finishing it is not even necessary to fill to get a smooth surface that will take an extremely high polish.

Since birch is naturally blond, it is a very good wood to use where a light finish is desired. Because of its blondness the graining

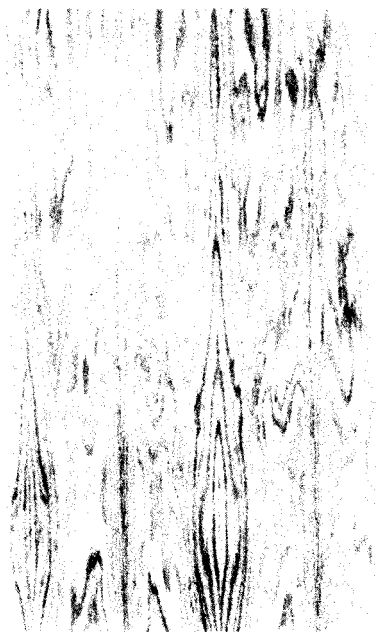

Fig. 507. *Plain sliced oak is characterized by a gentle swirl in its figure.*
(Courtesy Hardwood Plywood Institute.)

figure is subdued. Therefore the wood is not as visually interesting as some of the others. But then a lot of people don't like a strong grain: it's all a matter of taste.

Oak

Oak has been widely used for centuries and for good reason. It is one of the larger leafy trees found in the Temperate Zone, and is widely distributed in the United States and Europe. One of the very hardest and strongest of the domestic woods, it was used consistently in sailing days for the main timbers of ships, and is still the choice for the ribs and framing members of wooden vessels.

As a furniture material, its extreme hardness gives it tremendous durability and immense resistance to abuse. It will stand up to small children and pets long after most other materials have given up the ghost and disintegrated.

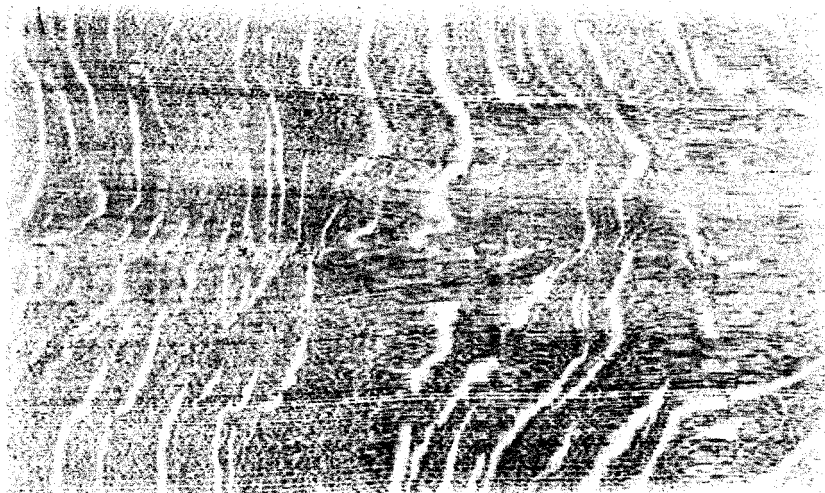

Fig. 508. *One of the most complex and beautiful figures seen in wood is found in the grain of quartered oak. (Courtesy Hardwood Plywood Institute.)*

Comb-grain or rift oak (Fig. 506) has an even-patterned grain showing a pencil stripe. Plain sliced oak has somewhat of a swirl to its figure, but not as much as birch or walnut (Fig. 507). One of the most beautiful patterns to be seen in any wood is found in the figure of quartered oak, with its contrasting longitudinal and radial lines (Fig. 508).

However, along with its advantages, oak has several glaring disadvantages. While it has a beautiful grain, it has a coarse pore structure. As a result, filling and finishing to a smooth surface is more difficult than with the smaller-pored woods. Due to its rather large and widely spaced pores and the extreme density of the material, it does not take stains as well as some the less dense woods.

In cost, it runs very close to walnut, which makes it one of the more expensive of the standard woods but less than the rare exotic ones.

The four woods mentioned thus far—mahogany, walnut, birch and oak—are what might be called the standards of the furniture field. An overwhelmingly large proportion of furniture is made from one of the woods of this group. However, a number of lesser known species are excellent cabinet materials and extremely beautiful woods. You may find that one of these appeals to you far more than the better known ones, so let's take a look at a few of them.

Primavera

With the emergence of Modern design as a dominant feature in the furniture field, there was a revolt, not only against the design of previous furniture, but also against the traditional brown



Fig. 509. *Avodire*, an African wood, is one of the more strongly grained blond woods. It suits itself admirably to the Modern look. (Courtesy Hardwood Plywood Institute.)

coloring. This led, among other things, to a search for some interesting woods of light color.

Primavera is a Central American wood sometimes known as white mahogany. Its hardness, durability and working properties are similar to those of mahogany and walnut. It has an extremely beautiful linear grain and the kind of density and pore structure that takes stains well, but it is normally used in its natural color. It has a very fine pore structure and will take a very high finish. Unfortunately, it costs 40–50% more than mahogany.

Avodire

Avodire (Fig. 509) is another of the woods that has come into recent popularity along with the Modern look. It is an African wood, blond in color ranging from just off white to pale gold. It falls into the category of the medium-hard woods and is therefore in the same durability and workability class as the mahoganies and walnuts. It has a beautifully figured grain, quite strong for a blond wood. Its texture and close, even pore structure make for

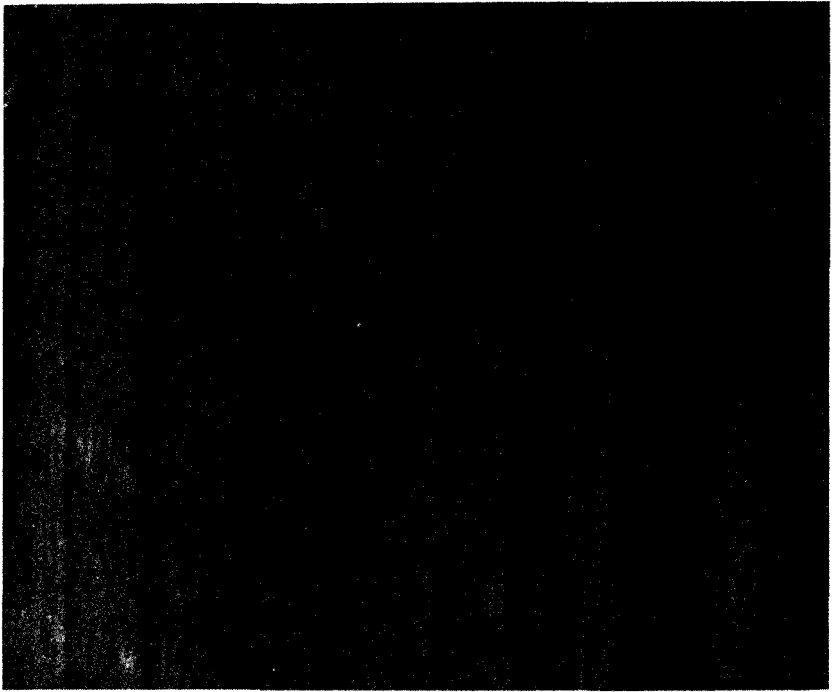

Fig. 510. *Blond limba or korina has a grain resembling mahogany and is sometimes sold as bleached mahogany. Also of African origin, it is in wide use.*
(Courtesy Hardwood Plywood Institute.)

excellent staining properties, but like primavera, it is seldom stained.

Since it is not in as widespread use as some of the other woods, it is sometimes difficult to obtain. When available, it runs in price generally somewhere between mahogany and walnut, and therefore is not one of the most expensive woods.

Blond limba

Blond limba (Fig. 510), sometimes known as korina is yet another of the more recently popularized blond woods. It, too, is of African origin. Its color ranges from ash blond to a light tannish yellow in the darker streaks. It has an extremely straight, regular and even grain, tending in figure toward a pencil stripe. It has been substituted for, and sold as, bleached mahogany. Although, in such cases, the customer is given incorrect information as to what he is buying, he is not really being fooled. In fact, if anything, he is probably slightly ahead on the deal—a wood that is naturally blond is more likely to stay that way than one that

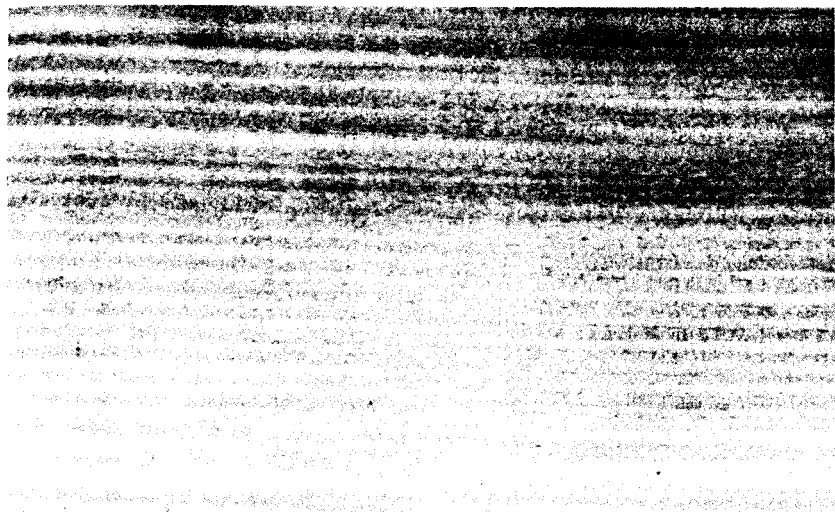

Fig. 511. *Sapele* is quite similar to African mahogany and is often confused with it. (Courtesy Hardwood Plywood Institute.)

has to be bleached. For a person who wants a blond finish, a naturally blond wood is far safer.

Korina has a texture and pore structure very similar to mahogany; it finishes, therefore, just as well. It is of about the same hardness, and therefore its durability will be just as good. Korina costs a little more than mahogany. So if someone has sold you korina as blond mahogany, smile smugly and go away happy because you have come out a little bit ahead on the material.

One final word in favor of limba is that it is more likely to be readily available than either avodire or primavera, since it is more widely used.

Chen Chen

Another blond African wood, which is, unfortunately, rather rare, is Chen Chen. It ranges from an off-white cream color to a pale yellow. It is figured with strongly pronounced ribbon stripes similar to mahogany.

An extremely beautiful wood, its texture and pore structure are well adapted to accept coloring as desired and it is easily finished.

Sapele

Sapele (Fig. 511) is an African wood similar to African mahogany. It is about as hard and has the same color, texture, pore structure and grain, but an even more pronounced ribbon stripe.

Sapele is often sold as mahogany. The only advantage to buying

it is that it generally costs a little bit less than mahogany. There's no particular reason for this except that sapele is not as well known and therefore the price isn't quite as high.

Teak

Teak (Fig. 512), has been a material of major importance in the Orient for hundreds, if not thousands, of years. It is found in the forests of Malaya and Indo-China and on the major islands of the East Indies. A hard, heavy, dense wood that comes from an extremely large tree, it has been used for all purposes, from architectural construction and shipbuilding to small sculptured figurines.

When finished to its natural color, teak has a medium-dark, rich red-brown color. It is somewhat darker in color than natural mahogany, but lighter than natural walnut.

Teak has a moderately coarse grain, but not as coarse as oak. It is generally seen finished in its natural color, often with just an oil

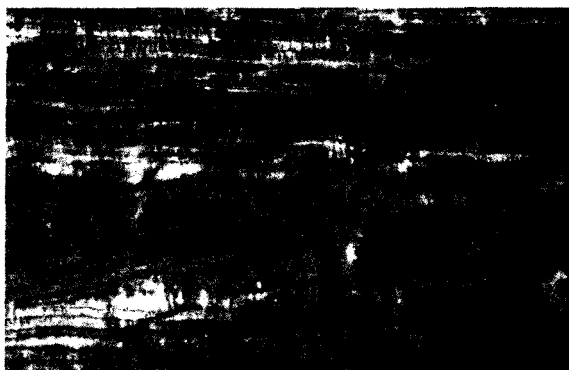

Fig. 512. Teak has been used for literally thousands of years. Its color and grain are such that it makes a striking material when properly used. (Courtesy Hardwood Plywood Institute.)

finish. Unfortunately it is very expensive, which limits its use. It generally costs about twice as much as mahogany.

Maple

Maple is an excellent heavy, hard, strong material having many of the characteristics of birch; it is blond, very hard, has an extremely close grain and a rather subdued figure.

Maple occasionally turns up extremely beautiful, and unusual graining figures: one is called birdseye maple (Fig. 513), another curly maple (Fig. 514) and a third blistered maple. While these



Fig. 513. One of the most beautiful and unusual grains found is birdseye maple. (Courtesy Hardwood Plywood Institute.)

figures are extremely beautiful when properly used, they are rather irregular and rare in occurrence in the wood itself, and are sometimes difficult to obtain.

The working, staining and finishing properties of maple are closely akin to those of birch.

Fig. 514. Curly maple is another example of the striking configurations of which this wood is capable. (Courtesy Hardwood Plywood Institute.)



Fruitwoods

Fruitwood is a sort of catch-all term for several different woods occasionally used for furniture. The most used fruitwoods are cherry, pear and apple. Of these, cherry is by far the most common.

The fruitwoods are heavy, strong, durable and close-grained. They vary from each other primarily in color and markings. Cherry runs from light to medium reddish brown in color, with a rather well-defined figure. Pearwood is a light, rosy pink with alternate light and dark shadings forming a large, mottled figure, considerably larger than the figure of cherry. Apple is also a light reddish color, with a more subdued figure than that of either cherry or pear.

None of these woods is apt to be in plentiful supply. If you want to use a fruitwood, try cherry; it will be the easiest to find.

A great deal of what is called fruitwood furniture is actually a fruitwood color simulated on either mahogany or walnut, and sometimes birch. If you like the fruitwood color but can't find the wood itself, a skillful finisher can simulate the color on one of the three more readily available woods just mentioned.

Gum

Gum is listed last among the hardwoods, not because it's the least used, but because it is the least desirable. Gum is hard, heavy and strong and is the most inexpensive of the hardwoods. These features are good, but it has a number of disadvantages.

In the first place, it has an excessive tendency to warp, and therefore cannot be used for any large areas without numerous internal supports.

Gum occurs as so-called white and red gum. The names refer, respectively, to the sap wood and heart wood of the same tree. The white gum is pinkish white, while the heart wood, or red gum, is a light reddish brown. White gum has practically no discernible grain figure, but is very often discolored with mineral streaks and other markings.

In addition to the graining and color irregularities found in red and white gum, the two types are usually mixed in the same piece of lumber or plywood, leading to additional irregularities. All in all, it's just not a very pretty wood. It's perfectly good for use where strength and expense are the main factors.

In finishing, it is best to paint or lacquer gum a solid color so that the grain is completely obscured. It will take a solid-color finish perfectly well, because it has a close grain and a very hard, smooth surface.

Knotty pine

Two soft woods are used often enough to require mention: one of them is knotty pine.

Knotty pine is used in furniture, most often for Colonial style reproductions. It is also used for wall paneling and for the construction of built-in wall treatments.

Pine has a flat and uninteresting grain. Knotty pine is considerably enlivened by dark knots against the lighter yellow background. One of its most attractive features is its low cost.

Fir

The second soft wood, and the last of the woods requiring mention, is the inevitable fir.

Fir is normally used in the form of plywood and is a good utility material for surfaces that will not show, such as backs, bottoms and

Fig. 515. One of the ways in which veneer is produced is through the use of the rotary cut. The wood is peeled from the spinning log in a thin sheet.

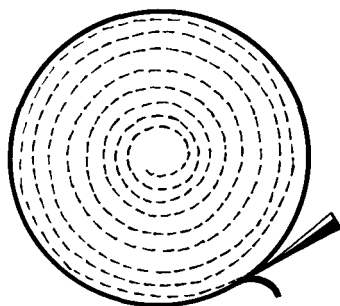

baffle boards in speaker enclosures. It should not, however, be used for any surfaces that will be exposed, except in the case of utility cabinets (such as experimental enclosures) or units that are to be painted to match the wall. I make this recommendation not because fir plywood is weak; but because it *is* ugly.

Fir tends toward an extremely wild grain, takes stain unevenly and is too soft to take a high finish.

Since it is far and away the cheapest of the standard plywoods, it is the material of choice for concealed parts, because you can save money this way. It is also entirely acceptable as the base for the lamination of plastic sheets such as Formica or Micarta. If these materials are laminated properly, there is little or no telegraphing of the underlying grain.

Fir is often used as the core in the manufacture of plywood that is later surfaced with a hardwood veneer. While the very best grades of plywood are not made in this manner, it forms a satisfactory material.

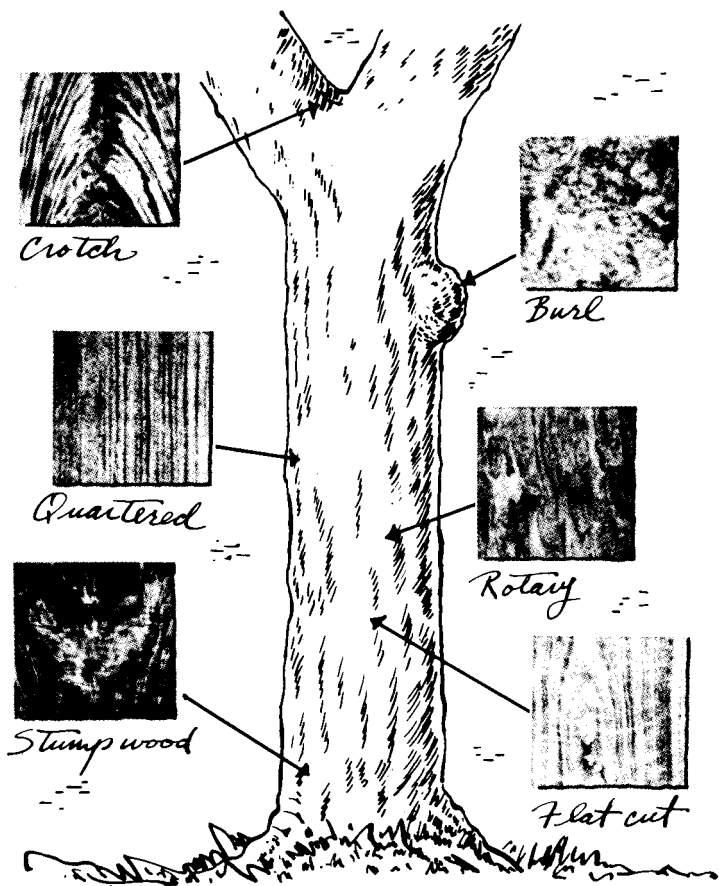

Where veneer figures are found

The various wood grain and figure patterns of face veneers used in hardwood plywood are determined by three main factors: 1) the part of the tree from which the veneer is cut; 2) the method of cutting (Quartered sliced veneer for example, shows a stripe produced by cutting across growth rings. In flat cut—or half round veneers the pattern is determined by the angle at which the knife passes through the growth rings. Rotary cut veneer, on the other hand, shows a highly figured and irregular pattern also occasioned by the angle at which the knife cuts through the growth rings; 3) the species of tree. From some species many figure types are cut. From most species however, production is limited to one or two figure or grain types.

Types of veneer cuts

Most furniture being built today is constructed of veneered plywoods rather than solid woods. This is not a disadvantage, as many people seem to feel, since plywood is inherently far more stable and resistant to deterioration than solid wood.

Since most of the wood part of your furniture will be veneered plywood, let's see how these veneers are cut, and how to describe

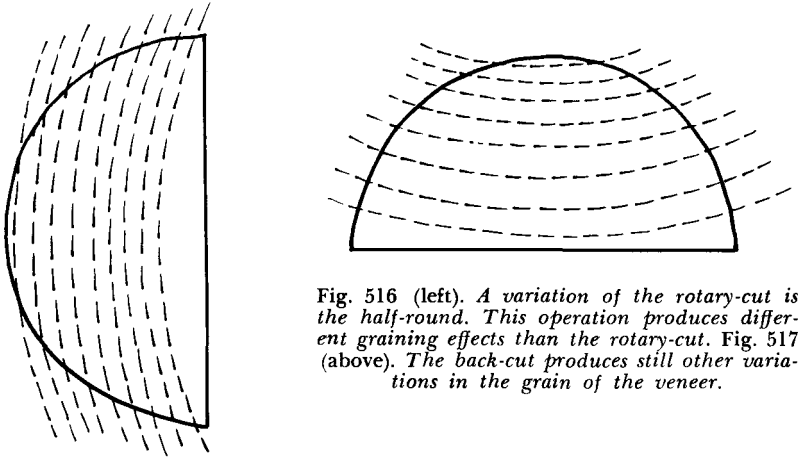

Fig. 516 (left). A variation of the rotary-cut is the half-round. This operation produces different graining effects than the rotary-cut. Fig. 517 (above). The back-cut produces still other variations in the grain of the veneer.

the figures that result from different methods of veneer cutting. This will enable you to specify accurately the kind of figure you want to your cabinetmaker or lumber dealer.

Logs are cut into veneers in one of three ways: they are either rotary cut, sliced or sawed. In rotary cutting, the log is first steamed in a large vat to soften the wood. The bark is removed and the log is mounted in a lathe and turned against a cutting knife which peels off thin layers of veneer along the whole length of the log (Fig. 515).

Two variations of the rotary cut are the half-round and the back cut. The log is split down the middle lengthwise and then mounted—in the case of the half-round, the curved side toward the knife (Fig. 516); in the case of the back cut, with the flat side toward the knife (Fig. 517). For both the half-round and the back cut, the knife follows a curved path through the wood, but the curve is not the same as in the rotary cut and the graining figure produced is different.

The main distinction in the figures produced by these variations is in the effect produced by the annular rings, which show up as

more and more sharply defined stripes as you move from rotary cut to half-round to back cut.

Sliced veneers are started by halving or quartering the log, and steaming it to soften the wood.

Plain slicing is done by mounting half a log in a frame that moves up and down against a stationary knife, cutting off a series of slices parallel to the center line of the log (Fig. 518).

In quarter slicing, quarters of the log are mounted in a frame in such a way that the knife will cut slices at or near right angles

Fig. 518. *Another method of producing veneer is plain slicing in which the log is moved up and down against a knife which slices thin sheets from it.*

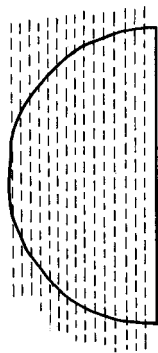

to the annular rings, producing a figure composed of narrow straight stripes (Fig. 519).

Sawed veneers are relatively uncommon, due to the excessive waste and consequent high cost involved. Where this method is

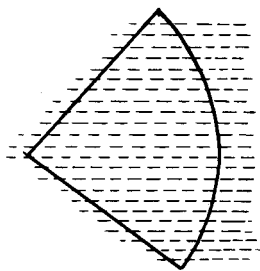

Fig. 519. *A variation of plain-slicing uses quartered logs. Called quarter-slicing, this method results in grain patterns composed of narrow straight stripes.*

used, the half or quarter of the log is passed through a special veneer saw, either a rotary or bandsaw, and straight slices are made, similar to the plain slice or quarter slice.

One other cut should be mentioned: you will probably run into it only in connection with oak. It is the so-called "rift cut" and is produced from quartered logs. They are cut in the same manner as quarter-sawed logs, except that the angle of the knife

to the annular rings, instead of being at right angles, is 15° or so beyond. This produces, in oak, the evenly-spaced pore structure and pencil type stripe characteristic of rift or comb-grained oak.

All the various figures in veneers are produced by the manner in which the veneer slicer strikes through the light and dark areas of the annular rings and by irregularities in the growth of the wood.

Three areas in a tree will show irregularities in the wood, which, in turn, result in particularly beautiful grain figures when sliced as veneers. One of these areas is the stump, where the wood fibres tend to twist and wrinkle around places where the roots join the trunk.

The second area is just below the crotch, where irregularities are produced by the branching out of a limb.

The third irregularity is called a burl. Burls are formed around an area where the tree was injured. A burl might be considered as the tree's equivalent of the scar tissue that forms as a result of injury to an animal. The cells divide irregularly, creating excess wood that forms in many little humps and bumps, which, when sliced, produce irregular swirls and eyes.

A good many terms are used in the trade to describe the various kinds of configurations and patterns that can occur in veneers. Plain stripe consists of alternating lighter and darker stripes running the length of the piece and produced by quarter-sawing through the growth or annular rings. Ribbon stripes are consistently wide stripes of alternately lighter and darker wood. It is generally found in mahoganies and woods similar to mahogany. Pencil stripe is a very narrow stripe of alternating light and dark, found in walnut and limba. Fiddleback is a strongly defined rippling figure running across the grain, often seen on the backs of violins—hence the name. It is found usually in mahogany (Fig. 520) or maple.

In addition to fiddleback, several other types of markings run across the grain, all of which are often lumped together under the heading of crossfires.

Most of the veneers you are likely to encounter will vary in thickness from $1/28$ to $1/16$ inch. Veneers can be cut as thin as $1/100$ inch. For all practical purposes, the thickest rotary-cut or sliced veneers are $1/8$ inch thick. Sawed veneers will, on occasion, get as thick as $1/4$ inch.

In the trade, wood cut up to $1/4$ inch thick is still considered veneer. Beyond that, it is regarded as lumber.

Types of cuts in lumber

Although the largest part of your cabinet will be plywood, it is likely that some portions will require the use of solid lumber: for moldings, edge bandings, legs or bases.

Basically, lumber is made in the same way as sawed veneers, except that the slices are thicker. Lumber will range in thickness

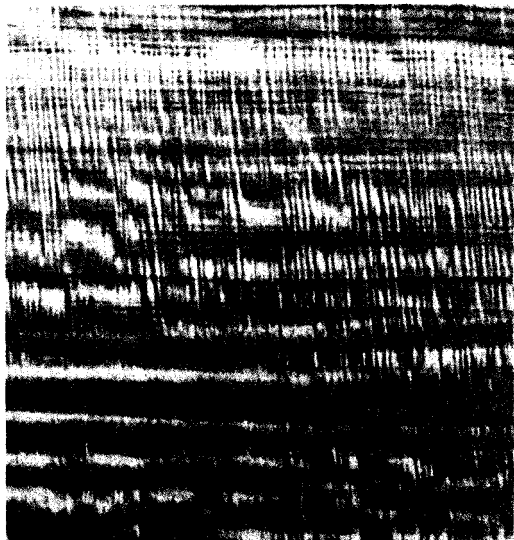

Fig. 520. A rather strong figure produced in veneers called fiddleback. This pattern is found primarily in maple and mahogany. (Courtesy Hardwood Plywood Institute.)

from the $\frac{1}{4}$ inch, which is the lumber-veneer dividing line, on up through board thicknesses to timber sizes, which may be many inches thick.

Furniture work very seldom requires lumber thicknesses beyond 2 or 3 inches; most of the material that thick is used for legs.

Since lumber is sawed, the same cuts that are made in veneers are the ones that can be made in lumber—plain, quarter or rift. Quarter or rift sawed lumber is very seldom required; therefore, there is very little of it made. The chances of your running into a situation that requires anything other than plain-sawed lumber is rather remote. For your purposes, you can pretty well consider that lumber is lumber, and disregard how it is cut. But remember that when you add a molding, frame or some other type of trim in solid material, you cannot expect an exact match of grain between the plain-sawed solid material and, for example, rotary-

cut veneer plywood. You can match the colors quite accurately in finishing, but do not expect an exact match of grain where a plywood surface meets a surface of solid wood.

Types of plywood construction

I have mentioned plywood a number of times, and it occurs to me that you might possibly be laboring under the illusion that "plywood is plywood," and that one is like another. Nothing could be further from the truth.

Plywood is constructed in several different ways, and there are various grades and classifications. All plywood constructions have

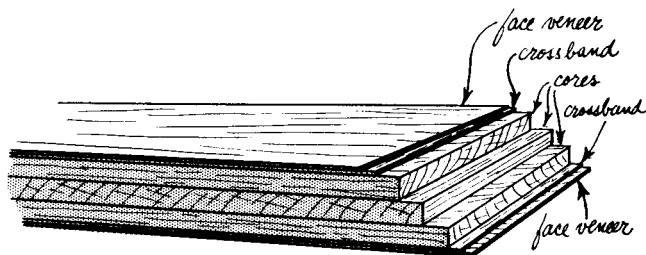

Fig. 521. Cut-away view of the internal construction of $\frac{3}{4}$ -inch veneer-core plywood.

this much in common: they consist of a number of layers of wood bonded together to make up the full thickness, whatever that may be, of the resulting panel. Starting from one side and going through the thickness of the plywood panel, you will find that all plywoods are made with the grain of each layer running at right angles to the previous layer.

Within the framework of these general similarities, there are several different ways of making plywood. The first and most common method results in a product called veneer-core plywood. Since most of the material you will be using will be $\frac{3}{4}$ -inch plywood, the illustration (Fig. 521) shows the construction of $\frac{3}{4}$ -inch veneer-core material.

The construction consists of two layers of veneer on the outside, crossbands beneath each layer of veneer, and three layers of core in the middle; making a total of seven plies altogether. This is the usual method, although you may possibly run into some nine-ply material. The number of plies is always an odd value, giving a balanced construction on either side of the center ply. This arrangement is intended to reduce any tendency to warp—*and it does.*

For material of less than $\frac{3}{4}$ -inch thickness, the basic construc-

tion remains the same, but the number of plies is reduced. For example, the $\frac{1}{4}$ -inch material, which you will use for control panels, will have only three plies. If you use any $\frac{1}{2}$ -inch material, it will generally be five-ply. Plies are always added or dropped in pairs on either side of the center. And, customarily, the core plies are thicker than the veneers or crossbands.

The next important construction method results in a product called solid-core plywood (Fig. 522). The veneer and crossband layers, top and bottom, are similar to comparable layers in veneer-core plywood. The difference lies in the core. In this case the core

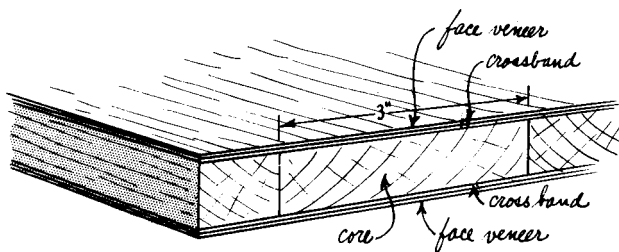

Fig. 522. Solid-core plywood differs from veneer-core in that the core material is composed of bands of solid material edge-glued to form the sheet of core material.

consists of 3-inch wide strips of solid wood running lengthwise through the panel and edge-glued to each other. Whichever way the annular rings of one strip of core material are curved, the rings in the strips on either side of it will curve the other way.

Solid-core plywood is more expensive than veneer-core, but is preferable. It will take edge veneers better and tends to have a smoother surface. That is to say, it has less tendency to telegraph ripples from underlying veneers and is more warp resistant than veneer-core.

Counterfront is a type of plywood that you will probably have little occasion to use except for built-in work, but you should be able to distinguish it from solid-core. Counterfront, like solid-core, consists of two veneer layers and two crossbands plus a solid core (Fig. 523). The core consists of strips $1\frac{1}{2}$ inches wide instead of the 3-inch strips in solid-core. The grain of both the coring strips and the surface veneers runs across the short dimensions of the panel, rather than down the length. This material is used mostly as an architectural plywood, rather than as a furniture material.

A relative newcomer to the field is plywood constructed on a core of chip or particle board. Chip board or particle board con-

sists of wood chips or wood shavings mixed with a bonding agent and pressed into a panel. Using this board as a core, plywood is made by adding the crossbands and surface veneers. The major claims made in favor of this material are comparable warp resistance and smoothness at a lower cost than solid-core. Since the core is grainless any tendency toward warping is sharply reduced.

One thing to watch out for with these chipboard core materials is the density of the core. There is considerable variation between different chipboards. If you are going to use a plywood with this type of core be sure it is strong enough to make good, solid cabinet joints. Some are; others are not. It depends on the purpose for which they were made. Some light-density chipboards are manufactured primarily for tabletops or sliding doors, where joints are not required and where stability against warpage is the primary consideration. Such a material is likely to be unsatisfactory for cabinet purposes.

On the other hand, denser-chipboard cores are made primarily for cabinet purposes.

Graining standards for veneer faces

One aspect of plywood quality is governed by the type of coring specified, another is covered in the grading of the face veneers. A plywood panel will have two face veneers, one on each side. These face veneers will be of the same thickness, but they will not necessarily be of the same quality nor even of the same material.

The price of plywood varies depending upon the grade of face veneers used. Use a good grade on any faces that will show. On the other hand, it is rather silly to go to the expense of paying for good grades on faces that will not show. For example, it is ridiculous to use good two-faced plywood for building speaker enclosures, where one of the faces will be inside and never seen. On the other hand, a swinging door is adequate reason for the use of good two-face material.

In general, then, specify one good front face. Specification of the backing face will vary depending on the cabinet; that is to say, on how much of the backing face will show.

For your convenience, we list here the basic Hardwood Plywood Institute Grading Standards governing faces and backs of hardwood plywoods. Most of the plywood you encounter will be governed by these standards, as the major American manufacturers are members of the Hardwood Plywood Institute.

Custom grade

This grade includes special selections and types produced by individual mills, or panels of a grade description agreed upon by buyer and seller. Architectural plywoods, technical types and matched-grain panels for special uses are also included.

Good grade (1)

For natural finish—the face shall be made up of tight, smoothly cut veneer, containing the natural character markings inherent in the species. If made of more than one piece, matched at the joints to avoid sharp contrasts in color and grain. A few small burls, occasional pin knots, slight color streaks or spots shall be permitted. Knots (other than pin knots), worm holes, splits, shake and doze shall not be permitted.

Sound grade (2)

For smooth paint surfaces—the face shall be free from open defects to provide a sound, smooth surface. The veneer is not matched for grain or color. It may contain mineral streaks, stain, discoloration, patches, sapwood, sound tight knots up to $\frac{3}{4}$ inch in average diameter, sound smooth burls up to 1 inch in average

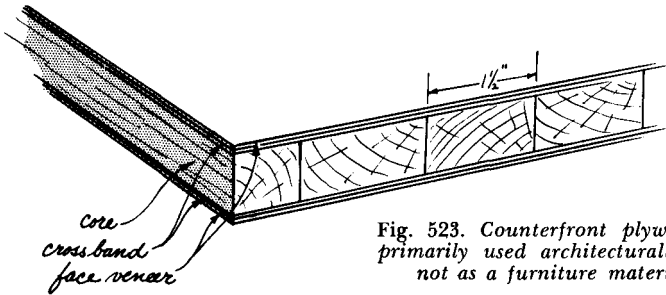

Fig. 523. Counterfront plywood is primarily used architecturally and not as a furniture material.

diameter, hairline splits or open joints up to a maximum of $\frac{1}{64}$ inch. Rough-cut veneer, brashness, shake or doze are not permitted.

Utility grade (3)

Discolorations, stain, mineral streaks, patches, tight knots, tight burls, knot holes up to $\frac{3}{4}$ inch in average diameter, worm holes, splits or open joints not exceeding $\frac{3}{16}$ inch and not extending half the length of the panel, cross creaks and small areas of rough grain shall be admitted. Brashness, shake or doze are not permitted.

Reject grade (4)

The veneer shall be unselected for grain or color. Knot holes

no greater than 2 inches in maximum diameter and no group of knot holes in any 12 inch square exceeding 4 inches in diameter and splits no wider than $\frac{1}{2}$ inch shall be admitted. Splits $\frac{1}{2}$ inch wide at widest point may be one-fourth panel length; those not more than $\frac{3}{8}$ inch wide at widest point may be one-half panel length; those not more than $\frac{1}{4}$ inch wide may be full panel length. Mineral streaks, stains and discolorations not associated with rot or doze, shims, plugs, patches, knots, burls, worm or borer holes and other characteristics are permitted, provided they do not seriously impair the strength or serviceability of the panel.

Fir plywood

In addition to the grading standards used for hardwood plywoods, another set of standards has been set up for grading fir plywoods.

In spite of the fact that its exterior appearance and finishing properties suffer by comparison with the hardwoods, fir plywood, for our purposes, is structurally just as sound as a plywood with a hardwood veneer. And, in view of the cost factor, it is, for many applications, the material of choice. It would be absurd, for example, to make the backs, bottom and baffle boards for speaker enclosures out of hardwood veneer. It would be equally silly to make the internal partitions in a horn out of hardwood veneer.

Fir plywoods are made entirely in veneer-core construction and are of two types, as well as several surface-appearance grades within each type. The two types of fir plywood are differentiated by the kinds of glue bond between plies. The *exterior* type is bonded with a completely waterproof glue, and it is required by the standards that the glue bond test out to be stronger than the wood itself. *Interior* type is made with a moisture-resistant but not waterproof glue. It will stand up under occasional wetting, but is not intended to withstand soaking.

In each type there are several grades, which refer to the surface appearance of the plywoods, similar to the grades used in hardwoods. Altogether there are seven grades of exterior and nine of interior type. However, not all of them concern us.

Grading of fir plywood is by letter rather than by the numbers used for hardwoods. The following standards for face veneers in fir plywoods are quoted from official publications of the Douglas Fir Plywood Association, which sets the standards in this industry. The standards given are minimum for each grade or, to put it another way, the defects mentioned are the largest defects that

will be allowed in each grade. The largest percentage of the material exceeds the standards given for the respective grades.

Veneer grade A

Must present a smooth surface free from knots, open splits, pitch pockets and other open defects. The veneer should be well joined if more than one piece is used. Grade A admits discoloration, sap wood and pitch streak averaging not more than $\frac{3}{8}$ -inch width and blending with the color of the wood; admits maximum of 18 veneer patches in a 4×8 -foot sheet; admits shims and neatly made panel patches. The shims may not be used over or around any type of patch and multiple repairs must be limited to *two* patches. All patches and repairs must run parallel to the grain. Grade A also admits approved plastic filler in splits and other minor defects up to $\frac{1}{32}$ -inch in width; in small splits or openings up to $\frac{1}{16}$ -inch in width if not more than 2 inches long; in small chipped areas or openings not to exceed $\frac{1}{8}$ by $\frac{1}{4}$ inch long.

Veneer grade B

This grade must present a solid surface, free from open defects, except splits not wider than $\frac{1}{32}$ -inch.

Vertical ambrosia beetle borer holes are permitted if they do not exceed $\frac{1}{16}$ inch in diameter and averaging not more than one per square foot; also horizontal tunnels $\frac{1}{16}$ -inch across, 1 inch in length, 12 in number in a 4×8 -foot panel, or proportionately in other dimensions.

Veneer quality C (repaired)

This is used for underlayment grade only. Tight knots can be up to $1\frac{1}{2}$ -inches in greatest dimension and worm and borer holes or other open defects may not exceed $\frac{1}{4} \times \frac{1}{2}$ -inch. Splits not to exceed $\frac{1}{16}$ inch wide are allowed. Solid, tight pitch pockets, ruptured and torn grain, minor sanding defects and sander skips up to 5% of the panel are allowed.

Veneer quality C

Knotholes shall be 1 inch in their least dimension; pitch pockets not wider than 1 inch; splits $\frac{3}{16}$ -inch (must taper to a point). Worm or borer holes $\frac{5}{8} \times 1\frac{1}{2}$ inches; tight knots— $\frac{1}{2}$ inch; plugs, patches, shims and minor sanding defects are permitted.

Veneer quality D

This veneer is used only in interior type plywood. Knot holes— $2\frac{1}{2}$ inches; pitch pockets— 2×4 inches; splits, widths at widest point: $\frac{1}{2}$ inch up to quarter panel length; $\frac{1}{4}$ inch up to half

panel length; 3/16 inch up to full panel length; all must taper to a point.

Plugs, patches, shims, worm or borer holes and minor sanding defects are allowed.

Veneer quality N (natural finish)

This is a special grade. It presents a smooth surface, 100% heart wood of yellow or pink color without stain. It must be free from knots, splits, pitch pockets and other open defects.

If joined, not more than three pieces of the veneer should be used, joints to be well matched as to color and grain and all joints to be parallel to the edges of the panel.

A maximum of two shims is allowed, not to exceed 6 inches long at the end of the panel. A maximum of four well-matched small patches not to exceed $\frac{3}{8} \times 2\frac{1}{2}$ inches is permitted.

All repairs must be parallel to the grain of the panel; neither overlapping of repairs nor plastic filler is permitted.

With these various veneer grades, different grades of plywood panels are made; the grading of the panels depending on the quality of the front and back face veneers. For example, AA grade of either exterior or interior type is good two-face. AB is good one face with the second face not quite as good as the first. On grades AC and AD the back face becomes progressively less attractive in appearance. By the time you get down to CB, you're using a utility grade. Structurally, it's just as sound as the others but its appearance is not as good.

In a situation where, for example, Formica type plastic laminates are going to be used for surfacing the cabinet, why pay for A faces when they're going to be covered? BD is a perfectly good grade for this purpose. No one is likely to stare for hours with rapt attention at the back or the bottom of a speaker enclosure. Again, this is a perfectly good use for BD grade.

Special surface veneers

In addition to standard hard or soft-wood panels, several companies produce specially surfaced decorative panels primarily for use as wall surfacing. Among the various decorative effects available are striated surfaces, embossed surfaces, simulated tongue-in-groove and parquet effects, actual tongue-and-groove strips and raised-grain effects. These special-effect panels are not desirable for a free-standing cabinet but, where a built-in wall installation

is intended, some very beautiful results can be achieved by integrating the installation into a paneled wall.

I am sure that you are all familiar with at least some of the laminated plastic surfacings that are available. These appear under a wide variety of trade names: Formica, Micarta, Textolite, Conso-weld, Pionite, Nevamar, etc. You are probably familiar with these sheets in the form of the rather grisly patterns used for kitchen work surfaces, bathrooms, luncheonette counters and tabletops. These same panels are also available in excellent wood grains and in a number of solid colors. Some very exciting combinations can be achieved by the judicious use of solid colors; for example, a white top or white fronts on a walnut cabinet.

The great advantage of these materials, of course, is that they are virtually impervious to the assaults of alcohol, cigarettes, small children and pets.

Walnut grains as well as dark and blond mahoganies are very attractive in plastic laminates; oaks or birches less so.

Hardware

The hardware, or lack of it, employed in your furniture can practically make or break the design. Choose it with great care.

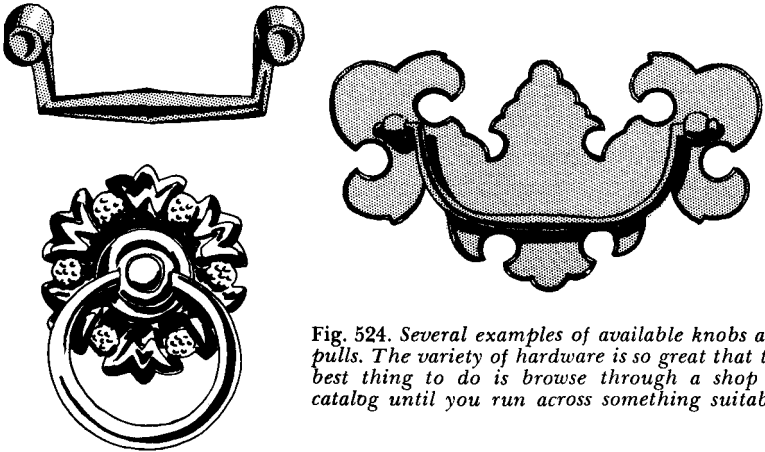

Fig. 524. Several examples of available knobs and pulls. The variety of hardware is so great that the best thing to do is browse through a shop or catalog until you run across something suitable.

You won't believe, until you have browsed through a really well-stocked hardware store, what a tremendous variety is available. There are literally hundreds of different knobs and pulls, as well as numerous kinds of hinges, catches, ferrules casters, gliders and various types of decorative metal trim.

Your choice of knobs and pulls is strictly a matter of taste. Look

at what is available until you find something that strikes your fancy. A few types are shown in Fig. 524.

With hinges there is one practical consideration over and above appearance. Whether you use the completely concealed type such as the Soss, the semi-concealed pivot hinges, piano hinges, butt

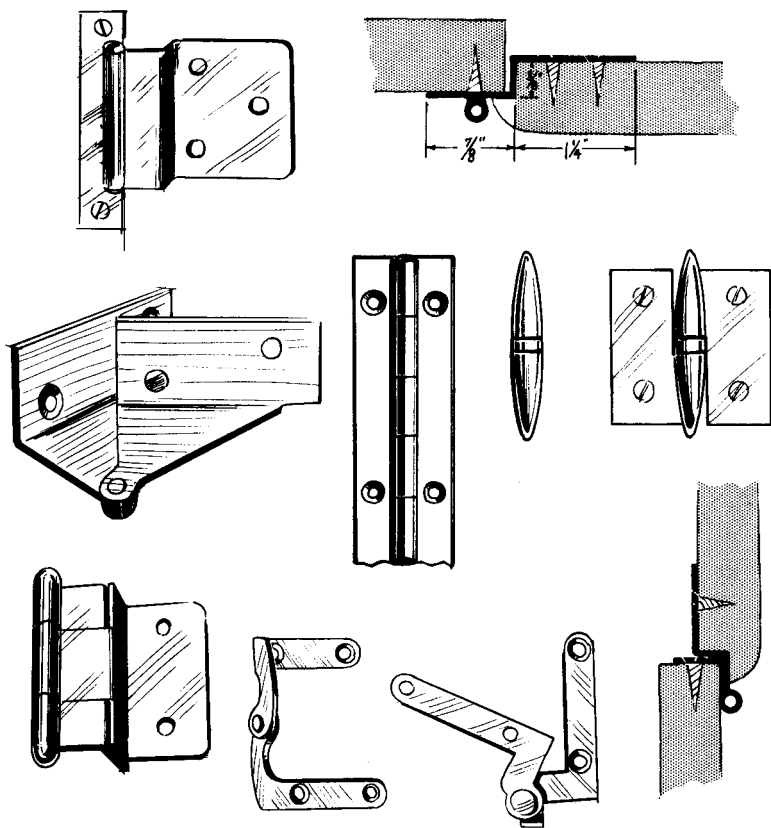

Fig. 525. Hinges are also a matter of taste. These are but a few of the available types.

hinges or any decorative hinges, be sure that they are capable of carrying the load of the door, lid or drop front you plan to hang on them. Fig 525 shows just a few of the available types.

As far as weight-handling capacity is concerned, the piano hinge is the strongest. The butt and Soss hinges are next. The weakest of the lot is the pivot hinge, so be careful as to how much weight you plan to load on it.

If you have any pullout drawers, for example, housing record changers or tape machines, you will need drawer slides (Fig. 526).

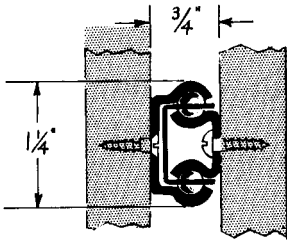
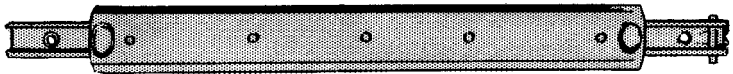
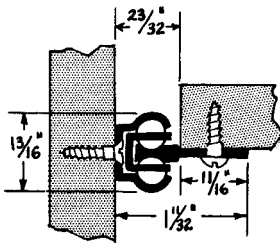
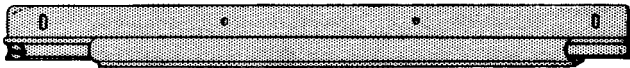
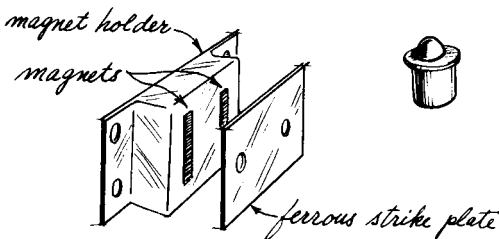
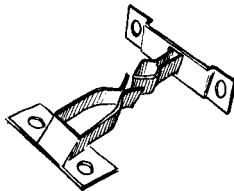

Fig. 526. Drawer slides of several types are available for equipment that is mounted in pullout drawers of any kind.



Make sure that the drawer slide will be able to carry the weight of the equipment. The drawings at the left show ball-bearing catches—a few of the many different types that could be used.

Fig. 527. Door catches of various types are also available in many sizes, shapes and forms. The bullet and magnetic types are the least conspicuous.



The standard type will be perfectly adequate for your record changer but, if you have a good-sized tape machine in a pullout

Fig. 528. Casters must be chosen with a view as to how often the cabinet is going to be moved and how much weight it will have to carry. The one illustrated here is a good general purpose type.

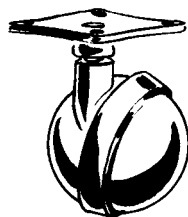

drawer, you will probably find it will be necessary to look for some heavy-duty slides. Check the weight of the unit to be

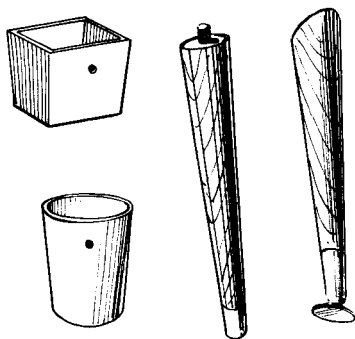
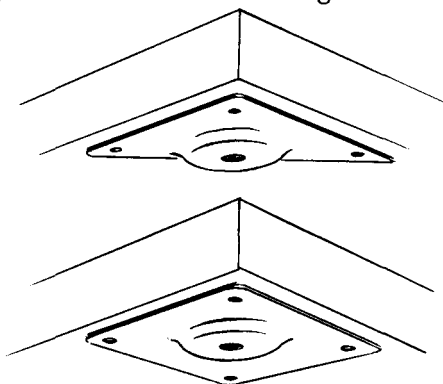

Fig. 529. Ferrules for wooden legs are available in brass. They are primarily designed for round tapered legs.

mounted in the drawer, and be careful to get slides rated to carry, say, at least 5 pounds over this weight.

Some slides are made for undercarriage mounting (that is, to

be used under the drawer) while others are made for side mounting between the drawer and the side of the cabinet. Usually, either is satisfactory (and they'll still work perfectly well) but, if you use a slide in a manner different from the one for which it was intended, you'll change its weight-carrying capacity. So when you check the loading capacity, be sure you know which way the slide is to be mounted to give that capacity.

Of the various types of door catches available, (Fig. 527) the most inconspicuous is the bullet catch. The only trouble with it

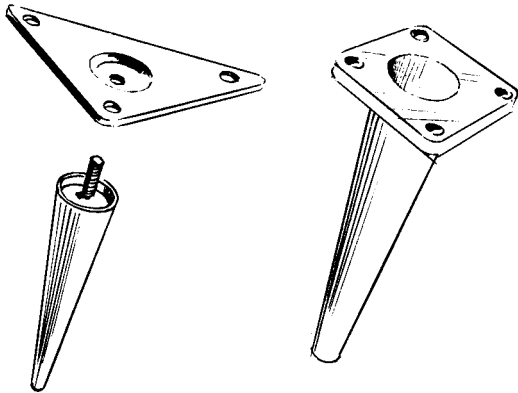

Fig. 530. An example of an all metal leg. Many types are available in brass, wrought iron or plated metal. Brass seems to be the most attractive material.

is that it's not too well constructed for the most part and sometimes tends to jam after its been in use for a time. You won't have this trouble with the spring-clip types, but they do show more.

A rather nice, recent innovation in this area is the magnetic catch. It consists of a magnet mounted in a carrier in the cabinet and a plate of ferrous metal mounted on the door opposite it. No moving parts, nothing to wear or jam. Very lovely indeed.

Castors (Fig. 528) are another item to which you have to give a second thought as to the amount of weight that is going to be placed on them. If you've got a unit that is designed for castors so that you can roll it around, be sure that you've left a good solid area in which you can attach the caster, and also that you use a large enough caster to handle the weight. Remember that the larger the caster wheel, the easier it will roll over carpets and minor obstructions such as door sills and the like.

The trouble is that by the time you've got a big enough caster so that it will roll easily, it's also big enough to be a trifle unsightly. You'll probably wind up having to make some sort of a

compromise between the size that would be functionally best and the size that would be esthetically pleasing.

If you want brass tips or ferrules on the legs of your furniture, you'll find a good selection available in round ones, but not much in square ones (Fig. 529). So if you're going to use ferrules, figure on using a round tapered leg. If you want to use a leg in metal throughout (Fig. 530), there is wrought iron, which has the advantage of being very inexpensive, but brass or brass plate is far more beautiful. In brass and brass-plated legs, sizes range from 3 to 30 inches in height, in round, tapered shapes either straight or angled.

A small number of straight square legs in brass are available, but not nearly the selection that you can get in round tapers. Also, a few decorative brass legs and some decorative brass feet are available for use with period designs.

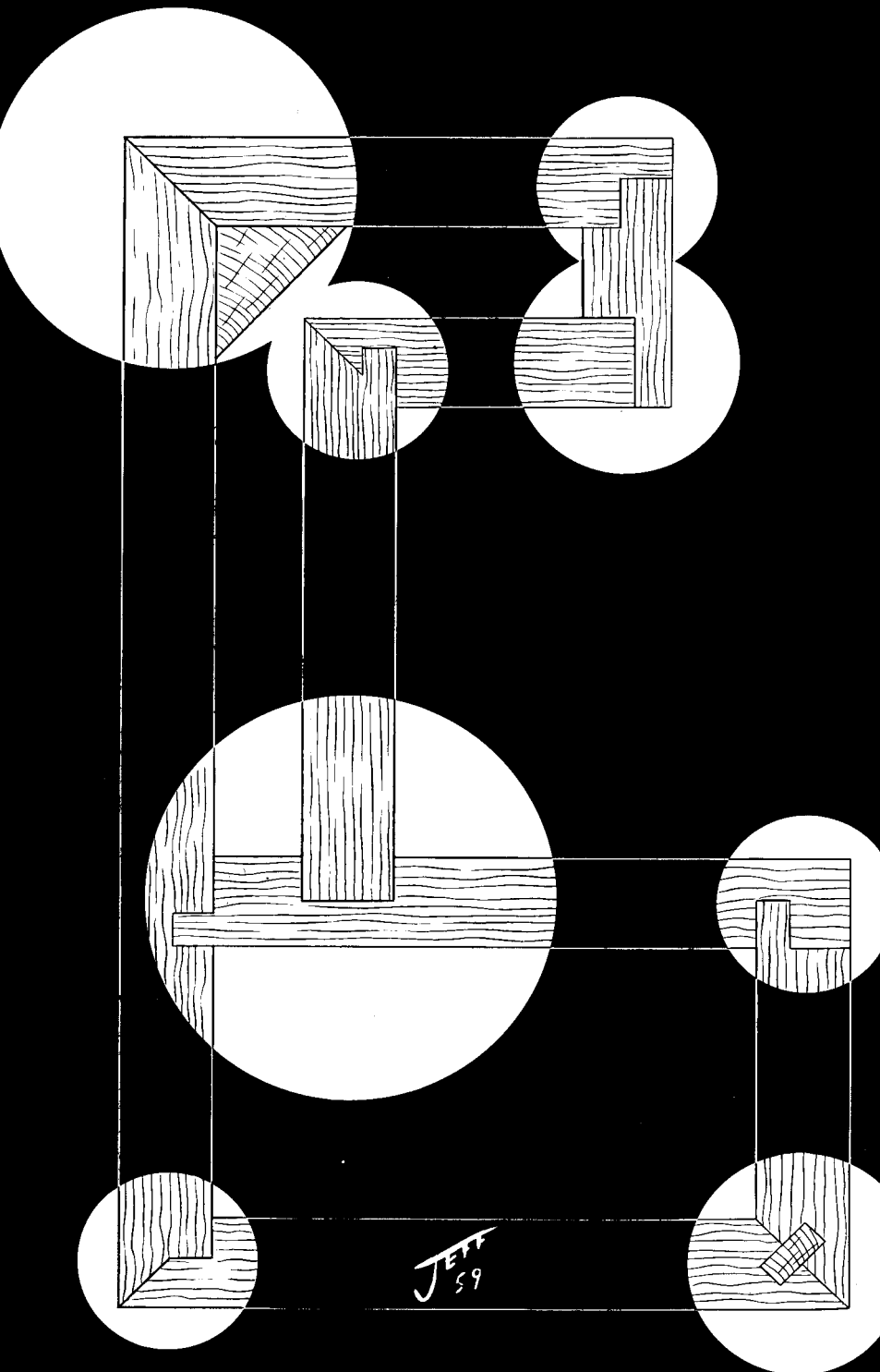

JEFF
59

CHAPTER 6

construction

WHETHER you build a cabinet yourself, turn the job over to a cabinet maker or buy it ready-made, it is best to know something about how furniture is constructed.

There are tricks in every trade, and to start a project without knowing about them is perilous at best. For those who want to buy, remember that some very pretty packages can conceal shoddy or mediocre products. By knowing how good furniture is made you'll be able to be sure that you get your money's worth.

Layout

Before purchasing materials, work out a cutting diagram. This is a miniature layout, to scale, of how you will cut the pieces of your cabinet from the large sheets of raw material. If you've bought a set of plans a cutting diagram is probably included. If not, or if you are starting from scratch, you'll have to make your own.

Consult your plans, and list every part required in categories according to the materials required. For example, some parts will be of $\frac{3}{4}$ -inch plywood, others, such as backs or control panels, may be $\frac{1}{4}$ -inch. Still others such as molding or legs, may be solid hardwood and you may require, in addition, some solid soft pine for cleats or glue blocks.

The parts for which a cutting diagram is normally needed are plywood. You need it to be sure that you have enough material for all parts, and to make economical use of your material. Too, the cutting diagram helps to keep the grain of the wood running in the right direction on each piece.

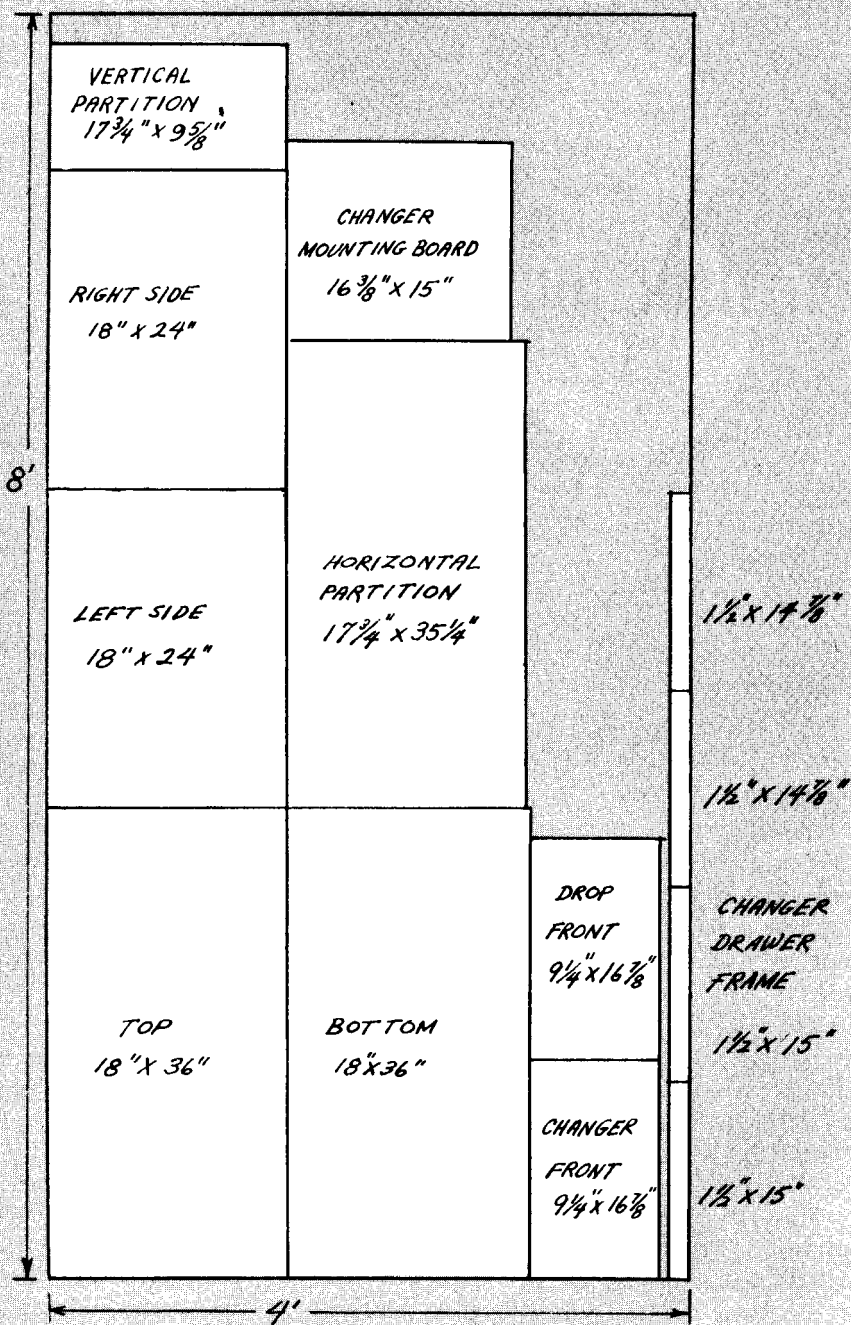

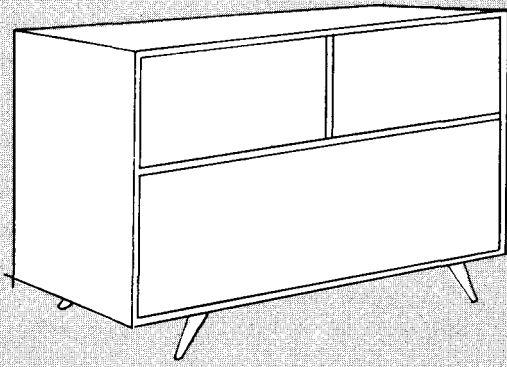

Fig. 601. *The final working or cutting diagram (shown on page 164 and above) is laid out on the plywood sheets.*

Cut pieces of paper to a scale of, say $\frac{1}{4}$ -inch to the foot, representing every piece of wood you'll need. Then lay them over a rectangle drawn to the same scale and representing an uncut plywood panel. Try a rectangle representing a 4×8 -foot panel first, since this is the most common stock size. For a big cabinet you may need more than one panel to get all the parts in and keep the grain running in the right direction. With a small cabinet, you can get them all in one piece with space to spare. In this instance try a smaller stock-size panel, 3×8 , 3×6 or 4×6 feet, and see if you can still get them all in. The smaller the plywood panel the less it will cost. Sometimes a set of parts that will not quite make it on one 4×8 -foot panel will go very comfortably on two 3×6 's. Try various combinations until you find the most economical arrangement.

Be careful at this stage to lay out every part with the grain running in the correct direction. The easiest way to keep track of grain is to put an arrow showing direction on each piece of paper representing a part of the cabinet. When making experimental layouts, be sure that this arrow is parallel to one of the long sides of the rectangle representing the panel. The grain on all plywood panels, except counterfront panels, runs parallel to the long sides.

Except in special graining effects, the general rule is that the grain shall run parallel to the longest dimension of a given piece of the cabinet. For example, it will run side to side across the top of a cabinet—not front to back. It will run top to bottom on the sides. However, grain may be either top to bottom or side to side on doors or drop fronts, depending on the effect desired and on

the proportions of the cabinet as they influence the proportions of the doors. On a door 2 feet high by 1 foot wide the grain will usually run top to bottom; on a drop front 3 feet wide by 10 inches high it would generally be side to side.

After experimenting with and repositioning the parts until you have located them on the panel diagram, finish your arrangement by either pasting the patterns to the diagram or drawing them in (Fig. 601). Be sure to label each individual part.

An experienced cabinet maker may not need to lay out all parts full scale on a panel before he starts cutting. But if you

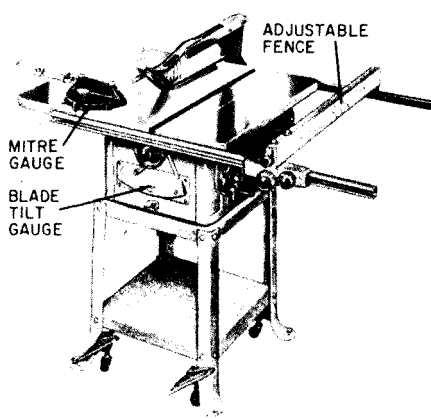

Fig. 602. *The table saw (tilting arbor circular saw) complete with adjustable fence and mitre gauge. (Courtesy Delta Power Tool Div., Rockwell Manufacturing Co.)*

haven't done much of this sort of work, drawing every part out full scale on the panel before starting to cut is essential for accuracy and economy. Remember to allow $\frac{1}{8}$ inch between the parts for the thickness of the saw cut. The pile of sawdust that will accumulate on the floor will no longer be part of your material. It has to come from somewhere!

Cutting

A hand saw is neither the best nor the most accurate way of cutting a large plywood cabinet panel. Machines do this kind of job better and faster.

Table saw

There are two kinds of cuts you may have to make: straight, and curved. For straight cuts, three methods are worth considering,

two good and one fair. The first and preferable method is to use a table saw. The saw (Fig. 602) consists of a circular blade with teeth set around its circumference. The blade is mounted under a heavy steel table in such a way that it protrudes up through a slot in the table top. It is rotated from below by an electric motor. Cutting with this type of saw is done by moving the work across the table top and past the rotating blade, which remains in a

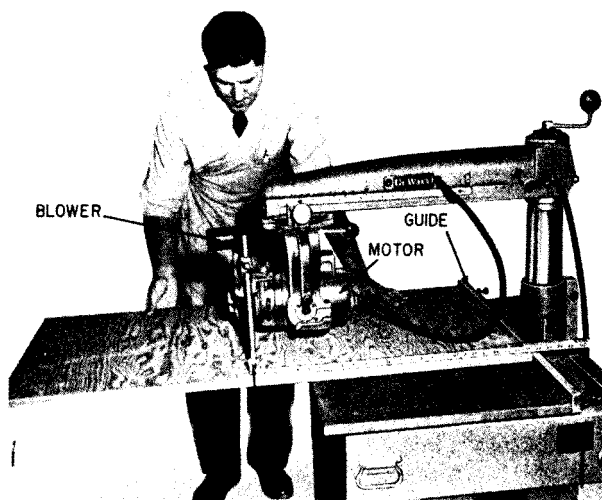

Fig. 603. *The swing saw is a useful and easily manipulated tool. (Courtesy De Walt Inc., Div. American Machine and Foundry.)*

fixed position. The saw blade may be raised or lowered, depending on the depth of cut required, and can also be tilted, allowing the cut to be vertical or beveled at any angle up to 45° .

To cut, say, a strip 16 inches wide by 8 feet long from a panel 4×8 feet, some sort of device must guide the work past the saw to keep the cut straight and maintain an even width. This function is performed by a "fence" mounted parallel to the saw on one side and adjustable to various distances from it.

A table saw is also equipped with a mitre guide for cutting various angles on the ends of narrow strips of wood. You would use it to cut the 45° angles on the ends of molding to make a frame, or to cut a 10° angle on the end of a stretcher before attaching an angled leg, or to cut off an angle at the top of the leg itself.

A table saw will cut only straight lines. You cannot cut curves with it. But straight-line cuts at all sorts of angles to each other can be made with the use of appropriate guides and jigs, and these

cuts can be simultaneously beveled at any angle up to 45°. Also, by proper adjustment of the saw-blade height, it is possible, instead of cutting through a piece of wood, merely to cut a groove in it. The width of the groove can be altered by the use of various dado blades.



Fig. 604. The portable rotary saw can be used for cabinet work provided a suitable guide and the proper blade are obtained. (Courtesy Porter-Cable.)

Use a table—or any other saw—only for the type of work for which it was designed. Any machine is safe when doing its proper work with proper safeguards. Improper operation can cause an accident to the user or the machine!

Overarm or swing saw

Also widely used to make straight cuts is the overarm or swing saw (Fig. 603). The swing saw has a circular blade similar to that of a table saw, but it operates differently—the table saw works from beneath the material to be cut, the swing saw cuts from above. The swing saw will handle long rips, cross cuts, bevels, dados and grooves just as accurately as a table saw. It will also do some jobs such as routing that cannot be done on a table saw. There is, however, one serious limitation to an overarm saw. The length of the arm limits the width of rips or cross cuts that can be made. (A table saw does not have this limitation.) It is one that is inherent in the design of an overarm saw, but there are ways of

working around it. You might, for instance, have to make a wide cross cut in two passes with a swing saw where you could have done it in one with a table saw.

Portable rotary saw

A portable rotary saw (Fig. 604) is really made for on-the-job carpentry, not cabinet work, but by using the right blade and feeding the machine carefully, it is possible to make a nice clean cut. The problem is to keep your cut straight in comparison with

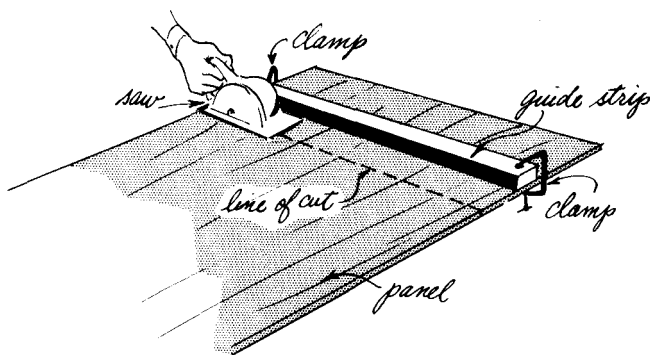

Fig. 605. A guide for the rotary saw is easily made from a strip of wood.

the cut you can get with a table or swing saw. It cannot be done by eye. Clamp a straight strip of wood to the panel to act as a guide for the shoe of the portable machine (Fig. 605). Be certain the guide piece is really straight; your cut can be only as straight as the guide.

Because of space limitations, the only practical way of cutting a large panel might be by use of a portable saw. If possible, however, try a table or swing saw.

Band saw

The saws mentioned thus far are designed strictly for straight-line cuts. But what happens if you need to cut a curve? For this you have a choice of three other types. The fastest and most powerful is a band saw (Fig. 606). Simply described, it consists of a pair of large pulleys or drums. One is placed above the other and a long continuous saw blade that resembles a belt runs around both drums. A small steel table is placed between the drums as a rest for the work, and the saw blade passes through the middle of the

table. The blade is narrow and made of very thin steel, permitting it to cut quite sharp curves as well as long flowing ones without binding the blade. The table is adjustable, making it possible to cut curves and bevels simultaneously, a feature that is often desirable. A band saw should be treated with extreme caution

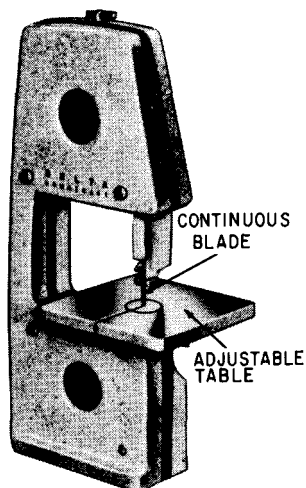

Fig. 606. The band saw is especially suitable for cutting curves. (Courtesy Delta Power Tool Div., Rockwell Manufacturing Co.)

and respect. Very fast and powerful, they can injure a careless operator before he is aware of what has happened.

Sabre saw

Another good machine for cutting curves is the sabre saw (Fig. 607). For cutting a long curve, say along the front of a cabinet top, it is slower than a band saw, but it is also much more compact, less expensive, and therefore much more likely to be available to the home craftsman.

The sabre saw is portable and cuts by means of a blade that moves alternately up and down like the movement of a hand saw, except that it cuts on the up instead of the downstroke. About half a dozen good makes are on the market, but only a few will simultaneously cut a bevel.

The smoothness and accuracy of a cut with this type of machine depends on how keen an eye you have and the steadiness of your hand. Practice on scrap wood before starting to do serious work.

The sabre saw is a fine tool for making the cutouts for the tuner and amplifier in control panels and for record players or tape machines in mounting boards. If you have any large ventila-



Fig. 607. *The sabre saw is another machine which is excellent for cutting curves. (Courtesy Porter-Cable.)*

tion holes to cut in your cabinet, the sabre is excellent for this purpose and it is also a fine tool for cutting speaker holes and ports in baffle boards.

Power jig saw

A third type of machine for curved cuts is a power jig saw (Fig. 608). Although they will make a nice clean cut, they are slow. Between sabre and power-jig saws, a sabre is preferable. A jig saw, however, will do the job.

Jointing

When your basic pieces of material have been cut to size, it is time to prepare the ends for the joints that will form the assembly. So let's look at the types of joints in common use, and see how

they are made. We will start with those that form the “basic case” —the top, sides, bottom and any *fixed* internal partitions.

Butt joint

The simplest method for joining two pieces of wood to form a corner is called a butt joint (Fig. 609). It is formed very simply by overlapping the end of one piece over the end of the other.

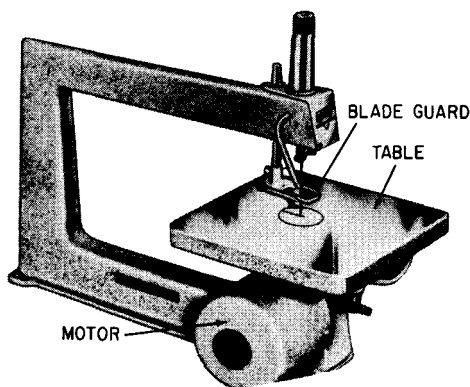

Fig. 608. Another useful machine for curved work is the power jig saw. (Courtesy Delta Power Tool Div., Rockwell Manufacturing Co.)

To have any strength at all this joint must be fastened, first with glue and then with screws or nails.

This is the simplest type of joint, but also the weakest. All that is required to make a reasonably tight clean joint of this type is a good straight smooth cut on each of the ends to be joined. No special machining is required. Ends satisfactory for butt joining can be done with very modest equipment, making this the joint of choice when facilities are limited.

The disadvantage of the plain butt joint, in addition to weakness, is that the entire end grain of the overlapping piece is exposed. It is impossible to finish this end grain so that it will conform to the lengthwise grain of the rest of the side. If veneered plywood has been used, the end grain can be particularly obnoxious.

Shoulder butt joint

A considerable improvement over the plain butt joint is the shoulder butt joint (Fig. 610). It is formed in the same manner as a plain butt except that the overlapping panel is notched to

receive the end of the other panel. As you can see, panel 1 now bears against two surfaces, forming an L in the end of panel 2, instead of a single flat surface. This considerably increases the strength of the joint and also improves the appearance since much less of the end grain of panel 2 is left showing. This joint is not really much more complicated to make than a plain butt. The

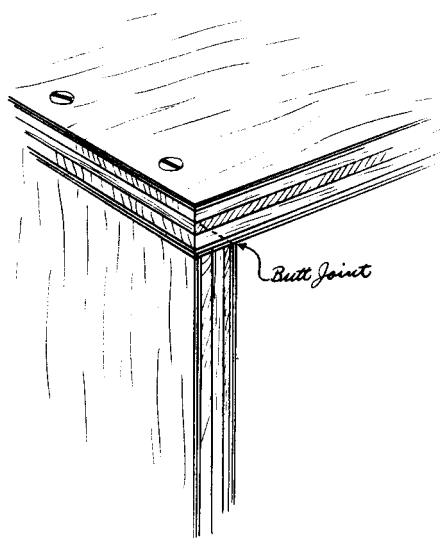

Fig. 609. *One of the simplest methods of joining wood is the butt joint.*

notches can be made on a table or a swing saw. They can even be made with a portable rotary saw since it is adjustable for depth of cut, but the problem remains of accurate guidance of the saw. Your solution will again be to clamp on a guide strip.

Double-shouldered butt joint

The next joint is not frequently used. It is a further variation of the shoulder butt, and could be defined as a "double-shouldered butt." (Fig. 611). The ends of both pieces to be joined are notched and are butted together with the notches interlocked. This joint has more strength than a normal shoulder butt since the pieces being joined bear against each other on three surfaces. However, it is not as popular as it might be, possibly because the notches in both pieces must be very accurate to form a good tight joint. Most constructors with skill and equipment adequate to handle

this joint can also handle mitres, and mitres do make a cleaner-looking job.

Mitre joint

The mitre joint involves cutting the ends of both pieces to be joined at a 45° angle and then fitting the angled surfaces to

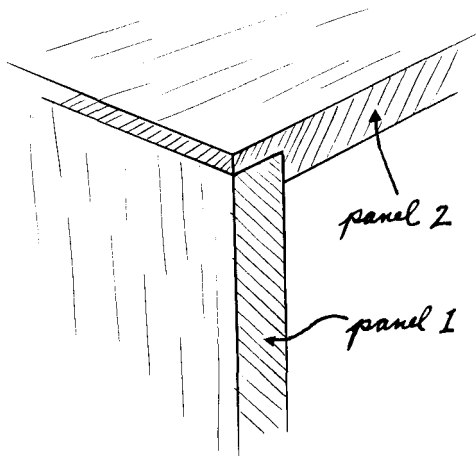

Fig. 610. The shoulder butt joint is stronger than the plain butt and makes finishing easier by eliminating much of the exposed end-grain of the wood.

form a corner. In good-quality furniture, variations of this joint are standard procedure (Figs. 612-a,-b,-c). The mitre joint can be strengthened or reinforced in several ways. The least effective is to add only glue blocks on the inside (Fig. 612-b).

Mitre and spline

Far superior to this is the “mitre and spline” variation. A spline of wood or metal is inserted to run down the length of the joint and at right angles to it. The spline is fitted in grooves cut in each piece before joining (Fig. 612-c).

A common variation of the mitre and spline is the use of clamp nails. These actually constitute partial splines, being inserted at each end of the joint and at right angles to it like a spline, the difference being that they run in only about 3 inches from each end.

All of the joints we have seen thus far can be made on either a table or a swing saw. However, for mitres a shaper (Fig. 613)

is preferred. A shaper consists of a steel table with a spindle sticking up in the middle of it. Various types of cutting knives can be attached to this spindle, and guides are provided for passing the work by the knives. The shaper leaves a much smoother surface where it has cut than does a saw; therefore, the mitres will be cleaner and tighter.

Lock mitre

Another effective variation of the mitre joint is known as a "lock mitre" (Fig. 614). The lock, of course, refers to the tongue-

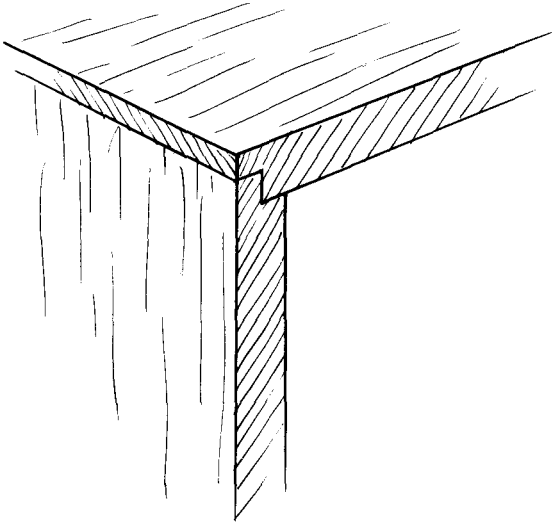

Fig. 611. The double-shouldered butt-joint, although stronger than the shoulder-butt, is not often used. Its complexity defeats its advantages.

and-groove arrangement inside the mitre. This joint is the strongest and the best of the variations, but to make it you need a shaper with special cutter knives. Don't try a lock mitre unless you have a shaper. However, if you are having a shop make your cabinets, try to get them to put your units together using this joint wherever possible.

Mitred shoulder butt

The last variation of the mitre joint is really a mitred shoulder butt (Fig. 615). It looks rather similar to a lock mitre except that there are two flat surfaces inside the joint instead of the tongue and groove. This joint is also best made on a shaper, but it can

be done with a table or swing saw. It is, perhaps, a bit more difficult to make than a mitre and spline, and is not quite as strong.

Not only the plain mitre, but also any of the other joints from

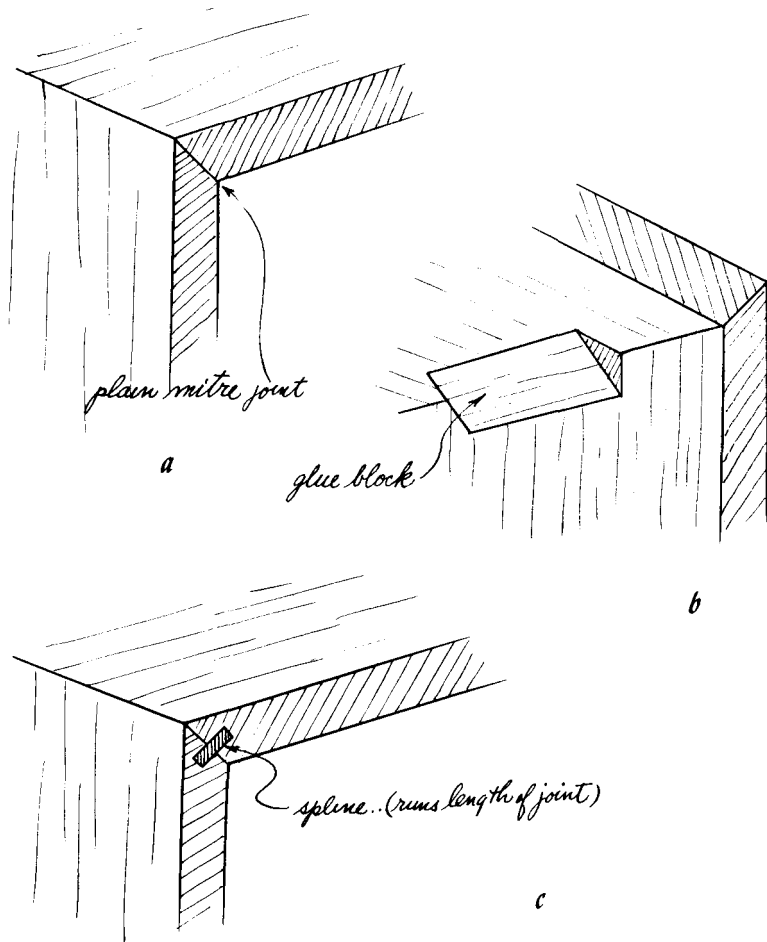

Fig. 612. The mitre joint and methods of reinforcing it: a) plain mitre; b) use of glue block; c) spline used to strengthen joint.

a plain butt on up can be reinforced with glue blocks on the inside. It is particularly advisable to do this in speaker enclosures as it will considerably improve the resistance of such joints to failure resulting from the vibration inevitably set up in the cabinet by the speaker.

It is possible literally to shake a cabinet apart, even a lock-mitred one, with speaker vibrations. To do this you would have to feed a pure tone of the right frequency into the speaker at a high level for a long time. You are not likely to do this, but it does illustrate the point that strains of a sizable magnitude are set up in a speaker enclosure. Internal reinforcing of the joints helps to extend the service life of the unit.

Partitions

So, you've enough joints now to make corners, but suppose the design calls for some fixed internal partitions such as shelves or

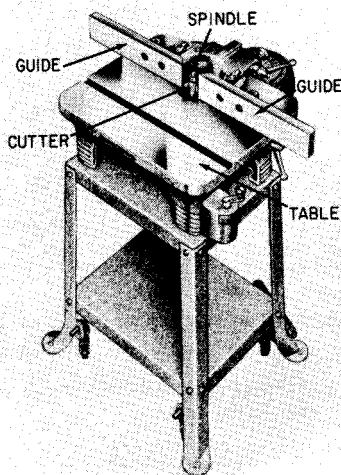

Fig. 613. *A shaper is an ideal tool for use with the various forms of mitre joints.* (Courtesy Delta Power Tool Div., Rockwell Manufacturing Co.)

record dividers. There are three common ways of installing such parts. The most obvious and again the least desirable is a plain butt (Fig. 616). No special machining beyond a smooth straight cut on each end of the partitioning piece is required.

There are, however, two better ways of fixing a permanent partition in a cabinet. In both cases dadoes are used (Figs. 617-a-b). Let us suppose we want to install a fixed shelf. One method is to cut a groove on the inside face of each cabinet side at the proper height, to a depth of about half the thickness of the side panels and of a width corresponding to the thickness of the

shelf. Assuming $\frac{3}{4}$ -inch plywood is being used, the grooves or dadoes in the sides would be $\frac{3}{8}$ -inch deep and $\frac{3}{4}$ -inch wide to receive the ends of the shelf. The dadoes can be cut on a table or

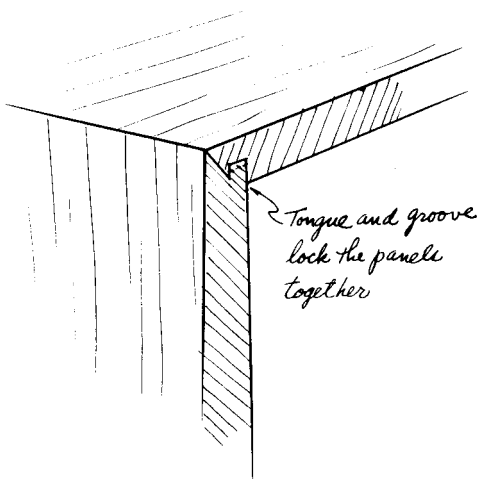

Fig. 614. The lock mitre is the strongest of the variations, but a shaper is essential if this joint is to be prepared properly.

swing saw or with a portable saw, and should be cut before any parts are assembled. Should it become necessary due to a change in plans to cut such grooves *after* assembly of the basic case this

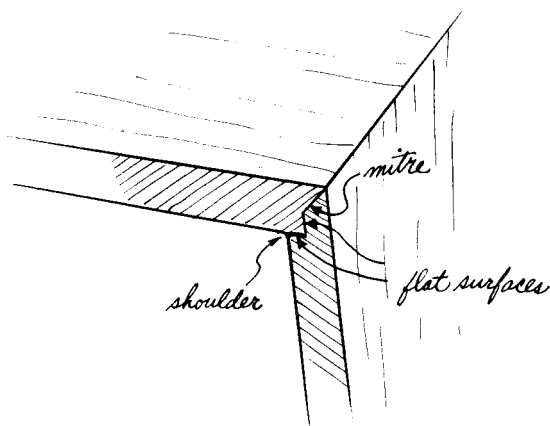

Fig. 615. The mitred shoulder butt is similar to a lock mitre, but is not quite as strong.

can be done by using a portable router (Fig. 618), which can also be used alternately on unassembled parts. This, by the way, is also an excellent tool for making tuner record player or speaker cutouts in place of a sabre saw since it will route curves as well as straight lines and is adjustable for depth of cut. It is, however, an expensive machine and, therefore, like the shaper, more likely to be found in a professional shop than in the home. If you should

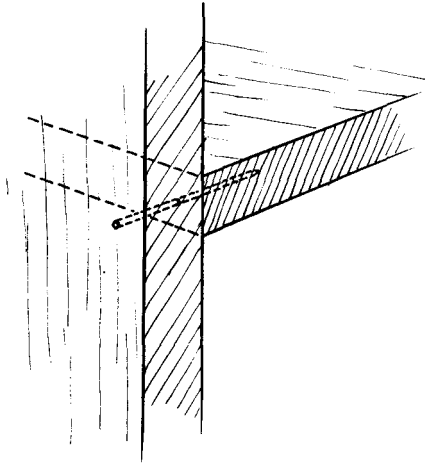

Fig. 616. Internal partitions can be fixed in place with plain butt joints. However, this is the least desirable method.

need one for a specific job, you could probably rent one by the day.

The dadoed shelf is vastly stronger than a butted one. With the full dado as described, only the cabinet sides are machined. The shelf need only be cut to the correct length. There is another method of dadoing a shelf or partition which involves machining both the partition and the cabinet. In this case the dado in the cabinet is only $\frac{1}{4}$ to $\frac{3}{8}$ -inch wide and $\frac{3}{8}$ -inch deep, and tongues are machined on the ends of the partition to fit. We are still thinking in terms of $\frac{3}{4}$ -inch plywood.

There is little to choose between the two latter methods as far as strength goes, except that the narrower groove weakens the cabinet side panels less. The wide groove method is less work, however.

Now you know enough joints to put the entire cabinet together by enough different methods to account for considerable variations

in available equipment. You can also choose the correct joint for any moldings. Whether you are planning to put a molding around a top or bottom or a frame around a front, you'll generally mitre it at the corners. In such places you would use a plain mitre. There is no need for splines or locks.

Except for a few contingencies you are quite well equipped. But suppose you wanted to make a frame with legs at the four corners

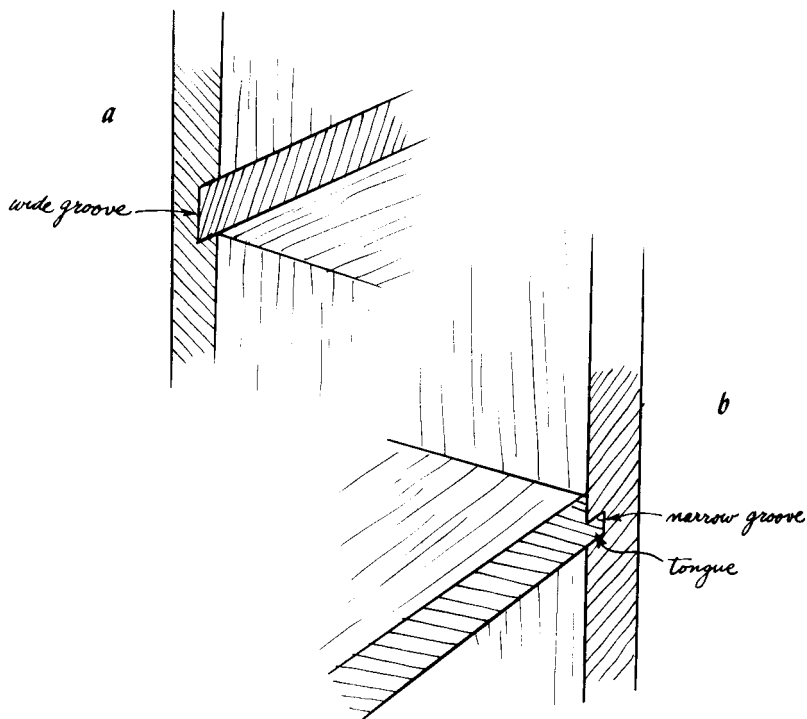

Fig. 617. Two ways of inserting a fixed partition in a cabinet: a) full dado; b) partial dado or tongue and groove.

to form a base on which to stand a cabinet, and the design calls for the legs to *be* the corners of the base. Or suppose you need to make a door of, say, American Colonial style that consists of a frame with an inset panel, and the corners of the frame are not mitred. They would both be handled by one of two alternate methods. One is a doweled joint, and the other is a mortise-and-tenon joint.

Doweling

Let's look at doweling first. It is the easier of the two. We'll say you want to dowel a stretcher to a leg to form a corner for a base. The stretcher is $\frac{3}{4}$ -inch material so you will need $\frac{3}{8}$ -inch dowels. Depending on the width of the stretcher, drill either two or three holes $\frac{3}{8}$ -inch in diameter and about $\frac{3}{4}$ -inch deep in the

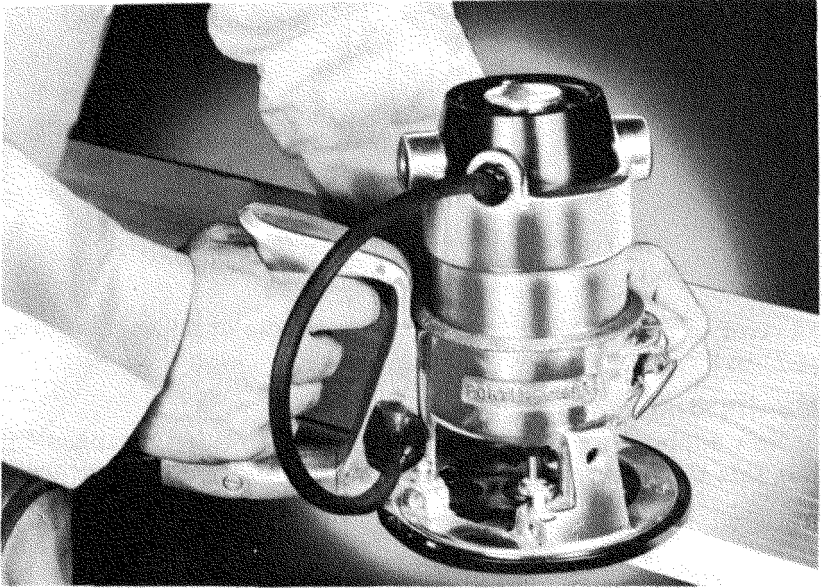

Fig. 618. *A portable router is useful for last minute shaping operations.*
(Courtesy Porter-Cable.)

end of the stretcher, and corresponding $\frac{3}{8}$ -inch holes in the leg. In a 2-inch wide stretcher use two dowels. If the stretcher is 3 or $3\frac{1}{2}$ -inches wide, use three dowels. Cut the dowels off to a hair under $1\frac{1}{2}$ -inches long, put glue in the holes in both stretcher and leg, insert the dowels in place so that they go through from the stretcher into the leg, and clamp the whole thing to dry (Fig. 619).

To dowel a door frame, the procedure is the same. Matching holes are drilled in the upright and cross piece, glue and dowels inserted, and the assembled frame clamped to dry (Fig. 620).

The real trick in doweling is to get the holes for the dowels in both pieces, say a stretcher and a leg, lined up exactly with each other. If the dowel holes do not match precisely as to size, location

and angle, assembly will be impossible. Unless you are a real Deadeye Dick, don't try to drill the holes with an unmounted hand drill. You'll think you are doing fine until you discover that

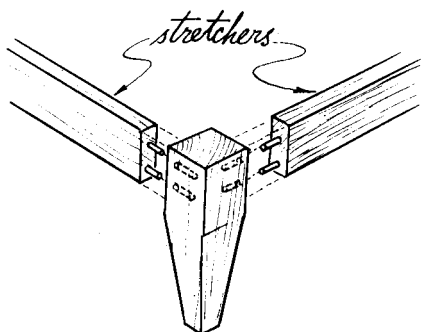

Fig. 619. Doweling is a must when assembling weight bearing structures such as the leg and stretchers illustrated.

an error of even $1/32$ -inch in centering a hole or an angular error of 2° to 3° is too much.

Mortise and tenon

Now suppose we take the same stretcher and leg arrangement, but this time the joint is to be a mortise and tenon. The tenon

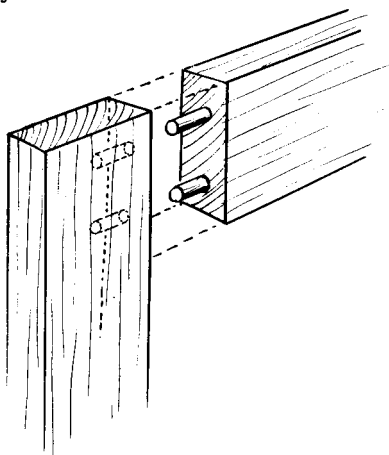

Fig. 620. Doweling a door frame follows much the same procedure as used in Fig. 619.

is a fancy name for a wood tongue that is cut on the end of the stretcher and is rectangular in shape (Fig. 621). The mortise is the matching rectangular hole in the leg and is cut with a special

mortising chisel. The tenon is glued into the mortise to make a firm joint. Occasionally, a locking pin or dowel is driven in at right angles to lock the tenon in place when a great deal of strain is expected.

The mortise and tenon must form a tight fit for the joint to have any strength, so they must each be cut very accurately. However, properly done, a mortise-and-tenon joint is stronger than a

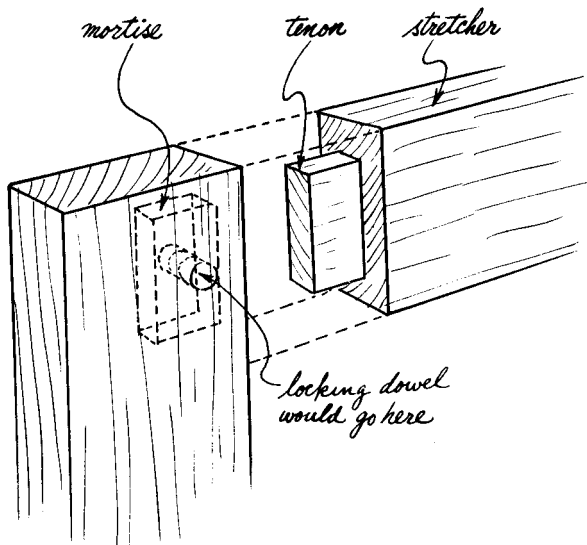

Fig. 621. The mortise and tenon joint, although a bit more difficult to handle, is much stronger than the doweled joint.

doweled joint, partly because a larger area of material is involved in forming the connecting linkage of the joint and partly because this same connecting piece needs to rely on glue on only one side of the joint.

Assembly

Up until now about all you can see to show for the work you have done is a pile of small pieces of wood where there were one or two big ones before. This is pretty uninspiring, but once you start to assemble you will see results in a hurry.

Assembly starts with the basic case; that is top, bottom, sides and any *fixed* internal partitions, either horizontal or vertical. For the moment forget the doors, drawers and other parts that are detachable from the main case.

The parts for your main case have been machined at the ends for whatever type of joints you want to use—buts, shoulder butts, mitre and spline or whatever. They've also been dadoed where necessary to take the ends of fixed partitions. Now place these parts in their proper positions relative to each other, and hold them in place with braces or tape while you make a trial assembly to see if your cutting is good, your joints fit well and your dimensioning was correct. If you did make any errors, this is the time when they will show up because the case just won't go together.

But let's assume that everything fits. You are then ready to glue the ends and make the assembly permanent.

Gluing

Here are a couple of tips in gluing. When two pieces of wood are to be fastened, glue should be applied to both. Putting a great slobber of glue on one piece and nothing on the other is not good practice. It tends to cause uneven spreading of the glue and, therefore, an unreliable joint. To get an even distribution, apply the glue with a brush uniformly over the surface to be joined.

Do not put on too much glue—a very common mistake. When you clamp for drying, the excess glue will come squirting out of the joint and get on your panels. Areas smeared with glue that has been allowed to dry will not take stain and, if you intend to leave your wood color natural, the glue may discolor it. A little excess glue should come out of a properly glued joint when clamped, but not much.

In the second place, a joint with too much glue in it is a *weak* joint. The strength of a glued joint comes from the combination and interlocking of the glue with the wood fibers. Glue alone, when dry, is a rather weak, brittle substance, so if a *heavy* layer of glue dries between two pieces of wood, the joint will be weakened.

Most glues penetrate better when warm than when cold. If they are very cold, they will not penetrate at all. When you heat glue, it will seem to thin out appreciably. This is fine, because it is easier to apply the kind of thin uniform coat that is desirable.

Glue sets well only under pressure. This means that, after the pieces are glued and joined the entire assembly should be set in clamps while the glue dries (Fig. 622). This is best done with cabinetmaker's pipe or bar clamps. The more clamps, the more uniform the pressure and the better the joints will be.

When the cabinet is clamped, check the corners with a carpenter's square to be sure that they are really right angles. If they are a little off, *now* is the time to correct them. If the cabinet is a little out of square, once the glue has set it will be that way permanently. This creates problems when trying to fit doors or drawers.

Fitting and edging

From here on, for a while, the sequence of events is dictated by the requirements of the specific design chosen. In one case

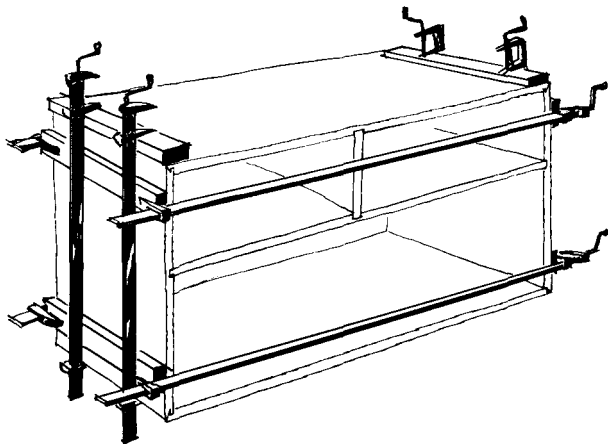

Fig. 622. Joints that are glued must be clamped under pressure so that the glue sets properly.

it may be necessary to do certain edging before it is possible to start fitting, while in another instance the fitting should come ahead of edging. Sometimes it is best to install at least part of the hardware, such as hinges on doors, prior to fitting. Only the constructor can figure out the proper sequence for each job after studying what is involved.

Edging is any form of veneer, stripping or molding used to cover the raw end grain of plywood left showing around, say, the front edges of the cabinet or the edges of doors or drawer fronts (Figs. 623-a,-b illustrate veneer and molding.). Edging may also be applied for purely decorative or styling reasons.

Except in speaker enclosures, where moldings are often used around the fronts as stops against which to press the speaker baffle boards from inside, edging has no structural importance. With few exceptions it is used purely for appearance.

On period styles the edging may take the form of elaborate decorative moldings that are often identifying characteristics of particular periods. Given a basic structure, the final overall appearance can be profoundly altered by variations in this kind of decorative detail.

Most edging, whether veneer, facing strip or molding, is applied in about the same manner. First, the end grain to be surfaced is carefully smoothed with a plane or sandpaper to eliminate any lumps or bumps that might prevent the edging from lying flat against it. (In a cabinetmaking shop, edges that will later need to be surfaced are run through a planer prior to assembly of the cabinet.) With the surfaces prepared, the edging is cut to the proper lengths, mitred for corners where necessary, then glued and clamped in place while the glue sets.

Facing strips and moldings are sometimes held with very fine wire brads in addition to the glue. After the brads are inserted the resulting small holes must be filled and sanded.

Always fit doors or drawer fronts prior to veneering the edges. If an edge is already veneered and must be planed to fit the door, the first thing you'll plane off is the veneer—in which case you've got to veneer it all over again.

Some methods of edging involve machining the end grain beforehand. One such method is the use of a V facing strip (Fig. 623-c). This type of stripping is triangular in cross-section and is glued into a V-shaped slot that must be machined into the edge of the plywood prior to assembly. This gives a very durable edge and eliminates the possibility of the ripples that sometimes occur with veneering. The method is, however, somewhat laborious and not recommended for the beginner.

Another method requiring premachining is the use of T-shaped facing strips (Fig. 623-d). Actually, this is sometimes done with facing strips and sometimes with moldings, but in either case the edging material has a tongue in the back that fits into a groove previously machined into the end grain of the plywood. This method increases the holding power of the edging very nicely.

Fitting is nothing but a series of minor adjustments to doors, drawer fronts, lids, control panels, baffle boards, backs and so on. Such adjustments account for minor variations in thickness or straightness in the panels forming the openings in which these various pieces are to be placed. Fitting is really a process of cut and try. With a drawer front, for example, you would mount the drawer on its tracks and the front on the drawer. Then just try

sliding it in and out to see if it fits. If it binds somewhere, find out where and determine whether the front should be realigned on the drawer or if it just needs to be planed off a bit. If it needs planing, take off very little at a time and keep trying it until it fits.

On occasion a drawer may bind, not because it doesn't fit, but because the drawer slides are a trifle out of alignment. Make sure this isn't the trouble before planing a door that doesn't need it.

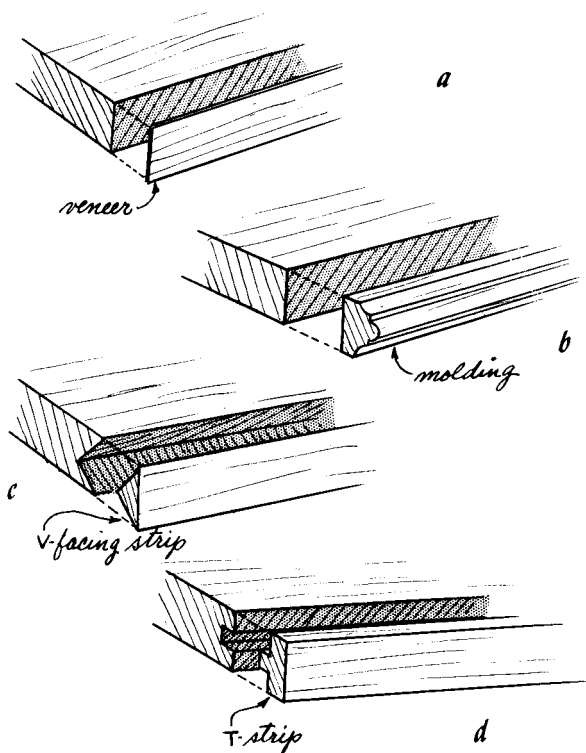

Fig. 623. Edging is available in a variety of forms: a) simple veneer stripping; b) decorative molding; c) V facing strip; d) T facing strip.

With doors or drop fronts, set in the hinges before your start fitting. They may have to be taken off again if the hinge side needs planing, but you won't get an accurate fit without them. With twin doors, hinge and fit one side first, then hinge and fit the other side to it.

Control panels and baffle boards need not be extremely accurate

(just as long as you can get them in and out) because they are usually covered by a molding in front. Be careful with speaker backs, however, to avoid air leaks.

Fitting isn't difficult nor does it require any great skill. It is, however, painstaking and time-consuming work when done properly, because one must be forever careful not to cut away too much. If you do and end with a loose fit, the part will function but it will not look right.

Hardware

A speaker cabinet is not likely to have much in the way of hardware. A decorative metal grille is not recommended because it

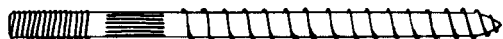

Fig. 624. *The hanger bolt is used to mount legs to the cabinet.*

often tends to rattle but, if one is used, it goes in after finishing and generally is mounted to the baffle board on top of the grille cloth. Leg ferrules also go on after finishing, to avoid smearing the metal with finishing materials.

Equipment cabinets are likely to require a good deal more in the way of hardware—knobs, catches, drawer slides, lid supports and so on. In addition to hinges, lid supports, slides and catches should be trial mounted during or after fitting to make sure they will align and operate properly. All these must be taken off again for finishing, but must be trial mounted beforehand so that, if you should get one of them in the wrong place and find yourself left with a couple of unwanted screw holes, you can fill and hide them in the finishing process.

Legs and bases

Now that the cabinet is built and the internal parts are all fitted and working properly, the job is almost done. All that is needed is something for it to stand on, and you'll be all set. You might have a cabinet design in which the sides come down below the bottom and form a base. If so, all that is necessary is to put four metal glides on the corners.

But in most cases either legs or a base are needed. Check thoroughly to see if there isn't a stock leg available that will satisfy your needs. Even the large commercial cabinet shops find it preferable to buy their legs rather than make them themselves. The chances are you will too.

Round or turned legs are made on a lathe, while square or square tapered ones can be made, with appropriate jigs, on a table saw. If you haven't a table saw, a square tapered leg can be made

Fig. 625. *The T-nut is a special fitting used in conjunction with the hanger bolt.*

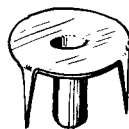

with a simple hand plane but, unless you are an expert, you might have a bit of trouble getting two to match, let alone four.

The question is, now, how to put legs on the cabinet. There are several ways of doing this. The most common is to drive what

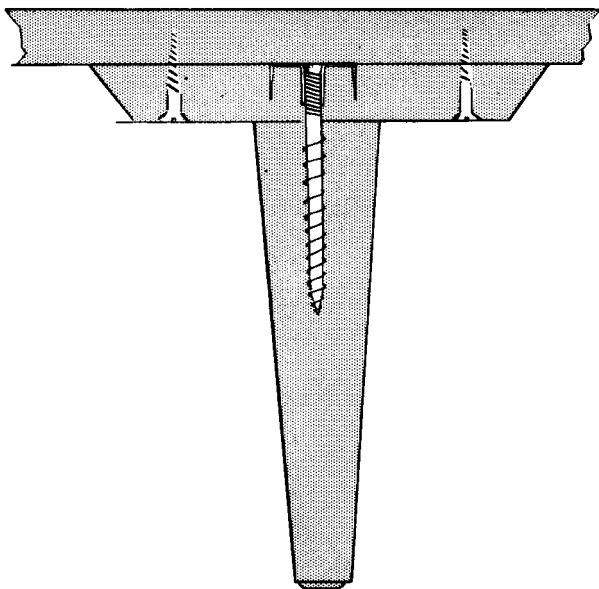

Fig. 626. *A mounted leg showing T-nut, wood plate and hanger bolt.*

is called a hanger bolt into the top of the leg, screw the hanger bolt to a special plate, and screw the plate in turn to the bottom of the cabinet. A hanger bolt is a device threaded to go into wood at one end and metal at the other. It has no head. An average one would be about $\frac{1}{4}$ -inch thick. The thread that goes into the

wood is similar to that on a lag bolt. The thread on the other end is a standard machine-screw thread (Fig. 624).

Ready-made legs may already have the hanger bolt installed. If not, be sure to drill an ample pilot hole in the legs before starting to drive the bolts, otherwise you won't get the bolt a half inch into the leg before it will split.

Although legs can be attached to either wood or metal plates, metal ones are more common. Several standard types are available, and it makes no difference which you use so long as you watch out for one thing. There is a plate made for angled legs, and another type for straight legs. Be sure, if you want angled legs, that you do not get straight-leg plates, or vice versa. There is also a type

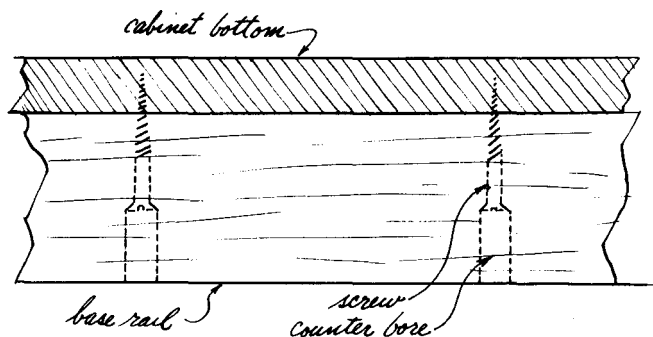

Fig. 627. Method of attaching a base to the cabinet.

of plate that can be used for either one. In this instance, put the leg into the correct end of the plate for the type of leg you want.

If for some reason you cannot get or do not wish to use metal plates, wooden ones can be made of 3- or 4-inch squares of scrap plywood. Drill a $\frac{3}{8}$ -inch hole in the center for the hanger bolt, and four clearance holes in the corners for the wood screws. A T-nut is used in the center hole. A T-nut is a metal fitting threaded on the inside to take the machine-screw-threaded end of the hangerbolt (Fig. 625). Tap this piece into the center hole in the wood block, with the threaded tube part down. Now run the hanger bolt on the leg up from underneath into the thread in the T-nut (Fig. 626).

A straight leg can also be installed with just a T-nut and hanger bolt, eliminating the plate entirely. To do this, drill the holes for the T-nuts directly into the bottom of the cabinet, install the T-nuts from inside, screw the leg and bolt up from underneath, and you are all set.

Legs can be held by merely driving long wood screws through a plate and down into the top of the leg. They have even been nailed. Neither method is very satisfactory. Stick to the hanger bolt. It is no great trouble and is more likely to be satisfactory.

Next, suppose you have a base. It may rest directly on the floor, or perhaps it is raised off the floor with legs at the corners. In any event it would be attached to the cabinet by wood screws from underneath (Fig. 627).

The only consideration here is to use the correct length of screws for the job. If they are too short, they will not go deep enough into the bottom of the cabinet to hold securely; if they are too long, they will come up through the bottom and into the inside of the cabinet.

The bottoms of either legs or bases should be capped with metal or plastic gliders to make movement easy and protect the floor. There are several varieties so pick the type and size suited for your unit. A glider should not be as big or bigger than the leg end. Generally, they are not supposed to show unless they are part of a ferrule, so select a size small enough to be inconspicuous.

Kit construction

You may have occasion to construct a cabinet from a kit, rather than from the raw materials. In such cases, all cutting, jointing and shaping operations will have been performed. You won't have to worry about what type of joint to use where, because the manufacturer has already taken care of this for you.

He will generally also supply you with a working drawing and an exploded view that will enable you to visualize immediately how the whole thing goes together.

Follow the manufacturer's step-by-step instructions. He has put several of these things together, and knows the best method. In working from a kit, you do not have any flexibility as regards varying the design, and you would be wise not to take any liberties. Build it the way the manufacturer intended, and you'll get good results. The finishing and retouching procedures, given in the following chapters, apply to kits just as they do to a cabinet that you have constructed from your own design.



CHAPTER 7

finishing hi-fi furniture

FINISHING hi-fi furniture involves the same processes as finishing any other type of good-quality furniture. It is no more difficult, but it is not one whit easier. If you know how to finish a bureau or a coffee table correctly you know how to finish a hi-fi cabinet.

There is more plain hard work involved in furniture finishing than there is technical knowledge or skill. The quality of the end product is directly proportionate to the amount of time spent sanding, polishing, rubbing and steel-wooling. There is no point in trying to think up ways to speed up or avoid these tedious jobs. They've all been thought of and tried—unhappily. Instead of spending your time scheming, spend it rubbing—the results will more than justify the effort.

One fellow summed it up neatly. Surrounded by brushes, paint, varnish, scrapers and so on, he was overheard murmuring unhappily, "I don't know why it is, but the minute I sit down nothing gets done." Some of the brute force needed can be alleviated by the proper use of power tools that can be rented if you do not own them. However, it's still a matter of elbow grease.

Aside from work, the most important factor in getting a good finish on a piece of furniture is the manner in which it is prepared. It is just not possible for the finish to be any better than the surface underneath.

We will assume now that the cabinet to be finished is completely assembled with all the required parts in place. In speaker cabinets this means that baffle boards and backs have been

fitted, speaker holes and ports cut. In equipment cabinets, drawers, lids, doors, drop fronts, slides, hinges, catches, etc. are all fitted and in working order.

This involves checking the fit of all moving parts. Make sure that a door, for example, does not rub anywhere as it closes. If there is the slightest hint of a door binding anywhere, take it off, shave it, then rehang and check it again.

When doing this final fitting, remember that in damp weather wood tends to swell a bit, so a fit that *just* clears in dry weather may bind when it gets damp. So if you're checking on a dry

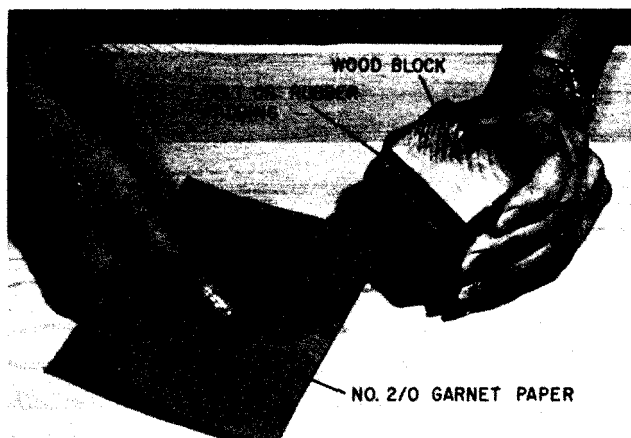

Fig. 701. When preparing large surfaces wrap sandpaper around a block of wood as shown. (Courtesy Grand Rapids Varnish Corp.)

day allow a little for swelling— $1/32$ inch around a door will be enough. It can be a fair-sized job to shave a door and retouch it after you've completed the finishing of the whole cabinet. This is the reason for the extremely careful check of fits before the finishing is started.

With everything satisfactorily fitted, take a look at the cabinet. Isn't it pretty? Fine! Now tear it all apart. Everything that can possibly be removed comes off. All doors, drawers, control panels, backs, lids, baffle boards, hinges, knobs, catches, slides and anything else that moves, comes off. Take out the screws very carefully so that you do not destroy the threads in the wood. You will want to put them all back in exactly the same places after finishing. Remember, the final check of the fit was made with hardware as it now is, so when you make your final reassem-

bly after finishing put each item back in precisely its present position.

If you have handled your materials carefully in the process of construction, you probably won't find any deep scratches or gouges in the surfaces. But there will be a lot of minor scratches. These are inevitable and must be removed prior to applying any finish. Also, the entire surface must be much smoother than it is as it comes from the lumber mill.

Sanding

Use a fine sandpaper from the beginning, somewhere between 0 and 2/0 garnet paper. The veneers are not very thick, and it

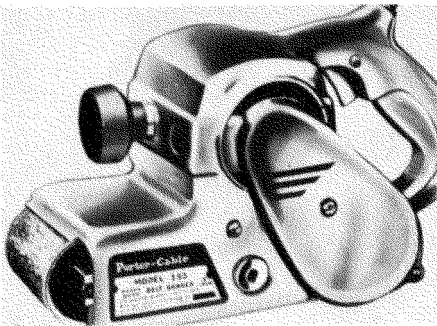
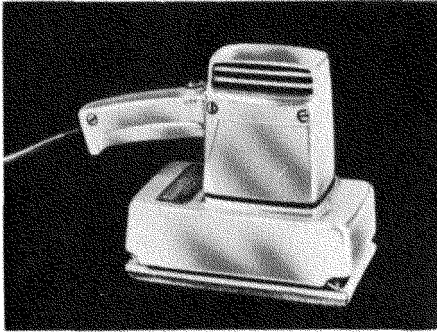

Fig. 702. Several types of sanding machines can be used in furniture finishing: an orbital sander (above) ordinarily cannot be used for final finishing; the belt sander (below) can be used for the final sanding. (Courtesy Porter-Cable.)

won't take much to go clear through. All you want to get off are the scratches. Always sand in the same direction as the grain, never across it. Wrap your sandpaper around a block of wood when doing large flat areas (Fig. 701).

To be acceptable, a sanding machine must have either a flat head on which an ordinary piece of sandpaper is mounted, or



Fig. 703. Curved and carved portions of the cabinet must be finished by hand. Do not use a sanding block. (Courtesy Grand Rapids Varnish Corp.)

it must be a belt sander. The flat-head types usually have an orbital motion. The orbital types are all right for preliminary

sanding, but should be followed by a final hand sanding with extremely fine sandpaper, about 4/0 to 6/0, to take out any little scratches that may be left by the orbital movement. With a belt sander even the final sanding can be done by machine, provided a belt with a fine enough grit is used (Fig. 702).

Curved parts such as moldings, turnings and beadings cannot be done by machine. They must be done by hand (Fig. 703). *Don't* put a sanding disk on your electric drill and try to use it for sanding furniture. If you do, the results will be appalling.

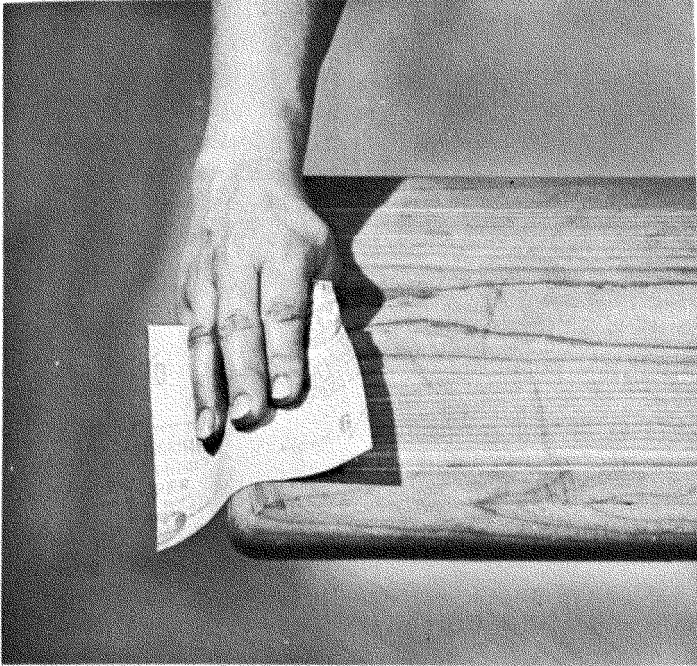

Fig. 703 (continued). *This photo shows hand-finishing of curved end using 6/0 sandpaper.*

In your final sanding be sure to go over *everything*; for example, the edges and backs of doors, the inside of a record changer well or the inside of record storage compartments. Anything that can be seen at any time is important, and the better this last sanding is the easier it will be to achieve a really good finish.

Inspect every square inch to be sure you haven't missed any nicks, scratches or rough spots. Supplement visual inspection by

running your fingertips over everything. Often they will find a rough spot that cannot be visually detected.

After inspection, if you are satisfied that you've done a good job, clean away the dust, and get ready to start applying the finish.

Precoloring

The first step is precoloring by staining or bleaching. Stain when you want to darken the color of the natural wood; bleach when you want to lighten it. If you want to leave the color of the wood alone, skip both operations and begin with filling.

Staining

A stain is a type of dye, and must be mixed in a liquid vehicle before it can be used. The three types are: water, oil and alcohol stains. Each has certain advantages and disadvantages.

Of the three the water stain is the most used. It penetrates well, is easy to prepare and goes on with good uniformity. There is one trouble with water stain, however. It tends to raise the grain of the wood a little, making it necessary to sand the piece lightly after staining to remove the "peach fuzz."

Oil stain does not have this fault. It will not raise the grain, but it does not penetrate as well. Its penetration is particularly poor on the denser woods with wide pore spacing, such as oak, but it is fine on softer woods with closer pores. Oil stain takes longer to dry than water stain, but it does eliminate the defuzzing operation.

For highly resistant woods, an alcohol stain is best. It has the highest penetrating power and is also the fastest drying. Due to its extremely rapid drying, it is more difficult to apply uniformly, but with a little practice on scrap wood this problem can be mastered.

The first thing to do when staining is to decide what color you want. Since a wide variety of prepared stains are available, you will find a satisfactory color without too much trouble. If you cannot, get one that is too dark and thin it, or get two that are close (one darker and one lighter) and mix them.

Any specific stain will have a different effect on each type of wood and their density and pore structure contribute to the effect of the stain.

This leaves you with the problem of finding out how a particular stain will affect a specific kind of wood. Apply some of the stain to scraps left over from the material used to make

the cabinet, and see what the result is. If it comes out too dark after it dries, thin the stain and try again. If it is too light, go back and get some darker stain.

Remember one thing however, when finally deciding the color of your stain. A piece of wood that has been stained only will appear a shade lighter than one that has been stained and lacquered. So if you are in any doubt about your stain, put some



Fig. 704. Wiping off an oil stain can be accomplished easily with a soft cloth or some cotton waste. (Courtesy Grand Rapids Varnish Corp.)

lacquer, shellac or varnish on a stained sample, and see what you get then. This is the only way to really see a final color in advance.

As soon as the color is settled, you've done the hardest part. The actual staining is easy.

In the case of water or alcohol stains just brush or wipe them on and let them dry. Be sure to allow enough drying time before moving on to the filling operation. Water stain can be a bit deceptive in this regard, particularly in humid weather, when it will sometimes feel dry when it is not. Under such conditions play safe and give it extra time.

Oil staining is a bit different but still very simple. An oil stain will be a fairly thick, gooey mixture. Brush or wipe it on with a rag, wait 5 minutes or so, and then remove the excess with cotton waste or cheesecloth (Fig. 704). The length of time an oil stain is allowed to penetrate will have an effect on how dark the stain will be, so do not work too large an area at one time, and try to keep the standing time about equal on the various parts. Remember, an oil stain takes longer to dry than either of the other two types. Allow it to dry thoroughly before moving on to filling.

Bleaching

Avoid bleaching. This is a pretty strong statement but it is the best policy to follow. If you want a light finish, start off with a blond wood—a lot of grief can be avoided this way.

Bleaching, even when it is done correctly, does not always result in a uniform color. The process cannot be trusted—it does not guarantee stable results in that dark streaks may later appear in a finish that originally bleached uniformly.

If for some reason you must bleach here is how you do it. Most bleaches consist of two different compounds that are to be applied to the wood, one after the other. These are standard mixtures available from finishing supply houses. The procedure is simple: Apply the first compound and let the piece stand for 15 or 20 minutes, then apply the second. After that, let the whole thing dry. At the end of the first stage the piece will have partially lightened, but you will not see the full bleach until the second mixture has been put on and dried.

After a piece has been bleached and dried, to remove the excess bleaching chemicals from the wood it must be *thoroughly* washed with a dilute solution of oxalic acid, acetic acid or a dilute solution of vinegar (about 1 quart of white clear vinegar to 1 gallon of water). The piece must again be thoroughly dried. It will also need a light sanding similar to the defuzzing after a water staining, and for the same reason. The water will have raised the grain.

Because the bleaching process is time-consuming and, in addition, tends to be somewhat unreliable as to results, most so-called bleached furniture commercially available isn't actually bleached at all. A simulated bleached finish is used. An opaque

Fig. 705. When removing the filler, work across the grain with a semi-circular motion. (Courtesy Grand Rapids Varnish Corp.)





DIRECTION OF GRAIN

CIRCULAR MOTION

or semi-opaque blond lacquer is first applied to the raw wood, after which the pores are filled with a toned filler. From there on, sealer and finish coats are applied, the same as for any other finish. The final finish closely resembles a true bleached one, but the process is faster and the results are more uniform and stable.

Filling

If you have not done any precoloring (staining or bleaching) of your wood, the finishing process will start here. If you have precolored, filling will be the second step. You literally fill in the little tiny pores in the surfaces of the wood. If unfilled, they show in the final finish as innumerable little pocks, practically impossible to eradicate. Filling is much easier!

A few very fine pored woods do not require filling—birch, maple, gum or beech, but walnut and the mahoganies need it as do oak, limba, primavera and most of the other woods you are likely to use.

Wood filler comes in a variety of colors. Choose the color that most closely matches the color of your wood. If the color you need in a filler is not available, tone one of the premixed ones with the correct stain.

Filler, which comes as a thick paste, must be thinned and mixed as directed to about the consistency of thick cream. When mixed, it can be either brushed on or wiped on with a rag. A generous coat is applied and allowed to stand until the surface “flats off” or starts to look dry. Wipe the excess filler with coarse rags or waste. Wipe *across* the grain to drive the filler into the pores of the wood, which is where you want it. This is the *only* time in the entire finishing process when you work across the grain. In every other operation work with the grain (Fig. 705).

After wiping, the filler should be allowed to dry for a minimum of 6 hours, or overnight. If it is not thoroughly dry when you start to apply the finish coats, it will pull out of the pores, and you will be no better off than if you hadn't filled the piece at all.

Pickling

This is similar to filling but not quite the same. It is most often done on oak or similar coarse-pored woods, although I can recall with some displeasure having seen it done to walnut. The procedure is to apply plain or toned white paint or white lead to the wood, and then wipe across the grain so as to leave the pores filled with the paint. Since the paint is more opaque

than filler, its effect on color is more pronounced. On oak, for example, it shows up as strong white streaks marking the pores. This is the well known limed-oak effect so popular a few years ago.

Sealing

The sealer is really the first coat of the final finish. The essential difference is that, since the sealer goes on over raw wood, it tends to be absorbed into the wood more readily than do later coats. Therefore, the material used for the sealing coat is about 50% thicker than that used for the final coats. Under a lacquer finish use a lacquer sealer; under varnish or shellac use shellac sealer. After the sealer has dried, sand it lightly with extremely fine paper, about 6/0.

Final finish coats

In commercial work the material used for final finishing is invariably either natural or synthetic lacquer applied by spray.

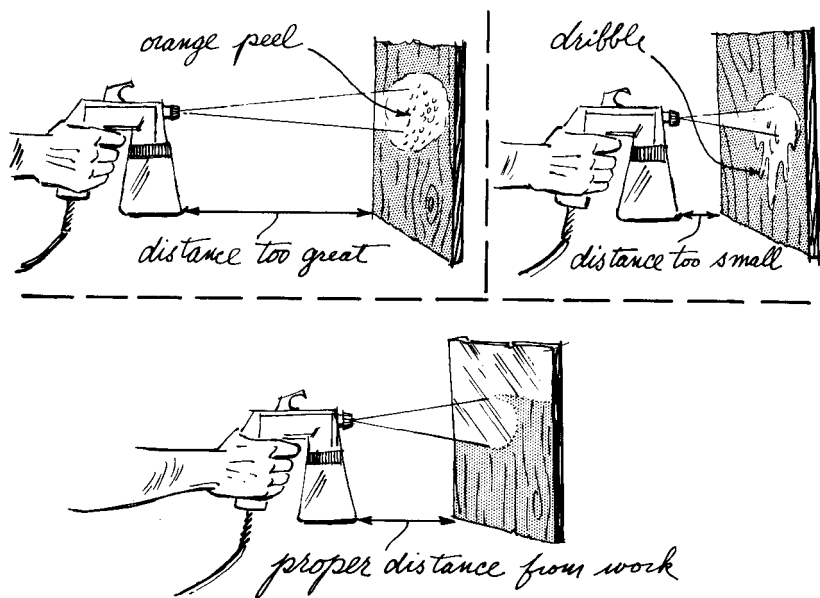

Fig. 706. A spray gun makes applying the finishing materials somewhat easier. However, skill is required when this tool is used.

Varnish is much too slow drying. Shellac, although rapid drying, is comparatively soft, and therefore leaves much to be desired in durability.

Where possible, lacquer is the choice for the home craftsman as well. It combines the advantages of both varnish and shellac, without the disadvantages of either. It has the durability of varnish combined with the rapid-drying property of shellac and, being a water-clear liquid, it has less effect on color than either.

If you are doing your finishing at home and have a spray setup available, practice with the gun on scraps first before starting on the cabinet. The two most common defects in spraying are "orange peel" and "runs." Orange peel is a type of rough surface texture resulting from either inadequate atomizing of the lacquer in the gun or from holding the gun too far from the work. Runs are caused by spraying too much lacquer on one area. The excess lacquer forms dribblets that run downward from the oversprayed area. They are both unsightly and difficult to remove. Fig. 706 illustrates the proper way to use a spray.

Another problem that sometimes arises in spraying is "blushing." This condition, characterized by the appearance of semi-opaque milky areas, is generally caused by excessive humidity in the air. When this happens, quit spraying and wait for a dry day.

Lacquer can also be applied with a brush. It will not go on as smoothly, but a little extra rubbing will make up the difference. Apply the lacquer sparingly to the brush and work rapidly because of the speed with which it dries. Do not brush over the same area repeatedly or you will cause laps and streaks. When applying one coat over another, it is even more important to work quickly lest the solvent in the second coat soften the first. Fig. 707 illustrates the technique used when applying lacquer with a brush.

As with spraying, a bit of practice makes a world of difference. Stay away from pressure cans for finish coats. The lacquer will be too thin for anything but touchup work.

If you haven't spraying facilities and brushing lacquer sounds too tricky for your first try, then switch to varnish. It has been used for centuries by the finest furniture craftsmen with excellent results. Much slower drying, it allows more working time but, for the same reason, it needs much more drying time between coats. You'll also no longer have to worry about working a second coat rapidly over a first. Once varnish has fully dried, its own solvent will no longer soften it, so there is no reason why you should not expect excellent results with it.

Shellac will not give the durability of either lacquer or varnish. Also be particularly careful not to let either water or alcoholic



Fig. 707. Technique used when applying lacquer with a brush: a) remove excess lacquer from the brush to aid in producing an even spread; b) apply lacquer in direction of grain. Note the proper way to hold the brush.

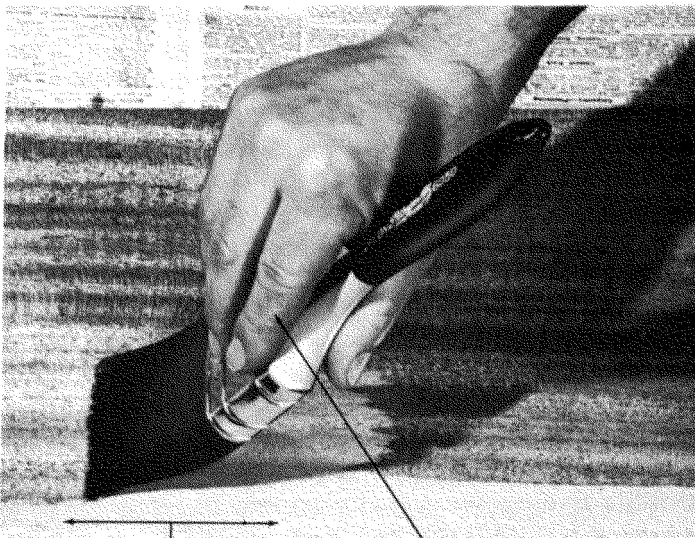

DIRECTION OF GRAIN

HOLD BRUSH BY FERRULE
FOR BETTER CONTROL

beverages stand on a shellac finish. Water will leave a white spot, while anything containing alcohol will simply dissolve shellac. The volatile oil in shellac is alcohol, and it is what is used to remove an old shellac finish. So wipe up that spilled martini!

One further word with regard to shellac. The usual commercial shellac is either a 4- or a 5-pound cut. This should be diluted practically 50% with denatured alcohol to thin it sufficiently for furniture application.

In furniture finishing a lot of thin coats are better than one or two thick ones. They will go on more smoothly, dry better and require less rubbing. Usually three coats on top of the sealer will be enough to build up a finish, but you might need more. The rule is; when in doubt, add another coat. It cannot harm and it can help.

Rubbing

For a plain gloss finish, you can stop after building up to final thickness, and eliminate rubbing. You can even use a flat lacquer or flat varnish for the last coat and obtain a flat finish without rubbing. Either one is adequate for large built-in wall installations, but for free-standing furniture to really look right it must be rubbed.

Many people prefer a matte or satin finish, others prefer a high gloss, but in either case the first step is the same. This consists of thoroughly rubbing over all surfaces. For *lacquer* or *varnish finishes* use a wet-dry abrasive paper dipped in a solution of soap and water to keep it from clogging. Minnesota Mining No. 400-A or equivalent is the paper for this purpose. The dipping in soap and water should be done repeatedly so that you are always rubbing a wet surface. The objective is to rub out all of the minute irregularities left by brush or spray. Rub with the grain, using a light even pressure. Check progress from time to time by wiping the surface with a clean rag. When you see a uniform surface with no little highlights or "hot spots," you are done (Fig. 708).

Remember—you cannot use water on shellac. For rubbing shellac, use ground pumice and oil. Pumice can also be used on the other two finishes if you would rather, or if you should have trouble finding the wet-dry paper.

After the first rubbing is complete, the final step depends on whether you want a satin finish or a high gloss. For satin finish,

go over everything again with very fine steel wool. Don't take your wife's scouring wool from the kitchen. It is *not* fine enough. Try to find some 4/0 or finer.

For a high gloss finish, get some furniture rubbing compound and rub until you get the uniform high gloss you want. If you have trouble locating furniture compound, try some automobile compound. It is almost exactly the same. If you are unable to find either, try rottenstone.

Retouch

The next chapter deals with this subject in detail, but it is appropriate to mention here some things you may find necessary to complete a new cabinet.



Fig. 708. *Rubbing is an essential feature of furniture finishing for matte or high-gloss finishes.* (Courtesy Grand Rapids Varnish Corp.)

If you have done a reasonably careful finishing job, any defects you will find now will be minor. In rubbing you may have here and there rubbed through the finish along an edge or corner. This is not an uncommon occurrence and shows up most on dark finishes in the form of a light line along the edge that has been rubbed through. It can be removed by touching over it lightly with a bit of the original stain followed by lacquer. A very small artist's brush is good for this purpose or you can use a small cloth pad if you are careful.

Another type of defect that you might find is a small nick or

dent that may have been in the wood before any finishing was done, and which was not previously removed. These can be removed by a process called "burning in." This method of removing such blemishes is given in detail in the next chapter in connection with treating nicks and dents on old furniture. For furniture new or old the procedure is the same.

Reassembly

Whether it is a speaker or an equipment cabinet you have just completed, some sort of reassembly is necessary. In the case of speaker enclosures, this may mean merely a baffle board and a back, but equipment cabinets may involve doors, drawers, lids, control panels and who knows what all hardware. Work slowly and carefully to be sure you are getting everything back exactly as it was when you completed the fitting. If you find that the threads in the wood have been stripped in a couple of screw holes, push a dowel into the wood ahead of the screw, then run the screw in. As the dowel expands, the screw will tighten in place.

Another reason for being careful now is that you do not want to drop or mar any parts since they are all finished. If you should damage anything, the next chapter will tell you what to do.

After the cabinet is reassembled, it should get a coat of hard wax as a protective measure before it is put into service. A number of hard wax compounds available contain a goodly percentage of Carnauba wax. One of these should be used at this point. The lighter liquid or self-polishing waxes are all right for later but they do not have enough body for the original protective coating.

Oil finish

No discussion of finishing would be complete without a mention of the oil finish which is widely used on walnut. It is also used extensively on teak. This type of finish results in an extremely matte, dulled surface which emphasizes the natural characteristics of grain and figure in the wood, and it requires that a high grade of material and workmanship have gone into the making of the piece. Where a normal full finish is applied, a good finisher can cover a multitude of minor defects in both material and craftsmanship that will show through an oil finish.

There are two ways of doing an oil finish. It is applied directly to the raw wood or over a filler. When filler is used, it is applied in the same manner as if a lacquer or varnish finish were to follow. Filling under oil will result in a sort of compromise

between the slightly raw effect of oil alone and a very dull conventional satin finish.

The oil used in an oil finish is linseed and is applied hot to improve penetration. Apply the hot linseed oil, let the piece stand for about 20 minutes, wipe off the excess oil and let the piece dry over night. This procedure is repeated about three times. An oil finish will generally take a reoiling once a month for 2 or 3 months, after which it can go 6 months at a time without attention.

An oil finish will darken with time so do not expect a newly oiled piece to match exactly an old one, even though the same species of wood has been used. Also do not expect an oiled piece to match a lacquered or varnished one. It will be a bit darker from the beginning and will darken a little more with time.



CHAPTER 8

retouch, repair and refinishing

PERHAPS you have an old TV, equipment or speaker cabinet of pleasing design that you'd just as soon keep, but time has taken its toll and the finish on the thing has become shabby-looking. Maybe it is scarred, nicked, scratched, or coming apart at the seams, but you still have a warm spot in your heart for the old warrior and would like to do something with it.

There is usually a great deal that can be done to brighten and refurbish the old vet, so let's investigate the kinds of defects likely in used cabinets and what can be done about them.

The common types of cabinet defects can be put into two categories: the first consists of various injuries resulting from use, wear and tear or transit damage. These, while occasionally serious enough to warrant discarding the entire cabinet, are usually relatively minor and rather simple to correct, although often they are unsightly. The second category comprises breakdowns or failures in the cabinet resulting simply from old age or from construction or finishing methods that were not what they might have been from the start.

Burns

Burns are one of the commonest of injuries (Fig. 801). About 99% of them will appear on cabinet tops, and about 98% will be cigarette burns. The ones along the edges of the top will be the result of parking a lighted cigarette on the edge of the cabinet. The ones in the middle of the top are generally caused by a lighted cigarette falling out of an ashtray.

Burns are easy to detect—they'll pretty much shout at you. Ranging from a small discolored spot to a large blackened area at least 2 inches long and $\frac{1}{2}$ inch wide, the size is the clue as to how much trouble it will be to repair the damage. Though a burn may appear superficial, when you start to scrape away the charred material you may have to go a lot deeper than you anticipated to get all the scorched wood out.

There are two ways to treat a burn, but the first step for both is scraping. All of the charred material, both finish and wood,

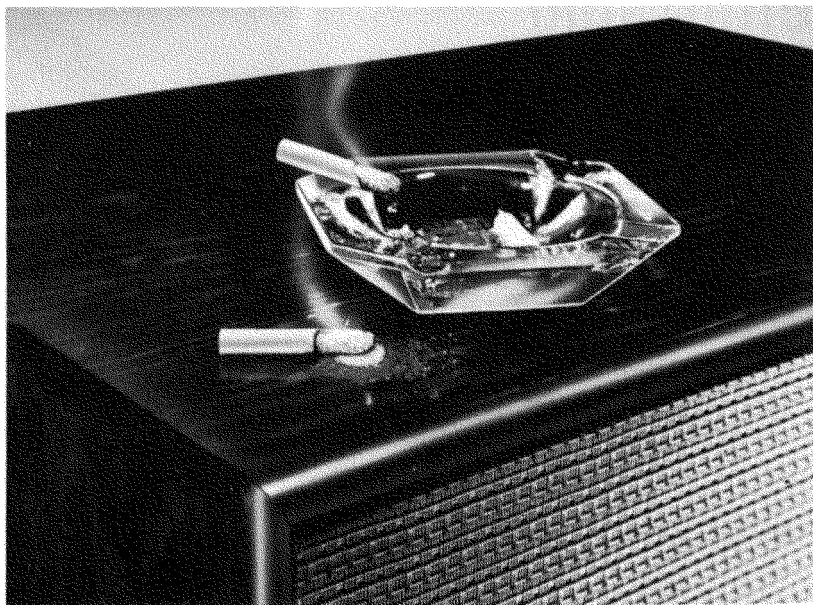

Fig. 801. *Most cabinet burns are caused by cigarettes.*

must be removed. Do the rough work with a sharp knife—a paring knife with a curved blade, a jack knife or a curved Exacto knife is good.

When you have removed all of the burned finish and scraped out all the blackened wood, smooth the spot with very fine sandpaper, 2/0 to 4/0, and stain it to match the surrounding area.

Now you have to decide which way to retouch, and this decision is based on how deep a hole there is in the surface after scraping. If the depth of the scraped-out spot is $\frac{1}{8}$ inch or less, use what is known as French polishing. Make a small pad of cheesecloth or gauze about $1\frac{1}{2}$ inches square and about 20 layers thick. Wet this

pad with white shellac and squeeze out the excess so that the pad is soggy but not dripping. Then pull up the four corners in your fingers to make a round-ended pad and apply three or four drops of linseed oil. With a brisk motion rub the shellac into the affected area. At first apply very little pressure, but after a few seconds the shellac will start to harden and you can rub with about the same pressure used when polishing hard wax. Keep repeating this process, working shellac into the burned area and around the edges until it is built up level with the rest of the top. When you

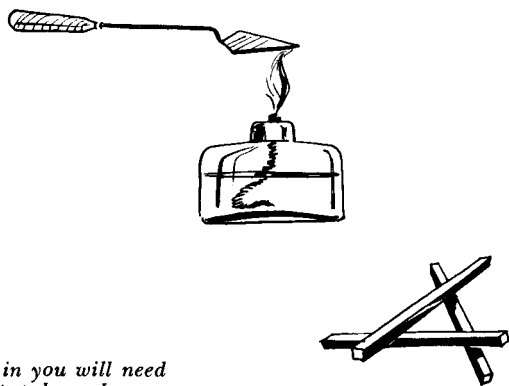

Fig. 802. For burning in you will need an alcohol lamp, a spatula and some shellac sticks.

are done, the spot you have been doctoring will be glossy. If the rest of the piece is satin-finished, dull the repaired spot with either extremely fine steel wool, 4/0, or pumice.

French polishing is fine for a shallow burn, but what do you do if you've got one that is deep, $\frac{1}{8}$ inch or more? After the burned area has been scraped, sanded and stained to match the surrounding color, do what is called "burning in." For this you need the following equipment: an alcohol lamp, a small flexible spatula (a light, springy artist's palette knife would be excellent) and a shellac stick, either transparent or of a color to match the piece under repair. (Fig. 802).

Heat the palette knife over the alcohol lamp. By touching the heated knife to the shellac stick you will melt a small amount of material so that you can place it in the hole to be filled. Repeat this process, filling the hole a little at a time until it is level with the surrounding area. Be careful not to overheat the knife as this will cause the shellac to burn creating carbon that will smudge the repair. All that is needed is enough heat to melt a little of the shellac stick at a time. When the hole is filled, use the heated

knife to smooth the surface around the edges (Fig. 803). Again be careful not to overheat the knife or it will blister the surrounding finish. Complete the smoothing operation by sanding lightly with the finest possible paper, about 4/0 to 6/0, and top off with French polishing, or rubbing with steel wool or pumice to conform with the surrounding texture.

Water and beverage stains

These will appear as opaque or semi-opaque milky areas, generally on cabinet tops (Fig 804). They may be in the form of rings left by the bottoms of wet glasses, or as irregularly shaped areas caused by spilled beverages that were allowed to stand.

There are two ways to remove white spots. One is by rubbing them, and the other is by chemical action. Since such spots do not



Fig. 803. Burn holes can be filled with shellac.

generally penetrate through the finish, it is best to try rubbing them out first.

On a dull finish, use very fine steel wool and oil; on a semi-gloss finish pumice and on a high-gloss finish rottenstone. Merely rub the spot with the appropriate abrasive until it disappears.

If rubbing doesn't seem to affect the spot much, then switch to a chemical treatment since the spot is apparently fairly deep. The danger of chemical methods is that, if the chemicals are too strong or are left on too long, they'll take the finish off the area entirely.

One method uses ammonia. Dampen a soft rag or cheesecloth with ammonia, then wring the pad as hard as you can. Now, *very* gently, quickly and lightly brush the ammonia across the white spot. For bad white spots on lacquer finishes, do the same thing with lacquer thinner. Remember—work quickly and lightly lest you take all the finish off along with the spot, in which case you've got a job of French polishing to do to put the finish back on.

Scratches

Little ones, big ones or both, scratches can be found on every used piece of furniture. In many cases the primary trouble with the appearance of an old cabinet is a myriad of little scratches which, all added together, give it a terribly dull, defeated-looking

appearance. Most of them can be removed easily and rapidly.

Rubbing with 4/0 steel wool, pumice, rottenstone and oil, furniture or even automobile-rubbing compound, depending on



Fig. 804. Beverage stains will appear as rings or milky areas.

the amount of gloss desired in the final result will remove most scratches.

Where you are doing a routine polishing job, don't even try to get *all* the scratches out. You'll get most of them with a brief rubdown and you will get the effect you want—appreciably brightening the appearance of the cabinet without a lot of work.

For a dull satin finish, use steel wool; on a semigloss use pumice and oil or pumice and water. For a high-gloss finish, use furniture rubbing compound. If you can't find this, use automobile rubbing compound. It is just about the same. If you cannot find either, use rottenstone and oil. The high gloss is, of course, the most exacting finish to clean because it will show much finer scratches than either of the others.

When you are through rubbing the scratches, go over the whole piece with a good-quality furniture polish to complete the job properly.

In many cases you'll find that by rubbing only the top and then

applying furniture polish to the entire cabinet, you will get the desired effect. Far and away the largest proportion of scratches will be on tops.

In cases where you really want to get out all the scratches and some deep or stubborn ones will not respond to rubbing alone, you will have to French polish and then rub.

Nicks and gouges

These, or course, result from the dozens of ways in which a cabinet can be hit or scraped, either in transit or in use around the house. The simplest of them will require more labor to repair than scratches, and they can be big and deep enough to be impossible to repair completely. If they are really big, you can reduce the unsightliness considerably, but don't give anybody the idea that you can make them disappear entirely.

All deep depression injuries require the same treatment. The first step is to clear away all loose splinters and chipped finish in and around the area. Stain where restoration of color is required and proceed to burn in with an alcohol lamp, spatula and shellac stick as previously described. Where possible, use transparent rather than colored shellac sticks for burning in, since the transparent type allows grain and color to show through, making a better match with the surrounding area.

After burning in, finish by smoothing and polishing as with other types of injuries.

Crushes

Crushes usually are due to transit damage and most often result from a cabinet being dropped on a corner. Like deep nicks and gouges, they can generally be vastly improved but cannot always be repaired completely. One word of caution: When you see a crushed corner examine the joint alongside the damaged area and the other joints. Make sure that none of them have sprung and started to open. If they have started to go, then the structure of the entire cabinet is in serious trouble and it may have to be discarded.

Crushed corners or edges are another type of damage treated by the use of shellac stick and burn-in. Particularly in the case of a crushed corner, you'll have to use your judgment as to how far to try to rebuild it. It is usually inadvisable to try to build a badly crushed corner back to its full original shape, since the resulting corner would be fragile and consist entirely of shellac. Build bad crushes back, say $\frac{1}{4}$ inch or a bit more, and stop there.

The damage won't be completely hidden, but it will be much less obvious and the repair will be more likely to stay in place.

Loose or broken hardware

This category includes a collection of miscellaneous problems—hinges that are wobbly due to loose screws, hinges bent out of shape, bent lid supports that won't open or won't support, door catches that won't catch, drawer slides that won't slide, and so on.

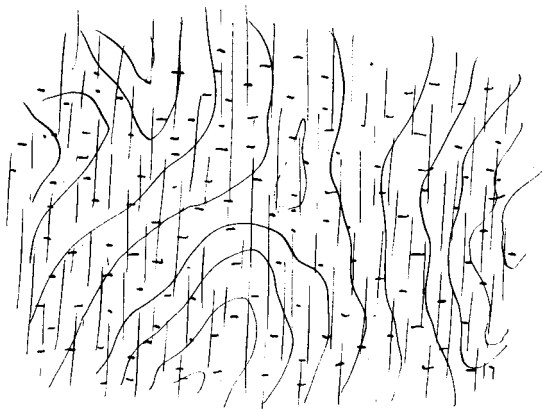

Fig. 805. *Excessive vibration can cause a finish to craze.*

Some of the trouble that arises from these causes is secondary in the form of scratching and scarring due to continued use of the cabinet after the hardware has become defective.

As a general rule, the best thing to do with bent or broken hardware is to take it off and replace it. A bent or broken hinge, catch or lid support will never be quite right if you try to repair it. On an original antique piece with antique hardware that cannot be substituted you have no choice but to attempt to repair it, but otherwise don't waste your time.

One of the most common troubles with hardware will be not that the hardware itself is damaged, but merely that the screws holding it in position have stripped their threads in the wood and loosened. Rather than replace with larger screws that may not fit the hardware it is better to remove the screws, fill the holes with plastic wood and while the plastic wood is still soft redrive the screws. *Caution:* Drive only until the screw heads are flush—no more, or you'll pull the plastic wood right back out. Give the plastic wood time to set, and you'll find the hardware is tight again.

Cracked, crazed or alligatored finish

These terms denote various types of deterioration found in aging finishes, although occasionally these conditions may appear on a relatively young piece of furniture. For example, a cabinet subjected to considerable vibration, such as a speaker enclosure, may have a tendency to craze before it is very old (Fig. 805). Cracks in the finish can be depended upon to occur over any cracks or

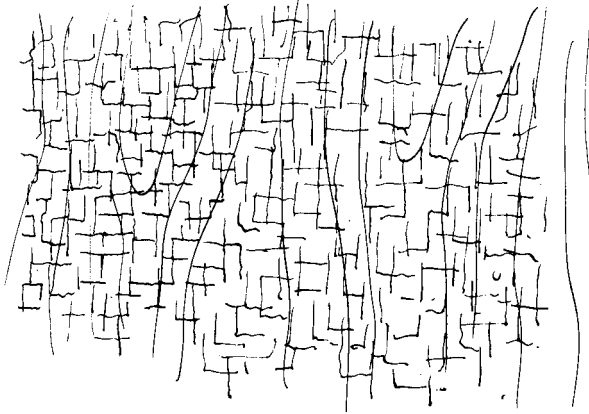

Fig. 806. Alligatoring is usually found in the finishes of old cabinets.

checks in the underlying wood. Alligatoring is so called because the finish crazes in a pattern similar to that of alligator skin. (Fig. 806). It is usually a disease of old age. You have probably seen it on old pianos. From time to time it can occur on a relatively new piece of furniture if the finishing was done in too cold a room.

With any of these conditions you may want to take a long pause before deciding whether to try to repair the finish, strip the old finish off and refinish or throw the whole piece in the fireplace. A moderately crazed finish can sometimes be restored by the use of 50-50 mixture of linseed oil and turpentine plus a good deal of elbow grease. There are also commercially available scratch-fixing and crack-eradicating mixtures that will often work wonders on crazed or cracked surfaces. Also an overall French polishing will often do the trick. It's a lot of work, but it can give you a lovely-looking surface on a piece that has become a dismal mess.

In the case of an alligatored finish a combination of treatments first with crack eradicator and then French polishing may remove them. But if the alligatoring is very bad, your best solution is to strip the whole thing and refinish, or discard the cabinet.

Grille cloth

A very common cause of shabbiness in a cabinet that is basically sound and in good condition is a baggy or torn grille cloth. To make the cabinet look miserable the cloth need not necessarily be ripped, frayed or even pulled loose. It may merely be dirty and discolored. Grille cloth is not expensive, particularly considering how much the replacement of a tired one can do toward sprucing up the entire appearance of a cabinet.

Loose, peeling or blistered veneer

Veneer will most often start to peel or loosen along an exposed edge, a place where atmospheric dampness can get in under it (Fig. 807). The most common places will be along the back edge

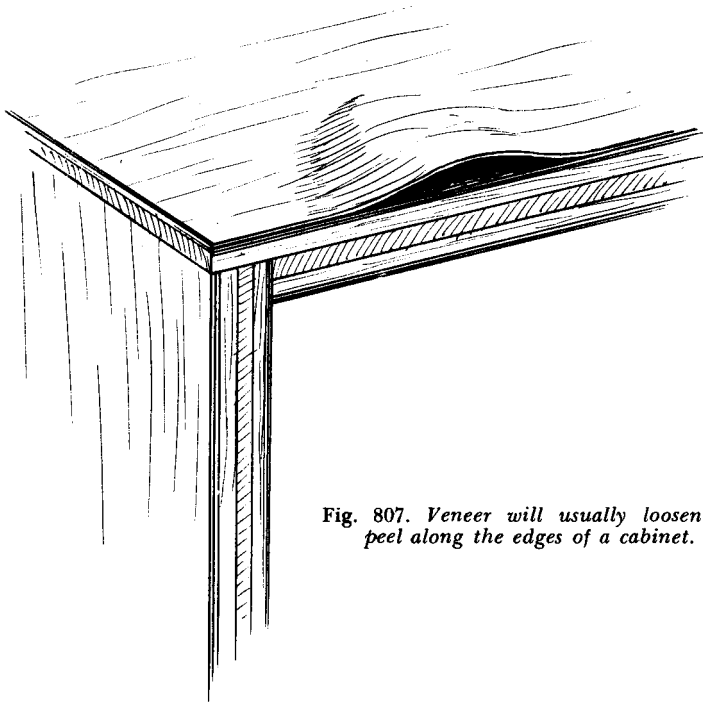

Fig. 807. *Veneer will usually loosen or peel along the edges of a cabinet.*

of the top or sides, along the bottom edge of the sides or along the hinge sides of doors. A good preventive for this is to seal such edges thoroughly with lacquer or varnish. Once they have started to peel, of course, it may be too late. However, if they haven't gone too far, they can be repaired, after which it is a good idea to seal the edges thoroughly to prevent a recurrence.

If the veneer is loose for lengths of 2 or 3 inches, but is still all there, you can repair it. But if a major area of a side or top got thoroughly soaked and the veneer is checked, blistered and loosened up over a large area—don't even try.

A small area of loose veneer can be easily corrected by forcing some glue in under it, using either a brush or a squeeze bottle. Apply pressure to hold the veneer tight against the core while the glue sets. This can be done with clamps or by resting the entire weight of the cabinet on the affected side. If you use a squeeze bottle, be careful not to get too much glue in. It will come squirting back out when you apply pressure.

In the occasional case of a panel on which the veneer has stayed tight around the edges but has blistered somewhere toward the middle, you've got quite a tricky situation. It does not usually respond well to treatment. However, you can take an extremely sharp, thin-bladed knife and make a slit through the veneer running lengthwise with the grain right down the center of the blister. Now, holding down one side of the blister with your finger, squirt glue in under the other side, then repeat the process in reverse. Next, take a little roller and roll the glue from the center line where your cut is and where you squirted in the glue out toward the edges of the blister underneath the veneer. When the glue is well distributed, apply pressure, allow the repair to dry, and see what sort of results you've got. If you were able to get the glue thoroughly distributed under the blister, it will take well. If not, you may find a half dozen little blisters instead of one big one. That is the chance you must take in trying to meddle with the thing. The cabinet was probably useless as it was so you will not have done any real damage.

Open joints

If a cabinet is cracking open along a joint and hasn't been dropped or abused, the cause is either that time and humidity have set up warping stresses in one of the panels, causing them to separate along a joint. Or else the glue has dried out, become brittle and let go. If the glue has given way, you haven't too much of a problem; if warpage has set in, you've got a bit of trouble (Fig. 808).

The basic cure for an open joint is glue and pressure. Whether you'll be able to help the joints with internal glue blocks (triangular wood strips placed inside the joints), or cleats and screws depends on the type of cabinet and the location of the open joint.

For example, the inside of a speaker cabinet is never seen nor for that matter is the inside of the tuner or amplifier compartment of an equipment cabinet. In such cases there is a good chance of effecting a successful repair even if the panels are warped because you can get inside to install glue blocks or cleats and screws to

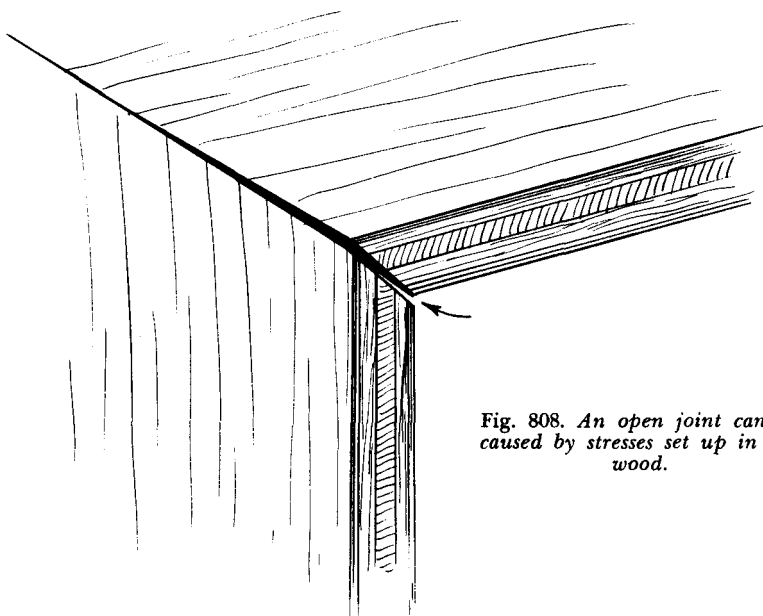

Fig. 808. *An open joint can be caused by stresses set up in the wood.*

reinforce and pull the joint back together. If, however, the open joint is in a readily visible area, they cannot be used, and you'll have to rely entirely on glue and pressure.

Try to clean out the old glue from the open joint before forcing in additional glue. Lumps of old glue remaining in the joint will make it difficult if not impossible to clamp the joint closed and keep it that way.

To get adequate and continuous pressure the ideal clamping tools are cabinetmaker's pipe or bar clamps. If these are not available, another way of developing a quite respectable pressure on the joint is to run a heavy rope around the cabinet. The corners of the cabinet must be protected with, first, a thick wad of tissue or other soft paper or soft rags and then, on top of that, L-shaped blocks of wood. When all of the corners are adequately protected, take up on the rope by putting a rod or pipe through it and twisting it in the manner of a tourniquet. Although a bit cumbersome, this method will develop considerable pressure.

Loose legs

More loose legs result from misuse than from old age. After all, if you load a cabinet full of heavy equipment plus a lot of records and then start dragging it across the floor, you cannot very well blame old age or faulty construction for loose legs that were subjected to lateral strains they were never intended to stand. Of course, legs can also loosen as a result merely of holding up a heavy load for a long time.

To tighten a loose leg the first question is to find out what is loose. This in turn will depend on how the leg was attached in the first place. When a cabinet has four separate legs independently fastened, a common method of attaching them is with hanger bolts. A hanger bolt, you will recall, has a thread like a lag bolt at one end and a machine-screw thread where the head ought to be. It is mounted by driving the lag-bolt thread into the leg; then the machine-screw thread runs into a plate that in turn is wood-screwed into the bottom of the cabinet.

Possible sources of trouble here are: 1) The plate is loose from the bottom of the cabinet; 2) The leg is partly unscrewed from the plate; 3) The hanger bolt is loose in the leg.

In the first two cases the solutions are obvious. If the plate is loose from the cabinet, tighten the screws. If the hanger bolt is loose in the plate, turn the leg to tighten it. If the bolt is loose in the leg, either the bolt has come loose by stripping the threads in the leg or the leg is split.

In either case the best thing to do is to replace the leg. If, however, this is not possible—perhaps you cannot get a leg that matches—then you have to try to repair it.

Take the hanger bolt out of the leg and determine whether the trouble is a stripped thread or a split leg. If the thread is stripped, squirt glue or an all-purpose adhesive into the hole, run the hanger bolt back in, then let the whole thing set until your adhesive is thoroughly dry and hard, and remount the leg. If the leg has been split, squirt glue in the hole and run the bolt back in. This will force glue out into the split. Now clamp the split closed, let it dry, and remount.

If the legs are not individual but attached to each other by a frame forming a base or bench under the cabinet and this arrangement has become loose, you'll find you are dealing either with broken dowels running from the frame into the legs or glue failure.

Lay the cabinet on its back and take the whole base off. Examine the base for loose joints. Any joints that are loose should be knocked completely apart. Now look for broken dowels or splits in the rails near the dowel holes. If all the parts are OK, clean the old glue out of the dowel holes, reglue, reassemble and clamp to dry. Any broken dowels should be replaced. If possible, use a hardwood such as birch for the replacement dowels. The common pine doweling is not very strong, and the loads that go in audio cabinets are often heavy.

If one of the rails has been split, force glue into the split and put a separate clamp on that part when you reassemble the whole base.

Loose molding

This is another case of cleaning out old glue and then regluing. It is often desirable to hold moldings in place with very tiny wire brads rather than by clamping. It is often difficult to get a clamp onto a small molding and, if you do, you may crush it. The brads used should be extremely small. Their purpose is not to hold the molding permanently; that is the job of the glue. The brads are merely to hold the molding while the glue sets.

In discussing repairs to the wood structure of cabinets very little mention has been made of screws and nails. This is because furniture is basically held together, not with fasteners, but with glue. Granted that, particularly in the case of speaker enclosures, the structure is reinforced with screws, the basic fastening is still glue. This is what was relied upon to hold the cabinet together originally, and this is what you can rely on to repair it.

Refinishing

Proper refinishing is a big job. Contemplate doing it only to a piece that you really love very dearly. The worst part of the job is stripping the old finish off and preparing to refinish. The first requirements are liberal quantities of paint remover, a scraper and a good deal of persistence. Different paint removers are used in slightly different ways, so follow the directions on the can and be sure to get all the old finish off, especially around moldings, doors and legs. You'll never get a decent new finish unless you get all of the old finish out from under it. Once the old finish is completely removed from a piece the refinishing procedures will be the same as for finishing a new piece.

After you are through with the paint remover and have taken off all of the old finish, wash the cabinet with turpentine or ben-

zine to get rid of any paint-removing chemicals that may still be on the wood. Then sandpaper as for a new piece and, the better your sanding, the better your final results will be.

You will have no trouble staining the cabinet if you did a good job of getting off the old finish, but any spots where the old finish has not been fully removed will not take the stain.

If you were thinking of bleaching—don't. Bleaching an old piece will give spotty results.

The filling, sealing, finishing and rubbing operations in refinishing an old piece will be exactly the same as if you were applying the initial finish on a new unit, and you can expect just as good results.

A final word of caution when refinishing an old cabinet: After you have completed the removal of the old finish, examine the entire unit very carefully for any structural defects and remedy these before starting the finishing work.