

DRAKE'S
RADIO
CYCLOPEDIA

MANLY

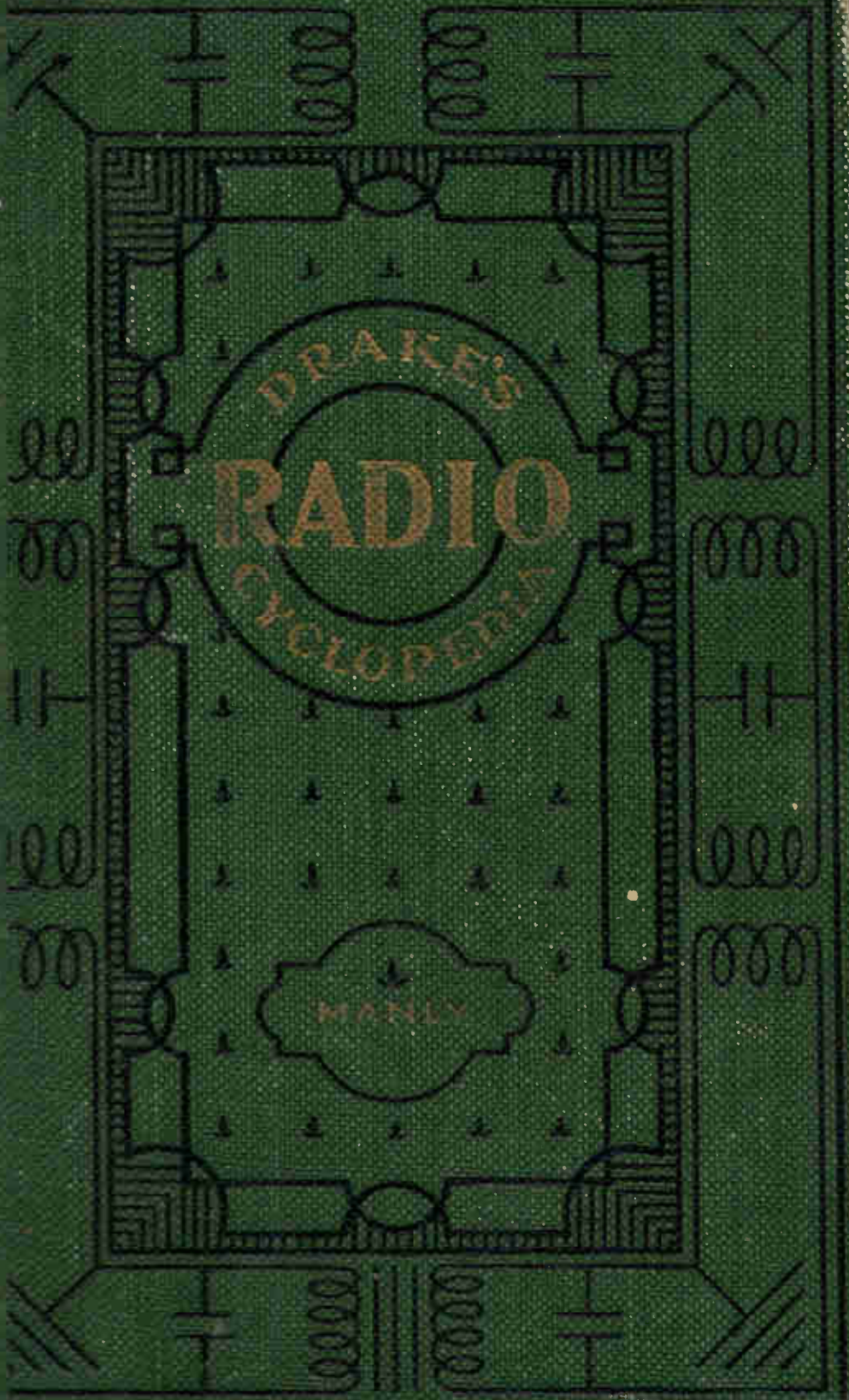

DRAKE'S RADIO CYCLOPEDIA

A COMPLETE AND NON-TECHNICAL REFERENCE
WORK EASY TO READ AND EASY TO USE

COVERING OVER 1,500 SUBJECTS, ARRANGED
ALPHABETICALLY, INCLUDING INSTRUCTIONS
FOR BUILDING, OPERATING AND TESTING
RECEIVERS, POWER UNITS AND RADIO-
PHONE EQUIPMENT

ARRANGED FOR USE BY
SET BUILDERS AND DESIGNERS; SERVICE AND REPAIR
MEN; DEALERS AND SALESMEN; EXPERIMENTERS AND
STUDENTS; SET OWNERS AND OPERATORS

BY
HAROLD P. MANLY
OF THE RADIOTECHNIC LABORATORY
Winnetka, Illinois

WITH 1000 ILLUSTRATIONS, CIRCUIT DIAGRAMS, CON-
STRUCTIONAL LAYOUTS AND GRAPHIC CURVES
ALL MADE ESPECIALLY FOR THIS BOOK

CHICAGO
FREDERICK J. DRAKE & CO.
PUBLISHERS

COPYRIGHT, 1931
By
FREDERICK J. DRAKE & CO.

FOURTH EDITION

MANUFACTURED COMPLETE BY
KINGSPORT PRESS, INC.
KINGSPORT, TENNESSEE
United States of America

PREFACE

DRAKE'S RADIO CYCLOPEDIA is a practical reference book intended to bridge the gap between the radio engineer and the radio worker by presenting useful information clearly, non-technically and with adequacy of treatment.

The field covered is that of the action, use and construction of devices employed in radiophone reception, together with related subjects which form the foundation of radio practice.

The entire book is written in language easily understood by those with no engineering or technical education. No preliminary electrical or radio knowledge of any kind is assumed and each word or term applying to this work is defined and explained in alphabetical order.

The alphabetical arrangement has been adopted because of its evident advantage for reference work. All subjects are treated in detail under the noun, with cross references under each of the other words in any phrase or term. In each article the underlying principles are given in large type, while further explanatory details are added in smaller type, thus making it possible for the busy reader to obtain the more essential information in the minimum of time. The principal object is to make any particular information immediately accessible.

Commencing with any given subject, the reader may continue on to other related subjects through the cross references and can supplement the first information by consulting the separate articles on any words or terms not thoroughly understood, until he finally reaches the fundamental principles of radio-electricity. Operation, construction, testing, design and repair make up the bulk of the material in each article with just enough theory to make clear the reasons for all steps in the actual practice. History and biography are omitted except in one special article.

The subject matter was selected for its value to those interested in practical radio. For example, the builder and designer of receivers will find constant use for the sections on receivers and amplifiers, on methods of construction, on single control, shielding and similar matters. Service and repair men will profit from the material on trouble location and remedy, interference, oscillators and frequency meters, power units and subjects related directly to their problems. Experimenters will use the working data on tubes, coils, condensers, transformers, filters and so on. Students find their

PREFACE

greatest interest in the principles of radio, in regeneration, oscillation, the action of detectors, balancing methods and other subjects dealing with the fundamentals. The owner, dealer and set operator will find information of direct usefulness on antennas and grounds, eliminators, chargers, loops, speakers, etc.

The lengthy treatment given to practical problems and the somewhat abbreviated handling of some technical matters is explained by the greater need for purely practical information by the classes of readers just mentioned. The same need has governed the preparation of the illustrations and diagrams, numbering nearly one thousand, every one of which has been especially drawn for this work to show certain features and details of practical importance otherwise impossible to emphasize properly. Formulas, where necessary and useful, have been written out in words rather than in symbols. The tables present the final results of calculations and experiments so that the reader has the data in its most useful form.

The principal sources of the material were laboratory experiments and the radio publications of the United States Bureau of Standards.

THE AUTHOR.

REFERENCE TABLES, FORMULAS AND GRAPHS

SUBJECTS COVERED	SECTION HEADINGS
Abbreviations.....	Abbreviations; also Symbols
Aluminum, sheet, gauge and weight.....	Shielding
Antenna, capacity and inductance.....	Antenna, Capacity and Inductance
" , frequency and wavelength....	Antenna, Fundamental Frequency
Battery, dry cell, life.....	Battery, Life of
Brass, sheet, gauge and weight.....	Shielding
Call letters, international.....	Letters, Station Call
Capacity, resonant value....	Resonance; also Meters, Frequency, Capacity
Charger, bulb, current from.....	Charger, Battery, Bulb Type
Choke, amplifying, inductance.....	Amplifier, A.F., Impedance Coupled
" , amplifying, voltage.....	Tube, Amplification of
" , retarding, inductance and gap.....	Coil, Choke
Circuit, A.C., current, impedance, reactance.....	Impedance
" , D.C., amperes, ohms, volts.....	Law, Ohm's
" , parallel, resistance.....	Resistance, Parallel Circuit
Code, International Morse.....	Code
Coil, coupling coefficient.....	Coupling, Coefficient of
" , design features, effect of.....	Coil, Design of
" , distributed capacity.....	Oscillator, R.F., Uses of
" , elongation factor.....	Coil, Inductance of
" , inductance.....	Coil, Inductance of
" , inductance, frequency effect.....	Coil, Inductance of; also Resistance of
" , inductance-resistance ratio.....	Coil, Resistance of
" , optimum coupling.....	Coupling, Optimum
" , resistance, binder effect.....	Binders
" , toroid, inductance.....	Coil, Closed Field, Toroid
" , tuning, short wave.....	Receiver, Short Wave
" , tuning, turns required.....	Coil, Tuning, Sizes Required for
" , turns per centimeter length.....	Coil, Inductance of
" , turns per inch length and cross section.....	Wire, Turns per Inch
Condenser, capacity (air, mica and paper).....	Condenser, Capacity of
" , capacity (electrolytic).....	Condenser, Electrolytic
" , capacity, parallel and series.....	Condenser, Capacity of
" , variometer tuning.....	Variometer, Coupling with
Copper, sheet, gauge and weight.....	Shielding
Copper wire.....	See Wire
Coupling coefficient.....	Coupling, Coefficient of
Dielectric constants.....	Constant, Dielectric
Distances, city to city.....	Distance, Geographical
Drills, tap and clearance sizes.....	Drilling

REFERENCE TABLES, FORMULAS AND GRAPHS

Frequency, assigned bands.....	Channel, Radio
“ , resonant values.....	Resonance
“ , wavelength relation.....	Wavelength, Frequency Relation to
Inductance, coil, air core.....	Coil, Inductance of
“ , coil, iron core.....	Coil, Choke
“ , parallel and series values.....	Inductance, Self-
“ , resonant value.....	Inductance; Resonance; Meters, Frequency, Capacity
Insulating material, resistance.....	Resistance, Insulation
Kilocycles, conversion to meters.....	Wavelength, Frequency Relation to
Loop, turns required.....	Loop, Design and Construction
“ , signal strength.....	Loop, Antenna Action of
Metals, resistance.....	Resistance, Materials for
“ , thickness and weight.....	Shielding
Meters, conversion to kilocycles.....	Wavelength, Frequency Relation to
Metric units, conversion of.....	Metric System
Mileage distances, city to city.....	Distance, Geographical
Resistors, current carrying ability.....	Resistor
Resonance, capacity and inductance.....	Resonance; Meters, Frequency, Capacity
Rheostat, resistance required.....	Rheostat, Sizes Required
Screws and bolts, dimensions.....	Screws and Bolts, types of
Symbols.....	Abbreviations; also Symbols
Thermocouple, voltage.....	Thermo-electricity
Thermometer scales, conversion.....	Temperature, scales of
Tube, amplification factor.....	Tube, Testing of
“ , amplification, frequency effect.....	Tube, Amplification of
“ , characteristics of.....	Tube, Characteristics of
“ , filament omission current.....	Tube, Restoration of
“ , mutual conductance.....	Tube, Mutual Conductance; also Testing of
“ , plate current.....	Tube, Amplification of
“ , plate impedance, resistance.....	Tube, Output Resistance and Impedance
“ , plate voltage, effective.....	Tube, Plate Voltages for
“ , power in watts.....	Tube, Amplification of
“ , restoration voltage and time.....	Tube, Restoration of
“ , voltage amplification.....	Tube, Amplification of
Volume, distance and season effect.....	Range, Receiver
Wavelength, assigned bands.....	Channel, Radio
“ , frequency relation.....	Wavelength, Frequency Relation to
“ , resonant values.....	Resonance
Wire, colors of covering.....	Wiring, Receiver

DRAKE'S RADIO CYCLOPEDIA

A

A.—A symbol for area.

A-BATTERY.—See *Battery, A.*

A-BATTERY CHARGER.—See *Charger, Battery.*

A-BATTERY POWER UNIT.—See *Power Unit, Filament Current Types of*; also *Charger, Battery, Trickle Type.*

ABBREVIATIONS.—Following are the abbreviations generally used in radio and in electrical work of all kinds. See also *Code and Symbols.*

A. C.	Alternating Current	K.	A constant
A. F.	Audio Frequency	L.	Inductance; henries
Amp.	Amperes	L-C	Inductance times capacity
A. W. G.	American Wire Gauge	M.	Mutual inductance
B. W. G.	Birmingham Wire Gauge	Mfd.	Microfarad of capacity
C.	Capacity	Mmfd.	Micro-microfarad of capacity
C. C. W.	Counter-clockwise	Mu.	Amplification constant
Cm.	Centimeters	P.	Power; watts
C. W.	Clockwise	P. D.	Potential difference
C. W.	Continuous Wave, also Clockwise	Q.	Quantity; ampere-hours
D. C.	Direct Current	R.	Resistance; ohms
D. C. C.	Double cotton covered wire	R. F.	Radio frequency
D. S. C.	Double silk covered wire	S. C. C.	Single cotton covered wire
D. X.	Distance, reception from	S. C. E.	Single cotton enamel wire
E.	Voltage; potential	S. S. C.	Single silk covered wire
E. M. F.	Electromotive force	S. S. E.	Single silk enamel wire
f.	Frequency; cycles	T.	Time or period; seconds
h.	Henries; inductance in	V. T.	Vacuum tube
I.	Amperage; current	W.	Energy; watt-hours
I. C. W.	Interrupted continuous waves	X.	Reactance
		Y.	Admittance; mhos
		Z.	Impedance; ohms

ABSCISSA.—One of the horizontal lines on a graph. On this line is measured the distance of a point, such as one of the points in a curve, to the right or left of the vertical axis or center line of the graph. In the graph shown on the page following the line *A-B* is an abscissa. The vertical lines are called ordinates. See *Graph.*

ABSORPTION, DIELECTRIC.—One of the causes of energy loss in condensers of all types. It is the part of the condenser charge which appears to be absorbed and lost in the material of the dielectric.

When voltage is first applied to any condenser there is a strong rush of current. This is the charging current. Following the charg-

ABSORPTION, DIELECTRIC

ing current there is a continued flow of current which sometimes lasts for an appreciable interval. This current which continues to flow is comparatively small and is called the absorption current. It represents a loss or an equivalent resistance because its energy is absorbed by the dielectric and is not given back into the circuit when the condenser discharges.

The amount of absorption depends on the material used as a dielectric and on the frequency of the charging current. If the time between alternations is long (low frequency) there will be a considerable period during which this absorption current may flow. If the time is short (high frequency) only a little absorption current will have time to flow into the condenser, consequently the loss due to dielectric absorption becomes less as the frequency increases.

When a condenser is charged by a source of electrical energy it would be desirable to have the condenser give back all of the energy upon discharge. We would like to have the condenser act as a perfect device for storing electricity so that all energy put into the condenser might be drawn out again. Unfortunately this is not possible.

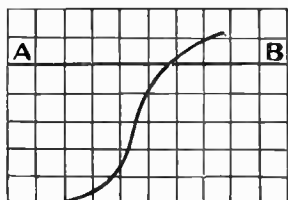

An Abscissa.

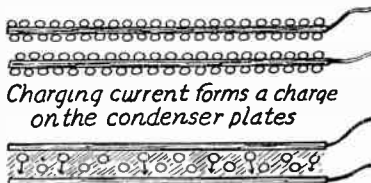

Charging current forms a charge on the condenser plates

Absorption current acts as if passing thru the dielectric.

Action of Absorption and Charging Currents.

Dielectric absorption is not of great importance in tuning condensers because the frequency of the current in the radio amplifying stages is so high that there is little time for absorption to take place. See also *Condenser, Action of and Condenser, Losses in.*

A. C.—An abbreviation for alternating current. See *Current, Alternating.*

ACCEPTOR CIRCUIT.—See *Circuit, Acceptor.*

ACID, BATTERY.—The electrolyte or liquid used in storage battery cells. See *Battery, Storage Type.*

ACOUSTICS.—The science of sound. See *Sound.*

ADAPTER, ANTENNA.—A device by means of which the wires of light and power circuits may be used for an antenna. See *Antenna, Light and Power Circuit for.*

ADAPTER, PHONOGRAPH.—A device by means of which a radio loud speaker unit may be substituted for the reproducer of a phonograph so that sounds from the speaker unit are carried through the sound chambers and horn of the phonograph.

ADAPTER, POWER TUBE.—A sleeve or receptacle which fits into a socket designed for an ordinary amplifying tube, the adapter being arranged to carry a power tube requiring greater plate

ADAPTER, SOCKET

voltage or B-battery voltage and greater grid biasing or C-battery voltage than the tube originally used in the socket.

The power tube adapter carries prongs which make connection with the socket contacts and also contains contacts against which rest the prongs of the power tube so that the filament connections are completed as before. The plate and grid circuits for the power tube are brought out through flexible wire leads attached to the adapter. By means of these leads it is possible to apply any necessary plate voltage and any necessary grid biasing voltage to the power tube, thus giving this tube different plate and grid voltages than ordinarily furnished to the other amplifying tubes through the receiver circuits.

ADAPTER, SOCKET.—A device by means of which a tube having a base of one style may be used in a socket of a different style or type. The more commonly used adapters are those which allow a tube with a small base, such as a dry-cell tube, to be used in the large base made for a storage battery tube.

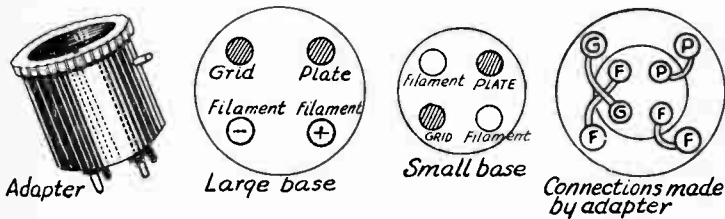

The Connections Through a Socket Adapter.

Since the arrangement of the contacts for grid, plate and filament connections in some dry-cell tubes is different from the arrangement in storage battery tubes, as shown in the diagram, the conductors or connections in the adapter must cross each other and be of some length. These added pieces of metal in the grid and plate circuits have an appreciable capacity to each other so that undesired feedbacks are increased. This is quite noticeable in radio frequency and detector tubes and the use of adapters in these positions is undesirable.

ADAPTER, TUBE.—See *Adapter, Socket*.

ADJUSTABLE.—Another name for variable.

ADMITTANCE.—The reciprocal of the impedance in a circuit; that is, 1 divided by the impedance. Admittance is measured in mhos and its usual symbol is " Y ." See *Impedance*.

AERIAL.—The words aerial and antenna are generally used as having the same meaning. However, many favor the word "aerial" as applying to the elevated conductors from which signals are radiated or sent out from a transmitting station, and the word antenna as meaning the conductors or wires which receive radio signals. According to this usage, an aerial is used at the transmitting station and an antenna is used at the receiver. See *Antenna*.

A. F.—An abbreviation for audio frequency. See *Frequency, Audio*.

AIR.—Air is the most common dielectric, being always available. The dielectric constant of air is unity, or 1. This dielectric constant

AIR CONDENSER

of air is the basis of measurement for all other dielectric constants.

Air is a good insulator at the voltages used in radio work, one-quarter inch of air at atmospheric pressure requiring about 10,000 volts for a spark to break through it. The electrical properties of air as an insulator are ideal. It has the least dielectric loss of any material.

See also *Ionization, in Air*.

AIR CONDENSER.—See *Condenser, Dielectric of*.

AIR CORE.—See *Core*.

ALPHABET, TELEGRAPHIC.—See *Code*.

ALTERNATING CURRENT.—See *Current, Alternating*.

ALTERNATING CURRENT POWER SUPPLY.—See *Power Unit*.

ALTERNATING CURRENT RECEIVER.—See *Tube, Alternating Current Tube Type*.

ALTERNATING CURRENT TUBE.—See *Tube, Alternating Current Type*.

ALTERNATION.—One half of one complete cycle of alternating current. The curve starting from zero voltage, increasing to the maximum positive voltage and falling again to zero voltage completes the positive alternation of one cycle. Then, from zero voltage to maximum negative voltage and back to zero forms the negative alternation of the cycle. See *Cycle*.

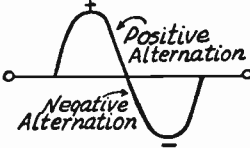

Positive and Negative Alternations.

ALTERNATOR.—An electric generator producing alternating voltages and current. See *Current, Alternating*.

ALUMINUM.—The metal which in importance is second only to copper for electrical work of all kinds. The resistance of aluminum is about 1.6 times that of copper of equal bulk or size. Its weight for a given bulk is about three-tenths that of copper.

Aluminum does not tarnish or corrode from the effects of dry air as does copper but aluminum is oxidized by moisture in the air. The film found on the surface of aluminum requires about one-half volt to break through it, therefore positive or wiping contacts should be employed for aluminum parts to which are carried low voltage currents from other parts touching them. Aluminum may be soldered, though with some difficulty. For additional information see *Shielding*.

AMATEUR.—A person who follows the science and practice of radio because of a liking for it and not only in a professional or profit-seeking capacity. Radio amateurs maintain and operate their own receiving and sending stations, being allotted the wavelengths below those in the broadcasting bands. Amateurs should not be confused with "novices" because the amateurs are highly expert in their avocation and their work and development of the radio art have been responsible for much of the advancement in this science.

AMMETER.—See *Meters, Ampere and Volt*.

AMPERAGE, CALCULATION OF.—See *Law, Ohm's*.

AMPERE.—The practical unit for measuring the flow of electric

AMPERE-HOUR

current. One ampere is the rate of flow through an electric circuit whose resistance is one ohm when the pressure is one volt. Amperes do not measure the quantity of electricity nor the speed, but only the volume of current flowing past a given point in the circuit in a given time. This electrical unit corresponds to the hydraulic unit of "gallons per minute" which likewise measures the rate or volume of flow in a given time.

AMPERE-HOUR.—The quantity of electricity that passes through a circuit in one hour when the rate of flow is one ampere. The number of ampere-hours is obtained by multiplying the number of amperes flowing by the number of hours during which the flow continues. This unit is used principally for measuring the charge and discharge of storage batteries.

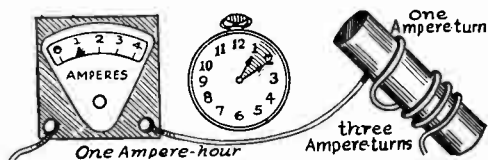

Ampere-Hour and Ampere-Turn.

AMPERE-TURN.—One complete turn of a conductor in a coil through which one ampere is flowing. The flow in amperes multiplied by the number of turns in the coil gives the number of ampere-turns. The ampere-turn is a unit used to measure the magnetic strength of a coil or magnet. The greater the number of ampere-turns, the greater the magnetic strength.

AMPLIFICATION.—Amplification is a measure of the increase in strength, either voltage or amperage or both, in a radio signal when passed through a tube, a transformer, or other amplifying device. The number of times the strength is increased is called the amplification ratio.

There is a difference between amplification and volume. Many seem to think that these two words mean the same thing. Amplification means the increase of signal voltage or current. Volume means the final result in power delivered from the amplifier, that is, volume means loudness.

An amplifier may receive an exceedingly weak signal, say a signal of only one-tenth volt. The amplifier may increase this signal one hundred times so that the one-tenth volt is changed to ten volts. This is an amplification of one hundred, which changes the incoming one-tenth volt to ten volts.

Another amplifier might have an amplification of only ten in place of one hundred but it might receive a much stronger signal, such as a signal of one volt. Since the amplification is ten the final result would be ten volts because the one volt incoming signal would have been multiplied by ten. The final voltage from this second amplifier would then be ten, the same as the final voltage from the first amplifier which increased its signal one hundred times.

The point is this, the first amplifier has greater amplification than the second. In fact, since the first one amplifies one hundred times and the second only ten times the first amplifier is ten times as powerful as the second. Yet the volume from each amplifier is the same since the final voltage is ten in

AMPLIFICATION

both cases. The volume is the strength of signal delivered by an amplifier while amplification is the number of times that the amplifier increases the original signal strength.

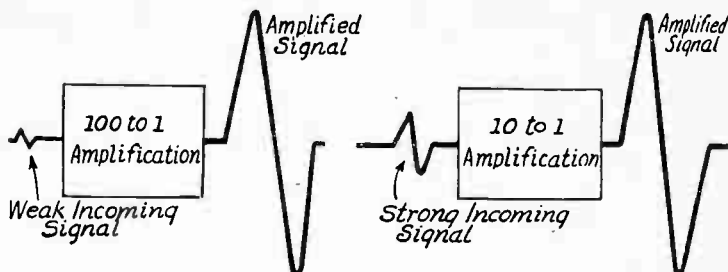

The Effect of Amplification on Signal Strength.

AMPLIFICATION, AUDIO FREQUENCY.—See *Amplifier, Audio Frequency*.

AMPLIFICATION, CASCADE.—The use of a number of amplifying stages connected together so that the output from one stage acts as the input for the following stage is called cascade amplification. Each stage further amplifies the signal from the preceding stage, and such a series of amplifying units forms a cascade amplifier. A two-stage cascade amplifier consists of two amplifying tubes with their coupling. A three-stage cascade amplifier consists of three amplifying tubes with their coupling. The word "cascade"

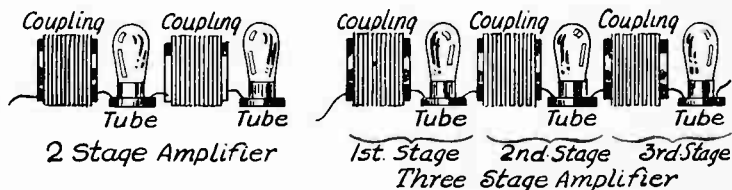

A Two-Stage and a Three-Stage Cascade Amplifier.

is generally omitted and such arrangements are called simply two-stage or three-stage amplifiers.

AMPLIFICATION, COEFFICIENT OF.—See *Tube, Amplification of*; also *Tube, Characteristics of*.

AMPLIFICATION, OF COUPLING DEVICES.—Of the many forms of coupling used in amplifiers only transformers of one type or another may be said to have amplification in themselves. By amplification is meant an increase of voltage.

Transformers having separate primary and secondary windings, or auto-transformers having primary and secondary connected, have a step-up voltage ratio when the number of turns in the secondary winding is greater than the number of turns in the primary winding. The incoming voltage is then increased or amplified.

AMPLIFICATION, POWER

The amplification or increase of voltage in audio frequency transformers is dependent on the turn ratio. A three-to-one turn ratio audio frequency transformer will theoretically multiply the voltage by three and the secondary voltage will be theoretically three times as great as the primary voltage. The actual voltage amplification is far below the turn ratio in audio frequency transformers. See *Transformer, Audio Frequency*.

In radio frequency transformers of the air-core type and in all tuned radio frequency transformers there is very little voltage amplification in spite of the fact that they generally have a high turn ratio. See *Transformer, Tuned Radio Frequency*.

A radio frequency transformer having fifteen primary turns and forty-five secondary turns might be expected to have a voltage ratio of three to one. Due to leakage in the air core and to other factors affecting high frequency transformers of this type there is generally very little gain or even a slight loss in voltage so that the transformer secondary voltage may not be quite as high as the primary voltage. In a radio frequency amplifier practically all of the amplification occurs in the tubes and little if any in the transformers.

Other forms of coupling such as capacity coupling and resistance coupling have no amplification in themselves but on the other hand they invariably reduce the voltage to a greater or less extent.

AMPLIFICATION, POWER.—See *Amplification, Voltage and Power*.

AMPLIFICATION, RADIO FREQUENCY.—See *Amplifier, Radio Frequency*.

AMPLIFICATION, STAGES OF.—See *Amplification, Cascade*; also *Radio, Principles of*.

AMPLIFICATION, TRANSFORMER.—See *Transformer, Audio Frequency*; also *Transformer, Tuned Radio Frequency*.

AMPLIFICATION, VOLTAGE AND POWER.—There are two kinds of amplification, voltage amplification and power amplification. Voltage amplification consists only of an increase in voltage with no increase of power or even with a decrease of power. Power is measured in watts, and watts are the product of voltage and amperage. Therefore, if we increase the voltage with voltage amplification while reducing the number of amperes we may reduce the total power in spite of the amplified voltage.

In power amplification we increase the number of watts and this is generally done by obtaining a decided gain in the number of amperes with a relatively small gain in voltage. Power amplification requires the use of a vacuum tube which releases power from a B-battery or other source of current for its plate circuit.

A vacuum tube is said to be a voltage operated device because it is the change of voltage applied to the tube's grid which causes the change of current through the tube's plate circuit. Voltage applied to the grid controls current and power in the plate circuit.

The current released through the plate circuit of the tube flows through a coupling transformer or other coupling device and in flowing causes a voltage change across the coupling device as in Fig. 1.

AMPLIFICATION, VOLTAGE AND POWER

This voltage change is applied to the grid of the following tube. The voltage which is applied to the grid of the first tube thus controls a flow of current in the plate circuit of that tube and this flow of plate current is the means of applying a voltage to the grid of the following tube.

When amplifying the signal by passing it through successive stages of radio frequency or audio frequency amplification an increase of voltage is desired from stage to stage until the last audio frequency tube is reached and then power is called for. If an amplifier as in Fig. 2 receives say one-quarter volt and has the ability to amplify this voltage eight times, the next stage will receive a voltage change of eight times one-quarter, or two. If this two-volt signal is passed through another similar stage it will multiply the two volts by eight and deliver sixteen volts. This process is called voltage amplification

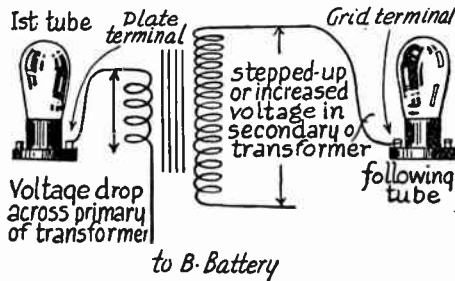

FIG. 1.—Voltage Amplification in a Transformer.

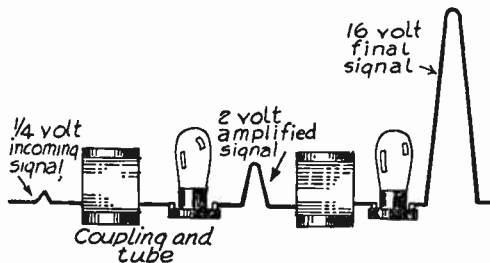

FIG. 2.—The Action of Voltage Amplification.

and it is the kind of amplification needed in all radio frequency amplifiers and in all stages of audio frequency amplification except the last stage. But when we come to the last audio stage, whose tube must operate the loud speaker, we want power amplification as well as voltage amplification.

In the output of the last tube of the audio amplifier we want a considerable voltage, the maximum voltage of the power supply unit. In the plate circuit of this last tube we also want the greatest possible amperage so that the number of amperes times the number of volts in the plate circuit of the last tube will give the greatest possible number of watts or the greatest possible power to operate the speaker.

The number which denotes the power amplification of a tube is the number of times the output in watts from the plate circuit is greater than the input in watts applied to the grid circuit of that tube. See *Tube, Amplification of*; also *Amplifier, Radio Frequency, Tuned Transformer Coupled*.

AMPLIFIER

AMPLIFIER.—An amplifier is an arrangement of vacuum tubes and coupling devices between the tubes whereby either the voltage or the power of a radio signal is increased or amplified. Amplifiers are of two principal types. One of them is designed to amplify the high frequency or radio frequency voltages received from the antenna and pass the amplified voltages on to the detector. This is the radio frequency amplifier. The other type of amplifier receives low frequency or audio frequency voltages from the detector, amplifies these voltages and finally increases their power before passing it on to the loud speaker. This is the audio frequency amplifier. Both kinds are described in the following pages.

AMPLIFIER, AUDIO FREQUENCY.—The audio frequency amplifier is the part of a receiver between the detector and the loud speaker or headphones. It may consist of one or more amplifying tubes with their interstage couplings. With two tubes or more it is a cascade amplifier which takes the signals from the plate circuit of the detector and after increasing their voltage and power delivers them to the loud speaker or headphones.

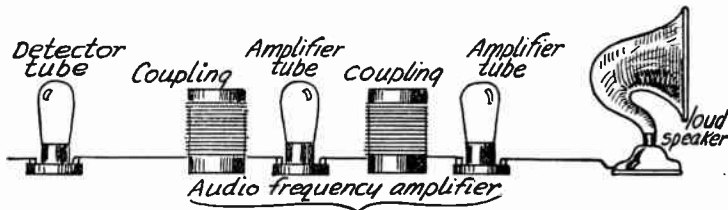

The Audio Frequency Amplifier Between Detector and Speaker.

Audio frequency amplifiers may be classed according to their means of interstage coupling. According to this classification we have transformer coupled amplifiers, resistance coupled amplifiers and impedance coupled amplifiers.

Amplifiers may also be classed according to the number of amplifying tubes. Some amplifiers use only one tube, forming a single stage of amplification. The greater number use two tubes and are called two-stage amplifiers. A few use three stages of amplification but more than three stages of cascade audio frequency amplification introduce distortion and other troubles which are very difficult to control. See *Radio, Principles of*.

The greatest gain in voltage and power is obtained with transformer coupling. Next to transformer coupling comes the form of impedance coupling which provides a step-up ratio in voltage. Following this comes the straight choke coil coupling while the resistance coupled audio amplifier gives the least voltage amplification. The lack of amplification in the resistance coupled amplifier is compensated for to a great extent by great uniformity of amplification at all frequencies within the audible range. In other words, the resistance coupled amplifier produces little distortion. The imped-

AMPLIFIER, AUDIO FREQUENCY, IMPEDANCE COUPLED

Inductance Required in Chokes.—In order to produce distortionless amplification the impedance of the choke coils or impedance units must be large for reasons which will be explained.

The power in the plate circuit of a tube is divided between the internal resistance of the tube and the external impedance which is furnished by the choke coil. The drop of voltage across the choke is transmitted to the grid of the following tube with but slight loss and it is this voltage applied to the following tube's grid which builds up the signal. The voltage drop across the resistance in the tube is lost so far as amplification is concerned.

In actual practice it is found that with the number of ohms in the external impedance twice as great as the tube resistance in ohms ninety per cent of the tube's maximum possible voltage amplification will be available for amplification by the next tube. With a choke whose impedance is three times that of the tube resistance we will obtain ninety-five per cent of the possible voltage across the choke. With a choke impedance four times that of the tube resistance we will obtain ninety-seven per cent of the possible maximum voltage.

The impedance of the choke changes with frequency, becoming greater as the frequency increases. If we start with an impedance only twice as great as the tube resistance, the changing frequency representing the changing sounds being amplified may cause amplification difference of between ninety per cent

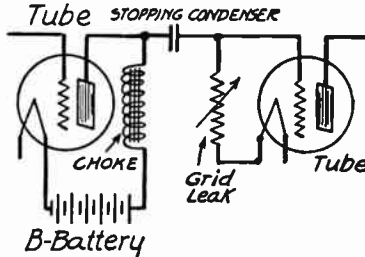

FIG. 1.—The Impedance Coupled Audio Amplifier.

and one hundred per cent, which is ten per cent, a considerable distortion. If we increase the choke impedance to three times the value of the tube resistance the greatest change due to changes of frequency can be only the difference between ninety-five per cent and one hundred per cent, or five per cent. This, of course, is less distortion. Now if we increase the impedance of the choke to four times the value of the tube resistance, which gives ninety-seven per cent of the possible voltage across the choke, the greatest change that can occur between high and low pitched sounds is the difference between ninety-seven per cent and one hundred per cent. This is a difference of only three per cent between the amplification of very low frequencies and of the highest frequencies. A difference as small as this means practically perfect amplification.

The plate resistance of ordinary quarter-ampere amplifying tubes is in the neighborhood of 10,000 to 12,000 ohms. If we wish an impedance in the choke equal to three times the plate resistance in ohms we must have between 30,000 and 35,000 ohms in the choke and if we want an impedance equal to four times the value of the tube resistance we must have an impedance of 40,000 to 50,000 ohms in the choke. This choke impedance should be figured at the lowest frequencies to be amplified.

In most amplifiers a frequency of fifty cycles is the low limit but in some of the better types frequencies of thirty or even twenty-five cycles are well amplified.

The impedance of the choke coil is composed of inductive reactance due to the choke's inductance, of capacitive reactance due to the distributed ca-

AMPLIFIER

AMPLIFIER.—An amplifier is an arrangement of vacuum tubes and coupling devices between the tubes whereby either the voltage or the power of a radio signal is increased or amplified. Amplifiers are of two principal types. One of them is designed to amplify the high frequency or radio frequency voltages received from the antenna and pass the amplified voltages on to the detector. This is the radio frequency amplifier. The other type of amplifier receives low frequency or audio frequency voltages from the detector, amplifies these voltages and finally increases their power before passing it on to the loud speaker. This is the audio frequency amplifier. Both kinds are described in the following pages.

AMPLIFIER, AUDIO FREQUENCY.—The audio frequency amplifier is the part of a receiver between the detector and the loud speaker or headphones. It may consist of one or more amplifying tubes with their interstage couplings. With two tubes or more it is a cascade amplifier which takes the signals from the plate circuit of the detector and after increasing their voltage and power delivers them to the loud speaker or headphones.

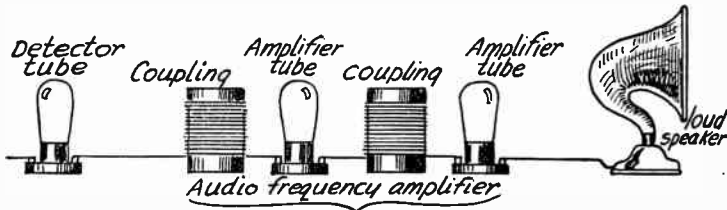

The Audio Frequency Amplifier Between Detector and Speaker.

Audio frequency amplifiers may be classed according to their means of interstage coupling. According to this classification we have transformer coupled amplifiers, resistance coupled amplifiers and impedance coupled amplifiers.

Amplifiers may also be classed according to the number of amplifying tubes. Some amplifiers use only one tube, forming a single stage of amplification. The greater number use two tubes and are called two-stage amplifiers. A few use three stages of amplification but more than three stages of cascade audio frequency amplification introduce distortion and other troubles which are very difficult to control. See *Radio, Principles of*.

The greatest gain in voltage and power is obtained with transformer coupling. Next to transformer coupling comes the form of impedance coupling which provides a step-up ratio in voltage. Following this comes the straight choke coil coupling while the resistance coupled audio amplifier gives the least voltage amplification. The lack of amplification in the resistance coupled amplifier is compensated for to a great extent by great uniformity of amplification at all frequencies within the audible range. In other words, the resistance coupled amplifier produces little distortion. The imped-

AMPLIFIER, AUDIO FREQUENCY

ance coupled amplifier with step-up ratio gives practically the same freedom from distortion and the straight choke coupled amplifier is also excellent in this respect. Transformer coupled amplifiers giving a high voltage gain may introduce considerable distortion and uneven amplification unless they are exceedingly well built and properly operated.

Some audio frequency amplifiers are of the power type. The difference between a power amplifier and an amplifier of ordinary construction is that the power type employs tubes which are capable of handling high plate currents and high voltages rather than only the ninety to one hundred volts generally applied to the plate of amplifying tubes. These power tubes deliver from twenty to one hundred times the power in watts delivered by the ordinary tube.

An audio amplifying stage gives a greater gain in voltage and in amplification than a radio amplifying stage but the audio amplifier increases or amplifies all noises at audio frequencies, such as power line noise and other kinds of local interference. Radio amplifiers do not increase these noises to such a great extent.

Theoretically the voltage of a signal might be increased indefinitely by passing it through many stages of voltage amplification. The voltage that actually may be used is limited by the operating characteristics of a vacuum tube. Any given tube working with certain voltages and loads in its plate circuit will amplify voltages up to a certain value without distortion. That is, it will take care of certain voltages applied to its grid and still give a true reproduction of these voltages in its plate circuit. But just as soon as the maximum allowable voltage is exceeded the plate circuit no longer carries faithful pictures of the voltage changes in the grid circuit and distortion takes place. Thus, voltage amplification is limited by distortion. See *Tube, Action of*; also *Distortion*.

An audio frequency amplifier of any type may be built with two or more stages which amplify weak signals satisfactorily but which over-amplify and distort strong incoming signals. One of the intermediate stages may be cut in or out of operation as described under *Jacks and Switches, Uses of*, or the over-amplification may be prevented by methods described under *Volume, Control of*.

Each of the principal types of audio frequency amplifiers is considered in sections immediately following. Comparative testing of audio frequency amplifiers is described under *Oscillator, Audio Frequency, Uses of*. See also *Receiver, Audio Amplifier for*.

AMPLIFIER, AUDIO FREQUENCY, BYPASS CONDENSERS FOR.—Audio frequency amplifiers regardless of their type of interstage coupling are commonly constructed in such a way that there is an additional but unwanted resistance coupling formed by the power supply or by a common B-battery, C-battery and A-battery used for several stages of one amplifier. Such coupling provides a ready means for feedbacks which may introduce great distortion. See *Oscillation*. This trouble may be reduced by properly placed bypass condensers which provide separate and individual circuits for the audio frequency currents in each stage while allowing the direct current of the common batteries or power supply to flow through all of the stages.

AMPLIFIER, AUDIO FREQUENCY, CHOKE COUPLED

The plate circuit of each amplifier tube is completed by connecting a bypass condenser of one microfarad capacity between the positive or negative filament terminal on the tube and the connection or terminal at which the coupling device is connected to the B-battery or plate voltage supply unit. The audio frequency plate circuit is then completed through the plate, the filament, the bypass condenser and the coupling device. The audio frequency current does not pass through the B-battery or power supply where it would find coupling with the audio frequency currents from other tubes.

A separate path for the grid voltage of the audio frequency amplifying tubes is provided by placing a bypass condenser of one-quarter microfarad or more between the negative filament terminal of each amplifying tube and the grid return for that tube. The grid return may be to the negative C-battery connection or to the battery side of the tube's rheostat. See *Return, Grid*. The connections of the plate and grid bypass condensers are shown for transformer coupling, impedance coupling and resistance coupling.

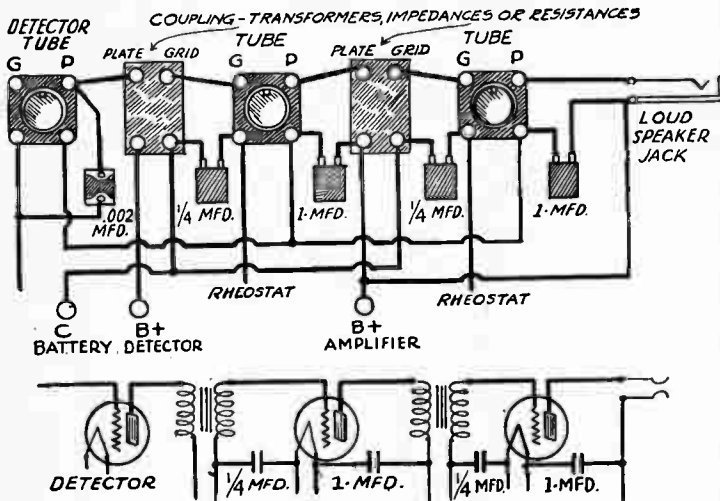

Bypass Condensers in Audio Amplifier to Reduce Feedbacks.

AMPLIFIER, AUDIO FREQUENCY, CHOKE COUPLED.—See *Amplifier, Audio Frequency, Impedance Coupled*.

AMPLIFIER, AUDIO FREQUENCY, IMPEDANCE COUPLED.—Impedance coupling, often called choke coil coupling, places a coil of high impedance between the plate of an amplifying tube and the B-battery or power unit which furnishes positive voltage for the plate. The connections are shown in Fig. 1. The voltage drop across this impedance or choke is applied through a stopping condenser to the grid of the following tube. The principle is the same as that used in resistance coupled amplification except that here the means for obtaining a voltage drop is an impedance (consisting of reactance and resistance) rather than a simple resistance. The following tube is provided with a grid leak to get rid of the surplus negative charges on its grid. See *Receiver, Audio Amplifier* for.

AMPLIFIER, AUDIO FREQUENCY, IMPEDANCE COUPLED

Inductance Required in Chokes.—In order to produce distortionless amplification the impedance of the choke coils or impedance units must be large for reasons which will be explained.

The power in the plate circuit of a tube is divided between the internal resistance of the tube and the external impedance which is furnished by the choke coil. The drop of voltage across the choke is transmitted to the grid of the following tube with but slight loss and it is this voltage applied to the following tube's grid which builds up the signal. The voltage drop across the resistance in the tube is lost so far as amplification is concerned.

In actual practice it is found that with the number of ohms in the external impedance twice as great as the tube resistance in ohms ninety per cent of the tube's maximum possible voltage amplification will be available for amplification by the next tube. With a choke whose impedance is three times that of the tube resistance we will obtain ninety-five per cent of the possible voltage across the choke. With a choke impedance four times that of the tube resistance we will obtain ninety-seven per cent of the possible maximum voltage.

The impedance of the choke changes with frequency, becoming greater as the frequency increases. If we start with an impedance only twice as great as the tube resistance, the changing frequency representing the changing sounds being amplified may cause amplification difference of between ninety per cent

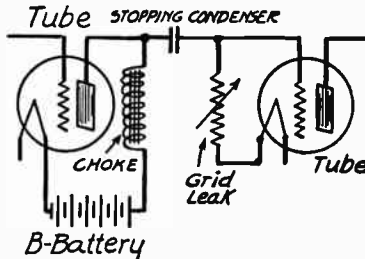

FIG. 1.—The Impedance Coupled Audio Amplifier.

and one hundred per cent, which is ten per cent, a considerable distortion. If we increase the choke impedance to three times the value of the tube resistance the greatest change due to changes of frequency can be only the difference between ninety-five per cent and one hundred per cent, or five per cent. This, of course, is less distortion. Now if we increase the impedance of the choke to four times the value of the tube resistance, which gives ninety-seven per cent of the possible voltage across the choke, the greatest change that can occur between high and low pitched sounds is the difference between ninety-seven per cent and one hundred per cent. This is a difference of only three per cent between the amplification of very low frequencies and of the highest frequencies. A difference as small as this means practically perfect amplification.

The plate resistance of ordinary quarter-ampere amplifying tubes is in the neighborhood of 10,000 to 12,000 ohms. If we wish an impedance in the choke equal to three times the plate resistance in ohms we must have between 30,000 and 35,000 ohms in the choke and if we want an impedance equal to four times the value of the tube resistance we must have an impedance of 40,000 to 50,000 ohms in the choke. This choke impedance should be figured at the lowest frequencies to be amplified.

In most amplifiers a frequency of fifty cycles is the low limit but in some of the better types frequencies of thirty or even twenty-five cycles are well amplified.

The impedance of the choke coil is composed of inductive reactance due to the choke's inductance, of capacitive reactance due to the distributed ca-

AMPLIFIER, AUDIO FREQUENCY, IMPEDANCE COUPLED

capacity of the choke's winding, and of resistance in the wire of the choke winding. The inductance is the chief factor in this impedance. The distributed capacity reduces the useful impedance and the wire resistance helps the useful impedance provided this wire resistance is not so large that it greatly reduces flow of current in the plate circuit. The effect of the wire's resistance is the same at all frequencies. The useful effect of the inductance increases with increase of frequency and the harmful effect of the distributed capacity also increases with increase of frequency.

The ideal choke would consist of pure inductance, without either distributed capacity or resistance. Some of the well built chokes come reasonably close to this ideal while some of the poorer coupling chokes come far from it.

The lower the internal resistance or plate resistance of the tube the less impedance is required in the choke to produce satisfactory and uniform amplification of all frequencies. The plate resistance of any tube may be lowered by increasing the plate voltage. But no amount of voltage that safely may be applied to a small dry-cell tube will make it the equal of a real power tube. Under most favorable operating conditions the smallest tubes have plate resistances around 15,000 ohms. The ordinary voltage amplifying tubes have plate resistances around 11,000 ohms while power tubes have plate resistances as low as 2,000 ohms in some cases.

The following table shows the inductance in henries required to provide various degrees of uniformity in amplification of sounds having minimum frequencies of twenty-five cycles and of fifty cycles when using tubes having plate resistances of 2000 ohms, 5000 ohms and 10,000 ohms. The great saving in choke size when using power tubes is shown very clearly. The table assumes that the chokes are formed of pure inductance, the capacity and resistance being neglected.

Inductances in henries are given at the intersections of the lines for plate resistance and the columns for percentage of uniformity in amplification. See also *Distortion*.

INDUCTANCES REQUIRED IN IMPEDANCE COUPLING COILS

Tube Plate Resistance in Ohms	Lowest Note—25-cycle Frequency			Lowest Note—50-cycle Frequency		
	90% Uniformity	95% Uniformity	97% Uniformity	90% Uniformity	95% Uniformity	97% Uniformity
2,000	25	38	50	13	17	25
5,000	65	95	125	31	42	63
10,000	125	190	250	63	84	125

Condensers and Grid Leaks.—When considering the stopping condenser used between the plate of one tube and the grid of the following tube it must be remembered that this condenser has reactance to the alternating or audio frequency current which must pass through it to reach the grid of the next tube. The stopping condenser should have very low reactance because the lower its reactance the less voltage will be lost in getting through the condenser. This means that the condenser must be of large capacity, at least one-tenth microfarad. This stopping condenser must also

AMPLIFIER, AUDIO FREQUENCY, IMPEDANCE COUPLED

have very high resistance, that is, it must be made with a dielectric which is a good insulator. If the insulation allows any appreciable leakage some of the positive voltage from the preceding plate circuit will be applied to the grid of the following tube and this positive voltage on the grid will cause much distortion.

The next thing to consider is the grid leak. Because the reactance of the stopping condenser is very low, the grid leak is practically in parallel with the impedance of the choke. If the grid leak is of too low resistance it will reduce the effective impedance of the choke since it will place a comparatively low resistance in parallel with the choke. But, on the other hand, if the grid leak is of too high resistance the accumulation of negative charges on the grid will not leak off fast enough and the tube will block. The accumulated negative charges will force the grid voltage so far negative that

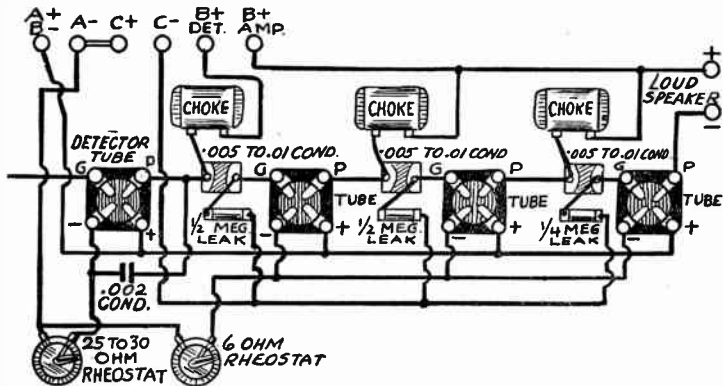

FIG. 2.—Three-Stage Impedance Amplifier Starting with the Detector.

plate current is prevented from flowing. As a general rule a grid leak of between one-quarter and one-half megohm is about right. See *Leak, Grid*. The same values of C-battery or biasing voltage are required with choke coupling as with any other form of coupling.

Construction of Amplifier.—The layout, connections and values of all units in a three-stage choke coupled amplifier are shown in Fig. 2. This covers all of the amplifier between the detector tube and the loud speaker terminals. The stopping condensers are shown as .005 to .01 microfarad capacity. Better results will be obtained in amplifying the low notes with still larger capacity stopping condensers. Grid leaks in the first two stages should be one-half megohm and in the last stage one-quarter megohm.

The choke or impedance coupled amplifier requires no higher B-battery or plate voltages than are used with transformer coupling, that is, for tubes of the 201-A type ninety volts is generally sufficient. For power tubes the plate voltage is 120, 150 or more volts. See also *Receiver, Audio Amplifier for*.

AMPLIFIER, AUDIO FREQUENCY, IMPEDANCE COUPLED

It is possible to utilize chokes or impedances which were not originally intended for this class of work. For example, the primary of an ordinary audio frequency amplifier will form a fairly satisfactory choke. The secondary ter-

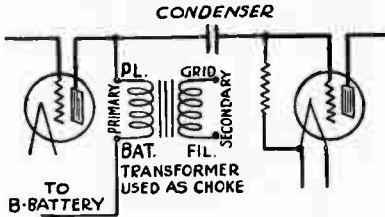

FIG. 3.—Transformer Primary as Coupling Choke in Impedance Amplifier.

minals are left unconnected as shown in Fig. 3. All other connections and values would be the same as when using a regular coupling choke. Make-shift chokes will seldom if ever give satisfactory amplification of low notes. Testing of impedance coupled amplifiers is described under *Oscillator, Audio Frequency, Uses of*.

AMPLIFIER, AUDIO FREQUENCY, IMPEDANCE (STEP-UP TYPE).—The type of impedance coupled amplifier which uses chokes having a single winding without taps cannot be made to give a step-up ratio of voltage in the coupling unit. A modified form of impedance amplifier is provided with a tap in the winding so that a voltage ratio as high as one and one-half to one or even two to one may be obtained. Both a circuit diagram and a construction layout with all connections and correct values for all units are shown in Figs. 1 and 2.

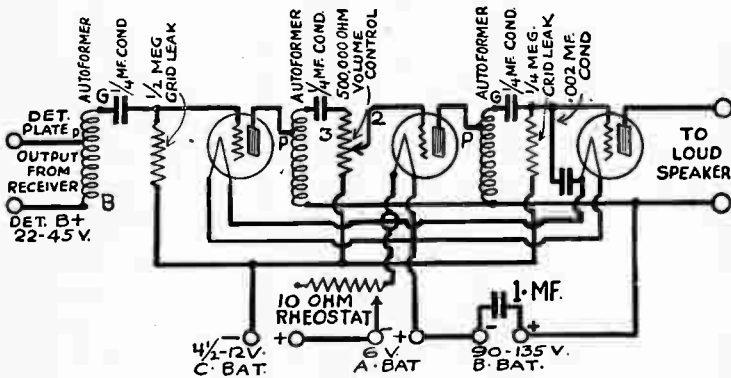

FIG. 1.—Circuits of Step-Up Impedance Coupled Amplifier.

One end of the impedance coil is connected through a stopping condenser to the grid of the following tube. The other end of the coil is connected to the B-battery or plate supply unit. The tap is connected to the plate of the preceding tube. Such an arrangement

AMPLIFIER, AUDIO FREQUENCY, IMPEDANCE COUPLED

gives considerably more amplification than an ordinary choke coupled amplifier and gives decidedly more amplification than a resistance coupled amplifier. The quality of reproduction is equal to the better types of resistance coupled or choke coupled amplifiers. The amplification is practically uniform throughout the entire audio frequency range starting at twenty-five cycles.

Large capacity stopping condensers will give better amplification of the low notes but it is unnecessary to use anything larger than one microfarad. In most amplifiers of this type one-quarter microfarad is the smallest size which will allow proper amplification of low frequencies. The cases of these stopping condensers should not be grounded, neither should they be connected to each other nor to any other metal parts such as brackets and shields. There is but little gain in the percentage of amplification by using stopping condensers larger than one-quarter microfarad capacity. Using stopping condensers as small as one-eighth microfarad shows some reduction in amplification while condensers as small as .06 microfarad reduce the amplification to less than half its maximum possible value.

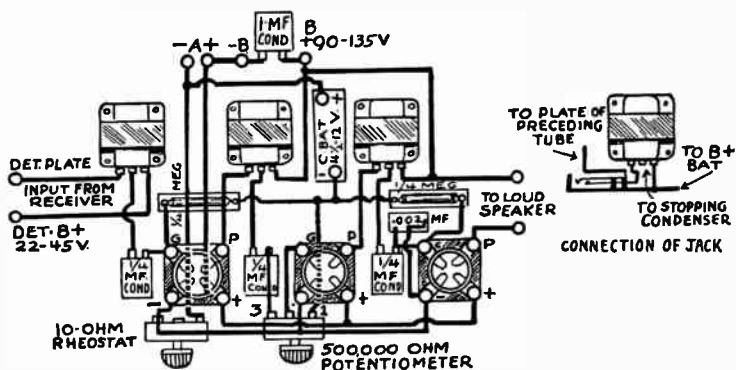

FIG. 2.—Layout of Step-Up Impedance Amplifier.

These tapped impedance amplifiers which give a step-up voltage ratio cannot be used with high Mu tubes. When such tubes are employed these impedances should be used as straight choke coupling by disregarding the tap terminal to which the plate lead of the preceding tube would normally be connected. The plate lead of this preceding tube is then connected to the same terminal of the impedance to which is connected one side of the stopping condenser.

Using a grid leak of comparatively small resistance will increase the volume limit although there will be a slight loss in uniformity of amplification. One-quarter megohm leaks are about right for all stages except the last, which may have a one-tenth megohm leak.

Chokes and impedances used for coupling cannot be reflexed because the primary and secondary circuits are not electrically insulated from each other as in a transformer having insulated primary and secondary windings. See also *Receiver, Audio Amplifier for*.

AMPLIFIER, AUDIO FREQUENCY, IMPEDANCE, DOUBLE TYPE.—The double impedance audio amplifier uses an impedance, an iron-cored choke coil, in the plate circuit of one tube, a second similar impedance in the grid circuit of the fol-

AMPLIFIER, AUDIO FREQUENCY, IMPEDANCE COUPLED

lowing tube and couples the two circuits through a condenser. The connections for such an amplifier are shown in Fig. 1.

The capacity of the coupling condenser depends on whether it is desired to tune the grid circuit at some low frequency. Increased amplification at or near any desired frequency may be obtained by selecting values of reactances for the grid choke and coupling condenser which together produce a resonant circuit at the frequency chosen. The resonant frequency is determined from the following formula:

$$\text{Cycles at Resonance} = 6.283 \times \frac{1,000}{\sqrt{\text{microfarads in coupling condenser} \times \text{henrys in grid choke}}}$$

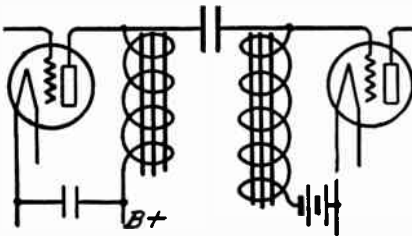

FIG. 1.—Double Impedance Amplifier.

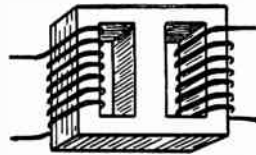

FIG. 2.—Double Impedance Windings.

The following table, at the intersection of columns of capacity and lines of inductance, shows the approximate frequency of resonance for commonly used values of inductance and capacity:

RESONANT FREQUENCY IN CYCLES FOR TUNED DOUBLE IMPEDANCE

Inductance of Grid Choke in Henrys	Capacity in Microfarads of Coupling Condenser							
	0.0075	0.01	0.012	0.015	0.02	0.03	0.05	0.1
150	150	130	118	106	92	75	58	41
200	130	113	103	92	80	65	50	36
250	116	101	92	64	71	58	45	32
300	106	92	84	75	65	53	41	29

The effect of tuning the coupling circuit to a given frequency is to raise the amplification curve rather sharply at this point. A sharp rise results from low impedance in the tuned circuit. The resonant peak may be broadened by inserting an adjustable resistor between the grid choke and the grid

AMPLIFIER, AUDIO FREQUENCY, POWER TYPE

bias connection. The maximum value of this resistor should be about 5000 ohms.

The two impedances have no intentional coupling, either electromagnetic or electrostatic, other than that through the coupling condenser. They may be wound on separate cores and enclosed in separate cases, they may be wound on separate cores within a single case or they may be wound on the two outer legs of a "figure 8" core as in Fig. 2. This type of coupling provides a path of low direct current resistance between the grid and filament circuit of the second tube and blocking is prevented by the ease with which excess negative charges flow away from the grid. The impedance in the grid circuit is high due to an inductance of from 150 to 250 henrys. This high impedance insures the application of suitable alternating current voltages to the grid. The inductance of the plate choke is generally higher than that for the grid choke so that the preceding tube may work to advantage and produce a considerable rise and fall of voltage across the plate impedance. These voltage variations are applied to the following grid circuit through the coupling condenser.

AMPLIFIER, AUDIO FREQUENCY, POWER TYPE.

—A power amplifier, as generally constructed, consists of one or more stages of audio frequency amplification, including the output stage, together with filament supply for all tubes in the amplifier and high voltage plate current supply for all tubes, both in the amplifier and the connected receiver. In addition, a power amplifier often furnishes field current for the operation of dynamic loud speakers. These amplifiers are used with radio receivers and also with phonographs as described under *Amplifier, Phonograph Type*.

A power amplifier may be attached to any existing receiver, taking the place of the last audio frequency stage in the receiver in all cases and in some arrangements, replacing the entire audio frequency amplifier and coupling directly to the detector tube of the receiver.

Since practically all receivers as originally built have at least a small power tube in their output stage, the power amplifiers are found to embody one of the larger sizes of power tubes or else to embody a push-pull stage of amplification using any type of power tube. See also *Amplifier, Audio Frequency, Push-Pull Type*.

In using amplifiers capable of delivering one watt or more of undistorted power from the output stage, it is essential that the power tube grid circuits be operated with sufficient voltage to obtain worth while results. In the design of such units it is assumed that the detector is capable of delivering from one-tenth to one-half volt in the primary of the coupling unit which follows: If the detector output is less, it should be increased by using more radio frequency amplification.

Such complete outfits are shown in Figs. 1 to 4. Figs. 1 and 2 both show the same amplifier, Fig. 1 being a circuit diagram and Fig. 2 a typical layout using the same parts. Figs. 3 and 4 both show a second type of amplifier, Fig. 3 being a circuit diagram and Fig. 4 a layout of the parts.

With a few exceptions the two outfits are alike. The amplifier of Figs. 1 and 2 uses a full-wave rectifying tube, uses resistances for the entire control of plate voltages and uses a transformer for coupling the power tube to the loud speaker. The amplifier of Fig. 3 and 4 uses a half-wave rectifying tube, uses a voltage regulating tube for the control of one plate voltage and uses a combina-

AMPLIFIER, AUDIO FREQUENCY, POWER TYPE

tion of choke and condenser for coupling the power tube to the speaker.

An examination of Figs. 1 and 3 will show that the portion of the outfit above the horizontal broken line is simply a power amplifier consisting of the power tube with its input and output couplings. The portions of both outfits below the horizontal broken lines are nothing more than plate voltage supply units employing a power

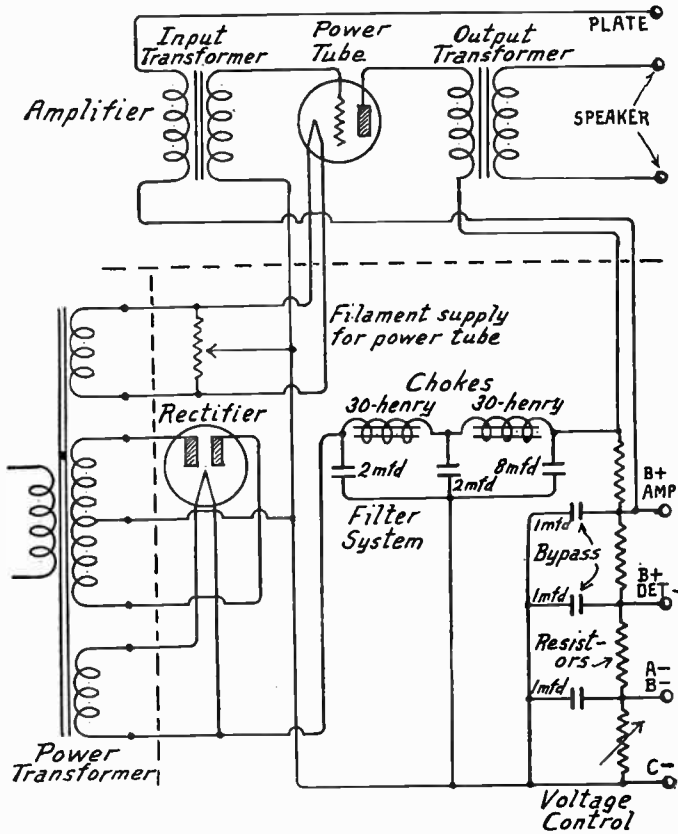

FIG. 1.—Complete Power Amplifier with Full Wave Rectifier.

transformer with additional windings for lighting the tube filaments. Any power amplifier might be thus connected to any plate supply.

Again looking at Figs. 1 and 3 it will be seen that the entire power transformer is at the left hand side of the vertical broken lines in each case. Each transformer has a single primary winding and three secondary windings. One of the secondaries furnishes the high voltage which is rectified and filtered for plate voltage.

AMPLIFIER, AUDIO FREQUENCY, POWER TYPE

Another of the secondaries lights the filament of the rectifying tube. The third secondary lights the filament of the power tube.

Three separate transformers might be used just as the one large transformer with its three secondary windings. The high voltage might be supplied from a transformer designed for a unit giving only plate voltage supply. The filament lighting might be handled with separate small transformers suited for this work. Of course it would not be possible to follow the exact connections of Fig. 3 unless the filament transformers had center taps, but the same result may be had with the use of a potentiometer across a secondary as shown in Fig. 1.

The chokes and condensers in the filter are the same as similar units used in any type of plate voltage supply unit. The values of the voltage regulating

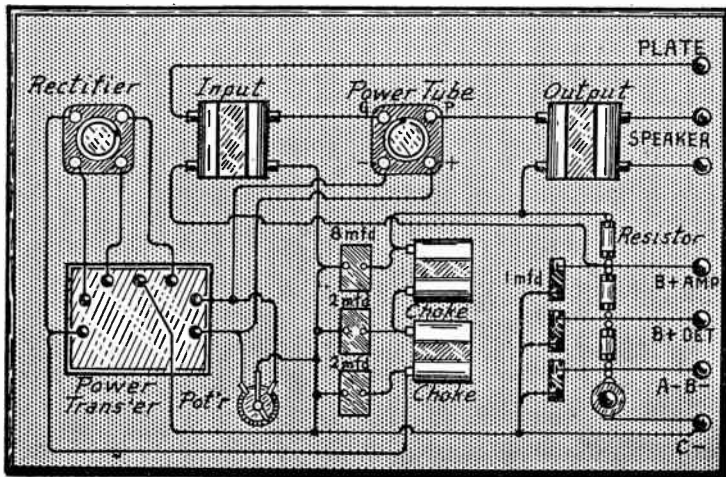

FIG. 2.—Layout for Power Amplifier with Full Wave Rectifier.

resistances between the plate voltage terminals will be determined by the characteristics of the power transformer and the rectifier tube. The bypass condensers placed across the regulating resistances may all be of one microfarad capacity.

The terminal marked "Plate" on the amplifier unit is connected to the plate terminal of the first or second audio frequency amplifying tube in the receiver to be used with the amplifier. This connection may also be made to the plate terminal of the detector tube, but with a considerable reduction in volume. The loud speaker is connected to the two terminals marked "Speaker" in the diagrams.

The A-battery is left connected to the filament circuits of the receiver as usual, since no filament current for the tubes in the receiver is furnished by the power amplifier unit. The B-battery terminals of the receiver are connected to the plate voltage terminals of the power amplifier unit. There are two of these terminals provided, one for the detector plate voltage and the other for the radio frequency and audio frequency amplifier tubes of the receiver.

AMPLIFIER, AUDIO FREQUENCY, POWER TYPE

The negative terminal of the A-battery is connected to the power unit terminal marked "A-B-." A negative biasing voltage for the receiver's audio amplifying tubes is provided from the amplifier unit terminal marked "C-." The terminal marked "C-" on the receiver is connected to this terminal of the amplifier unit. The resistance between the "A-B-" terminal and the "C-" terminal is made variable so that any needed biasing voltage may be obtained. A variable resistor adjustable between 1000 and 2000 ohms will be satisfactory at this point.

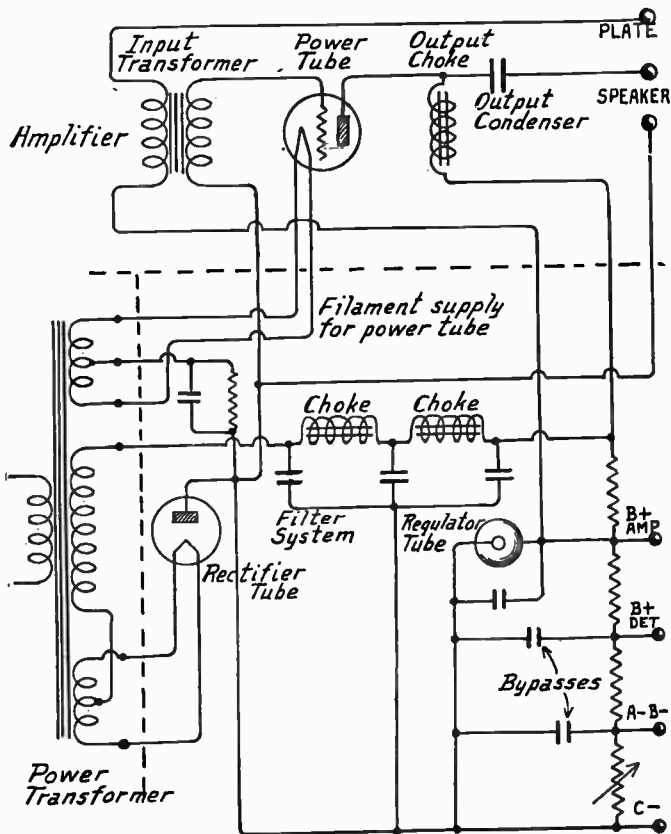

Fig. 3.—Complete Power Amplifier with Half Wave Rectifier.

The amplifier unit thus connected does away with the need of any B-batteries or any C-batteries for the receiver as well as for the power unit. The only additional unit required is an A-battery or filament power unit furnishing filament current to the radio frequency amplifying tubes, the detector tube and the audio frequency amplifying tubes in the receiver to which the amplifier unit is attached.

These circuits and layouts illustrate two of the combinations which may be made up from the several units entering into power amplifiers of the self-contained type. The possibilities of designing other arrangements to be built

AMPLIFIER, AUDIO FREQUENCY, PUSH-PULL TYPE

from standard apparatus are almost limitless and the constructor may easily choose such parts as meet the needs of certain installations, then combine them into compact units along the general lines shown here.

In the layouts shown by Figs. 2 and 4 the apparatus is distributed over a larger space than need be used when space is at a premium. With properly built and shielded parts it is possible to place the transformers, chokes and

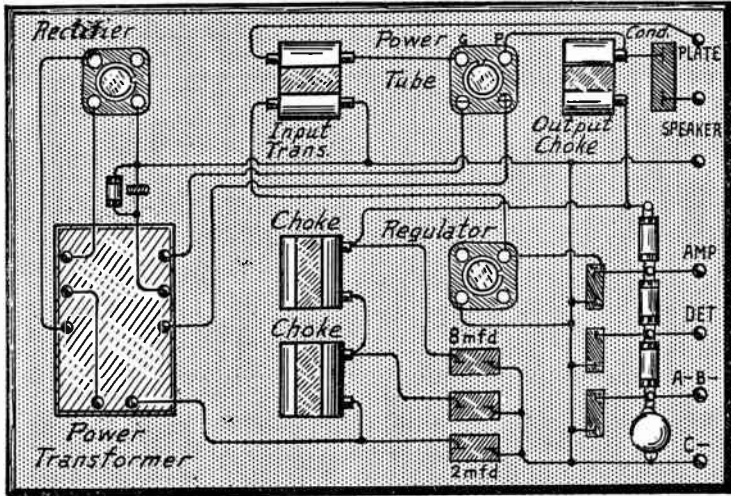

FIG. 4.—Layout for Power Amplifier with Half Wave Rectifier.

filter condensers so close together that their cases touch one another. It is best to allow at least two inches separation between parts entering into the audio amplifier stage and the parts entering into the construction of the power unit, or shielding may be used in the position shown by the horizontal broken lines in Figs. 1 and 3 to avoid the picking up of alternating current hum by the amplifier.

AMPLIFIER, AUDIO FREQUENCY, PUSH-PULL TYPE.—A push-pull amplifier is one in which grid voltage changes are applied simultaneously to two tubes so connected that increasing grid voltage on one tube is accompanied by decreasing grid voltage on the other. The resulting plate current changes, which are opposite in direction for the two tubes, are passed through an output coupling device in such a way that their effects add together. One tube tends to push plate current through the coupler while the other tube tends to pull it through in the same direction, this action accounting for the name of the amplifier.

The circuits of the special transformers and the tubes are shown in Fig. 1. The input transformer includes a primary winding which is connected to the plate circuit of one stage of ordinary audio amplification. This input transformer uses a split secondary winding having a grid terminal at each end and a tap used as a common filament terminal at the electrical center. This center tap is connected

AMPLIFIER, AUDIO FREQUENCY, PUSH-PULL TYPE

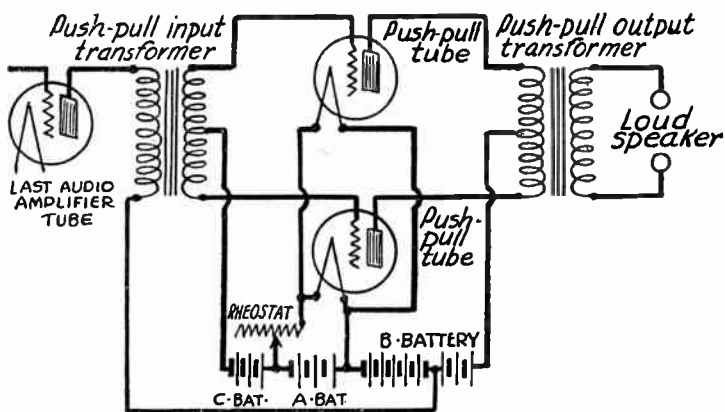

FIG. 1.—Circuits of the Push-Pull Amplifier.

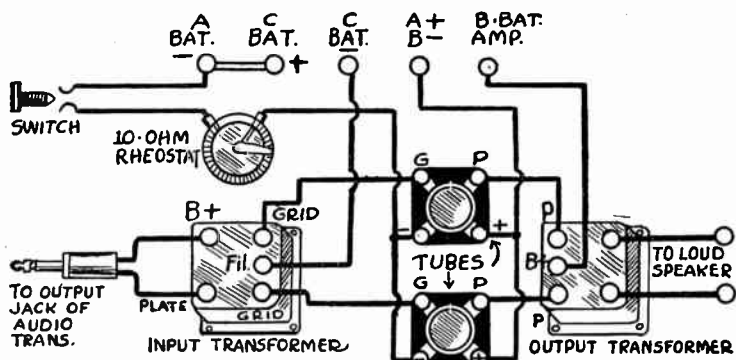

FIG. 2.—Layout for Single Stage of Push-Pull Amplification.

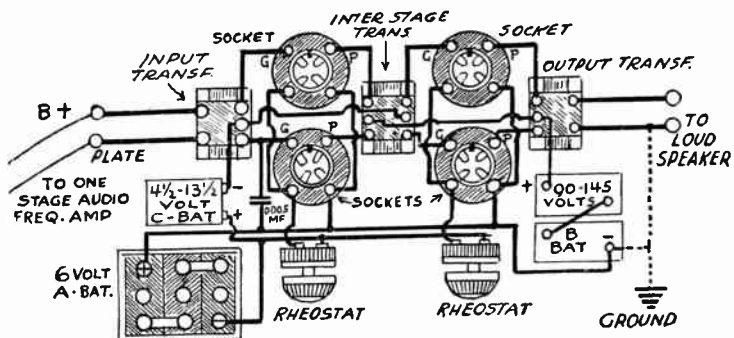

FIG. 3.—Two Stages of Push-Pull Amplification.

AMPLIFIER, AUDIO FREQUENCY, PUSH-PULL TYPE

through a C-battery to the filaments of the tubes in the usual way. The two grid terminals are connected to the grids of the two tubes.

The output transformer has a split primary winding with plate terminals at its two ends and a B-battery terminal brought out from the electrical center of the primary winding. This output transformer has a single secondary winding which is connected to the speaker.

In the double secondary of the input transformer we have a drop of voltage at one of the grid terminals at the same time we have a rise of voltage at the other grid terminal. Since both parts of the secondary are coupled to the same primary in the transformer, rise and fall of plate current fed into the primary causes rise and fall of

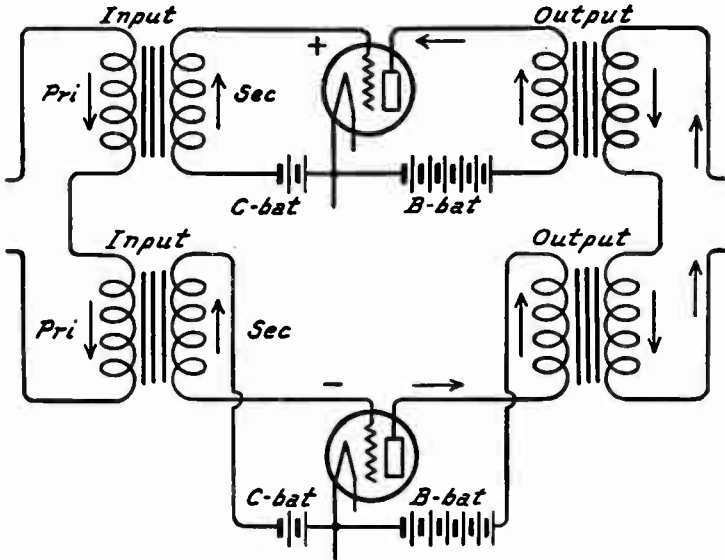

FIG. 4.—Separate Transformers Arranged for Push-pull Amplification.

voltage in the split secondary. Considering either terminal of the secondary, we first get a rise of voltage which is accompanied by a fall of voltage at the other end; then get a fall of voltage accompanied by a rise at the other end.

This action first lowers the voltage on one grid terminal and then lowers it on the other grid terminal. The grid voltage of one tube drops during one half the signal wave while during the other half of the wave the grid voltage of this tube rises. The grid voltage rise and fall in the second tube is always opposite to the rise and fall in the first one.

AMPLIFIER, AUDIO FREQUENCY, PUSH-PULL TYPE

The outputs from the plates of the two tubes combine in the split primary of the output transformer and their combined effect passes to the output transformer's secondary.

All of the connections and the most suitable values for all parts in the construction of a push-pull amplifier are shown in Fig. 2. It is also possible to use two stages of push-pull amplification by employing an interstage transformer according to the layout shown in Fig. 3.

The action of a push-pull amplifier may be understood from Figs. 4 and 5. In Fig. 4 are shown two amplifying tubes, each connected to its own separate input transformer and output transformer. The varying plate current from a preceding tube is assumed to flow in the direction of the arrows through the primary sides of both input transformers. Since this current flows through both transformers in the same direction, the voltages in their secondary windings will be similar, both windings being positive at the top and negative at the bottom for the instant being considered. The top of the upper input transformer is connected to the grid of its tube, while the bottom

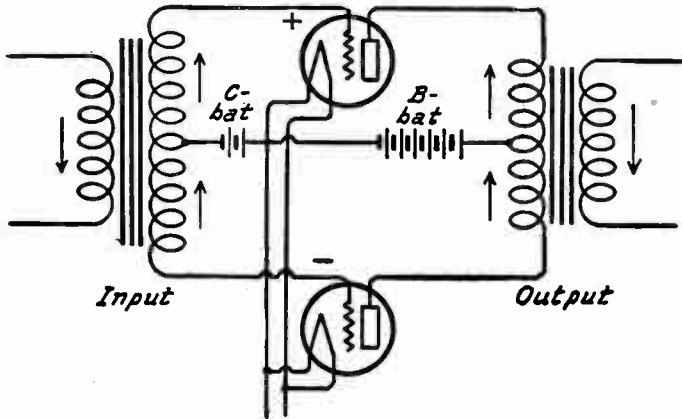

FIG. 5.—Transformers Combined in Push-pull Amplifier.

of the lower input transformer is connected to the grid of the lower tube. Thus, the grid of the upper tube is being made more positive in voltage while the grid of the lower tube is becoming more negative.

Making the grid of a tube more positive will increase the flow of plate current through that tube, while making the grid more negative will decrease the plate current. Therefore, in the upper tube, the plate current is flowing toward the plate at an increasing rate as shown by the arrow. At the same time, the plate current of the lower tube is decreasing and in effect is flowing away from the plate as indicated. Because the connections to the primary side of the lower output transformer are reversed from those to the upper output transformer, current flow is from bottom to top in both transformers. This flow of current in the primary windings will cause voltages in the output transformer secondary windings which act together and the two secondary windings will add their effects since they are connected together.

It will be realized that the effect of plate current change in the upper output transformer is added to the effect of current change in the lower output trans-

AMPLIFIER, AUDIO FREQUENCY, PUSH-PULL TYPE

former. The effort of one tube in increasing its plate current is added to the effort of the other in decreasing the current.

The two B-batteries of Fig. 4 may be replaced with a single battery, and since one end of each output transformer primary goes to the battery, these ends may be joined. Similarly, one end of each input transformer secondary goes to the tube filament circuit and since both filaments would operate from a single supply, these secondary ends may be joined. With the one winding of each of the transformers joined to the similar winding of its mate, the remaining windings might as well be joined with the result shown in Fig. 5.

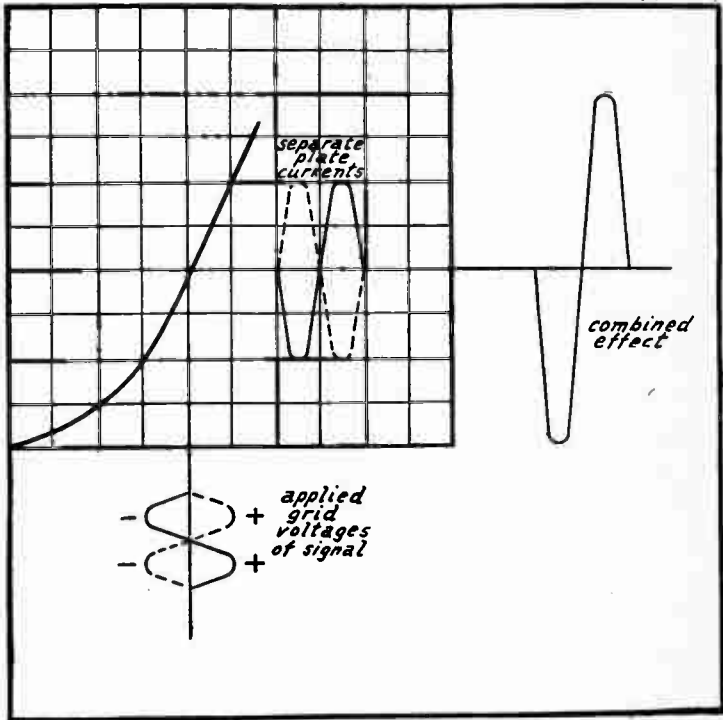

FIG. 6.—Combining of Signals in Push-pull Amplifier.

This diagram shows the center-tapped secondary winding of the single input transformer and the center-tapped primary winding of the single output transformer ordinarily employed for push-pull amplification.

In Fig. 6 is shown the effect of the two tubes working together. The signal voltage changes applied to the grids are indicated at the bottom, below the curve showing the relation between grid voltage and plate current. The voltage applied to one tube is shown in a full line and that for the other tube in a broken line. It is seen that these two voltages are equal in value but opposite in polarity or phase. The resulting plate current changes are shown at the right of the curve. The plate current changes, like the grid voltage changes, are equal and opposite. It will be recalled from the preceding explanation that there is a reversal of winding connection in one part of the

AMPLIFIER, AUDIO FREQUENCY, PUSH-PULL TYPE

output transformer. This reversal has the effect of reversing the effect of one tube's plate current change so that the full line curve and the broken line curve add their effects with the result of a much greater total change as shown at the extreme right hand side of Fig. 6.

Because of the compensating action of the two tubes, conditions which would cause either one alone to distort will balance out and leave true reproduction of input voltages. In the section on *Distortion* it is shown that a positive grid voltage will cut off one side of the signal, while too great a negative grid voltage will result in cutting off the other side of the signal. Incorrect grid bias will result in these conditions and they will be also brought about by a signal strong enough to swing the grid voltage too far either way.

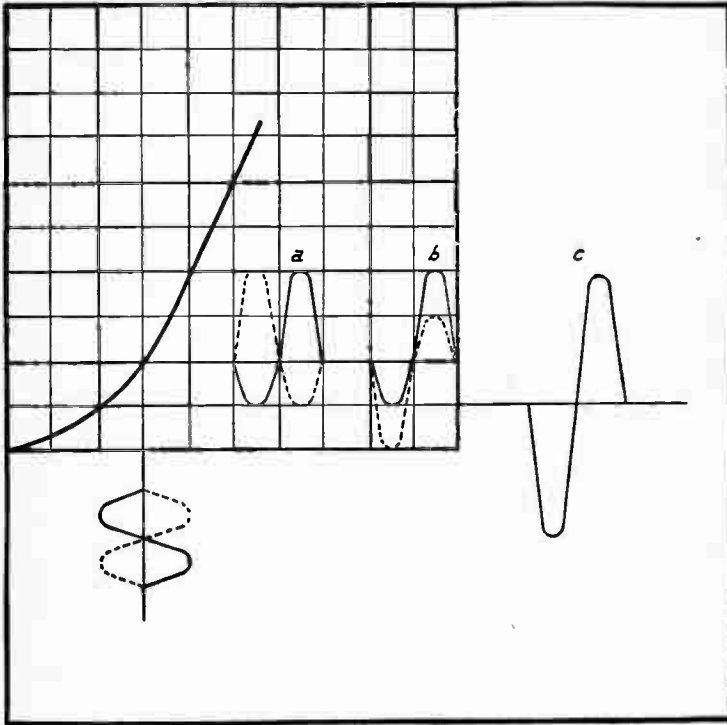

FIG. 7.—Elimination of Distortion in Push-pull Operation.

In Fig. 7 is shown the effect of applying the grid voltages on a part of the grid voltage-plate current curve that causes each tube to distort. For an equal applied grid voltage the decrease in plate current is much less than the corresponding increase as shown at *a*. The output transformer connection serves to make the current changes assist each other, in effect reversing one of them as at *b*. The combined effects produce the greater change at *c*. Here it is found that the large change of the broken line curve at *b* is combined with the smaller change of the full line curve to produce the first half of curve *c*, while the large change of the full line curve combines with the smaller one of the broken line curve to produce the second half of curve *c*.

AMPLIFIER, AUDIO FREQUENCY, PUSH-PULL TYPE

The result is that both parts of curve *c* are alike in extent and two distorted results have been combined into one which is free from distortion.

The total voltage developed across the secondary of the input transformer in Fig. 5 is applied to the two tubes together, consequently each tube is acted upon by half the transformer voltage. For this reason, a push-pull amplifier requires twice the input grid voltage required by a single tube of the same type if the push-pull arrangement is to show an advantage over a single tube in volume of output.

Under the heading of *Bias, Grid* it is shown in Fig. 3 that too great a negative bias on a single tube will result in distortion. From the explanation of Fig. 7 given here it is shown that such a negative bias will not cause distortion with a push-pull arrangement. The greater the negative bias the greater the grid voltage which may be handled without causing the grid to become positive at times and with push-pull amplification it is possible to use more than twice the amount of negative bias allowable for a single tube. Therefore, a push-pull amplifier using a given type of tube will handle more than

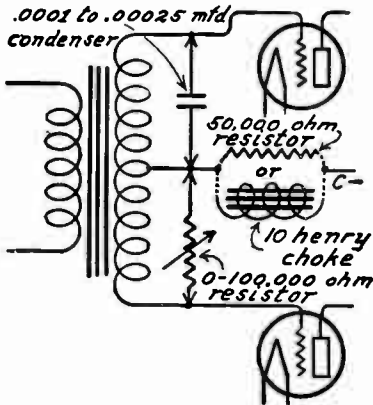

FIG. 8.—Remedies for Incorrect Design.

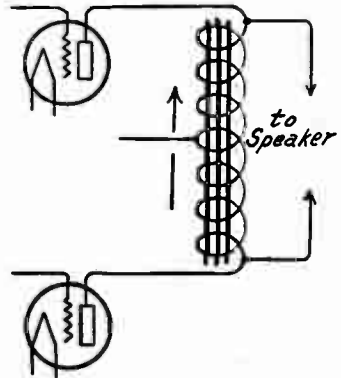

FIG. 9.—Output Choke for Push-pull Amplifier.

twice the incoming voltage that may be applied to a single tube of the same kind.

Provided that the coupling transformers are correctly designed, that the wiring is correctly laid out, and that the two tubes have identical operating characteristics, push-pull amplification will be without distortion even with very large applied grid voltages. If any of these conditions are not satisfied there will be a form of distortion. It may be evidenced in the production of harmonics, in audio frequency oscillation, or in failure to produce plate current changes which correspond in maximum value to the applied grid voltages. With poorly designed transformers or unsymmetrical wiring it may be necessary to place small (0.00025 mfd.) bypass condensers or adjustable resistors across one or the other halves of the input transformer secondary as in Fig. 8. It may also be necessary to place a ten-henry choke coil or a 50,000-ohm resistor in the line connected to the input transformer secondary center tap.

With alternating current filament operation and with power unit plate current supply, the tendency to produce a hum is much less with a push-pull amplifier than with a single tube. This is true because the disturbing elements

AMPLIFIER, AUDIO FREQUENCY, RESISTANCE COUPLED

balance each other in the two tube circuits and do not appear in the output.

In place of the output transformer shown in Fig. 5, it is possible to use a double choke coil for a speaker connection as in Fig. 9. Current changes take place through this choke just as they take place through the primary of an output transformer and the voltage differences between the two ends are applied to the speaker. This arrangement cannot be used to match the impedances of tubes and speakers, consequently should not be employed unless the plate resistance of the tubes being used is within the limits of 80 to 125 per cent of the speaker input impedance in ohms. With low impedance tubes and a high impedance speaker, or with the opposite relation, an impedance matching output transformer should be used.

AMPLIFIER, AUDIO FREQUENCY, RESISTANCE COUPLED.—A resistance coupler consists essentially of three parts. First a high resistance in the plate circuit, second a fixed condenser used as a coupling condenser or stopping condenser between the plate of one tube and the grid of the following tube, and third a grid leak for the following tube. The arrangement of these parts is shown in Fig. 1 and the circuit in Fig. 2. For layouts and specifications see *Receiver, Audio Amplifier* for.

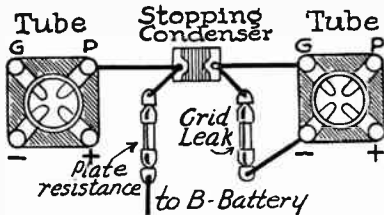

FIG. 1.—Arrangement of Parts for Resistance Coupled Amplifier.

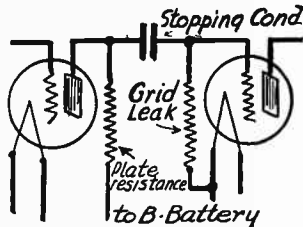

FIG. 2.—Circuits of Resistance Coupled Amplifier.

Flow of plate current through the plate resistance causes a voltage drop across this resistance. The changes in voltage or voltage drop across the plate resistance are carried through the stopping condenser and applied to the grid of the following tube.

The stopping condenser allows the voltage changes, which are alternating, to pass through it but prevents the positive plate voltage of the B-battery from reaching the grid of the following tube.

The purpose of the grid leak is to allow the excess negative charges to leak off or escape from the grid of the second tube. Were these negative charges allowed to accumulate they would finally force this grid to such a negative voltage that the flow of plate current in the second tube would be entirely prevented. The tube would then block and stop the signals. See *Leak, Grid*.

For a resistance coupled amplifier it is necessary to provide at least 135 to 150 volts at the B-battery or power supply in order to overcome the high resistance inserted in the plate circuit and still apply a sufficient positive voltage to the plate of the tube to cause the necessary flow of plate current in the tube.

AMPLIFIER, AUDIO FREQUENCY, RESISTANCE COUPLED

Plate resistances are usually 100,000 ohms each for all stages in either a three-stage or four-stage resistance coupled amplifier. In a three-stage amplifier the grid leak for the first amplifier tube should be be 1,000,000 ohms or one megohm, for the second tube 500,000 ohms or one-half megohm, and for the third tube 250,000 ohms or one-quarter megohm. In a four-stage resistance amplifier

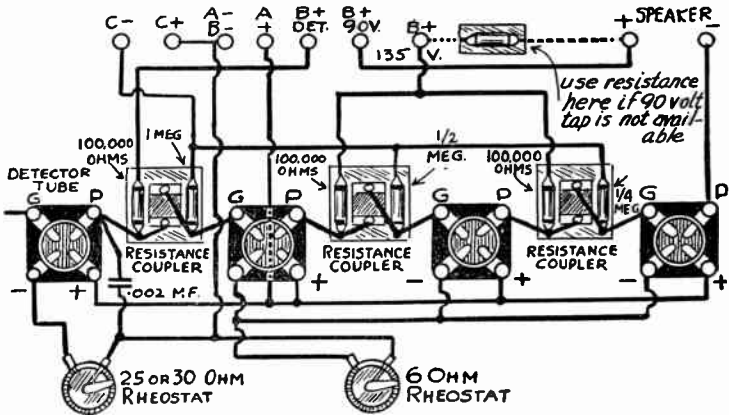

FIG. 3.—Arrangement of Parts in Three-Stage Resistance Amplifier.

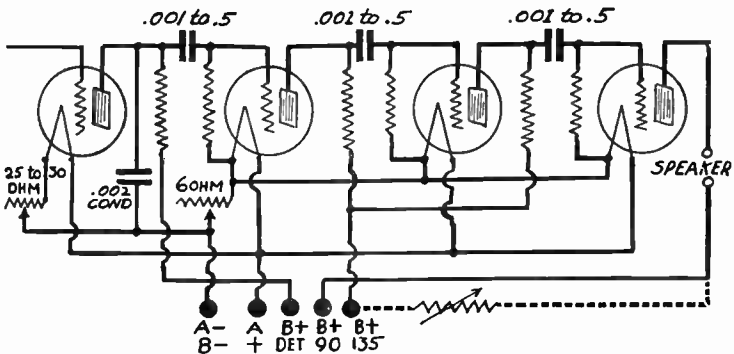

FIG. 4.—Circuit Diagram of Three-Stage Resistance Amplifier.

the grid leaks for the first three tubes should be the same as those in a three-stage amplifier, while for the fourth tube the leak should be 100,000 ohms or one-tenth megohm.

The plate voltage for the last tube should be lower than for the first two tubes unless this tube is a power type. When using only a voltage amplifier connected to the 135-volt terminal there should be a resistance in series with the lead to the plate of the last tube. This resistance should be between 5000 and 50,000 ohms. It is shown in

AMPLIFIER, AUDIO FREQUENCY, RESISTANCE COUPLED

Fig. 3. Stopping condenser values are not especially critical and may be between .001 and 0.5 microfarad.

In resistance coupled amplifiers the plate current decreases with the strength of the signal. The stronger the signal on the grid of the tube the less will be the flow of plate current. We say that the plate current modulates down, whereas in a transformer coupled amplifier it modulates up.

A three-stage resistance coupled amplifier uses only a little more than three-fourths the plate current used by two stages of transformer coupling in spite of the fact that much higher B-battery or plate voltage is used with resistance coupling.

A resistance coupled amplifier cannot be used directly after an antenna and a crystal detector because the exceedingly small antenna current, which is the only current through the crystal, is not enough to produce the necessary voltage changes across the high resistance. When a crystal detector is used with radio frequency amplification ahead of the crystal, the crystal may be immediately followed by stages of resistance amplification.

The higher the resistance of the grid leaks the louder will be the signals from the amplifier. However, too high a resistance in the grid leak will cause distortion and blocking.

Persistent howling sometimes may be corrected by changing the value of the grid leaks. It may be eliminated by increasing the plate resistance for the third tube or for both the second and third tubes to as high as 250,000 ohms in place of the usual 100,000 ohms.

In a resistance coupled amplifier a higher plate voltage is used for the detector tube circuit than is used with transformer coupling. When a jack is used in the detector plate circuit of a resistance amplifier the comparatively low resistance of headphones when plugged in prevents the tube from acting as a detector. If a jack is used following the detector it will be necessary to reduce the plate or B-voltage on the detector or to use a resistance in series with the headphones while they are in use. Connections for jacks are shown under the heading *Jacks and Jack Switches, Uses of*. Figs. 3 and 4 show complete details with the values of all units in the construction of a resistance coupled amplifier.

Resistance and Transformer Combination.—Fig. 5 shows the use of one transformer coupled audio frequency stage followed by two resistance coupled stages. The transformer coupled stage follows the detector tube and feeds into the first amplifier tube. Values of stopping condensers, plate resistances and grid leaks are the same as in the regular resistance coupled amplifier.

The combination of one stage of transformer coupled amplification followed by two stages of resistance coupling makes a very satisfactory audio amplifier. The tone quality is excellent, the volume is ample for all purposes and there is no trouble with blocking or instability. The arrangement of parts and the wiring for such an amplifier is shown in Fig. 6.

The diagram of Fig. 6 starts with the detector, to the grid terminal of which is connected the usual grid condenser and grid leak. The detector filament is handled with a rheostat of from ten to twenty ohms resistance for quarter-ampere tubes. The filaments for all other tubes are controlled with filament resistors marked R. The audio transformer may be of low ratio, preferably around two-to-one or three-to-one. The usual plate bypass condenser of .002 microfarad capacity is connected to the plate terminal of the detector tube.

The two plate resistances marked P should be one-tenth megohm each. The grid leak for the first resistance coupled tube should be between 500,000 and 250,000 ohms and the leak for the second tube should be between 250,000 and 150,000 ohms. The stopping condensers C may be as small as .006 micro-

AMPLIFIER, AUDIO FREQUENCY, TRANSFORMER

farad capacity but larger capacities, up to one microfarad, will improve the amplification of low notes. These stopping condensers must be able to stand the high voltages applied to the plates.

The last tube is assumed to be of the power type. Its plate voltage is applied through the battery terminal marked "B+ Power" and its biasing voltage is applied through the terminal marked "C- Power."

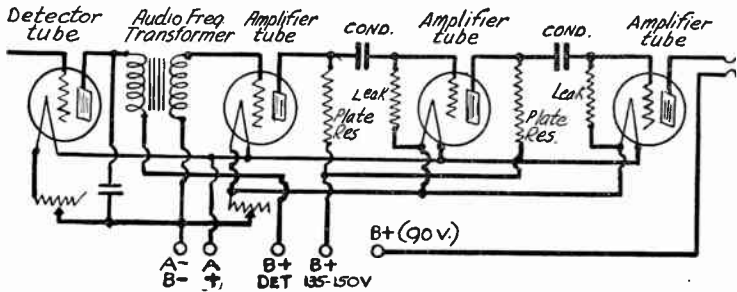

FIG. 5.—Amplifier with Two Resistance Stages and One Transformer Stage.

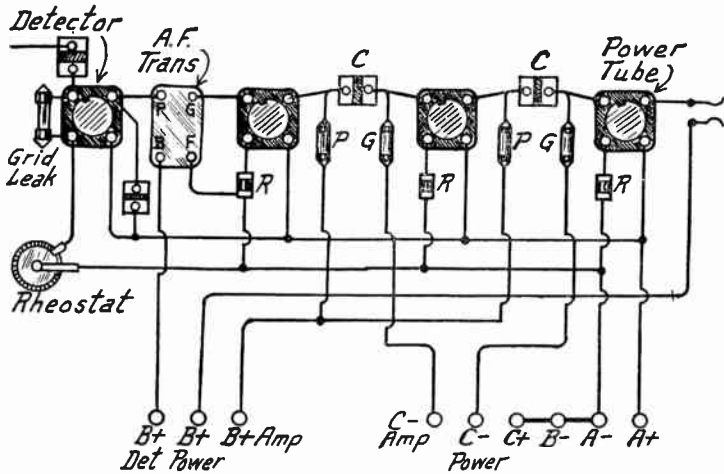

FIG. 6.—Layout of Amplifier with Two Resistance Stages and One Transformer Stage.

In any resistance coupled amplifier better amplification and volume will be secured from the use of high Mu tubes in all except the last stage. The last tube should be of the usual amplifying type or may be a power tube but all tubes between the detector and this last one may be of the high Mu type. The B-battery connections shown in Fig. 6 are adapted to the use of high Mu tubes as described. See *Tube, Amplifying Types of*. Testing of resistance coupled amplifiers is described under *Oscillator, Audio Frequency, Uses of*.

AMPLIFIER, AUDIO FREQUENCY, TRANSFORMER

AMPLIFIER, AUDIO FREQUENCY, TRANSFORMER COUPLED.—The transformer coupled audio amplifier is more commonly used than any of the other types. In this amplifier the coupling between tubes is formed by an iron-core transformer having separate and insulated primary and secondary windings as in Fig. 1. The cores provide closed magnetic circuits. Audio frequency transformers have step-up turn ratios of from one and one-half to one up to ten to one. The operating characteristics and various details relating to these units are taken up under the heading of *Transformer, Audio Frequency*, which may be referred to. Here are considered only the uses of such transformers in a practical amplifier unit. For layouts and specifications see *Receiver, Audio Amplifier* for.

As a general rule better and more uniform amplification will be obtained when using low turn ratios rather than high turn ratios in the transformers. Unless the transformers are of large size and have large cores of high grade steel it is not advisable to use ratios greater

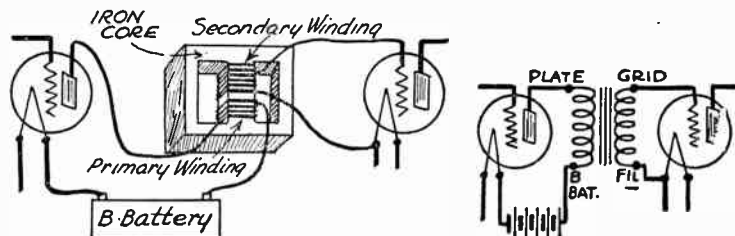

FIG. 1.—Transformer Coupling for Audio Frequency Amplifier.

than three and one-half to one or four to one. Greater volume on some notes may be obtained with ratios as high as six to one or even ten to one but this volume is obtained only on certain frequencies and the amplification at higher and lower notes is far from good.

Should transformers of two or more different ratios be used in the same amplifier, the transformer having the lowest ratio should immediately follow the detector tube because the plate resistance of the detector is high and it is better matched by the comparatively high primary impedance of a low ratio transformer.

Layout of Amplifier.—In laying out the amplifier the tubes and transformers should be arranged to make the grid leads as short as possible. The plate leads should be considered next and should likewise be as short as they can be made without undue crowding of parts. See *Receiver, Audio Amplifier* for.

The relative position of tubes and transformers depends to a great extent on the location of the grid, plate and filament terminals on the transformers. These locations differ with different makes of instruments.

AMPLIFIER, AUDIO FREQUENCY, TRANSFORMER

From an examination of the terminal arrangement of various transformers, the top views of which are shown in Fig. 2, it will be found that, starting with the plate terminal and proceeding either clockwise or anti-clockwise around the four terminals their order is usually as follows: Plate, Positive-B, Negative Filament, Grid. With some makes of transformers, starting at the plate terminal, this order follows to the right or clockwise, while with others it follows to the left, or anti-clockwise.

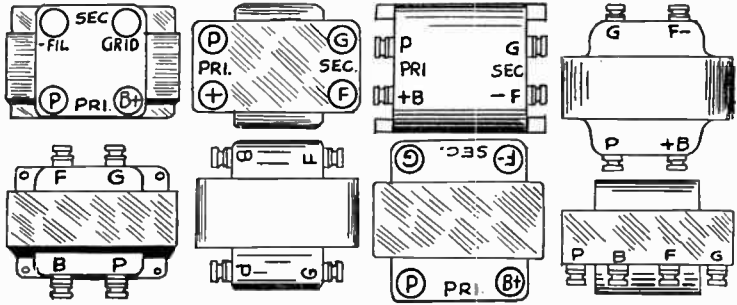

FIG. 2.—Terminal Arrangements on Audio Transformers for Amplifiers.

All audio frequency transformers have four terminals. One is the plate terminal to which is connected a lead from the plate terminal of the preceding tube. This plate terminal may be marked "Plate," "PL," or "P." On the same side of the transformer is the positive B-battery terminal from which a line runs to the positive connection of the B-battery or the power unit furnishing plate voltage to the preceding tube. This terminal may be marked "Pos-B," "B+," "B," or any other marking that indicates this connection. These two terminals, plate and B-battery, are the terminals of the primary winding of the transformer and on the side of the transformer carrying these terminals may be found the marking "Primary," "Prim" or "Pri."

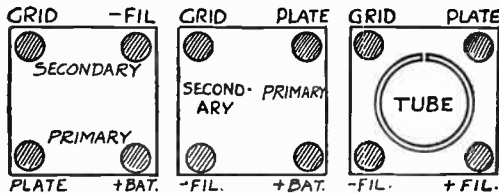

FIG. 3.—Similarity of Amplifier Transformer and Tube Terminals.

On the opposite side of the transformer from that carrying the primary terminals will be found the terminals for the secondary winding, that is, the grid and the negative filament terminals. From the grid terminal, marked "G" or "Grid," a connection is made to the grid terminal of the following tube. The negative filament terminal, which is always on the same side as the grid terminal, may be marked "Fil," "F—" or "F." Depending on the construction of the amplifier this filament terminal of the transformer may be connected to the negative side of a C-battery, to the A-battery terminal of a rheostat, to a biasing voltage in a power unit, or directly to the negative filament terminal of the following tube.

The two typical arrangements of transformer terminals are shown side by side in Fig. 3 and at the right is shown for comparison the terminal arrange-

AMPLIFIER, AUDIO FREQUENCY, TRANSFORMER

ment on a standard tube socket. It will be seen that one of the transformer arrangements is similar to the arrangement of the tube terminals except that on the transformer the positive B-battery terminal takes the place of the positive filament terminal on the tube.

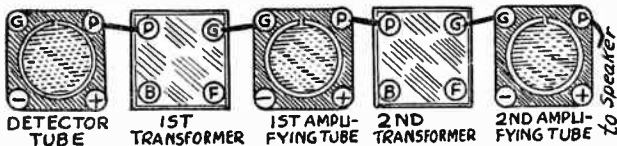

FIG. 4.—Audio Amplifier with Output at Right.

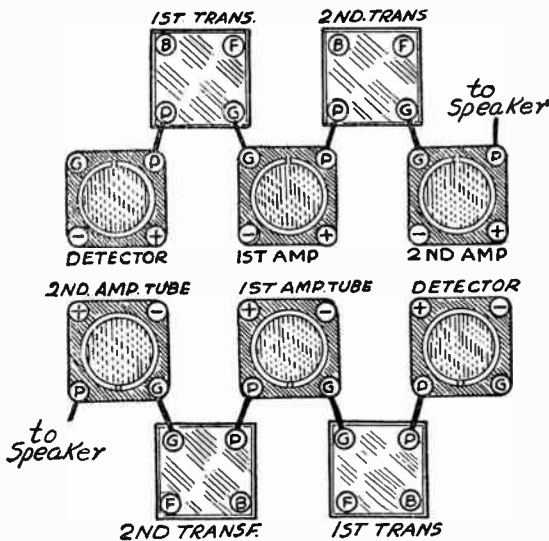

FIG. 5.—Audio Amplifiers with Tubes Back of and in Front of Transformers.

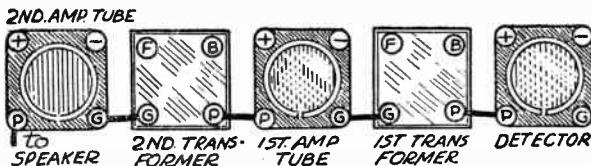

FIG. 6.—Audio Amplifier with Output at Left.

A number of satisfactory arrangements of detector tube, amplifier tubes and audio frequency transformers are shown in Figs. 4, 5 and 6. All of these plans provide the shortest possible grid leads and plate leads. In Fig. 4 the transformers are placed directly between the tube sockets and the final output to the loud speaker is at the right hand end. In Fig. 5 the transformers

AMPLIFIER, AUDIO FREQUENCY, TRANSFORMER

are placed either back of or in front of the tubes with the output at the right or at the left. Fig. 6 is similar to Fig. 4 except that the output to the speaker is at the left. Which of these plans is adopted depends on the space available, the general plan of the receiver and the type of transformer to be used.

Number of Stages.—Transformer coupled amplifiers may be constructed with one, two or three stages. More than three stages are not practical because of the difficulties in the way of feedbacks and noises generated and amplified in the various units. A single-stage audio amplifier of the transformer type will give sufficient volume to receive local and nearby stations on a loud speaker under average conditions. A properly constructed two-stage transformer coupled amplifier, the type used in the majority of receivers, will do good work with loud speaker volume for considerable distances when preceded by an efficient radio frequency amplifier and detector. The two-stage amplifier is easy to build in such a way that satisfactory operation is assured. The three-stage amplifier gives a tremendous gain in amplification and volume over the two-stage unit but it is quite difficult to build so that almost uncontrollable howling and distortion will not be present in its action.

The amplification of a three-stage amplifier will be too great when receiving local and nearby stations. It is then necessary to cut out one of the stages or to greatly reduce the amplification. The third stage may be cut out by the use of a jack or a special switch when the same style or type of tube is used in all three stages. If a power tube is used in the third stage it becomes necessary to cut out the second stage, leaving the third with its power tube always connected to the speaker. The proper connections of filament control jacks and jack type switches for cutting out the last stage of the two-stage amplifier and for cutting out the second stage of the three-stage amplifier are shown under *Jacks and Switches, Uses of*. The switch arrangement is to be preferred to the jack because when using a switch it is not necessary to withdraw the plug of the loud speaker from one jack and insert it in another jack.

Bypass Condensers.—In any form of transformer coupled amplifier it is advisable to bypass any high frequency currents which escape the detector and go over into the audio amplifier. The first step in this bypassing is to place a fixed condenser of .002 to .005 microfarad capacity from the plate of the detector tube to the negative filament terminal of this tube. Radio frequency currents which would otherwise overload the audio tubes are bypassed through this condenser.

The next step is to temporarily place a fixed condenser of .001 to .002 microfarad capacity between the grid terminal and the negative filament terminal of each audio amplifying tube in turn, or from the grid terminal to the filament terminal on each of the amplifying transformers, which amounts to the same thing. Both methods are shown in Fig. 7. Use the smallest capacity bypass condenser that will give satisfactory results in improving the tone quality or in increasing the volume.

Do this with one tube or one transformer at a time while the amplifier is in operation. A decided improvement in tone and an in-

AMPLIFIER, AUDIO FREQUENCY, TRANSFORMER

crease of volume may be noticed with this condenser connected to one of the transformers or tubes. A permanent installation in this position should then be made. This bypassing is almost always required in three-stage amplifiers and is generally helpful in most two-stage amplifiers.

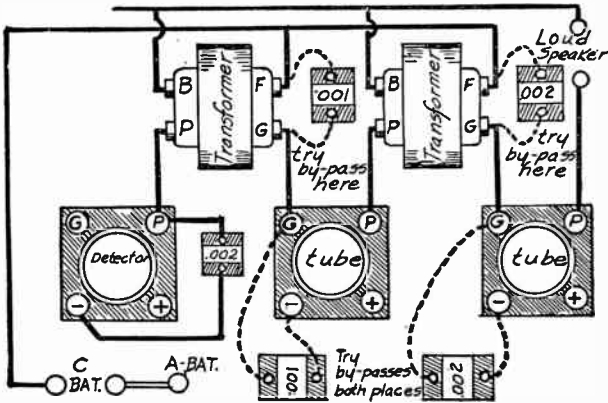

FIG. 7.—Bypassing Radio Frequency Currents in an Audio Amplifier.

In place of using the bypassing condensers, an improvement in tone may be obtained by connecting a fixed resistance of from 100,000 ohms to five megohms between the grid terminal and negative filament terminal of the last audio transformer or of the last amplifying tube. The best value of resistance may be found by experiment or by using a variable resistance unit. This resistance reduces the volume to some extent but produces more uniform amplification and improves the reproduction of the lower notes.

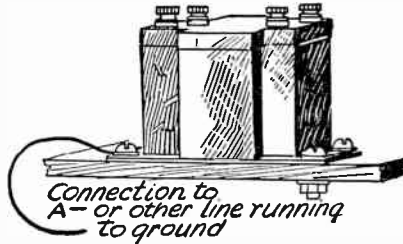

FIG. 8.—Grounding the Shield of an Audio Amplifying Transformer.

Grounding of Shields.—If the transformers are encased in a metal shield it is advisable to connect this shield to the negative battery line of the receiver, this being the line which is usually grounded. With transformer cases thus grounded as in Fig. 8 they may be placed very close to each other without any undesirable coupling effects. Unshielded transformers having rather small cores should be separated from each other by a space of three inches or

AMPLIFIER, AUDIO FREQUENCY, TRANSFORMER

more, but if unshielded transformers have large cores they may be placed within an inch of each other or even closer without harm.

Transformers with small cores are generally those selling at low prices. The body of the small size transformer seldom measures more than two and a half inches in any one direction. Large core transformers generally sell at higher prices and measure three inches or more in some of their dimensions. Transformers with comparatively small cores, if shielded in metal cases which are grounded, may be used without consideration of their relative position or closeness to each other.

Construction of Two-Stage Amplifier.—The layout, connections and usual values for all units in the construction of a two-stage transformer coupled audio frequency amplifier are shown in Fig. 9. Many of the values are variable. The grid leak may be of any value from one to ten megohms. The best value may be deter-

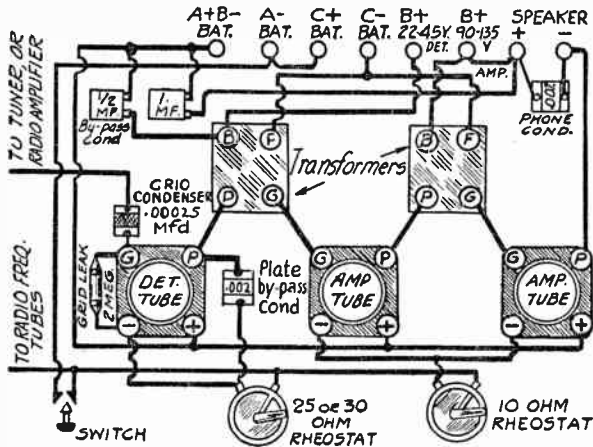

FIG. 9.—Layout of Two-Stage Transformer Coupled Audio Amplifier.

mined by trying different leaks until a satisfactory balance is obtained between stability and power. The connection shown as coming to the grid condenser is from the radio frequency amplifier or the antenna tuner. The plate by-pass condenser between the plate terminal of the detector tube and the filament of this tube may be of any value between .002 and .005 microfarad as explained under the heading *Detector, Plate Bypass* for.

A one-half microfarad bypass condenser is shown between the detector B-battery or power unit and the positive A-battery terminal. A one microfarad bypass is between the amplifier B-battery or power unit terminal and the positive A-battery terminal. The function of these condensers is to prevent interstage coupling which would be caused by the resistance of the B-battery common to both the amplifying stages and the detector. The .002 microfarad condenser placed across the speaker terminals is required only when the cord leading to the loud speaker is very short.

AMPLIFIER, AUDIO FREQUENCY, TRANSFORMER

The single switch would ordinarily control all of the tubes in the entire set, not only those in the audio frequency amplifier. The rheostats controlling the detector tube and the two audio frequency amplifier tubes will be of resistances shown under the heading *Rheostat, Sizes Required*. As mentioned before, if the transformers are of different ratios the one of lower ratio should be used following the detector tube. The proper value of C-battery voltage is given under the heading *Bias, Grid, Amount Required*.

The operation of a transformer coupled amplifier will be improved by using bypass condensers between either filament terminal of each tube and the B-battery terminal of the following transformer, also between the negative filament terminal of each tube and the filament terminal of the preceding transformer as described under *Amplifier, Audio Frequency, Bypass Condensers for*.

The proper connections for using any types of jacks or stage control switches for cutting out some of the audio amplifier tubes are shown and described under the heading of *Jacks and Switches, Uses of*.

A further improvement in the operation of a three-stage transformer coupled amplifier will be made if all plate leads in the amplifier are made with shielded wire and the shield grounded. This practice prevents feedbacks from these wires.

Additional information of value in designing and building transformer coupled audio frequency amplifiers is given under the following headings: *Distortion; Construction, Receiver; Speaker, Loud; Connections to Receiver; Transformer, Audio Frequency; Tube, Amplifying Types of; Volume, Control of; Impedance, Matching of; and Battery, Connection of A- and B-*.

Parallel Feed Audio Amplifier.—In the usual connection scheme for transformer coupling the direct current for the plate circuit flows through the primary winding of the transformer. In an alternative design, called parallel plate feed, the direct current for the plate of the preceding tube is carried through an additional choke as in Fig. 10, or through a resistor as in Fig. 11. The plate circuit of the tube is then coupled to the transformer primary through a coupling condenser.

Alternating current or audio frequency changes in the plate circuit then have a choice between two parallel paths; one path being the resistor or choke, the other being the coupling condenser and primary winding of the transformer. The impedance of the choke or the resistance of the resistor is made high in value. The impedance of the path through the coupling condenser and transformer is made reasonably low, at least no greater than the impedance of the choke. Audio frequency current changes then divide, part taking each path. Because of the condenser in one circuit, no direct current can take this path and only alternating current flows through the transformer primary. Relieving the transformer primary of the direct current load avoids the danger of core saturation which exists in small transformers and in those having core material of very high permeability.

The arrangement at the top in Fig. 10 shows the connections when using an ordinary transformer with two separate windings. The regular plate terminal of the transformer is connected to the bias voltage and the grid terminal is connected to the following tube. The regular B-supply terminal and the regular filament or biasing terminal are both connected to the coupling condenser or else are connected together and to the coupling condenser.

AMPLIFIER, AUDIO FREQUENCY, TRANSFORMER

In the lower part of Fig. 10 the transformer with separate windings has been replaced with an auto-transformer with an electrically continuous winding. It will be seen that similarly lettered transformer terminals in the two diagrams are similarly connected. The effect is to increase the turns ratio and the voltage step-up ratio of the transformer. In the upper drawing, were the transformer used in the usual manner with the primary and secondary winding circuits entirely separate, the ratio would be two to one with a secondary having twice as many turns as in the primary. With the auto-transformer connection or with the ordinary transformer connected as in the upper drawing, the primary winding is that part between the coupling condenser and the biasing terminal, while the secondary portion includes the entire winding between the plate terminal and the grid terminal. Thus, the secondary winding, in the case assumed, would have three times the number

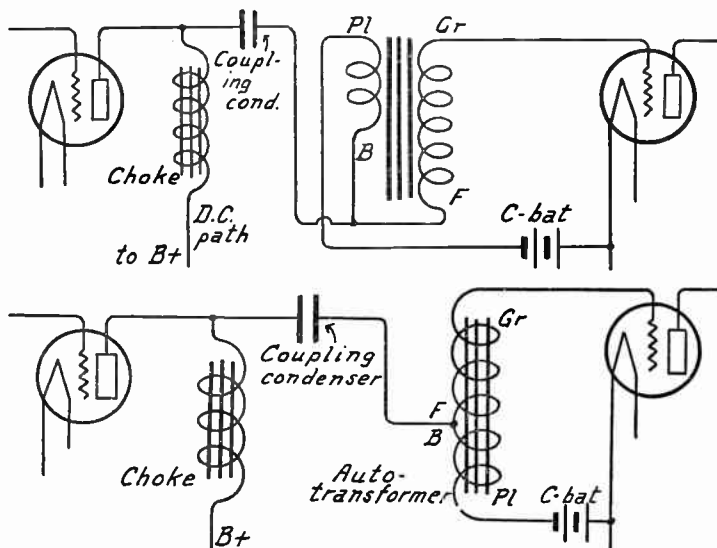

FIG. 10—Parallel Feed Connections for Choke and Ordinary Audio Frequency Transformer.

of turns that are included in the primary portion and the two-to-one ratio transformer becomes one with a three-to-one turns ratio.

Most audio frequency transformers may be connected as indicated at the top of Fig. 10. However, a few units of this kind have their windings reversed from usual practice and in such cases the terminal marked *B* would be connected to the biasing voltage and the terminal marked *Pl* would be connected to the coupling condenser. The transformer may be tried with both connections, the one giving the greatest amplification or volume being that which is correct.

With choke feed to the plate circuit, the choke coil should have an inductance of fifty henrys or more and must be wound with wire large enough to carry the plate current. Speaker coupling chokes and amplifying chokes may be used here. The coupling transformer may be of any value between 0.01 mfd. and 1.0 mfd. depending on whether it is desired to provide a tuned circuit employing the primary of the transformer as the inductance.

AMPLIFIER, AUDIO FREQUENCY, TRANSFORMER

A parallel plate feed through a resistor in place of a choke is shown in Fig. 11. The auto-transformer connections of Fig. 10 might be used here. Direct current for the plate circuit flows only through the resistor while the audio frequency current changes flow through both the resistor and the coupling condenser with its connected primary winding.

The use of a resistor, as in Fig. 11, requires that the power unit B-voltage be greater than when using a choke coil since the resistance of the resistor to direct current is many times greater than the resistance of the choke. In either case the voltage applied to the plate of the tube, as measured between the plate terminal of the tube and B-minus, should be that normally used with the tube being employed. The resistance generally required is some value between 75,000 ohms and 100,000 ohms. The greater the resistance, the more audio frequency energy will be sent through the transformer and the less wasted through the resistance. On the other hand, the higher the resistance, the greater will be the loss of plate supply energy in forcing the direct current for the plate circuit through the higher resistance. The resistance connection is suited only to voltage amplifying types of tubes in which there is a comparatively small plate current. It is not suited to power tubes carrying many milliamperes of direct current for the plate circuit.

With parallel feed it is possible to tune the plate circuit to resonance at some low frequency at which extra amplification is desired. At the resonant frequency there will be a decided increase of audio frequency plate current

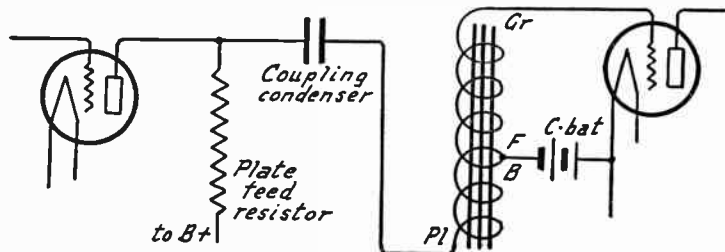

FIG. 11.—Parallel Feed with Resistor and Transformer.

with a corresponding increase of amplification at and near this frequency. The low frequency end of the amplification curve may be thus brought up to the level of the balance of the curve or the low frequencies may even be accentuated.

The coupling condenser and the transformer primary provide capacity and inductance for a series resonant circuit. The reactance of the condenser increases as the frequency drops while the reactance of the primary winding decreases with drop of frequency. Resonance will be obtained at the frequency for which the two reactances become equal. The transformer primary reactance depends not only on the apparent inductance of this winding but also on other factors such as the reactance due to leakage flux. With windings of ordinary proportion the tuning condenser will lie between 0.01 and 0.05 microfarads for resonance between fifty and eighty cycles. If it is not desired to make the circuit resonant at a low frequency, the coupling transformer may have a capacity of from one-half to two microfarads which will increase the amplification at all frequencies over that obtained with the small capacities.

Single Stage Amplifier with High Voltage Detector.—In receivers having great radio frequency amplification it is possible to obtain loud speaker volume with a single transformer-coupled audio frequency stage as shown in Fig. 12. The detector uses plate cur-

AMPLIFIER, PHONOGRAPH TYPE

rent rectification secured through proper grid biasing instead of using the more commonly employed grid condenser and leak with grid current rectification.

In order to obtain sufficient output from the detector tube to produce high voltages in the following transformer secondary, the detector plate voltage is made of a high value, usually in the neighborhood of 150 to 200 volts. To force operation on the lower bend of the grid voltage-plate current curve, a correspondingly high negative grid bias is provided, this being between twenty-

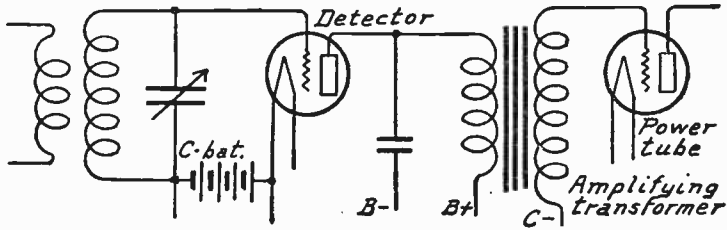

FIG. 12.—Connections for Single Audio Stage with High Voltage Detector.

five and forty volts according to the type of tube being used. The amplifying transformer is built with a comparatively high turns ratio, generally four to one or an even higher ratio in order to provide the required voltage step-up.

In spite of the fact that the power in the detector plate circuit is considerable, it is essential that the voltages applied to the detector grid be much higher than those generally available. This means that several efficient stages of radio frequency amplification must be placed between the antenna and the detector grid circuit.

AMPLIFIER, PHONOGRAPH TYPE.—A phonograph amplifier provides electrical reproduction of sound from the vibratory motion of a needle traveling over the surface of a phonograph record. The vibration of the needle is utilized to cause changes in the voltage and current of an electric circuit. The changes in current represent the vibrations of the needle which in turn represent the sounds originally impressed on the phonograph record.

The electric circuit carrying the changes of voltage and current will provide the source of initial signal voltage for operation of an audio frequency amplifier of any type. The audio amplifier may use any form of coupling and may employ one or more vacuum tubes. The electric phonograph amplifier, when properly designed and built, gives reproduction superior to that from the mechanical amplifiers or reproducers generally employed with phonographs.

The action of the electric amplifier is a reversal of the action of a loud speaker. In the action of a loud speaker changes of current and voltage cause mechanical vibration of the diaphragm and these movements of the diaphragm produce sound waves in the air.

For the electric amplifier the sound waves are represented by the uneven surface of a phonograph record. This uneven surface, through the needle, causes vibrations in the pick-up device. The vibration or movement in the pick-up device causes changes of voltage and amperage in its circuit. The changes of voltage and amperage are sufficient to operate an audio frequency amplifier or, with the addition of battery current, to operate a loud speaker directly without further amplification.

Operation of Pick-up Unit.—The operating principle of the phonograph amplifier may be understood from Fig. 1 which shows a

AMPLIFIER, PHONOGRAPH TYPE

pick-up unit. This particular unit is of the balanced armature type and its marked similarity to the balanced armature loud speaker will be immediately apparent. See *Speaker, Loud*. Other types of pick-up mechanism may be employed without affecting the basic principles of operation. The other possible types include most of those described for use in loud speakers.

Included in the pick-up of Fig. 1 is a permanent magnet having two positive poles on one arm and two negative poles on the other arm. Between these poles is a soft iron armature balanced on a central pivot and surrounded by a coil of wire. Attached to one end of the balanced armature is the phonograph needle riding on the uneven surface of a record.

As the record is revolved, its surface travels past the needle point, causing the needle to vibrate at frequencies representing the sounds impressed on the record. The vibrations of the needle are transmitted to the balanced armature which rocks about its pivot, first rising at one end, then at the other.

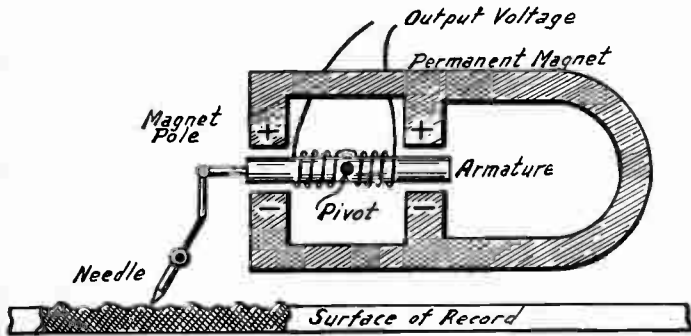

FIG. 1.—Principle of the Phonograph Amplifier Unit.

With the left hand end of the balanced armature raised toward a positive pole of the magnet its right hand end is depressed toward a negative pole. The magnetic lines of force from the permanent magnet then tend to travel from left to right through the soft iron armature. Movement of the needle will reverse the inclination of the armature, the direction of the magnetism is reversed and it flows from right to left since the right hand end of the armature is now near a positive magnet pole and the left hand end near a negative magnet pole.

Reversal of magnetism or rise and fall of the magnetic field through the armature causes a rising and falling magnetic field around the iron. By induction this changing field causes voltages of alternating polarity to be generated in the coil of wire surrounding the armature. The frequencies with which the voltages change represent the vibrations of the needle and the frequencies of the sounds originally impressed on the record.

AMPLIFIER, PHONOGRAPH TYPE

The terminals of the winding in the pick-up unit are connected to wires which pass out of the unit and are connected to the terminals of a loud speaker or the grid circuit terminals of the first tube in an audio amplifier. This connection is indicated in Fig. 2.

Connections to Receivers or Amplifiers.—As applied to a radio receiver the pick-up unit takes the place of the antenna system, of the radio frequency amplifier and of the detector tube. Just as the plate circuit output of a detector tube may be fed through a transformer, a resistance, or a choke coupling into the grid circuit of the first tube in an audio frequency amplifier, so may the pick-up unit's output be fed directly or through a coupling into this first grid circuit in any audio amplifier. One method of making such a connection is shown in Fig. 3. The wire originally attached to the grid terminal of the first audio tube is detached from the tube terminal and left detached. None of the other wires which are regularly attached to this first audio tube are disconnected or changed

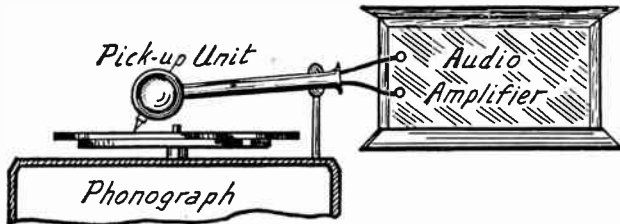

FIG. 2.—Phonograph Pick-up Unit Connected to an Amplifier.

in any way. One of the lines from the pick-up unit is connected to the grid terminal of the first audio amplifying tube. The other wire from the pick-up is connected to the negative terminal of a C-battery or other biasing voltage used with the audio amplifying tube.

The grid circuit of the first audio amplifying tube is now excited by the voltage changes from the pick-up and the remainder of the audio amplifier functions as usual in operating the loud speaker. The various types of amplifiers, any of which may be built especially for use following a phonograph pick-up unit, are described under *Amplifier, Audio Frequency*.

The biasing voltage is necessary in order that the grid voltage of the tube may always be negative. The output from a pick-up unit of the type shown in Fig. 1 is alternating and contains both negative and positive voltages. The negative biasing voltage of a C-battery is lessened by the positive alternations from the pick-up and is increased by the negative alternations, but always remains negative as required for distortionless amplification in the tube.

Considerable difficulty may be encountered in the use of remodeled loud speaker units as pick-up devices. In a loud speaker it is desired that small electrical energy applied to the winding in the speaker shall produce a large movement of the diaphragm. When such a unit is used as an electrical pick-

AMPLIFIER, PHONOGRAPH TYPE

up it is found that the powerful vibrations from the phonograph needle cause such great movement of the parts originally intended to move the diaphragm that great distortion and rattling result.

To make a loud speaker unit act as a pick-up unit much of the vibration of the speaker parts must be prevented. This may sometimes be accomplished by placing pieces of soft rubber between a balanced armature and the magnet pole pieces or placing rubber pieces at other points which will limit the motion. This mechanical damping of the vibration will limit movement of the speaker parts so that they act about the same as when they are used for loud speaker work.

If the coupling between detector tube and first audio amplifying tube in the receiver is through a transformer or a high impedance choke the output of the pick-up may be connected to the primary

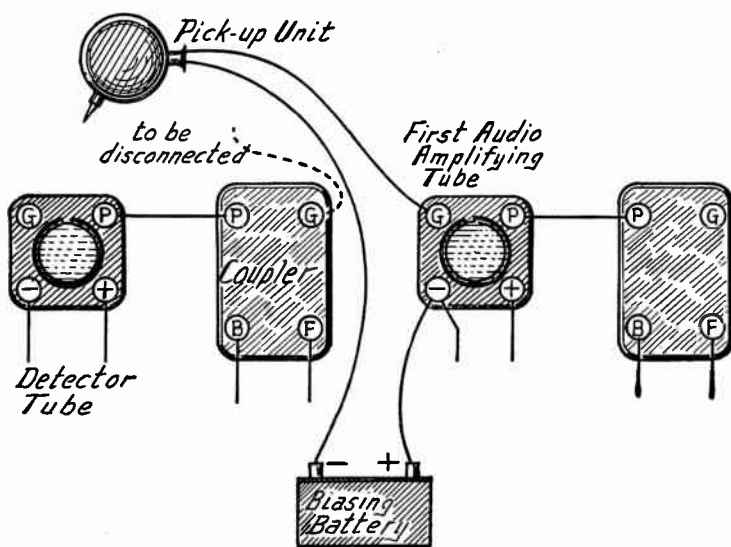

FIG. 3.—Phonograph Pick-up Unit Connected to First Audio Tube.

side of transformer or choke as shown in Fig. 4. This will give a step-up of voltage through a transformer and the result will be a louder amplified signal than with the pick-up connected directly to the grid circuit of the amplifying tube as in Fig. 3. A similar connection may be made from the pick-up unit to a resistance coupler or to a choke coil coupler between detector and first audio amplifier. With resistance or choke coupling there will be no step-up of voltage. The resistance used in the plate circuit for resistance coupling is usually a unit of 100,000 ohms. Greater volume will be secured by substituting a higher resistance, experimenting up to 1,000,000 ohms or one megohm.

In making the connection of Fig. 4 to a transformer, to a resistance or to a

AMPLIFIER, PHONOGRAPH TYPE

choke the lead originally attached to the plate terminal of the coupler should be disconnected and left off. Likewise the line attached to the B-battery or plate voltage supply terminal of the coupler should be detached and left off. The end of this latter wire should be well insulated with tape since it is connected to the B-battery or other high voltage supply. The two leads from the pick-up unit are then connected to the primary terminals, plate and B-battery, of the coupling unit. No other changes are made in wiring. The detector tube should be left out of its socket.

With a pick-up unit having a powerful magnet and windings of large inductance there will be quite high voltages generated and with these voltages

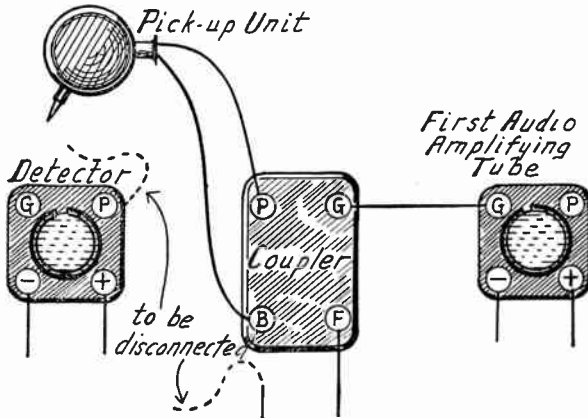

FIG. 4.—Phonograph Pick-up Unit Connected to Audio Coupling Unit.

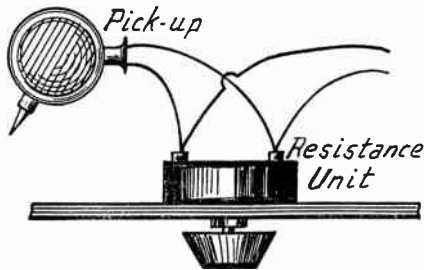

FIG. 5.—Resistance Control of Volume in Phonograph Amplifier.

applied directly to the grid circuit of an amplifying tube the volume will usually be too great even with only one audio amplifying tube in use. The volume may be controlled by placing a variable high resistance across the leads from the pick-up device as shown in Fig. 5. This unit should have a maximum resistance of 500,000 ohms. The volume is reduced by lowering the resistance. Volume will be maximum with the greatest possible resistance between the two sides of the circuit.

Use of Power Battery.—The strength of the amplified signal may be tremendously increased by using battery current through a

AMPLIFIER, PHONOGRAPH TYPE

coupling transformer as shown in Fig. 6. The transformer should have a low impedance primary and a high impedance secondary winding. High ratio audio amplifying transformers are fairly satisfactory. Turn ratios from six to one up to ten to one should be used. The resistance unit should be of 500 to 1000 ohms and con-

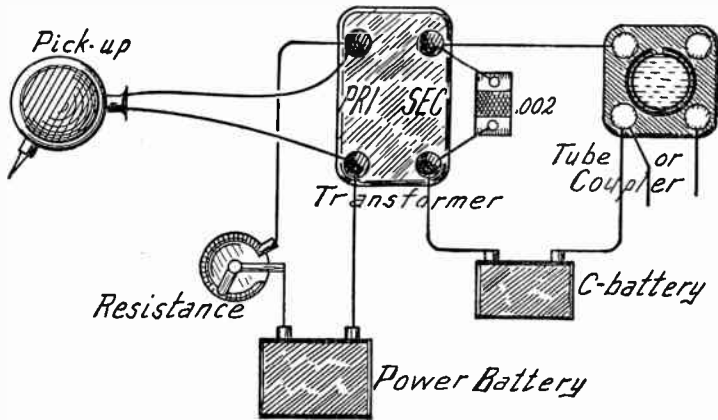

FIG. 6.—Using a Battery with Phonograph Pick-up Unit.

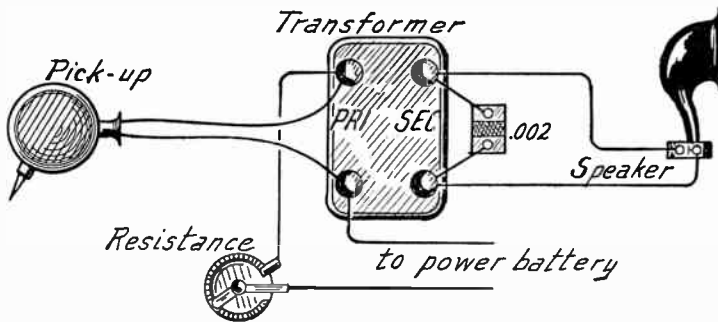

FIG. 7.—Phonograph Pick-up Connected Through Transformer to a Speaker.

tinuously variable for use as a volume control. A fixed condenser of .002 microfarad capacity is connected across the transformer secondary. The C-battery or biasing voltage should be of a value suited to the amplifying tube used and the plate voltage supplied. The power battery may be a single storage cell or a one and one-half volt dry cell. A C-battery is too small for a power battery because the current drain varies from one one-hundredth to one-quarter of an ampere.

AMPLIFIER, PHONOGRAPH TYPE

The pick-up leads and the power battery through its variable resistance are connected to the primary of the transformer. The secondary of the transformer is connected to the grid circuit of an amplifying tube or to a coupler as shown in Fig. 6. The transformer may also be connected directly to a loud speaker as in Fig. 7. If connected to a loud speaker the C-battery is not required. The battery current divides between the winding of the transformer and the winding in the pick-up unit so that the action is a process of modulation through the transformer.

The scratching noise of the needle may be bypassed or filtered out by connecting a fixed condenser of 0.01 to 0.015 microfarad capacity and an iron-core choke coil of 100 millihenries inductance in series with each other and placing the combination between the two lines coming out of the pick-up unit or between the plate and negative filament terminals of the first amplifying tube. The connections of Fig. 6 may be used without the power battery, simply omitting these parts from the circuit and making all other connections exactly as shown.

When a loud speaker is to be operated directly from a pick-up unit it is necessary to use the power battery system of Figs. 6 and 7 but when the output of the pick-up unit is fed first through an audio amplifier of one or more stages the battery is not required.

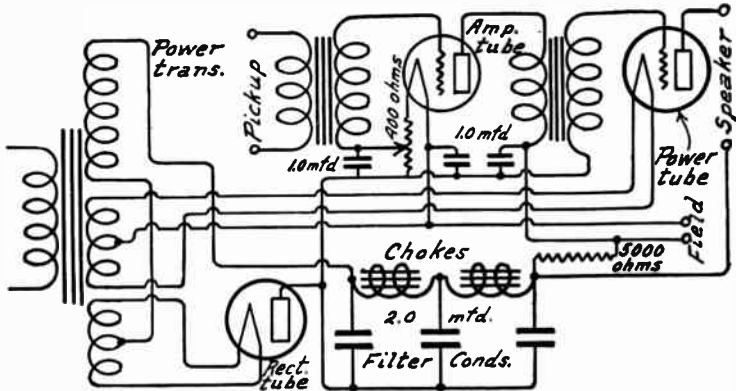

FIG. 8.—Circuit Diagram of Phonograph Amplifier.

The volume control method of Fig. 5 utilizes an ordinary variable resistance unit, that is, a unit having one end of the resistance element connected to one terminal, the other end of the element left unconnected and the slider connected to the second terminal. The outside wires are then connected to one end of the resistance element and to the slider. It is also satisfactory to use a potentiometer with its two ends connected directly across the pick-up. The transformer primary is then connected to either end of the potentiometer and to the potentiometer's slider. There are then two wires on one terminal of the potentiometer and one on each of the others.

AMPLIFIER, PUBLIC ADDRESS TYPE

Audio Amplifiers for Phonograph Operation.—The output from the electrical pick-up of a phonograph may be fed through one or more stages of audio frequency amplification to provide sufficient power for loud speaker operation at any desired volume.

A typical amplifier, constructed especially for this type of work, is shown in Fig. 8. This particular design employs an output power tube, a small voltage amplifying tube for the first stage, and is complete with its own high voltage and filament current supply system. A single half-wave rectifying tube provides direct current for both plate circuits and for the field magnet of a dynamic loud speaker. The rectifying and filter system also provides direct current for the filament of the first amplifying tube, this tube being of the type requiring 0.06 ampere or sixty milliamperes at three volts for filament operation. Part of the filament current in this tube consists of the plate current passing through the power tube.

AMPLIFIER, PUBLIC ADDRESS TYPE.—See *Amplifier, Power Type*.

AMPLIFIER, RADIO FREQUENCY.—A radio frequency amplifier consists of one or more amplifying tubes with the necessary coupling devices between them. This amplifier is placed between

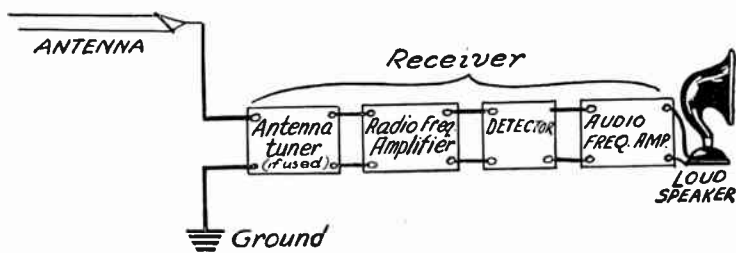

Position of the Radio Frequency Amplifier in a Receiver.

the antenna or tuner and the detector so that it may increase the strength of the signals coming from the antenna and deliver these amplified signals to the detector. A radio frequency amplifier is used ahead of the detector while an audio frequency amplifier is used following the detector. See *Radio, Principles of*.

There are four types of radio frequency amplifiers in more or less common use. They are designated according to the kind of coupling used between the tubes. By far the most common type is that using tuned transformer coupling. Other less used types include tuned impedance coupling, tuned variometer coupling and untuned transformer coupling.

The problems to be met in a radio frequency amplifier are quite different from those met in the audio frequency amplifier. An audio frequency amplifier handles currents of comparatively low frequency and high amperage. Such currents are quite easily controlled and amplified. In the radio frequency amplifier we deal with extremely high frequencies and with voltages so small that

AMPLIFIER, RADIO FREQUENCY, TUNED IMPEDANCE

they are measured in millionths of a volt as they come from the antenna. The greatest care is necessary to avoid the loss of any of this voltage and to prevent the escape or improper travel of the high frequencies.

Both tuned and untuned coupling devices have been mentioned as being used in radio frequency amplifiers. In audio frequency amplifiers all of the couplings are untuned, that is, they are not tuned to resonance at any particular frequency, but amplify almost equally well all frequencies within the audible range.

The lack of amplification or voltage step-up in the coupling devices used between radio frequency tubes is compensated for to some extent by what is called the square law action of the detector. The detector tube amplifies according to the square of the voltage changes applied to its grid. Therefore, all the voltage gain obtained in the radio frequency stages has the advantage of being finally squared by the detector. The real gain due to increasing the number of stages of radio frequency amplification may be as great as the gain in adding an equal number of audio frequency stages, although the radio frequency amplification itself is not as effective in increasing signal strength as is audio frequency amplification.

In dealing with the radio frequency amplifier we must handle broadcast frequencies from 500,000 cycles (or 500 kilocycles) up to 1,500,000 cycles (or 1500 kilocycles). It is not possible to build any form of coupling device which will amplify with even approximate uniformity such a range of frequencies as must be handled in the radio frequency end of a receiver. Therefore it is necessary to tune the coupling device or make it resonant to the particular frequency being handled at any one time for satisfactory reception of broadcasting.

Untuned transformer coupling has been mentioned, but this type of coupling has almost disappeared from use in receivers intended for broadcast reception. During the days when all broadcasting stations operated either on a wavelength of 360 meters or one of 450 meters it was possible to use untuned radio frequency transformers with a fair degree of satisfaction, since they may be built to amplify quite evenly between these limits. But now that the broadcasting wavelengths and frequencies have extended greatly both above and below these old limits we can no longer use untuned transformers.

It is not necessary to use radio frequency amplification ahead of the detector when receiving powerful nearby stations. Methods of cutting out one of the radio frequency stages are shown under *Jacks and Switches, Uses of*.

Since the subject of radio frequency amplifiers is closely related to a great part of all other work in radio receivers it is necessary to consider many related subjects when dealing with these amplifiers. For information on parts which enter into the construction of radio frequency amplifiers or which affect the operation of these amplifiers the following headings should be referred to: *Antenna, Coupling of; Coil, Angle of Mounting; Coil, Design; Coil, Tuning, Sizes Required for; Distortion; Condenser, Variable; Control, Single; Oscillation; Resonance; Selectivity; Sensitivity; Tube, Amplifying Types of; and Volume, Control of*.

AMPLIFIER, RADIO FREQUENCY, TUNED IMPEDANCE COUPLED.—The operating principle of the tuned impedance coupled radio frequency amplifier is the same as that of the impedance coupled audio frequency amplifier. In both these types of amplifiers we obtain a drop of voltage across an impedance

AMPLIFIER, RADIO FREQUENCY, TUNED IMPEDANCE

or a resistance in the plate circuit of one tube, and, through a fixed condenser used as a stopping condenser, we apply the changes in voltage across this impedance or resistance to the grid of the following tube.

The circuit of a tuned impedance coupled amplifier is shown in Fig. 1. The coupling device consists of a coil and condenser in parallel and placed between the plate of the tube and the B-battery

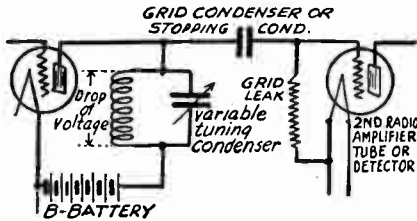

FIG. 1.—Tuned Impedance Coupling for Radio Amplifier.

or power unit. By varying the capacity of the condenser the combination is tuned to resonance with the frequency to be received and amplified.

With the coil and condenser tuned to resonance they have the greatest possible impedance at the received frequency. Therefore, plate current at this frequency meets a great impedance in the coil and condenser and there is the greatest possible drop of voltage

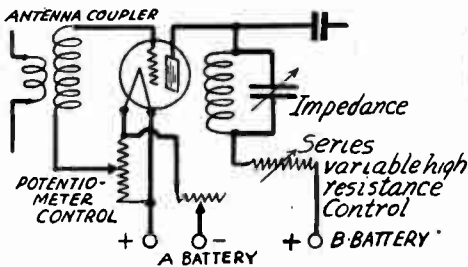

FIG. 2.—Oscillation Control for Radio Amplifier with Potentiometer and with Resistance in Plate Circuit.

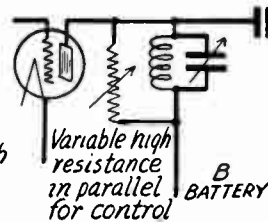

FIG. 3.—Radio Amplifier Control with Resistance in Parallel with Impedance.

across this impedance. From the tube's plate terminal, at its connection to the impedance, a lead runs to a stopping condenser whose other side is connected to the grid of the following tube. The changes in voltage across the impedance are carried through this condenser and applied to the grid of the following tube.

The inductance of the coil and the capacity of the variable tuning condenser are selected to tune together over the broadcasting

AMPLIFIER, RADIO FREQUENCY, TUNED IMPEDANCE

wave bands. The grid leak for the radio frequency amplifying tube should have a resistance of one megohm or more and the stopping condenser should be of .0005 microfarad capacity or larger.

The principal objection to the tuned impedance amplifier is the difficulty of preventing self-oscillation. This oscillation may be controlled with a 200- to 400-ohm potentiometer in the grid return or with several other types of oscillation control described under the heading *Oscillation*. The tuned impedance circuit cannot be neutralized. It may be handled satisfactorily by placing a variable high resistance in series between the impedance coil and the power unit or B-battery as in Fig. 2 or it may be handled by placing such a resistance in parallel with the impedance as shown in Fig. 3. For a single-stage amplifier this variable resistance should have a maximum value of 2000 ohms. For a two-stage amplifier the resistance may have a maximum value of 100,000 ohms.

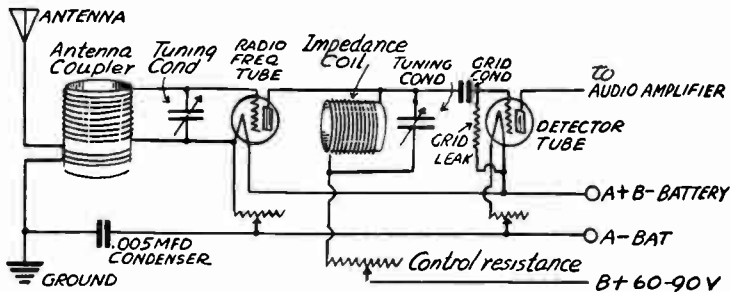

FIG. 4.—Circuits of Impedance Coupled Radio Amplifier.

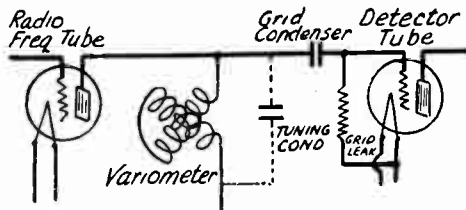

FIG. 5.—Variometer Used as Tuned Impedance Coupling in Radio Amplifier.

The circuit diagram in Fig. 4 shows the complete connections for an impedance coupled radio frequency amplifier from the antenna and ground to and including the detector tube. The antenna coupler may be of the style shown or of any other type which is available. The impedance coil should be placed at right angles to, or in such relation to, the antenna coil that there is the least possible coupling or feedback effect between them.

The capacity of the tuning condensers and the size of their coils will depend on the frequencies to be covered and may be determined by reference to the section *Coil, Tuning, Sizes Required for*. Oscilla-

AMPLIFIER, RADIO FREQUENCY, TUNED TRANSFORMER

tion control in this circuit is by a variable high resistance in series with the B-battery for the radio frequency tube but any other form of oscillation control may be used. Due to the difficulty of controlling oscillation, impedance coupled amplifiers are generally constructed with but one stage of radio frequency amplification ahead of the detector.

In place of the impedance coil and its tuning condenser a variometer may be substituted as shown in Fig. 5. Variometers which are constructed for the purpose of tuning will take the place of both the coil and its tuning condenser. With some types of variometers it may be necessary to use a fixed condenser connected in parallel with the variometer as shown by the dotted lines. This fixed tuning condenser may have a value between .0001 and .00025 microfarad, depending on the variometer with which it is used. See *Variometer, Coupling with*.

In a tuned impedance coupling there is no step-up ratio of voltage possible. With transformer coupling the primary is made of fewer turns than the secondary, consequently there may be an increase of voltage from primary to secondary but with impedance coupling there can be no such transformer action and the entire amplification must be obtained from the tube alone. The use of high Mu tubes is sometimes advantageous.

AMPLIFIER, RADIO FREQUENCY, TUNED TRANSFORMER COUPLED.—The tuned transformer type of radio frequency amplifier utilizes many of the principles found in the transformer coupled audio frequency amplifier but in place of employing an iron-core transformer as with audio frequency, one of the air-core type is used. Since an air-core transformer is in itself resonant to only one natural frequency a variable condenser is placed in parallel with the secondary winding of the transformer. This condenser may be varied to make the transformer resonant at the frequency to be received.

The circuit of a single stage of tuned transformer coupling is shown in Fig. 1. The transformer itself is composed of two separate windings, the primary and the secondary. The primary winding, of relatively few turns, is connected between the plate terminal of the preceding tube and the B-battery or power unit which applies positive voltage to the plate of that tube. One end of the secondary winding is connected to the grid terminal of the following tube and the other end of the secondary is connected either directly, through a rheostat, or a biasing battery, to the negative filament terminal of the following tube. The primary and secondary are formed by any of the types of coils such as those described under the following headings in the section on coils; *Basket Wound, Closed Field Type, Honeycomb, Single Layer* and *Spiderweb Type*. Information on the construction of transformers will be found under *Transformer, Tuned Radio Frequency*.

Transformer Construction.—The size or inductance of the secondary winding of a radio frequency transformer is selected of such value that it will tune to resonance when used with the tuning condenser employed. Correct sizes of coils and condensers are given under *Coil, Tuning, Sizes Required for*. The primary winding

AMPLIFIER, RADIO FREQUENCY, TUNED TRANSFORMER

of the transformer consists of from four to thirty turns, either closely or loosely coupled to the secondary. Information on tuning condensers will be found under the heading *Condenser, Tuning*.

The fewer turns in the primary winding the less will be the tendency toward feedback and the easier it will be to control oscillation and regeneration in the amplifier.

The greater the number of turns in the primary and the more closely it is coupled to the secondary the greater will be the amplification as shown by Fig. 2, consequently high amplification and ease of control are opposed to one another.

The majority of tuned radio frequency transformers are built with single layer straight-wound or solenoid coils. These coils are of such size that they may be tuned with variable condensers whose maximum capacity is .0005 microfarad in most cases. Many transformers are built to be tuned with condensers having a maximum capacity of approximately .00035 microfarad while still others use condensers of only .00025 microfarad. Of course the larger the coil which forms the secondary, the smaller must be the condenser with which it is tuned provided the same range of frequencies is to be covered.

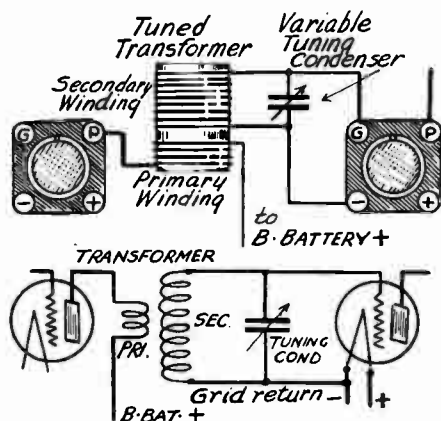

FIG. 1.—Tuned Transformer Coupling for Radio Amplifier.

Many radio frequency transformers have only six or eight primary turns, this low number being used to reduce the tendency toward oscillation. A greater number of turns is desirable from the standpoint of amplification, sensitivity and volume.

Voltage Amplification.—In radio frequency transformers such as generally used the greatest voltage amplification is obtained when the primary consists of from fifteen to twenty turns with a fifty or sixty-turn secondary on the same size tubing. With only ten turns on the primary the transformer delivers about seventy per cent of the maximum possible voltage amplification and with but five primary turns only about thirty-five per cent of the maximum voltage amplification is realized.

An increase in the number of primary turns beyond a certain point again reduces the voltage amplification. As the coupling is increased or made closer the voltage amplification increases up to a certain

AMPLIFIER, RADIO FREQUENCY, TUNED TRANSFORMER

value of coupling, but if the coupling is made still closer than this value, the voltage amplification will again fall off. This effect is explained more fully under *Transformer, Tuned Radio Frequency*.

With tuned transformer coupling employing fewer turns in the primary winding than in the secondary we would naturally expect a step-up of voltage because of the turn ratio of the transformer. There is sometimes an actual voltage step-up but it is very small and does not approach the turn ratio of the transformer. In a tuned radio frequency transformer having fifteen pri-

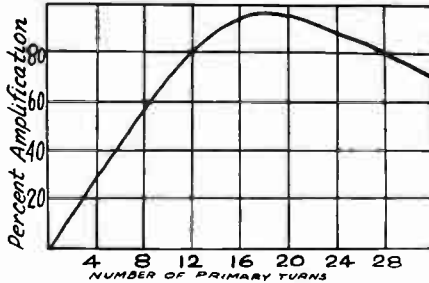

FIG. 2.—Effect of Primary Turns on Radio Frequency Amplification.

mary turns and sixty secondary turns we have a turn ratio of four to one (secondary to primary) but in such a transformer it is impossible to obtain a voltage ratio of anywhere near to four to one, in fact a ratio of one and one-half or one and one-quarter to one would be exceedingly good. This is because there is only a small transfer of energy from primary to secondary. Even with the closest possible coupling, the coupling does not compare in closeness with that obtained in an iron-core transformer. In the air-core type of transformer there is a very great leakage of flux which accounts still further for the small power transfer.

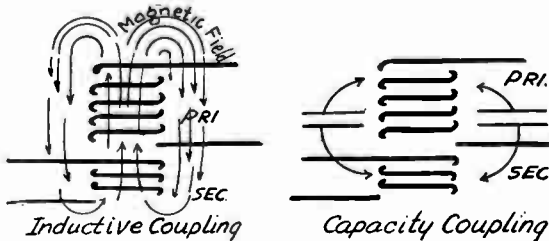

FIG. 3.—The Two Kinds of Coupling in a Radio Amplifier Transformer.

Coupling in Transformers.—Between the primary and secondary windings of radio frequency transformers there are always two kinds of coupling as indicated in Fig. 3. One is inductive coupling, which we desire, and the other is electrostatic or capacity coupling which is undesirable. Inductive coupling is due to the mutual inductance between the two windings. It is increased by increase of

AMPLIFIER, RADIO FREQUENCY, TUNED TRANSFORMER

inductance or by the number of turns in the primary winding. Through this inductive coupling or mutual inductance there is a transfer of energy between the two windings.

Capacity coupling exists between the two windings because of their surface area. The metal of the wire in the secondary winding is separated from the metal of the wire in the primary by insulation. The two metals form the plates of a condenser while the insulation forms the dielectric. The greater the area of these plates or the greater the size of the windings the greater will be the capacity coupling and through this capacity coupling feedbacks may occur between the stages. These feedbacks produce oscillation which must be controlled.

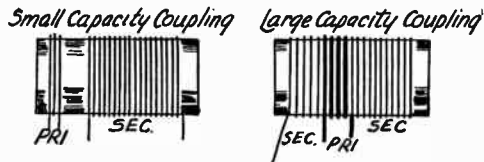

FIG. 4.—Effect of Primary Position on Capacity Coupling in Radio Amplifying Transformer.

The smaller the physical size or dimensions of the primary winding and the farther it is removed from the secondary winding the less will be the capacity between the two windings. This is shown in Fig. 4. From this standpoint a primary of small wire wound in a small space and placed at one end of the secondary is preferred to a winding of larger wire spread out over a larger space and wound directly over or under the secondary, especially if this large primary is well in toward the center of the secondary.

Inductance of Secondaries.—There is considerable difference of opinion as to the relative merits of large and small inductances in the secondary windings of tuned radio frequency transformers.

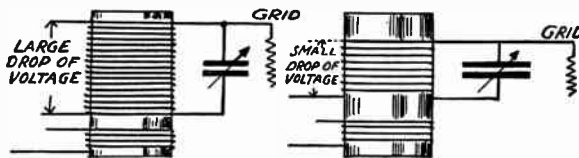

FIG. 5.—Voltages from Large and Small Inductances in Radio Amplifier.

A coil with a high value of inductance may be tuned with a condenser of smaller capacity than used for a coil of small inductance which requires a correspondingly large condenser. As shown in Fig. 5 the coil of large inductance gives a greater voltage drop and applies a greater voltage to the grid of the following tube, thus giving more amplification than obtained with a coil of small inductance.

While it is true that a coil having large inductance tuned with a small condenser gives a greater voltage drop and consequently impresses a greater voltage on the grid of the following tube, it should

AMPLIFIER, RADIO FREQUENCY, TUNED TRANSFORMER

be remembered that the large coil has more resistance than a small one and the small capacity condenser has more resistance than a large one. From the standpoint of voltage gain we should use a large coil and small condenser but from the standpoint of circuit resistance we should use the small coil and large condenser. It is

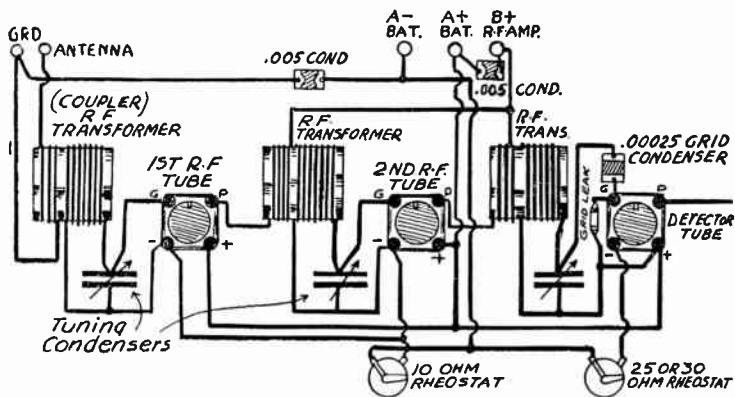

FIG. 6.—Arrangement of Parts in Two-Stage Tuned Transformer Type of Radio Amplifier.

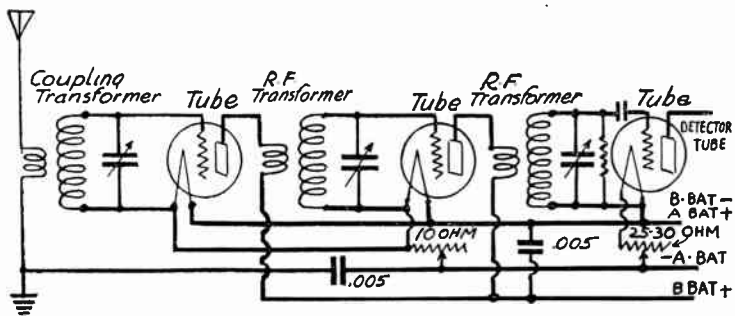

FIG. 7.—Circuits of Two-Stage Tuned Transformer Radio Amplifier.

important to eliminate all possible losses in the larger coil if used because if such a coil is carelessly designed and constructed the added losses together with the naturally high resistance of any coil at radio frequency will forfeit much of the gain in voltage.

Construction of Amplifier.—Since the voltages impressed on the grids of radio frequency tubes are very small it is not necessary to use an extra C-battery for providing negative grid bias because the tube will operate on the straight portion of its curve with only the bias from a rheostat. The best results will be obtained by connecting the grid return end of the transformer secondary winding directly to the negative battery side or line side of a rheostat

AMPLIFIER, RADIO FREQUENCY, UNTUNED

or filament resistance for the radio frequency amplifier tube whose grid carries the other end of the secondary winding.

Should the amplifier consist of so many stages that a considerable voltage is finally applied to the grids of tubes near the detector, the grid return may be made through one or two cells of a C-battery. See *Bias, Grid*.

In radio frequency amplifiers a bypass condenser for the plate direct current should always be provided. This may be a fixed condenser of .005 microfarad capacity. It should be connected between one of the filament terminals of the tube and the connection of the following transformer primary to the B-battery or power supply. This allows the radio frequency currents to complete their circuit without passing through the resistance of the B-battery. This practice improves the amplification and reduces the tendency to self-oscillation.

Complete constructional details of a two-stage transformer coupled radio frequency amplifier together with all connections and values for the principal units are shown in Figs. 6 and 7. This circuit includes all of the practices that have been recommended for this type of amplifier.

AMPLIFIER, RADIO FREQUENCY, UNTUNED TRANSFORMER COUPLED.—It was explained under *Amplifier, Radio Frequency* that untuned transformer coupling will cover only a very limited range of frequencies and that it is therefore unsatisfactory for broadcast reception. The circuit for a radio frequency amplifier using untuned transformers is shown.

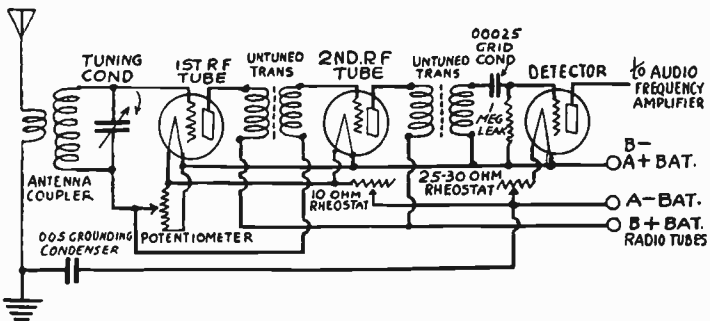

Radio Frequency Amplifier with Untuned Transformers.

An untuned radio frequency transformer has a small amount of iron as a core, this being indicated by the broken lines between the primary and secondary windings in the diagram. The circuit coupled to the antenna is tuned with a variable condenser. Oscillation control is by means of a 200- or 400-ohm potentiometer as shown. Other types of oscillation control may be substituted. The grid return for both radio frequency amplifier tubes is through this potentiometer, while the detector grid return is to the positive filament terminal of the detector. The resistance of the detector grid leak may be one

AMPLIFIER, RADIO FREQUENCY, VARIOMETER

megohm or greater. The negative A-battery line may be grounded through the .005 microfarad grounding condenser as shown, or grounded directly without the condenser. Such a receiver is a fairly good distance getter for a limited range of frequencies or wavelengths, but is not at all selective. See *Transformer, Untuned Radio Frequency*.

AMPLIFIER, RADIO FREQUENCY, VARIOMETER COUPLED.—A tuned impedance coupled radio frequency amplifier may be built with variometers for coupling units between the tubes in place of with coils and variable condensers. See *Amplifier, Radio Frequency, Tuned Impedance Coupled*; also *Variometer, Coupling with*.

AMPLIFIER TUBE.—See *Tube, Amplifying Types of*.

AMPLITUDE.—The highest voltage or amperage reached by a wave or alternation of an alternating current. See diagram.

AMPLITUDE DISTORTION.—See *Distortion*.

ANGLE, ELECTRICAL.—One complete cycle of alternating current is considered as consisting of 360 electrical degrees just as one complete circle consists of 360 degrees. One half a cycle, which is one alternation, then consists of 180 electrical degrees; one half alternation consists of 90 electrical degrees and so on.

The relative times with reference to one another at which alternating currents and voltages reach their maximum and minimum points and at which they pass through zero are designated by the number of electrical degrees between such points. See *Alternation*; *Cycle*; and *Phase*.

ANGLE OF COIL MOUNTING.—See *Coil, Angle of Mounting*.

ANGLE OF LAG.—See *Phase*.

ANGLE OF LEAD.—See *Phase*.

ANION.—A negative ion is called an anion. Ions are formed by the electrical breaking down of gases and liquids. Ions formed at the anode are the anions, those formed at the cathode are cations.

ANNUNCIATOR WIRE.—See *Wire, Bell*.

ANODE.—A terminal or an electrode through which an electric current enters an electrolyte, a vacuum or any other medium on its

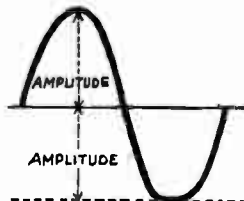

The Amplitude of an Alternating Current Wave.

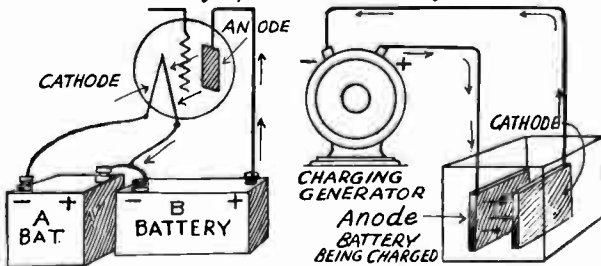

Anodes and Cathodes in Electric Circuits.

ANTENNA

way to the negative side of the source. The anode is therefore the positive terminal of an electric source such as a battery, or is the electrode connected to this positive terminal. In a vacuum tube the plate is the anode while the filament is the cathode. See also *Cathode*.

ANTENNA.—The antenna includes the wires or conductors which extend outside of the receiver proper and which are affected

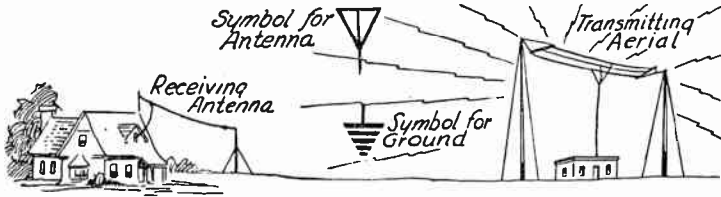

FIG. 1.—Relation of the Antenna and Aerial.

by the signals coming from a radio transmitter or broadcasting station. The type of antenna now being considered consists of one or more wires elevated some distance above the ground as in Fig. 1.

These wires form one plate of a large condenser whose other plate is the ground or earth. The antenna and ground have the air between them acting as the dielectric of this condenser.

Between antenna and ground connections in the receiver there is always an inductance, a coil. The inductance of the coil together

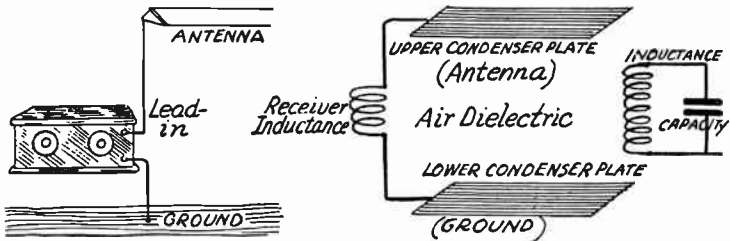

FIG. 2.—The Principle of the Capacity Antenna.

with the capacity of the antenna form an oscillatory circuit which responds to the frequency of the radio waves coming through the air from a broadcasting station. Oscillating currents are set up through the antenna, the coil and the ground. The inductance in the receiver is coupled to the tuning device, to the radio frequency amplifier or to the detector so that the signals coming in on the antenna are detected and amplified in the receiver.

The form of antenna which is generally used is called an open antenna, a capacity antenna or a plate antenna. Under the head-

ANTENNA, CAPACITY AND INDUCTANCE

ing *Loop, Antenna Action of* is considered a form of antenna which does not form a capacity or a condenser. The principle of the capacity type of antenna is shown in Fig. 2.

ANTENNA, CAPACITY AND INDUCTANCE OF.—

The antenna system consists of the horizontal wires or antenna proper and the vertical wires or lead-in. Considering only the horizontal portion, the capacity of the antenna increases almost directly with its length up to about one hundred feet but increases less rapidly for greater lengths. This might be expected since an increase of antenna length increases the size of the plates of the condenser which is formed by antenna and ground.

There is only a small change in capacity as the height of the antenna above the ground is increased above thirty feet. From a height of thirty feet up to a height of one hundred and twenty feet the decrease in capacity is only about seven per cent, but as the antenna is lowered under thirty feet the capacity increases quite rapidly. This effect also might be expected because lowering the antenna brings the plates of this big condenser closer together.

The capacity of a vertical lead-in wire increases directly with the length of the lead-in. The capacity of the lead-in must be added to that of the antenna to obtain the total capacity of the whole antenna system.

In the following tables the left hand columns give the height of the antenna in feet. The columns toward the right cover various lengths of antenna from thirty to one hundred feet. At the intersection of the vertical and horizontal lines will be found the capacity of the horizontal wires measured in micro-microfarads.

CAPACITY OF HORIZONTAL SINGLE WIRE ANTENNA

Antenna Height in Feet	Horizontal Portion of Antenna—Length in Feet				
	30 ft.	45 ft.	60 ft.	75 ft.	100 ft.
20 ft.	59 Mmfds	83 Mmfds	111 Mmfds	139 Mmfds	179 Mmfds
30 ft.	58 Mmfds	81 Mmfds	109 Mmfds	131 Mmfds	175 Mmfds
40 ft.	57 Mmfds	80 Mmfds	107 Mmfds	123 Mmfds	173 Mmfds
60 ft.	57 Mmfds	80 Mmfds	105 Mmfds	121 Mmfds	171 Mmfds
100 ft.	56 Mmfds	79 Mmfds	104 Mmfds	119 Mmfds	169 Mmfds

In the next table, which is similar to the preceding one, is given the capacity in micro-microfarads of the horizontal portion of the antenna and also the capacity of the vertical lead-in. Preceding the hyphen is the capacity in micro-microfarads of the horizontal portion and following the hyphen is the capacity of the vertical lead-in. Thus, for an antenna 60 feet long and 40 feet high the capacity of the horizontal portion is 107 micro-microfarads and of the vertical portion or lead-in is 71 micro-microfarads, a total of 178 micro-microfarads for the entire antenna system. The capacity of the lead-in must always be added to that of the antenna.

ANTENNA, CAPACITY AND INDUCTANCE

CAPACITY OF ANTENNA AND LEAD-IN—MICRO-MICROFARADS

Antenna Height in Feet	Length in Feet of Horizontal Portion of Antenna				
	30 ft. <i>Hor.-Vert.</i>	45 ft. <i>Hor.-Vert.</i>	60 ft. <i>Hor.-Vert.</i>	75 ft. <i>Hor.-Vert.</i>	100 ft. <i>Hor.-Vert.</i>
20 ft.	59-40	83-40	111-40	139-40	182-40
30 ft.	58-56	81-56	109-56	131-56	175-56
40 ft.	57-71	80-71	107-71	123-71	172-71
60 ft.	57-103	80-103	105-103	121-103	170-103
100 ft.	56-166	79-166	104-166	119-166	168-166

The effective capacity of the antenna system is somewhat greater at the higher frequencies or lower wavelengths used in broadcasting than at the other end of the scale. Taking the effective capacity at 1000 kilocycles or approximately 300 meters as represented by 100 per cent the following changes are found in practice: At 1500 kilocycles or 200 meters the capacity is 120 per cent and at 600 kilocycles or 500 meters it is 90 per cent of the value at 1000 kilocycles.

Inductance of Antenna.—The horizontal portion of the antenna and the vertical lead-in not only have capacity but also have inductance even though they are composed of straight wires. The following table is similar to the one preceding but gives the inductance in microhenries of the horizontal portion of the antenna and of the vertical lead-in. The number preceding the hyphen gives the inductance of the horizontal antenna and the number following the hyphen gives the inductance of the vertical lead-in.

INDUCTANCES IN ANTENNA SYSTEMS—MICROHENRIES

Antenna Height in Feet	Length in Feet of Horizontal Portion of Antenna				
	30 ft. <i>Hor.-Vert.</i>	45 ft. <i>Hor.-Vert.</i>	60 ft. <i>Hor.-Vert.</i>	75 ft. <i>Hor.-Vert.</i>	100 ft. <i>Hor.-Vert.</i>
20 ft.	20-10	30-10	41-10	50-10	68-10
30 ft.	20-15	30-15	41-15	51-15	69-15
40 ft.	20-21	30-21	42-21	52-21	71-21
60 ft.	20-34	31-34	42-34	53-34	72-34
100 ft.	20-61	31-61	42-61	53-61	73-61

The inductance of the antenna and the lead-in are not lumped inductances as found in coils but are distributed over the whole length of these wires. These distributed inductances are due to the ability of the wires to generate an electric field about them. For this reason the total inductance of antenna and of lead-in is not as great as the sum of their separate inductances as would be the case with lumped inductances in series. Nor is it as small as the inductances of the two in parallel. Practice shows that the approximate effective inductance of antenna and lead-in may be found by adding the two together and dividing their sum by three. Thus, for an antenna system forty-

ANTENNA, CIRCUIT OF

five feet long and forty feet high it is seen that the inductance of the horizontal portion is 30 microhenries and of the vertical portion 21 microhenries. Their sum is 51 microhenries and the approximate effective inductance is one third of 51 or 17 microhenries.

ANTENNA, CIRCUIT OF.—The antenna circuit includes the horizontal antenna wires, the lead-in and all the connections up to the receiver, the inductance or capacity which is inside the re-

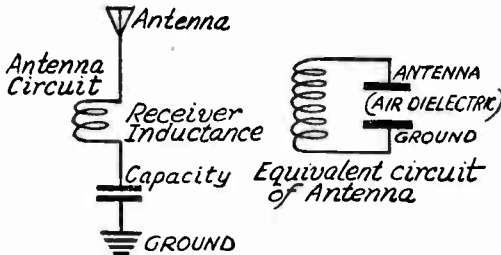

The Antenna Circuit and Its Electrical Equivalent.

ceiver, the ground lead from the receiver and the ground itself which forms the lower plate of the antenna system.

ANTENNA, CLOSED.—A loop antenna is called a closed antenna. See *Loop*.

ANTENNA, COIL TYPE.—In general a coil type of antenna is a loop antenna. See *Loop*. One end of a large coil of wire is sometimes connected to a receiver for use as an antenna, the other end of the coil being left open.

ANTENNA, CONDENSER FOR.—See *Condenser, Antenna*, also *Antenna, Tuned*.

ANTENNA, CONDENSER TYPE OF.—See *Antenna*.

ANTENNA, COUPLING OF.—The general custom in coupling the antenna to the first tuned circuit in the receiver is to use a very small coil of only a few turns of wire in series with the antenna as in Fig. 1. This small coil absorbs only a very little energy from the tuned circuit in the receiver and tuning is fairly sharp. However, the signal power with such an arrangement is not as strong as when the antenna itself is tuned to the frequency being received. The looser the coupling the sharper the tuning and the closer the coupling up to a certain point, the greater the amount of power or energy received from the antenna.

With the antenna coupled very loosely to the first tuned circuit the capacity and inductance of the antenna have but little effect on this first tuned circuit. As the degree of coupling is increased some of the antenna capacity and inductance are, in effect, added to the tuned circuit and if a variable condenser is used for tuning this circuit a lower setting or less capacity will be required because of the effect of the antenna which takes the place of part of the condenser's capacity. This is the reason why condenser settings for a certain frequency or wavelength will change when the antenna coupling is

ANTENNA, COUPLING OF

changed in receivers using variable antenna coupling to control the selectivity or sharpness of tuning.

The coupling of the antenna to the coil of the first tuned circuit may be reduced by reducing the number of turns in the antenna coil. It may be reduced by moving the antenna coil farther away from the coil which is tuned by the condenser or by turning the antenna coil and the tuned coil at greater and greater angles to each other. When they are at right angles the coupling is practically zero and the antenna's capacity and inductance will have very little effect on the tuning. All of these changes are shown in Fig. 1.

The form of antenna coupling shown in Fig. 2 provides maximum selectivity and very satisfactory operation in general. The antenna coil and the tuned coil are placed at right angles with each other and in line so that there is practically no inductive coupling between them. The antenna coil is composed of two windings, one having

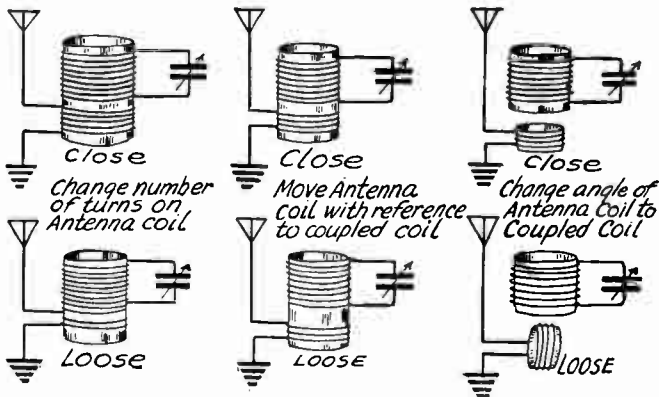

FIG. 1.—Close Coupling and Loose Coupling of Antenna Circuit.

four to six turns connected between the antenna and ground, the other having an equal number of turns in series with the tuning coil. The tuning condenser is connected across the two coils so that the entire winding of the large coil and the few series turns on the small one are both in the resonant circuit. The two windings on the antenna coil may be separated by one-quarter to one inch depending on the degree of selectivity required.

There is a certain best coupling for the antenna as far as signal strength is concerned. By starting with an extremely loose coupling secured with the antenna coil and tuned coil very far apart or at right angles to each other or by using but few turns in the antenna coil, the signal strength will be weak. By gradually increasing the degree of coupling the signal strength will become greater, although the tuning will become somewhat broader at the same time, until a maximum signal strength is reached. Then with still closer coupling, the signal strength will become less. There are two reasons for this effect. First, a very closely coupled antenna absorbs power from the first tuned circuit or places a load on this tuned circuit. Second, with very close

ANTENNA, DIRECTIONAL EFFECT

coupling the tuned coil and the antenna coil form a combination which responds not only to one frequency or wavelength but almost as well to another frequency or wavelength which is different from the first. The difference

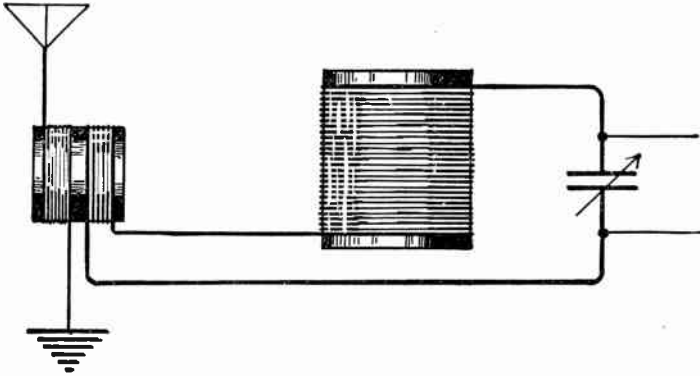

FIG. 2.—Separate Coupling Coil for Antenna Circuit.

between these two frequencies becomes greater as the coupling is increased and with very close coupling the antenna tuner will respond to either one of these frequencies. See *Coupling, Optimum*.

The use of a coupling tube to prevent antenna inductance and capacity from affecting the first tuned stage is shown under *Receiver, Single Control*.

The use of a tapped antenna coil or coupler to obtain various degrees of coupling is shown in Fig. 3. This changes the number of active turns in the antenna coil.

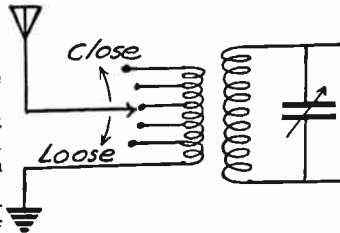

FIG. 3.—Tapped Coil for Antenna Coupling.

ANTENNA, DIRECTIONAL EFFECT OF.—It is often found that signals will be received best from a direction opposite to that in which the antenna runs from the receiver. If the antenna end points westward best reception may be from points to the east. Unless the antenna is at least one hundred feet long it will show no directional effects regardless of the direction it runs and will receive just as well from one point of the compass as from any other. Any apparent directional effects are due to local conditions such as interference of trees and buildings and antenna location in general.

ANTENNA, FORMS OF.—Receiving antennas of the outdoor type usually consist of a single straight wire open at one end and connected to the receiver at the other end. This is called an L-type antenna or an inverted L antenna. A connection is sometimes made to the center of the elevated wire rather than to one of its ends and the resulting antenna is called a T-type antenna.

ANTENNA, FRAME

Antennas placed indoors may be of the familiar type consisting of a single wire attached to the receiver or of the loop type. Both of these are described under their respective headings.

Transmitting stations use various forms of aerials that are seldom if ever duplicated as to form in receiver installations. A cage aerial or antenna consists of several parallel wires supported around the edge of frames so that they have somewhat the appearance of a squirrel cage. Umbrella aerials consist of a number of wires radiating from a central support and slanting downward toward the earth at their outer ends. The conductors of a fan or harp aerial radiate upward from a central point to a supporting wire across the top.

ANTENNA, FRAME.—Another name for a loop. See *Loop*.

ANTENNA, FUNDAMENTAL FREQUENCY OF.—The fundamental frequency of an antenna is the frequency to which the antenna's inductance and capacity are resonant in themselves. In an actual receiver installation the fundamental frequency of the entire antenna circuit is determined by the antenna's inductance and capacity together with the inductance of any coil and the capacity of any condenser placed in this circuit. The antenna system will respond best to frequencies below its natural frequency or to wavelengths above its natural wavelength.

The fundamental frequency of an antenna circuit may be found from the effective inductance and effective capacity in the system. These values for various heights and lengths of single wire antennas are given under *Antenna, Capacity and Inductance of*. The following formula is used:

$$\text{Antenna Frequency in Kilocycles} = \frac{159.3}{\sqrt{\text{Effective Inductance} \times \text{Effective Capacity}}}$$

The following table gives the approximate fundamental frequencies in kilocycles and the wavelengths in meters of antenna systems of various heights and lengths when there is no extra capacity or inductance placed in the antenna circuit by condensers or coils used in or with the receiver.

FUNDAMENTAL FREQUENCIES AND WAVELENGTHS OF ANTENNAS

Antenna Height in Feet	Length in Feet of Horizontal Portion of Antenna									
	30 ft.		45 ft.		60 ft.		75 ft.		100 ft.	
	<i>Kilo-C Meters</i>	<i>Meters</i>	<i>Kilo-C Meters</i>	<i>Meters</i>	<i>Kilo-C Meters</i>	<i>Meters</i>	<i>Kilo-C Meters</i>	<i>Meters</i>	<i>Kilo-C Meters</i>	<i>Meters</i>
20 ft.	5060	59	3940	76	3145	95	2650	113	2100	143
30 ft.	4360	69	3515	85	2875	104	2475	121	1980	151
40 ft.	3720	80	3085	97	2655	113	2325	128	1855	162
60 ft.	2950	102	2550	118	2200	136	1910	157	1625	185
100 ft.	2060	145	1840	163	1655	182	1530	196	1305	229

ANTENNA, HEIGHT AND LENGTH

If a concentrated inductance in the form of a coil is placed in the antenna circuit, its inductance is added to the effective inductance of the antenna and lead-in and the resulting total inductance is used in the preceding equation for antenna frequency. The two inductances are considered as in series and are added together.

If a fixed or variable condenser is used in series with the antenna and lead-in the capacity of this series condenser must be taken into account when using the formula for antenna frequency. For use in that equation the value of total capacity of antenna, lead-in and condenser is found as follows:

$$\text{Total Capacity} = \frac{\text{Capacity of Series Condenser} \times (\text{Capacity of Antenna} + \text{Capacity of Lead-in})}{\text{Capacity of Series Condenser} + \text{Capacity of Antenna} + \text{Capacity of Lead-in}}$$

All of the tables and equations for antenna fundamental frequencies and wavelengths assume that the antenna is free from the effects of objects such as trees, buildings and metal bodies in its field. It is seldom possible to erect an antenna system under such ideal conditions and the fundamentals of actual installations may vary widely from the figures given. The relations between frequencies for different lengths and heights of antennas will, however, remain in the same ratios to one another when conditions are similar for the installations.

ANTENNA, HEIGHT AND LENGTH OF.—The effective height of antenna is considered from the electrical and not the physical standpoint. The effective height is less than the physical height

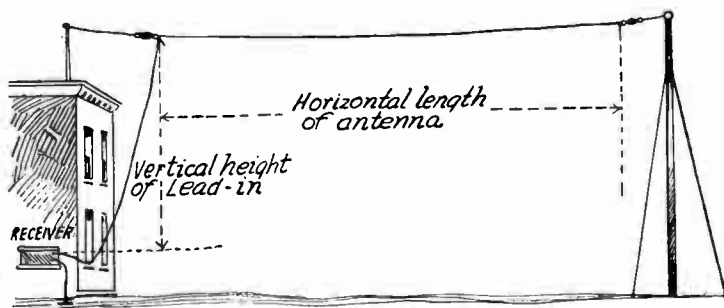

Physical Length of an Antenna and the Height of Its Lead-In.

because of objects in the antenna field. The higher and longer an antenna the more powerful will be the signals brought in, but unfortunately the louder will be all forms of interference as well. An antenna has no power of selection in itself and it takes exactly what the ether gives it.

A high antenna brings in lots of signal and also lots of interference, such as static. As the antenna is lowered the signal strength becomes less but it does not fall off as rapidly as the static, in other words, a low antenna gives a material gain in the ratio of signal to

ANTENNA, INDOOR TYPE

static. By a low antenna is meant one only five, ten or fifteen feet high, or at least one that is less than thirty feet high.

Of course this low antenna will not bring in such powerful signals but a good receiver will amplify its weaker signals to a point that is entirely satisfactory. There is a sort of superstition that thirty feet is the right height for an antenna. This is not based on any exact rule because the best height depends on particular conditions.

As a general rule it is best to have the horizontal or straight part of an antenna at least sixty to seventy-five feet long. This does not mean that excellent work cannot be done with fifty feet or less but seventy-five feet may be better. An antenna more than one hundred feet long, that is, with the straight horizontal part more than one hundred feet long, is not required by modern receivers. With many of the better sets the results will not be as good with one hundred and fifty to two hundred feet of antenna as with one hundred feet or less, considering selectivity, static interference and everything else that goes to make or mar satisfactory reception.

All of this advice applies to antennas used for broadcast receiving. Reception from long-wave commercial stations will require a much longer antenna, while short-wave reception among the amateurs will call for a much shorter antenna.

The best length of antenna depends on local conditions and on the type of receiver being employed. The following list gives lengths that are generally satisfactory. These lengths are the sum of the horizontal portion of the antenna, the lead-in to the receiver, and the ground connection from the receiver.

For receivers having six or more tubes. . . . 40 to 50 feet

For five tube, tuned radio frequency sets. .60 to 75 feet

For four tube sets with one radio stage. . . .80 to 100 feet

For three tube regenerative receivers. . . .100 to 120 feet

For one tube sets, crystal sets, etc.100 to 150 feet

ANTENNA, INDOOR TYPE.—An indoor antenna consists of twenty feet to one hundred feet of wire attached to the antenna terminal of a receiver and strung either in a straight line in the interior of a building or carried on various supports in various directions through the rooms of a building. This wire may be covered with insulation or it may be bare and supported on objects which are in themselves insulators.

An indoor antenna may be placed in a long room such as an attic with the use of the same insulators and supports employed in outdoor antenna construction. At the other extreme of construction we find a piece of wire laid along the picture moulding in one or more rooms with no extra precautions as to insulation. Either type will work but the more careful the construction the better will be the results.

An indoor antenna will not deliver as strong impulses to the receiver as would be delivered by an outdoor antenna of the same size but if the receiver has sufficient amplification the results may be surprisingly good. A receiver

ANTENNA, INDUCTANCE OF

with one stage of radio and two of audio frequency amplification operated with an indoor antenna will deliver loud speaker volume from stations two hundred miles away under favorable conditions. With two stages of radio frequency amplification this distance range will extend to about five hundred miles. An indoor antenna increases selectivity and reduces the effects of static and interference in general.

ANTENNA, INDUCTANCE OF.—See *Antenna, Capacity and Inductance of*.

ANTENNA, INSULATORS FOR.—The end of an antenna farthest from the receiver should be supported with an insulator made especially for this purpose. Good insulators are made of porcelain, glass, or of high grade moulded insulating materials. Glass is excellent but well glazed porcelain is probably as good as glass as long as the glaze is not chipped or cracked.

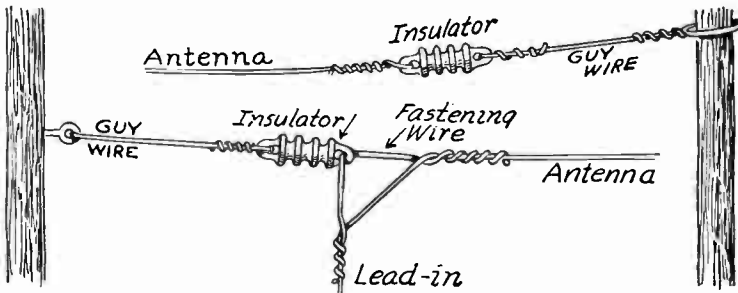

FIG. 1.—Installation of Antenna Insulators.

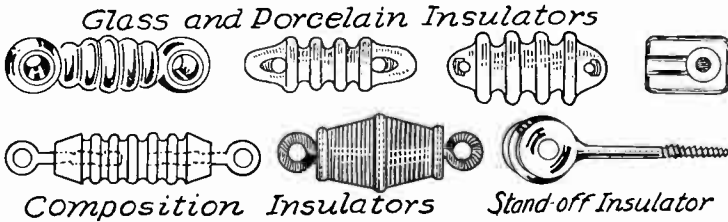

FIG. 2.—Types of Antenna Insulators.

The far end of the antenna should be fitted with one or two of these insulators as in Fig. 1. To the far end of the insulator should be attached at least five to ten feet of strong galvanized wire or any other strong wire. This is used for making the mechanical connection to whatever post or other support is used.

If it is necessary that the antenna turn any corners it should be held well away from walls or posts by using stand-off insulators as in Fig. 2. A stand-off insulator consists of a piece of glass or porcelain that holds the antenna wire and is itself held by a metal rod or flange that may be fastened to the wall, post or roof edge around which the antenna turns the corner. There should be at least two inches of insulating surface between the antenna wire and the nearest part of the metal support.

ANTENNA, LEAD-IN

Many stand-off insulators are made with a porcelain bushing, that is, a piece of porcelain with a hole through it, which is held in an eye formed on the metal bolt or screw. These are not as good as the form which provides a greater length of insulating surface between the antenna and the metal support.

ANTENNA, LEAD-IN FOR.—The lead-in includes all antenna circuit connections starting from the horizontal part of the antenna, running down into the building and to the receiving set. If there is anything more generally neglected than the antenna itself it is the lead-in. Too many radio enthusiasts seem to think that the chief purpose of the lead-in is to provide a final disposition for any scrap wire lying around the premises.

The first rule for the lead-in is to make it short. A lead-in, like an antenna, has inductance, capacity and resistance, but the inductance and capacity of the lead-in cannot be used to such good advantage as when in the antenna itself. To take an extreme case, a lead-in one hundred feet high used with an antenna only thirty feet long would have three times the inductance and capacity of the

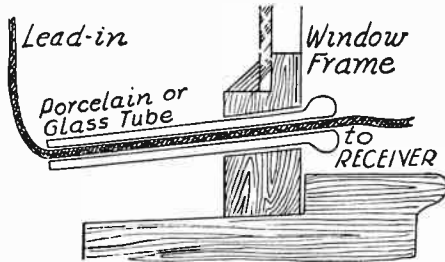

Antenna Lead-in Carried Through Tube.

antenna itself, but if the lead-in for this thirty-foot antenna were reduced to forty feet its inductance and capacity would be only about twenty per cent more than that of the antenna.

The lead-in is a part of the antenna circuit and within practical limits the lead-in should be kept away from everything. This does not mean that an entire pane of glass should be removed from a window to provide an opening into the building but it does mean to use stand-off insulators wherever they are required. Because insulated wire is used for a lead-in does not mean it may be dropped over the edge of a roof without any protection. There is no objection to using insulated wire for the lead-in if the wire is properly supported, but neither is there any advantage.

The lead-in wire from the antenna should be supported by insulators so that it is at least two or three inches away from all walls, ceilings, mouldings, etc., in the room through which it passes on the way to the receiver.

Sometimes the lead-in is connected near the center of the antenna rather than at one end. Then the effective length of the antenna is equal to about half its actual physical length or half that

ANTENNA, LIGHT AND POWER CIRCUIT

of an antenna of the same length in feet but having the lead-in at one end. Where the lead-in enters the building it should run through a porcelain or glass insulator. Such an insulator may be passed through a nine-sixteenths inch to three-quarter inch hole bored in the window frame.

The outer end of the lead-in wire should be scraped perfectly clean and a secure mechanical joint made between it and the end of the antenna wire, which also has been thoroughly cleaned of all insulation or oxide. This joint should then be thoroughly soldered. If it is impossible to solder the joint, wrap it tightly with tin foil, then cover the foil with a layer of rubber tape followed by a layer of friction or insulating tape. If rubber tape is not available use two layers of friction tape and cover the outside with a heavy coating of shellac.

If the lead-in wire enters a wall or window through a porcelain tube insulator, drill the hole for the insulator at a slant so that the outdoor end will tilt downward, thus preventing entrance of rain into the building.

In case it is objectionable to bore holes in window frames it will be best to open a window from the top, pass the bushing through this opening and push the window up against the bushing to hold it. If this lets in too much air, fit a piece of wood into the remaining part of the opening.

Various kinds of special lead-ins may be purchased. Some of these consist of a flat ribbon of copper encased in a covering of insulating fabric. Such a device may be laid over the window sill and the window closed tightly on it. The danger in this construction comes from the fact that the insulating covering may be broken through so that water from rain or snow will ground the antenna, which means weak signals or no signals in the receiver.

Never use a lead-in device in the ends of which wires are held by spring clips or similar devices. All such joints will corrode in wet weather and this means that beyond such a point the antenna might just about as well be disconnected. Every joint from the farthest end of the antenna to the binding post in the receiver must either be soldered or else solidly bolted and well shellacked to keep water from the joint.

After the lead-in has entered the building it will have to be carried along walls, base-boards or mouldings until it reaches the receiver. This inside part should be made of well insulated stranded copper wire. From the standpoint of appearance a silk covered wire is best, although any other insulated wire will be as good from the standpoint of radio reception. As a final precaution, bring the lead-in from the building entrance to the receiving set in the straightest line possible, in a line with the fewest possible turns.

ANTENNA, LIGHT AND POWER CIRCUIT FOR.—

The wiring of the light and power circuits of any public service company may be made to act as a fair antenna. Of course, it would not do to connect such wires directly to the antenna post of a receiver but by placing a fixed condenser between the light or power wires and a wire leading to the antenna post of the receiver, the radio impulses which are always present in such wires are carried into the receiver without interruption. The principle of such a device is shown in the illustration.

ANTENNA, LOCATION

Special forms of connectors which screw into an electric light socket may be purchased. These devices have one or more terminals from which wires may be run to the receiver. It will be realized that two sides of a circuit from the power or light lines enter any lamp socket. On one side the circuit is completed through a switch often incorporated in the lamp socket. The other side of the circuit is completed through the socket by a direct metallic connection at all times.

The antenna device which is screwed into the socket is provided with capacity coupling through one or more fixed condensers leading to both sides of the power circuit. There are usually two terminals, one for each side of the circuit. Better results will be obtained when the connection is made to the side of the circuit which does not run through the switch. Which of the terminals connects to this side may be determined by trying each of them; the one that works better being used permanently.

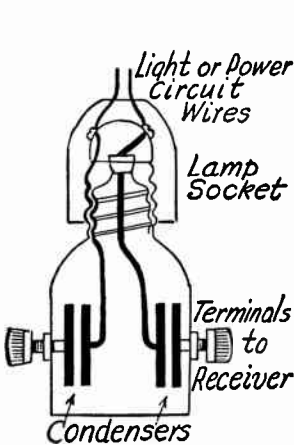

Antenna Connection to Light and Power Circuit.

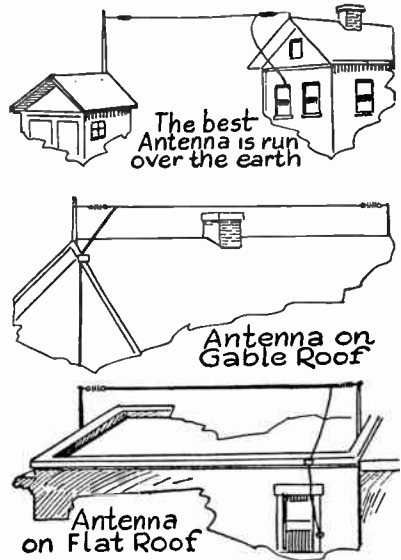

Various Locations for an Antenna.

ANTENNA, LOCATION OF.—Among the first things to consider about the antenna is location. To begin with it is better to run an antenna out over the earth, with nothing between the wire and the earth except air. An antenna on a roof may be very good but it cannot be as good as one that does not have a building underneath it.

It is often said that an antenna should not run over or under any kind of electric wires and should not be attached to any pole which carries other wires. There are two excellent reasons for these rules. First, it is dangerous and should these wires come in contact with the antenna through breakage of either it is more than probable that at least a part of the receiver will be destroyed and the final result may be a dangerous fire.

ANTENNA, LOOP TYPE

The second reason is that in many cases reception may be practically spoiled with an antenna in such a location. An antenna is nothing more than a big condenser with its wire for one plate and the earth for the other. If other wires carrying strong electric charges are between or near the "plates" of this big condenser it will receive signals from these other wires as well as from broadcasting stations. This applies even to guy wires on poles.

There are laws in many localities which forbid the placing of any wire above a public highway, and, in the cities at least, alleys are considered as public highways. The farther the antenna wire is kept from everything else on its way to the receiver the better will be the reception. The closer the antenna comes to wooden posts, brick walls, tin roofs, gutter spouts, fences, or trees, the worse it will be.

ANTENNA, LOOP TYPE.—See *Loop*.

ANTENNA, MULTIPLE LINE.—It is sometimes a question whether to put up a single wire for an antenna or to put up two or more parallel wires. The two-wire antenna of given length will bring in stronger signals than a single wire of the same length but nowhere near twice as strong. A three-wire antenna will bring in more signal strength than a two-wire antenna but it will not bring anything like half as much again.

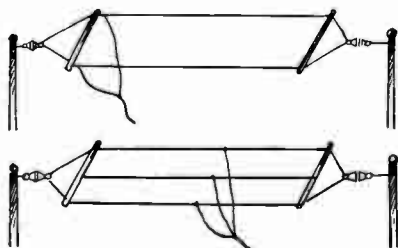

Multiple Wire Antennas.

If a two-wire antenna is erected, the wires should be about two feet apart. If their distance apart is less than two feet it would be almost as well to use one wire. On the other hand there is very little gain by making the spacing much more than two feet. With two or more parallel wires, connect them together at both ends and attach the lead-in as shown in the illustration.

The wires in two-wire or three-wire antennas are separated from each other by spreaders which may be of hard wood pieces about one inch square. The antenna wires may be passed through holes drilled in these spreaders with a half turn of wire taken around the spreader to prevent the wire from slipping. A better method of fastening is to use separate short lengths of wire passed through the holes in the spreaders and twisted around the long straight lengths of the main antenna wires.

All of the wires in a multiple wire antenna must be of the same length and they must be securely fastened so that none of them will sag. The lead-in wire may be attached to the antenna wires either at one end or in the center of the antenna, both constructions being shown.

ANTENNA, MULTIPLE RECEIVER CONNECTION

ANTENNA, MULTIPLE RECEIVER CONNECTION TO.—A single outdoor antenna may be used as a source of signal energy for two or more receivers with circuits arranged to allow each receiver to select any desired station regardless of the stations

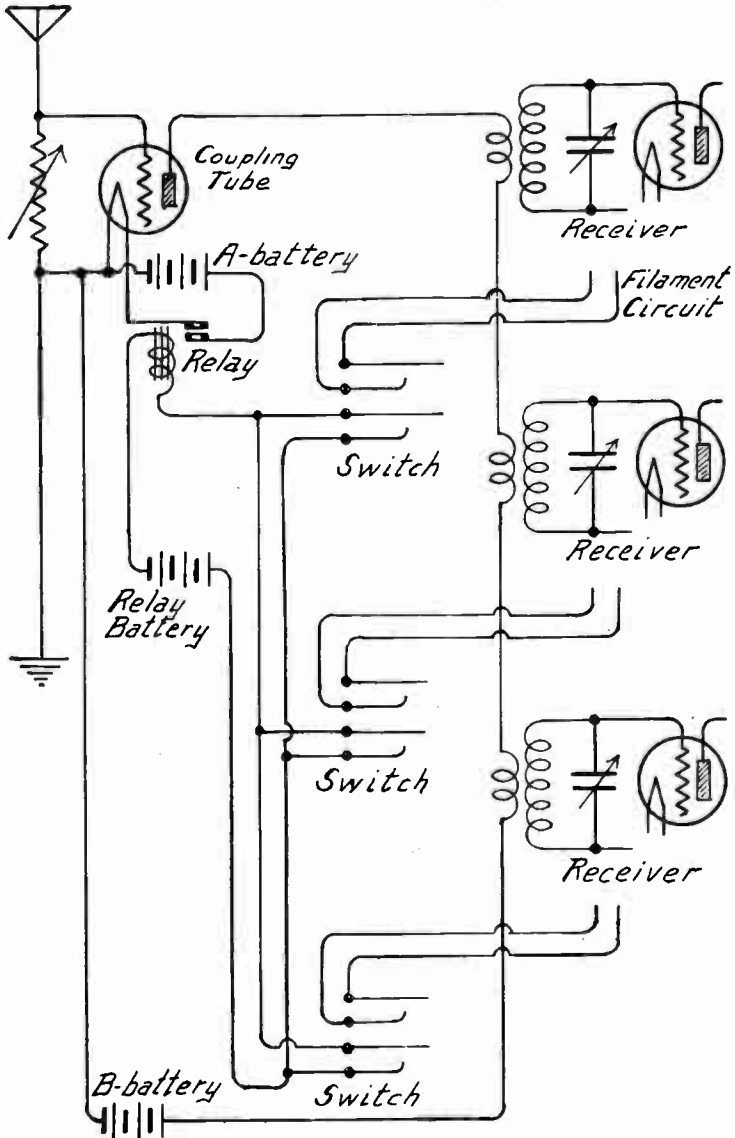

Connections for Operating Several Receivers from One Antenna.

ANTENNA, OPEN

tuned in by others using the same antenna. The connections are shown in the diagram.

Between the antenna and the ground is a variable high resistance and across this resistance is placed the grid circuit of a common coupling tube. The plate circuit of this coupling tube passes through any number of primary windings in radio frequency coupling coils of the separate receivers. The common plate circuit carries all signal frequencies reaching the antenna.

Each receiver uses the coupling coil as the primary winding of a radio frequency transformer in the first tuned circuit of the receiver. The balance of the receiver may consist of any combination of radio frequency amplifying stages, detector, and audio frequency amplifying stages.

Near each receiver is placed a double-pole, single-throw switch which is arranged to close the filament circuits or A-battery circuit of the receiver at the same time it closes an auxiliary circuit which lights the filament of the common coupling tube through a relay.

The coupling tube has its own filament battery which is connected to the contacts of a relay. The relay is connected to each of the double-pole switches at the receivers in the manner shown. Closing the switch at any receiver will light the tube filaments in the receiver and at the same time will energize the relay magnet so that the common coupling tube is placed in operation. The coupling tube will remain lighted as long as any receiver switch remains closed and will go out when the last receiver switch is opened.

While this arrangement allows simultaneous reception from one antenna at various frequencies, it greatly reduces the strength of signal in comparison with that received from the same antenna without the coupling tube in use. A great portion of the energy collected is allowed to leak away to ground through the resistance. If the resistance is made excessively high in an attempt to avoid this loss, the receivers connected to the circuit will become unstable and will have a noticeable tendency to pick up and amplify all kinds of interference, even that from power supply units which would be unnoticed ordinarily.

Reception from local and nearby stations is satisfactory with this scheme of coupling. There is an advantage in the fact that the effect of static disturbances is greatly reduced below their normal strength, the reduction of static being considerably greater than the reduction of signal so that the signal-static ratio is improved. The same method of antenna coupling is used in single control receivers to prevent the antenna inductance and capacity from affecting the first tuned circuit.

ANTENNA, OPEN.—A capacity type of antenna or an antenna consisting of one or more elevated wires and a ground between which is connected the receiver.

ANTENNA, RESISTANCE OF.—See *Resistance, Antenna.*

ANTENNA, RESONANCE WAVE COIL

ANTENNA, RESONANCE WAVE COIL TYPE.—A fairly efficient antenna may be made by winding a large number of turns of small wire on a tube about three inches in diameter. One end of this coil is connected to ground as shown and the other end is left free. Two or three turns of wire should be placed around

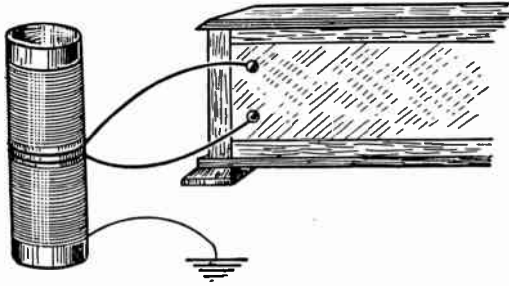

Resonance Wave Coil for Antenna.

this resonance coil and the ends of these turns connected to the input of a receiver. Signals from considerable distance may be received with this arrangement, which acts as a combination of antenna and loop.

ANTENNA, SERIES-PARALLEL SWITCH FOR.—In the diagram are shown the connections for a series-parallel switch by means of which a fixed or a variable condenser may be placed in series with the antenna, in parallel with the antenna, or cut out

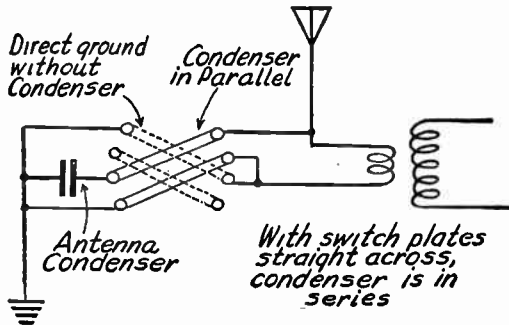

Series-Parallel Switch for Antenna Condenser.

of the antenna circuit entirely. Placing the condenser in series with the antenna allows the receiver to be tuned to shorter wavelengths than normally possible, while placing the condenser in parallel with the antenna allows the receiver to be tuned to longer wavelengths than normally. With the condenser out of the circuit the normal range of the receiver is obtained. See also *Switch, Series-Parallel*.

ANTENNA, TUNED

ANTENNA, TUNED.—An antenna may be tuned by placing a large capacity variable condenser in series with the lead-in or in series with the antenna circuit inside the receiver. Such a series condenser should have a capacity of .001 microfarad. The connections are shown in Fig. 1. Even with this large capacity condenser it may be found difficult to tune an antenna of ordinary size over the entire band of broadcasting frequencies now in use.

A better method of tuning the antenna is with a variometer in series with the antenna circuit. This makes the antenna act as a fixed capacity while the variometer acts as a variable inductance with which the antenna circuit may be tuned to resonance at any desired frequency. The capacity of the antenna will generally be too great to allow the entire inductance range of an ordinary variometer to be used in tuning over the broadcast frequency band. The

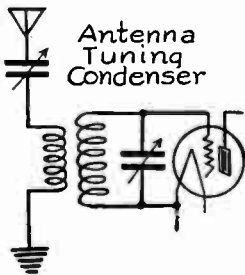

FIG. 1.—Connection of Series Condenser for Antenna Tuning.

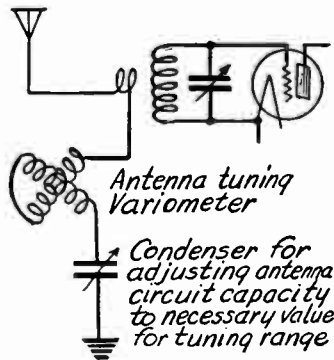

FIG. 2.—Use of Variometer for Antenna Tuning.

entire broadcast band will be covered by using only a part of the variometer's total change of inductance and only a part of the tuning dial scale will be employed. In such a case the capacity of the antenna system may be reduced by inserting a variable series condenser as shown in Fig. 2. This condenser may be adjusted to such a value that the variometer will tune to resonance over the entire range of frequencies to be received and use all of its tuning dial. This method provides great distance getting ability together with satisfactory selectivity. The construction using this plan is shown under *Receiver, Tuned Radio Frequency*.

When the antenna circuit is tuned to the same frequency as that to which the grid circuit of the first tube is tuned it will be found that a moderate degree of coupling between the antenna circuit and the grid circuit of the first tube places a heavy load on the grid circuit of this tube. In order for the first tube to oscillate it must develop power enough to set the entire antenna circuit into oscillation. This requires more power than is generally available.

Consequently, while a tuned antenna circuit will make the antenna more responsive to the tuned frequency and will bring more powerful signals into the receiver, the additional load of the antenna circuit prevents the first tube

ANTENNA, UNDERGROUND

from oscillating readily at the tuned frequency. Of course, even with the antenna tuned, the first tube will oscillate provided the coupling between its grid circuit and the antenna circuit is made very loose. A loosely coupled tuned antenna places very little load on the grid circuit of the first tube and oscillation is comparatively easy.

ANTENNA, UNDERGROUND.—Because of the fact that radio waves penetrate for a little depth into the earth it is possible to use a buried wire as an antenna in place of the usual elevated wire type. An underground antenna has a better signal to static ratio and is more selective than the elevated type. The buried wire also has a more pronounced directional effect. To offset these advantages the signal strength with the underground antenna is only a fraction of the strength with the usual constructions and it is necessary to use at least two tubes to obtain headphone reception.

The wire should be of copper, number 14 gauge or larger. It must be well insulated with rubber covering. To obtain satisfactory life and length of service from a buried antenna the wire should have live rubber covering about one-quarter inch thick. For broadcast reception the buried portion of the antenna should be about seventy-five feet long and may be buried from six inches to two feet deep. The more moist the earth the better will be the results with this method of reception.

ANTENNA, WAVELENGTH OF.—See *Antenna, Fundamental Frequency of*.

ANTENNA, WIRE FOR.—For antenna wire first choice is stranded enameled copper or phosphor bronze. The second choice is a solid wire, enamel covered. The third and fourth choices would be bare stranded wire, then bare solid wire. Iron or steel wire do not enter into radio construction. To this last statement there is a possible exception in that steel-cored copper wire would form a satisfactory antenna and would have greater mechanical strength than a wire of solid copper or bronze. Antenna wire should be of number 14 or number 12 gauge.

Radio impulses in the antenna travel almost wholly on the surface of the wire and the inside of the wire might just as well be hollow, in fact it would be better if it were hollow.

The great majority of antennas are found covered with corrosion. This corrosion is formed by the combination of oxygen in the air with the copper of the wire and, unlike a covering of enamel or other properly applied insulation, the corrosion becomes a part of the wire itself, in other words the outside of the antenna is no longer copper but is copper oxide.

Copper is the best of all conductors for radio impulses but copper oxide is very poor. Since radio impulses travel on the surface of the wire, if this surface is composed of the high resistance copper oxide such an antenna has lost much of its effectiveness as a conductor of signals.

ANTI-CAPACITY SWITCH.—See *Switch, Anti-Capacity Type*.

ANTINODE.—A point in a wave which is half way between two adjacent peaks or half way between two points of maximum amplitude. See *Node*.

ANTI-RESONANCE.—Another name for parallel resonance. See *Resonance, Parallel*.

APERIODIC

APERIODIC.—Not resonant at any particular frequency; un-tuned. Various coils and windings in radio receivers are said to be aperiodic when they are not tuned to the frequency being received but are allowed to act in a non-resonant state. See *Resonance*.

A-POWER SUPPLY UNIT.—See *Charger; Battery, Trickle Type*; also *Power Unit, Filament Current Types of*.

ARGON BULB RECTIFIER.—See *Charger, Battery, Bulb Type*.

ARITHMETICAL.—Pertaining to arithmetic. Arithmetical progression is the relation between a series of numbers or values in which the difference between any consecutive two is the same as the difference between any other consecutive two numbers or values.

ARMSTRONG RECEIVER.—A regenerative receiver. See *Receiver, Regenerative*.

ARRESTER, LIGHTNING.—A radio antenna has no more tendency to attract lightning than is found in other metal parts such as eaves troughs, rain spouts, wire clothes lines, etc. Should lightning strike an antenna directly no antenna construction and

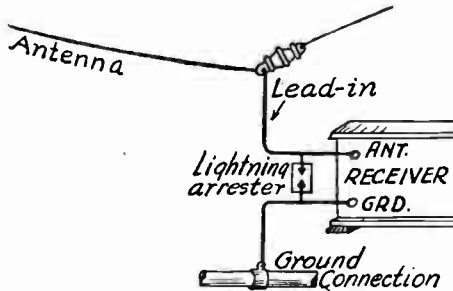

FIG. 1.—Connection of Lightning Arrester to Antenna and Ground.

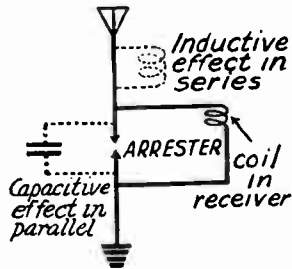

FIG. 2.—Effect of Inductance and Capacity in a Lightning Arrester.

no form of lightning arrester would stand the great strain. During atmospheric storms a certain amount of electrical charge will collect on the antenna. There is also some charge collected during rain storms and snow storms. Such charges, if not too large, may leak off gradually over the connections and supports of the antenna. They will also discharge through the receiver, causing static noises.

All receiver installations should have some form of lightning arrester placed as shown in Fig. 1 between the antenna or lead-in and the ground wire. An electrical charge of such volume as to damage coils, condensers and other parts in the receiver will jump across the small gap in the lightning arrester and pass harmlessly to ground. A lightning arrester consists of two points or electrodes supported a little distance from each other and placed between the antenna and ground with one point connected to the antenna and the other to the ground. The points are placed such a distance apart that

ARRESTER, LIGHTNING

500 volts or more will jump through the air or vacuum from the point connected to the antenna to the point connected to the ground. The purpose of a lightning arrester is to protect the parts of the receiving set.

Certain requirements for the construction and action of lightning arresters have been laid down in the National Electric Code. Following is a summary: The spark gap may be located in a vacuum, in a gas-filled tube, or in air. Electrodes in air shall be of brass, phosphor bronze, carbon or some other non-corroding material. If in a vacuum or gas-filled tube the electrodes may be of any conducting material. There must be a dust-proof enclosure for the gap and if the arrester is to be placed out of doors this enclosure must also be weather-proof. Any lightning arrester must allow an arc to form and a discharge to pass between the electrodes when an alternating voltage of 500 or more volts is applied.

The foregoing requirements are specified from the standpoint of protection from electrical discharges but it is also necessary to consider lightning arresters from the standpoint of radio reception. As with anything else pertaining to radio the lightning arrester has resistance, capacity and inductance. Too low a resistance bypasses the signals around the receiver and to ground. The capacity of a lightning arrester is in parallel with the capacity of an antenna and is added to the antenna capacity. Any inductance in the arrester is in series with the antenna. This is shown in Fig. 2. Both the capacity and inductance of the arrester will raise the natural wavelength or lower the natural frequency to which the antenna responds.

Fire Underwriters' rules require a lightning arrester in each radio installation. A lightning arrester approved by the Fire Underwriters is satisfactory from the fire prevention standpoint but may be unsatisfactory in its effect on radio signals. The resistance of an arrester should be as high as possible to avoid bypassing signals around the receiver. The capacity and inductance should be as small as possible to avoid affecting the tuning and operation of the receiver. The installation of a lightning arrester between antenna and ground reduces the voltage through the receiver and reduces the signal strength. This cannot be avoided unless the receiver has a tuned antenna circuit. With a tuned antenna a lightning arrester has comparatively little effect on signal strength.

Many types of construction are found in lightning arresters. Some are built with carbon electrodes separated by a thin sheet of mica. Unless well protected there is danger that dirt or moisture will short circuit this type. Many arresters are built with brass or copper electrodes sealed into a tube for protection. Since an arc-over must occur at 500 volts there can be only small separation between these electrodes. Another type of arrester has its electrodes sealed into a vacuum tube. Here it is possible to use a greater gap because the vacuum reduces the resistance. This type is satisfactory as long as the enclosing tube remains tight and does not admit air or moisture.

The electrostatic capacity of lightning arresters varies between five and thirty-five micro-microfarads. The addition of thirty-five micro-microfarads to the antenna capacity may have a decided effect on tuning. Lightning arresters having carbon electrodes separated by sheet mica generally have high capacity because the carbon electrodes are very close together.

See also *Rules, Underwriters' and Ground, Receiver.*

ASSEMBLY, ORDER OF

ASSEMBLY, ORDER OF.—See *Construction, Receiver*.

ASTATIC COIL.—See *Coil, Closed Field Type*.

ATMOSPHERICS.—A name given to static disturbances affecting radio reception. See *Static*.

ATTACHMENT, PHONOGRAPH.—See *Adapter, Phonograph*; also *Amplifier, Phonograph Type*.

ATTENUATION.—The decrease in strength of radio signals which is due to absorption of the energy from the waves as they travel through space and strike various objects in their path. Attenuation increases as the distance from the transmitter increases. The amount of attenuation depends greatly on the character of the land over which the waves travel. See *Radiation*.

ATTENUATION NETWORK.—See *Pad*.

AUDIBILITY.—Audibility is a measure of the strength of a signal as it affects the ear of a listener. Degrees of audibility are generally specified according to the number of times a signal is louder and clearer than when it is just recognizable. Degrees of audibility range from faint, through weak, fair, moderately strong, strong, good, very good and finally reach extremely strong audibility. A signal may be audible to a strong degree, yet may be hardly recognizable because of interference, fading, static, etc.

AUDIO FREQUENCY.—See *Frequency, Audio*.

AUDIO FREQUENCY AMPLIFIER.—See *Amplifier, Audio Frequency*.

AUDIO FREQUENCY CHOKE COIL.—See *Coil, Choke*.

AUDIO FREQUENCY TRANSFORMER.—See *Transformer, Audio Frequency*.

AUDION.—A name sometimes applied to a three-electrode vacuum tube. See *Tube*.

AURORA BOREALIS.—A visible effect of atmospheric electricity playing in the sky. Static disturbances are usually quite bad during the time of an aurora.

AUTODYNE FREQUENCY METER.—See *Meter, Frequency*.

AUTODYNE RECEPTION.—See *Receiver, Superheterodyne*.

AUTOFORMER, COUPLING WITH.—See *Amplifier, Audio Frequency, Impedance (Step-Up Type)*.

AUTOMATIC TUNING.—See *Tuning*.

AUTOMATIC VOLUME CONTROL.—See *Volume Control of*.

AUTO-TRANSFORMER.—See *Transformer, Auto-*.

AVERAGE VALUES.—See *Value, Average and Effective*.

A. W. G.—An abbreviation for American Wire Gauge.

B

B. b.—Symbols for magnetic induction. Susceptance in mhos.

BACK COUPLING.—See *Feedback*.

BACK VOLTAGE.—See *Electromotive Force*.

BAKELITE.—See *Phenol Compounds*; also *Resistance, Insulation*.

BALANCED ARMATURE SPEAKER.—See *Speaker, Loud*.

BALANCED CIRCUIT.—See *Balancing*.

BALANCING.—Between the internal parts of a vacuum tube there are capacities due to the fact that the parts are of metal, a conductor, and they are separated by the vacuum as a dielectric. These internal capacities are explained under *Tube, Capacities, Internal*.

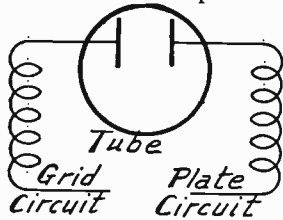

FIG. 1.—Internal Capacity of Tube Requiring Balancing.

The capacity between tube elements which are parts of the plate circuit and elements which are parts of the grid circuit within a single tube is the cause of considerable trouble. This trouble arises from the feedback of energy from the plate circuit to the grid circuit of the tube, the feedback producing regeneration and oscillation if allowed to continue. This capacity effect is inherent in the design of vacuum tubes and exists in all of them to some extent.

Since the amount of internal tube capacity is fixed by the design of the tube it cannot be changed after the tube is in operation. This capacity acts like any other capacity or condenser. Its reactance, or opposition to flow of alternating currents through it, becomes less and less as the frequency increases. Therefore, the feedback is greater at high frequencies or low wavelengths. The tube capacity is represented in Fig. 1.

The object of balancing is to provide a second feedback between various other external circuits through connections outside the tube. This second feedback is arranged so that energy passing through it is equal in amount to the tube feedback but is opposite in phase or polarity. The effect of the tube feedback is then exactly balanced by the external feedback. The result of combining the two feedbacks is to destroy the effect of both so that regeneration and oscillation are prevented.

The balancing feedback is primarily designed to compensate only for the internal feedback through the tube. As described under *Oscillation* there are many other causes of feedback of energy from plate circuit to grid circuit. These other causes are not properly within the province of the balancing scheme although excessive bal-

BALANCING

ancing capacity is often employed in an effort to overcome all kinds of feedbacks.

The principle of the balance of energies may be understood from Fig. 2. The feedback through the tube is represented at the upper left. The external balancing feedback is shown at the lower left. It will be seen that rises and falls of voltage are opposite in the two feedbacks. The combined energies which reach the grid circuit are

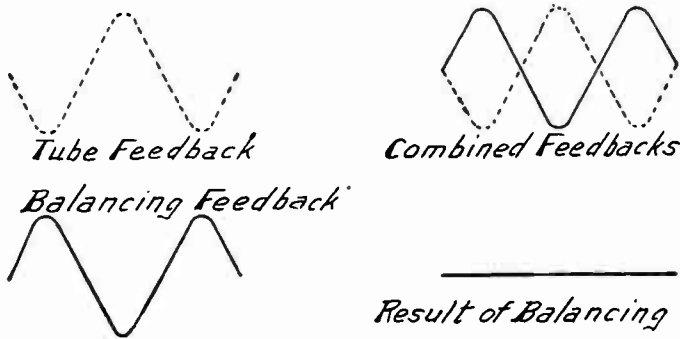

FIG. 2.—Combining the Feedbacks for Balancing.

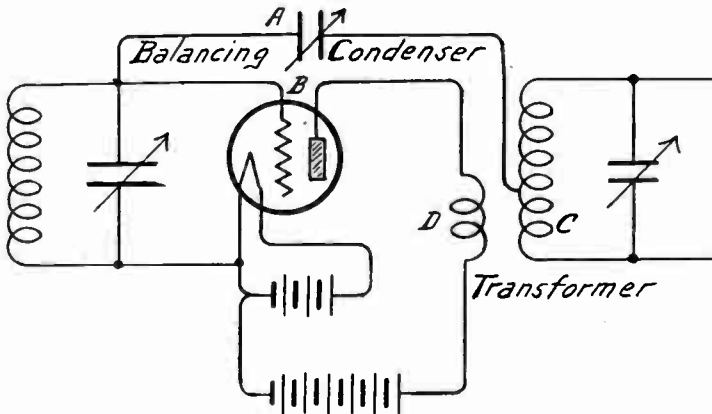

FIG. 3.—Neutrodyne Method of Balancing.

shown at the upper right of Fig. 2. At every point the positive and negative alternations are equal and opposite, consequently they destroy each other and leave a zero feedback.

Neutrodyne Balancing.—One of the first popular balanced circuits to come into common use was the Neutrodyne. Its principle is shown in Fig. 3. The feedback through the internal capacity of the tube takes place in the manner already mentioned. The exter-

BALANCING

nal balancing feedback is secured through a balancing condenser connected from the grid of the tube to be balanced to a tap in the secondary winding of the following radio frequency transformer. The tap is near the filament end of the secondary winding and voltages taken from this point are opposite in phase to those in the first grid circuit.

With the inductance of the part of the secondary below the tap equal to the inductance of the primary winding in the same transformer, the energy fed back will equal the energy passing through the tube capacity when the balancing capacity is equal to the tube capacity. Less inductance in the tapped portion of the winding requires greater capacity in the balancing condenser to equalize the two feedbacks. A greater inductance in the tapped

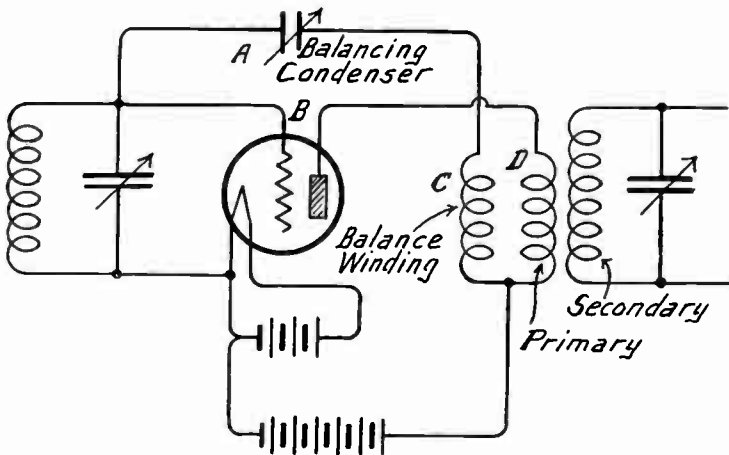

FIG. 4.—Roberts Circuit for Balancing.

winding allows the use of less capacity in the balancing condenser. See *Receiver, Neutrodyne*; also *Receiver, Browning-Drake*.

Roberts Method.—The balancing method used in the Roberts receiver is shown in Fig. 4. Here the balancing energy is secured from a special winding in the following radio frequency transformer. This balance winding is of the same inductance as the primary but is wound in the opposite direction so that voltages taken from it are of opposite phase to the voltages passing back from the primary through the plate into the grid circuit by way of the tube capacity. The balancing condenser is adjusted so that it allows enough feedback to just compensate for the internal feedback of the tube. See *Receiver, Roberts*.

Rice Method.—The Rice method of balancing is shown in Fig. 5. The winding in the grid circuit of the tube to be balanced is

BALANCING

tapped at its center. The tuning condenser extends across the entire winding. The upper end of the winding is connected to the grid in the usual way. The tap forms the grid return to the filament circuit. The lower end of the winding is connected through a balancing condenser with the plate of the tube being balanced.

Voltages fed back through the internal capacity of the tube from plate to grid enter the secondary winding at its upper end and pass down to the tap and return to the filament. Voltages fed back through the balancing condenser enter the secondary winding at the bottom and pass up to the tap and to the filament. The two voltages are made equal by adjustment of the balancing condenser to match the tube capacity. Since the two halves of the secondary winding are in opposition the two voltages entering it balance each other and any tendency to oscillation is destroyed. See *Receiver, Rice Control*.

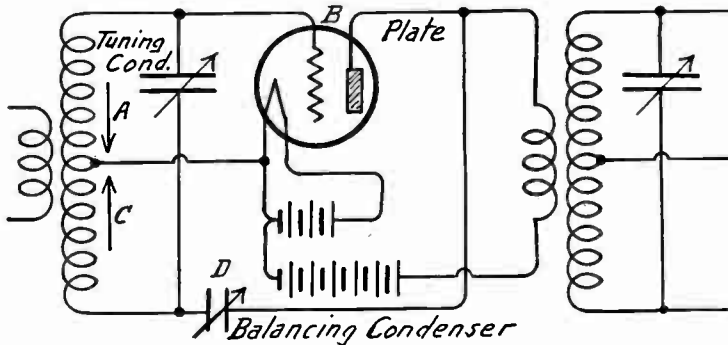

FIG. 5.—Rice Method of Balancing.

Balancing Adjustments.—Adjustment of the capacity of a balancing condenser is made according to the same general rules for all circuits using this principle of control. The balancing condenser's capacity is proportional to the internal capacity of the tube. Therefore, changing the tube in a balanced circuit will generally call for readjustment of the balancing condenser since it is very seldom that two tubes are found to have exactly the same internal capacity.

With all circuit connections properly made and with the balancing condenser set at about one-half its total capacity a signal from some station is tuned in with maximum possible volume. The station selected should be near enough to allow a strong signal to be received but should not be so close that its energy is picked up by the various parts and wires in the receiver. All of the signal should come in over the antenna, not through the coils and connections of the set.

The filament of the tube to be balanced is turned out by turning off its rheostat, by removing the filament control resistor or by dis-

BALANCING

connecting a wire from one of the filament terminals. No other changes are made, no other tubes are turned out, and the tuning controls are left unchanged. The signal from the station previously tuned in will still be heard with fair volume because of the energy that passes through the internal capacity of the tube.

The balancing condenser is then carefully adjusted so that the volume of the signal is at a minimum or until the signal disappears completely. This indicates that there is a balance between internal and external feedback capacities.

If the tube is removed from its socket the signal volume will increase because only the capacity of the balancing condenser remains and it is not compensated for by the capacity of the tube which has been removed from the circuit. If another tube is substituted for the one removed the signal may again reappear because of the changed capacity in the new tube.

The foregoing procedure of balancing should be carried out first on a low frequency or high wavelength station, then on a high frequency or low wavelength station. If it requires a considerable change of capacity in the balancing condenser to make the two adjustments at different frequencies the adjustment should be left about midway between the two points or slightly nearer the point used for the high frequency station.

When a change is necessary in the balancing adjustment for any change in received frequency it indicates that there are considerable feedbacks through stray capacities and through electromagnetic couplings in the receiver. The more of these that can be eliminated the nearer the two adjustments of the balancing condenser will come together. The change of adjustment required is caused by the balancing capacity attempting to compensate for these other feedbacks as well as for the feedback through the tube.

With the balancing condenser adjusted according to the directions given it should remain unchanged while the receiver is operated. An adjustment should be used that prevents oscillation at all frequencies or wavelengths to be received.

Balancing may be performed without listening to broadcasting stations by the use of methods explained under *Oscillator, Radio Frequency, Uses of*.

Regeneration may be brought about and may be increased until it passes into oscillation by using the balancing condenser as a regeneration control. As a rule the balancing condensers are placed inside the receiver cabinet and out of reach of the operator. If the condenser is to be used for regeneration control it should be placed on the panel with a dial or knob on the outside. See *Regeneration, Methods of Obtaining*.

Bridge Circuits.—All circuits in which the internal capacity of a tube is balanced by an external capacity may be classed as bridge circuits. This is because of their resemblance to a Wheatstone bridge or Wheatstone balance such as used in laboratory work for measuring capacities, inductances and resistances. The principle of the Wheatstone bridge is shown in Fig. 6.

Four resistances, *A*, *B*, *C* and *D*, are connected to form the four sides of a parallelogram. A meter is connected from a point between *A* and *B* to a point between *C* and *D*. A source of voltage is connected to the two remaining corners of the parallelogram. Cur-

BALANCING

rent from the source will flow through *A* and *B* as one side of a parallel circuit and through *C* and *D* as the other side, dividing between these two paths according to their resistances.

If the ratio of resistance in the arms is $A/B=C/D$ or $A/C=B/D$ the voltage drops will be such that the voltage at the upper connection to the meter is the same as the voltage to the lower connection. Since the voltages are equal at the two ends of the meter circuit there will be no flow of current through the meter or through any other conductor put in the meter's place.

The arms of the bridge may be composed of resistances as shown in Fig. 6 or of capacities or inductances. The two arms forming one ratio must be both resistances, both inductances or both capacities. These things must not be mixed up in a single ratio because, for example, the expression would be impossible to solve with a ratio calling for inductance to be divided by capacity. This is an important point in the design of bridge circuits.

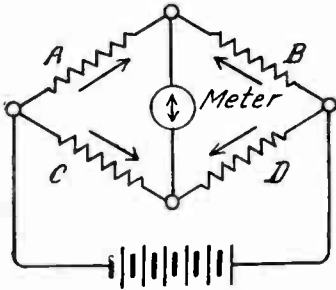

FIG. 6.—Balancing Principle of the Wheatstone Bridge.

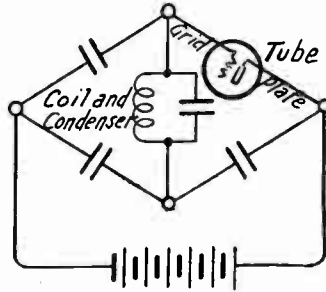

FIG. 7.—Position of Tube Capacity in a Bridge Circuit for Balancing.

In a radio circuit to be balanced it is desired that no feedback currents or voltages enter the grid circuit of the tube unless they are balanced out by other voltages. In building up a bridge arrangement the coil and condenser of the grid circuit may be put in place of the meter of Fig. 6 so that the bridge appears as in Fig. 7. Here the four arms are composed of capacities. Three of the capacities are formed by condensers and the fourth is formed by the capacity between plate and grid of a tube.

One arm of any bridge circuit must always be the plate to grid capacity of the tube. The two ends of the grid circuit will be at the top and at the bottom of the parallelogram as in Fig. 7. It is not necessary that both the coil and the condenser of the grid circuit be put in the center of the bridge as in Fig. 7 but they both must be connected between top and bottom of the bridge. The coil alone may be in the center with the condenser in the bridge arms or the condenser alone may be in the center with the coil in the arms.

Fig. 8 shows the circuit diagram of the Isofarad circuit and Fig. 9 shows this circuit rearranged as a bridge. The two tuning condensers *A* and *C* are moved

BALANCING

together on a single shaft. The balancing condenser is shown at *D*. The coil in the grid circuit runs from top to bottom of the bridge. The four arms are formed by the two tuning condensers, the balancing condenser and the tube capacity. With the capacities in the arms adjusted to conform to the proportion $A/C=B/D$ the bridge is balanced.

The Neurodyne circuit of Fig. 3 and the Roberts circuit of Fig. 4 are both represented by the bridge circuit of Fig. 10. For the Neurodyne, arm *A* of the bridge is formed by the balancing condenser, arm *B* is formed by the tube capacity, arm *C* by the portion of the secondary of the transformer which is

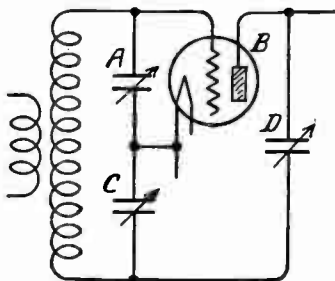

FIG. 8.—The Isofarad Method of Balancing.

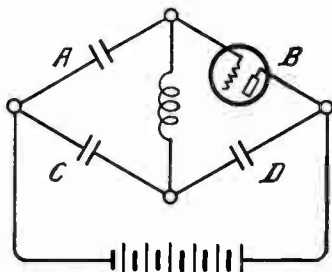

FIG. 9.—The Isofarad Balanced Circuit in Bridge Form.

below the tap, and arm *D* by the primary winding of the transformer. With the arms adjusted to the proportion $A/B=C/D$ the bridge is balanced and so is the receiver circuit.

For the Roberts circuit, arm *A* is formed by the balancing condenser, arm *B* by the tube capacity, arm *C* by the balance winding, and arm *D* by the

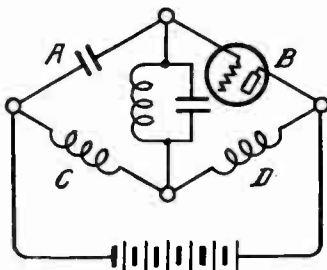

FIG. 10.—The Neurodyne Balanced Circuit in Bridge Form.

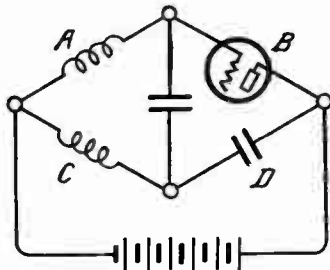

FIG. 11.—The Rice Balanced Circuit in Bridge Form.

primary winding of the transformer. The bridge is balanced when the arms are adjusted to the proportion $A/B=C/D$.

The Rice circuit of Fig. 5 is shown in bridge form by Fig. 11. Arm *A* is formed by the upper half of the secondary winding, arm *B* is formed by the tube internal capacity, arm *C* by the lower half of the secondary winding, and arm *D* by the balancing condenser. When the four arms are adjusted to the proportion $A/C=B/D$ the bridge is balanced and the two feedbacks compensate for each other.

It will be noticed that in all the proportions used for balancing the bridges of Figs. 9 to 11 each ratio is composed either of two capacities or of two

BALANCING CONDENSER

inductances. This rule is followed because a capacity and inductance will not balance each other at all frequencies although they might be made to balance for some one frequency. With increase of frequency the reactance of a capacity grows less while the reactance of an inductance grows greater.

One arm of the bridge must always be the tube capacity. Consequently at least one other arm must always be a capacity. The two remaining arms both may be capacities or both be inductances but must not be made up of mixed capacities and inductances in the two arms forming one ratio.

BALANCING CONDENSER.—See *Condenser, Balancing.*

BALLAST COIL.—See *Coil, Ballast.*

BALLAST TUBE.—See *Tube, Ballast Type.*

BAND SELECTOR.—See *Circuit, Band Selector.*

BAND, WAVE.—A series of radio frequencies or wavelengths set aside as one of the channels of transmission from stations engaged in sending out radio signals.

In the broadcasting field, wave bands are made ten kilocycles "wide." As an example one wave band extends from 795 kilocycles to 805 kilocycles. A transmitter using this wave band would send out a carrier wave at 800 kilocycles. Modulation of this carrier

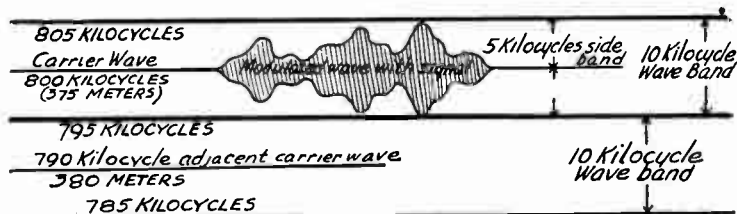

Relation of Wave Bands to Each Other.

wave would cause the side bands to extend five kilocycles on each side of the carrier, thus using the entire wave band of ten kilocycles from 795 kilocycles to 805 kilocycles.

Wave bands are not necessarily ten kilocycles wide, either a greater or less width may be used, for instance a wave band for broadcasting on 800 kilocycles might be made twenty kilocycles in width, from 790 kilocycles to 810 kilocycles. This would give a greater separation and less danger of interference between transmitters operating in adjacent wave bands or on adjacent assigned wavelengths.

See also *Broadcasting and Channels, Radio.*

BAND FILTER.—See *Filter, Band Exclusion and Band Pass.*

BANK-WOUND COIL.—See *Coil, Bank Wound.*

BASE, TUBE.—See *Tube, Bases of.*

BASKET-WOUND COIL.—See *Coil, Basket Wound.*

BASS WOOD.—See *Wood.*

B-BATTERY.—See *Battery, B-.*

B-BATTERY POWER UNIT.—See *Power Unit, Plate Voltage Types.*

BATTERY, A-.—The A-battery is the battery which provides a source of current for the filaments of the vacuum tubes used in a receiver. It is sometimes called the filament battery. A-batteries

BATTERY, B-

may be of either the storage battery or dry cell type. Storage A-batteries are often called wet batteries and dry cell types are called simply dry batteries.

A storage type of A-battery for use with five-volt, quarter-ampere tubes or for five-volt power tubes has three cells and can deliver six volts maximum pressure. A storage battery for use with three-volt tubes has two cells and can deliver four volts maximum while a storage type of A-battery for quarter-ampere tubes requiring only one and one-tenth filament volts has but a single cell and delivers a maximum of but two volts.

Storage A-batteries generally have working capacities of from sixty to one hundred ampere-hours. Batteries of greater capacity may be used to good advantage but less capacity than fifty ampere-hours will mean that the battery will require recharging at intervals too frequent for convenience.

Since the filaments of the tubes in a battery operated receiver are generally connected in parallel, the current consumption is equal to the total number of tubes times the number of amperes used by each tube. For example, a five-tube receiver using quarter-ampere tubes will draw five times one-quarter, or one and one-quarter amperes from the battery.

Dividing the number of ampere-hours capacity of the battery by the number of amperes drawn by the receiver will give the number of hours that the receiver may be operated without recharging the battery. The five-tube receiver drawing one and one-quarter amperes fitted with a one hundred ampere-hour capacity battery would operate for eighty hours provided the battery were fully charged to start with and if it were allowed to completely discharge.

See also *Battery, Storage Type* and *Battery, Dry Cell Type*.

BATTERY, B.—The B-battery is the battery which provides a voltage for the plates of the vacuum tubes in a receiver and which provides the flow of direct current in the plate circuits of the tubes. Either storage types or dry cell types of B-batteries may be employed.

Storage types or wet types of B-battery are constructed with small cells, each one of which gives two volts pressure. These cells are assembled in units or trays carrying eleven, twelve, twenty-two or twenty-four cells and giving voltages of twenty-two, twenty-four, forty-four or forty-eight for each unit. Any desired B-battery voltage may be obtained by using a sufficient number of units or cells.

Dry-cell B-batteries are made in two sizes considered from the standpoint of voltage. One size delivers twenty-two and one-half volts while the other delivers forty-five volts. The smaller voltage is secured from fifteen cells, each cell furnishing one and one-half volts, while the higher voltage is secured from thirty cells. The individual cells are of small size and are assembled into blocks with the cells completely covered with insulating compound through which terminals are brought out.

Dry-cell B-batteries are made in vertical and flat types. The vertical type in the large size measures approximately four inches in length, three inches in width and seven inches in height. A flat type of the same capacity would measure six and five-eighth inches long, four inches wide and three inches high. Whether vertical or flat type should be used depends on the space available.

The 22½-volt blocks may have only one negative terminal and one positive terminal or they may be provided with one negative terminal and several

BATTERY, C-

positive terminals or taps at the following voltages; $16\frac{1}{2}$, 18, $19\frac{1}{2}$, 21 and $22\frac{1}{2}$. The 45-volt blocks may have one negative terminal, one $22\frac{1}{2}$ -volt positive terminal and one 45-volt positive terminal or they may have one negative terminal followed by positive voltage taps of $16\frac{1}{2}$, 18, $19\frac{1}{2}$, 21 and $22\frac{1}{2}$ on the first section and a 45-volt positive tap at the end of the second section. These voltage taps are used to provide proper plate voltage on detector tubes as well as to allow variations in plate voltage on radio frequency amplifier tubes.

Dry-cell B-batteries are sometimes rated according to their capacity in milliampere-hours, or in their ability to deliver a certain number of milliamperes for a given number of hours. The normal capacities in milliampere-

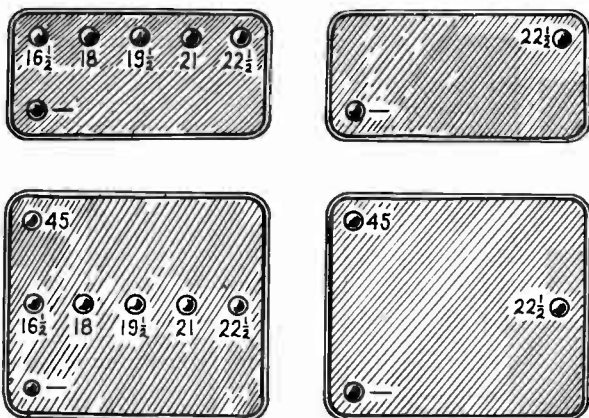

Terminal Arrangements on Dry Cell B-Batteries.

hours are 4500 for the large size, 1200 for the medium size and 450 for the small size. It is far more economical to use the large size than either of the others. The only good reason for using medium or small sizes is limitation of space. Large, medium and small sizes are sometimes called respectively, five-pound, two-pound and one-pound batteries.

See also *Battery, Storage Type*; *Battery, Dry Cell Type*; *Battery, Life of*; and *Charger, Battery, Bulb Type*.

BATTERY, C-—A battery which provides a biasing voltage for the grids of amplifying tubes. See *Bias, Grid*.

BATTERY, CARE OF.—See *Battery, Dry*; also *Battery, Storage Type*.

BATTERY, CHARGER FOR.—See *Charger, Battery*.

BATTERY, CHARGING OF.—See *Charger, Battery*.

BATTERY, CONNECTION OF A- and B-—In some receivers the negative terminal of the B-battery is connected to the positive terminal of the A-battery while in other receivers the negative terminal of the B-battery is connected to the negative terminal of the A-battery. Either method may be used with practically identical results from the receiving standpoint.

With the connection A+B— the return end of the plate circuit is through the A-battery to the negative side of the filament in the

BATTERY, DRY-CELL TYPE

tube. With the connection A—B— the return end of the plate circuit is directly to the negative side of the filament in the tube. In older receivers it was the more common practice to use the A+B— connection but in recent types the A—B— connection is generally found.

With the negative end of the B-battery or plate supply unit connected to the negative side of the A-battery or negative filament line, the voltage applied to the plate circuit is the voltage of the B-battery or plate power unit alone. With the negative end of the B-battery or plate power unit connected to the positive side of the A-battery or to the positive filament line, the plate circuit return is through both the A-battery and the B-battery or plate power unit. The voltage applied to the plate circuit is then equal to the sum of the voltages of the filament or A-battery and the voltage of the plate power unit or B-battery.

A slightly higher voltage is applied to the plate circuit when B— is connected to A+ than when B— is connected to A—. In modern receivers the addition of the filament voltage to the plate voltage makes little difference in

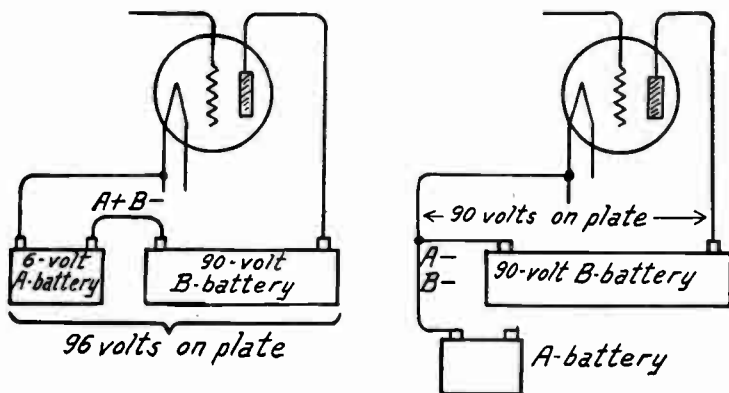

Effect on Plate Voltage of Connecting A+ and B— or of Connecting A— and B—

performance. In the case of 120-volt plate supply, adding 6 volts from the filament circuit makes only a five per cent change.

In older receivers, which used comparatively low plate voltages, the addition or subtraction of six volts made a decided change but nowadays there is no such effect.

The advantage of connecting together the two negatives is that all return circuits are then at the same negative voltage or zero voltage. The filament circuit return, the plate circuit return and the grid circuit return all come to a common negative or zero voltage point. This is considered better electrical practice than the older method.

BATTERY, DRY-CELL TYPE.—Dry-cell batteries are made up of a number of single dry cells connected with each other so that the voltage of the battery is equal to the number of cells times one and one-half, this one and one-half being the voltage of one dry cell regardless of its size.

Each cell consists of a cylinder or case of zinc inside of which is a carbon rod. There is a filling composed principally of finely pow-

BATTERY, ELECTROLYTE FOR

dered carbon and black oxide of manganese placed around the carbon rod. The zinc container is lined with porous material and the filling and the lining of the cell are saturated with liquid electrolyte. The top of the cell is tightly closed with sealing compound which prevents evaporation of the electrolyte. The carbon forms the positive element of the cell and carries the positive terminal. The zinc container forms the negative element of the cell and carries the negative terminal.

A dry cell of the size used for A-battery work will deliver one-half ampere for fifty or sixty hours of intermittent use or will deliver one-quarter ampere for about one hundred and fifty hours of intermittent use.

As far as voltage is concerned only a single dry cell is required for the operation of tubes requiring 1.1 volt for their filaments. These tubes draw one-quarter ampere of current and this is the maximum current that may be taken from a single dry cell if any reasonable length of service is to be obtained.



3 cells in parallel
 $1\frac{1}{2}$ volts



3 cells in series
 $4\frac{1}{2}$ volts

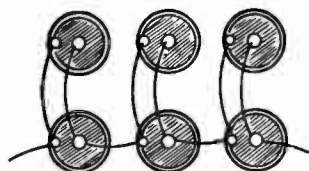

2 cells in parallel and
3 sets in series
 $4\frac{1}{2}$ volts

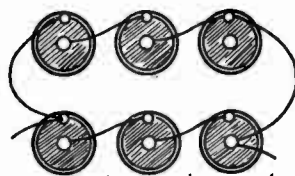

3 cells in series and
2 sets in parallel
 $4\frac{1}{2}$ volts

Dry Cell Connections for Increasing Voltage and for Increasing Allowable Current Drain.

It is much better practice to connect two or three dry cells in parallel with each other to form the A-battery supply in a receiver using 1.1 volt tubes. There should be at least one dry cell in the parallel connection for each tube in the receiver being handled.

In order to furnish current for tubes requiring three volts on their filaments two dry cells must be connected in series so that the one and one-half volt pressure is doubled. The current consumption of these tubes is only .06 ampere, so four of them may be operated in parallel and draw only 0.24 ampere which is within the current ability of a single dry cell. However, much longer life will be secured if two or more cells are connected in parallel and two of these parallel circuits connected in series to form a parallel-series arrangement as shown in the diagram.

BATTERY, ELECTROLYTE FOR.—See *Battery, Storage Type*.

BATTERY, ELIMINATORS FOR.—See *Power Unit*.

BATTERY, FILAMENT.—See *Battery, A-*.

BATTERY, GRID.—See *Bias, Grid*.

BATTERY, LIFE OF

BATTERY, LIFE OF.—The life of a storage type of A-battery operated under normal conditions and without abuse in the form of excessive discharge is from one and one-half to three years. The end of the battery's life will be indicated by its becoming discharged in a much shorter time than normal. The battery may then be taken to a battery service station and advice secured as to whether it will be economical to replace plates and separators or whether a real saving of money will be made by replacing it with a new one.

The months of life which may be expected from the three sizes of B-batteries for various plate currents in milliamperes with the receiver used for an average of two hours a day is shown in the following table at the intersection of the columns for battery size and the lines for current.

DRY CELL B-BATTERY LIFE

When Furnishing Current in Milliamperes	Months of Life		
	<i>Small</i>	<i>Medium</i>	<i>Large</i>
6	15	—	—
7	13	—	—
8	11.6	—	—
9	10.3	—	—
10	9.3	15.5	—
11	8.5	14	—
12	7.8	13	—
13	7.2	12	15.5
14	6.6	11	14.3
15	6	10.2	13.4
16	5.5	9.6	12.6
17	5	9	11.8
18	4.7	8.4	11
19	4.2	7.9	10.4
20	4	7.4	9.8
21	3.7	7	9.2
22	3.5	6.6	8.7
23	3.2	6.2	8.3
24	3	5.8	7.9
25	2.8	5.5	7.6
26	2.6	5.2	7.1
27	2.4	5	6.8
28	—	4.7	6.5
29	—	4.4	6.2
30	—	4.2	5.9
31	—	4	5.6
32	—	3.8	5.3

BATTERY, PLATE

The life of dry cell B-batteries will be prolonged by using large sizes. The large size or heavy duty type of dry B-battery should be employed with any receiver having four or more tubes or any receiver drawing fifteen milliamperes or more in its plate circuits. The medium size may be used for receivers having from one to three tubes. The small size should be used only in portable receivers where minimum size and weight are important considerations.

The life of a dry cell battery comes to an end when its voltage drops below 1.12 per cell. When the voltage of a 22½-volt block drops to 17 or when the voltage of a 45-volt block drops to 35 the battery should be replaced with a new one. Waste of current from B-batteries and a consequent short life is caused by leaving the receiver tubes lighted at any time when no programs are being received. Short life is also caused by burning the filaments too brightly, by using old and worn out tubes, by using a run down C-battery, by using leaky bypass condensers, and by allowing high resistance leaks or short circuits to exist in the receiver.

BATTERY, PLATE.—See *Battery, B*.

BATTERY, STORAGE TYPE.—Storage batteries consist of a number of cells. Each cell is made up of several positive plates and several negative plates. All of the positives are connected together and all of the negatives are connected together as in Fig. 1. The positive and negative plates alternate with each other in position and are kept apart by separators of wood, celluloid or hard rubber. The plates themselves are made of lead alloys and chemical compounds of lead. The plates and their separators are immersed in a bath of sulphuric acid diluted with water, this liquid being called the electrolyte. The electrolyte and the plates are carried in a jar made of glass, hard rubber or other insulating material.

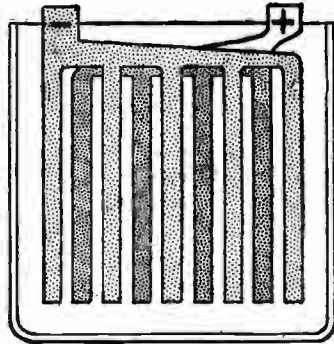

FIG. 1.—How Positive and Negative Plates Alternate in Storage Battery Cell.

One cell of a storage battery, regardless of its size, shape or construction will deliver only two volts pressure, but its ability to deliver current or amperage depends upon the size of the plates, the quantity of material in the plates and the amount of electrolyte in the cell.

A battery is made up of a sufficient number of cells to give the required voltage. The cells are connected in series with each other as in Fig. 2 so that the voltage of the battery is equal to the number of cells times two, since each cell will give two volts.

Both positive and negative plates are formed of metallic lead frames called grids. Spaces in the grids are filled with active material formed from com-

BATTERY, STORAGE TYPE

pounds of lead. After manufacture the plates are given several charges and discharges, called forming. This forming turns the active material in the positive plate to peroxide of lead which is reddish brown in color. The material in the negative plates becomes sponge lead, dull gray in color.

When the battery is connected to the receiver and the filament switch turned on an action immediately begins to take place between the plates and the electrolyte. A part of the sulphuric acid in the liquid combines with the lead in the plates to form lead sulphate, and the surfaces of both plates gradually become covered with this sulphate. The percentage of water in the electrolyte is increased because of the combining of part of the acid with the

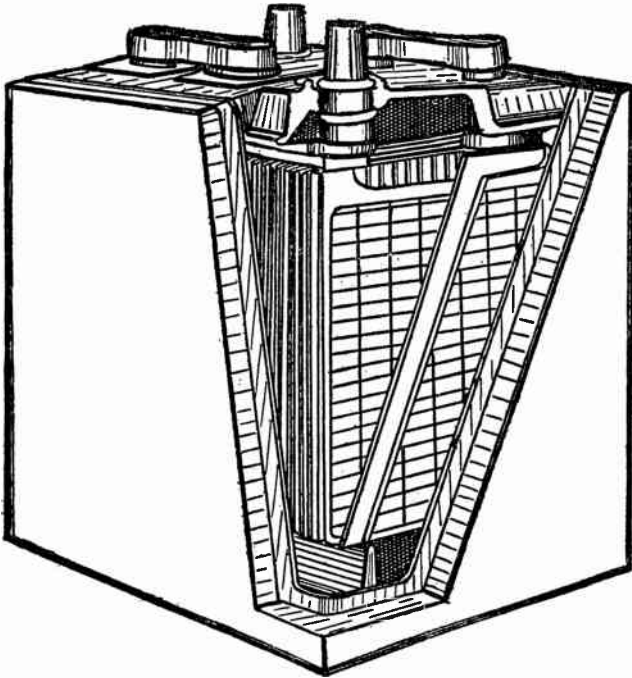

FIG. 2.—The Complete Storage Battery with Cells in Series.

lead of the plates, leaving water in the electrolyte. The surfaces of the plates thus change slowly to lead sulphate, while the liquid becomes more nearly pure water.

When the battery is recharged, the sulphate of the plates combines with part of the hydrogen and oxygen in the electrolyte to form more sulphuric acid. The positive plate then becomes peroxide of lead and the negative is left as sponge lead. This transformation continues until the sulphate is completely reduced, and the battery is then said to be charged.

The capacity or current delivering ability of a storage battery is measured in ampere-hours (see *Ampere-Hour*). The larger the plates the greater will be the ampere-hour capacity of the battery; that is, the greater the height, width and thickness of the plates the more capacity they will have.

Radio types of storage batteries generally have plates about five thirty-seconds to one-quarter of an inch in thickness. This comparatively thick

BATTERY, STORAGE TYPE

plate makes for long life and durability. The demand for current is very small in radio work so that a great number of plates is not required.

Testing Storage Batteries.—In the operation of a storage battery the discharge must not go so far that the voltage becomes abnormally low. Under no conditions should discharge be continued when the voltage drops to 1.7 volts per cell. If the current flow from the battery is continued at this voltage serious and permanent damages will result from over-sulphation of the plates.

From the explanation given of the action that takes place during charge and discharge, it will be seen that the proportion of acid in the electrolyte will give an indication of the condition of the battery,

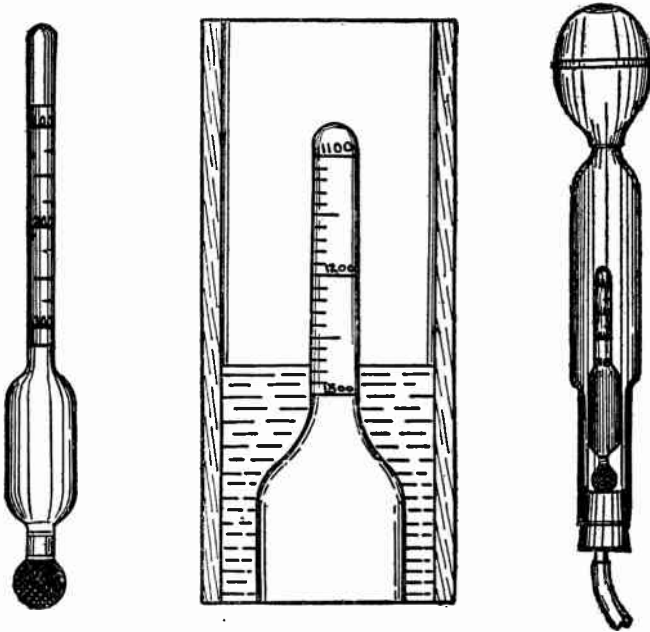

FIG. 3.—A Hydrometer, Its Scale, and a Hydrometer Syringe for Storage Battery Tests.

whether it is properly charged or nearly discharged. The acid is much heavier than water, and as the proportion of acid in the liquid becomes greater, the weight of the electrolyte becomes greater. Therefore, the heavier the electrolyte, the more nearly charged the battery is known to be.

To find the condition of the battery by testing the liquid, a hydrometer is used. The hydrometer is a glass tube having a hollow bulb with a weight at one end and a thin tube with a numbered scale at the other end. When this instrument is allowed to float in the electrolyte liquid from the battery cells, the point on the scale to which it sinks indicates the weight of the liquid. The hydrometer

BATTERY, STORAGE TYPE

will not sink so deeply into the heavy liquid having a large proportion of acid as into the lighter liquid when almost all water. The hydrometer scale is graduated according to specific gravity, which is the weight of the liquid compared to that of pure water.

On the stem of the hydrometer appear numbers from 1.100, near the top, to 1.300 near the bottom. This is shown in Fig. 3.

The hydrometer itself is usually carried in a larger tube with a small nozzle at the lower end and with a bulb at the upper end so that some of the electrolyte may be drawn from each of the cells for purposes of test. In the top of each cell of every battery is a small plug. This plug may be unscrewed or released from its lock and will leave an opening into the interior of the cell. Through this opening the electrolyte or the tops of the plates may be seen. With a plug removed, the hydrometer syringe, as the tube and bulb are called, is inserted into the cell, the bulb is squeezed and allowed to expand whereupon some of the liquid will be drawn up into the tube and the hydrometer will float in this liquid. After all pressure has been released from the bulb the specific gravity of the liquid is the reading on the hydrometer scale at the point where the instrument rises above the surface of the electrolyte. After the gravity is read the liquid should be carefully returned to the same cell from which it was drawn. The same method is used to find the specific gravity of each cell.

If this gravity is between 1.250 and 1.300, the cell is well charged. If the gravity is between 1.200 and 1.250, the cell is at least half, but not fully, charged. Gravity between 1.150 and 1.200 indicates that the cell is nearly discharged, while gravity of 1.150 or below means that the cell is discharged to a point at which no further discharge should be allowed. The gravity is often mentioned in "points," the difference between 1.200 and 1.250 being fifty points.

If the battery is in good condition, the gravity will be within twenty-five points of the same in all cells. If there is a greater difference than this it usually indicates trouble in the low cells.

Care of Storage Batteries.—It is essential that a storage battery have certain attention at regular intervals. The most important item in the care of a battery is that of adding pure water to each cell at least once a month. Water is added through the holes left with the vent plugs removed and may be easily handled by using the hydrometer syringe. A sufficient quantity of water should be placed in each cell to bring the surface of the liquid from one-quarter to one-half inch above the tops of the plates, this point being indicated in many batteries by a rim that may be seen at the bottom of the hole from which the plug was removed.

The water used for filling cells must be distilled water or else perfectly clean rain water. Tap water or water that has been kept in metal containers must never be used. Except when some of the electrolyte has been spilled from one or the cells, nothing but pure water should ever be added. In no case should undiluted sulphuric acid or strong electrolyte be used. Such work should be done only by a battery service station.

BATTERY, SWITCH FOR

Care should be used when testing not to spill electrolyte on top of the battery, as it will cause corrosion at the terminals and partial short-circuiting of the cells. The level of the liquid in the cells should not be made so high that overflow results from the gases evolved as the battery is charged.

At the time of testing or adding water to the battery the terminals should be carefully examined for looseness or breakage. No copper wires should be attached directly at the lead battery posts, as the copper will be eaten by the action of the acid. Lead covered lugs or lead covered spring clips are used for all connections at the battery itself. If the connections are found covered with corrosion or verdigris, they should be washed with ammonia or with baking soda and water and covered with a coat of vaseline to prevent further action by the acid. If the battery case is wet or if the inside of the battery compartment is wet, the moisture should be wiped away with a cloth slightly wet with ammonia water.

See also *Charger Battery*.

BATTERY, SWITCH FOR.—See *Switch, Battery or Filament*.

BATTERY, TESTING OF.—See *Battery, Dry Cell Type; Battery, Storage Type*; also *Trouble, Battery Weakness and Resistance*.

BATTERY, TUBE FOR USE WITH.—See *Tube, Filament Current Supply for*.

BATTERY, WET.—See *Battery, Storage Type*.

BEACON, RADIO.—A radio beacon is a transmitting station on or near the shore of a navigable body of water. Signals are sent out by the beacon to be picked up by ships. The navigators of such ships are able to determine their location with reference to two or more of the radio beacons from which they receive signals.

Radio beacons generally send out certain distinctive signals. These signals are sent at definite intervals like the signals from a lighthouse and the intervals of time together with the kind of signal allow the ship's navigator to tell what beacon is heard. The system is also in use whereby a ship may call a shore station which takes the ship's bearings, and at the same time has bearings taken by other shore stations. One of the shore stations then calculates the ship's position from the bearings and transmits the information to the navigator. See also *Compass, Radio*.

BEAM TRANSMISSION.—See *Transmission, Beam*.

BEAT FREQUENCY.—See *Beats, Formation of*.

BEAT FREQUENCY OSCILLATOR.—See *Oscillator, Audio Frequency*.

BEATS, FORMATION OF.—An alternating current of one frequency may be combined with another alternating current of a different frequency to produce an entirely new frequency which will be lower than either of the first two. This effect may be understood by an examination of the diagram.

The upper part represents the rise and fall of voltage in an alternating current having an assumed frequency of 500 cycles while the curves immediately below represent the rise and fall of voltage in another alternating current having a frequency of 400 cycles.

At the instant represented by the vertical line *A-A* the positive voltage of the 500 cycle frequency combines with the negative voltage of the 400 cycle frequency and, since their amplitudes are nearly

BEE SWAX

equal, the result is a very small amplitude in the new current. This new current is represented by the third curve from the top which shows the varying amplitudes of the combined currents or voltage waves.

At the instant represented by the vertical line *B-B* the negative voltage of the 500 cycle current and the negative of the 400 cycle current have combined with each other to form a much greater negative amplitude in the combined curve.

At the instant represented by the vertical line *C-C* the positive voltage peaks of the two upper frequencies have combined to form a new positive peak of much greater amplitude. Between point *A-A* and point *C-C* the voltage of the combined currents rises steadily from minimum to maximum amplitude. Then from point *C-C* to point *D-D* the combined voltage steadily falls to minimum value again.

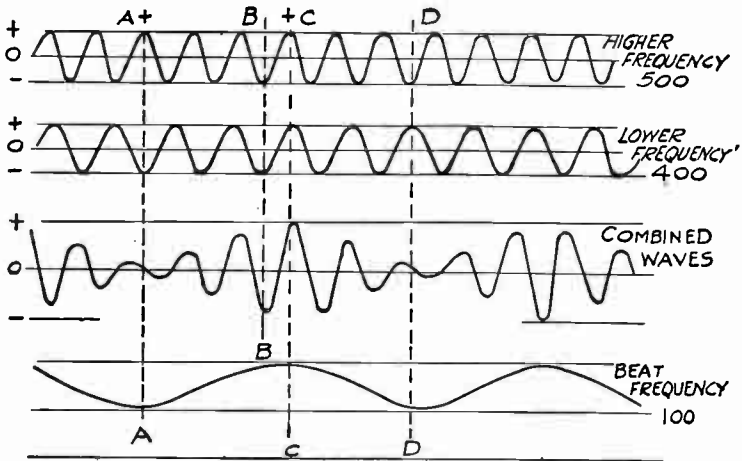

The Formation of a Beat Frequency from Two Higher Frequencies.

This repeated rise and fall in voltage or amplitude is represented by the bottom curve where it is seen that the new frequency of 100 cycles has been formed. Any two frequencies may thus be combined when introduced into the same circuit and they will give rise to a new frequency which will be equal to the difference between the two which were combined. Thus, a frequency of 300 kilocycles may be combined with one of 310 kilocycles to produce a new frequency of 10 kilocycles which is the difference between 310 and 300 kilocycles. This principle of forming a beat frequency is the foundation of the superheterodyne method of amplification.

BEE SWAX.—See *Waxes, Insulating*.

BELL WIRE.—See *Wire, Bell*.

BEZEL, PANEL

BEZEL, PANEL.—A grating, a screen or a transparent window placed in a hole through a panel so that the operation of tubes or pilot lamps back of the opening may be observed.

BIAS, GRID.—When a vacuum tube is in operation there is a voltage impressed on its filament by the A-battery and a voltage impressed on its plate by the B-battery. These are called the filament voltage and the plate voltage. But unless a C-battery or some equivalent source of voltage acts upon the grid circuit, there is no voltage impressed on the grid and the grid is said to be at zero voltage. This is the normal condition when the grid return is con-

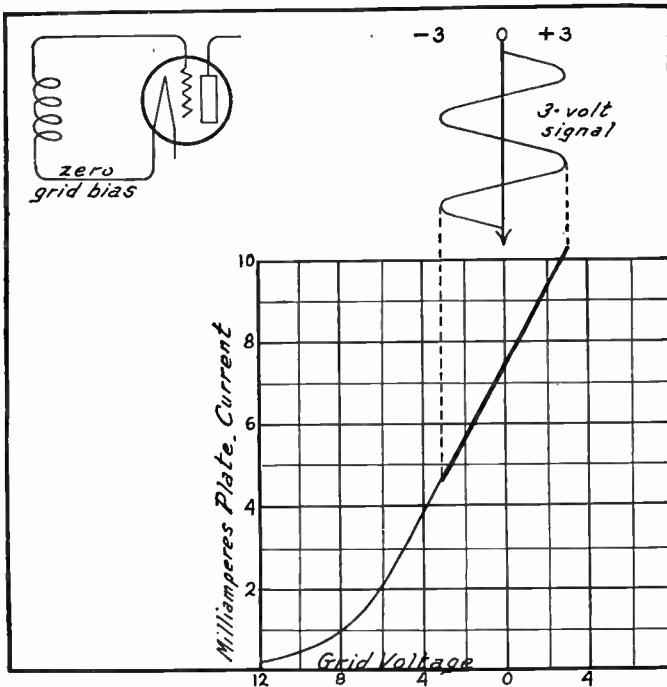

FIG. 1.—Effect of Zero Grid Bias, Distortion.

nected to the negative or "zero" filament terminal of the tube as in Fig. 1 and when no signal voltage is acting upon the grid.

If, with no incoming signal, the grid return is connected to any point at higher voltage than the voltage of the negative end of the tube filament the grid itself will be at a higher voltage or a positive voltage with reference to the negative end of the filament. The grid then is said to have a "positive bias." On the other hand, if the grid return is connected to any point at lower voltage than the voltage of the negative end of the filament the grid will be at a correspondingly lower voltage or negative voltage and is said to

BIAS, GRID

have a "negative bias." The grid itself is affected by the voltage of a point to which the grid return is connected.

Grid bias may be defined as the difference in voltage between the grid (or grid return) and the negative end of the tube filament when no signal is being handled. With negative grid bias the grid's voltage is below that of the negative filament. With positive grid bias the grid's voltage is higher than that of the negative end of the filament.

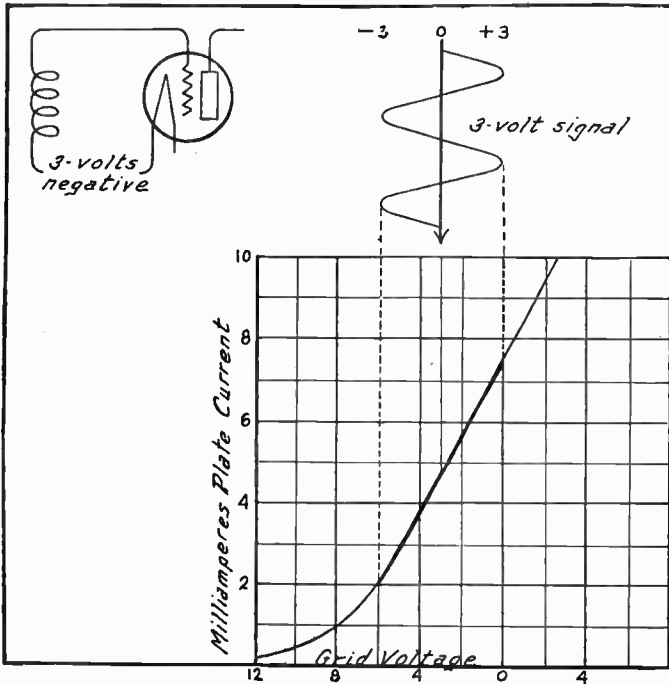

FIG. 2.—Negative Grid Bias Equal to Signal Voltage, No Distortion.

Effect on Distortion.—It should first be understood that the signal impressed on the grid consists of a series of rises and falls in voltage. Such a signal forms an alternating current with maximum and minimum voltages on opposite sides of the line representing average voltage or zero voltage. The stronger the signal, the greater will be the voltage change between minimum and maximum.

A three-volt signal is shown by the curve at the top of Figs. 1, 2 and 3. In Fig. 1 the grid is at zero voltage to start with or has a zero grid bias. The three-volt maximum peaks of the signal then cause the grid voltage to become three volts positive and the drops of voltage cause the grid voltage to become three volts negative.

BIAS, GRID

The curves at the bottom of Figs. 1, 2 and 3 show the effect of grid voltage changes on plate current in an ordinary tube. As may be seen, the higher the grid voltage the greater will be the plate current with other things remaining the same. The fluctuation of grid voltage causes a rise and fall of plate current over the heavy part of each curve in Figs. 1, 2 and 3.

In Fig. 1 with its zero grid bias to start with, the signal voltage causes the grid voltage to fluctuate between three volts negative and three volts positive.

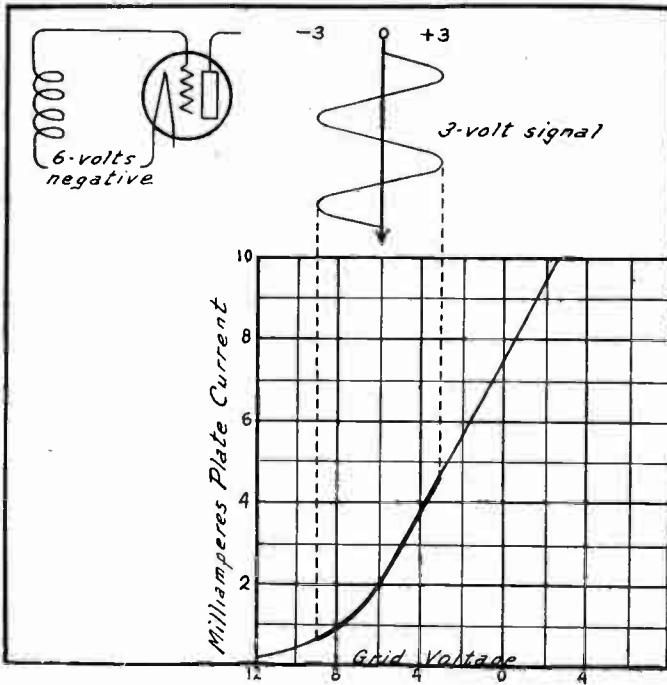

FIG. 3.—Too Much Negative Grid Bias, Distortion.

As will be explained it is very undesirable ever to allow the grid voltage to become positive in an amplifying tube. Therefore the condition shown in Fig. 1 with zero grid bias is not satisfactory.

In Fig. 2 the same three-volt signal is being impressed on a grid that has a three-volt negative bias to start with. That is, with no signal coming to the tube the grid voltage is three volts negative. Under this condition the three-volt peak of the signal just exactly overcomes the original three-volt negative bias and the grid voltage rises to zero. The three-volt drop of the signal adds its effect to the original three-volt negative bias and the grid voltage drops to six volts negative. The part of the curve being used is again shown in a heavy line.

The condition of Fig. 2 is ideal for undistorted amplification. It will be seen from the curve that the plate current varies from 2.2 milliamperes at six volts negative grid to 7.4 milliamperes with zero grid. At the middle point of

BIAS, GRID

the curve which represents the signal, or at three volts negative grid, the plate current is 4.8 milliamperes. The three volt drop in the signal causes a drop from 4.8 to 2.2 milliamperes or a change of 2.6 milliamperes. Also, the three volts rise of signal causes a rise of plate current from 4.8 to 7.4 milliamperes or a change of 2.6 milliamperes. Therefore the rise and fall of plate current is exactly proportional to the rise and fall of signal voltage and the signal is exactly reproduced by the plate current without any distortion.

Next take the case of Fig. 3 in which the grid has a six-volt negative bias to start with. The grid voltage now fluctuates from nine volts negative to three volts negative by combination of the original six-volt grid bias with the three-volt drop and the three-volt rise of the signal voltage. Once more the part of the curve being used is shown by the heavy line. Here it is seen that the bent portion of the curve is used.

Now to check the changes in plate current of Fig. 3. At the greatest drop in signal voltage the plate current drops to 0.8 milliampere. At the greatest rise in signal voltage the plate current rises to 4.6 milliamperes. At zero signal voltage, which leaves only the six-volt negative bias on the grid, the plate current is 2.2 milliamperes. The positive peaks of signal voltage cause the plate current to rise from 2.2 milliamperes to 4.6 milliamperes, a change of 2.4 milliamperes. But the drops of signal voltage cause the plate current to drop only from 2.2 to 0.8 milliampere, a total drop of only 1.4 milliamperes.

Now the three volt rise in signal voltage causes a change of 2.4 milliamperes in plate current but the corresponding three-volt drop in signal voltage causes a drop of only 1.4 milliamperes in plate current. Therefore, the even rises and falls of signal voltage are reproduced by uneven rises and falls of plate current so that the signal is not truthfully reproduced in the plate current changes. This means distortion. This distortion is due to too great a negative grid bias causing the tube to operate on the bent part of its grid voltage-plate current curve.

Effect on Signal Volume.—An examination of the curves in Figs. 1, 2 and 3 shows that the greater the negative bias on the grid the less will be the volume of signal delivered as represented by plate current from the tube. With zero grid bias in Fig. 1 the average plate current is 7.4 milliamperes; with the three-volt negative bias of Fig. 2 the average plate current drops to 4.8 milliamperes; while with the six-volt bias of Fig. 3 the average plate current has gone down to 2.2 milliamperes. The signal volume will be proportionate to these currents of 7.4, 4.8 and 2.2 milliamperes. Proper grid bias reduces the volume while improving the quality of reproduction.

Effect of Positive Bias.—It might be thought that the condition shown by Fig. 1 with no negative grid bias, would be satisfactory since operation is on the straight part of the curve and the rise and fall of plate current appears to be proportionate to the rise and fall of signal voltage. But because the grid voltage becomes positive for a part of the time there is distortion as will appear upon examination of Figs. 4 and 5.

In normal operation the flow of plate current is accompanied by a flow of electrons from the heated filament to the plate in the tube. The plate is at a positive voltage and the positive charge on the plate attracts the electrons. But there will be no flow of electrons to anything that is at zero voltage or at negative voltage.

In Fig. 4 electrons are being emitted by the hot filament and many of them get far enough away from the filament to be attracted to the plate as shown

BIAS, GRID

by the small arrows. These electrons represent the flow of plate current in the tube. Since the grid is negative it does not attract electrons which come into its vicinity on their way to the plate. As indicated by the two meters all of the current flow is in the plate circuit and none in the grid circuit.

Should the grid become positive as in Fig. 5 its positive voltage or positive charge causes it to act in the same way that the plate acts and part of the electron flow is attracted to the grid as shown by the small arrows, the balance being left for the plate circuit. Looking at the meters it will be seen that the negative grid voltage of Fig. 4 allows the whole current of eight milliamperes to flow in the plate circuit while the grid is at negative voltage. But in Fig. 5 the grid circuit has taken three milliamperes, leaving only five milliamperes for the plate circuit while the grid is at positive voltage. Such a large part of the whole current would not actually be taken by the grid circuit, but these figures serve to illustrate the point.

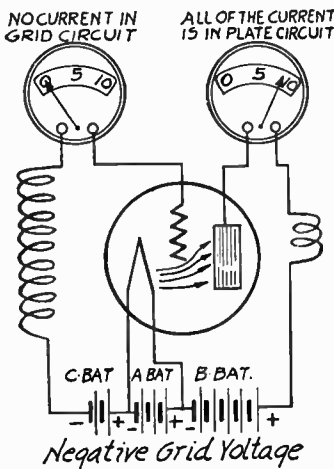

FIG. 4.—Electron Flow with Negative Grid Bias Voltage.

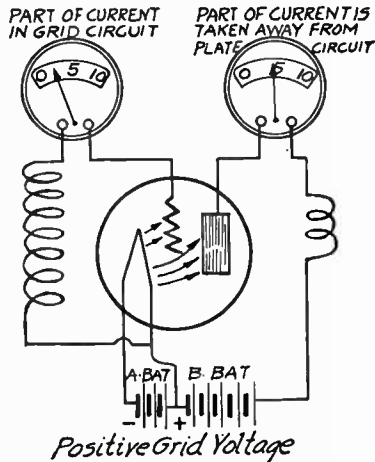

FIG. 5.—Current in Grid Circuit with Positive Bias.

Now, going back to the curve of Fig. 1; while it is true that the total change of current is the same for a given rise of signal voltage as for an equal fall of signal, a part of the total current on the positive half of the signal will not go to the plate but will be attracted to the grid circuit and subtracted from the plate circuit. Therefore, the rise of current in the plate circuit will be less than the fall of current in this circuit for equal rises and falls of signal voltage. Consequently the plate current rise and fall will not be exactly like the signal voltage rise and fall and distortion will be the result. For this reason, the grid bias voltage must be sufficiently negative so that the greatest increase of signal voltage will not cause the net grid voltage to become positive. This object is attained in Fig. 2.

Amount of Grid Bias Required.—The amount of negative voltage required for proper grid bias is determined by the voltage of the strongest signal to be handled by the tube. In Figs. 1, 2 and 3, the strongest signal is three volts which means that the signal voltage varies between a three-volt rise above average and a three-volt fall below the average. It is apparent that the negative bias of the grid must be at least equal to the greatest rise of signal voltage,

BIAS, GRID

as otherwise the positive peak of the signal voltage would cause the grid to become positive. Therefore, a three-volt signal calls for at least three volts of negative grid bias, a one-volt signal calls for not less than one volt negative bias, a ten-volt signal calls for not less than ten volts negative bias, and so on.

Determining Required Bias.—How to decide on the proper value of negative grid bias to be employed depends to a great extent on the means which are available for this work. If a curve of the tube's grid-voltage, plate current characteristic is at hand, such as the curves shown in Figs. 1, 2 and 3, it is necessary only to measure the negative grid voltage from the zero line over to where the curve starts to bend. Half of this voltage is the proper amount of negative grid bias to be used. These curves vary according to the tube being used and vary according to the plate voltage being used on the given tube.

In the curves of Figs. 1, 2 and 3 the straight part of the curve goes down as far as six volts negative where it starts to bend sharply. To avoid distortion the grid voltage must never become positive as in Fig. 1 and for this reason we use only that part of the curve on the negative side of the zero line. And also, to avoid distortion, the grid voltage must never become so far negative as to work onto the bend of the curve as in Fig. 3. So we can consider only the straight part of the curve on the negative side.

Now since this straight part of the curve must take care of both the rise and the fall of signal voltage it must take care of the sum of the positive signal voltage and the negative signal voltage. Consequently we take half of the negative grid voltage represented by the straight part of the curve to the left of zero as the proper amount of negative grid bias to employ.

From the foregoing it will be seen that any given tube with a certain plate voltage in use will handle only a certain limited signal voltage without distortion. Any greater signal voltage will either force the grid to become positive, or, if sufficient negative bias is used to prevent positive grid voltage, then the lower bend of the curve will be used as in Fig. 3 and distortion will occur here.

If a vacuum tube voltmeter is available the signal voltage may be measured directly with this meter and a negative grid bias equal to the greatest signal voltage may be used. A vacuum tube voltmeter measures the peak voltages rather than the average voltages of the signals.

A direct current milliammeter inserted in the plate circuit may be used to determine the correct negative grid bias as follows: It will be realized that distortionless amplification calls for equal rises and falls of plate current to correspond with the equal rises and falls of the signal voltage. Then the average plate current (which is the only value measured by a direct current milliammeter) must remain steady if distortion is to be avoided. If an extra strong signal causes the reading of the milliammeter to show a sudden and momentary decrease, it indicates that the strong signal voltage is forcing the grid voltage to become positive and the signal must be reduced or else more plate voltage and a greater negative grid bias applied. Sudden and momentary increases of milliammeter readings indicate that the B-battery voltage or plate voltage is too low, or that the negative grid bias is too great, or that both the plate voltage and biasing voltage are wrong. See also *Distortion*.

BIAS, GRID, METHODS OF OBTAINING

BIAS, GRID, METHODS OF OBTAINING.—Various methods of securing any desired grid bias for alternating current tubes are shown in Figs. 9 and 11 under the heading *Tube, Alternating Current Type*. Methods of securing a negative bias from plate power units are shown in Figs. 10 and 11 under the heading *Power Unit, Plate Voltage Types*. Methods requiring the use of

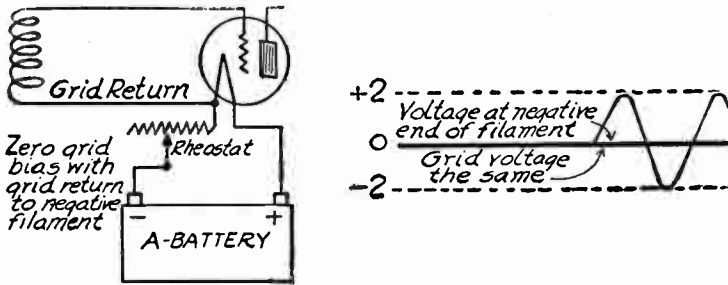

FIG. 1.—Zero Bias with Grid Return to Negative of Filament.

batteries are described here. Zero bias, with the grid return to the negative end of the filament is shown in Fig. 1.

In Fig. 2 is shown the method of obtaining grid bias that is commonly adopted when the signal voltages are small, such as in radio frequency amplifying tubes and in the first stage of audio amplification. The grid return is connected to the negative side of the fila-

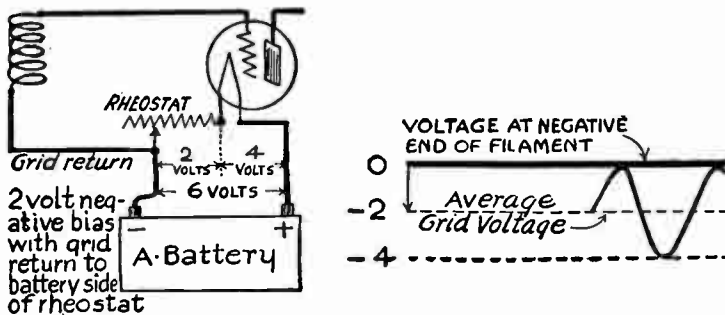

FIG. 2.—Bias with Grid Return to Battery Side of Resistor.

ment battery or A-battery, the negative end of the filament being connected to the other end of the rheostat or filament control resistor.

The total voltage difference between the negative terminal of the battery and its positive terminal is six volts. But since two volts are being used to overcome the resistance of the rheostat, the difference between the negative and positive ends of the filament is only four volts. The battery end of the rheostat, to which the grid

BIAS, GRID, METHODS OF OBTAINING

return is connected, is therefore two volts more negative than the negative end of the filament. This two-volt drop is used for negative grid bias since the voltage difference between the negative end of the filament and the grid return connection is two. At the right of Fig. 2 is shown the effect on the net grid voltage of a two-volt incoming signal which causes the grid voltage to change from zero to four volts negative.

In Fig. 3 is shown the use of a C-battery for obtaining any desired value of negative grid bias. This is one of the methods of biasing employed with audio amplifier tubes which handle strong signals or signals of great voltage. The grid return is connected to the negative terminal of the C-battery and the positive terminal of the C-battery is connected to the negative terminal of the A-battery. In Fig. 3 a three-volt C-battery is shown, but the C-battery may be of any desired voltage. Values of forty volts and more are commonly used with power amplifiers handling very strong signals.

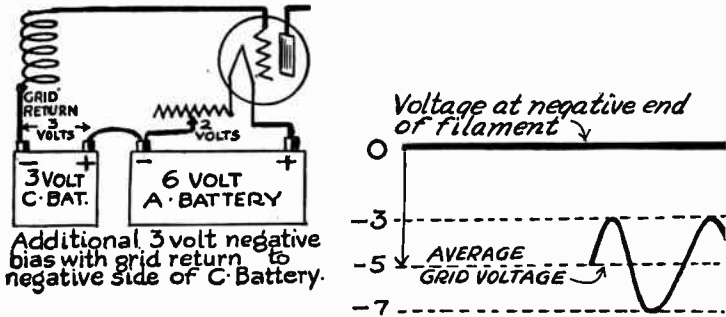

FIG. 3.—Negative Bias with C-Battery and Resistor.

With the six-volt A-battery of Fig. 3 there is a two-volt drop shown across the rheostat. Were the grid return connected to the battery end of the rheostat as in Fig. 2 we would have a two-volt negative grid bias due to the voltage drop in the rheostat. But in Fig. 3 we have added the negative voltage of the C-battery to the drop in the rheostat. Then, starting at the grid return we have three volts in the C-battery and two volts in the rheostat so that the end of the filament is at five volts higher pressure than the grid return. This makes the grid return and the grid itself five volts negative with respect to the negative end of the filament, giving five volts negative grid bias. The effect of a two-volt signal on the grid voltage is shown at the right of Fig. 3 as changing the net grid voltage from three volts negative to seven volts negative.

It will be realized that the voltage drop in the rheostat is variable and depends on the position of the rheostat arm and the amount of the total resistance being used. This means that the grid bias is of variable voltage, changing with the rheostat setting. Such a condi-

BIAS, GRID, METHODS OF OBTAINING

tion is not desirable since change of grid bias may have damaging effects on the quality of amplification. The same objection applies to the system shown in Fig. 2 or to any method utilizing the voltage drop in a variable rheostat for grid bias. A fixed filament resistor is not open to this objection.

Use of a C-battery in the grid return with a variable filament rheostat placed in the positive side of the filament circuit in place of in the negative side is shown in Fig. 4. This method provides

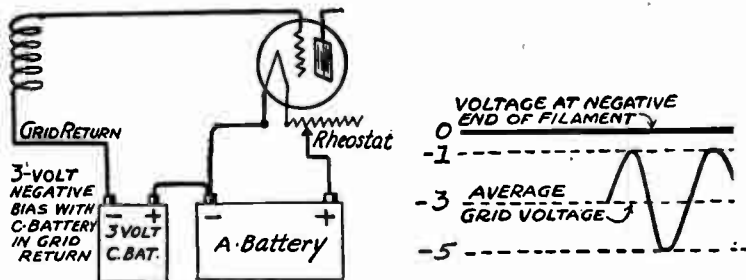

FIG. 4.—Negative Bias with C-Battery Alone.

a fixed and unvarying value of negative grid bias since the changing voltage drop in the rheostat is no longer in the grid return line. With this system the negative grid bias always remains of the same value as the voltage of the C-battery being used.

It is possible to use the voltage drop through the filament of one tube as a grid bias for the following tube in an amplifier system such as shown in Fig. 5. Two three-volt tubes have their filaments in

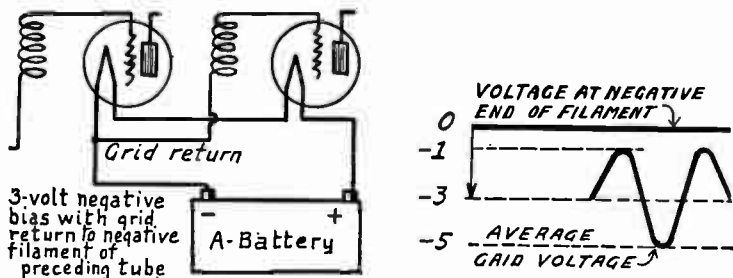

FIG. 5.—Bias from Drop of Voltage Through Tube Filament.

series across a six-volt battery. The grid return for the second or right hand tube is connected to the filament of the first or left hand tube. Thus the grid return is connected to a point of lower voltage than the negative voltage of the filament in the right hand tube and the voltage drop through the filament of the left hand tube is used as a negative grid bias for the second tube. Such a system is well adapted for amplifiers using a power supply for filament

BIAS, GRID, METHODS OF OBTAINING

current with the filaments of all tubes in series. See *Power Unit, Filament Current Types of*; also *Power Unit, Plate Voltage Types*.

Although a positive grid bias is always to be avoided with amplifier tubes, it is desired with hard tubes used for detectors. To place a positive bias on the grid it is necessary only to connect the grid return to a point of higher voltage than the negative end of the filament. Since the positive end of the filament is at a higher

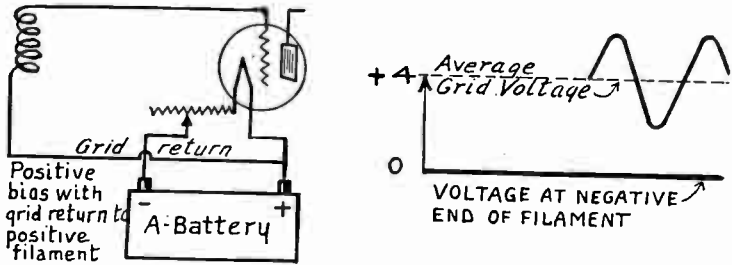

FIG. 6.—Obtaining Positive Grid Bias.

voltage than the negative end, connecting the grid return to the positive end of the filament will place a positive bias on the grid. Such a connection is shown in Fig. 6. See also *Detector, with Grid Bias*.

Variable grid biasing voltages may be obtained with potentiometers or high resistances as shown in Figs. 7 to 9. The potentiometers may be of 200 to 400

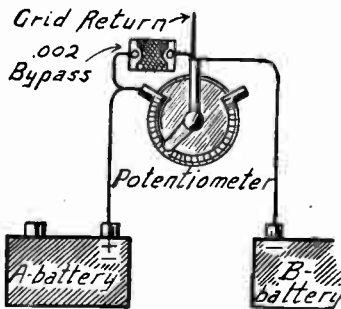

FIG. 7.—Single Biasing Voltage from Potentiometer.

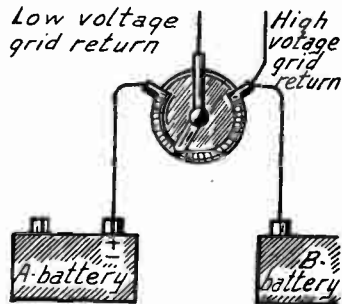

FIG. 8.—Two Biasing Voltages from Potentiometer.

ohms resistance each. They are connected between the negative terminal of the B-battery or plate power unit and either the positive or negative terminal of the A-battery or filament power unit, whichever connection may be used in the receiver.

The voltage drop through the potentiometers, which is applied to the grid circuits as a bias, is equal to the current in amperes through the plate circuit times the resistance in ohms of the part of the potentiometer being used. For example, if the plate current is ten milliamperes or 0.01 ampere and the resistance is 200 ohms, the voltage drop for grid bias will be equal to 0.01 times 200,

BIAS, NEGATIVE

or 2 volts. With 400 ohms resistance and twenty milliamperes the bias would amount to 8 volts. There is a possible objection to this system in that the biasing voltage will change with every change of current through the plate circuit. However there should be a steady average current in the plate circuit at all times since any variation means that distortion is taking place.

The connections of Fig. 7 show the arrangement for a single grid return which may, however, be for any number of tubes. In Fig. 8 two biases are available, the high voltage bias will always be equal to the plate current times the resistance in the whole potentiometer and the low voltage bias may be varied. In Fig. 9 both the high voltage bias and the low voltage bias may be varied, the high biasing voltage always being higher than the lower bias.

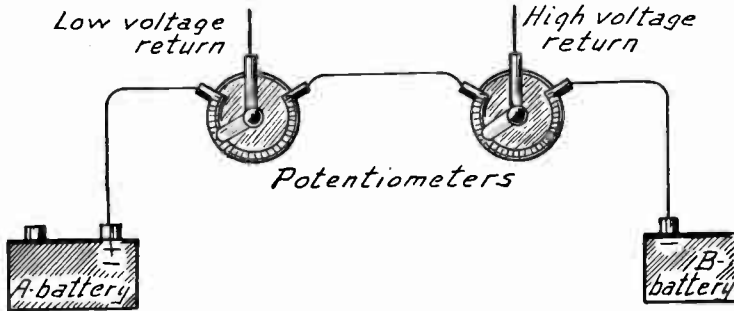

FIG. 9.—Two Variable Biases from Potentiometers.

When using any of these schemes it is advisable to connect a bypass condenser of at least .002 microfarad capacity between the grid return line at the potentiometer and the side of the potentiometer attached to the A-battery.

BIAS, NEGATIVE.—See *Bias, Grid*.

BIAS, POSITIVE.—See *Bias, Grid*.

BINDERS.—Various materials are used as coating of coils for the purpose of adding mechanical strength, of holding the wires together and in place, and of making the coils moisture proof. The most generally used binders include collodion, paraffine, shellac, insulating varnish and specially prepared cements marketed under various trade names.

While all forms of binders or cements improve a coil from the standpoint of permanence and unchanging performance, all of them likewise do more or less harm from the standpoint of electrical efficiency. The principal objection is that the binder adds a certain amount of distributed capacity to the coil and this distributed capacity causes a loss of energy. The amount of harm done is in direct proportion to the amount of binder used, therefore any cementing material should be used sparingly and spread thinly. It should be used only where really needed on the coil.

A good coil cement may be made from collodion dissolved in a mixture of one-half acetone and one-half amyl acetate. The collodion may be secured by washing the coating from photographic films in warm water. Collodion is composed of pyroxilin or gun cotton dissolved in ether and alcohol.

Collodion, paraffine wax and many of the prepared coil cements add so little distributed capacity at the frequencies used in broadcasting that the gain

BINDING POSTS

in permanence and reliability of performance is almost always of greater value than the very slight loss in efficiency. Shellac and ordinary insulating varnish cause a considerable loss in coils coated with these materials and their use should be avoided.

The effect of different binders on the effective resistance of coils used at broadcasting frequencies is shown in the curves. All of the coils are wound

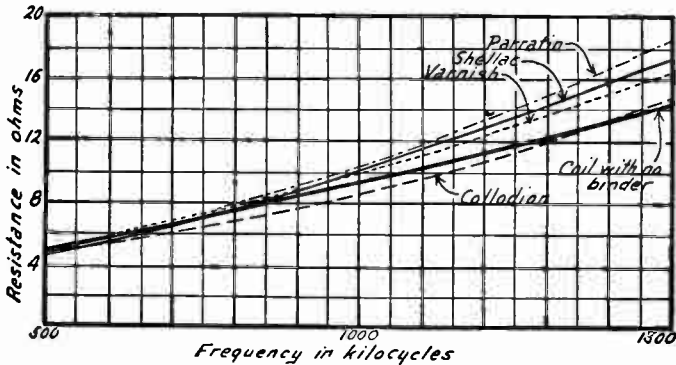

Effect of Binders on High Frequency Resistance of Coils.

with number 28 wire on hard rubber forms. It will be seen that the resistance of the coil having collodion as a binder is actually less than a similar coil with no binder of any kind. All other binders increase the resistance from twelve to twenty-two per cent at high frequencies.

BINDING POSTS.—See *Post, Binding*.

BINOCULAR COIL.—See *Coil, Closed Field Type*.

BLANKETING.—The effect of a powerful signal from a nearby station because of which a receiving set is unable to receive signals from other stations operating at frequencies near that of the blanketing station. The nearby station forces the receiving circuits to oscillate at its frequency by means of shock excitation whenever the receiving circuits are tuned to resonance. See *Selectivity*.

BLOCKING CONDENSER.—See *Condenser, Stopping*.

BLOCKING OF TUBE.—See *Tube, Blocking of*.

BLOOPER.—A radiating receiver. See *Re-radiation*.

BLUE GLOW.—See *Tube, Ionization in*.

BODY CAPACITY.—See *Capacity, Body*.

BOOK CONDENSER.—See *Condenser, Variable*.

BOOSTER.—See *Trap, Wave, Radio Frequency Type*.

BOUND CHARGE.—See *Induction, Electrostatic*.

BOX LOOP.—See *Loop, Box Type*.

BRASS.—Brass is a metal made by alloying copper and zinc in various proportions. Its electrical resistance varies with the composition. The more copper the less the resistance and the less the mechanical strength or hardness. Resistances vary from 1.1 times to 2.5 times that of copper of equal cross sectional area.

BRIDGE CIRCUIT

Various radio receiver parts are made of brass, these parts including brackets, condenser parts, tube socket parts, screws, etc. Brass may be easily soldered and it is comparatively easy to drill, thread and bend into various shapes. Brass corrodes when used near storage batteries and oxidizes slowly in the air. To prevent oxidation brass parts are often lacquered. See also *Shielding*.

BRIDGE CIRCUIT.—See *Balancing*.

BRIDGE, MEASUREMENTS BY.—Various forms of the Wheatstone bridge may be used for making quick and easy measurements of unknown resistances, inductances and capacities used in radio work. The principle of the Wheatstone bridge, or Wheatstone balance as it is sometimes called, is shown in Fig. 1. Four arms of the bridge are connected as shown in Fig. 1, the arms being designated by the letters *A*, *B*, *X* and *S*. Points *c* and *d* are connected to a battery or other source of voltage. Between points *e* and *f* is connected a sensitive galvanometer or a pair of headphones.

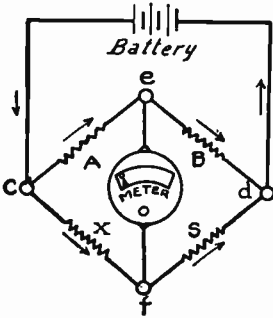

FIG. 1.—Principle of the Wheatstone Bridge.

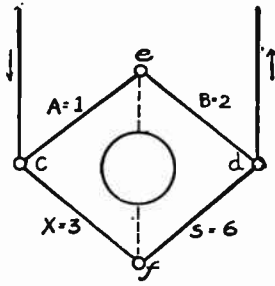

FIG. 2.—Obtaining a Balance in the Bridge.

Current flows from the battery or other source to *c*, then divides and flows by way of the two parallel paths *A-B* and *X-S* to point *d* and back to the source. If the values in the four arms are such that they conform to the proportion

$$\frac{A}{B} = \frac{X}{S}$$

then the voltage drop from *c* to *e* will be the same as the drop from *c* to *f* and points *e* and *f* will be at equal voltages. Since there is no difference between the voltage at *e* and that at *f*, there will be no flow of current through the meter or phones and the bridge is then said to be balanced.

A balanced bridge is shown in Fig. 2 where arm *A* has a value of 1, arm *B* has a value of 2, arm *X* a value of 3 and arm *S* a value of 6. Substituting these values in the above proportion or equation we have,

$$\frac{A}{B} = \frac{X}{S} \quad \text{or} \quad \frac{1}{2} = \frac{3}{6}$$

BRIDGE, MEASUREMENTS BY

Under such a condition arm *A* contains one-third the total resistance of side *A-B*, while the corresponding arm *X* contains one-third the total resistance of side *X-S*. Since the ratio is the same on both sides of the bridge, points *e* and *f* will be at the same voltage and a balance is secured.

As shown in Fig. 3, arms *A* and *B* are called the "ratio arms" since they form the first part of the proportion $A:B::X:S$. Arm *X* is formed by the unit of unknown value which is to be measured. Arm *S* is formed by a known value which may be adjusted to such a point that the bridge is balanced.

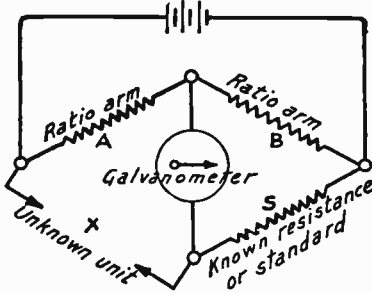

FIG. 3.—Functions of the Arms in a Bridge.

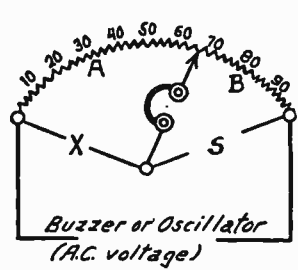

FIG. 4.—Principle of the Slide Wire Bridge.

If *S* cannot be gradually varied to secure a balance, then the ratio arms *A* and *B* are changed until the bridge is balanced.

Slide Wire Bridge.—A form of bridge in which the ratio arms *A* and *B* are continuously variable is shown in Fig. 4, this being one of the most convenient forms for radio measurements. A "slide wire bridge," made according to the principle shown in Fig. 4, is

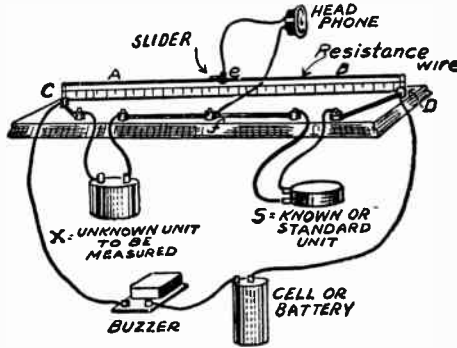

FIG. 5.—Practical Form of Slide Wire Bridge.

illustrated in Fig. 5 as actually constructed in practice. The two ratio arms are formed by a single resistance wire of uniform cross section and of any convenient length which is mounted between two posts which correspond to points *c* and *d*. A scale, such as a long ruler, is mounted directly underneath the slide wire and a slider or sliding contact which corresponds to point *e* is arranged

BRIDGE, MEASUREMENTS BY

to be moved along the wire while remaining in contact with it at all times. Arms X and S are left open for the unknown and known units respectively. Between point f and the slider or point e are connected the headphones or a galvanometer. The source of voltage and current may be a dry cell and buzzer for tests of inductance and capacity or simply a dry cell alone for resistance tests. When using only a dry cell without the buzzer a galvanometer must be used as the headphones will not give any sound.

An excellent source of voltage for making all measurements of resistance, inductance and capacity is the audio frequency oscillator described under *Oscillator, Audio Frequency*. The terminals of the oscillator are connected to points c and d of the bridge. The alternating voltage of the buzzer allows measurements of inductances and capacity which cannot be made with a battery as a source of current.

Tests made with this bridge are shown in Figs. 6, 7 and 8. Determination of the resistance of a rheostat is shown in Fig. 6. The rheostat is connected in arm X while a known fixed resistance of 60 ohms is used in arm S . The known value, whether it be resist-

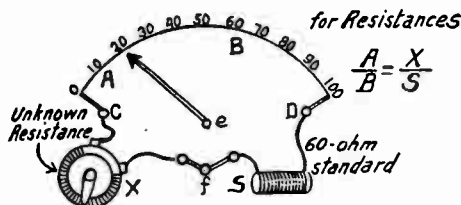

FIG. 6.—Resistance Measurement with Bridge.

ance, inductance or capacity, should be selected as somewhere near the probable value of the unknown unit. The slider is moved across the wire until the bridge is balanced, which will be indicated by the galvanometer reading becoming zero or by no sound of the buzzer or oscillator being heard in the headphones. The part of the wire at the left of the slider then forms value A of the ratio and the part of the wire at the right of the slider forms the value B of this ratio.

In Fig. 6 we find 20 parts of the wire forming value A and the remaining 80 parts forming value B . Consequently we have the ratio $20/80$ which is the same as $1/4$. This must be equal to X/S and since we know S to be 60 the second part of the proportion becomes $X/60$. Now $20/80$ equals $X/60$, which gives the value of X as 15 ohms.

Fig. 7 shows the use of the bridge for determining the value of an unknown inductance. Here we use a known inductance of 300 microhenries as arm S and when no sound of the buzzer or oscillator is heard in the phones the arm is found to rest at 40, giving 40 as the value of arm A and leaving the remaining 60 parts of the wire as the value of arm B . Then, substituting the known value of 300 microhenries as S in the proportion A/B equals X/S we have $40/60$

BROADCASTING

equals $X/300$ and solving this proportion gives the value of X , the unknown inductance, as 200 microhenries.

In Fig. 8 the bridge is being used to find the value of an unknown capacity. The unknown value condenser is connected in arm X and a known capacity of 1000 micro-microfarads is used as arm S . When no sound is heard in the phones the arm is at 66 on the wire and scale. In measuring capacity we do not use the direct ratio that was used for both resistance and inductance measure-

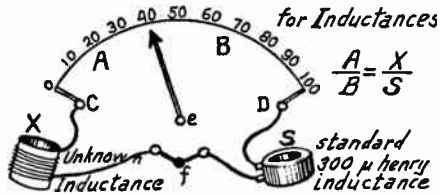

FIG. 7.—Inductance Measurement with Bridge.

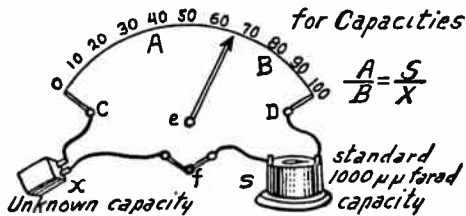

FIG. 8.—Capacity Measurement with Bridge.

ments but now use the inverse ratio, A/B equals S/X . Substituting the known values in this proportion we have $66/33$ equals $1000/X$. The fraction $66/33$ is close enough to the true values $66/34$ and is used because it forms a comparatively simple ratio equal to $2/1$. Solving this equation ($66/33$ equals $1000/X$) gives 500 micro-microfarads as the capacity of the unknown condenser.

BROADCASTING.—Public broadcasting is one class of radio communication. Broadcasting consists of radio telephone signals sent out from transmitting stations on certain frequencies which may be picked up and reproduced by any receiver within range of the broadcasting station.

Public broadcasting is done in the United States, Canada and Mexico on wavelengths between 200 and 545 meters which correspond to frequencies between 1500 and 550 kilocycles. See also *Distances, Geographical; Radiation; Channels, Radio; Modulation; and Letters, Station Call.*

BRONZE.—Bronze is a metal made by alloying copper and tin. Other metals are sometimes added to give the finished product cer-

BUCKING COIL

tain desired qualities. The electrical properties of bronze are similar to those of brass. See *Brass*.

BUCKING COIL.—See *Coil, Bucking*.

BUILDING OF RECEIVER.—See *Construction, Receiver*.

BULB TYPE CHARGER.—See *Charger, Battery, Bulb Type*.

BURIED ANTENNA.—See *Antenna, Underground*.

BURNOUTS.—See *Trouble, Burnouts*.

BUS WIRE.—See *Wire, Bus*.

BUSHING, LEAD-IN.—See *Antenna, Lead-in for*.

BUZZER.—A source of alternating or pulsating current is convenient for many uses in radio work. Some source of such current is needed while making tests of capacity of inductance with a Wheat-

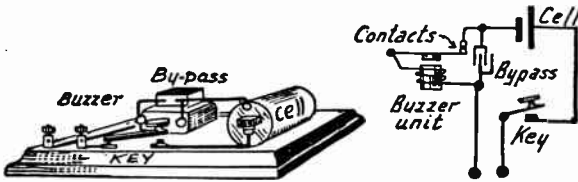

Construction and Circuit of Buzzer Exciter.

stone bridge, while adjusting crystal detectors, using frequency meters, etc. A convenient source of such energy is a buzzer and dry cell arranged as shown. The complete outfit includes a buzzer unit, a dry cell, a key and a bypass condenser. The arrangement of these parts on a board is shown at the left of the illustration while the circuit connections are shown on the right. The buzzer, the dry cell and the key are connected in series with each other. The bypass condenser is connected across the contacts of the buzzer. This outfit gives a pulsating direct current whose frequency or tone may be controlled within narrow limits by the adjustment of the buzzer armature. See also *Oscillator, Buzzer Type*.

B. W. G.—An abbreviation for Birmingham Wire Gauge.

BYPASS.—See *Condenser, Bypass; Filter; and Detector, Plate Bypass for*.

C

C.—A symbol for capacitance or electrostatic capacity. See *Capacity*.

c.—A symbol for velocity of light.

CABINET.—Cabinets for housing radio receivers are made in a number of standard sizes. Whenever possible a receiver should be arranged to fit into one of these standard sizes since this saves the expense of a special cabinet. The height, length and depth of cabinets and panels in common use are shown below.

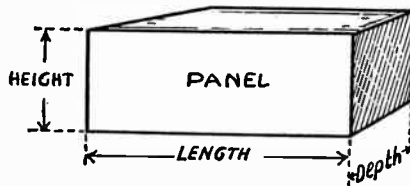

PANEL AND CABINET DIMENSIONS

Panel		Cabinet	Panel		Cabinet
<i>Height in Inches</i>	<i>Length in Inches</i>	<i>Depth in Inches</i>	<i>Height in Inches</i>	<i>Length in Inches</i>	<i>Depth in Inches</i>
6	7	7	7	24	10
6	10½	7	7	26	10
6	14	7	7	27	10
6	21	7	7	28	10
7	12	7	7	30	10
7	14	7	8	40	8
7	18	7	—	—	—
7	21	7	9	14	10
7	24	7	9	21	10
7	26	7	9	24	10
7	27	7	—	—	—
7	28	7	12	14	10
7	30	7	12	21	10

CABINET SPEAKER.—See *Speaker, Loud*.

CABLE.—See *Wire, Stranded*.

CABLING OF LEADS.—See *Wiring, Receiver*.

CAGE ANTENNA.—See *Antenna, Forms of*.

CALIBRATION, OF FREQUENCY METER.—See *Meter, Frequency*.

CALIBRATION OF OSCILLATOR

CALIBRATION, OF OSCILLATOR.—See *Oscillator, Radio Frequency, Uses of.*

CALIBRATION, OF RECEIVER.—The work of determining the dial settings at which various broadcasting stations should be heard on a receiver is called calibration of that receiver. Calibration is also spoken of as logging and a chart or list of the calibrations is called a log.

The log of a typical broadcast receiver using straight line wavelength condensers and having three dials is shown on the following page.

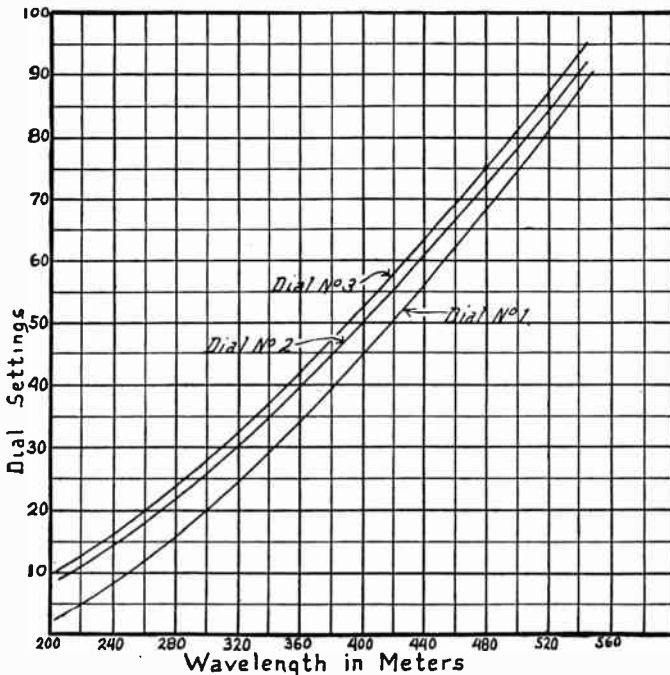

FIG. 1.—Calibration Curves for Wavelength.

It will be noticed that in the dial settings as logged three stations were missed, these being on 325.9, 422.3 and 468.5 meters. These missing stations or any others which are not logged may be found quite easily if the known settings are plotted in curves showing the relation between the dial setting and the wavelength or between the dial setting and the frequency in kilocycles.

Two such curves are shown in Figs. 1 and 2. One of them, Fig. 1, shows the calibration which by wavelength. The dial settings are written vertically at the left and the wavelengths are written horizontally at the bottom. The known settings are first marked off with points and the curves filled in as shown. The curve drawn according to wavelengths is fairly straight since the receiver contains straight line wavelength condensers. The curve drawn according to

CALIBRATION OF RECEIVER

Station Call Letters	Wavelength in Meters	Frequency in Kilocycles	Dial Settings as Logged		
			No. 1	No. 2	No. 3
WBNY	209.7	1430	3	9.5	11
WIBO	225.4	1330	5.5	11.5	13.5
WBCN	265.3	1130	12.5	19	21
WREO	285.5	1050	17	23	25
KDKA	309.1	970	22	28	30
WSAI	325.9	920	—	—	—
WLS	344.6	870	30	36	38.5
WJJD	370.2	810	37	42	44.5
WGY	379.5	790	39.5	45	47.5
WHAS	399.8	750	45	50	52.5
WLW	422.3	710	—	—	—
WMAQ	447.5	670	59	63.5	66
WRC	468.5	640	—	—	—
WOC	483.6	620	70	74	76.5
WMC	499.7	600	74.5	78.5	81
WHO	526.0	570	82	86	89
KSD	545.1	550	89	92	95

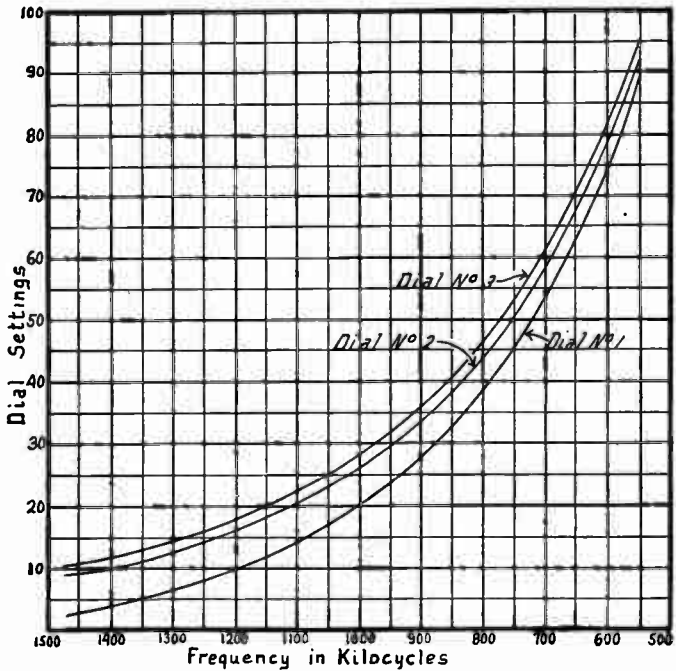

FIG. 2.—Calibration Curves for Frequency.

CAM SWITCH

frequency shows a considerable bend, illustrating the difference in tuning that might be expected between straight line wavelength and straight line frequency condensers.

Taking either set of curves it is easy to determine the approximate dial settings at which any new stations will be received. For instance, a station at 325.9 meters or 920 kilocycles should come in at dial settings of 25.5, 31.5 and 34. Similarly a station at 422.3 meters should be received at settings of 51.5, 56.5 and 59 and a station at 468.5 meters should be received with the dials set at 64, 68.5 and 71.5. These trial settings are shown in the following list.

WSAI	325.9	920	25.5	31.5	34.0
WLW	422.3	710	51.5	56.5	59.0
WRC	468.5	640	64.0	68.5	71.5

After a half dozen or more stations have been logged for any receiver it will be advantageous to make a set of curves for that receiver, since their use in determining dial settings will save a great deal of time and effort in future reception. See also *Meter, Frequency, Calibrating Receivers and Circuits with an Oscillator, Radio Frequency, Uses of.*

CAM SWITCH.—See *Switch, Cam Type.*

CAMBRIC INSULATION.—See *Cloth, Insulating.*

CAMBRIC TUBING.—See *Tubing, Insulating.*

CAPACITANCE.—Another name for capacity. See *Capacity.*

CAPACITIVE COUPLING.—See *Coupling, Capacitive.*

CAPACITIVE FEEDBACK.—See *Oscillation.*

CAPACITIVE REACTANCE.—See *Reactance.*

CAPACITY.—Capacity is the ability or power of anything to receive or to contain electricity. The capacity of a condenser or other device is the amount of electricity or the electric charge that it will receive and hold. The unit of measurement for capacity is the farad, but capacities used in radio work are so small that the practical unit in this field is the microfarad which is one millionth of a farad. A condenser which will receive and hold one coulomb of electricity when a pressure of one volt is applied to its terminals has a capacity of one farad.

A capacity effect exists between any two conductors which are at different voltages and between which there is an insulating medium or a dielectric. In radio work it is desired to concentrate or to lump all capacities in the condensers. It is not possible to do this because of the capacity effect existing between all conductors. See *Condenser, Capacity of.*

CAPACITY, ANTENNA.—See *Antenna, Capacity and Inductance of.*

CAPACITY, BODY.—There is a capacity effect between a person's body and parts of a radio receiver which are carrying high frequency currents. When any part of the body, such as the hand of the operator, is brought near a radio receiver the body capacity effect may change the tuning of the various circuits or may cause the circuits to start oscillating which results in howling and squealing.

The rotors and shafts of tuning condensers are generally connected to the negative or ground side of the tuned circuit. They are

CAPACITY, CONDENSER

at low potential and no effect is noticed when the operator's hand is drawn close to them.

Condensers used for control of feedback or for control of other high frequency currents have neither their stators nor rotors at low potential so that body capacity is very noticeable when they are being operated. This is also true of variometers used for tuning, for regeneration or for control.

The most successful method of eliminating body capacity in such cases is to avoid bringing the metal shaft of the condenser or variometer through the panel to the hand operated dial or knob. As shown in the illustration the shaft may be cut off and extended by means of a short length of hard rubber tubing placed over it with an extension shaft may be cut off and extended by the other end of the piece of tubing. This extension shaft may then be brought through the panel.

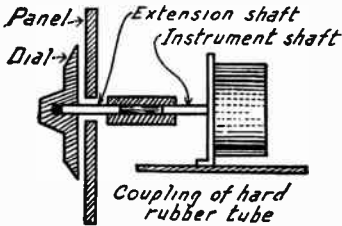

Extension Shaft for Avoiding Body Capacity Effect.

When it is necessary to bring the live shafts of variometers, feedback condensers and similar devices through a panel so that the operator's hand will come close to them the effect of body capacity may be avoided by mounting the instrument itself an inch or two back of the panel and extending its shaft through the coupling described.

CAPACITY, CONDENSER.—See *Condenser, Capacity of.*

CAPACITY, CONDENSER, MATCHING OF.—See *Oscillator, Radio Frequency, Uses of.*

CAPACITY, DISTRIBUTED.—In addition to the concentrated or lumped capacity between the plates of condensers there is

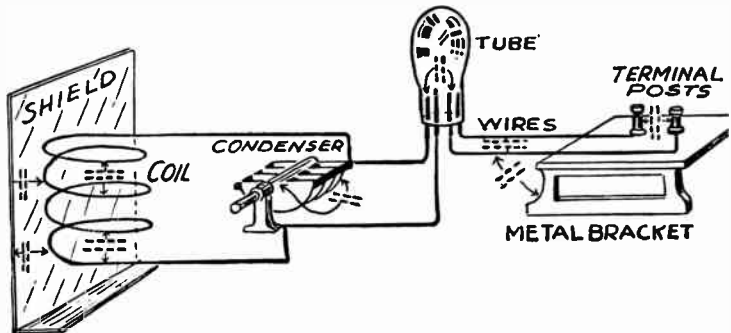

Distributed Capacities in a Receiver.

capacity between any two conductors which are at different voltages from each other. This latter capacity effect is called distributed capacity.

Distributed capacities may be found at many places in a receiver. There is a distributed capacity between a coil and any shields placed near the coil

CAPACITY, FREQUENCY EFFECT ON

and there is also distributed capacity between the turns of a coil. There is distributed capacity between the shaft and the plates of a condenser, there is distributed capacity between any two wires running near each other. This undesired capacity effect is also found between terminal posts or brackets and other parts. There is capacity between each element of a vacuum tube and all of the other elements; plate, grid and filament.

It is important in radio work, especially in designing, to think of all metal parts and all conductors as having capacity to each other so that high frequency currents can flow from one to the other. Figuring on this capacity will avoid a great deal of trouble. This distributed capacity is increased by larger surfaces, by their closeness to each other and by the voltages in the conductors and metal parts. See also *Coil, Distributed Capacity in; Transformer, Audio Frequency; and Oscillator, Radio Frequency, Uses of.*

CAPACITY, FREQUENCY EFFECT ON.—The opposition of a capacity or condenser to flow of alternating current becomes less and less as the frequency increases. This is because the capacitive reactance decreases with increase of frequency. See *Reactance.*

The actual capacity of a condenser may change with change of frequency due to the changed distribution of potential which in turn is caused by skin effect in the plates of the condenser.

CAPACITY, INTERNAL OF TUBE.—See *Tube, Capacities, Internal.*

CAPACITY, MEASUREMENT OF.—See *Bridge, Measurements by; also Meter, Frequency, Capacity and Inductance Measurements with.*

CAPACITY, RESONANCE VALUES OF.—See *Resonance, Inductance-Capacity Values for.*

CAPACITY, SPECIFIC INDUCTIVE.—Another name for dielectric constant. See *Constant, Dielectric.*

CAPACITY, STRAIGHT LINE CONDENSER FOR.—See *Condenser, Straight Line Types.*

CAPACITY, UNITS OF.—One farad is the capacity of a condenser which is given a charge of one coulomb by a potential difference of one volt across its terminals. A coulomb is the quantity of electricity that passes through a circuit in one second when the flow is one ampere.

A microfarad is the one millionth part of one farad.

A micro-microfarad is the one millionth part of a microfarad. It has been proposed that the micro-microfarad be called a picofarad.

One centimeter of capacity is equal to 1.1124 micro-microfarads. A centimeter of capacity is the centimeter-gram-second or C. G. S. electrostatic unit of capacity.

CARBON.—Carbon in its various forms includes graphite, plumbago, lamp black, bone black, coal, coke and diamonds. Carbon is a fair conductor, rods such as used for electrodes and in arc lamps having resistances in the neighborhood of 0.0015 or 0.0016 ohm per cubic inch. The resistance of the graphite form of carbon is much less, being about 0.00033 ohm per cubic inch. The resistance of a cubic inch of copper is about 0.0000065 ohm so that carbon has a resistance roughly two hundred and thirty times that of copper while graphite has a resistance about fifty times that of copper.

CARBORUNDUM DETECTOR

The resistance of carbon becomes less as its temperature rises. This is the opposite of the effect of temperature increase in metals which increase their resistance with heat. This effect is more pronounced in carbon rods than in graphite.

CARBORUNDUM DETECTOR.—See *Detector, Crystal*.

CARRIER CURRENT TELEPHONY.—See *Radio, Wired*.

CARRIER WAVE.—See *Band, Wave*; also *Radiation*.

CASCADE AMPLIFICATION.—See *Amplification, Cascade*.

CASTOR OIL.—See *Oils, Insulating*.

CAT WHISKER.—See *Detector, Crystal*.

CATHODE.—The electrode connected to the negative of a source. The filament of a vacuum tube is a cathode. See *Anode*.

CATHODE RAYS.—See *Television*.

C-BATTERY.—See *Bias, Grid*, also *Battery, C-*.

C. C. W.—An abbreviation for counter-clockwise rotation.

CELL, BATTERY.—See *Battery, Storage Type*.

CELL, PHOTOELECTRIC.—See *Television*.

CELLULOID.—Celluloid is a rather hard but flexible substance made from gun cotton and oil of camphor. It may be transparent or colored in various ways. The dielectric strength of celluloid varies from 250 to 700 volts per thousandth of an inch thickness. Its dielectric constant also varies between wide limits, running from as low as 4.0 up to 6.0.

Celluloid is very inflammable. It may be softened in hot water and bent into almost any shape.

CELORON.—See *Phenol Compounds*.

CEMENT.—See *Binders*.

CENTIGRADE THERMOMETER SCALE.—See *Temperature, Scales of*.

CENTIMETER.—See *Capacity, Units of*; also *Metric System*.

CERESIN WAX.—See *Waxes, Insulating*.

CHANGER, FREQUENCY.—By combining one frequency with another one it is possible to produce a third or a new frequency. Such a combination of two frequencies really produces two new frequencies, one of the new being equal to the difference between the original frequencies and the other new one being equal to the sum of the first two.

The new frequencies are called beat frequencies. The action by which they are produced is explained under *Beats, Formation of*. The intermediate frequency of a superheterodyne receiver is produced by beat action. The parts which work together to form the beat frequency make up a frequency changer. A frequency changer produces a locally generated frequency by means of a vacuum tube used as an oscillator and this local frequency is combined with a signal frequency to change the modulated signal to the new or the beat frequency. See *Receiver, Superheterodyne*.

CHANNELS, RADIO.—Certain definite frequencies are assigned for radio signal transmission of each class of service. The frequency ranges allowed are called channels. At the International Radio Telegraphic Conference all nations which exercise control

CHARACTERISTIC

over their radio transmission agreed to abide by assignments then outlined. The bands of frequencies included between ten kilocycles and 60,000 kilocycles, corresponding to a range between five meters and 30,000 meters wavelength, were all allotted to definite classes of service. These services include broadcasting, point to point communication, aircraft and ship traffic, other maritime services, beacons and direction finding, distress calls, amateur work, experimental work, and similar classifications. A few of the highest frequencies were not reserved. Bands for each class of service are found at several places throughout the frequency spectrum. For example, broadcasting is allowed in eight groups of frequencies in addition to the group between 550 and 1500 kilocycles.

CHARACTERISTIC.—A quality or attribute of any device showing its behavior under certain conditions of use. For instance, characteristic curves of vacuum tubes show the relation between such things as grid voltage and plate current, plate voltage and plate current, etc.

CHARACTERISTIC OF TUBE.—See *Tube, Characteristics of*.

CHARGE.—The electricity which is held in a condenser or in any other conductors having capacity is called the charge. It is measured on coulombs or similar units of electrical quantity. See *Condenser, Action of*.

CHARGE, BOUND AND FREE.—See *Induction, Electrostatic*.

CHARGE, SPACE.—See *Tube, Action of*.

CHARGER, BATTERY.—Any device used for furnishing direct or pulsating unidirectional current to a storage battery for the purpose of recharging the battery is called a battery charger. Chargers in general use are designed to do two things; first they reduce the voltage of the power supply line to a voltage suitable for battery charging work, second if operated from alternating current they rectify the alternating current received from the power line and turn it into a pulsating direct current which is suitable for storage battery charging. There are three principal types of alternating current battery chargers in use, the bulb type, the electrolytic type and the vibrating type.

Voltage Required for Charger.—The voltage delivered by any charger must be greater than the voltage of the battery to which it is connected. The charger is like a pump and the battery is like a tank. If a tank had seventy pounds pressure in it and the pump were able to deliver only eight or nine pounds pressure it is plain that the tank would discharge through the pump. It is equally true that a battery, such as a wet B-battery, which still shows seventy or eighty volts will be completely discharged if connected to a charger for A-batteries which delivers only eight or nine volts.

CHARGER, BATTERY

Many B-battery chargers are designed to charge 90-volt or 96-volt B-batteries but if such a charger is connected to a B-battery of say 120-volt size or any greater voltage than 90 to 96 the battery will be discharged in place of being charged.

A fully charged battery will show $2\frac{1}{2}$ volts pressure for each cell while the charging current is still flowing through it and the charger must deliver a voltage at least equal to $2\frac{1}{2}$ times the number of cells in the battery. As an example, a 96-volt wet B-battery has 48 cells and $2\frac{1}{2}$ times 48 is 120. A charger to handle such a battery must be capable of delivering at least 120 volts.

Most chargers are operated from house lighting circuits in which there is a pressure of only 110 volts. Unless the charger includes a transformer which increases or steps up this house current voltage, it cannot possibly do satisfactory work on a 96-volt wet B-battery. Many chargers for this work do include such step-up transformers.

Connection to Battery.—It is exceedingly important that any charger be properly connected to the battery with regard to positive and negative terminal polarity. The positive terminal of the charger must be connected to the positive terminal of the battery and the

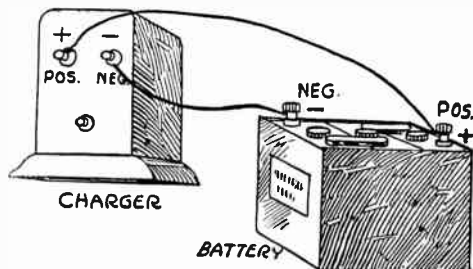

Connection of Charger to Battery.

two negatives must be connected to each other. If these connections are reversed, so that positive and negative are together, there will be a very heavy flow of current through the battery and charger in the wrong direction. If there is a fuse in the charger it will blow, otherwise the battery will be completely discharged and quite seriously damaged.

Practically all chargers may be allowed to remain connected to the battery after the power current is shut off at the house or building lines and there will be no danger of discharging the battery. Rarely a vibrating charger may stop with its contacts closed and there would be a discharge. There are very few vibrating chargers with which this could happen and with a bulb type or electrolytic type of charger there is no such danger.

Requirements and Operating Costs of Chargers.—The small ammeters attached to most battery chargers do little more than show whether the battery is charging or discharging. That is, they do not show the actual charge or discharge in amperes. This is because they are cheap instruments and are mounted on a piece of apparatus that tends to prevent them from being accurate. There is no certainty that a battery is being charged at the rate shown by one of these ammeters.

When house lighting power costs ten cents per kilowatt hour it costs from sixteen to twenty-four cents to charge a 80 ampere-hour, 6-volt battery. The

CHARGER, BATTERY, BULB TYPE

exact cost depends on efficiency of the charger and some factors which are variable.

A radio receiver will work best when the battery is fully charged. It is possible to figure out the number of hours charging required by a receiver so that the battery may be kept in prime condition. To do this proceed as follows—

First figure the current consumption of the tubes. Ordinary storage battery tubes of the 201-A type use one-quarter ampere each. The power tubes such as the 112, 371, MU-6, etc., use one-half ampere each. The 210 type of tube uses one ampere. Add the amperages of all the tubes together. For example, if a receiver has five tubes, four of them using one-quarter ampere each and the last one, a power tube, using one-half ampere, the total current will be four times one-quarter or one ampere, plus one-half ampere for the last tube, making one and one-half amperes in all.

Now multiply this current in amperes by the average number of hours the receiver is used during a week. Four hours a day totals twenty-eight hours a week. Twenty-eight times one and one-half equals forty-two and this shows that in one week's use the receiver will require forty-two ampere-hours from the storage battery.

Storage batteries are far from one hundred per cent efficient and for each four ampere-hours taken out of the battery it is necessary to put five ampere-hours of charging current through it. For safety it is better to figure on charging one-quarter more than the total discharge.

Now one-quarter of 42 ampere-hours is $10\frac{1}{2}$ ampere-hours which must be added to the original 42, making a total of $52\frac{1}{2}$ ampere-hours, of charging. If a 2-ampere charger is used, divide $52\frac{1}{2}$ by 2, which shows that the charger must be operated for $26\frac{1}{4}$ hours during the week. In this particular case the charger is operated almost as many hours as the set. With two-ampere chargers it is a safe rule to charge one hour for every hour the receiver is used. If a five-ampere charger is used it will give the battery its $52\frac{1}{2}$ ampere-hours by charging for only $10\frac{1}{2}$ hours since 5 (amperes) times $10\frac{1}{2}$ (hours) equals $52\frac{1}{2}$ ampere-hours.

Calculations have been made for one specific case but for any similar problem it is only necessary to add the number of amperes drawn by all the tubes in the set, to multiply this by the number of hours of use, and then add one-quarter to this amount (to make up for battery inefficiency). This last result is divided by the number of amperes given by the charger. The division shows how many hours the charger should be operated for the number of hours the receiver is in use.

CHARGER, BATTERY, BULB TYPE.—A bulb type of battery charger consists of a transformer connected to the supply line and a rectifying bulb of the argon type with connections made as in the diagram, Fig. 1. This particular diagram shows the use of an auto-transformer, but many of these chargers are made with a

double winding transformer as in Fig. 2. In any case the plate of the rectifying bulb is connected to the negative side of the battery to be charged, while the positive of the battery is connected to the tube filament through the transformer winding. Current for lighting the filament is taken from a part of the transformer winding or from a separate winding, depending on the transformer design.

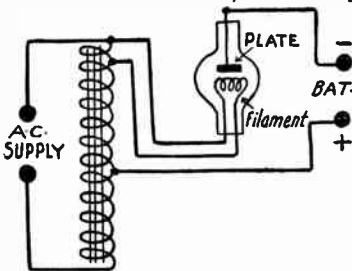

FIG. 1.—Bulb Type Battery Charger with Auto-Transformer.

CHARGER, BATTERY, BULB TYPE

Bulb types of rectifiers such as Tungar and Rectigon use a bulb in which is a coiled filament of wire and a plate or disc a little distance away from this wire filament. The filament is made of tungsten and the plate is made of graphite. The air is drawn out of these bulbs and they are filled with very pure argon gas.

Bulb chargers can be used when the voltage on the supply line remains between 90 per cent and 110 per cent of normal. That is, on a line which is supposed to carry 110 volts, such a charger will work when the actual line voltage is between 100 and 120 volts approximately. With the line voltage at 120 the charging rate would be about one-fifth greater than the nominal capacity of the charger. That is, with a 2-ampere charger the actual rate would be about 2.4 amperes. If the line voltage is ten per cent below normal the charging rate would be reduced to about one-half of its proper value.

These chargers are made in 2-ampere and 5-ampere sizes, using two different sizes of bulbs. If the battery is not larger than forty to

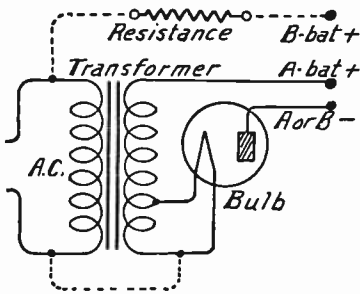

FIG. 2.—Bulb Type Battery Charger with Double Winding Transformer.

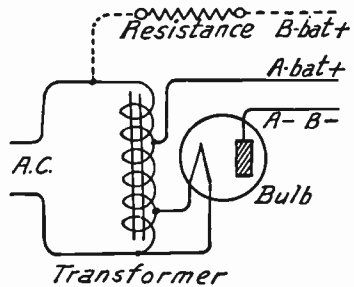

FIG. 3.—Charger with B-Battery Charging Connections.

fifty ampere-hour capacity the 2-ampere charger is large enough but for a bigger battery the 5-ampere size is more satisfactory.

Connections for charging B-batteries from bulb chargers are shown in Figs. 2 and 3. Fig. 2 shows the added connections for a double winding transformer. The original connections for A-battery charging are not disturbed. A jumper is run from one end of the primary winding to one end of the secondary winding as shown by a broken line at the bottom. From the other end of the primary winding a line, also shown broken, is carried through a resistance to the terminal for the positive side of the B-battery. This resistance will be needed when charging less than forty-two cells in a battery and for safety may be used at all times. The resistance may conveniently be an ordinary incandescent house lamp of such size that not more than one-quarter ampere of current flows through it. The same terminal of the charger that is used for the negative connection to an A-battery is used for the negative connection to the B-battery.

The B-battery charging connections for an auto-transformer are shown in Fig. 3. It is necessary to add only one extra line running from one end of the transformer winding through a resistance to the terminal for the positive side of the B-battery. Here again the resistance may be an ordinary lamp. The common negative terminal is used for either an A-battery or a B-battery on charge.

CHARGER, BATTERY, DIRECT CURRENT TYPE

The following table shows the current in amperes passed by a two-ampere bulb when used as a B-battery charger with the connections shown in Figs. 2 and 3. The current is shown for various numbers of cells in series. While values for thirty-six and for forty-eight cells are given it will be found that heating is excessive when attempting to charge batteries of such high voltages. The practical limit is reached with twenty-four cells in one series line.

B-BATTERY CHARGING CURRENT IN AMPERES

Size of Lamp Used as Resistance	Number of Battery Cells Connected in Series				
	3 cells	12 cells	24 cells	36 cells	48 cells
25-watt.....	0.09	0.08	0.06	0.05	0.03
60-watt.....	.23	.19	.15	.11	.07
75-watt.....	.30	.26	.21	.17	.12
100-watt.....	.40	.35	.28	.22	.15
No lamp.....				1.10	.60

Since the normal charging rate for a majority of storage B-batteries is one-quarter of an ampere the 75-watt or the 100-watt lamp makes a satisfactory resistance when handling twenty-four cells from 110-volt alternating current circuits with a two-ampere bulb as a rectifier.

See also *Tube, Rectifier Types of.*

CHARGER, BATTERY, DIRECT CURRENT TYPE.—

Batteries may be charged from direct current lines simply by insert-

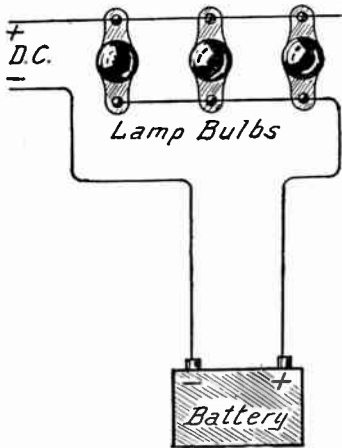

FIG. 1.—Direct Current Battery Charging with Lamp Resistance.

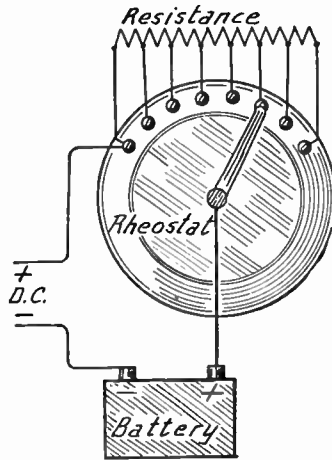

FIG. 2.—Direct Current Battery Charging with Rheostat.

ing a current limiting resistance between the line and battery. The direct current, of course, requires no rectification. Two methods are shown in Figs. 1 and 2. In Fig. 1 several incandescent lamps

CHARGER, BATTERY, ELECTROLYTIC TYPE

are connected in parallel and placed between either side of the power line and the battery. The other side of the power line runs directly to the battery. In Fig. 2 a variable rheostat is used in one side of the charging line.

Care must be used to see that the positive side of the charging line is connected to the positive terminal of the battery and that the two negatives are connected together. Fuses may be placed in the power line and an ammeter may be used to advantage in adjusting the charging rate to the proper value. The ammeter may be placed in series with either side of the line at any point.

If a rheostat is used it must have sufficient current carrying ability to avoid excessive heating and possible burnout when carrying the normal charging current. Current for A-battery charging runs from two amperes to five amperes. The maximum resistance of the rheostat for use on 110-volt power and light lines should be 110 ohms in order that the charging rate may be reduced to one ampere. The minimum resistance used should not be below twenty-two ohms so that the charging rate will not go above five amperes.

If lamps are used as in Fig. 1 the charging rate will be one ampere for each 110 watts in the lamps. For example, three lamps of 100 watts each will make a total of 300 watts through which will flow a charging current of $300/110$ or 2.72 amperes. The desired charge rate in amperes may be multiplied by 110 to find the required total wattage of all the lamps in the parallel circuit.

CHARGER, BATTERY, ELECTROLYTIC TYPE.—Electrolytic chargers or rectifiers are those which use one or more jars containing an electrolyte and two pieces of metal. There are many possible substances used as the electrolyte which is a liquid, and the electrodes which are metal pieces. One of the electrodes is

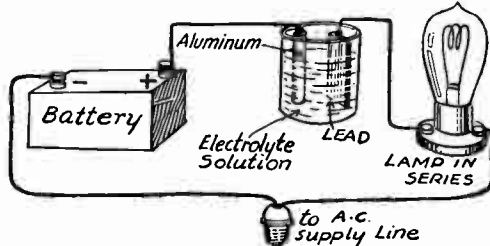

FIG. 1.—Electrolytic Battery Charging Rectifier.

usually lead or in rare cases may be carbon. The other one is aluminum or tantalum. These materials prove most satisfactory in actual use. A rectifier employing aluminum together with either lead or carbon is shown in Fig. 1.

There are several metals which, when immersed in an electrolyte, will allow electric current to flow quite freely from the electrolyte into the electrode but which offer a high resistance to current flow in the reverse direction from the metal into the electrolyte. Such metals may be used as one-way "valves" in an alternating current circuit so that alternations of only one polarity are passed.

The valve metals include aluminum, tantalum, tungsten, bismuth, magnesium and others. The other electrode has no valve action or

CHARGER, BATTERY, ELECTROLYTIC TYPE

rectifying action, being used simply as a means for getting the current into the electrolyte. This other electrode is made of any inert metal or other substance which is not acted upon by the electrolyte. Lead, carbon and iron are used for this part of the rectifier.

It is evident from the foregoing that current will flow through the battery only while the power line voltage is of one polarity and no current will flow through the battery while the power voltage is reversed. In other words, a single electrolytic cell rectifies only one-half of an alternating current wave from the power line. It is possible to use four or more cells arranged as in Figs. 2 and 3 so that both halves of the wave are rectified.

In the four-cell rectifier of Fig. 2 each end of the transformer secondary winding is connected both to an aluminum and a lead plate. Therefore, no matter which polarity the transformer winding may assume during the alternating wave, current from one end or the other will flow into the lead electrode of one of the cells, through the cell, out of the aluminum and to the battery. On the next alter-

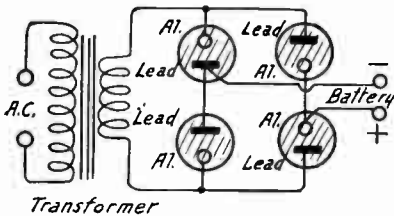

FIG. 2.—Electrolytic Battery Charging Rectifier with Transformer.

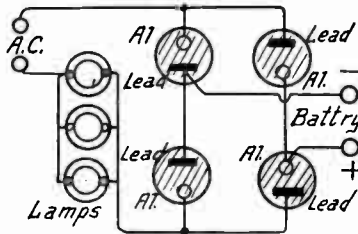

FIG. 3.—Lamp Resistance with Electrolytic Battery Charging Rectifier.

nation or half wave, current will flow into the other cell whose lead is connected to the transformer winding so that both halves of the wave will be rectified.

In Fig. 2 the electrolytic rectifier is shown connected to a transformer which reduces the line voltage to a value suited for battery charging. In Fig. 3 the transformer has been replaced by a bank of ordinary house lighting lamps whose resistance reduces the voltage for the battery. The lamps are connected in parallel and each one will pass a certain flow of current. The greater the number of lamps thus connected in parallel or the larger the lamps used, the greater will be the number of amperes passing to the battery.

It is highly important that the electrolyte liquid in these chargers be pure. The water must be pure and the material dissolved in the water must likewise be pure. Any impurities will greatly reduce the charging rate because they allow a considerable discharge or reversal of current while the power line voltage reverses. Some impurities such as chlorine, iodine or bromine will stop the charging action completely. City water is often heavily treated with chlorine, therefore should not be used. Distilled water only should be used for making these solutions.

CHARGER, BATTERY, ELECTROLYTIC TYPE

The electrolyte for rectifiers using aluminum and lead as electrodes may be made with either ammonium phosphate or ammonium borate dissolved in distilled water. Ammonium phosphate is prepared by dissolving as much primary ammonium phosphate as the water will take up, by making a saturated solution. Crystals should be added until there is an excess of the chemical that cannot be dissolved by the water. The clear solution is then poured off and is ready for use.

The ammonium borate solution may be prepared by adding three or four tablespoonfuls of boracic acid and four tablespoonfuls of clear household ammonia to a pint of distilled water. The ammonium borate solution will handle somewhat higher charging voltages than the phosphate but otherwise is not as satisfactory as the ammonium phosphate.

When the electrolyte is made with ammonium phosphate it may be allowed to stand idle for long periods and there will be no increase of internal resistance. With ammonium borate the internal resistance will increase during the idle period so that the voltage will be considerably lowered or the charger may refuse to operate until the electrodes are removed and cleaned by scraping.

When using ammonium borate solution the surface of the lead electrode is turned to lead peroxide. This compound finally drops off and forms a sediment in the bottom of the jar. Such trouble is not encountered when using ammonium phosphate.

The aluminum rod should be formed of chemically pure metal. Commercial aluminum may work satisfactorily and again it may not. Welding rods which contain small amounts of copper are not satisfactory. Impure metal causes excessive overheating. The water used in the electrolyte should always be pure distilled water.

The upper end of the aluminum rod should be protected against excessive chemical action which occurs at the surface of the liquid. The upper end of the rod may be covered with a short piece of rubber tubing slipped over the rod. The lower edge of this tubing should extend one-quarter inch below the surface of the liquid. The upper end of the aluminum rod may be covered with celluloid dissolved in acetone or with a high grade coil cement. Electrolyte jars must not be completely enclosed because it is necessary to have currents of air around them to prevent overheating.

Action of Rectifier.—With an electrolytic rectifier in normal operation the aluminum electrode may be seen to glow with a pale yellow-green light. Overloading the rectifier will cause excessive heating and will damage the elements. The temperature of the aluminum and lead type of rectifier should not go above 100 to 110 degrees Fahrenheit. To avoid overheating the rectifier it should not be used on batteries of more than twenty-two cells in a single series connection. When more cells must be charged they should be connected in parallel to provide units of not more than twenty-two cells in each section or the twenty-two cell sections may be charged one after the other.

An electrolytic rectifier made with small size electrodes and operating at low or moderate voltages gives almost complete rectification, passing the alternation of one polarity but stopping the opposite polarity with very little back current. With large electrodes or electrodes of large surface area and at high operating voltages there is a considerable flow of current backward through the circuit on the alternation which should be stopped completely.

Rectification takes place by virtue of a film which forms on the surface of the valve metal. This oxide film is an insulator and acts as a dielectric between the electrode metal and the electrolyte liquid, both of which are con-

CHARGER, BATTERY, TRICKLE TYPE

ductors. This combination forms a condenser in which the capacity increases with surface area of the electrode. This condenser passes a certain amount of current on both alternations of the cycle and the amount passed on one alternation forms a back current or reverse current. This reverse current is reduced by decreasing the area of the electrode.

The insulating film has very high resistance but if sufficient voltage be applied to the film a certain amount of current will flow through it just as with any other insulator. The voltage acting to break through the insulating film is equal to the sum of the alternating current line voltage and the voltage of the battery being charged. The higher these voltages the greater will be the back current. See also *Condenser, Electrolytic*.

Tantalum Rectifier.—The tantalum rectifier uses a strip of tantalum as the valve metal or rectifying electrode and a lead or lead peroxide element as the opposing electrode. The electrolyte is pure sulphuric acid diluted with pure water to have about the same

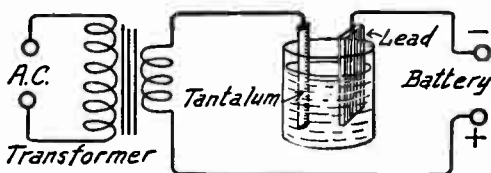

FIG. 4.—Connections of Tantalum Battery Charging Rectifier.

specific gravity as the electrolyte used in lead-acid storage batteries. The electrical losses are less in the tantalum rectifier than in the aluminum type and the life is much greater because the tantalum is acted upon but slowly by the acid electrolyte.

The connections of a tantalum rectifier are shown in Fig. 4. This rectifier employs tantalum and lead as the electrode metals and an electrolyte of sulphuric acid diluted with pure water. The tantalum rectifier is not affected by rise of temperature to such an extent as the aluminum type.

CHARGER, BATTERY, TRICKLE TYPE.—A trickle charger is a device designed to maintain an A-battery in a continual state of full charge. The charger is connected to the A-battery through a special master switch that turns on the charger by the same operation which turns off the set. Since this switch turns the set on and the charger off at one operation and turns the set off and the charger on at another single operation the battery is being charged whenever the set is not in use. Such an outfit is shown in the drawing.

Trickle chargers are designed to give a very low charging rate to the battery, generally not more than one-fourth to one-half of an ampere. This charging rate is sufficient to keep the A-battery fully charged at all times and yet is too low in amperage to harm the A-battery even though the charge continues indefinitely.

The trickle charger unit consists of a transformer for reducing the supply line voltage and a rectifier of either the bulb type or

CHARGER, BATTERY, VIBRATING TYPE

electrolytic type. Such a unit is often built into one housing with a specially designed storage battery of small ampere-hour capacity but with an extra large space for electrolyte. Such a battery will handle an ordinary receiving set because it is charged immediately after each period of discharge. The large electrolyte space makes it unnecessary to add distilled water more than five or six times a year. This connection forms an A-power supply. See *Power Unit, Filament Current Types of*.

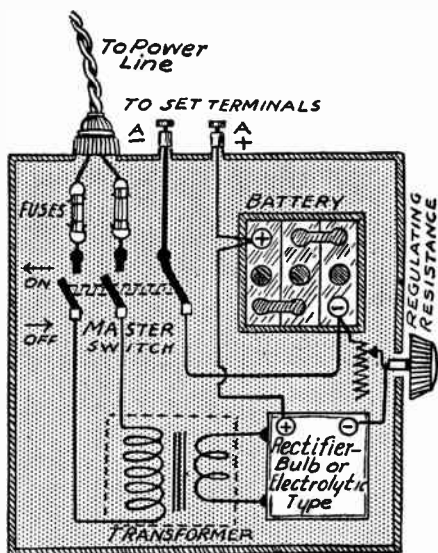

Parts and Circuits of Trickle Charger or an A-Power Unit.

Most trickle chargers are provided with a regulating resistance by means of which the charging rate may be varied to care for the requirements of the battery. This regulating resistance is usually in the form of a rheostat between the battery and the charger. This rheostat has a resistance of about twenty-five ohms and is capable of carrying a continuous current of from one-third to one-half ampere. Some types of trickle chargers use an ordinary incandescent lamp in the power supply line in place of the regulating rheostat in the battery line. Still other chargers provide one or more taps on the transformer windings, the taps being connected to a regulating switch.

The master switch may also include contacts for controlling a plate voltage supply unit. At one operation this switch then turns off the set and the plate supply while it turns on the trickle charger. See *Jacks and Switches, Uses of*.

The batteries used in complete units of the trickle charger type are generally of from thirty to fifty ampere-hour capacity, although some batteries having as low as twenty ampere-hours have been employed.

The trickle charger requires from twenty to fifty watts from the power and light line for its operation. Electrolytic types use less line current than the bulb types since the electrolytic rectifier has no bulb filament to be heated.

CHARGER, BATTERY, VIBRATING TYPE.—The construction and circuit connections of a full-wave rectifier of the

CHARGER, BATTERY, VIBRATING TYPE

vibrating type are shown in Fig. 1. The charger includes the step-down transformer shown at the top of the drawing and the rectifier mechanism shown at the bottom.

This vibrating rectifier is built in such a way that the connections of the charging line to the battery are automatically reversed with the reversal of current flow in the power line. This reversal in the rectifier is brought about by a combination of two electromagnets and a spring.

When the current flowing in the power line passes through the A. C. electromagnet in one direction this electromagnet attracts one end of the D. C. electromagnet. When the current in the power line reverses, the other end of the D. C. magnet is attracted. When the magnets are acting together they overcome the tension of the spring and close the vibrator contacts alternately so that charging current

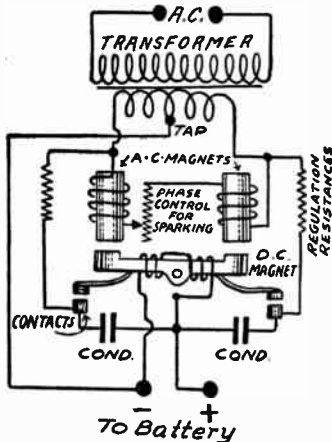

FIG. 1.—A Full-Wave Type of Vibrating Battery Charger.

flows through the battery. At the instant of reversal of current flow, the magnets balance each other and the spring opens the contacts so that a reverse current cannot flow through the battery and discharge it.

Some vibrating rectifiers have a flat spring whose tension must be adjusted so that it vibrates in step with the alternations of the power lines or supply lines. With this adjustment correctly made the spring will open the circuit at the proper time.

Other vibrating rectifiers like the one in Fig. 1 use a permanent magnet in place of a direct current electromagnet, which amounts to the same thing. This D. C. electromagnet in Fig. 1 is operated from the battery being charged. This type gives a slightly larger current to a battery that is completely discharged than to a battery that is well charged.

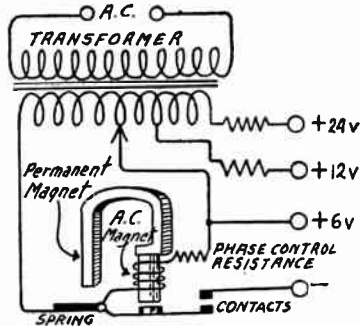

FIG. 2.—A Half-Wave Vibrating Battery Charger.

CHASSIS, RECEIVER

The rectifier shown in Fig. 2 is of the half-wave type. When the current from the supply line is of the correct polarity to charge the battery, the contacts close and the current flows to the battery. But when the supply line reverses its polarity the contacts open so that the battery cannot be discharged. On this diagram are shown taps for charging batteries of several voltages. Such taps may be arranged on any type of charger.

The spring adjustment on vibrating chargers is sometimes very critical and the least movement of the regulating screw one way or the other will start or stop the charge. Other chargers of this same type are not at all critical and are easily handled. The adjustment should be made to give the greatest possible current in amperes without making the vibrating contacts spark excessively.

Some vibrating types of chargers will not start to charge when connected to a completely discharged battery. This is because a small amount of current is taken from the battery itself for the operation of the vibrator. The only thing to do under such circumstances is to take the battery to a charging station.

As long as a vibrating rectifier is in proper working condition it may safely be left connected to the battery even when charging is not being done. For safety sake and in case of failure of the contacts to open it is always best to use some kind of switch that disconnects the charger from the battery.

The rapid opening and closing of the vibrator contacts cause sparking and the electrical effects travel for a long distance through the power line wiring. These disturbances are picked up as interference by nearby receiving sets. The interference may be minimized or completely eliminated by proper filtering as described under *Interference*.

CHASSIS, RECEIVER.—A name sometimes given to the electrical parts and internal framework of a receiver.

CHEMICAL CONDENSER.—See *Condenser, Electrolytic*.

CHEMICAL RECTIFIER.—See *Charger, Battery, Electrolytic Type*.

CHOKE, AMPLIFYING.—See *Amplifier, Audio Frequency, Impedance Coupled*.

CHOKE, AUDIO FREQUENCY.—See *Coil, Choke*.

CHOKE, COILS FOR.—See *Coil, Choke*.

CHOKE, FILTER.—See *Coil, Choke*.

CHOKE, OUTPUT.—See *Speaker, Loud, Connections to Receiver*.

CHOKE, RADIO FREQUENCY.—See *Coil, Choke*.

CIRCUIT.—A circuit is a path through which current, voltage or magnetic effects may reach and pass through all of the parts included within the circuit. In radio work circuits are composed of wires, of coils or inductances, of condensers or capacities and of resistances. See also *Law, Ohm's*.

CIRCUIT, ACCEPTOR.—A circuit consisting of an inductance or coil and a capacity or condenser in series with each other is sometimes called an acceptor circuit. Such a circuit may be tuned to resonance with a frequency and its opposition to flow of current at that frequency is at a minimum. The circuit then accepts the tuned frequency. This is a case of series resonance. See *Resonance, Series*.

CIRCUIT, ANTENNA

CIRCUIT, ANTENNA.—See *Antenna, Circuit of.*

CIRCUIT, APERIODIC.—See *Aperiodic.*

CIRCUIT, BAND SELECTOR.—A band selector consists of two tuned circuits, coupled together so that their reactance is low to an entire band of frequencies which it is desired to receive and is very high to all other frequencies.

A transmitter sending a signal on a carrier frequency of 800 kilocycles, for example, will modulate this frequency for the sending of music and speech with additional frequencies of 5,000 cycles or five kilocycles each side of 800 so that the entire band extends from 795 kilocycles to 805 kilocycles as explained under *Band, Wave*. Two such bands are indicated in Fig. 1. One is that portion of the broadcast spectrum occupied by a station operating at 800 kilocycles carrier frequency and the other is that of a station operating at 780 kilocycles. Each band occupies a width of ten kilocycles.

The response of broadly tuned and sharply tuned resonant circuits at various frequencies is shown in Fig. 2. With the broadly tuned circuit at the left,

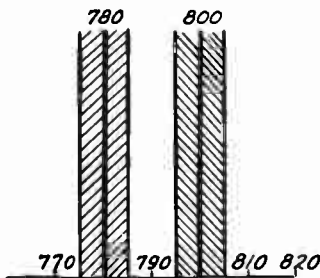

FIG. 1.—Frequency Bands.

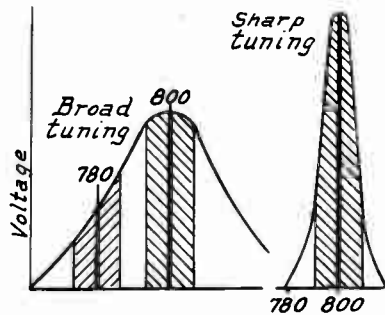

FIG. 2.—Response of Resonant Circuits

the voltage induced in the tuner is maximum for the tuned frequency, 800 kilocycles, but the response is also quite strong to frequencies as low as 775 kilocycles. Signals from another transmitter operating on the 780 kilocycle band will represent a considerable percentage of the signals received by such a broadly tuned circuit, the proportion of the wanted and unwanted signals being roughly indicated by the shaded portions of the frequency bands.

At the right hand side of Fig. 2 is shown the voltage response of a sharply tuned resonant circuit at a frequency of 800 kilocycles. It is seen that the response is only to the desired frequency with no interference from the unwanted signal on 780 kilocycles. From the standpoint of selectivity the sharply tuned circuit is satisfactory but from the standpoint of tone quality it is unsatisfactory. The voltage response peak of the sharply tuned circuit is so narrow that it does not take in the side bands which carry the audio frequency modulations. Only the lower audio frequencies, those lying close to the carrier frequency, are fully reproduced. The higher audio frequencies, which are the farthest above and below the carrier frequency, are not well reproduced by the sharply tuned circuit. From the left hand part of Fig. 2 it is apparent that the broadly tuned circuit gives satisfactory response to all the audio frequencies in the entire band.

CIRCUIT, BAND SELECTOR

A fairly satisfactory response to the entire audio frequency range, together with satisfactory selectivity, may be secured through the use of a number of successive broadly tuned stages of radio frequency amplification, by the use of the successive tuned intermediate stages in a superheterodyne receiver, or by the use of a band selector circuit in connection with a radio frequency amplifier.

One of the simplest band selector circuits depends upon a principle long known in radio, the principle that two coupled circuits, each separately tuned to the same frequency, will respond to two frequencies one of which is above and the other below the original tuned frequency. The application of this idea is shown in Fig. 3. In the plate circuit of the first tube is a resonant circuit including the tuning condenser $C1$ and the coil $L1$. The plate circuit is completed through the bypass condenser $C3$ and the direct plate current for the tube is supplied through the choke. In the grid circuit of the second tube is another resonant circuit including tuning con-

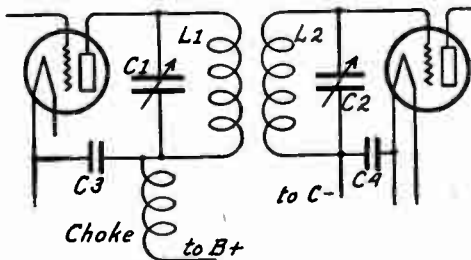

FIG. 3.—Band Selector with Tuned Plate and Tuned Grid Circuits.

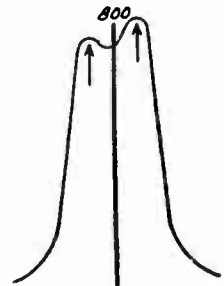

FIG. 4.—Double Resonance Peak.

denser $C2$ and the coil $L2$. The grid circuit is completed through bypass condenser $C4$.

The two resonant circuits are tuned to the same frequency, that of the carrier which it is desired to receive. The response curve, shown in Fig. 4, consists of two peaks slightly separated from each other so that quite uniform amplification is secured over a whole band of frequencies rather than over only a narrow peak as at the right in Fig. 2. Each circuit alone must be capable of producing a sharply peaked response, therefore the construction must include coils and condensers having the lowest possible resistance at radio frequencies. The coils and condensers are matched so that they tune alike with the two condensers operated from one control. The separation of the two peaks is determined by the frequency being received and by the degree of coupling between the circuits. See *Coupling, Coefficient of*.

As shown in Fig. 5, the closer the coupling the farther apart are the two peaks and the greater is the dip between them. This produces a receiver in which the response is less when tuned exactly to the desired frequency than when tuned slightly above or below that frequency. As shown in Fig. 6, the response curve is much broader at high frequencies or low wavelengths than at low frequencies or high wavelengths. Therefore the selectivity is better at the low frequencies.

CIRCUIT, BAND SELECTOR

In Fig. 7 is shown the principle of the Vreeland selector in which the two tuned circuits are coupled through a mutual inductance consisting of a third coil rather than by electromagnetic coupling between the two tuned coils as in Fig. 3. The resonant circuit in the plate circuit of the first tube consists of tuning condenser $C1$, coil $L1$ and coil $L3$. The resonant circuit for the grid circuit of the second

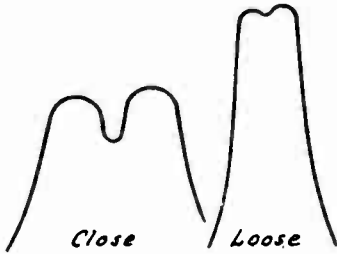

FIG. 5.—Peaks Secured with Changes in Coupling.

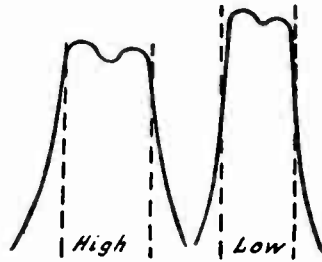

FIG. 6.—Effect of Frequency on Resonance Peaks.

tube consists of tuning condenser $C2$, coil $L2$, and coil $L3$. Coupling is by means of the coil $L3$. Bypass condensers complete the plate circuit, the grid circuit and the resonant circuits. In general, the action of this system is like that of the one first described.

In the two circuits so far described, the band selector feature is combined with the radio frequency amplifying circuits. In a third

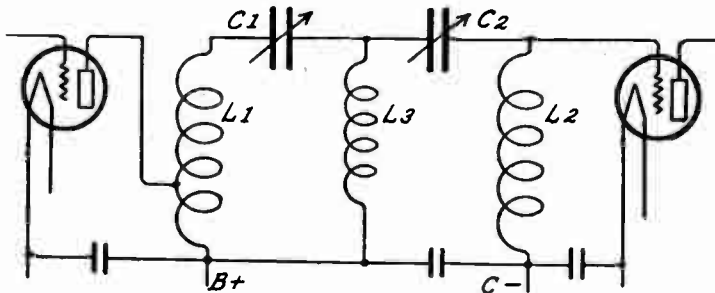

FIG. 7.—Circuit Arrangement of Vreeland Band Selector.

design, the Jones or Technidyne system, the band selector circuit is separate from and precedes the radio frequency amplifier, being placed between the antenna and the amplifier. The amplifier may then be of the untuned type.

In Fig. 8 are shown two tuned circuits; one including coil $L1$ and condenser $C1$ the other including coil $L2$ and condenser $C2$. The circuits are coupled together by the coil M , which is common to both and which forms

CIRCUIT, BAND SELECTOR

an inductance mutual to both tuned circuits. The two tuned circuits are made resonant at exactly the same frequency or are tuned exactly together. Were these circuits uncoupled, each would respond to a narrow band of frequencies and the bands would be alike as at the right hand side of Fig. 2.

When these two tuned circuits are coupled through the mutual inductance, they will respond well at a frequency slightly below the original one and at a frequency slightly higher than the original tuned frequency. The combined response is then like that shown in Fig. 4. The comparatively steep sides of the individual sharply tuned circuits have been retained, thus giving good selectivity because of slight response to frequencies outside the selected band. The top of the combined curve is now broad enough so that the entire frequency band with all the audio modulation is reproduced very well. In actual practice, a signal enters the band selector through circuit *I* of Fig. 8 which might be connected to an antenna, and leaves the selector through circuit *O*, which might lead to the grid of the first amplifying tube.

The selectivity of this circuit depends on the sharpness of tuning in the two tuned portions because sharp tuning preserves the steepness of the sides of the response curves. Sharpness of tuning depends on the use of high grade and carefully constructed parts throughout, on the reduction of high frequency resistance and on correct shielding of the circuits.

The broadness of the response depends on the degree of coupling used between the two tuned circuits, the closer the coupling the broader the response

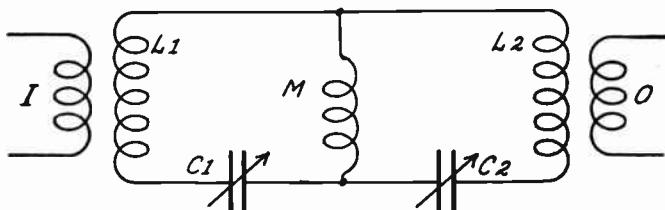

FIG. 8.—Mutual Coupling with Coil in Two Tuned Circuits.

curve. The width of the response curve depends also on the frequency being received, the curve being broader at high frequencies and narrower at low frequencies.

When using a coil for mutual inductance and coupling, the smaller the coil the smaller will be the coupling and the narrower the top of the response curve. Varying the number of turns in the coil or otherwise varying its inductance will make a corresponding variation in the width of the response.

The degree of coupling is determined by the amount of common reactance. The larger a coil, the greater will be its reactance at a given frequency.

When used with tuning coils of sizes generally employed for broadcast work, the coupling coil *M* need have only about one and one-half microhenries inductance, four to six turns of wire on a one inch diameter form being about right. The reactance of such a coil at 800 kilocycles would be approximately seven and one-half ohms.

A band selector circuit as used ahead of the first radio frequency amplifying tube is shown in Fig. 9. The antenna circuit passes through an adjustable condenser *Ca* which adjusts the natural frequency or the capacity of the antenna. The remainder of the antenna circuit includes the tuned circuit *L1-C1* in which the coil couples to coil *L2* of the band selector. Coil *L2* of the selector is

CIRCUIT, BAND SELECTOR

tuned with adjustable condenser $C2$. The coupling coil is marked M , and couples the first circuit of the selector to the second circuit consisting of coil $L3$ and tuning condenser $C3$. This second circuit is coupled to coil $L4$ which, in turn, is tuned with adjustable condenser $C4$ to form a resonant circuit connected to the grid of the first amplifying tube. The broken lines indicate shields. The antenna circuit and the first tuned circuit of the selector are enclosed

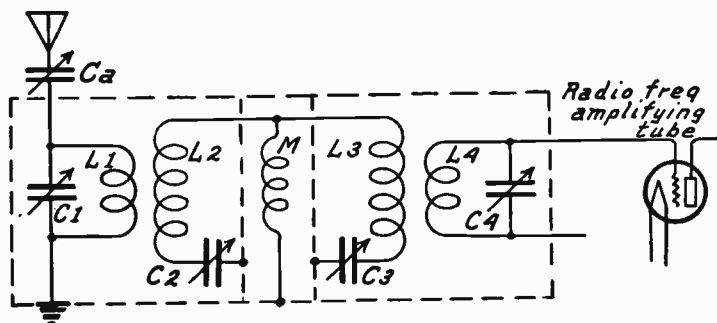

FIG. 9.—Circuit of Jones Pre-selector.

in one shield, the coupling coil in a second shield and the remaining two tuned circuits in a third shield. The first shield, for the antenna circuit, is sometimes omitted.

Capacitive coupling instead of inductive coupling may be used as shown in Fig. 10. This circuit should be compared with that shown in Fig. 8. Here the capacity M is common or mutual to both tuned circuits. The degree of coupling is changed by changing the capacity of condenser M . Increasing the condenser reactance by making its capacity smaller will increase the coup-

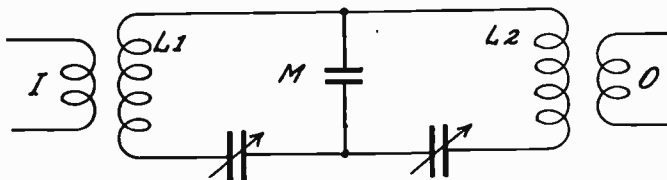

FIG. 10.—Mutual Coupling with Condenser.

ling and cause the response curve to become broader. The opposite effect is secured with a greater capacity and smaller reactance.

The reactance of a coupling coil increases with increase of frequency while the reactance of a coupling condenser decreases with increase of frequency. Therefore, the tendency of a coupling coil is to make broader tuning at high frequencies and the tendency of a coupling condenser is to make broader tuning at low frequencies. Since the lower frequencies naturally tune more sharply than the high frequencies, the effect of using a condenser for coupling is to compensate for the frequency effect with more uniform width of response curve for all frequencies.

CIRCUIT, BRIDGE

Additional information on tuned amplifiers will be found under *Amplifier, Radio Frequency, Tuned Transformer Coupled*.

CIRCUIT, BRIDGE.—See *Balancing*.

CIRCUIT, CLOSED ELECTRIC.—Any circuit that is complete and through which either direct or alternating current may flow when voltage is applied is called a closed circuit. Should any part of the circuit be open so that current or voltage cannot pass through that part there is an open circuit at the point which prevents current or voltage from passing. All useful circuits in radio work are of the closed type, and all of the examples shown in illustrations and drawings are of the closed type.

Circuits may be closed through batteries, rheostats, condensers, inductance coils, tube filaments or even through the space between the plate and filament of a tube. See also *Law, Ohm's*.

CIRCUIT, FILAMENT.—The filament circuit of a vacuum tube includes all of the parts through which the filament heating current passes. As shown in the diagram the filament circuit includes the A-battery or power supply unit, the filament itself, the rheostat or filament control resistor and all of the wires and conductors which connect these parts.

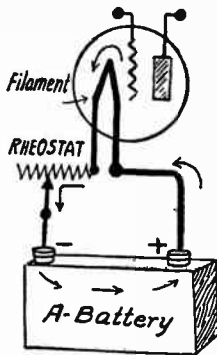

A Filament Circuit.

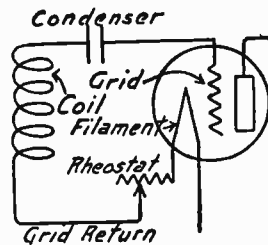

A Grid Circuit.

CIRCUIT, GRID.—The grid circuit of a vacuum tube includes all of the parts through which act voltage changes applied to the grid or through which grid current may flow when conditions are favorable to such a flow of current. The parts of a typical grid circuit are shown in the diagram. They include the grid itself, a condenser which might be a detector grid condenser or a blocking condenser, an inductance coil, the grid return connection, the filament rheostat if the rheostat is in the grid return circuit and all of the wires and conductors connecting these parts with each other. See also *Return, Grid and Detector, with Grid Condenser and Leak*.

CIRCUIT, HIGH AND LOW POTENTIAL SIDES OF.
—Any closed circuit consists of two parts, one called the high po-

CIRCUIT, LINK

tential or high voltage and the other called the low potential or low voltage side. The high voltage side of any circuit starts at the high voltage terminal of the unit through which voltage is introduced into the circuit and continues to the current consuming or voltage reducing device in the circuit. The low potential or low voltage side of the same circuit extends from the current consuming or voltage reducing device back to the low voltage or negative side of the unit at which voltage is introduced.

For example, in a filament circuit the high potential side extends from the positive terminal of the battery to the tube filament. The low potential side extends from the filament to the negative terminal of the battery. In a grid circuit the coil is the source of voltage, the high potential side of the circuit extends from the coil to the grid of the tube while the low potential side extends from the other end of the coil through the grid return, the rheostat and to the filament of the tube.

In a plate circuit the B-battery is the source of voltage and the high potential side extends from the B-battery through the coil to the plate of the tube, the low potential side extending from the negative side of the B-battery to the filament.

The greatest care should be used in handling and placing the high potential sides of all circuits. One instance is found in the rule that grid and plate connections must be carefully placed and kept well separated.

CIRCUIT, LINK.—A link circuit provides electromagnetic coupling between two parts which in themselves would have little or no coupling without the link in action. A link circuit is shown in

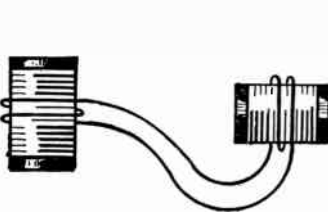

FIG. 1.—Link Circuit with Fixed Coupling.

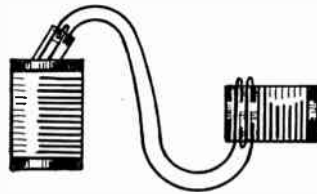

FIG. 2.—Link Circuit with Variable Coupling.

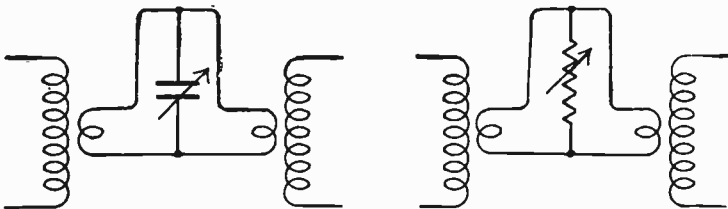

FIG. 3.—Variable Units in Shunt with Link Circuits.

Fig. 1. The two large coils are placed in a non-inductive relation to each other so that they have zero coupling. The link circuit consists of two turns of wire around each coil with the link turns joined through long conductors.

CIRCUIT, MAGNETIC

Link circuits are of great usefulness in providing a readily adjustable and controllable coupling of low value between two other circuits. The link circuit may contain only inductance in the form of windings or turns of wire and the resistance of the wire. It need contain no condenser and is not tuned in itself.

The coupling of the link circuit to either of the other circuits may be adjustable as in Fig. 2. Changing the coupling of either part of the link circuit to the unit with which it is used will change the coupling between the two larger parts or units.

The degree of coupling allowed through a link circuit may be changed by placing a variable condenser or a variable resistance across the two sides of the link circuit as in Fig. 3. Similar results in change of coupling may be

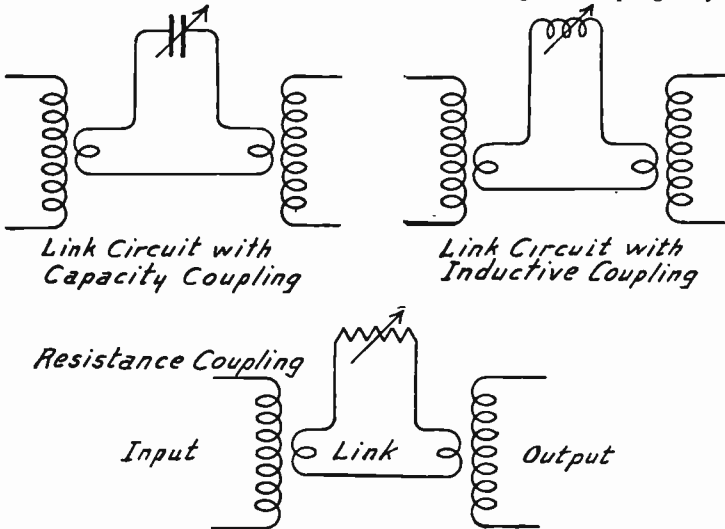

FIG. 4.—Link Circuits with Adjustable Couplings.

secured by inserting a variable condenser, resistance or inductance in one line as in Fig. 4. Any of these will change the impedance of the link. See *Regeneration, Methods of Obtaining*.

Link circuits are employed in antenna systems to provide coupling with the tuned circuits or the detector circuit of a receiver. They are also employed in working with frequency meters and wavemeters when but little coupling and sharp tuning are required.

CIRCUIT, MAGNETIC.—A magnetic circuit is formed by the path in which magnetic lines of force pass through a magnet or a coil and through the field of the magnet or coil. In the illustration is an iron-core transformer, the path of the magnetic lines of force which form the magnetic circuit being indicated by the arrows. At the right is shown, by arrows, the path or circuit of the magnetic lines of force through and around an air-core coil.

CIRCUIT, OPEN.—Any circuit which is not complete is called an open circuit. See *Trouble, Circuit, Open, Location of*; also see *Circuit, Closed Electric*.

CIRCUIT, OSCILLATORY

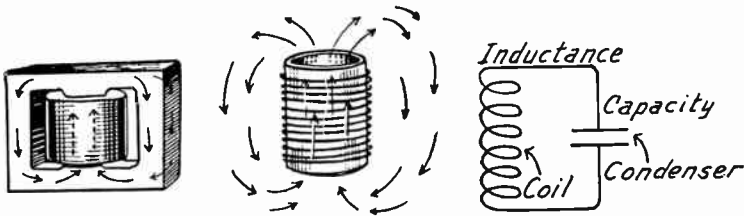

Magnetic Circuits in Iron Core and in Air Core.

An Oscillatory Circuit.

CIRCUIT, OSCILLATORY.—A circuit in which electricity may surge back and forth at high frequency between an inductance and a capacity as shown in the diagram is an oscillatory circuit or an oscillating circuit. Such circuits consist of inductances or coils connected to capacities generally formed by condensers. These circuits also contain resistance which is either inserted intentionally or is unavoidable. See *Oscillation*; also *Radio, Principles of*.

CIRCUIT, OUTPUT AND INPUT.—An input circuit is a circuit through which electric energy, voltage or current enters any electrical device. An output circuit is a circuit through which electric energy leaves the device. Input and output circuits are shown in the diagram. At the left is a transformer whose primary wind-

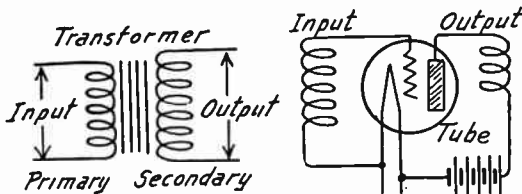

Input and Output Circuits.

ing forms its input circuit and whose secondary winding forms its output circuit. At the right is shown a vacuum tube whose grid circuit forms the input circuit of the tube and whose plate circuit forms its output circuit.

CIRCUIT, PARALLEL.—Several electrical parts so connected with one another that current from a common source divides between them, part flowing through each, are said to be in parallel with one another or to form a parallel circuit. Such a connection is shown in Fig. 1. The three coils, *A*, *B* and *C*, are connected in parallel with one another and with the battery. Part of the total current leaving the battery passes through each of the three coils and the currents having passed through the coils come together again and flow back to the battery. In Fig. 2 are shown three vacuum tubes with their filament circuits in parallel. With a parallel con-

CIRCUIT, PLATE

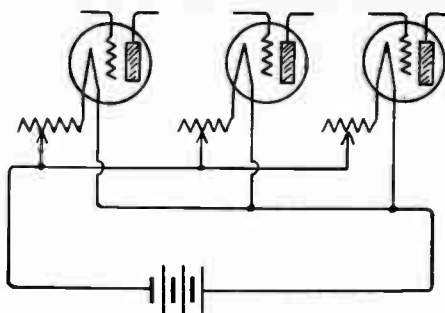
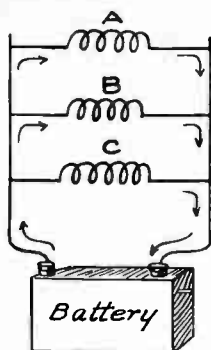
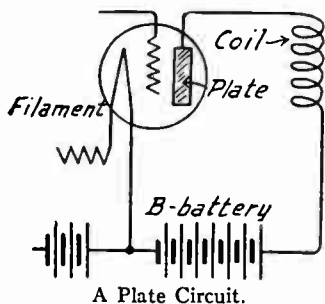

FIG. 1.—Parallel Circuits. FIG. 2.—Tube Filaments in Parallel Circuit.

nection one side of each unit is attached to one side of the source while the other sides of all the units are connected to the other side of the source. Parallel circuits are also called multiple circuits or shunt circuits. See also *Resistance, Parallel Circuit*.

CIRCUIT, PLATE.—All of the parts and conductors through which flow the plate current of a vacuum tube form the plate circuit of that tube. The plate circuit includes the plate itself, any inductance, capacity or resistance connected to the plate, the B-battery or power supply unit, the connection between the B-battery and the tube's filament, and the space between the filament and plate inside the tube. The electron flow between filament and plate passes through parts of this circuit.



CIRCUIT, PRIMARY.—An input circuit. See *Circuit, Output and Input*.

CIRCUIT, REJECTOR.—A circuit formed by an inductance or coil and a capacity or condenser connected in parallel with each other is sometimes called a rejector circuit. With the inductance and capacity tuned to resonance at a certain frequency they have the greatest possible impedance or opposition to flow of current at that frequency, hence are said to reject that particular frequency. A rejector circuit is a circuit containing parallel resonance. See *Resonance, Parallel*.

CIRCUIT, RESONANT.—See *Resonance*.

CIRCUIT, SECONDARY.—An output circuit. See *Circuit, Output and Input*.

CIRCUIT, SERIES.—A series circuit is a circuit in which all of the parts are connected end to end so that all electric current

CIRCUIT, SHORT

passing through any one part must also pass through all other parts in the series circuit. A series connection is shown in Fig. 1. The coils A, B and C are connected in series with the battery. All current leaving the battery must flow first through coil A, then through

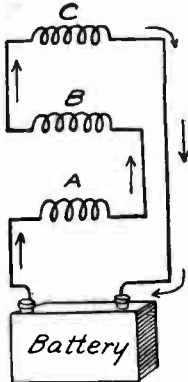

FIG. 1.—A Series Circuit.

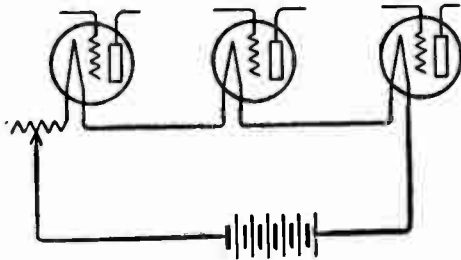
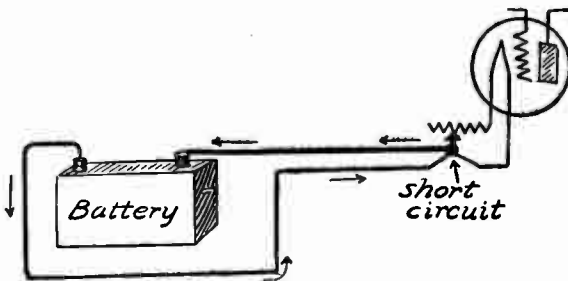

FIG. 2.—Tube Filaments in Series Circuit.

coil B and finally through coil C before it can return to the battery. In Fig. 2 are shown three vacuum tubes with their filaments in series. See also *Resistance, Series Circuit*.

CIRCUIT, SHORT.—An accidental connection between the two sides of a circuit so that current from the source may return to the source without passing through the energy consuming devices in the circuit. The diagram shows a short circuit in the wiring between a battery and the filament of a tube. The two wires from the battery are short circuited on each other at the rheostat so that battery current flows through this short circuit and back to the bat-



A Short Circuit.

tery without passing through the filament of the tube. A short circuit prevents operation of the device affected and at the same time puts a heavy drain upon the source of current. See also *Trouble, Circuit, Short, Location of*.

CIRCUIT, SHUNT

CIRCUIT, SHUNT.—A parallel circuit. See *Circuit, Parallel*.

CIRCULAR MIL.—See *Mil, Circular*.

CLAMP, GROUND.—A device designed to clamp securely around a pipe or rod and to make a permanent electrical connection of low resistance. To the ground clamp is bolted or soldered one end of the ground wire from a receiver, the receiver ground being secured through the part to which the clamp is fastened.

CLARIFIER.—A name sometimes applied to various forms of wave traps. See *Trap, Wave*.

CLEAT.—A fastening by means of which a wire or conductor is attached to and supported from some solid part. Cleats may be made from insulating material such as fibre, porcelain, moulded insulation or glass. They may also be made of insulated metal.

CLOSE COUPLING.—See *Coupling, Close*.

CLOSED CIRCUIT.—See *Circuit, Closed Electric*.

CLOSED CIRCUIT JACK.—A jack through which a circuit is normally closed. See *Jacks and Jack Switches, Types of*.

CLOTH, INSULATING.—Cotton, silk and linen are used as insulating coverings in electrical work. Cotton and silk are made into wire insulation, their characteristics for this work being given under *Wire, Cotton Covered* and *Wire, Silk Covered*.

Varnished muslin or varnished cambric are made from cotton and linen treated with oils to increase their resistance. Their dielectric strength is from 500 to 1000 volts per thousandth of an inch and their dielectric constant is from 3.0 to 5.0. Oiled cloths, such as Empire cloth, are of the same general character.

CM.—An abbreviation for centimeters of length.

COCKADAY RECEIVER.—See *Receiver, Four Circuit*; also *Tuner*.

CODE.—A system of signals used for communication in radio or wire telegraphy is called a code. The International Morse Code is used in radio telegraphy. It is different from the American Morse code which is used in wire telegraphy. The code is formed by various combinations of dots and dashes which represent letters, numerals, marks of punctuation and various phrases and short sentences commonly employed. The dash is of longer duration than the dot, being equal in length to three dots. A space or interval equal in length of time to one dot is allowed between parts of the same letter. That is, between two dots, between two dashes or between any dash and dot a space would be allowed equal in length to one dot. At the end of each letter in a word a space or interval of time equal in length to three dots is allowed before commencing the next letter. At the end of each word the space is equal in length to five dots.

Following the list of signals is a list of abbreviations which were authorized by the International Radiotelegraphic Convention. It will be noticed that all of these abbreviations start with the letter Q, and by reference to the list of call letters under the heading, *Letters, Station Call*, it will be found that the letter Q is not used as the first letter of any station's call.

CODE

THE INTERNATIONAL MORSE CODE AND CONVENTIONAL SIGNALS

A	• —
B	— • • •
C	— • — •
D	— • •
E	•
F	• • — •
G	— • — •
H	• • • •
I	• •
J	• — — —
K	— • • —
L	• — • •
M	— —
N	— •
O	— — —
P	• — — •
Q	— — — —
R	• — • •
S	• • •
T	—
U	• • —
V	• • • —
W	• — — —
X	— • • •
Y	— — — —
Z	— — • •
Ä (German)	• — • —
Å or Ä (Spanish-Scandinavian)	• — • —
CH (German-Spanish)	— — — —
É (French)	• • — • •
Ñ (Spanish)	— — • — —
Ö (German)	— — — •
Û (German)	• — — —
1	• — — — —
2	• • — — —
3	• • • — —
4	• • • • —
5	• • • • •
6	— • • • •
7	— — • • •
8	— — — • •
9	— — — — •
0	— — — — —

Period	• • • •
Semicolon	— • — — •
Comma	• — • — —
Colon	— — — • •
Interrogation	• • — — •
Exclamation point	— — • • — —
Apostrophe	• — — — — •
Hyphen	— • • • • —
Bar indicating fraction	— • • — •
Parenthesis	— • — — — •
Inverted commas	• — • • — •
Underline	• • — — • •
Double dash	— • • • —
Distress Call (S.O.S.)	• • • — — — • • •
Attention call to precede every transmission	• — — • •
General inquiry call (C.Q.)	— • — • — — — —
From (de)	— • • •
Invitation to transmit (go ahead) (K)	• — • —
Warning—high power	— — • • • — —
Question (please repeat after . . .)—interrupting long messages	• • — — • •
Wait	• — • • •
Break (Bk.) (double dash)	— • • • —
Understand	• • • — •
Error	• • • • • •
Received (O.K.) (R)	• — • •
Position report (to precede all position messages)	— • • • •
End of each message (cross)	• — — — •
Transmission finished (end of work) (conclusion of correspondence)	• • • — — —

COEFFICIENT OF AMPLIFICATION

COEFFICIENT OF AMPLIFICATION.—See *Amplification*; also *Tube, Amplification of*.

COEFFICIENT OF COUPLING.—See *Coupling, Coefficient of*.

COIL.—The subject of inductance coils for use in radio work is one of the most important. All radio circuits are composed principally of inductance found in coils, of capacity found in condensers, and of resistance in the conductors. Therefore, the three principal things in any radio receiver are the coils, the condensers, the resistances and, of course, the tubes.

COIL, AIR-CORE.—For work in the high frequency or radio frequency portions of receivers the inductance coils are generally built with no core in the center and are called air-core coils. It is not customary to use iron or other magnetic material in the cores of coils which are operating at high radio frequencies such as received on the antenna because of the magnetic lag and other energy losses that would be introduced into the circuits by the magnetic and electric properties of the iron.

COIL, ANGLE OF MOUNTING.—The air-core transformers or coils in a radio frequency amplifier should be mounted to have the least possible coupling with each other.

In order to reduce this coupling as nearly as possible to zero two coils may be placed with their axes at right angles as in Fig. 1. The magnetic lines of force which form the field of one coil then cut through the wires of the second coil at right angles so that all the lines passing through one side of the second coil pass also through

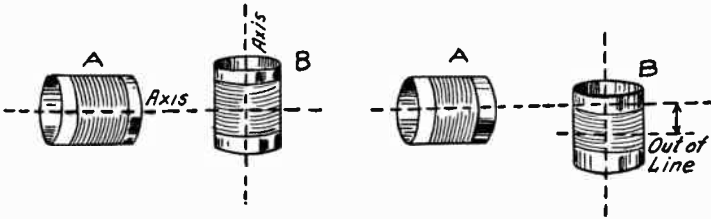

FIG. 1.—Coils with Axes at Right Angles.

its other side. Since the wires forming the two sides of each turn in this second coil run in opposite directions the effect of any lines of force passing through both sides is to set up a voltage in one side of each turn. The voltage on one side of any turn is neutralized by the equal and opposite voltage set up in the other side of the same turn.

It is important that a line continued from the axis of one coil pass exactly through the center of the axis of the other coil and also through the center of the length of the winding on the other coil as at the left in Fig. 1. The two coils shown at the right of Fig. 1 have their axes at right angles to each other yet the center line of

COIL, ANGLE OF MOUNTING

coil *A* does not pass through the center of the length of the winding on coil *B*. Therefore there is a considerable magnetic coupling between the two.

In Fig. 2 are shown top, front and side views of two coils so placed in relation to each other that they have the least possible magnetic coupling. These three views show the points to be observed in placing coils. The first point is that the center lines of

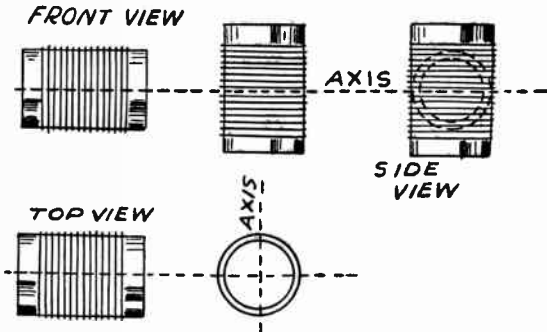

Fig. 2.—Coils Properly Aligned for Minimum Coupling Angle.

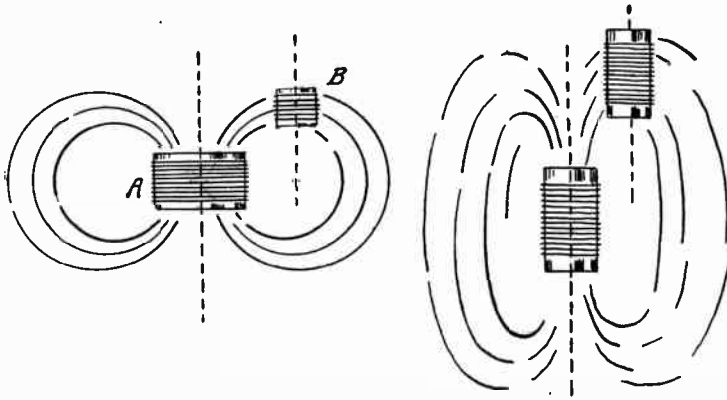

Fig. 3.—Field Lines of Force Passing at Right Angles Through a Coil.

the two coils must intersect at right angles and the second point is that the center lines must intersect at the center of the length of the winding on one coil.

This method of placing coils at right angles to each other is satisfactory when there are only two coils to be handled but when, as in many receivers, there are three or more radio frequency coils it is difficult to place more than two of them in a correct right angle relation to each other. Use is then made of the method shown in Fig. 3 whereby the lines of force forming the magnetic field of any one of the coils cut equally through both sides of all other coils coming within the field.

COIL, BALLAST

It will be seen from Fig. 3 that the axes of two coils may be kept parallel to each other and the second coil *B* placed in such a part of the field of the first coil *A* that all of the magnetic lines from coil *A* which cut through one side of coil *B* also cut through the other side of coil *B* and there is practically no magnetic coupling.

The position of the two coils with reference to each other depends on the ratio of their length to the diameter of their windings. At the left hand side of Fig. 3 is shown the correct position for coils which are comparatively short and of large diameter. At the right hand side of Fig. 3 is shown the position for coils which are comparatively long and of small diameter. The change in position is due to the change in the shape of the field of a coil as the winding is lengthened. Any number of coils may be placed in such an angular relation to each other that they have very little magnetic coupling.

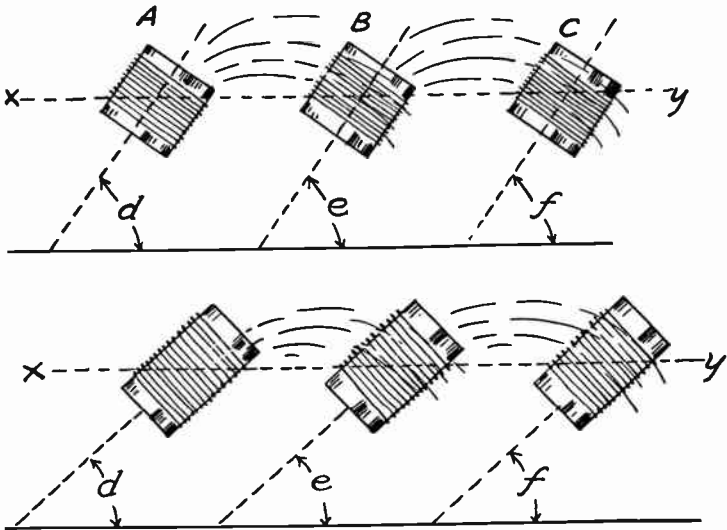

FIG. 4.—Coils at Angle at Minimum Coupling.

In Fig. 4 is shown the approximate position of three coils placed for minimum coupling. The axes of all coils so placed in a receiver must be parallel with each other and the centers of the winding axes must lie in one straight line such as the line X-Y in Fig. 4.

The correct angle for mounting these coils depends on the length of their winding, the diameter of their winding and the distance between adjacent coils. This angle is most easily found by experiment, starting with the approximate angle shown in Fig. 4. With coils of usual proportions the angles *d*, *e* and *f* are generally between 56 and 60 degrees.

COIL, BALLAST.—The name ballast coil is often given to a fixed resistance used in series with the filaments of one or more tubes to regulate the voltage applied to these filaments. Another name for this part would be resistance unit or resistor.

A loading coil for increasing the wavelength or reducing the frequency to which an oscillating circuit will respond is sometimes called a ballast coil.

COIL, BANK WOUND

COIL, BANK WOUND.—A bank wound coil is a plain cylindrical coil having two or more layers of windings one over the other. Were a multi-layer coil wound with the first layer running the entire length of the winding and with the second layer started over the end of the first one and brought back as at the right of Fig. 1 the first turn of the first layer would come directly underneath the last turn of the second layer. The greatest voltage difference between any two turns in such a coil is between the first turn and the last one. Therefore, the first and last turns coming together in a winding like that at the right of Fig. 1 would have a considerable capacity effect, since such an effect depends to a great extent on the voltage difference between two metallic parts.



FIG. 1.—Bank Winding of Two-Layer Coil.

To avoid this excessive distributed capacity the practice of bank winding is resorted to as shown at the left of Fig. 1. Here the first two turns of the first layer are wound in the usual way but the third turn is wound on top of the first two and forms the first turn of the second layer. The fourth turn is then wound alongside the first two, directly on the winding form, and the fifth is placed on top of the second and fourth according to the numbers shown in the drawing. A bank wound coil may be used where the length of a single layer coil would be too great for the amount of inductance desired.

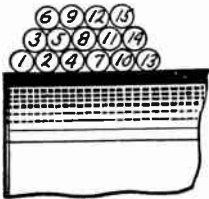

FIG. 2.—Bank Winding for Three-Layer Coil.

A three-layer bank wound coil is constructed as shown in Fig. 2. The first five turns are placed in the same way as for a two-layer coil. The sixth turn is on top of the third and fifth. After that the winding proceeds by laying each following set of three turns up along the turns already placed.

The bank wound coil is not suitable for use in tuned circuits employed for broadcast frequencies because of the excessive losses. It is true that bank winding makes a coil with less distributed capacity than were plain multi-layer winding used, but the capacity is still very great when compared with that of a single layer coil of equal inductance. In a two-layer bank wound coil using the same amount of wire as on a single-layer coil the distributed capacity and skin effect cause the bank wound unit to have an effective resistance about ten times as great as in the single layer unit.

COIL, BASKET WOUND.—An easily constructed form of self-supporting coil with spaced turns is known as the basket wound coil. Such a coil requires no solid winding form to be left permanently inside the winding and, due to the peculiar method of winding, adjacent turns are at some distance from one another. This

COIL, BASKET WOUND

construction thus gets rid of the losses inherent in any solid winding form and also reduces the distributed capacity which is caused in the ordinary close wound coil by the capacity between adjacent turns. Some of the advantage of the basket wound construction is lost due to the fact that it requires a considerably greater length of wire to provide a given inductance than is required in a plain cylindrical close wound coil.

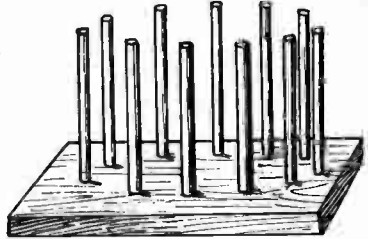

FIG. 1.—Form for Basket Winding.

The basket-wound coil is formed on a number of pegs or posts set into a base and forming a circle as in Fig. 1. An odd number of pegs must be used. They may be placed on any desired diameter of circle from two and

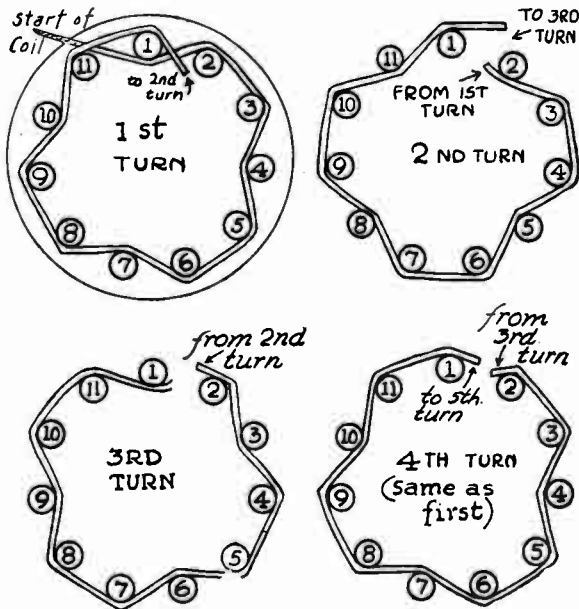

FIG. 2.—First Four Turns of a Basket Winding.

one-half inches up. Convenient diameters lie between three and five inches. The pegs must be solidly set into the base. If wooden pegs are used they must be at least one-quarter inch in diameter to provide sufficient strength but if steel rods are used one-eighth to three-sixteenths of an inch diameter will be sufficient.

The winding is started as shown at the upper left in Fig. 2. The wire is run behind one peg then outside of the next two, underneath the fourth one, outside of the fifth and sixth and so on around the form, following the rule of "one under and two over."

COIL, BINOCULAR

The first turn is shown in the upper left hand drawing of Fig. 2. The second turn, running from the end of the first one to the beginning of the third, is shown in the upper right hand drawing. The third turn is shown in the lower left hand drawing and the fourth turn is shown in the lower right hand drawing. It will be seen that the fourth turn is exactly like the first and the winding is continued on from this point until the desired number

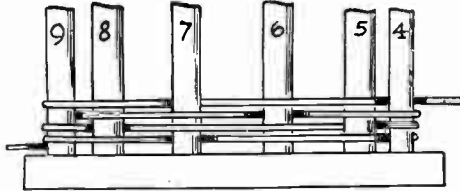

FIG. 3.—Partly Completed Basket Winding.

of turns is secured. The appearance of such a coil while still on its winding form and as viewed from the side is shown in Fig. 3. While still on the form the turns should be securely fastened by lacing as shown in Fig. 4.

Basket-wound cylindrical coils of this general type may be constructed by winding two turns outside the pegs, then two turns back of the pegs, two more turns outside and so on, following the rule of "two over and two under."

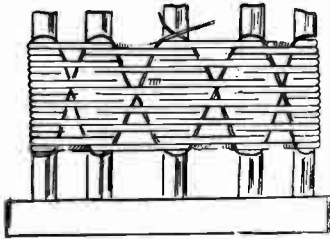

FIG. 4.—Finished Basket Winding with Lacing in Place.

It is also possible to wind such coils with each alternate turn outside and the intervening turns inside of the pegs, "one over and one under." The results are much the same for any method of winding, the principal difference being in the changed appearance of the finished coil.

If it is found more convenient, the lacing shown in Fig. 4 may be omitted and the coil held together by applying some kind of binder or coil cement at the points between the pegs where the turns cross one another.

COIL, BINOCULAR.—See *Coil, Closed Field Type*.

COIL, BUCKING.—A bucking coil is a part of a winding or is a separate winding on the same form as another winding, this bucking coil being wound or connected in such a way that its mag-

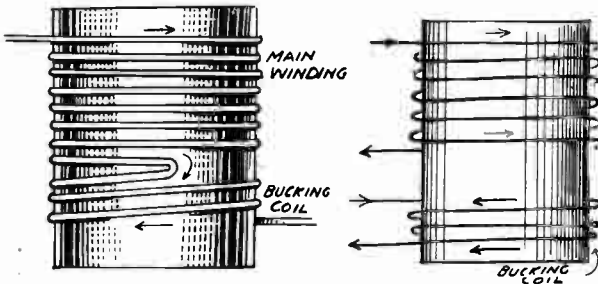

Bucking Coils or Bucking Windings.

COIL, CHOKE

netic effect opposes or bucks the magnetic effect of the main winding. The flow of current around the turns of a bucking coil is opposite to the direction of current flow around the turns of the main winding. Two forms of bucking coil are shown.

COIL, CHOKE.—A choke coil is a coil of great reactance or impedance whose purpose is to limit the flow of alternating or pulsating currents of certain frequencies through part of a circuit in which the choke is placed.

By means of various combinations of choke coils and condensers, a circuit containing currents of both high and low frequencies and also direct current may be so divided as to send the low frequency current through one path, the direct current through another path, and the high frequency current through a third path.

The plate circuit of the vacuum tube shown in Fig. 1 carries both radio frequency (high frequency) current and direct current. If

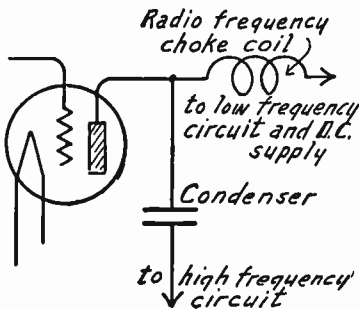

FIG. 1.—Separation of Frequencies with a Choke Coil.

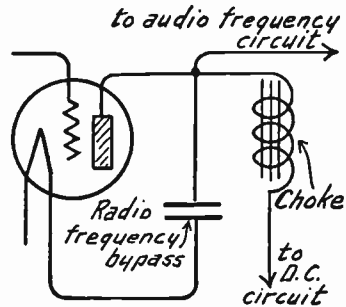

FIG. 2.—Separation of Direct and Alternating Currents with Choke Coil.

the tube should happen to be a detector, audio frequency (low frequency) currents are also taken from the plate circuit. If a radio frequency choke coil and a condenser are placed as shown in the plate circuit, the choke coil will oppose passage of radio frequency current through itself. But the radio frequency current will pass easily through the condenser since the condenser's reactance to high frequencies is very small. The condenser, however, forms an open circuit for the direct current of the B-battery. Consequently this direct current cannot pass through the condenser. The radio frequency choke has no iron core and is wound with comparatively large wire, therefore, it offers very little opposition to the low frequency audio current or to the direct current which flows freely through the choke. Audio frequency currents will pass through a radio frequency choke coil if the coil is properly designed to offer high reactance only at high frequencies.

The use of an iron-core choke coil is shown in Fig. 2. In this circuit the plate of the vacuum tube is carrying radio frequency or high frequency current, audio frequency or low frequency current

COIL, CHOKE

and direct current or battery current. The high frequency current finds a path of low reactance through the bypass condenser and returns to the tube filament. The direct current flows easily through the choke, leaving only the audio frequency current to pass to the audio frequency circuits. The bypass condenser is assumed to be of small capacity so that it offers high reactance to the audio frequency current and forms an open circuit for the direct current.

Wire Size in Chokes.—The wire must be of sufficient size to carry the current without overheating. This consideration is of importance in audio frequency chokes, also in filter chokes used for filament supply and for eliminating interference. In radio frequency circuits the maximum current is not over five milliamperes in the great majority of cases. In audio frequency circuits the maximum current is seldom more than twenty-five milliamperes for the lines in any one stage.

The wire size and the length used determine the direct current resistance of the choke. The resistance is one factor in impedance. The alternating current that will pass through any choke may be found by dividing the voltage by the impedance. The total current through the choke is the sum of the high frequency current, the low frequency current and the direct current. The wire is chosen to handle whatever total current will actually pass.

The following table shows the maximum allowable current in milliamperes for the different gauge sizes of copper wire used in choke coils of all types.

CURRENT CARRYING CAPACITY OF COPPER WIRE

Gauge Size	Current in Milliamperes	Gauge Size	Current in Milliamperes	Gauge Size	Current in Milliamperes
16	1700 to 2600	24	275 to 400	32	40 to 63
17	1300 to 2000	25	200 to 325	33	35 to 50
18	1100 to 1600	26	175 to 250	34	25 to 40
19	850 to 1300	27	125 to 200	35	20 to 32
20	675 to 1000	28	100 to 160	36	18 to 25
21	550 to 800	29	85 to 125	37	13 to 20
22	425 to 650	30	65 to 100	38	10 to 15
23	350 to 500	31	55 to 80	40	5 to 10

Proportions of Choke Coils.—A choke coil should contain the maximum possible inductance and the least possible resistance. The best ratio of resistance to inductance is obtained in solid layer-wound coils by making them of the following proportions:

With the length of the winding represented by 100, the thickness or depth of winding should be also represented by 100. The inside diameter of the winding, or the outside diameter of the winding form, should be represented by 266. The outside diameter of the winding should be represented by 466. As an example; supposing a choke coil were to be made one inch long. The length being 1.0 inch, the depth of winding should be 1.0 inch, the inside diameter of the winding should be 2.66 inches and the outside diameter should be 4.66 inches.

While the foregoing are the ideal proportions, chokes may vary widely from these dimensions and still be entirely satisfactory for their work.

COIL, CHOKE

Radio Frequency Chokes.—Choke coils designed to oppose only the flow of high frequency currents are usually of air-core type. They must be constructed to have the least possible distributed capacity since such capacity will pass the high frequency across the choke. The size of wire is of no particular importance, gauges from number 24 to number 32 being often employed. Larger sizes are equally satisfactory but they increase the bulk of the coil. Single cotton covered or double cotton covered wire is preferable to enameled wire because of the increased spacing and lower distributed capacity with the cotton covering. With double cotton covered wire the coil will be of considerably larger bulk than with single cotton in order to obtain the same inductance.

The radio frequency choke must oppose the passage of high frequencies but must not choke back the audio frequencies. Therefore, when only radio frequency currents are to be stopped the choke should not have an iron core unless the core is of very small size because the iron will give the coil so much inductance and reactance that some of the higher audio frequencies are quite likely to be lost.

If both radio frequencies and audio frequencies are to be choked by the same coil it is then necessary to use iron-core construction in order to obtain enough reactance to properly oppose the lower audio frequencies. Radio frequency currents will be choked effectively by any coil that will choke audio frequency.

An inductance of at least two and one-half millihenries is required for radio frequency chokes used in broadcast receivers. For almost complete stoppage of the radio frequency an inductance of five millihenries is better.

Honeycomb coils make excellent radio frequency chokes when there is space enough to allow their use. A honeycomb coil of 200 turns is the smallest that will prove reasonably effective. Coils of 250 or of 300 turns do very good work as chokes. A satisfactory radio frequency choke coil may be made by winding one thousand to fifteen hundred turns of number thirty-two single cotton covered wire on a form one inch long with a center formed by a five-sixteenth inch diameter wood or rubber rod or a fibre tube. Use no iron in the core.

Audio Frequency Choke Coils.—An audio frequency choke coil should offer a very high impedance at audio frequencies but should be of sufficiently low resistance so that direct current for the plate circuit is not unduly reduced.

Since the reactance of such chokes varies according to frequency, it is a rather difficult matter to obtain sufficient reactance to act as an effective stop for the very low audio frequencies. As an example, a choke to offer a certain reactance in ohms at twenty-five cycles would require eight times the inductance of a choke offering the same reactance at two hundred cycles. If the low frequencies are to be held back very large coils will be required for audio frequency chokes. See also *Amplifier, Audio Frequency, Impedance Coupled*.

Audio frequency chokes always have an iron core. They are generally formed with layer windings of enameled wire, although single cotton covered is more satisfactory from the standpoint of low distributed capacity. The gauge of wire employed is determined by the maximum current as shown in the preceding table.

COIL, CHOKE

Audio frequency chokes are made with inductances of from twenty-five to five hundred henries. The inductance required depends on the circuit in which the choke is to act. The audio frequency current will divide in inverse proportion between two or more possible paths according to the impedances of the paths, the greater part of the current flowing through the path of less impedance.

If an audio frequency circuit is attached to a choke coil of 200 henries inductance and also to an audio frequency transformer of 100 henries inductance the current will divide approximately in inverse proportion to the inductances, two-thirds passing through the audio frequency transformer and one-third through the choke.

Chokes sold as audio frequency amplifier coupling chokes or impedances make satisfactory coils for this work in any part of a receiver where the current to be carried is not greater than allowed by the wire size used in these coils. Secondary windings of audio frequency transformers may be used as makeshift choke coils with the same limitation as to wire size.

Several points in the design of choke coils for handling low frequencies are taken up in following paragraphs on iron-core choke coils.

Filter Chokes.—Choke coils used in filters of power supply units and in filters for the elimination of power line hum are always of the iron-core type. These chokes are built to have twenty, twenty-five or thirty henries inductance in most cases. The wire used depends on the current the choke must carry without overheating. Suitable wire sizes are given in the preceding table showing the maximum carrying capacity of copper wires.

Iron-Core Chokes.—Iron-core choke coils are often used in circuits carrying both direct current and alternating current. The direct current tends to magnetize the iron with a polarity depending on the direction of current flow around the iron. To prevent saturation of the iron, one or more air gaps are always built into the core. The total air gap must be wide enough to prevent magnetic saturation, which would prevent normal or proper action of the alternating current, yet the gap must not be so wide as to reduce the inductance below the required minimum.

The air gap in the core may be divided into a number of small gaps or may consist of a single large gap. The minimum air gap that is generally found satisfactory may be calculated from the following formula:

$$\text{Air Gap in Inches} = \frac{\text{Number of Turns} \times \text{Current in Amperes} \times 2.2}{\text{Flux Density in Lines per Inch}}$$

The flux density allowed may be anywhere from 10,000 to 30,000 lines. The smaller the core used for a coil of given inductance the greater will be the density.

The cores of choke coils may be either of the shell type or core type of construction. The section of the iron over which the winding is placed may be conveniently made square, using dimensions of from one-half inch up to one inch on a side. The overall size of the core is made to accommodate the winding required for the inductance. Under *Wire, Turns per Inch* is a table which shows the number of turns per square inch of cross section of winding.

COIL, CLOSED FIELD

Following are the approximate inductances obtained when using windings in which the length is equal to one and one-half times the depth of wire between inside and outside diameters and which are wound on one leg of a rectangular core. The air gap is assumed to be of a size determined by the formula given in a preceding paragraph.

With core iron three-quarters of an inch square in cross section; twenty henries will require 7,600 turns, thirty henries will require 9,800 turns, forty henries will require 12,000 turns and fifty henries will require 14,500 turns.

With core iron one inch square in cross section; twenty henries will require 5,750 turns, thirty henries will require 7,500 turns, forty henries will require 9,350 turns and fifty henries will require 11,250 turns.

All of these figures assume the use of enameled wire of gauge sizes between numbers thirty and thirty-four.

Iron-core chokes for prevention of radio frequency currents may be of two and one-half to five millihenries inductance. The core may be straight, formed either of iron wires or of thin flat iron laminations. Radio frequency filter chokes may be called upon to carry large currents when used for the reduction of power line interference. Following are wire sizes to be used:

To carry 0.75 to 1.0 ampere	use number 18 gauge
To carry 1.0 to 1.75 ampere	use number 16 gauge
To carry 2.0 to 3.0 ampere	use number 14 gauge
To carry 3.0 to 5.0 ampere	use number 12 gauge
To carry 5.0 to 8.0 ampere	use number 10 gauge
To carry 8.0 to 15.0 ampere	use number 8 gauge

The inductance of iron core choke coils may be calculated from the following formula:

$$\text{Inductance} = \frac{\text{Core Area} \times (\text{Number of Turns})^2}{\text{Air Gap} \times 40,000,000}$$

This assumes the use of silicon steel transformer core iron, an air gap determined by the preceding formula and a flux density of about 20,000 lines. The inductance is in henries, the core area in square inches of cross section and the air gap in inches. The result is close enough for average construction work.

COIL, CLOSED FIELD TYPE.—Much of the undesired feedback and consequent oscillation in receiving circuits is caused by coupling between the magnetic fields of radio frequency coils. A plain cylindrical coil such as that shown at the left of Fig. 1 has a large and widely distributed field. The size of such a field may be reduced either by completely shielding the coil or by using coil windings of such form that the field is closed upon itself to a greater or less extent.

A receiver using an ordinary cylindrical coil in its grid circuit has, in effect, a number of small loop antennas, one in each grid circuit. These small loop antennas are formed by the turns of wire around the cylindrical coils and they pick up signals from powerful nearby broadcasting stations. At least one and maybe two of the grid circuits in any tuned radio frequency receiver are naturally broad tuning. These broad tuning circuits are the grid circuit of the first tube, because it is coupled to the antenna and the grid circuit of the

COIL, CLOSED FIELD

detector when positive grid return is used. The coils pick up signals in these circuits which are naturally broad tuning and the selectivity that might be expected from two tuned circuits is not obtainable.

The double cylindrical coil of Fig. 1 is composed of two separate cylindrical coils, each having rather small diameter and comparatively great length. The windings of these two coils are joined in series and the current is sent around the two coils in opposite directions. The positive end of one coil will then be at the same end of the pair as the negative end of the other coil and the lines of force coming out of one coil will enter the other as shown. The field is thus confined except near the ends of the two coils.

The two coils of the pair are wound on tubes or forms of identical diameter and length. Each of the coils is usually from one inch to two and one-half inches in diameter and from three to five inches long. A clear space of at least one-half inch should be left between the two coils to avoid excessive capacity effect. Such a double coil

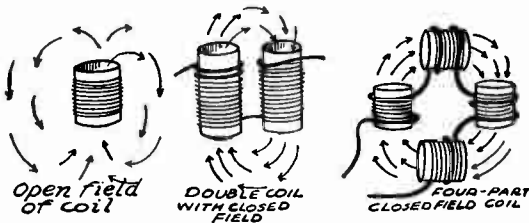

FIG. 1.—Coils with Open Fields and Closed Fields.

should be mounted with due care that no objects of any kind come within the open part of the field at the ends of the coil. Neither metal nor dielectric should be within the space occupied by the arrows.

The third type of coil shown in Fig. 1 is made of four parts with the windings in series with one another. A coil of this type has a more nearly closed field than the double coil, but for a given inductance the four-part coil occupies more space than any other form of closed field coil. The separate windings are on tubes of from one inch to two inches in diameter and from one and one-half to two inches long. The heavy continuous winding is the primary.

The toroid coil has an almost completely closed magnetic field. It is described in detail under the heading *Coil, Closed Field, Toroidal*.

Two variations of closed field coils are shown in Fig. 2. At the left is the D-coil which is wound on a cylindrical form with two vertical slots cut part way down through the form. The top view of the D-coil shows the method of placing the winding on the form. The form remains in the coil. The D-coil has the same characteristics of field as the double coil shown in Fig. 1. It has the advantage that the two ends of the windings are at opposite ends of the coil so that there is little capacity effect between them whereas with

COIL, CLOSED FIELD, TOROID

the double coil in Fig. 1 there is a considerable difference of voltage between the two ends of the total winding.

The "figure 8" coil shown in Fig. 2 has the same field characteristics as the double coil of Fig. 1, but since it is wound in a way exactly similar to the winding of a D-coil, the two ends of the winding are brought out at opposite ends of the coil so that capacity effect between them is reduced to a minimum. The "figure 8" coil is wound on two tubes of comparatively small diameter and great length, the same sizes being used as for the double cylindrical coil.

The spacing between closed field coils and between such coils and other parts in the receiver may be less than when using open field coils because of the reduced tendency to magnetic coupling of the closed field types. The closed field coils may be placed at any convenient angle to each other with little regard for their magnetic fields.

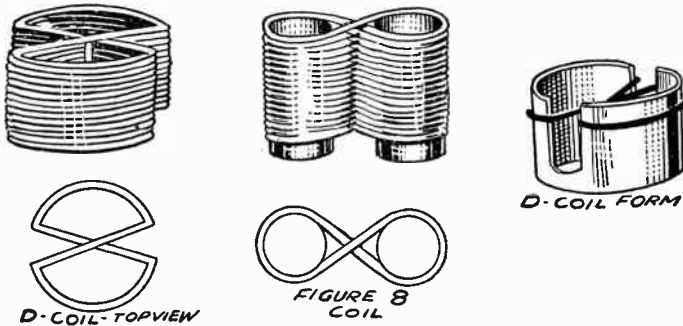

FIG. 2.—Coils of the Closed Field Type.

While it is true that the forms of coils just considered have their magnetic fields closely confined, this limiting of the field does not extend to the electrostatic field or capacity effect between any two coils in a receiver. Regardless of the shape or design of the coil the fact that it contains metal and has the dielectric air between it and other coils in the same receiver causes a capacity effect to exist between any two coils and a feedback of energy may take place through this capacity or electrostatic coupling.

COIL, CLOSED FIELD, TOROID.—The toroid coil of Fig. 1 has apparently a completely closed electromagnetic field. This coil is formed into a ring so that the two ends of its field join and allow a continuous flow of lines of force. At radio frequencies even a toroid coil has some external field although not nearly so extensive as that from a cylindrical coil.

While there is very little electromagnetic coupling between toroid coils there is some coupling due to capacity effects between them. There is also a very slight electromagnetic field from such a coil because the entire coil forms one large turn which, like any other turn, generates lines of force as in Fig. 2.

Any radio waves which reach a toroid coil will generate equal and opposite voltages on the two opposite sides. The two voltages balance and the net result is as if such a coil picked up no signals.

COIL, CLOSED FIELD, TOROID

This is shown in Fig. 3. It is true that the toroids themselves will not pick up undesired signals, but they cannot prevent amplification of such signals which are picked up by other parts of the receiver.

The number of turns and the overall size of a toroid may be determined from the required inductance. The coil may be proportioned to obtain the best relation between inductance and resistance by considering the outside

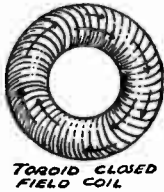

FIG. 1.—Toroid
Type of Coil.

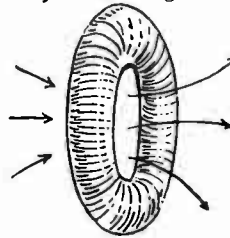

FIG. 2.—Magnetic Field of Toroid
Winding Acting as a Single Turn.

radius and the inside radius according to the measurements of Fig. 4. The outside radius of the coil is the distance from the center of the ring formed by the coil to the extreme outside or rather to the center of the wire forming the outside of the turns. The inside radius is the distance from the center of the ring to the center of the wire forming the inside of the turns. The greatest inductance is obtained when the outside radius is equal to 1.7 times the in-

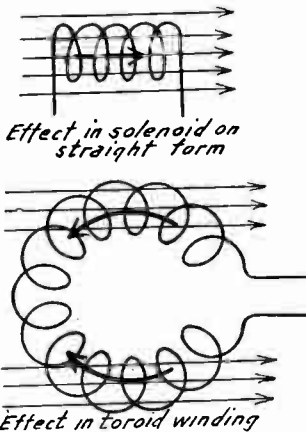
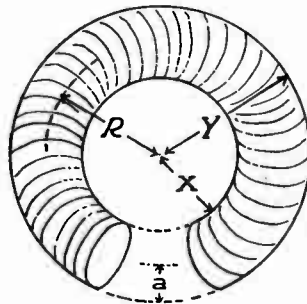

FIG. 3.—Opposing Voltages Set
Up in Toroid Winding.



a = winding radius
 X = inside radius $\frac{Y}{X} = 2.6$
 Y = outside radius
 R = mean radius

FIG. 4.—Measurements for Toroid
Coil Inductance Formula.

side radius but the best ratio of inductance to resistance, that is, the greatest inductance with the least resistance, is obtained when the outside radius is equal to 2.6 times the inside radius.

In any toroid coil the diameter of the turns must be small and a large number of turns must be used. This is necessary in order to keep the total size of the coil within reasonable limits.

The inductance of the toroid coil may be calculated from the following formula:

COIL, DEAD ENDS IN

$$L=0.01257 \times N^2 \times (R - \sqrt{R^2 - a^2})$$

in which L is the inductance in microhenries, N is the total number of turns in the whole winding, R is the distance in centimeters from the axis of the ring to the center of the cross section of the winding, distance R in Fig. 4. a is the radius in centimeters of the turns of the winding.

A toroid winding may be constructed according to the following method: Select a piece of tubing of the desired cross sectional diameter for the coil to be wound and of a length greater than the length around the ring of the toroid.

Wrap a piece of thin waxed paper around this tube and wind an ordinary single layer coil on the outside of the paper. The purpose of the paper is to allow the winding to be slipped off the tube later on.

Secure a long narrow strip of very thin celluloid and fasten it along the length of the winding on the tube with collodion or coil cement. That is, paste the strip along one side of the coil winding on the tube. Then slip the whole thing off the tube. Bend the celluloid strip into a circle which forms the inside of the ring, fasten the ends of the strip together and the toroid winding is complete.

COIL, DEAD ENDS IN.—A dead end is an unused portion of a coil or winding. The tapped coil shown at the left in the draw-

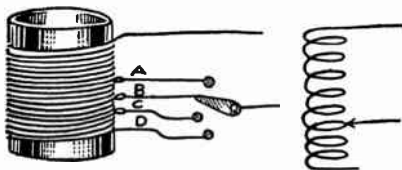

Dead Ends on a Coil Winding.

ing is connected at points A , B , C and D with the small switch. With the switch in the position shown, connected to tap B , all of that portion of the coil from B to D forms a dead end. The symbol for a tapped coil with a dead end at the bottom is shown at the right.

A voltage is induced in the dead ends of a coil and this voltage causes current to pass through the coil's distributed capacity. This current acts on the used part of the coil in such a way as to increase its resistance.

If dead ends must be used on a coil, do not short-circuit them while they are not in use because the closed circuit formed by a short-circuited dead end will absorb a great deal of power. It is better to completely disconnect the dead ends from the remainder of the coil when they are not in use. Even then the presence of the open turns in close proximity to the used part of the coil will form a considerable loss and will dissipate much energy. See *Switch, Dead End*; also *Coil, Tapped*.

COIL, DESIGN.—In designing single layer, air-core inductance coils there are certain rules which will aid in avoiding unnecessary losses and in making the coils more efficient in operation.

First, to consider the relation between coil diameter and length, the maximum inductance for any given length of wire on a single

COIL, DESIGN

layer coil is secured when the diameter is equal to 2.3 times the length. This would be a coil of the proportions shown at the right in Fig. 1. It is not necessary to follow this rule strictly because good results will be secured in practice when, with a diameter represented by three units, the length is anywhere between one and four units. That is, a coil three inches in diameter may be anywhere from one to four inches long and give good results. A coil of these general proportions has the further advantage of a comparatively small field.

The other extreme of ratio between length and diameter is shown at the left in Fig. 1. It should be noted that the length of the coil is taken as the length of the winding, not as the length of the form on which the coil may be wound.

In the design of any radio frequency coil there are four important factors. First, to obtain the most inductance with the least wire; second, to obtain the least high frequency resistance; third, to obtain the least distributed capacity, and fourth, to build a coil with

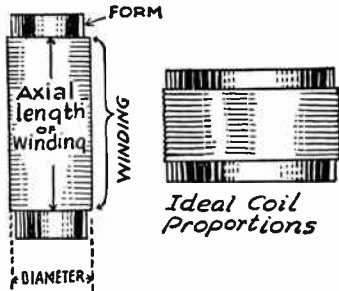

FIG. 1.—Design Proportions between Length and Diameter of Coil Windings.

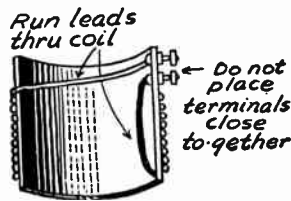

FIG. 2.—Wrong Design for Running Leads through a Coil.

the smallest field. Each of these things should be given consideration when deciding upon the various features of coil design.

The features of coil design include the type, shape and proportion of the winding, the wire size and insulation, and the design and material of the winding form and of the coil supports. In the following table are listed the different practices and methods that may be adopted in designing and building a radio frequency coil. At the right of each method in five separate columns are listed the advantages or disadvantages of each method considered from the standpoints of durability, inductance, resistance, distributed capacity and size of field.

The ratings are given as best, good, fair and poor. When possible the method designated as best should be employed provided it does not interfere too much with other requisites of the coil design. A rating of good indicates that satisfactory results may be expected. Fair means that this method may be allowed when no other seems available. Any method listed as poor should be avoided except in case of necessity.

COIL, DESIGN

ADVANTAGES AND DISADVANTAGES IN COIL DESIGN

	Durability	Most Inductance	Least Resistance	Least Distributed Capacity	Small Field
<i>Type of Winding</i>					
Cylindrical, single layer, close wound.....	Best	Best	Best	Poor	Poor
single layer, space wound.....	Good	Poor	Good	Good	Poor
bank wound.....	Good	Good	Poor	Poor	Poor
honeycomb, duolateral, etc.....	Good	Good	Fair	Good	Good
basket wound.....	Fair	Fair	Good	Best	Fair
Flat, basket wound, diamond.....	Fair	Fair	Fair	Best	Good
flat wound, spiderweb.....	Good	Fair	Poor	Good	Good
<i>Shape of Winding</i>					
Open field type, cylindrical or circular.....	Best	Good	Good	Fair	Fair
hexagon, octagon, etc.....	Good	Fair	Good	Fair	Fair
square, oblong, etc.....	Good	Poor	Fair	Fair	Fair
Closed field type, double, toroid, etc.....	Fair	Poor	Fair	Good	Best
<i>Proportion of Winding</i>					
Large diameter, short in length.....	Good	Best	Good	Poor	Fair
Small diameter, long winding.....	Good	Poor	Fair	Good	Fair
Diameter about half of length.....	Good	Good	Best	Fair	Good
<i>Wire Insulation</i>					
Air, bare wire.....	Poor	Fair	Fair	Good	Fair
Cotton, double covered.....	Good	Fair	Fair	Best	Fair
single covered.....	Fair	Good	Fair	Fair	Good
Silk, double covered.....	Good	Good	Good	Fair	Good
single covered.....	Fair	Best	Fair	Poor	Good
Enamel.....	Fair	Good	Fair	Poor	Good
cotton covered.....	Good	Good	Good	Good	Fair
<i>Wire Size</i>					
Small, No. 30 to No. 26.....	Good	Best	Fair	Best	Good
Medium, No. 24 to No. 20.....	Good	Good	Good	Good	Fair
Large, No. 18 to No. 14.....	Best	Fair	Best	Fair	Poor
<i>Material of Winding Form</i>					
Paraffined paper or cardboard.....	Poor	—	Good	Good	—
Fibre and "mud" dielectrics.....	Good	—	Poor	Poor	—
Dry paraffined wood.....	Good	—	Good	Good	—
Hard rubber.....	Fair	—	Best	Good	—
Phenol fibre, bakelite, etc.....	Best	—	Fair	Fair	—
Glass.....	Fair	—	Fair	Fair	—
<i>Design of Winding Form</i>					
Solid or continuous material.....	Best	—	Fair	Fair	—
Skeleton form.....	Good	—	Good	Good	—
No form, self-supporting coil.....	Poor	—	Best	Good	—
<i>Fastenings of Winding</i>					
Wire laced together or in place.....	Fair	—	Good	Good	—
Binder of collodion or coil cement.....	Good	—	Fair	Fair	—
Binder of varnish, glue, etc.....	Good	—	Poor	Poor	—

COIL, DIAMOND WEAVE

ADVANTAGES AND DISADVANTAGES IN COIL DESIGN—*Continued*

	Durability	Most Inductance	Least Resistance	Least Distributed Capacity	Small Field
<i>Material of Supports</i>					
Entirely of dielectric.....	Best	—	Good	Good	—
Dielectric, fastened with metal parts.....	Fair	—	Fair	Fair	—
Entirely of metal.....	Good	—	Poor	Poor	—
<i>Connections to Winding</i>					
Terminals close together in dielectric.....	Good	—	Poor	Poor	—
well separated in dielectric.....	Good	—	Good	Good	—
Direct leads, no terminals.....	Best	—	Best	Best	—
Tapped connections.....	Fair	—	Poor	Poor	—

From the foregoing table it is seen that a construction may be desirable in some ways, yet very undesirable in others. All things considered, durability is probably the most important single consideration in a receiver intended to give continual enjoyment of broadcast programs. In a receiver of an experimental type, intended principally as a means of testing the effects of various constructions, durability would come last. Next in importance for conditions of average use come the advantages of a small field, least distributed capacity, least resistance and most inductance in the order given.

Do not run the leads or connections from one end of the coil through the center of the coil form to terminals at the other end as shown in Fig. 2 because this increases both the distributed capacity and the apparent resistance of the coil. If it is absolutely necessary to run a wire through a coil, run it through the exact center as far from the walls of the form as possible.

Do not place terminals or binding posts carrying the two ends of the winding close to each other as in Fig. 2 because there is considerable distributed capacity between them.

Do not coat a coil with ordinary varnish or shellac. Use either collodion, paraffine or special coil cement. Use the smallest possible amount of any binder.

Among the things generally to be avoided in coils are: wire sizes smaller than number 28, enamelled wire, heavy or bulky winding forms, metal parts in coil mountings, terminals set into heavy blocks of insulation, taps and unused turns.

COIL, DIAMOND WEAVE.—See *Coil, Honeycomb* and *Coil, Spiderweb Type*.

COIL, DISTRIBUTED CAPACITY IN.—In a coil we wish to have inductance only but we cannot possibly avoid having also resistance and capacity. The turns of wire in a coil produce inductance which is desirable. The insulation of the wire and the material on which the coil is wound produce some of the effective resistance while the remainder is accounted for by the resistance of the metal in the wire itself. The unwanted capacity allows loss of energy which is equivalent to a resistance loss.

There is, of course, a voltage or electrical pressure acting across a coil. The greatest voltage differences will be between one end

COIL, DISTRIBUTED CAPACITY IN

and the other of the winding, but there are also differences of voltage between each two adjacent turns. That is, in a coil of forty turns across which there is a pressure of eighty volts we will find a drop of two volts between each two turns. In other words, we have two conductors (represented by two turns in the coil) and one of these conductors is at a higher voltage than the other. They are separated from each other by a small space which may be filled by the wire's insulation or by air. Therefore, each two adjacent turns form the plates of a small condenser which are separated by a dielectric and are at different voltages. In a coil of forty turns we therefore have many condensers in addition to the inductance we are trying to get. It is the combined capacity of all of these tiny condensers that is called the distributed capacity of the coil.

The effect of distributed capacity is almost the same as if a single large condenser were connected between the two ends of the coil or connected in parallel with the coil. About the only difference is that the condenser formed by the distributed capacity is an exceedingly poor one viewed from the standpoint of efficiency and radio losses.

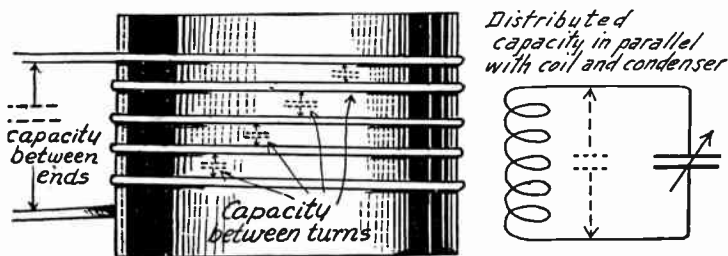

Distributed Capacity and Its Effect in a Coil.

One effect of distributed capacity is to bypass a certain part of the radio frequency currents. It is well known that a condenser of given size will pass more and more radio frequency current as the frequency increases. That is, a condenser of a certain size will pass much more current at 1000 kilocycles than at 500 kilocycles. Now, since we have the effect of a small bypassing condenser across every coil it follows that the leakage will increase with every increase of frequency. This leakage causes a loss of energy and this loss becomes greater and greater with increase of frequency.

Distributed capacity may sometimes produce another effect. An oscillating circuit is formed by an inductance and a capacity together. This is just what we have in a coil with its distributed capacity. This combination will be resonant at some rather high frequency because the inductance of the coil will be tuned by the coil's own capacity and then the circuit will absorb great amounts of power at that frequency.

At the frequency to which the coil with its distributed capacity is naturally resonant oscillating currents will circulate in the winding and capacity. The power required to maintain these oscillating currents is absorbed from circuits in which the coil is used and this energy is a complete loss. At resonance the coil becomes a parallel resonant circuit, having great impedance to currents from outside the coil when these currents are at the resonant frequency.

COIL, DISTRIBUTED CAPACITY

Therefore a coil will strongly oppose frequencies of its own natural period and it acts as a high impedance in its circuit.

The frequency or wavelength to which a tuned circuit responds is determined by its inductance and capacity. The increase of either one results in the circuit's responding to a lower frequency or higher wavelength. Therefore, the addition of the distributed capacity of the coil has the same effect on tuning as the addition of more external capacity or more inductance. One effect of this distributed capacity is to increase the apparent inductance of the coil. At least it increases the wavelength to which the coil responds. The frequency to which the combined inductance and capacity of the coil will respond is called the natural frequency of the coil, and it determines the lowest wavelength or highest frequency at which the coil is useful in a radio receiver.

The effect of the distributed capacity in causing an apparent increase of inductance with increase of frequency may be realized from the following statement: In a coil whose effective inductance is 291 microhenries at one kilocycle the effective inductance becomes 298 microhenries at 500 kilocycles (600 meters), 319 microhenries at 1000 kilocycles (300 meters) and 355 microhenries at 1500 kilocycles (200 meters). The effects of distributed capacity increase with frequency because the reactance of any capacity becomes less with increased frequency and allows more current to flow. At very high frequencies the distributed capacity of a coil may be of greater importance than its inductance.

It is sometimes thought that because a tuning condenser is used across the terminals of a coil that a little additional capacity in the coil will do no harm. But the capacity of the tuning condenser is almost free from resistance effects or losses while the distributed capacity of the coil is a loss, an effective resistance. This distributed capacity adds resistance to the whole circuit and having it in the circuit is the same as using an extremely poor condenser for tuning.

The effect of distributed capacity is reduced by space winding in any coil. Therefore the forms of coils having the greatest freedom from distributed capacity include space-wound single layer coils, basket-wound coils and spiderweb coils. Measurement of distributed capacity is described under *Oscillator, Radio Frequency, Uses of*.

Factors Affecting Distributed Capacity.—Distributed capacity in a coil is determined principally by five factors.

First: The longer the coil and the smaller its diameter the less will be the distributed capacity because of the increased separation of the end turns between which there is the greatest difference of voltage. A long thin coil, however, has less inductance for a given length of wire than one in which the diameter and length are more nearly equal.

Second: The greater the diameter of a coil the greater will be the distributed capacity. There will be a greater voltage difference per turn since for given inductance such a coil will have fewer turns than a long thin one. The capacity effect between two adjacent conductors, two adjacent turns, is increased with increase of voltage difference between them.

Third: The capacity between turns of a coil depends on the insulation or dielectric used around the wire. Air gives the least capacity of all, so bare wire coils have less distributed capacity than a similar coil with any form of insulation around the wire. Cotton covering is next best, then comes silk, and enamel is worst of all.

Fourth: There is less distributed capacity in a coil wound with small sizes of wire than when wound with large sizes. The surface area of the turns is less with small wire and since adjacent turns form the plates of miniature

COIL, DOUGHNUT

condensers the smaller these plates the less will be their capacity to each other.

Fifth: The material and shape of the form or tube on which the coil is wound also affect the distributed capacity. The lower the dielectric constant of the form the less will be the distributed capacity. From this standpoint alone perfectly dry paper, cardboard or wood would be best, closely followed by hard rubber. Bakelite and glass have a higher dielectric constant and will increase the distributed capacity.

COIL, DOUGHNUT.—See *Coil, Closed Field, Toroid.*

COIL, DUOLATERAL.—See *Coil, Honeycomb.*

COIL, EXPLORING.—A small air-core inductance attached to a pair of headphones or to a frequency meter. The exploring coil may be moved about in the vicinity of electromagnetic or electrostatic fields and by its effect in the meter circuit or headphones the strength and extent of such fields may be learned.

COIL, FEEDBACK.—See *Coil, Tickler.*

COIL, FIELD OF.—The field which is due to the difference in voltage between parts of the coil and between the coil and surrounding objects is called the electrostatic field. See *Field, Electrostatic.*

The field which is due to the magnetic lines of force passing through the core or center of the coil and the surrounding space is called the electromagnetic field. See *Field, Magnetic and Electromagnetic.*

COIL, FILTER.—See *Coil, Choke*; also *Filter.*

COIL, FORMS FOR.—The methods of supporting the wire which forms a coil are as follows: First, self-supporting coils; second, skeleton forms similar to those shown; third, hard rubber tubing or forms; fourth, dry waterproofed wood; fifth, dry waterproofed cardboard; sixth, phenol fibre forms such as bakelite.



Skeleton Forms for Coils.

The advantages and disadvantages of the various forms from both the electrical and mechanical standpoints are shown under the heading of *Coil, Design of.* In actual construction all factors must be considered. For example, a material comparatively poor in electrical performance may be best from the standpoint of mechanical strength, appearance, permanence and freedom from the effects of moisture, heat, and dust. The principal objection to hard wood and cardboard is that the addition of sufficient binder to maintain them in a dry and waterproof condition makes them less desirable electrically. Hard rubber is desirable in every respect except that it is deformed under pressure and heat.

A winding form or tube may be improved by cementing strips of hard rubber, celluloid or bakelite lengthwise of the form about every half or three-quarters of an inch around it. This raises the winding away from the solid

COIL, HONEYCOMB

surface of the form and reduces the distributed capacity and effective resistance.

COIL, HONEYCOMB.—Honeycomb coils, which are sometimes called duolateral or lattice wound coils, include a form usually of fibre or cardboard, on which the coil is wound one layer over another with the turns running diagonally or spirally around the coil and spaced from each other by a distance equal to two or three times the diameter of the wire. The appearance of such a coil is shown in Fig. 1. The specifications and electrical characteristics of generally used honeycomb coils are shown in the following table.

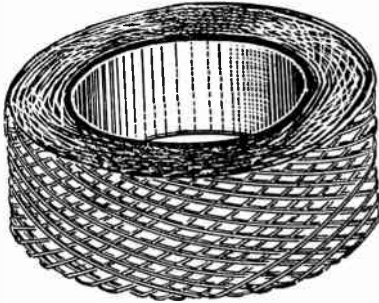

FIG. 1.—A Honeycomb Coil.

INDUCTANCE AND CAPACITY OF HONEYCOMB COILS

Number of Turns	Wire Size in Winding	INDUCTANCE		Distributed Capacity Micro-microfarads	Resistance in Ohms (D. C.)
		Microhenries	Millihenries		
25	24	40	—	30	0.42
35	24	72	—	33	0.50
50	24	150	—	31	0.88
75	24	325	—	26	1.24
100	24	555	—	24	1.68
150	24	—	1.3	17	2.56
200	25	—	2.3	16	4.44
250	25	—	3.7	15	5.65
300	25	—	5.4	17	7.11
400	25	—	9.6	13	10.7
500	25	—	15.5	13	12.4
600	28	—	21.6	14	27.8
750	28	—	34.2	14	35.3
1000	28	—	61.0	13	50.0
1250	28	—	102.5	11	67.0
1500	28	—	155.0	13	88.0

Coils from which the above measurements were made have a uniform inside diameter of two inches, a winding length of one inch, and outside diameters varying from two and one-quarter to four and one-half inches.

The winding scheme used in making a honeycomb coil is shown in Fig. 2. The form may be a cylindrical block into the surface of which are set radial pegs or posts. The pegs are set into holes from which they may be removed when the winding is complete. The appearance of a segment of the form with a number of pegs in place is shown.

The winding is started by taking it around the outside of two pegs, then across the width of the form and around the outside of two pegs on the opposite side. The form should have an uneven number of pegs on each side with the same uneven number on both sides. The starts of the first four turns are

COIL, IMPEDANCE OF

shown in Fig. 2. The first turn is shown by a solid line, the second turn by a broken line, the third turn by a line composed of long and short dashes and the fourth by a double line. The same method is followed around and around the form until the desired number of turns is obtained. The wire is secured by an application of any kind of binder or cement. The pegs are then pulled out of the form and the coil slipped off one side.

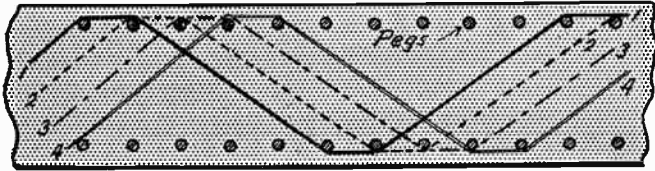

FIG. 2.—Method of Winding a Honeycomb Coil.

COIL, IMPEDANCE OF.—See *Impedance*.

COIL, INDUCTANCE OF.—The inductance of any coil depends on its number of turns of wire, its diameter and its length. Increasing any of these three factors will increase the inductance of the coil provided that an increase of length is accompanied by an increase of the number of turns. If the number of turns and the diameter remain the same while the length is increased, the inductance will be reduced because the turns will be spread out more and will be farther from one another. See also *Induction, Electromagnetic*.

The inductance of single layer, air-core, cylindrical coils may be found from formulas and tables in the paragraphs immediately following. Inductances for other forms of coil windings are given under *Coil, Choke; Coil, Closed Field, Toroid; and Coil, Honeycomb*. Information on coil sizes for tuned radio frequency work is given under *Coil, Tuning, Sizes Required for*.

Doubling the diameter or the number of turns will not exactly double the inductance because the ratio of the coil's length to its diameter has an important effect on the inductance. For example, doubling the number of turns will more than double the inductance while doubling the diameter will give the coil nearly three times as much inductance.

To obtain the true inductance it is necessary to figure on the shape of the coil by introducing what is called the elongation factor which is designated by the letter "K." It depends on the ratio of diameter to length.

The inductance of a closely wound cylindrical air-core coil may be found from the following formula when the dimensions are in centimeters:

$$\text{Inductance in Microhenries} = \frac{\text{Number of Turns Squared} \times \text{Radius Squared} \times 0.04 \times K}{\text{Length of Winding}}$$

COIL, INDUCTANCE OF

The values for K are given in the following table. The number of turns is the total number in the winding. The radius and the length of winding are both in centimeters. The number 0.04 is an approximation for 0.039478 by which the multiplication may be made instead of by 0.04 if more accurate results are required. The radius is the distance from the center of the winding to the center of one of the wires in any turn.

When the measurements are all in inches the following formula may be used:

$$\text{Inductance in Microhenries} = \frac{\text{Number of Turns Squared} \times \text{Radius Squared} \times K}{10 \times \text{Length of Winding}}$$

Here again the values for K are found from the following table. The radius and the length of winding are in inches.

To find the proper value of the elongation factor, K , in the following table, divide the coil's diameter by its length and find the resulting number in the column headed "Ratio D/L ." The value of K for this coil will be found at the right.

VALUES OF ELONGATION FACTOR "K"

Ratio D/L		Ratio D/L		Ratio D/L		Ratio D/L		Ratio D/L	
	K		K		K		K		K
100.0	0.0350	14.0	0.1605	5.4	0.3050	2.9	0.4370	0.95	0.6995
90.0	.0381	13.0	.1692	5.2	.3122	2.8	.4452	.90	.7110
80.0	.0419	12.0	.1790	5.0	.3198	2.7	.4537	.85	.7228
70.0	.0467	11.0	.1903	4.8	.3279	2.6	.4626	.80	.7351
60.0	.0528	10.0	.2033	4.6	.3364	2.5	.4719	.75	.7478
50.0	.0611	9.5	.2106	4.4	.3455	2.4	.4816	.70	.7609
45.0	.0664	9.0	.2185	4.3	.3502	2.3	.4918	.65	.7745
40.0	.0728	8.5	.2272	4.2	.3551	2.2	.5025	.60	.7885
35.0	.0808	8.0	.2366	4.1	.3602	2.1	.5137	.55	.8033
30.0	.0910	7.5	.2469	4.0	.3654	2.0	.5255	.50	.8181
28.0	.0959	7.4	.2491	3.9	.3708	1.9	.5379	.45	.8337
26.0	.1015	7.2	.2537	3.8	.3764	1.8	.5511	.40	.8499
24.0	.1078	7.0	.2584	3.7	.3822	1.7	.5649	.35	.8666
22.0	.1151	6.8	.2633	3.6	.3882	1.6	.5795	.30	.8838
20.0	.1236	6.6	.2685	3.5	.3944	1.5	.5950	.25	.9018
19.0	.1284	6.4	.2739	3.4	.4008	1.4	.6115	.20	.9201
18.0	.1336	6.2	.2795	3.3	.4075	1.3	.6290	.15	.9391
17.0	.1394	6.0	.2854	3.2	.4145	1.2	.6475	.10	.9588
16.0	.1457	5.8	.2916	3.1	.4217	1.1	.6673	.05	.9791
15.0	.1527	5.6	.2981	3.0	.4292	1.0	.6884	.00	1.0000

In using the first formula for inductance it is convenient to know the number of turns per centimeter of coil length when using the various gauges of wire with their different insulations. The following table gives this information.

COIL, INDUCTANCE OF

WIRE TURNS PER CENTIMETER OF LENGTH

Wire Gauge	Single Cotton	Double Cotton	Single Silk	Double Silk
20	10.4	9.3	11.5	10.9
22	12.4	11.1	14.2	13.3
24	15.1	13.0	17.55	16.2
26	18.0	15.1	21.5	19.5
28	21.2	17.2	26.4	23.4
30	24.7	19.5	31.9	27.7

Under the heading *Coil, Tuning, Sizes Required*, are tables showing the number of turns required on various size tubes, using various kinds of wire, to tune over the range of broadcasting frequencies when using condensers of generally available sizes.

Effective Inductance.—There is an increase of effective or apparent inductance with increase of frequency at which a coil is used. For example, the apparent inductance of a certain single layer coil is found to be 298 microhenries at 500 kilocycles and 356 microhenries at 1500 kilocycles. This change is detrimental because it

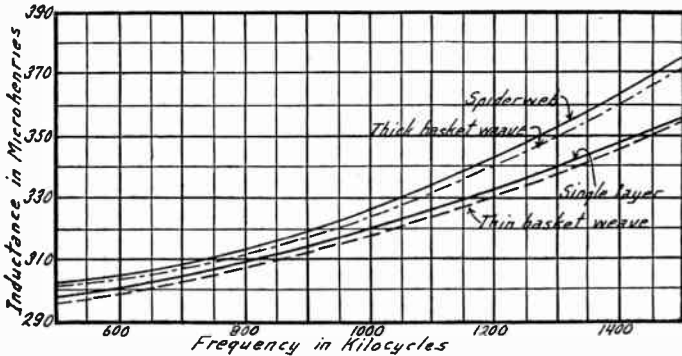

Change of Coil's Effective Inductance with Frequency.

calls for a greater change in the capacity of a variable tuning condenser to overcome the increasing inductance. To tune to higher frequencies either the capacity of the condenser, the inductance of the coil, or both capacity and inductance must be reduced. Inasmuch as the inductance of the coil increases with frequency, the capacity of the condenser must be still further reduced to tune to a given frequency. The change in inductance for several types of coils, all having a nominal inductance of 291 microhenries, is shown in the curves.

Effect of Distributed Capacity.—All coils have a certain amount of distributed capacity in addition to their inductance. The apparent inductance is altered by this capacity and is found from the following formula:

COIL, IRON CORE TYPES

$$\text{Apparent Inductance} = \frac{\text{Actual Inductance}}{1 - (6.283 \times \text{Frequency})^2 \times \frac{\text{Distributed Capacity}}{\text{Actual Inductance}}}$$

The actual inductance is that calculated from formulas given on preceding pages.

Effect of Metal in Coil's Field.—Bringing a piece of metal into the field of a coil which is operating at high frequency will cause a reduction of the apparent inductance of the coil.

In the case of a single layer coil, moving a metal plate from a distance of one and one-half inches away to within three-sixteenths of an inch of the end of the coil will reduce the apparent inductance from 330 microhenries to 285 microhenries. Similar movement of the plate into the field of a honeycomb coil reduces the inductance from 550 to 450 microhenries, while with a spider-web coil the reduction is from 390 to 230 microhenries. These are observed changes in experimental work but they indicate the effect of metal pieces in general.

For methods of matching coil inductances see *Oscillator, Radio Frequency, Uses of.*

COIL, IRON-CORE TYPES.—Iron-core coils are used in audio frequency transformers, in audio frequency amplifying impedances, in filter chokes for power supply units, in chokes for the elimination of interference, and in chokes for the separation of audio frequency currents from direct currents. Uses of such coils are described under the following headings: *Amplifier, Audio Frequency; Power Unit; Filter; Interference; and Coil, Choke.*

COIL, LATTICE WOUND.—See *Coil, Honeycomb.*

COIL, LOADING.—A loading coil is an inductance coil which is added to a tuned circuit so that the circuit will be resonant or will tune at higher wavelengths or lower frequencies, than without the loading coil.

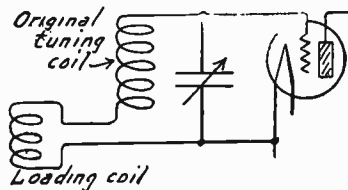

Loading Coil Added to a Tuned Circuit.

The term loading coil does not signify any particular style of coil, but tells only the use to which the coil is put. Any type of coil which would be suitable for the circuit in which inserted may be used for this work.

Loading coils might be added to the circuits in a short-wave amateur receiver to allow its use on the broadcasting range, and they might be added to any broadcast receiver so that it would tune to the higher wavelengths used by government and commercial stations in trans-oceanic work. For methods of inserting loading coils see *Jacks and Switches, Uses of.*

COIL, LORENZ.—See *Coil, Basket Wound.*

COIL, LOSSES IN.—There are a number of different causes for loss of energy in tuning coils used in receivers. An ideal coil

COIL, MATCHING OF

from the standpoint of low loss would be wound with wire having no resistance, would require no support and would be in a position completely isolated from all other parts of the receiver. Of course such conditions cannot be attained but in attempting to come close to them many of the common losses will be eliminated. Design factors affecting loss of energy are treated under *Coil, Design*.

Most of the causes for loss of energy are treated under their separate headings. Following is a list of the more important ones:

High frequency resistance in the coil. See *Coil, Resistance of*.

Distributed capacity between the turns and between terminals. See *Coil, Distributed Capacity in*.

Dielectric absorption due to such causes as poor insulation between turns of wire or to the use of tapped coils. See *Absorption, Dielectric*.

The form on which the coil is wound or the supports of the coil may be made of material which forms a poor dielectric. See *Dielectric*.

Nearby metal parts or shields may cause eddy currents to be formed in these parts. See *Current, Eddy*.

The insulation of the wire may absorb moisture thus reducing the insulation between turns. See *Binders*.

COIL, MATCHING OF.—See *Oscillator, Radio Frequency, Uses of*.

COIL, MOUNTING OF.—No metal should be used in the parts which form the supports of a coil. It may sometimes seem necessary to use screws, bolts and nuts but they should then be made of the smallest possible size. Strips and posts of brass or aluminum should not be used in coil supports.

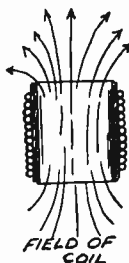

FIG. 1.—Coil Mounting in Weak Field.

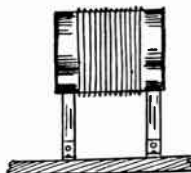

FIG. 2.—Plug Mounting for Coil.

As far as possible all material, no matter of what kind, should be kept out of the strongest part of a coil's field. The strongest part of the field is inside of the coil and at its ends as shown in Fig. 1. The field becomes steadily weaker as the distance from the ends of the coil winding increases. A substantial support for a coil so designed that it is in the weakest possible part of the field is shown at the right in Fig. 1. A support that would fully satisfy the requirement of keeping all materials at a minimum quantity within the field of the coil would probably be too weak for the mechanical

COIL, NON-INDUCTIVE

requirements, therefore a compromise must be made between elimination of loss and mechanical durability and rigidity of construction.

In plug mounting coils such as the one in Fig. 2 the plugs should be well separated from each other where they pass through the solid insulating material. Any form of plug mounting increases the capacity appreciably unless the plugs are more than an inch apart.

Because of the tremendous loss in eddy currents a condenser should never be mounted inside of a coil. Such practice increases the effective resistance twenty to forty per cent. If a coil is mounted on a condenser the center line or axis of the coil should be at right angles to the condenser shaft and the side of the coil nearest the condenser should be separated at least one inch from the nearest metal part of the condenser.

COIL, NON-INDUCTIVE.—A coil wound in such a way that it has little or no inductance is called a non-inductive coil. A winding on a flat form such as the one at the left in the illustration is one type of non-inductive coil. Such a coil has almost no inductance because it has practically no cross sectional area and has no dimension taking the place of the diameter of a cylindrical coil.

It is possible to wind a non-inductive coil by placing the turns so that half of them run in each direction around the winding form. The inductance of one half the winding then neutralizes the inductance of the other half and the net result is nearly zero inductance. This construction is also shown. A non-

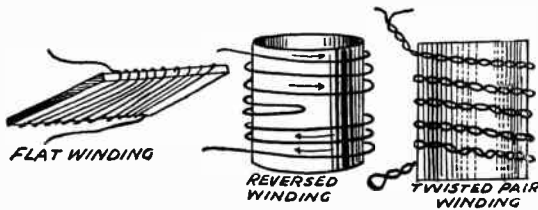

Non-Inductive Windings for Coils.

inductive winding may also be made by using a double conductor such as "twisted pair" with both wires at one end of the twisted pair cable joined together. Current then runs around the coil one way through one of the conductors, turns at their joined end and comes back the other way through the other conductor. This principle is shown at the right. Non-inductive windings are used on resistors. See also *Coil, Bucking*.

COIL, REACTANCE OF.—See *Reactance*.

COIL, RESISTANCE OF.—In considering the resistance of a coil used in a radio frequency circuit the principal concern is with its high frequency resistance which is generally quite different from its resistance to direct currents. High frequency resistance depends not only on the direct current or ohmic resistance of the wire, but also on skin effect and on distributed capacity.

In order to take these things into consideration in the comparison of radio coils it has been proposed that such coils should be rated according to their "circuit resistance." This circuit resistance would be equal to the coil's direct current resistance in ohms divided by the inductive reactance of the coil in ohms. With well designed coils this ratio will range between 0.003 and 0.0125 depending on the size of wire, the spacing and the wavelength or frequency being received. The value of this circuit resistance increases with decrease in

COIL, RESISTANCE OF

the size of wire. The circuit resistance for most coils is a minimum around 300 to 350 meters wavelength and increases for both lower and higher wavelengths.

The greatest single cause of resistance in a coil is the resistance of the wire with which it is wound. The resistance of the wire depends on its material, its length and its gauge or cross section. The material is always copper so that the factor of material may be neglected. The large sizes of wire, at least as large as number 20, should be favored when the size of the coil will allow their use. The

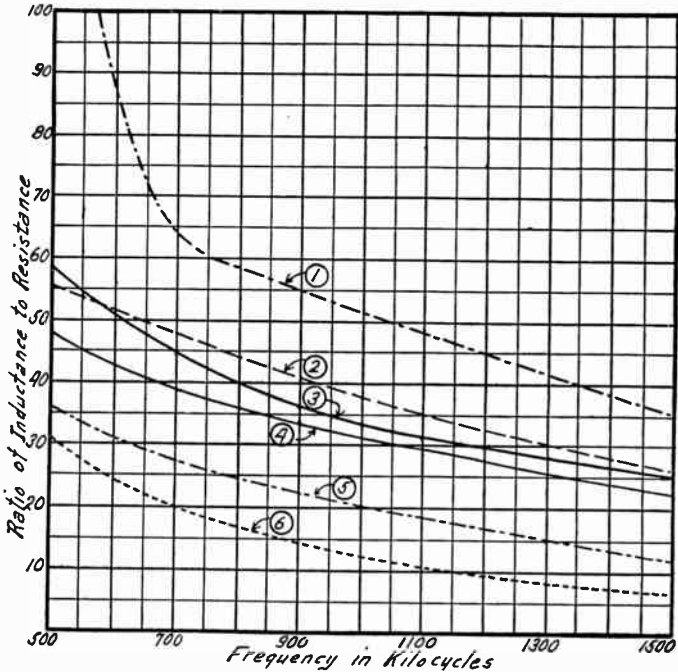

FIG. 1.—Ratio of Inductance to Resistance in Various Kinds of Coils.
 No. 1. Single Layer Coil with Litz Wire. No. 2. Basket Winding, Thin, Solid Wire. No. 3. Single Layer Winding on Hard Rubber, Solid Wire. No. 4. Spiderweb Winding on Hard Rubber Form, Solid Wire. No. 5. Basket Winding with Thick Walls, Solid Wire. No. 6. Honeycomb Coil.

length of the wire required for the needed inductance is the least important factor to be considered. It should be remembered that a plain cylindrical coil gives the greatest possible inductance per foot of wire used.

For wire sizes smaller than number 16 or number 18 the resistance increases as the size of the wire gets less but with larger wires the skin effect is more pronounced and more harmful. By actual experiment it is found that the combination of resistance and skin effect results in such a total of effective circuit resistance that there is practically no difference between wires of 20,

COIL, RESISTANCE OF

22, 24, 26 and 28 gauge at a frequency of 1000 kilocycles or a wavelength of about 300 meters. This applies to ordinary cylindrical single layer coils with double silk covered wire. At higher wavelengths or lower frequencies, there is a slight reduction of resistance when using the larger gauges, that is number 20 or 22 in place of 24, 26 or 28. Gauges as small as 32 and 34 show a decided increase of resistance over the other sizes at all frequencies.

All special winding forms such as basket weaves, spiderwebs, lattice windings, etc. increase the length of wire and the resistance. These special forms, however, reduce the distributed capacity and

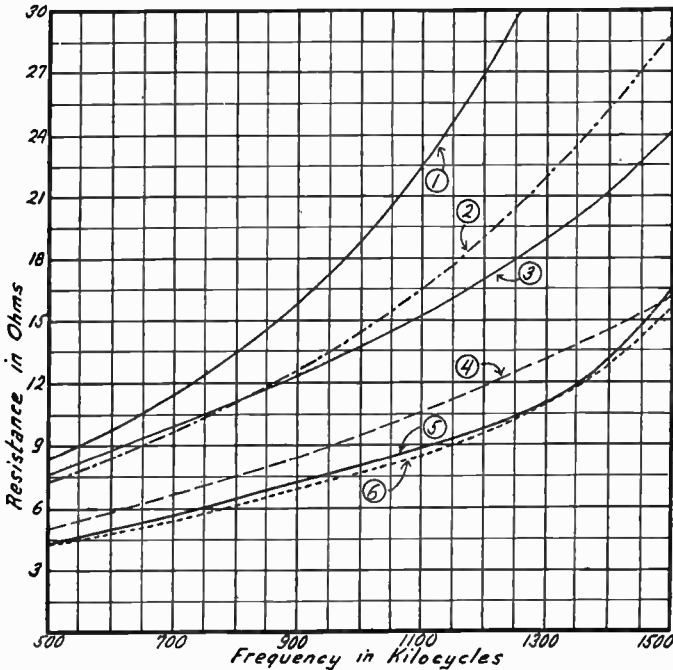

FIG. 2.—Change of Resistance with Change of Frequency in Coils.
 No. 1. Honeycomb Coil. No. 2. Two-Layer Bank Winding. No. 3. Basket Winding, Thin Walls. No. 4. Spiderweb Winding. No. 5. Single Layer Winding. No. 6. Basket Winding with Thick Walls.

skin effect so if they do not add too much to the length of wire the net result may be a decrease in the total effective resistance.

The effect of the form or the tubing on which the coil is wound is to show the greatest increase of resistance at high frequencies or low wavelengths. A form made of hard rubber or a skeleton form shows an advantage at high frequencies but loses most of this advantage at low frequencies.

The effective resistance of any coil increases with increase of frequency. This increase is due to the skin effect. A plain cylindrical coil wound with number 24 double cotton covered wire on a three-

COIL, RESONANCE WAVE

inch form will increase its resistance from 4.5 ohms at 600 kilocycles to 16.5 ohms at 1500 kilocycles. This rise of resistance with frequency for a typical single layer cylindrical coil, two basket wound coils and several other types, all of the same nominal inductance is illustrated in the curves of Fig. 2.

The effective inductance of any coil increases with increase of frequency because of the continual adding of the effect of distributed capacity. The effect of distributed capacity becomes greater and greater as the frequency becomes higher, resulting in an apparent increase of inductance. The total apparent inductance of the coil is called its effective inductance. The change of this effective inductance is illustrated in the curves under the heading *Coil, Inductance of*.

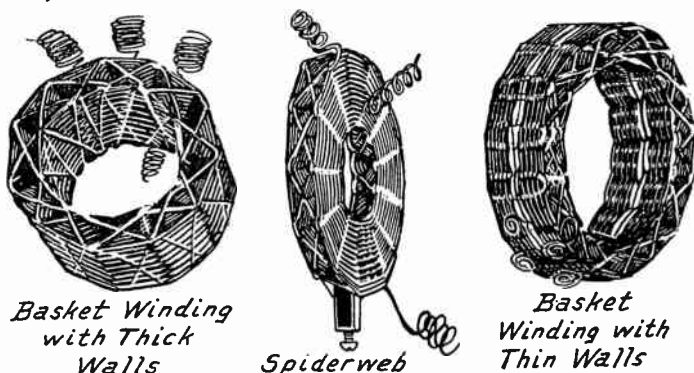

FIG. 3.—Types of Coils Showing Various Resistances.

It has been mentioned that radio coils might be compared with each other on a basis of circuit resistance. An equally effective comparison may be made on the basis of the ratio of inductance to resistance at some given frequency. A statement of the resistance in ohms without taking inductance into consideration might be very misleading. This will be realized when it is considered that a resistance of ten ohms in a coil of 300 microhenries inductance would be only half as bad as the same resistance in a coil of only 150 microhenries inductance. In Fig. 1 are shown the ratios of inductance in microhenries to resistance in ohms. The higher the ratio the better the coil from this standpoint. The measured resistances of different types of coils at broadcasting frequencies are shown by the curves in Fig. 2. All of the values shown by Figs. 1 and 2 are from reports of experiments made at the Government Bureau of Standards.

COIL, RESONANCE WAVE.—See *Antenna, Resonance Wave Coil Type*.

COIL, SEARCH.—See *Coil, Exploring*.

COIL, SHIELDING OF.—See *Shielding*.

COIL, SINGLE LAYER TYPE.—This is the form of coil most generally used in radio frequency circuits. It is wound on the outside of a form that is cylindrical or approximately cylindrical in shape. Except for the fact that the single layer cylindrical coil has a rather extensive field it is probably the most satisfactory for

COIL, SLIDE CONTACTS ON

regular work. It is easily constructed, mechanically strong, of good appearance, and its electrical characteristics are easily calculated.

COIL, SLIDE CONTACTS ON.—In place of bringing out leads from a coil and attaching them to a tap switch as described under the heading *Coil, Dead Ends In*, a sliding contact is sometimes used to accomplish the same result of using more or less of the winding on a coil. The slide contact is moved along a portion of the winding from which the enamel or other insulation has been removed, leaving a part of the wire in each turn bare so that the slider may make contact. The construction is shown in the illustration.

If the contact of the slider touches two turns at the same time, as it almost always does, one full turn is short-circuited. A large current will be induced in this shorted turn and this current will act against the current in the balance of the coil. This reduces the inductance and introduces a considerable loss or effective resistance in the coil thus constructed.

COIL, SOLENOID TYPE.—In its practical form a solenoid consists of a uniform spiral conductor forming a cylinder around either a straight or a curved axis. With current flowing in this

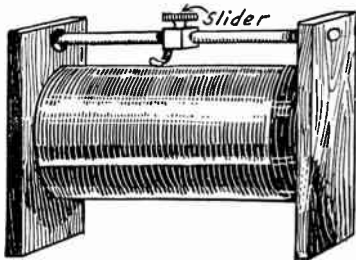

Coil with Slide Contact.



Space Winding on Single Layer Coil.

conductor the solenoid acts like a magnet, having a north and south pole. A single layer cylindrical coil is one form of solenoid.

COIL, SPACE WOUND.—Coils are often made with adjacent turns of their windings spaced at some distance from one another. A space wound cylindrical coil is shown in the illustration. It can be seen that there is a space between turns, the space in this case being about equal to the diameter of the wire.

Other forms of space wound coils include the basket-wound type, the spiderweb type and honeycomb coils. The purpose of any form of space winding is to reduce the distributed capacity in the coil. The capacity of any two conductors to each other is reduced as the conductors are separated more and more. When this practice is followed it is important to keep the leads which form the coil's terminals well separated from each other, especially where they run through solid insulators. If the leads from the space wound coil are brought out close to each other through a piece of insulation the capacity between them at this point will destroy much of the gain in the space winding. Spaced turns have little effect on distributed capacity except at high frequencies.

COIL, SPACING OF IN RECEIVER

Space windings may be made by running a piece of heavy string or cord onto the winding form along with the wire so that the cord lies between adjacent turns of wire. After the wire is secured at the ends of the winding the cord may be unwound and the wire turns fastened by applying binder or coil cement along the completed winding at several places about its circumference.

Space windings are also made by cutting or moulding threads on the surface of the winding form, the wire then being laid in the thread grooves. The number of threads per inch should be such that the separation between adjacent turns of winding is between ten-thousandths of an inch and the full diameter of the wire. Less separation than ten-thousandths will not accomplish much in reduction of distributed capacity.

COIL, SPACING OF IN RECEIVER.—Coils should be kept well separated from all other parts in the receiver and should be especially well separated from all metal parts. The larger the coil the larger will be its field and the greater should be the clear space left around it.

A properly spaced coil is shown in the drawing. As far as possible all other parts, whether of metal or of insulating material, should be kept out of a line drawn through the coil's axis. For instance, if a

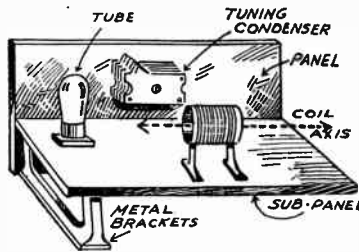

Coil with Proper Spacing Around All Sides.

coil is to be mounted near a condenser, the coil is placed so that its axis will not pass through the metal of the condenser.

Any coil, no matter how small, should have a clear open space of at least two inches all around it. As this distance is reduced to as low as one inch the resistance and losses in the coil circuit rise rapidly. A space of less than one inch at any point around a coil is exceedingly harmful and will probably result in lowered efficiency of the receiver.

It is almost impossible to mount coils in a receiver so that magnetic feed-backs are entirely avoided. The difficulty may be realized from the following: A coil placed so that it has no direct magnetic coupling with another coil may send its field lines of force through any nearby body of metal and thus set up eddy currents in the metal. The inductive effect of the eddy currents may be communicated to a second coil so that currents are set up in the second coil. There is then an indirect coupling between the two coils through the medium of the metal which may be the end plate of a condenser, a bracket or any other object. Couplings as great as ten per cent may be secured in this manner.

See also *Coil, Angle of Mounting*.

COIL, SPIDERWEB TYPE.—A spiderweb coil is formed of wire wound in such shape that the general appearance is that of a

COIL, SPIDERWEB TYPE

spider's web. Spiderweb coils may be wound on a form of flat fibre or hard rubber or on a form of cylindrical pegs as in Fig. 1.

The flat forms of Fig. 1 may be purchased ready made. They are usually one-sixteenth of an inch thick and with various numbers of radial spokes, the number, however, always being odd.

To wind the flat spiderweb the wire is fastened through a small hole which is left in the form, and is then woven back and forth between the spokes, passing on one side of one spoke and on the opposite side of the next spoke, around and around the form. When a sufficient number of turns have been placed on the form the outer end of the wire is fastened to the outer end of one of the spokes. The form is left in place.

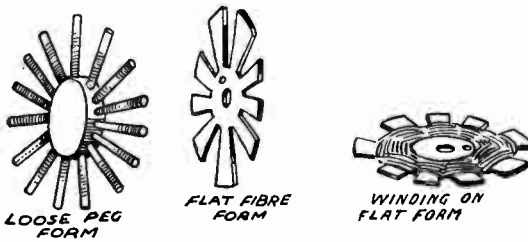

FIG. 1.—Forms for Spiderweb Coil Windings.

The spiderweb coil is compact and is easily constructed, also it has spaced turns to reduce the distributed capacity. Aside from these three features the spiderweb is not a desirable type of coil, principally because of the large amount of dielectric directly in the field of the coil.

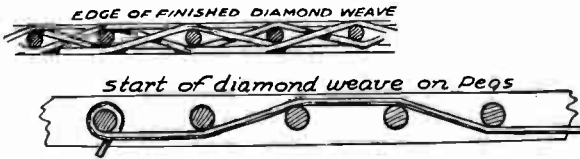

FIG. 2.—Method of Winding Diamond Weave Spiderweb Coil.

The spiderweb coil wound on the peg form is often called a diamond weave. It forms an efficient coil, doing away with the disadvantages of the flat spiral while retaining its advantages. The winding form consists of a central cylindrical disk having holes bored radially around its circumference. Into these holes fit cylindrical pegs either of wood or of metal. The number of pegs is always odd.

The construction of a diamond weave coil is shown in Fig. 2. The wire is fastened around one of the pegs to start with and as shown at the bottom of Fig. 2 the winding continues very much as with the basket weave coil, that is, over two pegs, under the next two, over the following two, and so on. The wire will build up so that its appearance from the edge is as shown at the

COIL, TAPPED

top of Fig. 2, this giving the diamond shaped appearance. When the winding has been completed it will appear from the side as in Fig. 3. The wire may be fastened in place by a thin line of coil cement run along the wires where they come together along the length of each peg. If it is desired to avoid the use of cement or binders, lacing may be run through the coil as shown in Fig. 3, this forming a very secure fastening.

With the winding completed and the wires secured either with lacing or cement, the pegs may be withdrawn. With the pegs out of the way the finished winding will slide off the center disk and form a self-supporting space wound coil of compact form, good efficiency and low resistance.



FIG. 3.—Lacing the Finished Diamond Weave Spiderweb Coil.

The inductance of a spiderweb coil is not very great for the length of wire required in its construction. This objection may be overcome by placing two spiderwebs close together with their axes in line and with the two windings connected to assist each other. The inductance of such a combination is from three to four times the inductance of one of the coils alone. While this method obtains great inductance it also increases the distributed capacity at the same time.

COIL, TAPPED.—It is sometimes necessary to make connections at various points along the winding of a coil so that less than

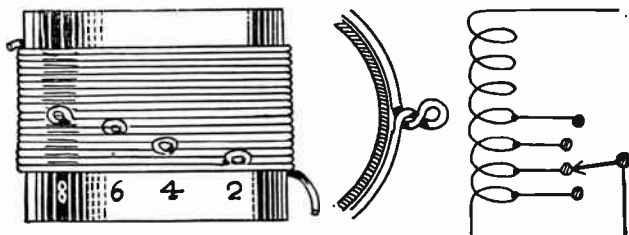

Construction of a Tapped Coil.

the whole coil may be used. The appearance and construction of a tapped winding are shown in the illustration. The coil shown has four taps, these being made at the second, fourth, sixth and eighth turns from the lower end. The taps are made by winding on a number of turns, then giving the wire a twist as shown at the right of the coil. The wire at the outer end of this twisted part or tap is bared of insulation and tinned so that an extension wire may be

COIL, TICKLER

soldered to it. The wiring symbol for a coil with four taps is shown at the right of the drawing. A coil should not be tapped unless it is absolutely necessary and if taps must be used the switch points to which the taps are secured are separated from each other as far as possible. See also, *Coil, Dead Ends in* and *Coil, Slide Contacts on*.

COIL, TICKLER.—A tickler coil is a coil electrically connected in one circuit and coupled to another circuit so that energy from the circuit in which the coil is connected may be introduced into the circuit to which the coil is coupled. A tickler coil is used as shown in Fig. 1 to secure a feedback of energy from the plate circuit of a tube to its grid circuit for the purpose of causing regeneration. The tickler coil is connected in the plate circuit and coupled to the grid coil of the tube.

Tickler coils may be of either the variable type or the fixed type. The variable type, as in Fig. 1, is mounted so that its magnetic coupling with the main coil may be changed; usually by rotating the tickler coil. The variable coupling might also be changed by sliding the tickler one way or the other.

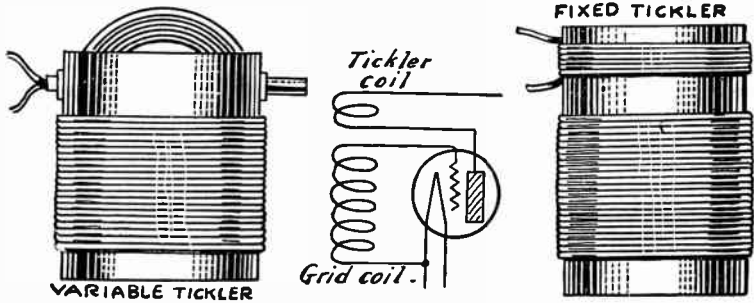

FIG. 1.—Connection of a Tickler Coil.

FIG. 2.—Fixed Tickler Coil.

The fixed tickler coil shown in Fig. 2 is not movable in relation to its main coil. The effect of the tickler, or its effective coupling, is then controlled by a variable condenser or variable resistance, thus giving a capacitive or resistance control of feedback and regeneration. See *Regeneration, Methods of Obtaining*.

COIL, TOROIDAL.—See *Coil, Closed Field, Toroid*.

COIL, TUNING, SIZES REQUIRED FOR.—It is highly desirable to know how many turns of wire will be required on a form of given size to be used in connection with a tuning condenser of given capacity and with a certain gauge or size of wire employed for the winding. As explained under the heading of *Coil, Inductance of* the calculation of this problem is rather long drawn out and requires the employment of a formula including the varying elongation factor "K." In the following tables this information is given in a readily usable form without the necessity for further calculation.

These tables assume the use of properly constructed coils and of condensers of an actual capacity at least approximating their rated or listed capacity. The coils specified are calculated so that about

COIL, TUNING, SIZES REQUIRED

ninety to ninety-two per cent of the total condenser capacity will be in use when the lowest broadcasting frequency (highest wavelength) is being received. This highest wavelength (545.1 meters) should come in when the dial of a straight line frequency condenser is set at 96 or 97; when the dial of a straight line wavelength condenser is at about 94 or 95; and when the dial of a straight line capacity condenser is set at 90 to 92. All of these settings are for a dial graduated from "0" to "100" as the condenser capacity changes from minimum to maximum.

Coils are listed for five different capacities of condenser, the capacities being given in microfarads in the tables. The .00025 microfarad condenser is of 250 micro-microfarads capacity and usually has from eleven to fourteen plates. The .0003 microfarad condenser is of 300 micro-microfarads capacity and usually has fifteen plates. The .00035 microfarad condenser is of 350 micro-microfarads capacity and has seventeen plates as a general rule. The .0005 microfarad condenser has 500 micro-microfarads capacity and corresponds

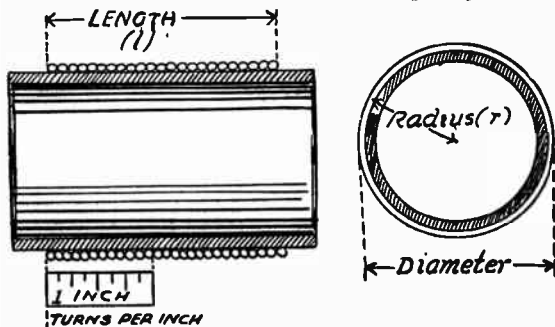

Measurements of Tuning Coil Windings for Calculation of Inductance.

to the twenty-three plate size of most manufacturers. The .001 microfarad condenser has a capacity of 1000 micro-microfarads and is the usual forty-three plate size.

The approximate inductances in microhenries allowed for each condenser capacity are as follows: For the .00025 microfarad condenser, 370 microhenries. For the .0003 microfarad condenser, 310 microhenries. For the .00035 microfarad condenser, 265 microhenries. For the .0005 microfarad condenser, 185 microhenries. For the .001 microfarad condenser, 90 microhenries.

The following should be noted in using these coil sizes:

Many condensers have an actual capacity greater than their nominal or rated capacity so that the coil will be too large. A few condensers have an actual capacity smaller than their rating, in which case the coil will be too small.

The diameter of the coil winding is, as shown in the diagram, the mean diameter to the center of the cross section of the wire used and is larger than the outside diameter of the form on which the winding is made. Thus, a coil wound on the outside of a tube whose outside diameter is three inches would have a coil winding diameter slightly

COIL, TUNING, SIZES REQUIRED

greater than three inches, the difference depending on the size of wire being used.

The inductance values assume that the turns are close wound. If they are loose and slightly spaced from each other the inductance in microhenries will be too small and the coil will appear to be too small. The number of turns per inch with the turns properly placed is given in each table; this factor affecting the total length of the coil. The length of the winding affects its inductance.

High distributed capacity caused by poor dielectric as insulation on the wire will increase the apparent inductance of the coil and will make the coil too large for the work. Such an increase of distributed capacity would take place when using enamelled wire.

Another winding closely coupled to the tuning coil will increase the apparent inductance of the tuning coil and will cause the coil to seem too large. This is especially true when the antenna is closely coupled to the tuning coil by having the antenna coil wound directly over the tuning coil.

If the high wavelength (low frequency) stations are tuned in at dial readings that are too high it indicates that the tuning coil is too small and turns must be added.

If these high wavelength stations are tuned in at dial readings that are too low it indicates that the coil is too large and turns should be removed.

The highest wavelengths, 535.4 and 545.1 meters, should come at least as high as "90" on the dial because the receiver is more efficient when using as much as possible of the condenser capacity. Coil adjustments should not be made on low wavelength (high frequency) stations but on the highest possible wavelength.

The dial must be attached to the condenser so that the dial reading is "100" or maximum when the condenser plates are fully in mesh, with the condenser at its maximum capacity.

The first six tables cover the use of double cotton covered wire of the several commonly used gauge sizes from No. 20 to No. 30 inclusive. The remaining tables are calculated for the use of double silk covered wire in similar gauge sizes.

The table for each wire gauge has columns for generally used winding form diameters from two inches up to four inches. At the left hand side of the table are listed the condenser capacities which may be used for tuning. Having decided upon the wire's insulation and size, on the diameter of the winding and the capacity of the tuning condenser, the required number of turns may be determined from the table which applies.

As an example, it may be desired to use No. 22 double cotton covered (D. C. C.) wire on a 3-inch diameter winding to be tuned with a condenser of .0005 microfarad capacity. In the second table, under the 3-inch heading, and opposite the capacity of .0005 microfarad it is found that 50 turns of wire will be required to tune to resonance over the broadcasting frequencies.

Other tables are given under *Receiver, Short Wave*.
See also *Resonance, Inductance-Capacity Values for*.

COIL, TUNING, TURNS REQUIRED

No. 20 D. C. C. Wire—23.5 Turns per Inch

<i>Condenser Capacity in Mfds.</i>	<i>Diameter of Coil Winding</i>						
	2"	2½"	2¾"	3"	3¼"	3½"	4"
.00025	166	121	103	93	87	77	68
.0003	143	103	89	79	74	68	59
.00035	126	91	79	71	66	61	53
.0005	93	68	60	54	50	46	40
.001	53	41	37	34	31	28	25

No. 22 D. C. C. Wire—28 Turns per Inch

<i>Condenser Capacity in Mfds.</i>	<i>Diameter of Coil Winding</i>						
	2"	2½"	2¾"	3"	3¼"	3½"	4"
.00025	141	107	94	84	79	72	60
.0003	116	92	81	72	67	62	53
.00035	108	82	72	65	60	56	48
.0005	82	61	55	50	46	43	38
.001	50	38	34	31	29	27	24

No. 24 D. C. C. Wire—33 Turns per Inch

<i>Condenser Capacity in Mfds.</i>	<i>Diameter of Coil Winding</i>						
	2"	2½"	2¾"	3"	3¼"	3½"	4"
.00025	132	98	87	78	72	66	49
.0003	114	86	75	68	63	58	44
.00035	101	76	67	62	57	53	41
.0005	76	59	52	47	44	41	34
.001	45	35	32	30	28	26	23

No. 26 D. C. C. Wire—38.25 Turns per Inch

<i>Condenser Capacity in Mfds.</i>	<i>Diameter of Coil Winding</i>						
	2"	2½"	2¾"	3"	3¼"	3½"	4"
.00025	121	89	80	72	67	62	53
.0003	114	78	70	64	59	54	46
.00035	93	70	63	57	52	48	42
.0005	70	53	49	45	41	39	35
.001	43	34	31	29	27	25	22

COIL, TUNING, TURNS REQUIRED

No. 28 D. C. C. Wire—43.75 Turns per Inch

<i>Condenser Capacity in Mfds.</i>	<i>Diameter of Coil Winding</i>						
	2"	2½"	2¾"	3"	3¼"	3½"	4"
.00025	112	88	75	70	66	61	53
.0003	97	74	67	61	58	54	46
.00035	87	67	60	56	53	49	42
.0005	67	53	48	44	41	38	33
.001	41	33	30	28	26	24	21

No. 30 D. C. C. Wire—49.5 Turns per Inch

<i>Condenser Capacity in Mfds.</i>	<i>Diameter of Coil Winding</i>						
	2"	2½"	2¾"	3"	3¼"	3½"	4"
.00025	105	80	73	67	62	58	50
.0003	92	71	65	60	55	51	45
.00035	82	65	58	53	49	46	41
.0005	63	50	45	42	39	36	32
.001	39	32	28	26	24	23	20

No. 20 Double Silk Covered Wire—27.5 Turns per Inch

<i>Condenser Capacity in Mfds.</i>	<i>Diameter of Coil Winding</i>						
	2"	2½"	2¾"	3"	3¼"	3½"	4"
.00025	150	108	96	86	80	76	67
.0003	128	93	83	74	69	65	58
.00035	113	82	73	66	61	58	52
.0005	84	62	56	51	47	45	40
.001	48	39	35	32	30	28	25

No. 22 Double Silk Covered Wire—33.75 Turns per Inch

<i>Condenser Capacity in Mfds.</i>	<i>Diameter of Coil Winding</i>						
	2"	2½"	2¾"	3"	3¼"	3½"	4"
.00025	130	96	85	76	71	66	56
.0003	112	83	75	67	62	58	50
.00035	99	75	67	61	56	52	45
.0005	75	58	51	47	44	40	35
.001	45	35	32	30	28	26	23

COIL, TUNING, TURNS REQUIRED

No. 24 Double Silk Covered Wire—41 Turns per Inch

<i>Condenser Capacity in Mfds.</i>	<i>Diameter of Coil Winding</i>						
	2"	2½"	2¾"	3"	3¼"	3½"	4"
.00025	116	87	77	71	65	60	56
.0003	99	76	67	63	57	53	46
.00035	89	68	61	56	51	47	42
.0005	68	53	47	44	41	38	34
.001	41	33	30	28	26	25	22

No. 26 Double Silk Covered Wire—49.5 Turns per Inch

<i>Condenser Capacity in Mfds.</i>	<i>Diameter of Coil Winding</i>						
	2"	2½"	2¾"	3"	3¼"	3½"	4"
.00025	105	83	71	66	62	57	50
.0003	91	72	63	59	55	50	45
.00035	82	64	57	53	49	46	41
.0005	63	48	45	43	40	37	33
.001	40	34	30	28	26	24	21

No. 28 Double Silk Covered Wire—59.25 Turns per Inch

<i>Condenser Capacity in Mfds.</i>	<i>Diameter of Coil Winding</i>						
	2"	2½"	2¾"	3"	3¼"	3½"	4"
.00025	96	75	66	61	59	54	48
.0003	82	65	59	55	52	48	42
.00035	64	59	54	51	47	43	38
.0005	57	46	42	40	37	34	30
.001	36	29	26	24	22	21	18

No. 30 Double Silk Covered Wire—70 Turns per Inch

<i>Condenser Capacity in Mfds.</i>	<i>Diameter of Coil Winding</i>						
	2"	2½"	2¾"	3"	3¼"	3½"	4"
.00025	88	72	65	60	55	50	45
.0003	76	63	57	51	48	44	39
.00035	68	57	50	47	44	40	35
.0005	55	45	40	37	34	31	28
.001	35	28	26	23	21	20	18

COIL, TURNS PER INCH

COIL, TURNS PER INCH.—See *Wire, Turns per Inch*; also *Coil, Choke*.

COIL, TYPES, RELATIVE MERIT OF.—See *Coil, Design*.

COIL, WINDING OF.—See *Winding, Coil, Methods of*.

COIL, WIRE FOR.—In considering the wire with which a coil is to be wound four things are to be thought of. First comes the size or gauge of the wire, then the kind of insulation, next whether the wire is to be solid or stranded and finally the material of the conductor.

As a general rule wire sizes between number 20 and number 24 are most satisfactory. Wire sizes larger than number 20 are needed only on short wave reception. Wire smaller than number 24 should be used only when the size of the finished winding needs to be small, because there is a considerable increase of resistance in the smaller sizes. Of course it must be remembered that the smaller the actual size of the wire the larger will be the gauge number that designates it. Wire of sizes larger than number 18 gauge should never be used in close wound coils because of the high eddy current losses. If larger sizes are used the coil must be space wound.

As far as the insulation is concerned, double cotton covered is probably most satisfactory for all around use when the size of the finished coil is not of great importance. The double cotton covering provides good spacing between turns, reducing the distributed capacity, and the cotton is a good dielectric. Double silk covered wire has a thinner insulation and allows a greater distributed capacity than double cotton. Furthermore silk is not as good a dielectric as cotton. To offset these disadvantages of silk it makes a much smaller coil for a given inductance, consequently has a smaller field with less liability of back coupling. Double silk covered wire will generally make a more permanent job than cotton covering because the silk does not absorb moisture as readily as does cotton and corrosion of the conductor itself is less with silk covering.

Enamelled wire is not satisfactory for use in coils of radio frequency circuits. The enamel is a poor dielectric and it is so thin that coils wound with enamelled wire have a large distributed capacity. Cotton enamel wire is satisfactory because the enamel underneath the cotton makes the insulation moisture proof and the additional thickness of the cotton gives sufficient spacing to reduce distributed capacity.

Single cotton covered or single silk covered wires are not desirable because they provide too little spacing between turns and there is too much likelihood of baring the conductor through the thin insulating covering.

A satisfactory wire for a bulky coil winding is white covered annunciator wire. The cotton covering is so thick that it gives a spaced winding and the wax in the covering prevents corrosion. Do not use colored annunciator wire. This wire winds 16 turns to an inch and it is of number 18 gauge.

Copper is the only material used or considered for the conductor in radio coils. Space wound cylindrical coils are sometimes wound with bare copper wire laid in spirally threaded grooves around the winding form. The disadvantage of bare wire is that its surface

COIL, WIRE FOR

corrodes badly within a short time. Because of skin effect a large part of the high frequency currents flow in the surface layers of the wire. The resistance of the corrosion is high and such coils therefore become inefficient after a short time. This difficulty may be avoided by using copper wire that has a thin plating of gold. Plated wire of this kind is quite inexpensive. A wire of solid silver would have a lower direct current resistance than a wire of copper having the same gauge. The percentage of gain in direct current conductivity would not hold good at high frequencies so that the expense of the solid silver wire would not be warranted.

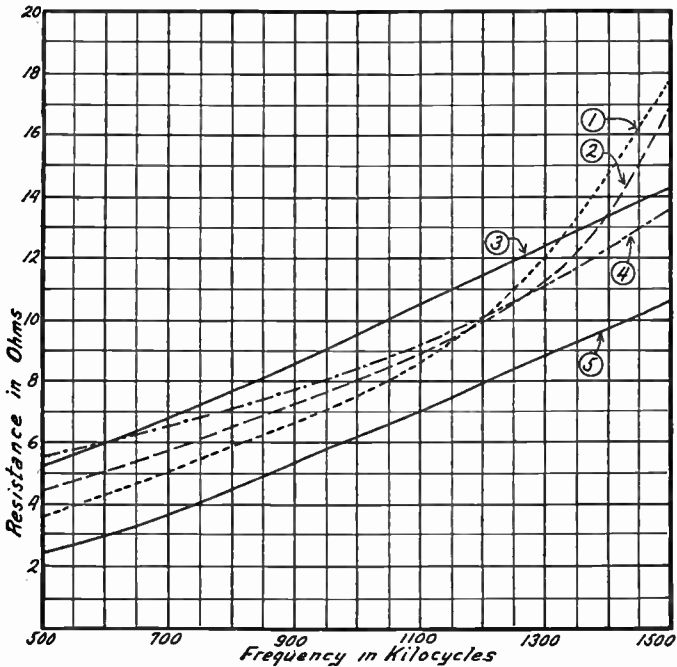

Effect of Wire Size on Coil Resistance at Different Frequencies.

No. 1. 16 gauge. No. 2. 24 gauge. No. 3. 28 gauge.
No. 4. 28 gauge, space wound. No. 5. 32-38 gauge.

Solid conductor is used in almost all of the wire in radio work. A form of stranded wire called "Litzendraht" is sometimes used for coil winding. For a discussion of its advantages and disadvantages see *Wire, Stranded*; also *Resistance, High Frequency*.

The effect on high frequency resistance of using different sizes of wire for coil windings is shown in the curves. All of the coils are of the single layer type wound on hard rubber forms. It will be seen that the larger sizes of wire show greater effective resistance than the small sizes at high frequencies. At the lower frequencies the condition is completely reversed and the large wire has the advantage.

COIL, WIRE SPECIFICATIONS FOR.—See *Wire, Copper*.

COLLODION

COLLODION.—See *Binders*.

COLOR OF WIRES.—See *Wiring, Receiver*.

COMPASS, RADIO.—A radio compass consists essentially of a receiver mounted in a completely shielded cabinet and equipped with a directional loop as shown in Fig. 1. The receiver is not affected by radio waves or signals except those coming through the

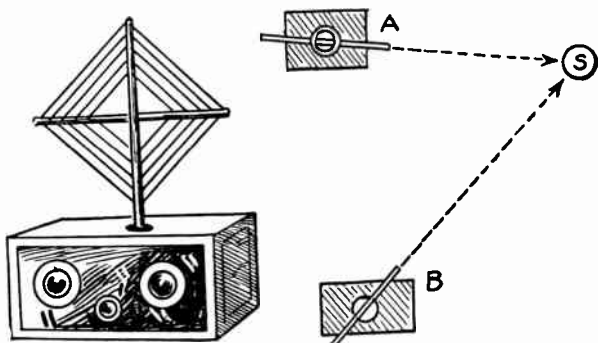

FIG. 1.—Elementary Principle of Radio Compass.

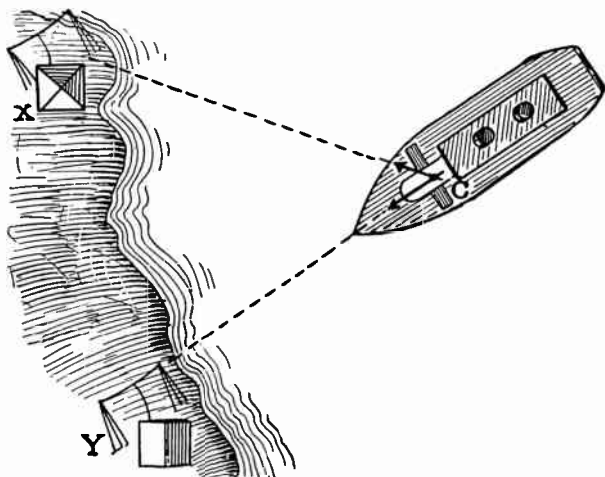

FIG. 2.—Determining Ship's Position with Radio Compass.

loop. By turning the loop it is possible to tell from which direction of the compass a signal is coming.

A transmitting station as at *S* in Fig. 1 may be located as to position with the aid of such a receiver. The receiver is tuned in on the station from two or more positions and the bearing of the loop is noted in each case. At the intersection of the bearings, such as those

COMPRESSION CONDENSER

taken from positions *A* and *B* in the illustration, the location of the transmitter may be determined.

For use on shipboard the radio compass is in the form of a large loop carried usually above the pilot house of the ship. Compass signals are transmitted from two or more shore stations. These signals are distinguished from each other as received by the ship. The location of the shore stations is known to the navigators and the ship's position with reference to the shore stations may be determined. Such a position finding method is illustrated in Fig. 2, the ship's radio compass being designated as *C* and the shore stations as *X* and *Y*.

A form of apparatus used for locating transmitting stations uses a portable receiver, and is often called a radio direction finder although its principle is exactly the same as that of the radio compass. See also *Beacon, Radio* and *Goniometer*.

COMPRESSION CONDENSER.—See *Condenser, Variable*.

CONDENSER, ACTION OF.—All radio circuits consist principally of capacity, inductance and resistance as shown in Fig. 1. Capacity is the property of two electrical conductors, when separated by insulation or a dielectric, to receive and retain elec-

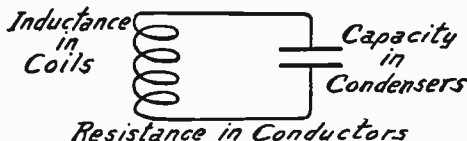

FIG. 1.—The Elements of a Radio Circuit Containing a Condenser.

tricity. Inductance is the property of conductors by which voltage and current are produced in them by movement of electromagnetic lines of force through the conductors. Resistance is the opposition to flow of electric current in conductors.

Inductance is found principally in the coils. Resistance is found in all conductors. The condenser is a device intended to have ca-

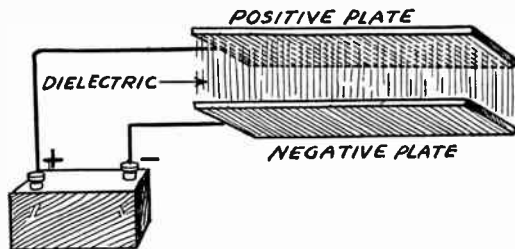

FIG. 2.—The Plates and Dielectric of a Condenser.

capacity only. Electricity flows into the conductors or plates of the condenser, forming what is called the condenser's charge, and remains there until released.

A condenser consists of two principal parts, considered from the electrical standpoint. One of these parts is formed by metal plates which receive and hold the charge. The other part is the dielectric

CONDENSER, ACTION OF

or insulation which separates the plates and is between them. The dielectric may be air, mica, paper, glass, oil or any other electrical insulator. The dielectric is whatever is between the plates. This is shown in Fig. 2.

There are two kinds of plates, positive and negative. In construction they are usually similar to each other. A condenser may consist of only two plates, one positive and one negative, or it may consist of many plates as in Fig. 3. Approximately half will be positive and the other half negative. All positive plates are connected with each other and all negatives are connected together. This makes all the positive plates the equivalent of one large plate and makes the negatives the equivalent of a second large plate.

Charge of Condenser.—When a source of electricity or electrical pressure is connected to a condenser with the positive side of the source connected to one set of plates and the negative of the source connected to the other set of plates, the condenser will be charged. That means, the electricity will flow from the positive of the source into the positive plates attached to it. There will be a flow of negative electricity away from the condenser plates connected to the negative of the source. The positive plates are then at a higher electrical pressure than are the negatives.

With one of the plates or sets of plates at a positive voltage or potential and the other at a negative voltage or potential, there is what we call an electrostatic pressure or strain placed on the dielectric between the plates. In this strained condition the dielectric stores electrical energy.

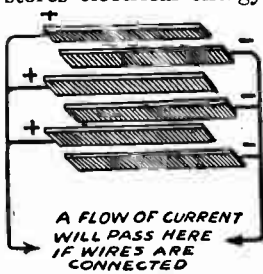

FIG. 3.—A Condenser May Have Many Plates.

The condition is much the same as if a piece of elastic rubber were either compressed or stretched out between pieces of metal. The strain thus put upon the rubber would cause it to store or contain mechanical energy. This energy in the rubber would tend to return the metal pieces to their original positions as soon as the strain was relieved. The electrostatic strain set up in the material of the dielectric does likewise; tends to return the plates to their original condition of no voltage difference as before receiving the charge.

After a condenser absorbs a certain amount of charge with a certain impressed voltage it will take no more and the flow of current ceases. If the source is then disconnected from the condenser plates and nothing else is connected between them the charge will remain on the plates. If a wire or any other electrical conductor is now connected between the plates of the condenser they will discharge and there will be a flow of current from the positive to the negative plates through the conductor.

The capacity, also the amount of charge the condenser holds depends on the four things shown in Fig. 4. First, the higher the voltage used to charge the condenser the more electricity it will hold. Second, the larger the area of the

CONDENSER, ACTION OF

plates and the greater the number of plates, the more electricity will be held. Third, the closer the plates are to each other, that is, the closer together are the positive and negative plates, the greater will be the charge. Fourth, certain kinds of dielectric allow the condenser to hold a greater charge than other kinds. For instance a condenser using mica for a dielectric will take more than twice the charge of a condenser otherwise exactly alike but using paper for a dielectric. The relative value of dielectrics is called their dielectric constant and is indicated by the capital letter "K." See *Constant, Dielectric*. The thickness of the plates has no effect on capacity.

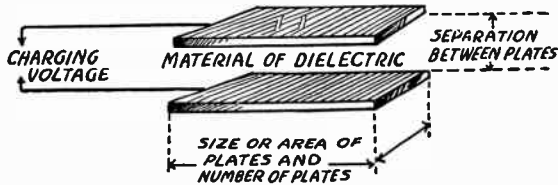

FIG. 4.—The Four Factors Affecting a Condenser's Charge.

The charge of a condenser is measured in the unit of electrical quantity called the coulomb. One coulomb is the amount of electricity that flows through a circuit in one second when the rate of flow is one ampere. The condenser's charge in coulombs is equal to the number of volts applied to the condenser terminals multiplied by the capacity of the condenser in farads. See *Condenser, Capacity of*.

Stray Capacities.—From the explanation of a condenser just given it is easy to realize that any two electrical conductors separated by air or any other dielectric form a condenser. All wires in a radio receiver have capacity to each other, in other words, form an active condenser if they are at different alternating voltages. See *Capacity, Distributed*. A ball of metal as small as one inch in diameter has a measurable capacity to the walls of an ordinary room. A radio set is literally full of all kinds of small stray capacities which cannot be eliminated, although all radio work would be simplified beyond measure were such a thing possible.

In a condenser as actually constructed, in addition to the metal forming the plates, at least a part of the support for the plates is usually of metal. The insulating material between the plates forms the dielectric and does the useful work of the condenser, but other insulation is used for supporting and fastening together the various parts of the condenser and for insulating the positive plates from the negative plates.

Current Flow Through a Condenser.—Certain materials are known to be good insulators. For instance, a wire surrounded by a covering of silk or cotton is considered as being insulated from another nearby wire similarly covered. This is perfectly true of direct currents but not of alternating currents. When a current alternates its effect will pass through a condenser. The alternating current in house lighting systems has a very low frequency, usually only sixty cycles per second and such a low frequency is easily insulated. But in radio work we deal with frequencies running into the millions per second and electric currents at such tremendously high frequencies cannot be fully insulated.

CONDENSER, ACTION OF

If one end of a high frequency electric circuit is connected to one side of a condenser and the other end of the circuit is connected to the other side of the condenser, the condenser plates will absorb the positive voltage peaks during one alternation and will be discharged by the following negative alternation. A large condenser will absorb a large charge during each alternation and under such conditions the rapid charge and discharge of the condenser plates allows the effect of the current to pass right through the condenser.

This action may be understood by reference to Fig. 5 which shows a hydraulic comparison to an electric condenser. This illustration shows a reciprocating water pump whose piston moves up and down.

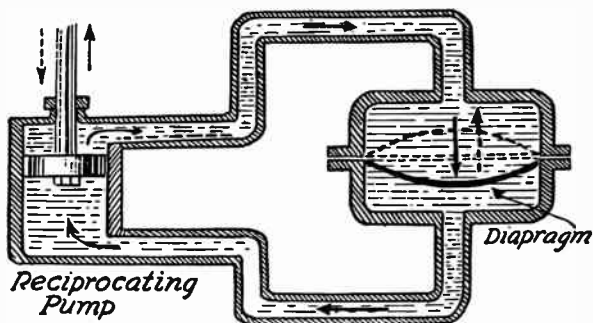

FIG. 5.—Hydraulic Explanation of Condenser Action.

This pump is connected through a circuit of water pipes to both sides of a hollow chamber containing a flexible rubber diaphragm. With movement of the pump piston upward, as shown by the full line arrows, the flow of water through the circuit will be in the direction of the full line arrows and the diaphragm will be stretched downward as shown. Upon the reverse motion of the piston, as shown by broken line arrows, the direction of water flow is reversed and the diaphragm is stretched upward. The motion of the water back and forth in the chamber is apparently carried right through the diaphragm, although no water actually passes through and only the effect is transmitted.

In Fig. 6 is an electric circuit containing an alternating current generator which sends electric current first one way, then the other way; just as the reciprocating water pump sends water first one way, then the other. The plates of the condenser are represented by the top and bottom halves of the chamber in the water circuit of Fig. 5 and the dielectric of the condenser is represented by the diaphragm in the chamber.

In the water circuit the pump places a strain on the diaphragm and the diaphragm then contains energy which would do the work of sending water through the circuit were the pump removed. In the electric circuit the generator places the condenser's dielectric under an electric strain and the energy then stored in the dielectric

CONDENSER, ADJUSTABLE

would send a flow of electric current through an external circuit were the generator disconnected.

Condensers always may be thought of as passing alternating current. They are not insulators for alternating current as for direct current. The greater the condenser capacity the more easily the alternating current effect passes through and the smaller the condenser capacity the harder it is for the alternating current to pass through it.

The higher the frequency of the current being handled the more easily it will pass through a condenser of given size or capacity. Also the more easily it will pass from one conductor to another, from one metal part to another when these parts are near each other. The radio frequency currents received by the antenna and carried through the receiver as far as the detector are at extremely high frequencies, consequently pass through condensers or between conductors very easily. The audio frequency currents from the detector to the loud speaker or headphones are at much lower frequency and their escape from one conductor into another is more easily prevented.

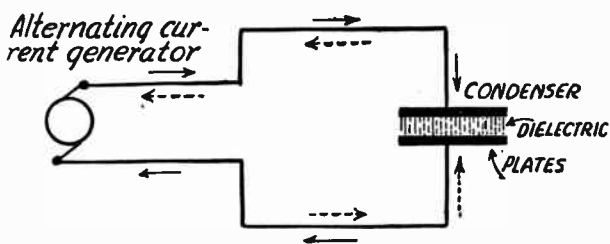

FIG. 6.—Flow of Alternating Current Through a Condenser.

The higher the frequency of the current the smaller need be a condenser that will pass a given amount of current through its circuit. The lower the frequency the larger will be the condenser required to allow the same amount of current to pass through. Direct current will not pass through a condenser at all.

See also *Induction, Electrostatic.*

CONDENSER, ADJUSTABLE.—See *Condenser, Variable.*

CONDENSER, AIR TYPE.—See *Condenser, Dielectric for.*

CONDENSER, ANTENNA.—A condenser connected in shunt or parallel with the antenna, by attaching it between the antenna binding post and the ground binding post on the receiver, is called an antenna shunting condenser and will allow the antenna circuit of the receiver to be tuned to higher wavelengths or lower frequencies.

A condenser connected in series with the antenna by attaching it between the antenna lead-in and the antenna binding post of the receiver is called an antenna series condenser and it will allow the antenna circuit to be tuned to lower wavelengths or higher frequencies. These effects may be understood from Figs. 1, 2 and 3.

Fig. 1 shows an antenna and ground with an inductance coil of a receiver connected between them in the ordinary way. Since the antenna and the ground form the two plates of a condenser, this circuit may be represented as at the right hand side of Fig. 1; this being an equivalent circuit.

CONDENSER, ANTENNA

In Fig. 2, at the left, is shown the connection of a parallel or shunting antenna condenser P between the antenna A and the ground G . The equivalent circuit is shown at the right of Fig. 2 where the condenser formed by antenna and ground is represented by the condenser whose plates are marked A and G .

It will be seen that the condenser $A-G$ is in parallel with the condenser P . Two condensers in parallel add their capacities together

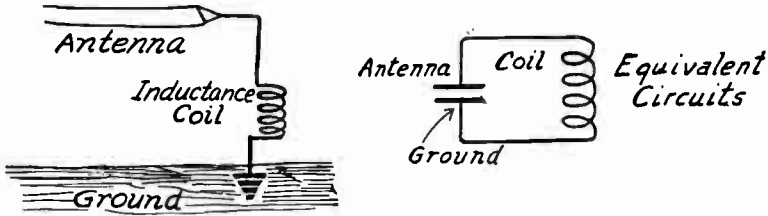

FIG. 1.—The Usual Outdoor Antenna Acts as a Condenser.

and this greater total capacity across the coil will allow resonance or tuning at lower frequencies or higher wavelengths.

In Fig. 3 is shown, at the left, an antenna series condenser S between the antenna and the inductance of the receiver. The equivalent circuit is shown at the right, the condenser with plates A and G representing the capacity of the antenna and ground while the condenser S represents the antenna series condenser. Now it will be seen that the two condensers $A-G$ and S are in series with each

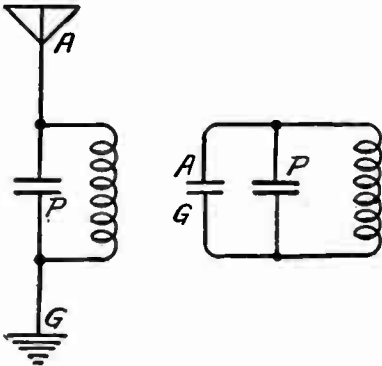

FIG. 2.—Connection of Parallel or Shunting Antenna Condenser.

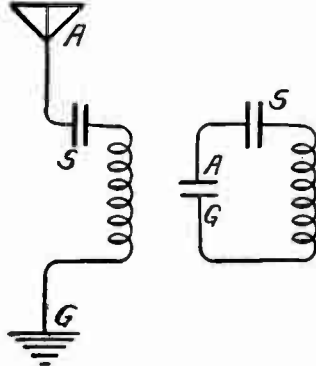

FIG. 3.—Connection of Series Antenna Condenser.

other. Any two condensers in series have a combined capacity less than the capacity of either one alone, therefore this lessened capacity used with the coil allows resonance or tuning at higher frequencies or lower wavelengths.

A receiver which cannot be tuned to the higher wavelengths may be helped by placing a small additional condenser (usually smaller than .00025 micro-

CONDENSER, BALANCING

farad capacity) from antenna terminal to ground terminal as in Fig. 2. A receiver which cannot be tuned to the lower wavelengths may have a fairly large condenser (.0001 to .0005 microfarad capacity) connected between the antenna lead-in and the antenna terminal of the set as in Fig. 3. It should be borne in mind that this expedient will help only the first tuned circuit in the receiver, the one coupled to or connected with the antenna. It will not help the other tuned circuits of a receiver using several tuned radio frequency stages. See also *Antenna, Tuning of*.

A single condenser, either variable or fixed, may be so connected that it can be placed first in series and then in parallel with the antenna. Such connections are shown under *Jacks and Switches, Uses of*, and under *Switch, Series-Parallel*.

CONDENSER, BALANCING.—A condenser used to balance the feedback effect of the capacity between the grid and plate of a tube is called a balancing condenser. A condenser used for this work is sometimes called a neutralizing condenser because it is used to neutralize the effect of the grid to plate capacity in the tube. See *Balancing*.

CONDENSER, BLOCKING.—See *Condenser, Stopping*.

CONDENSER, BYPASS.—A bypass condenser is a condenser which allows alternating or high frequency currents to pass around or away from parts through which the current should not flow. These parts may be of high impedance to such currents or they might produce coupling effects due to resistance or impedance.

In any radio receiver there are, among others, two circuits which it is especially desired to keep complete in themselves and separate from all other circuits. These two are the plate circuit and the grid circuit of each tube. These circuits are described under *Circuit, Grid* and *Circuit, Plate*.

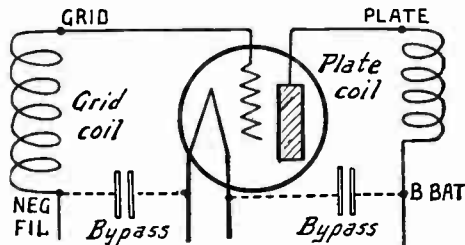

FIG. 1.—Grid Circuit and Plate Circuit Bypass Condensers.

Fig. 1 shows a vacuum tube with its plate circuit and its grid circuit completed through a plate bypass and a grid bypass condenser respectively. The complete grid circuit without the bypass condenser would pass not only through the grid coil, but also through a C-battery, rheostats, an A-battery and other parts. If any of these parts are also used in the circuits of other tubes as well as in the circuit of the tube being considered, then there will be the possibility of undesirable feedbacks and couplings which tend to produce distortion and to prevent the proper control of oscillation and regeneration. By the insertion of a grid bypass condenser as shown the grid circuit is completed directly from the return end of the grid coil to the filament of the tube so that the high frequency voltages affecting the grid find a complete circuit through the coil and the bypass without going through any of the other parts just mentioned. The chance of couplings and feedbacks is thus reduced to a minimum or eliminated.

CONDENSER, BYPASS

The plate circuit without the bypass condenser would be completed through the B-battery or other source of plate voltage back to the filament and this battery or voltage source would undoubtedly be used for other tubes as well as for the one considered. But here again, by connecting a condenser between the return end of the plate coil and the tube's filament, the plate circuit is completed for the high frequency currents without their having to pass through any other parts than those shown.

The grid bypass is connected from the negative filament terminal of the tube (usually marked —) to the grid return of the same tube, which may be a terminal of any coupling unit such as a radio frequency transformer, an antenna coupler, an audio frequency transformer, a choke, a resistance or whatever unit is used in the receiver. The plate bypass is connected from either the negative or positive filament terminal of the tube to the plate return of the same tube, which is the B-battery terminal of any of the coupling units just mentioned. This does away with the need of separate bypass condensers for batteries, rheostats, potentiometers, etc., since both plate and grid circuits have thus been completed independently.

Of the two bypasses, grid and plate, the plate condenser is of greater usefulness provided both kinds are not used. A plate bypass will greatly improve the quality of reception from any receiver. These bypasses as described should

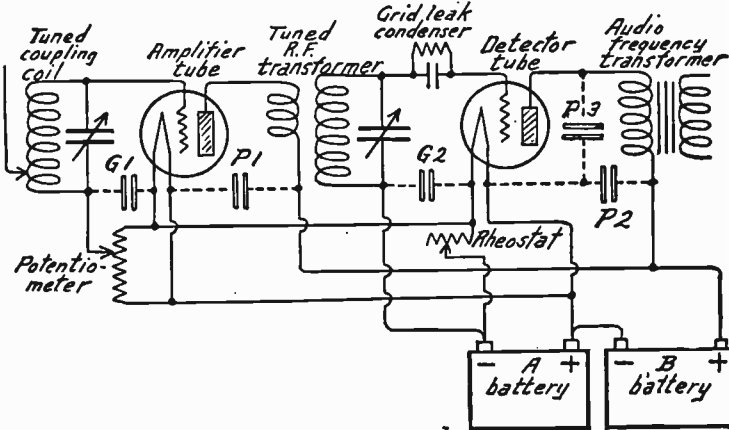

FIG. 2.—Bypass Condensers in a Receiver.

be used on all amplifier tubes, both radio frequency and audio frequency types, but the connection for the detector tube is slightly different as shown in Fig. 2.

Fig. 2 shows many of the parts and circuits of a complete receiver up to the detector tube and shows the proper use of grid and plate bypasses for each tube. For the first amplifier tube the grid bypass condenser is marked *G-1*. Without this bypass the grid return would be through the potentiometer whose high resistance in the grid circuit would broaden the tuning and reduce the volume. The plate bypass for this first tube is marked *P-1*. Without it the plate return would be through the B-battery to the tube filament.

The grid bypass for the detector tube is marked *G-2* and without it the detector grid return would be through the rheostat which is bypassed by condenser *G-2*.

Two bypasses are connected to the plate of the detector tube in Fig. 2. One of these, *P-2*, is the regular plate bypass already explained. It is connected from the B-battery terminal of the audio frequency transformer to

CONDENSER, BYPASS

the tube's filament terminal. The bypass marked *P-3* is for the purpose of bypassing the radio frequency currents around the high impedance of the audio frequency transformer with its iron core. Without this condenser there would be such great impedance to the radio frequency currents attempting to pass through the transformer winding that amplification and volume would be reduced to a fraction of their proper value. Bypass condenser *P-3* allows the radio frequency currents from the plate of the detector tube to return directly to the filament of this tube, while the lower frequency audio currents pass through the winding of the transformer. See *Detector, Plate Bypass for*.

Sizes or Capacities of Bypass Condensers.—In the circuits of radio frequency amplifying tubes, grid bypasses may be of any capacity from .0005 microfarad up. Plate bypasses for these tubes may be from .001 microfarad up to any size available.

In the circuits of audio frequency amplifying tubes the grid bypasses should be of at least one-half microfarad capacity. The plate bypasses should be of at least one microfarad capacity. Any capaci-

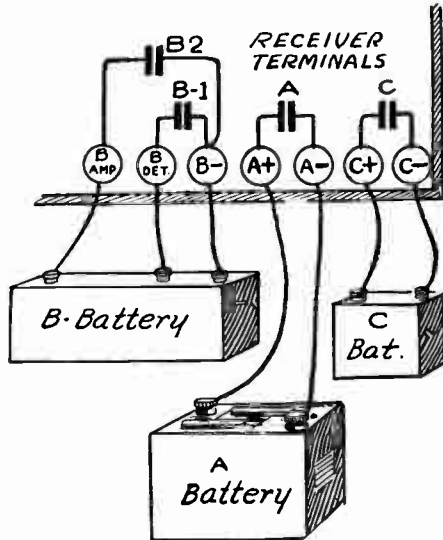

FIG. 3.—Connections of Bypass Condensers to Receiver Terminals.

ties greater than those mentioned may be used for either radio frequency or audio circuits and for either grid or plate returns.

The radio frequency bypass connected between the plate of the detector tube and this tube's filament must be large enough to bypass all of the radio frequency, but not so large as to pass any of the audio frequency currents. At this point, indicated by *P-3* in Fig. 2, the condenser should not be smaller than .001 microfarad and not larger than .005 microfarad capacity. The best value for any particular receiver may be found by experimenting with different capacities until the greatest volume and best quality are secured.

Battery Bypasses and Resistance Bypasses.—If the receiver is not fitted with the grid and plate bypasses shown in Fig. 2, the

CONDENSER, CAPACITY OF

principal points of trouble may be handled separately as in Fig. 3.

The battery bypasses are connected between the receiver terminals as shown, either on the outside of the cabinet or inside as may be convenient. Bypass *A* for the A-battery is not really required in the majority of cases. Bypass *B-1* takes care of the detector plate circuit and should be used. Bypass *B-2* is for the amplifier circuit and is the most important of the four shown. Using *B-2* alone will not provide a bypass for the detector circuit, although this *B-2* bypass across the entire B-battery is often the only one used or recommended. Bypass *C* is for the grid circuits. It is of less importance than the B-battery bypasses but is of greater advantage than the A-battery bypass. In the order of their advantage to the receiver the bypasses shown in Fig. 3 would range; first *B-2*, second *B-1*, third *C*, and fourth *A*. Bypass *C* may be as small as one-half microfarad capacity, but all others should be of at least one microfarad size and *B-2* may better be of two microfarad capacity.

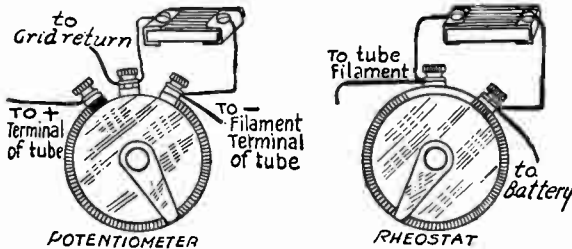

FIG. 4.—Bypass Condensers for Potentiometer and Rheostat.

The connection of bypasses around rheostats and potentiometers is shown in Fig. 4. The potentiometer bypass of .001 or .002 capacity is absolutely necessary when a potentiometer is used. The rheostat bypass is not required but is of some advantage with radio frequency amplifier tubes. It is of .001 microfarad capacity. Neither of these external bypasses are needed if the grid and plate bypasses of Fig. 1 are used.

CONDENSER, CAPACITY OF.—The capacity of a condenser is a measure of its ability to receive and hold an electric charge. The capacity is the relation between the charge that will be taken by a condenser and the voltage that is applied to give the charge.

The capacity depends on four things, (1) the surface area or size of the plates, (2) the number of plates in the condenser, (3) the separation of the plates or the thickness of the dielectric between them, and (4) the kind of dielectric or the nature of the material between the plates.

Capacity is increased by larger plates, by more plates, and by bringing the plates closer together. Capacity is decreased by using smaller plates, fewer of them, and by separating them more from one another. The capacity is also affected by the nature of the

CONDENSER, CAPACITY OF

dielectric. See *Constant, Dielectric*. The capacity is measured in microfarads, micro-microfarads, or centimeters of capacity. See *Capacity, Units of*.

The capacity in micro-microfarads of a multiple plate condenser with air for dielectric, such a condenser as used for tuning purposes, may be calculated from the formula:

$$\text{Capacity in Micro-microfarads} = \frac{0.225 \times \text{Area of One Side of One Plate} \times \left(\text{Total Number of Plates} - 1 \right)}{\text{Separation between Plates}}$$

The area of one side of one plate is in square inches.

The thickness of the dielectric or separation of the plates is in inches.

The capacity of condensers using other dielectrics than air; such as mica condensers and paper condensers, may be found by multiplying the value given from the above formula by the number representing the dielectric constant of the material between the plates. The formula then becomes:

$$\text{Capacity in Micro-microfarads} = \text{Capacity with Air Dielectric} \times \text{Dielectric Constant}$$

in which all of the values are the same as in the first formula but with the addition of the dielectric constant K . Values of K are given in the table under the heading *Constant, Dielectric*.

As an example, take a variable air condenser of 14 plates, each plate having an area on one of its sides of 2.6 square inches and with a separation of 0.3 inches between plates. Using the first formula and substituting the values:

$$\text{Capacity} = \frac{0.225 \times 2.6 \times (14 - 1)}{0.3}$$

Solving this equation gives the capacity as 253.3 micro-microfarads. The condenser is undoubtedly intended to have a nominal capacity of 250 micro-microfarads or .00025 microfarads, one of the common sizes.

Were the dielectric of mica with a dielectric constant (K) of 6, in place of air, but with all other values and dimensions remaining the same, this condenser would have a capacity six times as great, 1519.8 micro-microfarads or approximately .0015 microfarad.

To find the capacity in micro-microfarads of a two-plate condenser such as a paper condenser the following formula is used:

$$\text{Capacity in Micro-microfarads} = \frac{0.225 \times \text{Area of One Side of One Plate} \times \text{Dielectric Constant}}{\text{Thickness of Dielectric}}$$

The area of one side of one of the two plates is measured in square inches. The dielectric constant is the constant of the material used between the plates. The thickness of the dielectric is measured in inches.

Condensers in Parallel.—Condensers connected in parallel add their capacities together thus:

$$\text{Total Capacity} = C_1 + C_2 + C_3, \text{ etc. for all so connected.}$$

Taking four condensers in parallel with capacities of .001, .0005, .0005 and .0002; they would be added:

CONDENSER, CAPACITY OF

.001
.0005
.0005
.0002
—

making a total of .0022 microfarad in all.

Condensers in Series.—To obtain the value of a number of condensers connected in series it is necessary to add together the reciprocals of the capacities of the separate condensers which gives the reciprocal of the total capacity. The reciprocal of a number is 1 divided by the number.

$$\frac{1}{\text{Total Capacity}} = \frac{1}{C_1} + \frac{1}{C_2} + \frac{1}{C_3} + \frac{1}{C_4}, \text{ etc., for all so connected}$$

As an example, take the four condensers just considered as parallel and connect them in series, using the capacities in micro-microfarads as 1000, 500, 500, and 200: these corresponding respectively to the values in microfarads of .001, .0005, .0005, .0002. The reciprocals then are:

$$\frac{1}{1000} + \frac{1}{500} + \frac{1}{500} + \frac{1}{200} = \frac{1}{C}$$

Adding these fractions gives the result as 10/1000 which is equal to 1/C. Then 1000/10 is equal to C/1, and C/1 is equal to C itself and the total capacity must be 100 micro-microfarads for the four condensers connected in series.

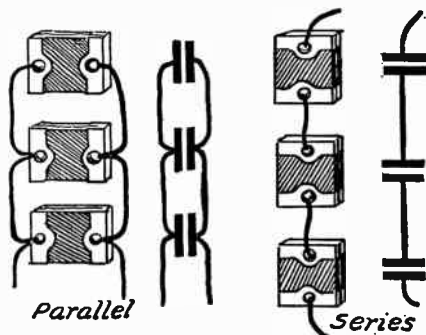

Condensers in Parallel and in Series.

It will be found invariably that the total capacity of any number of condensers in series is smaller than the capacity of the smallest condenser in the lot. It is thus possible to obtain capacities of smaller value by using two or more condensers in series and to obtain capacities of larger value by using two or more condensers in parallel.

CONDENSER, CAPACITY OF

The following tables give the capacities resulting from the connection of two condensers in series and from the connection of two condensers in parallel. These tables make use of the usual capacity sizes of both variable air condensers and of small fixed mica condensers. It is possible to place a fixed condenser either in series or in parallel with a variable condenser to obtain a lower minimum or higher maximum capacity. Also, with a limited number of condenser capacities available it is possible to obtain many other capacities.

CAPACITIES OF CONDENSERS IN SERIES

Combined Capacity		Two Separate Capacities Combined	
<i>Micro-microfarads</i>	<i>Microfarads</i>		
50	.00005	.0001	.0001
72	.000072	.00025	.0001
83	.000083	.0005	.0001
91	.000091	.001	.0001
95	.000095	.002	.0001
96	.000096	.0025	.0001
98	.000098	.005	.0001
98.4	.0000984	.006	.0001
125	.000125	.00025	.00025
166	.000166	.0005	.00025
200	.0002	.001	.00025
222	.000222	.002	.00025
227	.000227	.0025	.00025
238	.000238	.005	.00025
240	.00024	.006	.00025
250	.00025	.0005	.0005
333	.000333	.001	.0005
400	.0004	.002	.0005
417	.000417	.0025	.0005
455	.000455	.005	.0005
462	.000462	.006	.0005
500	.0005	.001	.001
666	.000666	.002	.001
714	.000714	.0025	.001
833	.000833	.005	.001
857	.000857	.006	.001
1000	.001	.002	.002
1111	.001111	.0025	.002
1250	.00125	.0025	.0025
1428	.001428	.005	.002
1500	.0015	.006	.002
1578	.001578	.006	.0025
1666	.001666	.005	.0025
2500	.0025	.005	.005
2727	.002727	.006	.005
3000	.003	.006	.006

CONDENSER, CAPACITY, MATCHING OF

CAPACITIES OF CONDENSERS IN PARALLEL

Combined Capacity		Two Separate Capacities Combined	
<i>Micro-microfarads</i>	<i>Microfarads</i>		
200	.0002	.0001	.0001
350	.00035	.00025	.0001
500	.0005	.00025	.00025
600	.0006	.0005	.0001
750	.00075	.0005	.00025
1000	.001	.0005	.0005
1100	.0011	.001	.0001
1250	.00125	.001	.00025
1500	.0015	.001	.0005
2000	.002	.001	.001
2100	.0021	.002	.0001
2250	.00225	.002	.00025
2500	.0025	.002	.0005
2600	.0026	.0025	.0001
2750	.00275	.0025	.00025
3000	.003	.0025	.0005
3000	.003	.002	.001
3500	.0035	.0025	.001
4000	.004	.002	.002
4500	.0045	.0025	.002
5000	.005	.0025	.0025
5100	.0051	.005	.0001
5250	.00525	.005	.00025
5500	.0055	.005	.0005
6000	.006	.005	.001
6100	.0061	.006	.0001
6250	.00625	.006	.00025
6500	.0065	.006	.0005
7000	.007	.006	.001
7000	.007	.005	.002
7500	.0075	.005	.0025
8000	.008	.006	.002
8500	.0085	.006	.0025
10000	.01	.005	.005
11000	.011	.006	.005
12000	.012	.006	.006

CONDENSER, CAPACITY, MATCHING OF.—See *Oscillator, Radio Frequency, Uses of.*

CONDENSER, CHARGE OF.—See *Condenser, Action of.*

CONDENSER, CHEMICAL.—See *Condenser, Electrolytic.*

CONDENSER, CONNECTIONS TO.—With any variable condenser having a shaft extending through a panel and ending with

CONDENSER, COUPLING BY MEANS OF

a dial or knob touched by the hand of the operator it is necessary to connect parts of the condenser attached to the shaft to the low voltage side of any circuit which includes the condenser. This avoids the bad effects of body capacity. See *Capacity, Body*. The movable plates or rotating plates of the condenser are attached to the shaft, the moving assembly being called the rotor of the condenser. The rule is then to connect the rotor to ground or low voltage wires.

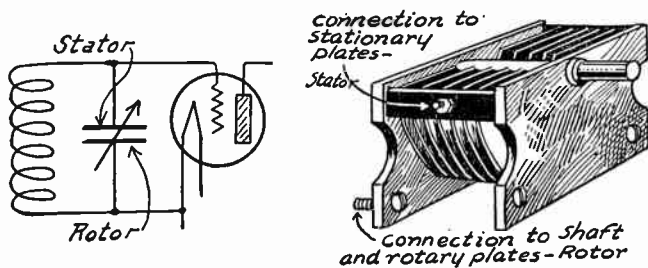

Connections to Rotor and Stator of Condenser.

A condenser used with a tuned radio frequency transformer has one side connected to the grid of the following tube and the other side connected to the grid return or filament circuit of that tube. The rotor part of the condenser must always be connected to the filament or grid return side of the circuit and the stationary part or stator of the condenser must be connected to the grid of the tube as in the diagram.

With other condensers, such as balancing condensers, the stator of the condenser is connected to the plate side, the grid side, or other high voltage side of the circuit. The rotor is connected to the battery or coil side.

CONDENSER, COUPLING BY MEANS OF.—See *Coupling, Capacitive*.

CONDENSER, CURRENT FLOW THROUGH.—See *Condenser, Action of*.

CONDENSER, DESIGN AND CONSTRUCTION OF.—The following remarks on features of condenser design apply particularly to variable air condensers used for tuning purposes. As mentioned under the heading *Condenser, Action of*, any condenser is made up of two principal parts considered from the electrical standpoint. One of these parts consists of the stationary plates and rotary plates while the other part is formed by the dielectric between the plates.

Since the stator and rotor are insulated from each other, the two sets of plates make a further division of condenser parts into stator plates, rotor plates, and dielectric. The condenser's rotor and shaft bearings, the end plates, the spacer rods and the panel support studs or bosses are of metal and are all in contact with one another so that they form one continuous electrical conductor all parts of which must be at the same voltage at any one time. All of these parts are shown in the typical condenser of Fig. 1.

The stator plates are all connected with each other metallicly, but the stator plate assembly is electrically insulated from all other

CONDENSER, DESIGN AND CONSTRUCTION

metal parts of the condenser. The support for the stator is formed by insulation attached firmly to the end plates or other metallic parts forming the framework of the condenser. The stator plate assembly is carried by this supporting insulation so that the stator plates are held rigidly in place and interleaved between the rotor plates. One or more terminals for making connections to the stator plates are mounted somewhere on the insulating support.

The stator plates and all metal parts and terminals connected to them should be carried as far back of the panel supports as possible so that the operator's body capacity will have little or no effect.

Condenser Plates.—The metal of which the plates are made is preferably of the same kind as used for the rotor shaft and for the metal support which joins the stator plates together. Unless well soldered or welded together, two different metals will in time corrode at a joint between them and this corrosion makes very high resistance. To guard against high resistance between the plates and

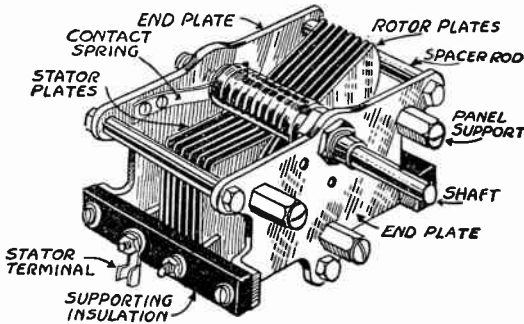

FIG. 1.—The Parts Considered in Design of a Typical Variable Condenser.

their supports, the plates should be soldered, brazed or welded to their shaft or other support. A few condensers are built with the plates and their supports cast in one piece, this being an ideal method, although quite costly.

Plates are generally made either of brass or of aluminum. There is little difference in their resistances. Brass is subject to corrosion while aluminum is practically free from this corrosion. Brass plates are often lacquered to prevent this corrosion.

Plates which are thin will reduce the losses from skin effect and from eddy currents. But plates must be strong and rigid to maintain a uniform capacity and prevent the possibility of short circuit between stator and rotor plates which would be caused should they warp or bend. It is to secure this needed stiffness or rigidity that brass or aluminum is selected rather than pure copper, although copper is a better conductor than either.

Supporting Insulation.—The material used for the insulating support should have the lowest possible dielectric constant consistent with mechanical strength. The reason for requiring a low dielectric constant is that this constant indicates the ease with which the electrostatic lines of force pass through the material or are drawn

CONDENSER, DESIGN AND CONSTRUCTION

into it, much as magnetic lines of force are drawn into iron and steel more easily than into other metals.

Phenol fibre products, such as Bakelite, also quartz and dielectric glass, are the materials that best combine the requirements of mechanical strength with low electrical losses. Hard rubber and moisture-proofed wood would be satisfactory electrically, but cannot be depended on to hold their shape over long periods of time.

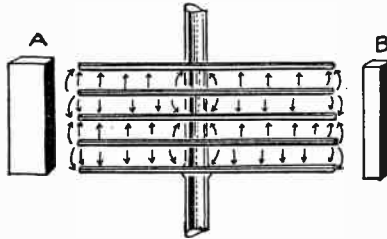

FIG. 2.—The Electrostatic Field Affecting Design of a Condenser.

The supporting insulation should be placed in the weakest possible electrostatic field. Since the strongest electrostatic field is between the plates, the insulation should be as far from the plates as it can be placed.

All dielectric or insulating material in the vicinity of the plates tends to draw part of the electrostatic field into and through itself rather than allowing all of this field to exist between the plates. Therefore, the least possible bulk of insulation should be used for the supports. However, a comparatively large piece of insulation well removed from the vicinity of the plates is to be preferred to a much smaller piece close to or in the field.

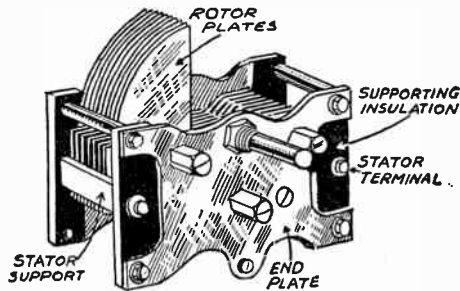

FIG. 3.—Terminal Positions Considered in Condenser Design.

The lines of force forming the electrostatic field of a multi-plate variable condenser are shown in Fig. 2. If a piece of dielectric material or insulation be placed with its long dimension running in the same direction as these electrostatic lines of force, the lines will tend to leave the main part of the field and flow through the length of the dielectric. This condition is to be avoided.

The electrostatic lines of force will leave the field between the plates and pass through a large piece of dielectric as at *A* more readily than through a small piece as at *B* provided both pieces are equally close to the plates.

Terminals and Connections.—The terminal or terminals for the stator plates should have the greatest possible length or surface

CONDENSER, DIELECTRIC FOR

of insulation between them and the nearest metal part or terminal which is connected to the rotor plates. This is to prevent surface and volume leakage through the insulation from the stator plates to the rotor plates. This is well illustrated in the condenser of Fig. 3 where the stator terminal is in the center of the length of the insulation and separated by the greatest possible distance from the nearest points of the end plates.

It will be realized that some kind of connection must be provided between the rotor plates and the stationary metal parts of the framework since the rotor plates must move while the remainder of the condenser stands still. In many condensers the only electrical connection from the moving rotor plates to their terminal is through the shaft bearing. This does not make a satisfactory connection and will generally lead to noisy reception after the condenser becomes old.

A better practice is shown in Fig. 1 where a contact spring is solidly riveted to the end plate and has its other end bearing firmly against the shaft carrying the rotor plates. This construction is open to the objection that dirt or corrosion, either on the spring's end or on the boss against which it presses, will cause noise and a loss of energy.

A flexible pigtail connection between rotor plates and their terminal or the end plate is most satisfactory, especially if the ends of the pigtail are soldered to the rotor plates or shaft and to the end plate or the terminal. The use of such a properly installed pigtail will often reduce the resistance of a condenser as much as ten per cent if the bearings alone have been depended on for contact. See *Pigtail*.

End Plates of Condensers.—Many variable condensers are made with metal end plates like those shown in Figs. 1 and 3. Other condensers, equally well designed, use end plates of dielectric material as in Fig. 4.

Whether end plates are of metal or of insulating material, they should be at the greatest possible distance from the active plates of the condenser. Furthermore, the end plates, of whatever material, should have the least possible bulk or size consistent with the required mechanical strength. The end plates have no other purpose in the condenser than to provide a framework and a support, so the less of them the better. An openwork end plate is better than a solid end plate of any kind.

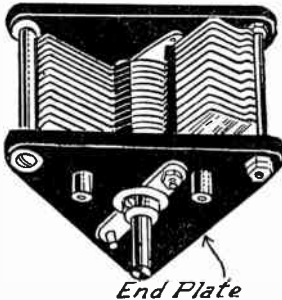

FIG. 4.—Condenser Designed with Dielectric End Plates.

There are dielectric losses in the end plates of a condenser using insulating material for these parts, but there are equally serious eddy current losses in metal end plates. The shape of end plates is of more importance than the choice of material.

CONDENSER, DIELECTRIC FOR.—In radio work there are three principal kinds of condensers when classed according to their dielectrics. There are air condensers such as the variable

CONDENSER, DIELECTRIC ABSORPTION IN

tuning condensers, mica condensers such as the various fixed condensers of small capacity, and paper condensers represented by the larger bypass units. Air condensers come closest to the ideal condenser. Mica runs next and paper condensers are poorest.

CONDENSER, DIELECTRIC ABSORPTION IN.—See *Condenser, Losses In*; also *Absorption, Dielectric*.

CONDENSER, ELECTROLYTIC.—An electrolytic condenser is formed with a metal as one plate, a liquid electrolyte as the other plate and with a gas layer between the two as the dielectric. When metals such as aluminum and tantalum are put into an electrolyte it is possible for electric current to flow from the electrolyte into the metal when voltage is impressed across them, but there is exceedingly high resistance to passage of any current in the reverse direction; from the metal to the electrolyte. This principle of a one-way electric valve is utilized also in the electrolytic rectifier.

Since the combination of metal and liquid has the properties of an insulator to flow of current one way, and since the metal and the

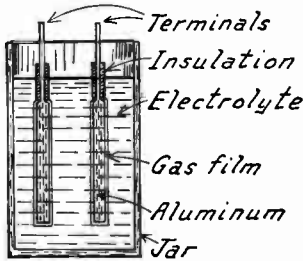

FIG. 1.—Parts of an Electrolytic Condenser.

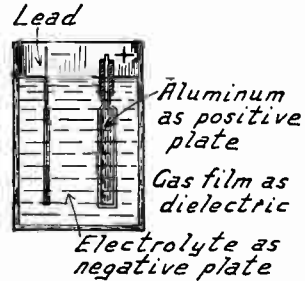

FIG. 2.—Electrolytic Condenser for Direct Current.

liquid are both conductors, this arrangement has all the elements needed to form a condenser. That is, the combination is made up of two conductors separated by an insulator.

If two aluminum plates are placed in an electrolyte as shown by Fig. 1, the aluminum becomes covered with a very thin layer of oxide. On this oxide there forms a thin layer of gas whose resistance amounts to thousands of ohms. The electrolytic condenser of Fig. 1 is suitable for use in alternating current circuits because it will not allow flow of electricity through it in either direction. In radio work, such as power supply units, most of the condensers are used with direct currents or at least with pulsating currents which do not reverse their polarity. Therefore, it is possible to use the form of electrolytic condenser shown in Fig. 2.

The condenser of Fig. 2 consists of the aluminum as a positive plate, of the gas film as a dielectric and of the electrolyte as a negative plate. In order to make a connection from the electrolyte

CONDENSER, ELECTROLYTIC

to the negative side of the circuit a piece of lead is immersed in the electrolyte, this lead acting only as a terminal for the liquid and having no condenser action whatever. It is impossible for current to pass from the aluminum to the electrolyte, consequently this form of condenser provides the necessary insulating effect as long as the positive side of the circuit is connected only to the aluminum.

The capacity of the electrolytic condenser depends on (1) the area of the metal plate, (2) on the material of which this plate is made, and (3) on the thickness of the dielectric film of gas. The thickness of the gas film depends on the voltage which is used when the film is first formed. The higher the voltage applied during formation of the film, the thicker the film is made and the less the capacity becomes.

After the condenser elements are assembled a direct voltage is applied for eight to ten hours. This voltage causes formation of the gas film. The maximum working voltage of the condenser when finally placed in service must be less than the voltage used during the forming process. If higher voltages are applied, the gas layer will become thicker and the capacity of the condenser will be reduced. As long as the formation voltage is not exceeded in service the gas layer will remain of constant thickness and the condenser capacity will remain unchanged.

The maximum formation voltage which may be safely applied depends on the chemical used in making the electrolyte solution. Various chemicals will withstand certain maximum critical voltages and if these voltages are exceeded the gas layer will be punctured. Puncture of the gas layer allows the condenser to break down and cause a short circuit between its terminals. Upon reduction of the applied voltage the break will be mended by formation of a new film.

The following list shows the maximum voltages which may be used with condensers having several kinds of electrolytes dissolved in pure water and employing aluminum plates:

Borax; sodium tetraborate.....	480 volts
Ammonium citrate.....	470 volts
Ammonium phosphate.....	460 volts
Sodium silicate.....	445 volts
Ammonium bicarbonate.....	425 volts
Potassium cyanide (very poisonous).....	295 volts
Ammonium chromate.....	122 volts
Potassium permanganate.....	112 volts
Sodium sulphate (Glauber's salts).....	40 volts

(from "Electrochemical and Metallurgical Industry")

Inasmuch as the thickness of the gas layer is determined by the voltage of formation, the capacity of the condenser really depends on this voltage, on the metal used for the plates, and on the area of the plate surface. These three factors are taken into consideration in the curves of Fig. 3 which show the capacity in microfarads per square inch of plate area for the metals aluminum and tantalum with various formation voltages.

From these curves it is seen that great capacity per unit of area may be obtained when using up to 100 or 150 volts on formation. With higher formation voltages the capacity becomes comparatively small and it is there-

CONDENSER, ELECTROLYTIC

fore desirable to use such condensers with 100 volts or less across their terminals. When higher voltages than this are to be handled, two or more condensers may be connected in series as shown by Fig. 4. The voltage that may then be applied across the condensers is equal to the maximum voltage allowed

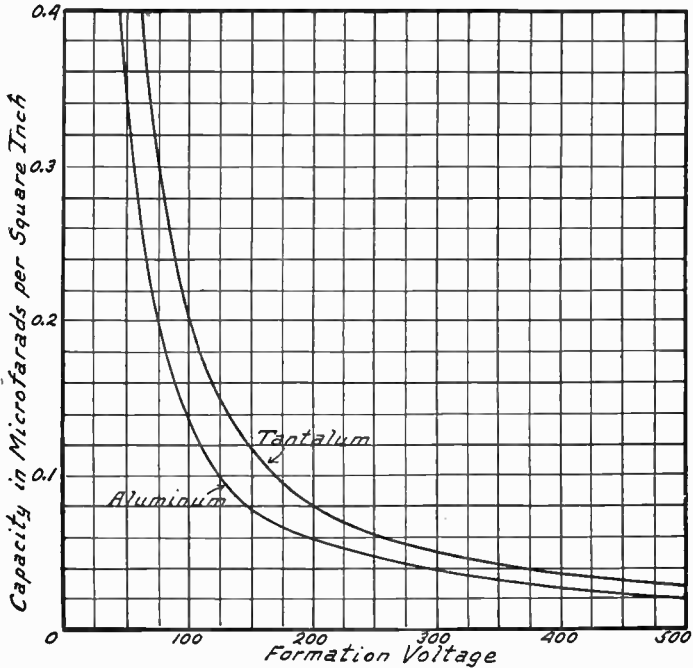

FIG. 3.—Capacity of Electrolytic Condenser with Various Formation Voltages.

for one condenser times the number of condensers and the capacity is equal to the capacity of one condenser divided by the number of condensers.

As indicated in Fig. 4, the condenser may consist of a number of thin aluminum plates to increase the surface area within reasonable overall dimensions. A single lead plate serves as a common negative

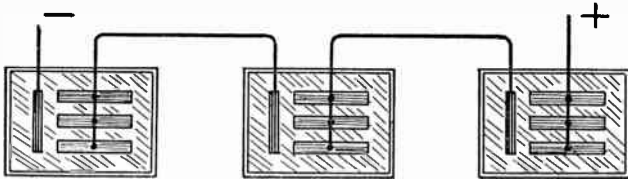

FIG. 4.—Electrolytic Condensers in Series for High Voltages.

terminal for the whole condenser. The aluminum plates may be made quite thin, number 18 gauge being suitable for this work. The size of the plate connection where it goes through the surface of the electrolyte into the air must be as small as possible and this

CONDENSER, ELECTROLYTIC

portion of the plate should be covered with insulation of rubber tubing, glass tubing or wax which extends at least one-quarter inch both above and below the surface of the electrolyte. This insulation is to prevent the voltage from arcing over at the surface of the liquid.

A condenser made with eight aluminum plates two inches wide and five inches long formed at 125 volts will have a capacity of about sixteen microfarads. If formed at 300 volts the same condenser will have a capacity of slightly more than six microfarads. If formed at 40 volts, as for work in A-power units, this condenser would have a capacity of about 65 microfarads.

The construction of a commercial electrolytic condenser, the Mershon, is shown in Fig. 5. The anode, connected to the positive terminal, is composed of a rolled sheet of aluminum on the surface of which has been formed a layer of aluminum oxide. The film of oxide acts as the dielectric. The liquid electrolyte acts as the cathode and is in contact with the copper container which forms the negative terminal. Several anodes are generally placed within one container. The separate anodes are provided with a celluloid insulator to resist differences in voltage applied to them, also with an electrostatic shield.

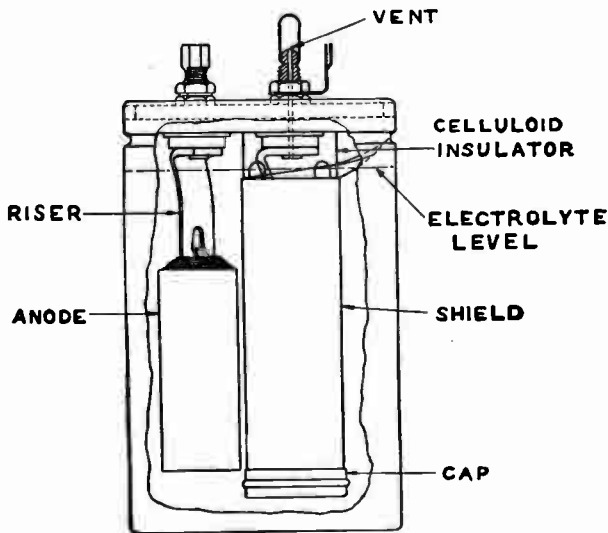

FIG. 5.—The Mershon Electrolytic Condenser.

Modern types of electrolytic condensers are built to withstand up to 400 volts without breakdown. The reverse current, or leakage current, is very small, being in the neighborhood of only one and one-half to two milliamperes for each ten microfarads of capacity with 300 volts applied across the terminals.

Dry Electrolytic Condensers.—Electrolytic condensers of exceedingly great capacity within small space are constructed in dry form. The anode (forming the positive connection) is made of thin aluminum foil on the surface of which is a film of aluminum oxide

CONDENSER, EQUIVALENT RESISTANCE IN

acting as the dielectric. The electrolyte may be carried by fibrous sheets wound between the aluminum with the sides of these sheets sticking out at the ends of the roll to form a negative or cathode connection. In other forms of dry condensers the cathode side is formed by layers of lead foil wound between the aluminum sheets. The thinness of the dielectric film, together with the large surfaces of foil, allow condensers of several thousand microfarads capacity to be built within a few cubic inches of space.

CONDENSER, EQUIVALENT RESISTANCE IN.—See *Condenser, Losses In.*

CONDENSER, FIXED.—Fixed condensers are those in which the capacity is determined and fixed at the time of their manufacture and which cannot be changed afterward. Variable condensers are condensers in which the capacity may be changed by the operator while the condensers are in use.

Fixed condensers are of two general types. Those of small capacity are known as mica condensers because they use mica for their dielectric. Those of larger capacity are generally known as paper condensers, these having paper for dielectric.

The small mica condensers are made in a great variety of sizes or capacities, the following capacities in microfarads being those in general use:

0.00004	0.0002	0.001	0.005
.00005	.00025	.0012	.006
.00006	.0003	.0015	.007
.00007	.00035	.00175	.0075
.00008	.0004	.002	.008
.0001	.0005	.0025	.01
.00012	.0006	.003	.012
.00015	.0007	.0035	.015
.000175	.0008	.004	.02

In micro-microfarads the above capacities range from 40 to 20,000 and by using them in parallel or in series with each other an almost infinite variety of capacities may be had. In mentioning these small sizes they are generally spoken of as follows: A .0001 condenser is called a "triple oh one" condenser, a .00025 is called a "triple oh two five," one of .005 capacity being called "double oh five," and a .02 size being called "oh two."

Some mica condensers are made by coating thin sheets of mica with a layer of silver just as a mirror is silvered. Metal foil is placed between these sheets of silvered mica and solidly clamped after which the condenser is treated with paraffin or other wax. Other fixed condensers are made in a similar way but without the silver coating. The dielectric in these condensers is therefore a combination of mica and wax.

These small mica condensers are used for radio frequency, for headphone and for loud-speaker bypasses; as grid condensers for detector tubes; as coupling condensers in all types of capacitive coupling; as blocking or stopping condensers to prevent direct currents from entering various parts of circuits; and as antenna condensers. It is rather astonishing to find that small mica condensers, in spite of

CONDENSER, FIXED

their solid dielectric, have no greater losses or resistance than the air type of tuning condensers of small capacities. This is due to the fact that these fixed condensers have very small and thin plates in which there is little skin effect. The reduction in skin effect offsets the increase of dielectric absorption in the solid dielectric so that the net result is a low resistance.

Most of these mica condensers will be found accurate as to capacity within a plus or minus variation of ten per cent. If greater accuracy is secured, the condensers generally cost more than the regular variety. Where exact capacities are required it is necessary to either buy tested and matched condensers or to measure the capacities of standard types and select those that are suitable for the work. Capacity may be measured as described under *Bridge, Measurements with* and under *Oscillator, Uses of*.

The larger capacities of fixed condensers are of the paper type. The following sizes or capacities in microfarads are generally used for bypasses and filter condensers in all types of circuits:

1/10 1/4 1/2 1 2 3 4 8 16 24

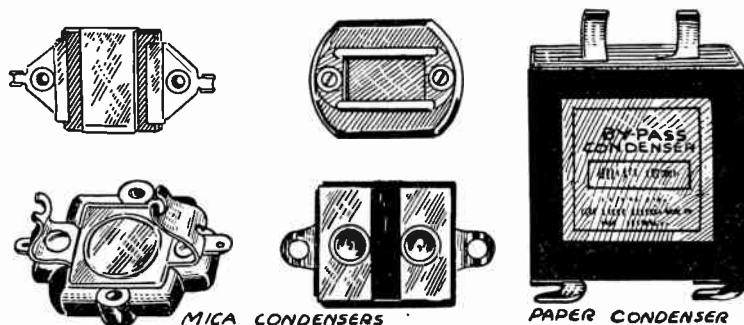

Types of Fixed Condensers.

Paper condensers, unless built especially for high voltages, often break down or puncture when subjected to pressures greater than 100 volts. This trouble, causing a high resistance leak or even a direct short circuit, should be tested for when such a condenser can be suspected.

Papers condensers consist of layers of very thin metal foil separated by one or more thicknesses of insulating paper, and finally impregnated with paraffin or other wax. A paper condenser has comparatively high dielectric absorption.

For the various uses of fixed condensers, see the following: *Condenser, Antenna. Condenser, Bypass. Coupling, Capacitive. Condenser, Stopping. Detector, with Grid Condenser and Leak.* For methods of matching fixed condensers for capacity and for comparing impedances see *Oscillator, Radio Frequency, Uses of*.

CONDENSER, FIELD OF, ELECTROSTATIC.—Between any two conductors separated by dielectric material there are electrostatic lines of force whenever the two conductors are at dif-

CONDENSER, FILTER

ferent voltages. These electrostatic lines of force form what is called the electrostatic field. In a condenser the electrostatic field is between the plates, through the dielectric. There is also an electrostatic field between the stator plates of a condenser and the shaft carrying the rotors, the end plates, and all other metal parts connected with the rotor plates. These stray electrostatic fields exist because the stator plates are at a different voltage from that of the rotor plates and parts connected with them. See *Field, Electrostatic*.

CONDENSER, FILTER.—See *Filter*; also *Power Unit*.

CONDENSER, GANG.—See *Condenser, Multiple*.

CONDENSER, GRID.—See *Detector, with Grid Condenser and Leak*.

CONDENSER, GROUNDING, IN RECEIVER.—See *Ground, Receiver*.

CONDENSER, IMPEDANCE OF.—See *Impedance*.

CONDENSER, INSULATION OF.—See *Condenser, Design and Construction of*.

CONDENSER, LOOP TUNING.—See *Loop, Design and Construction of*.

CONDENSER, LOSSES IN.—An ideal condenser would have no resistance, no leakage or absorption of the charge, and no inductance. Such an ideal is manifestly impossible of attainment. Everything about a condenser which causes it to fall short of this ideal is a condenser loss. The principal losses are classed as ohmic resistance of the plates and metal joints, as equivalent series and shunt resistances of the condenser as a whole, as surface and volume leakage in the insulating supports, and as dielectric absorption.

Ohmic Resistance.—The plates of a condenser have resistance just as any other conductor has resistance. This ohmic resistance is governed by the same laws that govern the resistance of any conductors, that is, by the conductor's material, length and cross section. The resistance of thick plates would naturally be less than that of thin plates. The skin effect increases with increase of frequency and at radio frequencies the skin effect is of more importance than the ohmic resistance.

The joints between plates and the parts in which they are supported may under some conditions be of high resistance. When the plates are of one metal and the shafts and brackets of another metal it is more than likely that there will be corrosion, oxidation or looseness at the joints.

Equivalent Resistance.—The equivalent series resistance of a condenser is the amount of resistance which, if placed in series with a perfect condenser of the same capacity, would allow the same current to flow that actually flows in the condenser being considered. This is shown in Fig. 1. The equivalent series resistance acts to lessen the flow of current in the condenser's circuit just as an actual ohmic resistance would lessen it.

Series resistance is due to skin effect in the plates, to dielectric absorption, to the formation of eddy currents in end plates and other metal parts and to

CONDENSER, LOSSES IN

the ohmic resistance of the condenser's plates and their connections to terminals.

The loss of energy due to skin effect and eddy currents increases with increase of frequency. The loss in dielectric absorption is much like the loss caused by heating in a conductor. The equivalent resistance of a condenser decreases with increase of condenser capacity. Taking several condensers of the same style made by the same manufacturers, the resistances are found as follows for various capacities: In the 250 micro-microfarad size the resistance is 1.65 ohms; in the 350 micro-microfarad size the resistance is 1.10 ohms; in the 500 micro-microfarad size the resistance is 0.85 ohm and in the 1000 micro-microfarad size the resistance is only 0.60 ohm.

Condensers also have what is called an equivalent parallel resistance. This is the amount of resistance which, if placed in parallel with a perfect condenser, would allow the same escape of current around the perfect condenser that actually escapes through the parallel resistance of the condenser under consideration. The parallel resistance allows a leakage of alternating current between the plates of the condenser.

The principal cause of equivalent parallel resistance is the surface leakage and volume leakage over and through the insulation used in the condenser

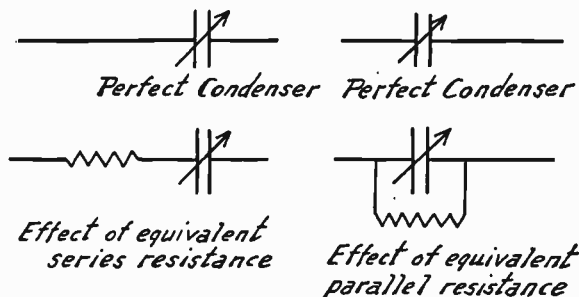

FIG. 1.—Effect of Loss from Equivalent Resistance in Condensers.

supports. The better the grade of insulation and the greater the length of the insulation between stator plates and rotor plates or their supports the less will be the loss due to parallel resistance.

Compared with the resistance of coils generally used in connection with tuning condensers the resistance of the condenser is of minor importance. Measured at radio frequencies the resistance of coils is many times greater than the resistance of only moderately good condensers.

Capacity Reactance Effects.—As the plates of a condenser are turned out of mesh, that is, as the dial is turned from 100 or the highest reading down toward zero, the resistance does not increase to any great extent until the plates are about three-quarters out of mesh. On a dial with one hundred divisions this would be at about 25 on the dial. As the setting is turned further down toward zero the condenser's resistance begins to rise very rapidly. At 20 it has about doubled in value. At 10 it is about seven times as great and below ten the resistance goes "out of sight," comparatively speaking. Therefore condensers should be large enough so that it is not

CONDENSER, LOSSES IN

necessary to go below one-quarter or one-fifth of their total capacity for the lowest wavelength stations to be received. The resistance of any condenser is least when the plates are fully in mesh, that is, when it is being used for the lower frequencies or higher wavelengths.

Surface and Volume Leakage in Insulation.—Some power is lost in condensers by leakage of current across the surface of the insulating parts and supports of the condenser. Such leakage is increased by dampness or dust on these parts. Finally there is an extremely small leakage of current from positive to negative plates right through the insulating supports which carry these plates. The effects of the surface leakage and volume leakage combine and are then called the parallel resistance of the condenser because their effect is the same as if a resistance were placed across the stator and rotor plates as in Fig. 1. A very small amount of current flows away through this parallel resistance. This form of loss usually is so small as to be of little importance.

Dielectric Absorption.—When a condenser is charged it will immediately give back a flow of current into a circuit attached to it.

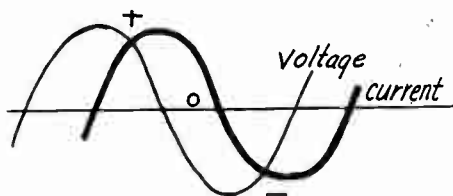

FIG. 2.—Current and Voltage in Quadrature.

This charge which flows out instantly is called the free charge. Some kinds of dielectrics will allow the condenser to deliver a further flow of current later on. This is called the residual charge and is an absorbed charge.

At the high frequencies used in radio work the condenser does not have time between alternations to give back all of the absorbed or residual charge left from one voltage peak before another one comes along. Therefore, most of the absorbed charge is lost and is never recovered from the condenser. This loss is due to dielectric absorption.

The amount of dielectric absorption depends on the kind of dielectric used. With air the loss is negligible. With mica or with oil as the dielectric the absorption is very small. Glass is somewhat poorer in this respect, while phenol fibre materials are really troublesome.

The loss in the dielectric depends altogether on the kind of dielectric used and not on the amount that is used or on the spacing between plates. If an attempt were made to reduce this loss by doubling the thickness of dielectric, doubling the separation between plates would be required. In order to regain the original capacity, the area of the plates would then have to be doubled, resulting in four times the bulk of dielectric being used. Since the plates would then be twice as far apart the voltage gradient through the dielectric would

CONDENSER, MICA TYPE

be halved. The dielectric loss varies as the square of the voltage gradient and the square of one-half is one-quarter. Therefore there would be one-quarter the loss for a given volume of dielectric but four times as much dielectric would have to be used. The actual or total loss would be just the same as in the beginning. See also *Absorption, Dielectric*.

Phase Angle Difference of Condensers.—In all alternating current circuits, such as those including condensers, there is a rise, fall and reversal of electrical pressure or voltage, also a rise and fall of current or amperage. The rise and fall of voltage is not always in exact step or in phase with the rise and fall of current. In an ideal condenser, which does not exist in practice, the current rise and fall would lead the voltage rise and fall by one-quarter of a cycle or ninety degrees as in Fig. 2.

All condensers throw the current and voltage slightly off from the ninety degree ideal difference, which is called in quadrature. The more the condenser throws the current and voltage out of quadrature the greater is the loss of energy. The amount of displacement is called the phase angle difference of the condenser. The phase angle difference is a measure of poorness in a condenser. The greater the phase angle difference the poorer the condenser.

There is a slight increase in the phase difference as the condenser capacity decreases. The smaller the condenser capacity the greater the phase difference. This applies to variable tuning condensers of the air type. In fixed mica condensers the phase difference becomes less and less as the capacity of the condenser decreases. A small fixed condenser has decidedly less phase difference than a large one of the same type. The phase angle difference in fixed condensers shows great irregularities. These irregularities depend on slight imperfections in individual condensers of the same capacity rating. The resistances and phase differences of first-class fixed mica condensers are no greater than the resistances and phase differences of high grade variable air condensers. Therefore, there is no objection to using fixed condensers and variable inductances for tuning. That is, there is no objection as far as the losses in the circuits are concerned.

CONDENSER, MICA TYPE.—See *Condenser, Fixed*.

CONDENSER, MULTIPLE TYPES.—Multiple or tandem tuning condensers similar to those shown in Figs. 1 and 3 are used

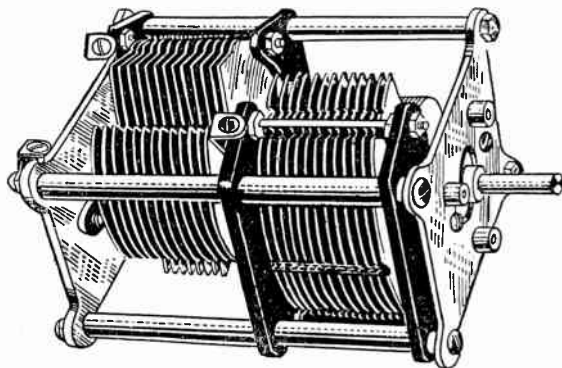

FIG. 1.—A Two-Part Tandem Multiple Condenser.

CONDENSER, MULTIPLE TYPES

for tuning several circuits or several stages of radio frequency amplification to the same frequency at the same time. Two, three, or more condensers may thus be connected together.

A single shaft, a toothed rack, a pulley cord or similar connection operates all parts of the multiple condenser and to this control are attached all of the sets of rotor plates.

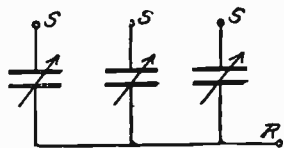

FIG. 2.—Electrical Connections of Multiple Condenser.

This method is satisfactory and practical because in any multi-stage amplifier the rotors of all the tuning condensers may be connected to a common grid return or grounded line as shown under *Control, Single*.

The scheme of electrical connection of three condensers used in this way is shown in Fig. 2. This three-gang condenser has only one common rotor terminal *R*, but has three separate stator terminals *S-S-S* which are used for the grid connections.

The condenser shown in Fig. 1 has its stators mounted on opposite sides of the central shaft and the rotors are accordingly mounted opposite each other. The two rotors thus balance their weights so that the shaft does not require additional balancing or extra friction

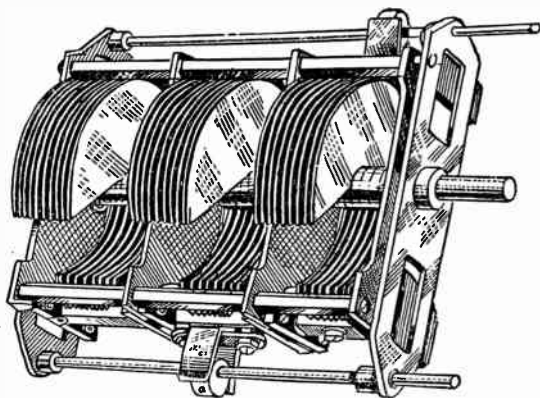

FIG. 3.—Three-Gang Multiple Condenser.

devices to prevent the rotors falling into their lowest position. This condenser consists of two units and is called a two-gang condenser.

The condenser of Fig. 3 is of the three-gang type. The central shaft runs straight through and has the three sets of rotor plates solidly attached to it. The stator plates of the rear or left hand condenser are fixed permanently in place but the stators of the other two condensers are movable for vernier action. The small shaft shown at the top of the unit controls the vernier action of the right hand or front condenser while the small shaft at the bottom controls the vernier action of the middle condenser.

CONDENSER, NEUTRALIZING

All of the features of design and construction as well as the explanations of condenser characteristics of all kinds apply as well to multiple condensers as to single unit types. See also *Control, Single*.

CONDENSER, NEUTRALIZING.—See *Condenser, Balancing*.

CONDENSER, PAPER TYPES.—See *Condenser, Fixed*.

CONDENSER, PARALLEL CONNECTED.—See *Condenser, Capacity of*.

CONDENSER, PARALLEL RESISTANCE OF.—See *Condenser, Losses in*.

CONDENSER, PHASE ANGLE OF.—See *Condenser, Losses in*.

CONDENSER, PIGTAIL FOR.—See *Pigtail*.

CONDENSER PLATES, NUMBER OF.—Condensers should be rated according to their capacity in microfarads or in micro-microfarads rather than according to the number of plates. It seems that in early days of radio the first tuning condensers happen to have had either twenty-three plates or forty-three plates. Consequently people began speaking of “twenty-three plate condensers” and “forty-three plate condensers.” The common forty-three plate condenser generally has a maximum capacity in the neighborhood of 0.001 microfarad or 1000 micro-microfarads. What is commonly called a twenty-three plate condenser has a maximum capacity in the neighborhood of 0.0005 microfarad or 500 micro-microfarads. The seventeen plate size is intended to have a maximum capacity of about 0.00035 microfarad or 350 micro-microfarads. The thirteen plate and eleven plate condensers generally run 0.00025 microfarad or 250 micro-microfarads. Seven plate condensers would have a nominal maximum capacity of 0.00015 microfarad or 150 micro-microfarads. The actual capacity generally varies as much as five per cent from the nominal rated capacity.

CONDENSER, REACTANCE OF.—See *Reactance*.

CONDENSER, RESISTANCE, EQUIVALENT.—See *Condenser, Losses in*.

CONDENSER, RESISTANCE IN SERIES WITH, EFFECT OF.—A variable resistance placed in series with a condenser or with several condensers themselves connected in parallel may be used to obtain a slight change in the effective capacity of the condenser or condensers. This is because the variation of the

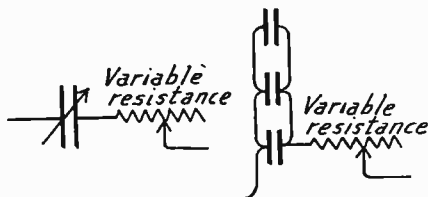

Resistances for Change of Effective Condenser Capacity.

CONDENSER, ROTOR OF

resistance changes the impedance of the circuit containing the condensers.

CONDENSER, ROTOR OF.—See *Condenser, Design and Construction of*.

CONDENSER, SERIES ANTENNA.—See *Condenser, Antenna*.

CONDENSER, SERIES CONNECTED.—See *Condenser, Capacity of*.

CONDENSER, SERIES RESISTANCE OF.—See *Condenser, Losses in*.

CONDENSER, SHIELDING OF.—See *Shielding*.

CONDENSER, SHUNTING ANTENNA.—See *Condenser, Antenna*.

CONDENSER, STATOR OF.—See *Condenser, Design and Construction of*.

CONDENSER, STOPPING.—A condenser used to prevent direct current such as battery current from entering a circuit or part of a circuit is called a stopping condenser. The term blocking condenser is sometimes used and has the same meaning.

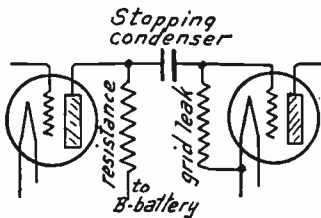

FIG. 1.—Stopping Condenser in Resistance Amplifier.

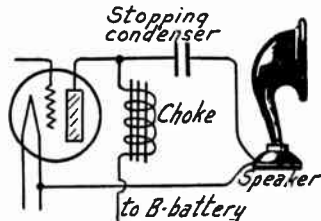

FIG. 2.—Stopping Condenser in Speaker Connection.

The use of a stopping condenser for coupling in a resistance amplifier is shown in Fig. 1. The plate of the left hand tube is connected to the high voltage of the B-battery or power supply through the resistance and to the grid of the following tube through the stopping condenser. Were it not for this condenser the high voltage would pass directly to the grid circuit of the right hand tube.

In Fig. 2 is shown the connection of a stopping condenser used to prevent direct current at high voltage from flowing through the winding of a loud speaker. The tube's plate is connected to the B-battery or power supply through the choke, but the direct current cannot flow to the speaker because of the stopping condenser in the way. The audio frequency current from the plate will, however, pass to the speaker through the stopping condenser as it cannot pass as easily through the choke coil. Stopping condensers are usually of rather large capacity. In radio frequency circuits these condensers are at least .001 microfarad in size; in audio frequency circuits they are from .005 to 1.0 microfarad capacity and for loud speaker use these condensers are one microfarad or larger.

See also *Amplifier, Audio Frequency, Impedance Coupled and Resistance Coupled*.

CONDENSER, STRAIGHT LINE TYPES.—In variable tuning condensers three different styles or types are in use. These

CONDENSER, STRAIGHT LINE TYPES

are commonly called straight line capacity, straight line wavelength and straight line frequency. The abbreviations SLC, SLW and SLF refer to these styles.

When an ordinary tuning dial having graduations from 0 to 100 over half its circumference is attached to one of these condensers the circuit controlled by the condenser may be tuned to various frequencies or wavelengths as the dial is turned. This assumes that the inductance of the coil used with the condenser remains fixed.

With the straight line capacity condenser there is an increase of capacity that is in direct ratio to the increase in dial reading, that is,

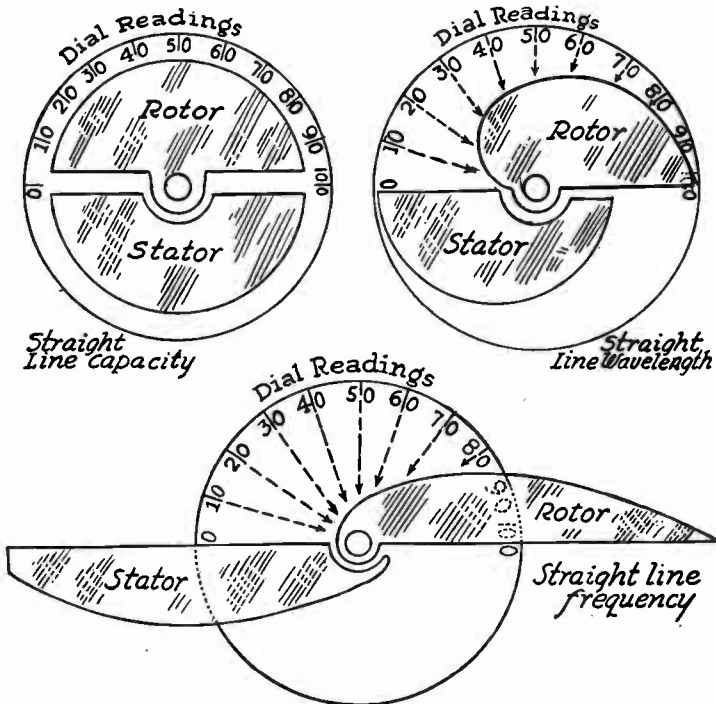

FIG. 1.—Plate Forms of the Different Straight Line Condensers.

at 25 on the dial we have one-quarter of the total capacity of the condenser, at 50 we have one-half the total capacity, at 75 we have three-quarters of the capacity and at 100 we have all of the capacity. The plates for such a straight line capacity condenser are semi-circular as shown in Fig. 1. The capacity increase is in proportion to the area of the stator and rotor plates enmeshed.

The straight line wavelength condenser has plates which are cut off and curved on the entering side, on the side that goes into mesh with the stator plates as the dial reading increases. This is shown in Fig. 1. At first the capacity increases rather slowly but as the

CONDENSER, STRAIGHT LINE TYPES

plates go farther and farther into mesh the capacity increases more and more rapidly, in fact the capacity increases as the square of the dial reading. If the capacity at 25 on the dial is then represented by 625 (or 25 squared) the capacity at 50 is represented by 2500 (50 squared). The capacity of the straight line capacity type is twice as much with the dial at 50 as with the dial at 25, whereas the capacity of the straight line wavelength type is four times as great at 50 on the dial as at 25.

Plates in one type of straight line frequency condenser are sharply tapered as shown in Fig. 1. The increase of capacity is even slower than with the straight line wavelength type as the dial readings increase through the low numbers. The increase of capacity for a given movement of the dial becomes greater and greater as the dial travels toward 100. In this straight line frequency type the increase

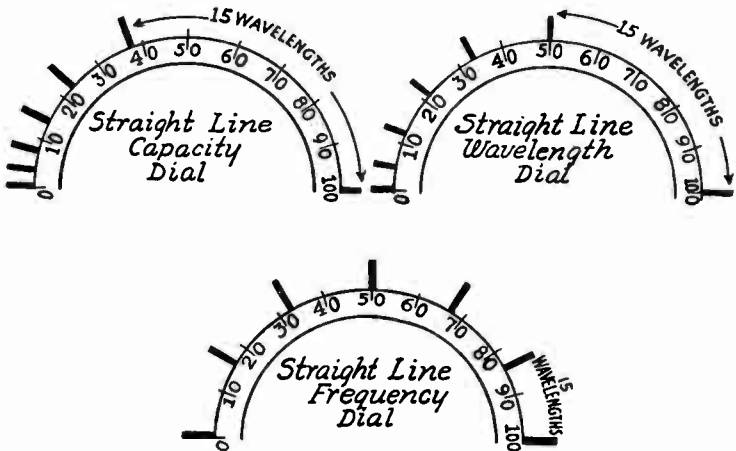

FIG. 2.—Distribution of Frequencies on Three Types of Straight Line Condensers.

of capacity with dial reading is proportional to the reciprocal of the dial reading squared, or is proportional to one divided by the dial reading squared. With this straight line frequency condenser we might represent the capacity at a dial reading of 25 by 18 (approximately). We may then represent the capacity of the condenser with a dial setting of 50 as having reached only 40. At a dial reading of 75 the capacity would then be represented by 160. It will be seen that the increase in capacity at low dial readings is very small but becomes greater as the upper end of the dial is approached.

The assignment of broadcasting stations is still often spoken of according to their wavelength, although they are actually assigned according to frequency in kilocycles. When using a straight line capacity condenser, in which the capacity increases evenly all across the dial, 500 kilocycles in frequency are covered by the first ten divisions on the dial. That is, fifty broadcasting

CONDENSER, STRAIGHT LINE TYPES

frequencies or wavelengths are covered by the first ten divisions on the dial. Then, at the upper end of the dial, only 100 kilocycles or ten broadcasting frequencies are between 55 and 100. This makes a very uneven distribution of stations on the dial because in the first ten points there is a broadcasting frequency for every one-fifth division while in the upper half of the dial the broadcasting frequencies are separated by almost five points. This is shown by Fig. 2, which illustrates the part of the dial movement within which will be found each fifteen broadcasting frequencies or wavelengths. Crowding and separation of the three types are evident.

The straight line wavelength condenser, by increasing its capacity rather slowly, spreads out the frequencies at the lower end of the dial and brings them quite a little closer at the upper end as compared with the straight line capacity type. With the straight line wavelength condenser there are 200 kilocycles or twenty broadcasting frequencies in the first ten points and the last 100 kilocycles or ten frequencies are included between 75 and 100 in place of between 55 and 100. This also is shown in Fig. 2.

The straight line frequency condenser increases its capacity with dial readings at such a rate that stations separated according to kilocycles are evenly spaced from each other all the way across the dial. That is, the same number of broadcasting frequencies or wavelengths are between zero and ten on the dial as between ninety and one hundred. This even separation of stations is an undoubted advantage.

For those familiar with the wavelengths of broadcasting stations the following table gives a graphic view of the difference between the three types of condensers. The frequency in kilocycles is given in the first column, the meters of wavelength are shown in the second column and toward the right in three columns for the three types of condensers are shown dial readings at which these frequencies or wavelengths would be tuned in under ordinary conditions:

Frequency in Kilocycles	Wavelength in Meters	Dial Readings		
		SLC	SLW	SLF
1500	200	2	3	4
1000	300	10	27	42
750	400	28	52	74
600	500	55	76	90
500	600	100	100	100

All straight line wavelength condensers do not have plates shaped as shown in Fig. 1. Square plates as in Fig. 3 may also be used since their increase of capacity as they are drawn together will be proportional to the square of the dial reading.

Both straight line wavelength and straight line frequency condensers may have semi-circular rotor plates and may have their stators shaped to give the required gradual increase in capacity with dial reading. This method is illustrated in Fig. 4.

An idea of the capacity change required to tune between frequencies ten kilocycles apart may be gained when it is mentioned that to change from a frequency of 1500 kilocycles to one of 1490 kilocycles calls for an increase in tuning condenser capacity of only

CONDENSER, STRAIGHT LINE TYPES

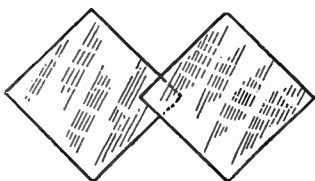

FIG. 3.—Square Plates for Straight Line Wavelength Condenser.

three-quarter micro-microfarad when using a condenser whose maximum capacity is 500 micro-microfarads. But to change from 560 kilocycles to 550 kilocycles calls for an increase of thirty-five micro-microfarads in the same condenser.

It should be understood that, while the straight line frequency condenser gives a greater separation between the settings of the stations at low wavelengths, it does not actually increase the selectivity of the receiver.

That is, the stations themselves are separated by ten kilocycles of frequency and the kind of condenser used has no effect on this station separation. It does become easier to tune in and to separate stations among the low wavelengths because the straight line frequency condenser provides a greater dial movement between the frequencies than is secured with other types.

As may be seen from Fig. 1, a straight line frequency condenser designed so that the shape of the rotor plates alone is depended on to give the frequency characteristics will be extremely wide. This disadvantage is overcome to a certain extent by shaping the stator plates as in Fig. 4.

The straight line frequency condenser may also be made more compact by using a greater number of smaller plates for a given capacity as in Fig. 5. A design which allows the condenser to be of the straight line frequency type, yet use semi-circular plates, is shown in Fig. 6. Here the thickness of both rotor and stator plates

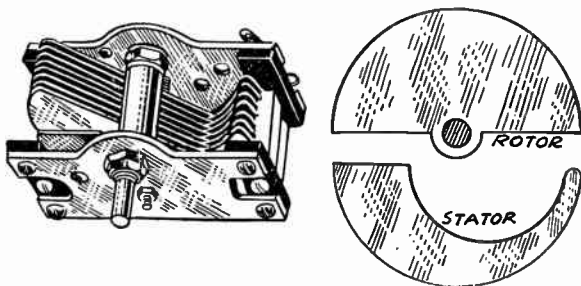

FIG. 4.—Stator Plates Shaped for Straight Line Frequency Condenser.

changes from one side to the other. As these plates are meshed it will be seen that the spacing between them, or the thickness of the air dielectric becomes less and less so that the capacity is increased by the increasing mesh of the plates and by the thinning of the dielectric space at the same time.

In a straight line frequency condenser having sufficient maximum capacity for tuning purposes, it is difficult to have a small enough minimum capacity to give a full range of tuning over the entire broadcasting range of frequencies. Even with the plates entirely

CONDENSER, STRAIGHT LINE TYPES

out of mesh there is a considerable capacity effect remaining between them because the condenser still consists of two metal parts separated by a dielectric of air. Because of this limitation and also because of the greater bulk of straight line frequency designs for a given capacity, such condensers are generally built with maximum

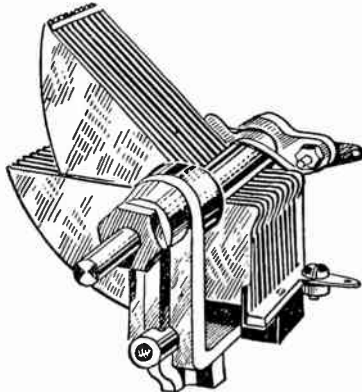

FIG. 5.—Increased Number of Plates to Secure Compactness in Straight Line Frequency Condenser.

capacities of .00035 microfarad and less. The .0005 microfarad size is comparatively rare and the .001 microfarad capacity straight line frequency condenser is not used at all.

In changing from straight line capacity or wavelength condensers to straight line frequency types in a receiver already built it is necessary to make sure that the coils are large enough to operate

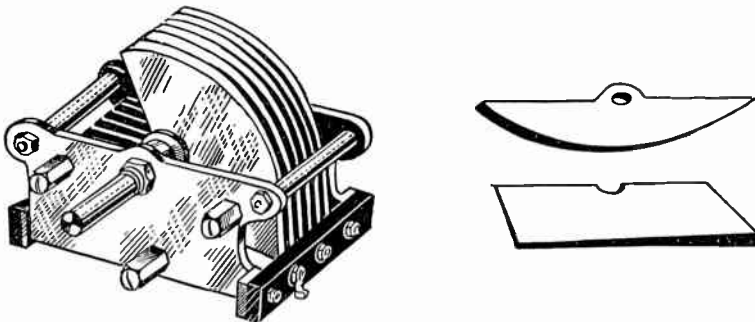

FIG. 6.—Thin Edge Plates for Straight Line Frequency Condenser.

with one of the available sizes of the newer condensers. See *Coil, Tuning, Sizes Required for*.

Because of the great length of the plates in true straight line frequency condensers a majority of units which are called "straight line frequency" are in reality only a modified type. The portions of the plates that come together

CONDENSER, TANDEM

first, for tuning low wavelengths, are of real straight line frequency characteristic. But the outer ends of the plates are a compromise between straight line frequency and straight line wavelength types. This can be seen in Fig. 7. This makes a very satisfactory kind of condenser from the standpoint of the operator. Such types are sometimes called "straight line tuning" or "SLT" condensers.

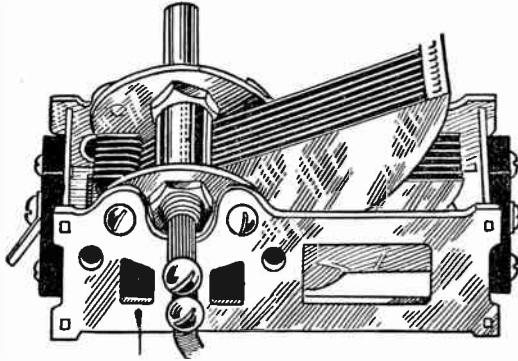

FIG. 7.—Modified Straight Line Frequency Condenser.

The long narrow plates of straight line frequency condensers are usually tied together at their outer ends to provide rigidity and permanent alignment between stator and rotor. This also is shown in Fig. 7.

CONDENSER, TANDEM.—See *Condenser, Multiple Types*.

CONDENSER, TUNING.—Any variable condenser of sufficient range may be used for tuning. In practice, variable tuning condensers are always of the multi-plate type with air dielectric.

With a fixed inductance or coil and a variable condenser the capacity must change according to the square of the change in wavelength. For instance, if the range of wavelength to be covered is from 200 to 600 meters we have a change in the condenser equal to the squares of one and three or a change of one to nine. To cover the broadcasting band between 200 to 600 meters the maximum capacity of a condenser must be at least nine times its minimum capacity. Because of the distributed capacity or minimum possible capacity of the condenser it is necessary that the condenser capacity have a range of at least one to ten or even more in total variation to cover the broadcasting band. See *Resonance, Inductance-Capacity Values for*.

A fixed condenser may be connected in parallel with a variable tuning condenser to increase the maximum capacity available for tuning. The maximum capacity of the combination will then be the former maximum of the variable condenser plus the capacity of the fixed condenser. The minimum of the combination will be the former minimum of the variable condenser plus the total capacity of the fixed condenser.

To reduce the minimum capacity of any condenser another fixed condenser may be connected in series with the first one. The maximum capacity of the combination will be less than the maximum capacity of either condenser alone, this being shown by the table of combined capacities under *Condenser, Capacity of*.

CONDENSER, VARIABLE

CONDENSER, VARIABLE.—Any condenser whose effective capacity may be changed while the condenser is being used in a circuit is a variable condenser. As a rule, such condensers are made continuously variable so that the capacity may be gradually increased or decreased, not changed by more or less abrupt steps.

While the great majority of the variable condensers are of the multi-plate, air dielectric type, other constructions are available and are sometimes used. Variable condensers are used for all purposes which require a change of capacity. They are used for tuning purposes, for control of regeneration and feedback, for changing the frequency of the antenna circuit, for balancing condensers, for throttling condensers, and for various other uses throughout the radio receiver.

Screw Type Condenser.—A compact form of variable condenser may be made as in Fig 1. One of the plates, of which but two are used, is fixed in position. The other plate is formed of a disc of thin spring brass split on one side so that it tends to spring

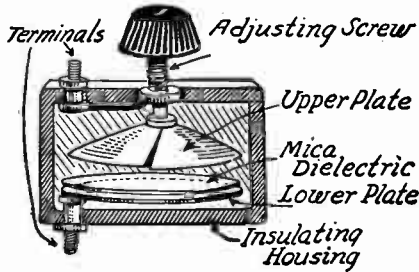

FIG. 1.—Screw Type of Variable Condenser.

up into a conical shape. Between the two plates is a very thin disc of dielectric mica. A screw which may be turned by an external knob within reach of the operator presses the brass disc down closer and closer to the stationary plate, thus increasing the capacity of the condenser. Such a design gives a very gradual change of capacity since it requires several complete turns of the knob to pass from minimum to maximum capacity. The losses in a well built unit of this kind are low enough to allow its successful use in radio frequency circuits.

Book Type Condenser.—Fig. 2 shows one of the first forms of variable condenser used for tuning purposes, this being called the book type condenser on account of its resemblance to the leaves of a book. The metal plates of the condenser are attached to the inner surfaces of two hinged blocks with a sheet of mica or glass dielectric hinged loosely between them or fastened to one of the plates. Bringing the two plates closer together increases the capacity. The hinged plates are normally pressed apart by a spring and are moved together by a screw or cam attached to the operating dial.

CONDENSER, VARIABLE

Compression Type Condenser.—The condenser shown in Fig. 3 consists of a number of plates having mica or glass dielectric sheets between them. The plates are normally forced apart by a series of springs between adjacent plates and are pressed together by a screw operated by a dial or knob.

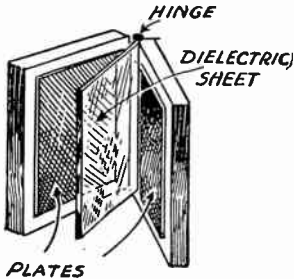

FIG. 2.—Book Type of Variable Condenser.

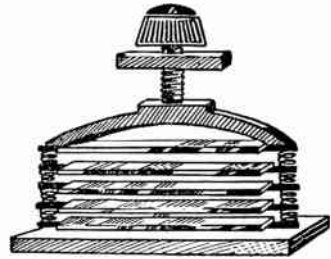

FIG. 3.—Compression Type of Variable Condenser.

A variation of this type is made as shown in Fig. 4. Here there is a stationary bottom plate covered with a thin sheet of mica dielectric. The upper plate is of spring brass formed into a curve so that, when fastened to the lower plate at one edge, the remainder of the top plate tends to curl away from the bottom plate. A slider is arranged to move across the springy top plate and press it down onto the dielectric, thus increasing the capacity. This type may be made in a circular form with the plates formed of rings which are pressed or rolled together by the slider.

Mercury Condenser.—Fig. 5 shows a mercury type of variable condenser. The two plates are formed of half circles of metal attached to insulating plates or discs. Approximately one half of the supporting discs are immersed in a bath of mercury. A thin layer of air between the plates acts as the dielectric. As the discs are rotated, more and more of the surface of the plates is carried down into the mercury, leaving a smaller and smaller area of the plate

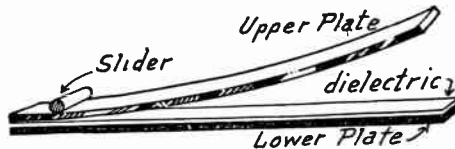

FIG. 4.—Compression Variable Condenser Operated with Slider.

surfaces above the mercury with air between them. The plate area is thus reduced and the capacity of the condenser is decreased. The two rotating discs are, of course, operated from a dial.

Dovetail Condenser.—The condenser shown in Fig. 6 consists of two large plates, one made up of a series of cylindrical concentric rings, the other of a corresponding series of cylindrical grooves or depressions into which the rings will fit.

CONDENSER, VERNIERS FOR

The grooved portion forms the stator of the condenser and is mounted upon a panel or other support. The set of rings on their base form what corresponds to a rotor. They are arranged to slide back and forth, away from or toward the stator. The movable unit

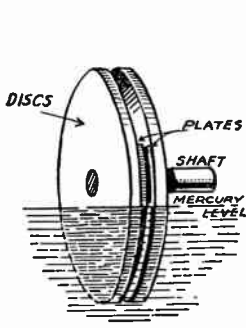

FIG. 5.—Mercury Type of Variable Condenser.

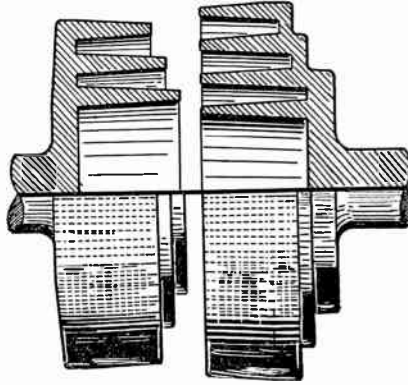

FIG. 6.—Dovetail Type of Variable Condenser.

is operated by a shaft having a very coarse screw thread which engages the plate unit. The shaft is turned through one full revolution or 360 degrees in bringing the condenser parts closely in mesh or moving them apart to their maximum separation.

With the two plate units close together maximum capacity is obtained. With the movable unit all the way back, the condenser is at minimum capacity. Such a design may be made to act as a straight line capacity condenser, a straight line wavelength condenser or a straight line frequency condenser. The type depends on the shaping of the rings and grooves.

CONDENSER, VERNIERS FOR.—There are two principal methods of providing a vernier effect for tuning condensers. In

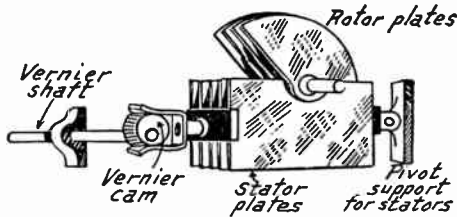

FIG. 1.—Hinged Condenser Plates with Cam Vernier.

order to do effective tuning on distant and weak broadcasting stations it is necessary to obtain a very accurate adjustment of the tuning condenser. A simple dial attached directly to the condenser shaft cannot be moved slowly enough or moved a small enough part of a turn to bring in such distant stations most effectively. To overcome this handicap vernier motions have been introduced so that a comparatively large movement of the tuning control makes

CONDENSER, VERNIERS FOR

only an exceedingly small movement of the condenser plates with reference to each other. Either the stators or the rotors may be affected by this vernier action.

In Fig. 1 is shown one method of obtaining a small movement of the stator plates. The rotors are carried in the usual manner on their shafts but the stators are provided at one side with a pivoted or hinged support. The other side of the stator plates is supported by an offset cam between two arms attached to the edges of the plates. Turning the vernier shaft rotates this cam so that the stator plates are moved up or down a very little bit with reference to the rotors. Turning of the rotor plates for rough tuning is not affected or altered in any way.

A method of obtaining a vernier action on the rotor plates is shown in Fig. 2. Two arms are clamped around one end of the shaft. A tension screw draws these two arms tightly enough around the shaft to cause considerable friction between arms and shaft. The

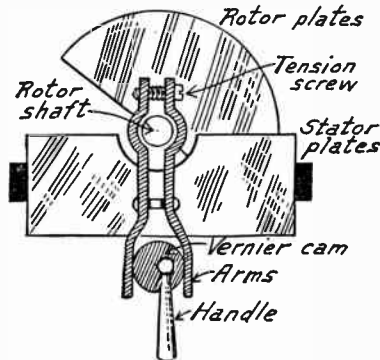

FIG. 2.—Cam Vernier for Moving Condenser Rotor Plates.

lower ends of these arms pass on either side of a cam to which is attached the vernier handle. Moving the vernier handle rotates the cam and imparts a very small motion to the arms, the rotor shaft and plates. The pressure of the arms is adjusted by the tension screw so that the vernier cam will move the plates but so that the main tuning dial can rotate with comparative freedom for rough tuning.

A geared type of vernier is shown in Fig. 3. Here a large gear is attached to one end of the rotor shaft and in mesh with this gear is a small pinion held in engagement with the gear by means of a tension spring. The pinion shaft extends out through the panel and ends in the vernier knob. The gear reduction in such devices is generally between five to one and twelve to one so that very small movements of the rotor plates may be obtained.

Still another method of obtaining fine tuning is by the use of an auxiliary variable condenser of small capacity connected in parallel with the main tuning

CONDENSER, VERNIERS FOR

condenser as shown in Fig. 4. After the main tuning condenser is brought to a rough setting the final tuning is done by means of the small auxiliary condenser or vernier condenser.

It is rather poor practice to use an additional small condenser in parallel with a larger tuning condenser for the purpose of obtaining fine tuning or obtaining a vernier action. The two condensers in parallel add their minimum capacities together, consequently the minimum capacity of the combination is

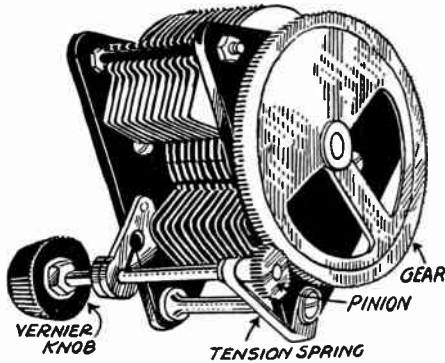

FIG. 3.—Geared Vernier for Tuning Condenser.

equal to the sum of the minimum capacities of the two condensers rather than being equal only to the minimum capacity of the tuning condenser. This makes it more difficult to tune to the higher frequencies or low wavelengths.

The effect of the small parallel vernier condenser is not the same at all frequencies. At low frequencies or high wavelengths, adding or subtracting the capacity of the vernier condenser has comparatively small effect because at low frequencies almost all of the capacity of the large tuning condenser is being

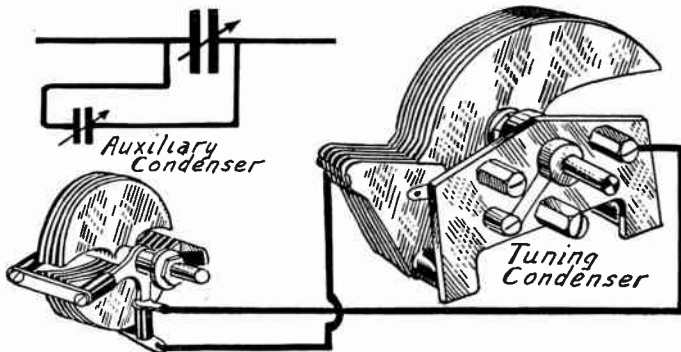

FIG. 4.—Auxiliary Condenser Used as Vernier for Fine Tuning.

used and the percentage of the total capacity represented by the vernier condenser is small. On the other hand, at high frequencies or low wavelengths only a small part of the total capacity of the main tuning condenser is in use and adding or subtracting the whole capacity of the vernier condenser has a very great effect on tuning.

The perfection of tuning dials which incorporate a vernier action or reduction of motion within themselves has to a great extent done away with the use

CONDENSITE

of vernier mechanism built into the condensers or of auxiliary vernier condensers. See *Dial, Tuning, Vernier*.

CONDENSITE.—See *Phenol Compounds*.

CONDUCTANCE.—The ability of a conductor to carry an electric current is called conductance. It is measured in mhos and is the opposite of resistance.

CONDUCTANCE, MUTUAL, OF TUBE.—See *Tube, Mutual Conductance of*; also *Tube, Characteristics of*.

CONDUCTIVE COUPLING.—See *Coupling, Conductive*.

CONDUCTIVITY.—The conductance measured in mhos through a centimeter cube of a conductor is called the conductivity or specific conductance of that conductor. Conductivity is a measure of the current carrying ability of a certain size of conductor.

CONDUCTOR.—Any path through which an electric current may flow with comparatively little resistance is called a conductor. The best conductors are of metal. All wires used in radio work are conductors.

CONE SPEAKER.—See *Speaker, Loud*.

CONFINED FIELD.—See *Field, Stray and Confined*.

CONNECTOR.—When it is desired to join two wires crossing each other at an angle or when it is desired to attach the end of one wire to some point along the length of another wire as in the illustration, a neat, permanent and workmanlike joint may be made by using soldered or solderless connectors made especially for this pur-

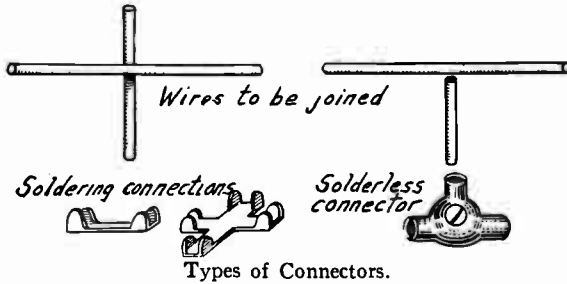

Types of Connectors.

pose. A solder type of connector consists of a piece of thin tinned brass or copper with the ends formed into lips or ears. These lips are turned up around the wires to be joined, clamped over the wires with pliers, and soldered securely.

Solderless connectors are made in the form of small screw clamps which pass around the wires to be joined and fastened by turning the screw tight.

CONSOLE.—In the language of radio a console is an ornamental combination of a receiver and a cabinet standing from the floor upon its own legs. The console is designed to provide a space for the receiver itself and for batteries or power supply units connected to the receiver. Some consoles are built so that they may

CONSTANT, DIELECTRIC

contain a loud speaker, either a separate speaker simply set into the console or a sound chamber or horn built in as a part of the console's construction. See also *Cabinet*.



Console Type of Cabinet.

CONSTANT, DIELECTRIC.—The capacity of a condenser depends upon the kind of dielectric used between the plates. If a certain condenser with air as the dielectric has a capacity of ten microfarads, substituting mica in place of the air for a dielectric will increase the capacity of the condenser. If the capacity is now measured and found to be sixty microfarads the capacity has been increased six times by using the mica in place of air as the dielectric. The dielectric constant of this mica is then said to be six.

The dielectric constant of any material is the number of times its use as a dielectric will increase the capacity over the use of air as a dielectric in the same condenser. Another name for dielectric constant is specific inductive capacity. A table of the values of dielectric constants of different materials follows.

CONSTRUCTION, RECEIVER

The dielectric constant of any material is a measure of its ability or power to carry the effect of electric charges through it between the plates. This term should not be confused with "dielectric strength" which refers to the strength of the material as an insulator, that is, its resistance to voltage.

The variations between low and high limits of the dielectric constants are due to the differences between grades and qualities of the materials. The constant depends to a great extent on how nearly free from moisture the material is made, since the presence of water will raise the constant materially. The values also depend on whether measurements are made with direct or alternating voltages and if alternating voltages are used the dielectric constant will change with change of frequency.

DIELECTRIC CONSTANTS			
Dielectric Material	Constant	Dielectric Material	Constant
Air (taken as standard) ..	1.0	Oil, neatsfoot	3.0 to 3.2
A reduction of pressure		olive	3.0 to 3.3
below that of the at-		petroleum	2.0 to 2.2
mosphere lowers the		sperm	3.0 to 3.2
constant		transformer	2.4 to 2.7
Alcohol	15.0	turpentine	2.1 to 2.3
Bakelite, C	4.0 to 8.5	Paper, insulating, untreated	1.6 to 2.5
dielectro	5.0 to 7.5	oiled or waxed	2.0 to 3.2
micarta	4.5 to 6.0	cardboard, press-	
Beeswax	3.0 to 3.2	board	3.0
Celluloid	4.0 to 6.0	blotting, porous	5.0
Ceresin Wax	2.5	Paraffine wax	2.0 to 2.5
Collodion	3.7 to 4.0	Phenol composition,	
Cloth, oiled or varnished	3.0 to 5.0	moulded	5.0 to 7.5
Ebonite (see <i>Rubber, hard</i>)		Porcelain	4.0 to 6.0
Fibre, uncolored	5.5	Quartz	4.5 to 5.0
black	7.5	Resin	2.5
red	5.0 to 8.0	Rubber, gum	2.3
Film, photographic	6.8	soft vulcanized	2.0 to 3.0
Gelatine	4.0 to 6.0	hard	2.0 to 3.5
Glass, window	7.5 to 8.0	Shellac	3.0 to 3.6
plate	3.0 to 7.0	Silk	4.6
heat resisting	5.0 to 6.0	Slate, electrical	6.0 to 7.0
Gutta percha	3.0 to 5.0	Sulphur	2.5 to 4.0
Isolantite	3.6	Varnish	4.5 to 5.5
Marble	9.5 to 11.5	Vaseline	2.0
Mica, sheet	3.0 to 6.0	Water, distilled	81.0
built up	5.0 to 6.0	Wood: bass, cypress, fir	2.0 to 3.0
Oil, castor	4.5 to 4.8	maple	2.5 to 4.5
cottonseed	3.0 to 3.3	oak	3.0 to 6.0

CONSTRUCTION, RECEIVER.—The construction of a receiver naturally divides itself into four steps: First; deciding upon the type of circuit, the number of radio frequency stages and the number of audio frequency stages. Second; the layout or general arrangement of the parts required for the chosen design. Third; the assembly of these parts. Fourth; the wiring.

It may be assumed that the type of circuit or kind of receiver has been decided upon. It will be made up of a considerable number of major and minor parts. The major parts will determine the most advantageous layout and the minor parts or the auxiliaries must be grouped around the principal ones.

CONSTRUCTION, RECEIVER

The major parts, the parts which determine the general plan or arrangement of the whole, are: The tuning condensers, the radio frequency couplers which are tuning coils or radio frequency transformers, the audio frequency couplers (transformers, chokes or resistances) and the tubes. These are the parts which must be given

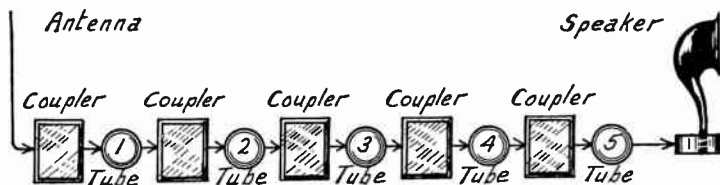

FIG. 1.—Process of Amplification Considered in Receiver Construction.

greatest consideration and when they are properly placed the smaller units must be located so that they will operate properly with the larger pieces.

Interior Arrangement.—The signal comes from the antenna or the loop, passes through the receiver, and is delivered to the loud speaker. Between antenna and speaker there must be amplification,

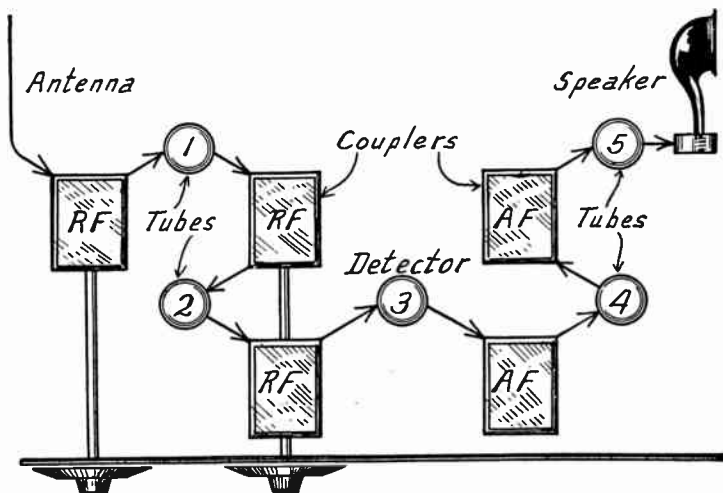

FIG. 2.—Compactness in Receiver Design and Construction.

which is secured by one or more stages of radio frequency amplification, a detector, and one or more stages of audio frequency amplification. Each stage of amplification consists of a vacuum tube and a coupling device which takes the output of this tube and passes it on to the next tube. The scheme of amplification in a receiver is indicated in Fig. 1. Any of the tubes shown might be a detector. Everything from the antenna to the detector is in the radio fre-

CONSTRUCTION, RECEIVER

quency portion of the receiver and everything between the detector and the speaker is in the audio frequency portion.

In general it is desirable to carry out the design in as nearly a straight line as possible, such a straight line of amplification as shown in Fig. 1. The receiver may be made shorter and deeper by some such arrangement as indicated in Fig. 2, thus maintaining the general idea of passing the signal as directly as possible through all the stages. All parts operating at radio frequency are at the left of the detector and all operating at audio frequency are at the right.

It is also desirable to keep the radio frequency and the audio frequency parts well separated from each other. Therefore, the arrangement of Fig. 3 would not be satisfactory without proper shielding because the output for the speaker is brought back near the input from the antenna. With shielding between audio and radio frequency this plan is satisfactory. The arrangement of Fig. 4 is symmetrical and looks well because all of the tubes are in a line

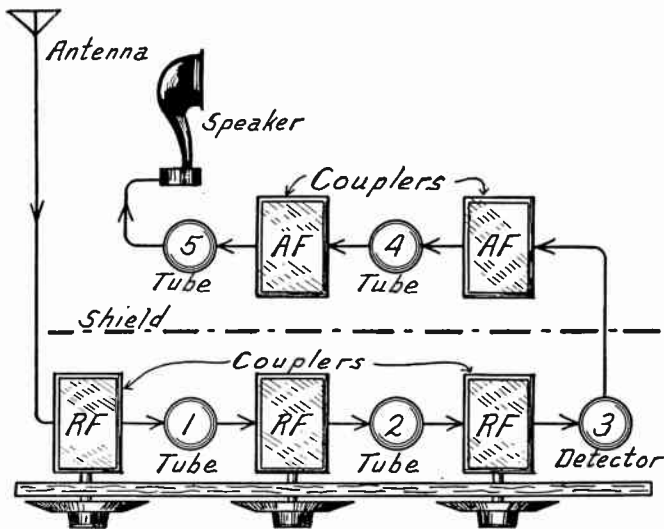

FIG. 3.—Shielding Between Radio Frequency and Audio Frequency Parts.

and the couplers are evenly spaced. It is bad electrically and will usually be difficult to operate with any degree of satisfaction.

If shielding is to be used, the parts must be arranged in such a manner that the shields can come in the right places. If each stage of radio frequency amplification is to be completely enclosed in a shield the coupler and the tube for each stage must be placed to allow the shield around them. With tuning by means of a variable condenser the shield must enclose the tuning condenser, the tuning coil and the tube as shown in Fig. 5. It is not necessary that the condenser, coil and tube be placed exactly as shown in Fig. 5, but they must be placed so that all three may be enclosed in a shield.

The next thing that must be taken into consideration is whether two or more tuning devices are to be operated from one control. The plan shown in Fig. 2 allows three tuned stages to be handled

CONSTRUCTION, RECEIVER

with two controls. One control operates the tuner or coupler attached to the antenna while the other control operates the remaining two radio frequency tuners or couplers together.

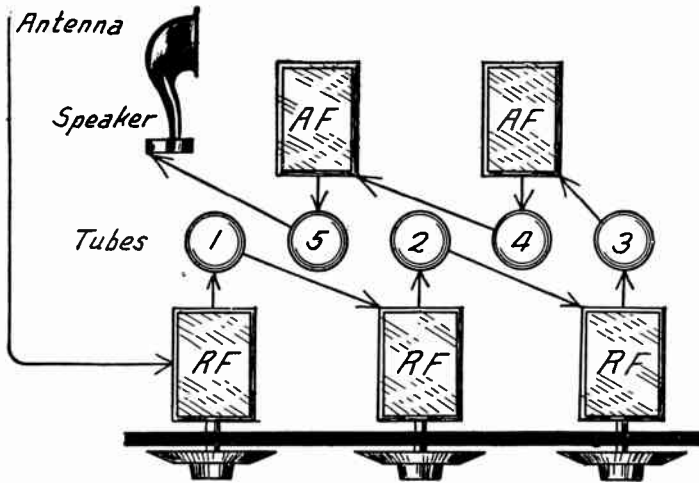

FIG. 4.—A Construction Which Is Poor Electrically.

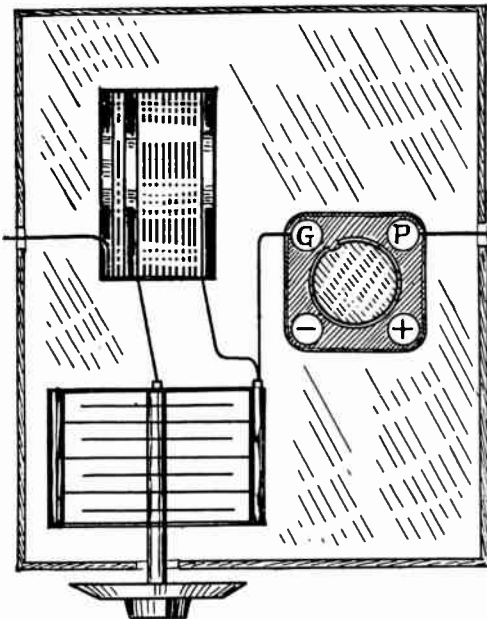

FIG. 5.—Arrangement of Parts for Shielding.

CONSTRUCTION, RECEIVER

Where three tuning elements are to be handled from one control they may be placed one behind the other so that they are in line from front to back or they may be placed end to end lengthwise of the receiver. One general plan for the front to back arrangement is shown in Fig. 6. The radio frequency transformers or couplers are marked "RF," the audio frequency couplers (transformers, chokes or resistances) are marked "AF" and the tubes are numbered with the order in which the signal passes through the receiver from antenna to speaker. There is seldom room in any ordinary cabinet for more than three tuning controls arranged in line from front to back.

Any number of tuning units may be placed on a single shaft running lengthwise of the panel as shown in Fig. 7. Here the tubes from number 1 to number 4 are radio frequency amplifiers, number 5 is a detector and numbers 6 and 7 are audio frequency amplifiers.

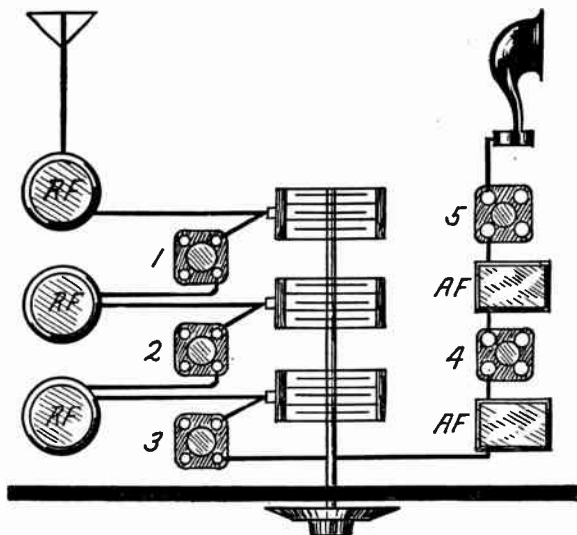

FIG. 6.—Three Tuned Stages on One Control Shaft.

Panel Arrangement.—After the general plan for the interior of the receiver has been decided upon its effect on the controls must be considered. Many receivers are built with the appearance of the cabinet and the panel as first considerations, everything else being of minor importance. This, of course, is wrong and it is also needless. There is no reason why a thoroughly efficient receiver cannot be designed to allow the use of pleasing proportions in the cabinet and of a symmetrical arrangement of panel controls.

The number and kind of controls will depend on the type of receiver being built. The simplest panel arrangement would include one tuning control, one volume control and a switch for placing the receiver in operation. Starting from this acme of simplicity, more and more controls may be added until the panel is completely filled. The average modern receiver will have two tuning controls, one or

CONSTRUCTION, RECEIVER

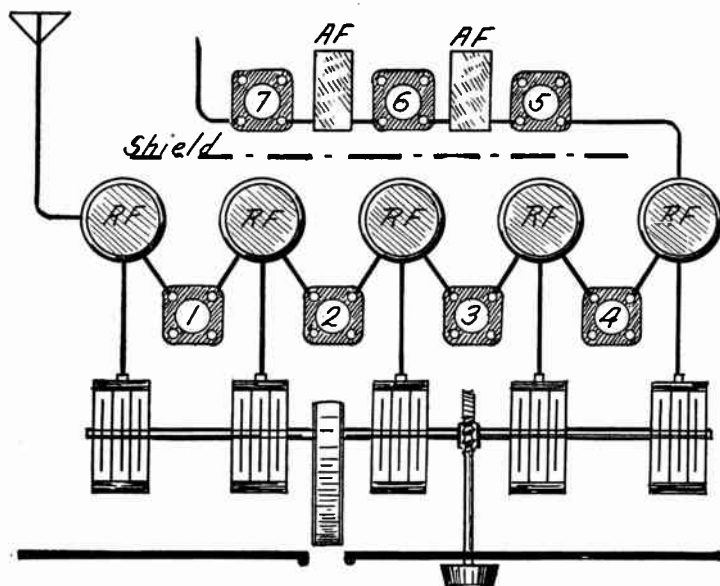

FIG. 7.—Single Control with More Than Three Stages.

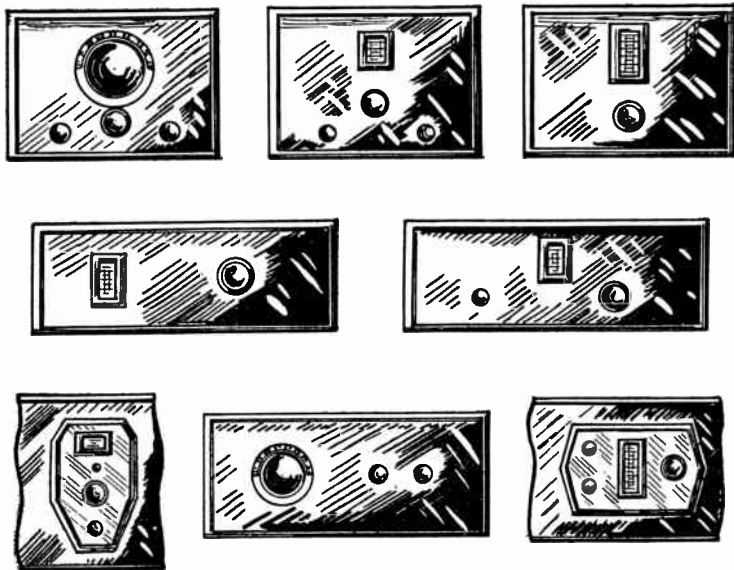

FIG. 8.—Panel Layouts for Single Control Receivers.

CONSTRUCTION, RECEIVER

two volume or regeneration controls and a switch. Many of the older receivers have three tuning dials and from two to five rheostats, regeneration knobs and miscellaneous switches.

With two or more tuning controls, the closer the dials or indicators are to each other the easier will be the work of the operator. It is not convenient to have to glance from one side of a receiver way over to the other side when tuning two or more controls to certain settings.

There should be some support on which the operator's hand or forearm may rest while tuning. It is tiring to have to hold the entire hand and arm up in the air while adjusting the controls. This support may be a drop front of a console, the top of a table carrying a radio cabinet, or only a ledge of some kind. The knob or dial which is grasped by the operator when moving the controls should be at such a height above the natural support that it is not

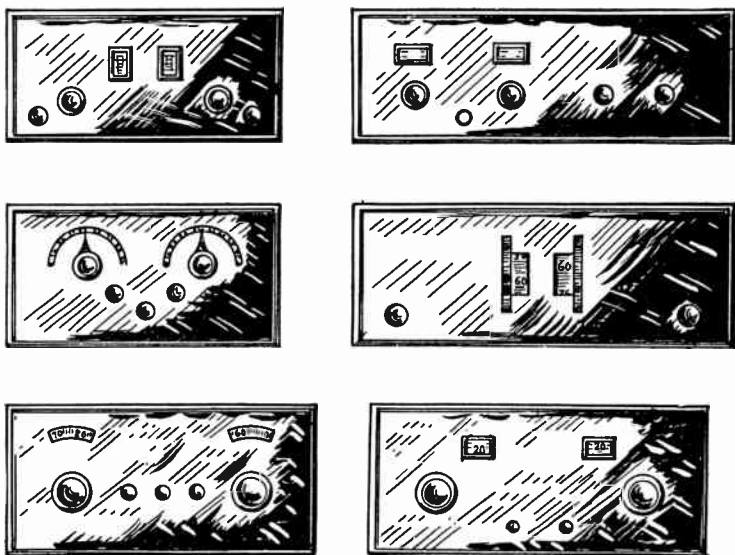

FIG. 9.—Panel Arrangements for Two Tuning Controls.

necessary to raise the arm in the air. The knob, handle or dial to be moved should be from two to five inches above the surface of the support if a great deal of tuning is to be done without fatigue of the arm and hand muscles.

A number of panel layouts for receivers with but one tuning control are shown in Fig. 8. With the numbered scale concealed behind a panel and with the setting visible through a window there is always a knob by means of which the operator rotates the scale. Panel layouts for two tuning controls are shown in Figs. 9 and 10. These include types with concealed scales and with exposed dials. The arrangements are typical of those used with many commercial receivers but are, of course, subject to wide variations to suit different constructions. In Fig. 11 are layouts for three tuning controls with various kinds of dials and scales.

CONSTRUCTION, RECEIVER

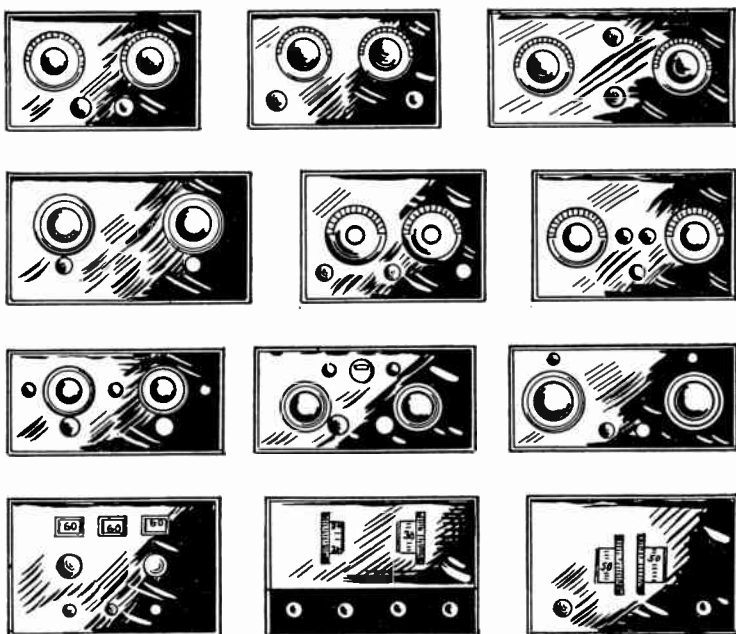

FIG. 10.—Panels for Two Control Receivers.

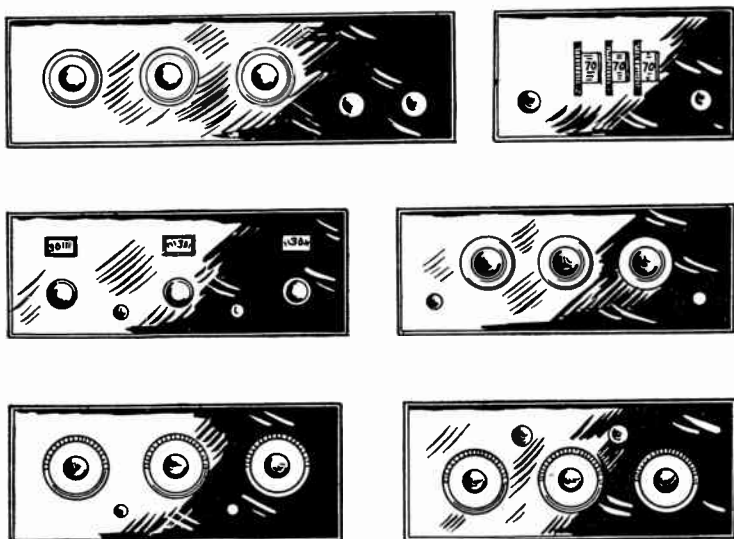

FIG. 11.—Panels with Three Tuning Controls.

CONSTRUCTION, RECEIVER

In all of the panel arrangements it will be noticed that controls of similar size and appearance are laid out in line with one another. Two or more straight lines drawn either horizontally or vertically across the panels will pass through the centers of all the controls. For the sake of appearance this rule for line-up should be followed.

With the interior plan tentatively decided upon it is possible to figure out a panel arrangement which will suit the general location of tuning and control units called for. Some adjustment between the two plans will then be called for after which the front panel may be laid out to show the centers of all shaft holes and mounting holes.

Sub-panel and Base.—So that the receiver may be built as a complete unit separate from the cabinet the entire construction is usually carried out on the main panel or front panel and a sub-panel as shown in Fig. 12. The sub-panel forms a kind of shelf which carries the coils, transformers, chokes, tube sockets, resistors and most of the wiring. A bracket of metal or wood attaches to both panels, supporting the sub-panel from the bottom of the cabinet and holding the front panel in its proper place and at the proper angle.

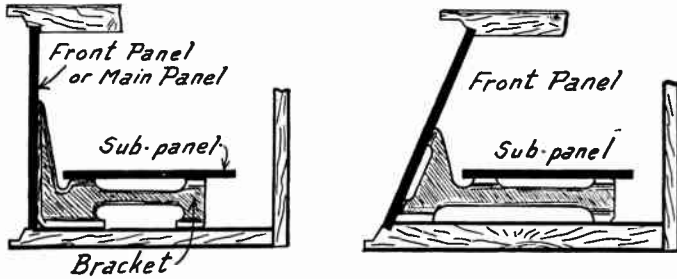

FIG. 12.—Sub-Panel Construction for Receivers.

If it is not required that the receiver be removable as a unit from the cabinet, the sub-panel may be dispensed with and all of the units not carried by the front panel then mounted directly on the wood bottom of the cabinet. This method saves something in first cost but is inconvenient. Receivers may be designed so that all units are supported from the front panel. This requires that some rather heavy parts be carried on the panel and with some panel materials there will be considerable sagging and warping. Many of the newer receivers are constructed upon a steel or aluminum frame-work which carries the condensers, coils, tubes and transformers and to which is attached the front panel.

If a sub-panel is used it is possible to place many parts underneath so that the interior appearance is greatly improved. These parts include bypass condensers; choke coils; jacks and jack switches; rheostats; audio frequency transformers, chokes and resistances; controls for volume and for regeneration; and all wiring. Such parts as filament control resistors, balancing condensers, grid leaks and fuses should not be placed underneath the sub-panel because it is often necessary to reach them in making service adjustments. The following parts are usually mounted on the front panel: Tuning condensers; coupling or selectivity controls; voltmeters or ammeters; panel or pilot lamps; control knobs for volume and regeneration; rheostat knobs; and switches. Some of these parts will be above the sub-panel level and others will be below.

CONSTRUCTION, RECEIVER

The sub-panel brackets should come as nearly as possible underneath the heaviest units, which will usually be the audio frequency couplers, transformers or chokes. The thicker the material used for the sub-panel, the farther apart the brackets may be placed. A span of fifteen inches is about the maximum distance between supports if sagging and deformation is to be avoided. Phenol compounds, such as Bakelite, have the stiffness and mechanical strength required for sub-panel work. Hard rubber has a decided tendency to change its shape under the continued action of weight.

Tube Sockets.—The sockets should be placed so that the shortest possible distance is obtained between their grid terminals and the parts to which the grid lines run. The length of plate leads and their separation from grid lines should also be given careful consideration in placing the sockets. These points are illustrated in Fig. 13. The position of the socket filament terminals is of no importance and is determined by the requirements for grid and plate terminals.

In placing the detector socket it must be remembered that a grid leak and condenser will be connected to the grid terminal. These

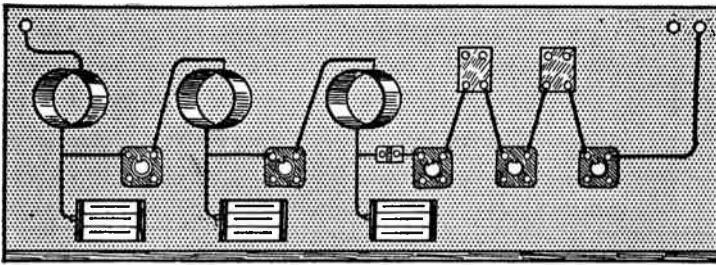

FIG. 13.—Parts Arranged for Shortest Grid and Plate Connections.

parts should be accessible and sufficient room must be left around one side or corner of the tube to take whatever type of leak and condenser are employed. It is also necessary to figure on a small bypass condenser on the plate side of the detector. Many receivers place a radio frequency choke coil between the plate terminal of the detector and the first audio frequency coupling unit. All of these accessories which are attached to the detector call for more room around its socket than around the other sockets.

Many types of sockets allow the grid and plate leads to be taken from their top while the two filament leads are taken from below. This is especially convenient when shielding is used, since the grid and plate leads may be kept inside the shield and the filament lines may be run on the outside. The necessary change of terminal arrangement can often be made by simply reversing the screws in the sockets.

The tube sockets may be placed close to tuning condensers or may be placed between these condensers. They should, however, be placed so that the tubes are not within the strongest part of the fields of tuning coils. Sockets should be placed at the sides of coils and not in line with the axes of coils carrying high frequency currents. See *Coil, Mounting of*.

CONSTRUCTION, RECEIVER

The final precaution in locating the sockets is to keep the grid wires away from the front panel. Grid wires running close behind an unshielded panel will generally cause considerable body capacity effect. The grid connections to the tuning condensers should be the only wires of this kind brought near the front panel.

Binding Posts.—All of the binding posts are generally placed along the rear edge of the sub-panel so that battery wires, power supply wires, and speaker wires may be brought through openings in the cabinet directly to the posts. The position of the battery posts should be chosen to allow the most convenient wiring to the switches, tube sockets, rheostats, transformers, etc., to which they attach. The posts for the antenna or loop connections should be at least one inch from all other posts. It is not necessary that the ground post be near the antenna post. One of the speaker posts will often be connected directly to the high voltage B-battery or power supply post, consequently these two posts should be next to each other. The same rule applies to the C-battery or grid bias positive post and the A-battery or filament supply negative post

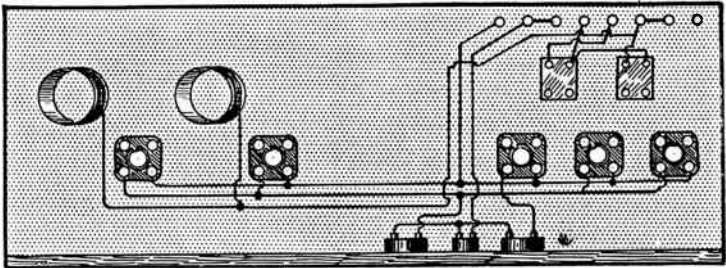

FIG. 14.—Filament and Plate Supply Wiring Arranged for Cabling in Receiver Construction.

since these two are connected together. Such an arrangement is shown in Fig. 14.

Location and Mounting of Units.—Instructions for handling the radio frequency coils or transformers are given under *Coil, Angle of Mounting and Coil, Mounting of*. Tuning condensers, unless shielded, should have at least two inches clear space between the nearest parts of adjacent units. If a loop is used the instructions under *Loop, Precautions in the Use of* should be followed.

Audio frequency transformers may be placed close together and with no regard to their positions relative to one another. This applies to transformers, and to chokes as well, when they are completely enclosed in metal shields. When using more than two stages of audio frequency amplification the shields should be grounded. With unshielded audio frequency couplers it may be necessary to allow an inch or more separation between them and to place them so that the axes of their coils are at right angles.

Output transformers or output chokes and condensers for the

CONSTRUCTION, RECEIVER

loud speaker should be kept well away from other parts of the receiver. Leads to the speaker itself should run directly out of the cabinet and should not be carried around the other wiring. If power supply units are placed in the same cabinet with the receiver, these units should be located at the radio frequency end and not near the audio frequency parts because there will be less tendency to pick up the low frequency hum with this arrangement. All wires carrying alternating current for power supply should be of twisted pair to prevent radiation at the frequency of the power circuit.

Any storage battery gives off fumes which are ruinous to metal parts of a receiver. Therefore, all such batteries must be in compartments completely separated from the receiver and well ventilated to get rid of the fumes. This applies to storage batteries, either for filament or plate supply, and to filament power supply units which contain a small storage battery as part of their construction.

The sockets should be placed so that all of the filament wiring may be run together and cabled, such an arrangement being shown

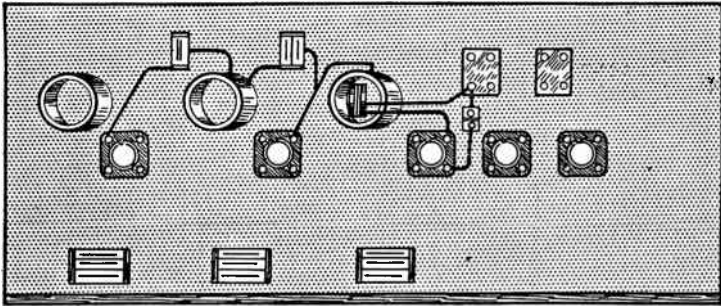

FIG. 15.—Regeneration Controls Kept Away from Panel in Receiver Construction.

in Fig. 14. Connections running from coupling units to the terminals for B-batteries or power supply units should be run with the filament wiring. The filament circuits include all rheostats, filament resistors and switches.

Small condensers or resistances for control of oscillation and regeneration, also the wiring attached to them, should be kept well back from the panel whenever this is at all possible. The same rule applies to tickler coils and their connections. Such practice is shown in Fig. 15.

Related Subjects.—The following list of headings shows the subjects which are of interest when designing and constructing a complete receiver:

Amplifier, Audio Frequency
Amplifier, Radio Frequency
Balancing
*Battery, Connections of A-
and B-*
*Bias, Grid, Methods of Obtain-
ing*

Cabinet
Coil, Angle of Mounting
Coil, Design
Coil, Mounting of
Coil, Spacing of in Receiver
Condenser, Bypass
Condenser, Connections to

CONTACT, POINTS FOR

<p><i>Condenser, Design and Construction of</i></p> <p><i>Condenser, Tuning</i></p> <p><i>Connector</i></p> <p><i>Control, Single</i></p> <p><i>Detector, with Grid Condenser and Leak</i></p> <p><i>Dial, Tuning</i></p> <p><i>Drilling</i></p> <p><i>Fuses and Protective Devices</i></p> <p><i>Graining, Panel</i></p> <p><i>Jacks and Switches, Uses of</i></p> <p><i>Lamp, Pilot or Panel</i></p> <p><i>Loop, Precautions in the Use of</i></p> <p><i>Oscillation</i></p> <p><i>Panel, Materials for</i></p> <p><i>Post, Binding</i></p>	<p><i>Power Unit</i></p> <p><i>Resistor, Filament Control</i></p> <p><i>Return, Grid</i></p> <p><i>Rheostat</i></p> <p><i>Rheostat, Sizes Required</i></p> <p><i>Screws and Bolts, Types of</i></p> <p><i>Shielding</i></p> <p><i>Socket, Tube</i></p> <p><i>Soldering</i></p> <p><i>Speaker, Loud, Connections to Receiver</i></p> <p><i>Switch</i></p> <p><i>Tools</i></p> <p><i>Tubing, Insulating</i></p> <p><i>Volume, Control of</i></p> <p><i>Wire</i></p> <p><i>Wiring, Receiver</i></p>
---	--

CONTACT, POINTS FOR.—A contact point is formed of a threaded shank carrying a disc shaped head as shown in the illustration. Contact points are passed through panels or other insulating materials to form a part of tap switches. The switch arm makes contact with the disc while the screw shank forms a terminal for a connecting wire.

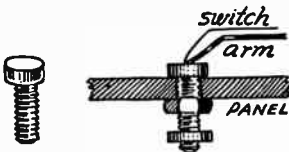

Contact Points.

CONTACT, SLIDE.—See *Coil, Slide Contacts On*.

CONTACT, SWITCH.—See *Contact, Points for*.

CONTINENTAL CODE.—See *Code*.

CONTINUOUS CURRENT.—See *Current, Direct or Continuous*.

CONTINUOUS WAVE RECEPTION.—See *Reception, Continuous Wave*.

CONTROL, REMOTE.—One of the practices in broadcasting by means of which a microphone is placed at a considerable distance from the transmitter. The microphone works through a line amplifier feeding wire line connections running to the transmitting station. Sounds originating at the microphone's location are sent by wire to the transmitter where they are broadcast.

CONTROL, SINGLE.—In a well built receiver having several stages of tuned radio frequency amplification it is always noticed that the tuning dials maintain their settings very close to one another for all stations. By exercising the greatest care and precision in design and manufacture it is possible to tune two or more stages from a single control by allowing this control to simultaneously operate all of the stages so handled.

Single control is used with multi-stage receivers having tuned transformers. The tuning condensers or the variable tuning induc-

CONTROL, SINGLE

tances for all stages are connected together and operated together by one control. For layouts see *Receiver, Single Control*.

The generally adopted method of building this type of receiver is to use fixed inductances and variable capacities, that is, to use coils that are not adjustable and tune them with variable condensers as in Fig. 1. It is also possible to use variable tuning inductances,

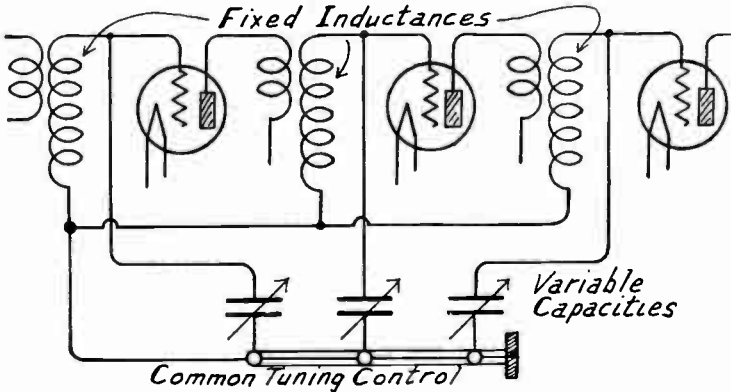

FIG. 1.—Single Control with Variable Condensers.

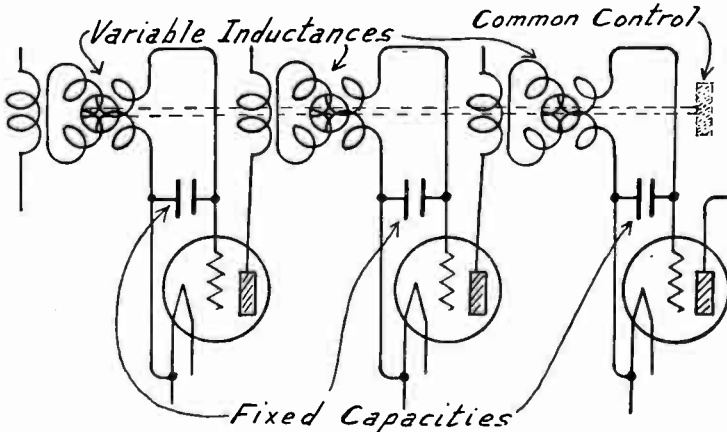

FIG. 2.—Single Control with Variable Inductances or Variometers.

such as variometers, and provide them with semi-fixed capacities in the form of condensers that are adjusted to the correct capacity once for all and left there. This is shown in Fig. 2.

Tuning Condensers for Single Control.—Several variable tuning condensers may be placed end to end and use one common rotor shaft for all as described under *Condenser, Multiple Types*.

CONTROL, SINGLE

Condensers may also be placed side by side with their shafts connected through pulleys and cords, through racks and pinions, or through a system of parallel arms and levers; all of these methods being illustrated in Fig. 3. With the pulley and cord scheme, the cord is fastened into the groove of each pulley at one point and any slack or lost motion in the cord is prevented by inserting a small coiled spring to maintain an even pull.

When using the rack and pinions, each condenser shaft carries a small pinion which engages the teeth of a rack that is long enough to extend across all the shafts. The rack may be moved by a separate pinion and tuning knob or it may be operated by turning the dial for any one of the condensers. The teeth of the rack are held in mesh with the pinions by pressure springs so that no lost motion can develop.

A system of arms and levers may be used to impart the turning motion of one condenser shaft to the shafts of all other condensers to be tuned simultaneously. The lost motion that would develop from the slight looseness in the many pinned or pivoted joints is prevented by fastening a tension spring to the arm attached directly to the rotor shaft of each condenser.

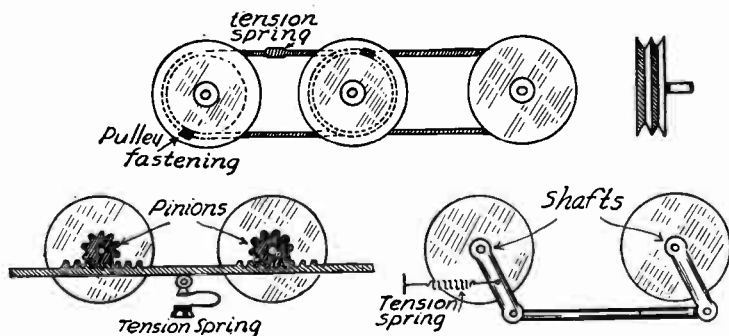

FIG. 3.—Single Control for Side-by-Side Tuning Units.

Any of these methods of connecting condensers may be applied equally well to variable inductances used for single control tuning.

All of the condensers joined together for tuning must be exactly alike in every respect, otherwise their capacities cannot possibly be made to change in step with one another as the control is operated. The condensers must change not only their capacities together, but must change all resistances and losses in the same ratio right through the tuning range. See *Condenser, Losses in*.

When two or more condensers are operated by a single control these condensers are generally provided with very small semi-fixed condensers in parallel with them. After the receiver has been assembled and the condensers connected to coils whose inductances are alike, these semi-fixed condensers are adjusted to bring all of the stages into resonance at the same setting for some one frequency. This scheme makes the single control operate perfectly at the one frequency where the balancing is done, but it is quite likely to allow the resonant points of the different tuned circuits to get farther and farther apart as this frequency is departed from. This objection

CONTROL, SINGLE

applies when the capacities of the condensers, without their auxiliary semi-fixed units, are not exactly alike at any one setting. If one of the small auxiliary condensers must be given a greater or less capacity with change of frequency this stage cannot possibly be kept in step because the change of capacity in the main tuning condensers has no effect on the adjusted capacity of the semi-fixed condensers.

The real purpose of such auxiliary capacities is to compensate for difference in stray capacity of the wiring of any one stage. They cannot compensate for differences in the capacities of the tuning condensers.

Many ingenious methods have been developed to handle this problem of compensating for differences in the capacities in the several stages. One manufacturer keys the rear rotor plate to the rotor shaft so that this end plate may be slid along the shaft toward or away from the other rotor plates. This end plate is moved to change the capacity of the condenser to the amount required and is then locked in place. Thereafter, the adjusting plate rotates with the other plates so that the effect of the capacity change is carried all the way through the tuning range and is maintained in proper ratio to the total capacity of the condenser.

When a condenser is used for the higher frequencies its plates are generally well out of mesh and a capacity near the minimum is being used. The internal capacity between the grid and filament of the tube may then be almost as large as the condenser capacity and changing a tube will upset the tuning balance for the stage in which such change is made. This trouble may be reduced by using a condenser of low enough minimum capacity so that its plates are still fairly well in mesh when tuned to the highest frequencies or lowest wavelengths. This may be accomplished only when distributed capacity in the coils and stray capacities in the tuned circuits are reduced to a minimum.

Coils for Single Control Tuning.—The inductance coils used for tuning in the several stages under one control must be identical with one another. This means that all the coils must be of the same shape and style, must be wound on forms that are exactly alike, must be of the same number of turns, wound with the same kind of wire, and with their diameters and lengths exactly the same. The supports should be alike and terminals should be in the same positions for all coils. The primary windings should all be alike and the coupling between primary and secondary windings should be the same for all stages.

When controlling two or more tuned coils with condensers operated together it is absolutely essential that the coils be exactly alike in inductance, resistance and distributed capacity regardless of the frequency at which they are being operated. Curves showing the relation between frequency and inductance or distributed capacity must be exactly alike at all points for all such coils. Such curves are shown under the heading *Coil, Resistance of*.

The primaries of tuned radio frequency transformers have a decided effect on the secondaries and thereby on the tuning of the secondary. The primary circuit is affected by the internal capacity and by the internal resistance of the tube to which it is connected as well as by the primary's own inductance and distributed capacity.

The tuning coils may be matched with one another under operating conditions at radio frequencies according to the method described under *Oscillator, Radio Frequency, Uses of*.

CONTROL, SINGLE

Detector Grid Return for Single Control.—Many of the multiple condensers have one continuous metallic rotor shaft common to all the units, consequently all of the rotors must necessarily be at one common voltage. If such a multiple condenser is used in the amplifier stage connected to the grid of the detector tube and also in the stages connected to the grids of radio frequency amplifier tubes, the grid returns for all tubes including the detector will be negative when using the connections shown in Fig. 1.

Whether a negative or positive grid return is required for the detector depends on the kind of tube used in this position. With hard tubes, those having a high degree of vacuum with no intentional gas content, a negative grid return does not give as great sensitivity as a positive return. Consequently, hard tube detectors are not working at maximum efficiency with a negative grid return made to the common rotor connections of these multiple condensers.

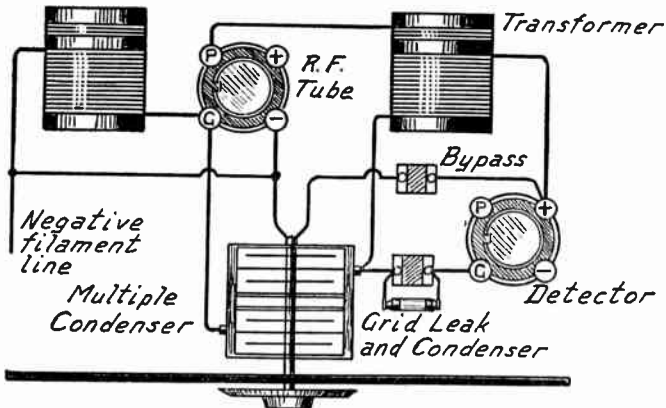

FIG. 4.—Positive Bias for Detector with Bypass to Condenser Rotor in Single Control.

The negative grid return is desirable and gives the greatest sensitivity with any soft or gaseous detector tube. Many such tubes are on the market and should be employed whenever the grid return is negative.

If it is desired to use a hard detector tube with the proper positive grid return when employing a multiple condenser having a common rotor shaft, special means must be employed to provide the positive bias on the detector and a negative bias on all the radio amplifier tubes.

If the grid leak and grid condenser are in parallel with each other as in Fig. 4, the grid return for the detector tube may be run to the positive filament terminal of the tube. This provides a positive bias. The high voltage side or grid side of the grid circuit of the detector is connected to the stator of one section of the condenser, consequently the filament side of the grid circuit must be connected to the rotor of the condenser. This latter connection is secured by placing a bypass condenser of .006 microfarad capacity or larger between the positive filament line and the negative filament line or any other line running to the condenser rotor.

CONTROL, SINGLE

If the grid leak is connected between the grid terminal and filament terminal of the detector tube as in Fig. 5, a positive bias may be secured by attaching the grid leak to the positive filament terminal rather than to the negative terminal. The grid condenser is then between the tube and the tuning coil and the other end of the coil may be connected to the lines running to the condenser rotor as shown.

Some multiple condensers are made with insulated rotors as well as insulated stators and these styles may be connected with positive return for the detector grid and negative return for the grids of amplifier tubes. Any of the multiple condensers placed side by side may be insulated completely from each other by using insulation in the control connections. With pulleys and cords, the cords should be of good insulating material. With gears or with rack and pinion, the small pinions or the gears may be of insulating composition. With parallel arms and levers, the levers attached to the condenser shafts may be of insulating material.

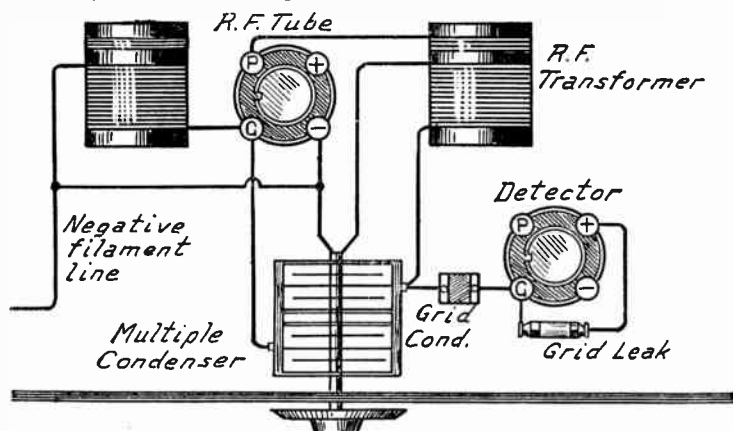

FIG. 5.—Positive Bias for Detector with Grid Leak Connection to Filament in Single Control.

Difficulties with Antenna Stage Tuning.—The first stage may give some trouble. It is comparatively easy to provide uniform tuning for all radio frequency amplifier stages after the first stage. The effect of the antenna's capacity and inductance on the first stage makes it practically impossible to keep the tuning of this first stage in exact step with the tuning of the following stages. This difficulty may be overcome by using special means to obtain exceedingly loose coupling between the antenna circuit and the grid circuit of the first radio frequency tube. See *Antenna, Coupling of*. Many receivers recognize this particular difficulty by using two tuning controls. The first control handles only the first amplifier stage which is coupled to the antenna. All of the remaining stages of radio frequency amplification are handled together by the other control.

It is possible to obtain uniform operation and satisfactory single control of all tuned stages by using a coupling tube for the antenna circuit as shown

CONTROL, SINGLE

in Fig. 6. This idea is the same as that used for handling several receivers on one antenna.

A variable high resistance is placed between antenna and ground with the upper end of the resistance connected to the grid and the lower end to the filament circuit of the first tube. This resistance is adjusted for satisfactory operation and allowed to remain without further change. It is not used for tuning. The plate circuit of this coupling tube forms the primary of the first radio frequency transformer and the first tuning control is in the grid circuit of the second tube.

The first tube or coupling tube is used only to keep the direct effect of antenna capacity and inductance from affecting the first tuned circuit. Little or no amplification need be expected of this tube. The remainder of the radio frequency amplifier, the detector and the audio amplifier may be built according to any desired design. The coupling tube simply takes the place of the usual direct coupling of the antenna to the first tuned circuit and does not in any way affect the rest of the receiver.

Avoiding Stray Couplings.—When attempting to use single control it is absolutely necessary that all of the stray capacities or distributed capacities between the parts and the wires of the receiver must be in exact balance for all of the amplifier stages operated by

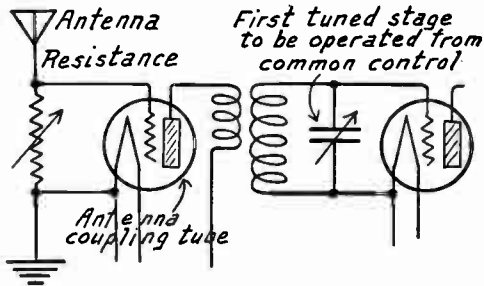

FIG. 6.—Antenna Coupling Tube to Allow Single Control of Tuned Stages.

the one control. It is not satisfactory to provide vernier controls for the several tuning condensers because, while the use of these controls will overcome capacity differences between the stages, they really take the receiver into the multiple control class.

Single control of several stages of radio frequency amplification is made simpler and easier if each stage is completely shielded. Properly applied shielding prevents the feedbacks and stray couplings that would upset the tuning and make it exceedingly difficult to obtain really efficient operation of several stages tuned together. See *Shielding*.

Oscillation or Volume Control.—To conform with the requirement that all inductances and capacities in the amplifier stages operated from a single control must be identical, special care must be used in handling regeneration and oscillation. Any method of preventing oscillation or of controlling regeneration that is applied to one of the single control stages must be applied in exactly the same manner and in exactly the same degree to all other stages so controlled.

CONTROL, SINGLE

Almost all methods of handling regeneration affect the inductance, capacity, or resistance in the radio frequency circuits. Any change of one of these factors in a single stage which did not affect the same factor equally in all other stages would be sure to upset the tuning.

Adjusting the Single Control Receiver.—All tuning units must be properly adjusted to work with each other and to obtain resonance at a given frequency with identical settings of the several tuning condensers.

When a single control receiver is assembled it should first be made certain that all of the tuning condensers have their rotor plates in exactly the same relative position with reference to the stator plates. Coils of the same measured inductance should be connected to each of the condensers. All of these coils should be exactly like one another down to the last detail. This includes length, diameter, wire size, wire insulation, position of terminals, number of turns and the size, location and shape of the primary winding.

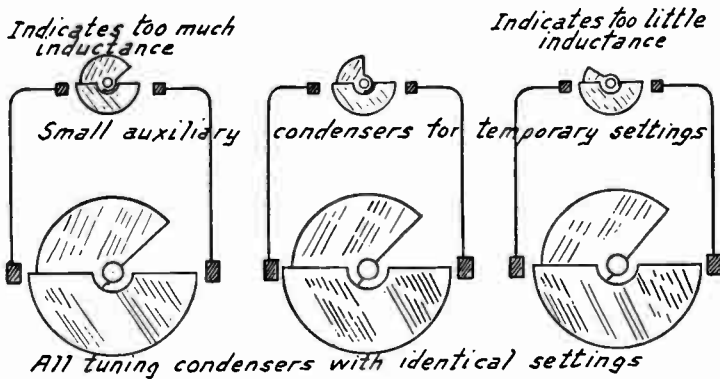

FIG. 7.—Use of Auxiliary Condensers for Adjusting Single Control.

Obscure and difficult causes of trouble will be avoided if the layout and all wiring in each stage is exactly like the layout and wiring in all the other stages.

It is finally necessary to test the receiver in actual operation and make any adjustments that are necessary for maximum possible efficiency. Tuning may be done with the help of a radio frequency oscillator whose coupling to the receiver may be made quite close to begin with. Then, as the stages are brought into approximate resonance at one setting, the oscillator coupling may be reduced as the work proceeds. If no oscillator is available for this work, the receiver may be adjusted by tuning it to several broadcasting stations, selecting at least one of high frequency and another of low frequency for the work.

If the stages are to be adjusted by tuning the receiver to broadcasting stations a comparatively near and powerful station should first be tuned in. Small auxiliary variable condensers may then be connected in parallel with each of the main tuning condensers.

CONTROL, SINGLE

These auxiliary condensers should be set approximately midway between minimum and maximum capacity. The settings of the auxiliary condensers may then be changed one at a time to increase or decrease their capacity. They should be left at the positions where reception is most satisfactory.

Then proceed to tune in a weaker station and continue to tune in stations that are weaker and weaker or at greater distance, changing the settings and capacities of the auxiliary condensers from time to time to improve and strengthen the reception.

If, in the beginning, all of the stages of amplification have exactly the same capacity and inductance at any given setting, the settings and capacities of the auxiliary condensers will remain exactly alike, but if considerable changes have to be made in the small condensers it shows that adjustments are required as shown in Fig. 7. Provided it is felt that the main tuning condensers run uniform with each other the adjustment will be made to the coils.

Whenever one of the auxiliary condensers has been given more capacity, has its plates farther in mesh than the plates of other auxiliary condensers, it indicates that the coil for that stage has too little inductance. The inductance may be increased by adding turns of wire or by pressing the turns already on the coil closer together provided such a thing is possible. This, however, may change the distributed capacity.

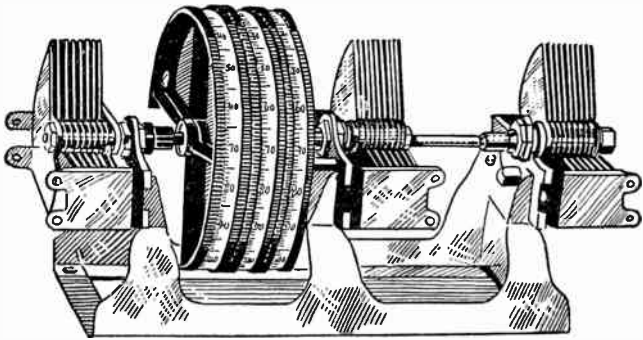

FIG. 8.—Modified Single Control Tuning Unit.

Wherever it has been necessary to give the small auxiliary condenser less capacity, by turning its plates farther out of mesh than the others, it indicates that the coil for that stage has too much inductance, is too large. Turns of wire or parts of turns may be removed from this coil and after each removal it will be found necessary to turn the auxiliary condenser for that stage farther into mesh. Wire should be removed from the coil until the corresponding small condenser is brought to a setting exactly like that of the other small condensers. All of this work should be done while the receiver is tuned in on a distant or weak station or very loosely coupled to an oscillator so that accurate settings must be had to hear the signal with any volume.

After each coil has been adjusted so that the small condensers are all set exactly the same these additional small condensers may be disconnected and removed from the set since they have served their purpose. With them removed it should be found that all of the stages so adjusted tune exactly alike.

Testing Resonance in Single Control Stages.—Each stage of a single control receiver may be tested for the position of its tuning element at which resonance is secured with a given frequency of signal. An autodyne frequency meter such as shown in Fig. 10 under *Meters, Frequency*, is used for the test.

CONTROL, SINGLE

From the grid circuit of the frequency meter a connection is made to any point of the tuned circuit to be tested in the receiver. The connections are shown in Fig. 9. The frequency meter is adjusted so that the squealing which indicates oscillation is just audible. The tuning control on the receiver is set midway between its extreme positions and the midget variable condenser is adjusted so that the indication of oscillation remains audible. The midget condenser should have only two or three plates. The condenser of the frequency meter is then turned to a point at which the meter tube ceases to oscillate, as indicated by the squeal disappearing. The capacity of the midget condenser should be reduced until the oscillation is stopped only while the meter condenser is moved over a very small portion of its dial. At the center of the dial space in which there is no oscillation, the frequency meter circuit and the circuit being tested are in resonance. Absorption of power by the circuit on test serves to prevent oscillation in the meter. A careful note is made of the exact position of the receiver tuning control.

The connection of the line from the midget condenser to the receiver circuit is now removed and a similar connection is made to another of the tuned circuits in the receiver. The setting of the frequency meter condenser should not be altered for the second test. The tuning control of the receiver

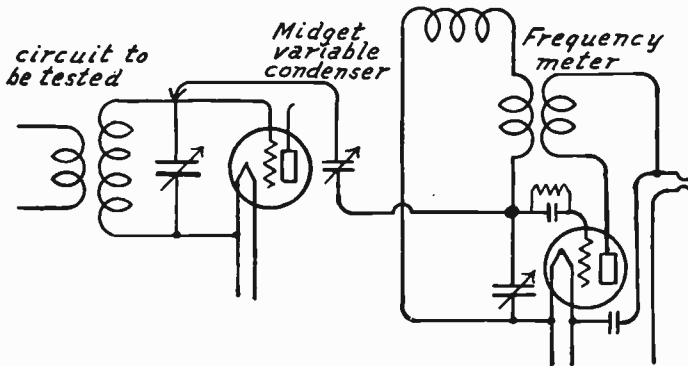

FIG. 9.—Testing Resonance of Single Control Stages.

is moved to the point at which oscillation again ceases in the meter. Any difference in setting of the receiver control from its position for the first test indicates that the two circuits do not resonate together and suitable adjustments should be made. Each of the tuned circuits of the receiver which are operated from the single tuning control should be thus tested and adjusted by changing their capacity or inductance until all will indicate resonance with the frequency meter at its single setting. After the receiver's circuits have been tested at an intermediate position of the tuning control, they should all be tested at a dial setting for high frequencies and finally at a setting for low frequencies. The setting of the midget coupling condenser will have to be changed to a higher capacity for the lower frequency settings of the receiver control.

Modified Single Control.—It will be realized that a properly designed and built single control receiver will be a rather expensive receiver. At least, it will cost considerably more than a receiver of the same general type but with individually operated controls for each stage of amplification.

COPPER

In an attempt to provide at least some of the advantages of the true single control receiver with the economy in first cost of the multi-control types, the single control arrangement has been somewhat modified in many designs. These designs may operate all of the tuning units together from one central dial or knob by using connections such as racks and pinions. The shafts of the condensers are driven by friction from the central control, yet each shaft may be turned individually from its own knob or dial without turning the other shafts since the friction grip on any one shaft is not great enough to overcome the friction of all the others or of the main tuning control. This is a centralized or localized form of control, but is not actually a single control.

A modified form of single control is used in receivers whose several tuning condensers are attached to individual tuning drums as shown in Fig. 8. These drums revolve around a common center, are parallel to each other and are close together. There may be sufficient friction between them so that moving any one drum will cause the other drums to move with it. Still, this friction is not so great but what any one drum may be given a slight individual movement of its own to correct for the small difference required in the several stages. This might be called a localized control.

COPPER.—Copper is by far the most important of the metals from the electrical standpoint because it is used universally for conductors. The metal is of reddish color and is very malleable. It is quite heavy, having a density of about 8.9. Copper oxidizes easily in air, becoming covered with a black coating of copper oxide which has rather high resistance. Fumes from lead-acid types of storage batteries attack this metal and form copper sulphate or "blue vitriol" which is poisonous. Copper melts at about 1980 degrees Fahrenheit.

The resistance of soft annealed copper is 10.371 ohms per mil foot at 68 degrees Fahrenheit. Hard copper which has been rolled or drawn has a resistance of 10.65 ohms per mil foot. These values are for commercial electrolytic copper which is about 99.93 per cent pure copper. The resistance of copper wire of all gauge sizes is given under *Wire, Copper*. Information on the weight of copper sheets is given under *Shielding*.

COPPER CLAD WIRE.—See *Antenna, Wire for*.

COPPER OXIDE RECTIFIER.—See *Rectifier, Copper Oxide*.

COPPER WIRE.—See *Wire, Copper*.

CORD, EXTENSION.—This is a flexible, two-conductor cable with tips or terminals at one end suitable for connection into the output of a receiver and at the other end suitable for attachment to a loud speaker. Such an extension allows the speaker to be used at a considerable distance from the receiver. These cords are usually twenty feet or more in length.

CORE.—The iron center of an iron-cored inductance coil or transformer is called the core. The purpose of the core is to concentrate the magnetic lines of force through the center of the winding and to make the passage of these lines of force easier than it would be without the core. This increases the inductance.

CORE, TRANSFORMER

The inside of any coil or winding, that is, the space in which there is the greatest concentration of lines of force is called the core of that coil or winding. If the center or core of the coil contains no iron it is called an air-core coil even though insulating material is present.

The central portion of a cable is called the core of the cable. The core may or may not be the principal conductor. For example, in copper-clad steel wire, the core is of steel.

CORE, TRANSFORMER.—See *Transformer*; also *Transformer, Audio Frequency*.

CORE TYPE TRANSFORMER.—See *Transformer*.

COTTON COVERED WIRE.—See *Wire, Cotton Covered*.

COUNTER ELECTROMOTIVE FORCE.—See *Inductance, Self*.

COUNTERPOISE.—A counterpoise is a network of wires or other conductors carried underneath an antenna and used in place of a ground in the antenna circuit of a receiver. Considering the antenna system as a condenser, the antenna itself forms the upper plate and the counterpoise forms the lower plate with air as the dielectric between them. The counterpoise is connected to the ground terminal of the receiver. A counterpoise and its connections are shown in the illustration.

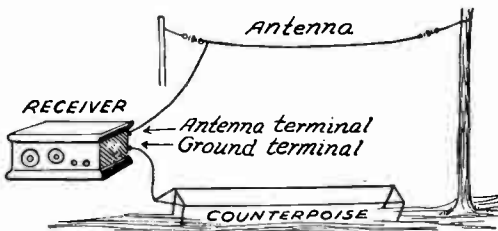

Use of Counterpoise in Place of Ground.

A counterpoise in shape and size should practically duplicate the antenna. It is still better if the space covered by the counterpoise is larger than that covered by the antenna. The counterpoise should be supported a foot or more above the ground and well insulated. If the receiver is in an upper floor of a tall building or if the earth is very dry a counterpoise may work better than a ground. A counterpoise must be protected with a grounded lightning arrester just as an antenna would be protected.

A counterpoise may be built out of doors or it may be placed under a floor, in a cellar or anywhere else underneath the antenna. The construction may be carried out according to the rules given for antenna construction. The counterpoise may be close to the ground or it may be ten feet or more above ground and work equally well.

COUNTERSINK.—See *Tools*.

COUPLER.—Any arrangement of inductance coils, condensers or resistances so placed with reference to each other that there is electromagnetic or electrostatic coupling between their circuits is called a coupler. See *Coupling*; also *Amplification, of Coupling Devices*.

COUPLER, FIXED TYPE.—A fixed coupler consists of two windings, primary and secondary, which have a fixed relation or a

COUPLER, LOOSE

fixed coupling with each other. After such a coupler is constructed the primary and secondary cannot be moved with reference to each other. In the common type shown the secondary winding is on one end of a tubular form with the primary on the other end of the same form and separated from the secondary by a small space, generally of one-eighth to one-half an inch. The greater the separation the less the coupling. If the coupler is used for interstage coupling between tubes the outer end of the primary is connected to the plate of the preceding tube and the inner end is connected to the B-battery. In either case the inner end of the secondary is connected to the filament circuit and forms the grid return while the outer end of the secondary is connected to the grid of the following tube. See also *Transformer, Tuned Radio Frequency*.

COUPLER, LOOSE.—Any coupler that provides what is known as loose coupling is called a loose coupler. See *Coupling, Loose*.

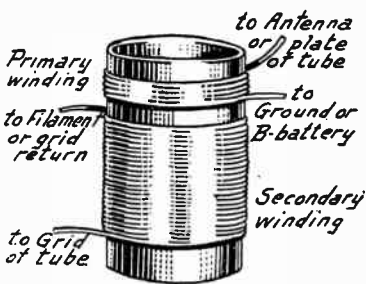

A Fixed Coupler.

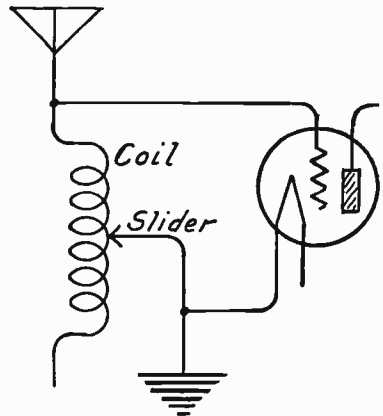

A Slide Coupler.

COUPLER, SLIDE.—A slide coupler consists of a coil of wire with which contact may be made at different points along the length of the coil by means of a slide contact. A slide coupler is used to insert more or less inductance in a tuned circuit. See also *Coil, Slide Contacts on*.

COUPLER, SPLIT VARIOMETER FOR.—The two windings of any variometer may be disconnected from each other. The outer winding may then form the primary and the inner winding the secondary winding of a variocoupler. See *Variometer, Coupling with*.

COUPLER, VARIABLE.—Any coupling device in which the degree or coefficient of coupling may be changed while the unit is in operation is called a variable coupler. A common type is shown. Here the secondary winding is placed on a tube which supports a

COUPLER, VARIOCOUPLER TYPE



A Variable Coupler.

rotating primary winding at one end. When the axis of the primary winding is in line with the axis of the secondary winding, that is, when both windings are flat, the coupling is closest. With the axes at right angles, with the primary turns straight up and down, the coupling is loosest.

A variation in coupling may be obtained without moving any parts of a coupling device when the actual coupling is obtained through resistances or capacities used in connection with the two coupled circuits. The method shown in this illustration provides a variation of the inductive coupling between the coil windings.

COUPLER, VARIOCOUPLER TYPE.—Variocoupler is another word for variable coupler. Two forms of variocoupler are shown. The upper unit consists of two spherical windings one with-

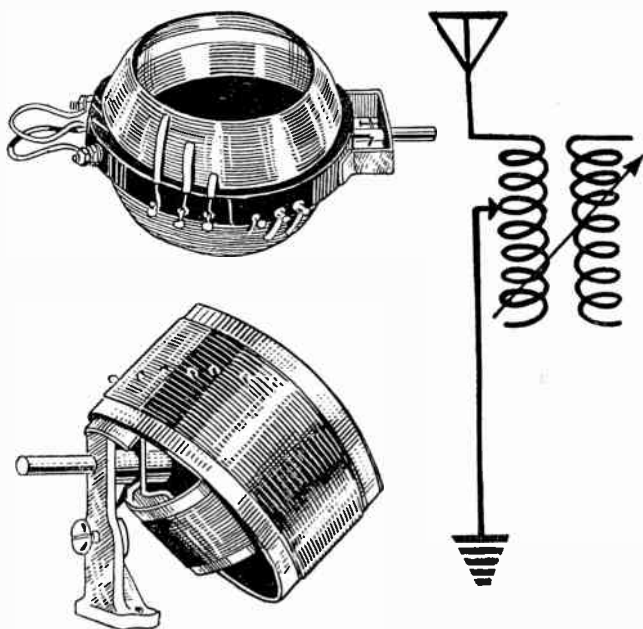

Two Types of Variocoupler with Their Symbol.

in the other. In this unit, as in many of the older types, the outer or primary winding is tapped so that more or less of it may be included in an antenna circuit. With the two coils in the position shown coupling is at a maximum. A shaft movement of ninety

COUPLING

degrees or one-quarter of a turn changes the coupling from minimum to maximum.

In the type of coupler shown at the bottom a half-turn of the shaft is required to change from minimum to maximum coupling. The outer coil is a tapped primary and is mounted at forty-five degrees from the vertical. The inner coil, the secondary, is attached at a forty-five degree angle to a horizontal shaft. In the position shown the coupling is at its minimum. Before the two coils can be brought into such a position that their axes lie in the same line the shaft must be rotated one hundred and eighty degrees or a half turn. The symbol for a tapped variocoupler is shown at the right.

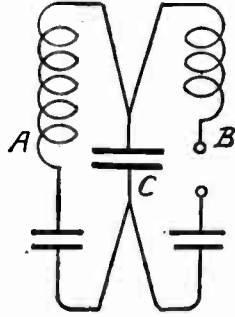

Capacitive Coupling.

COUPLING.—When any two circuits are arranged so that energy from one circuit passes into the other circuit the two are said to be coupled. Coupling is obtained whenever parts of a magnetic field or electrostatic field of one circuit pass through the field of the other circuit. Coupling is obtained when the two circuits have resistance, capacities or inductances in common with each other. See also *Radio, Principles of*.

COUPLING, ANTENNA.—See *Antenna, Coupling of*.

COUPLING, BACK.—See *Feedback*.

COUPLING, CAPACITIVE.—Capacitive coupling is coupling obtained by means of a condenser or an electrostatic field which is common to two circuits. This common capacity is called the mutual capacity. In the capacitive coupling illustrated the capacity C is mutual or common to circuit A and to circuit B .

COUPLING, CLOSE.—Any degree of coupling whose coefficient of coupling is greater than 0.5 is called close coupling. The closer the coupling, that is, the greater the coefficient of coupling, the more energy will be transferred from one circuit to the other. See *Coupling, Coefficient of*.

COUPLING, COEFFICIENT OF.—The coefficient of coupling between two circuits is a measure of the amount or degree of coupling between them. It is a measure of the ease with which energy may be transferred from one circuit to the other.

The coefficient of coupling is the ratio of the mutual inductance, capacity or resistance of both circuits to the square root of a number obtained by multiplying together the separate inductances, capacities or resistances of the two circuits. The coupling coefficient is represented by the letter K . The value of the coupling coefficient when two circuits are coupled by inductive coupling is represented by the formula on the following page.

COUPLING, COEFFICIENT OF

$$\text{Coefficient of Coupling} = \frac{\text{Mutual Inductance or Coupling Inductance}}{\text{Square Root of } \left(\text{Inductance of One Circuit} \times \text{Inductance of Other Circuit} \right)}$$

All inductances are in microhenries, all in millihenries or all in henries; the same unit being used for all three values.

If the mutual inductance is not known, the coefficient of coupling may be calculated from the diameters and lengths of the two coils when their axes coincide and when the centers of their lengths are together as at the left in the illustration. The formula for this value of coupling coefficient follows:

$$\text{Coefficient of Coupling} = \frac{\left(\text{Diameter of Smaller Coil} \right)^2 \times \left(\text{Length of Winding on Smaller Coil} \right)^2}{\left(\text{Diameter of Larger Coil} \right)^2 \times \left(\text{Length of Winding on Larger Coil} \right)^2}$$

If the axes of the coils are inclined to make an angle with each other but remain in the same plane as at the right in the illustration, the value of the coupling coefficient K is proportional to the cosine of the angle of inclination.

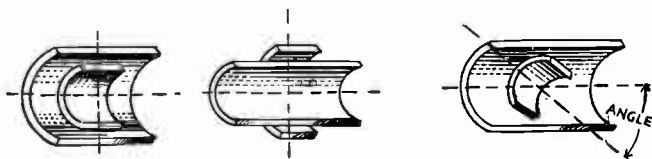

Effect of Coil Position on Coupling Coefficient.

The following table gives the proportional values of K for various angles of inclination. To find the actual value of coupling, multiply the value of K as found from the above formula by the decimal fraction given opposite the angle of inclination.

COUPLING WITH ANGLE OF INCLINATION

Angle Degrees	Decimal	Angle Degrees	Decimal	Angle Degrees	Decimal	Angle Degrees	Decimal
0	1.000	22½	.924	45	.707	67½	.383
2½	.999	25	.906	47½	.676	70	.342
5	.996	27½	.887	50	.643	72½	.301
7½	.991	30	.866	52½	.609	75	.259
10	.985	32½	.843	55	.574	77½	.216
12½	.976	35	.819	57½	.537	80	.174
15	.966	37½	.793	60	.500	82½	.131
17½	.954	40	.766	62½	.462	85	.087
20	.940	42½	.737	65	.423	87½	.044

If the two coils are moved bodily apart while their axes are kept in line the coefficient of coupling depends on the separation between the coils, becoming less as the separation is increased. The separation is measured be-

COUPLING, DIRECT

tween the ends of the windings which are toward each other, not from the center of one winding to the center of the other.

The following table shows the change in coupling when the coils are moved apart. The coupling with a separation of one inch is taken as 100. The two coils are assumed to be exactly alike in every respect.

CHANGE IN MUTUAL INDUCTANCE WITH SEPARATION OF TWO COILS

Separation in Inches	Per Cent Inductance	Separation in Inches	Per Cent Inductance	Separation in Inches	Per Cent Inductance
1.0	100.0	3.5	36.2	6.0	10.6
1.5	91.1	4.0	28.5	6.5	8.1
2.0	78.7	4.5	22.1	7.0	6.4
2.5	65.1	5.0	17.4	7.5	5.1
3.0	47.6	5.5	13.6	8.0	4.3

See also *Coupling, Optimum.*

COUPLING, CONDENSER TYPE.—See *Coupling, Capacitive.*

COUPLING, CONDUCTIVE.—Conductive coupling, which is also called direct coupling, is obtained through an inductance which is common to two circuits. This type of coupling is equivalent in

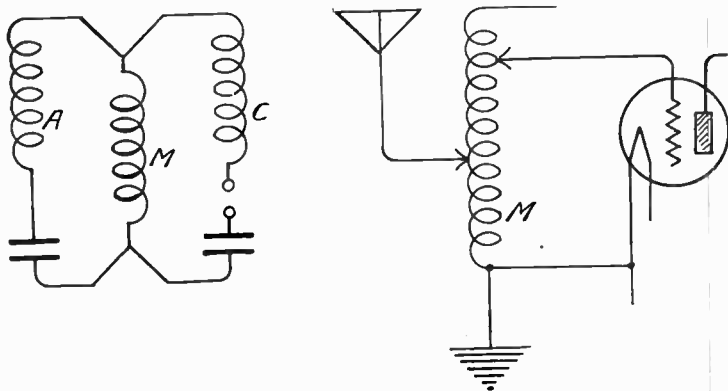

Conductive or Direct Coupling.

its effect to inductive coupling. One form of direct coupling as used in radio receivers is shown at the right of the drawing. An auto-transformer makes use of direct or conductive coupling.

COUPLING, DIRECT.—See *Coupling, Conductive.*

COUPLING, EFFECT ON RESONANCE.—When two tuned circuits are very closely coupled to each other it is found that resonance is obtained with two different adjustments of the tuning condenser or the tuning inductance. With the closest possible coupling the two points of resonance or the two resonance peaks are some distance apart.

COUPLING, ELECTROSTATIC

Close Coupling

Loose Coupling

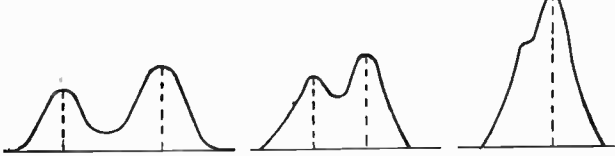

Effect of Coupling on Resonance.

As the coupling is made looser the two peaks keep coming closer and closer together until, with very loose coupling, they practically merge and form a single resonance peak of greater height or amplitude than either of the others alone. This explains the broadness of tuning when using very close coupling in radio frequency circuits.

COUPLING, ELECTROSTATIC.—See *Coupling, Capacitive*.

COUPLING, IMPEDANCE.—Impedance coupling is obtained through an impedance Z which is common to the two circuits A and B . The principle of impedance coupling as used in radio am-

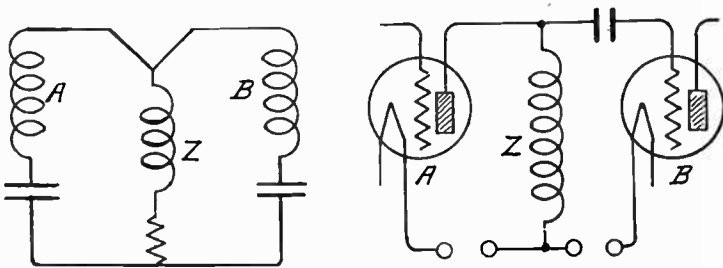

Impedance Coupling.

plifying circuits is shown at the right hand side of the drawing. See also *Amplifier, Audio Frequency, Impedance Coupled*.

COUPLING, INDUCTIVE.—Inductive coupling is obtained through parts of two magnetic fields which are common to two

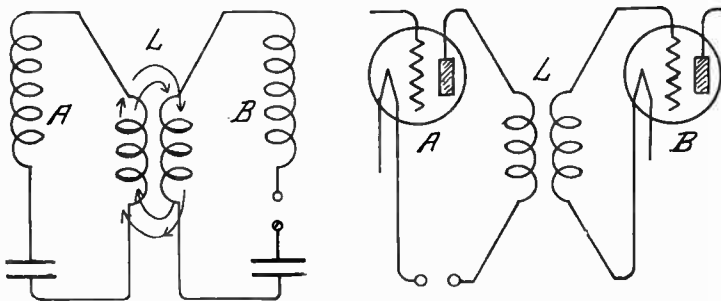

Inductive Coupling.

COUPLING, INTERSTAGE

circuits as in the drawing where the two inductance coils L have parts of the field of each passing through the field of the other. These two coupling coils are said to have mutual inductance and through this mutual inductance, coupling is obtained between circuits A and B. Inductive coupling as found in the commonly used transformer coupling of radio circuits is shown at the right hand side of the drawing.

COUPLING, INTERSTAGE.—Any form of coupling by means of which one stage of amplification is coupled to the following stage of amplification so that energy may pass from one stage to the next is called interstage coupling. The interstage coupling is obtained through a transformer, a resistance, an impedance or a reactance placed between the amplifying tubes in two stages.

COUPLING, LINK.—See *Circuit, Link*.

COUPLING, LOOSE.—Any degree of coupling whose coefficient of coupling is 0.5 or less is generally called loose coupling. The looser the coupling the less energy is transferred from one circuit to the other and the less will be the effect of the inductance, the capacity or the resistance in one circuit on the other circuit. See *Coupling, Coefficient of*.

COUPLING, MAGNETIC.—See *Coupling, Inductive*.

COUPLING, OPTIMUM.—The optimum coupling between two circuits is that coupling with which there is the greatest transfer of energy from one circuit into the other. The optimum coupling is neither the closest nor the loosest coupling which may be used.

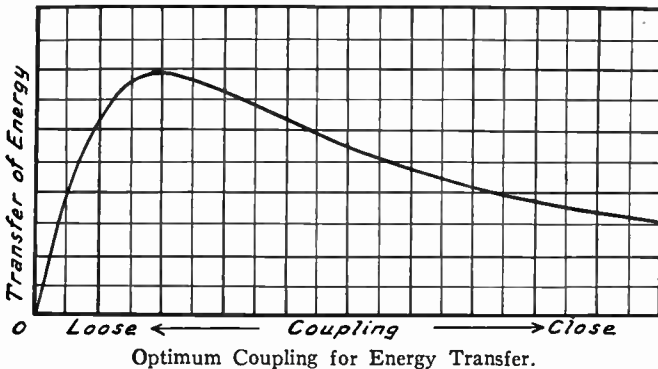

With circuits containing high resistance the optimum coupling may be a rather close coupling, a coupling whose coefficient is rather high. As the circuit resistance is reduced the greatest power transfer is secured with looser and looser coupling. This effect is shown in the curve which illustrates the rise in energy transferred as the coefficient of coupling is increased. It is seen that with zero coupling there is no energy transfer, that the transfer increases quite rapidly with increase of coupling up to the optimum point, then decreases gradually.

Optimum coupling and maximum possible transfer of energy are obtained when the values of frequency, mutual inductance and resistance satisfy the equation on the following page.

COUPLING, RESISTANCE

$$\left(\frac{\text{Mutual Inductance of Circuits}}{\text{of Circuits}} \right)^2 \times \left(\frac{\text{Frequency in Kilocycles}}{\text{Kilocycles}} \times 6280 \right)^2 =$$

$$\left(\frac{\text{Total Resistance of One Circuit}}{\text{of One Circuit}} \right) \times \left(\frac{\text{Total Resistance of Other Circuit}}{\text{of Other Circuit}} \right)$$

The resistances are the high frequency resistances measured at the frequency used in the first part of the equation. See *Resistance, High Frequency*.

COUPLING, RESISTANCE.—Resistance coupling is obtained by a resistance which is common to two circuits. In the drawing the common resistance R provides a coupling between cir-

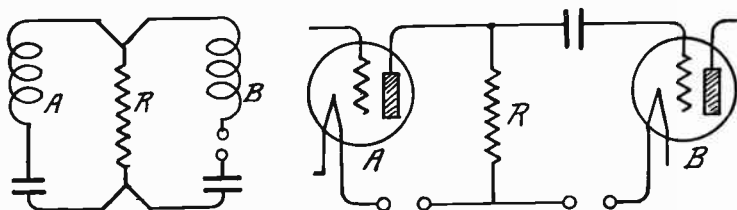

Resistance Coupling.

cuits A and B . The principle of resistance coupling as used in radio amplifying circuits is shown at the right hand side of the drawing. See also *Amplifier, Audio Frequency, Resistance Coupled*.

COUPLING, SELECTIVITY AFFECTED BY.—See *Selectivity*.

COUPLING, TIGHT.—See *Coupling, Close*.

COUPLING, TRANSFORMER.—Coupling from one stage of amplification to the following stage which is obtained through the mutual inductance of the two windings in a transformer is called transformer coupling. This is the most common type of interstage coupling. Tuned transformers are used for coupling in radio frequency circuits and untuned iron-core transformers are used for coupling between audio frequency circuits. See *Transformer*.

COUPLING, TUBE FOR.—See *Receiver, Single Control*.

CRITICAL.—A point at which some certain change takes place is called a critical point. For example, a critical resistance would be the amount of resistance in a circuit at which devices in the circuit would commence operating or cease operating.

CRYSTAL DETECTOR.—See *Detector, Crystal*.

CRYSTAL RECEIVER.—See *Receiver, Crystal Type*.

CRYSTAL, FREQUENCY CONTROL BY.—A piece of quartz, called a quartz crystal, may be used to control the frequency at which a circuit oscillates, keeping this frequency so nearly constant that it is difficult to measure the slightest deviation. This property of the quartz crystal is made use of in keeping the carrier wave from any type of radio transmitter on the exact wavelength or frequency which is desired. The crystal is also used for frequency

CRYSTAL, FREQUENCY CONTROL BY

control in many other applications of radio circuits. This effect, called the piezo-electric effect, is due to piezo-electricity generated by the crystal, that is, to electricity generated by pressure.

When a crystal or a thin slab of quartz is placed between two metal plates, as in Fig. 1, the combination forms a condenser with the metal pieces forming the plates and the quartz forming the dielectric. If the plates are connected to a source of alternating current, the quartz is found to expand and contract as the charge on the plates reverses its polarity. This seems a remarkable property, but it is still stranger to find that with the plates connected to a sensitive galvanometer the quartz crystal will actually generate alternating electric charges in the plates as the crystal is caused to expand and contract, lengthen and shorten. The effect is reversible; alternating electric charges impressed on the crystal cause it to lengthen and shorten, and the lengthening and shortening of the crystal cause it to produce alternating electric impulses in the plates.

While this peculiar action exists to some extent no matter what the frequency of the alternations, at one certain frequency the action becomes very strong and pronounced, this being at the natural frequency of the piece of quartz crystal being used. The quartz has a kind of mechanical resonance and electrical resonance combined at this frequency.

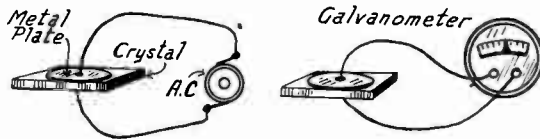

FIG. 1.—Action of the Quartz Crystal for Frequency Control.

At this natural frequency, which is determined by the thickness and length of the piece of quartz, the crystal acts like a small high frequency generator and produces alternating current of this frequency. The thinner and the shorter the piece of quartz, the higher will be its natural frequency. As a matter of fact, each piece of quartz has two natural frequencies, one depending on its length and the other on its thickness. A feature that makes quartz especially valuable as a controlling standard is that its natural frequency is almost unaffected by age, by changes of temperature, or by any of the things that might be expected to affect any material so used.

When such a combination of a quartz crystal and two metal plates is put into the grid circuit of a vacuum tube, somewhat as in Fig. 2, and an exciting voltage applied to the plates, the crystal lengthens or expands, then immediately shortens or contracts and in doing so causes the plates to become charged. In an oscillatory circuit, which may oscillate at the crystal's natural frequency, the crystal will thus feed voltages or impulses at this frequency into the circuit. These impulses act on the grid of a tube, whose plate circuit then delivers more powerful impulses at this same frequency. This crystal

CRYSTAL, FREQUENCY CONTROL BY

controlled tube is used to control another and larger tube which may, in turn, be used to control the frequency of a transmitter's entire output.

Another view of the crystal action is as follows: The voltage applied to the two sides of the crystal causes it to get thinner and to become longer between the metal plates. This movement of the crystal is energetic enough so that it overshoots the mark and gets thinner than it would from the effect of the applied voltage alone. Then, of course, the crystal comes back, gets thicker again.

This action is like that of a pendulum which, when pushed, swings past the center and starts back. The crystal is like a pendulum in the radio circuit. It takes power to start it to swinging or oscillating, but when started it swings at its own frequency or oscillates at its own frequency regardless of the frequency of applied power. If power is applied to the pendulum or to the crystal at its own natural frequency the response will naturally be very great. Once started in this way, either the pendulum or the crystal will give off power at its natural frequency of oscillation.

The crystal is cut on planes which are determined by optical measurements. It is then ground down flat with opposite sides perfectly smooth. The thickness of the crystals in general use deter-

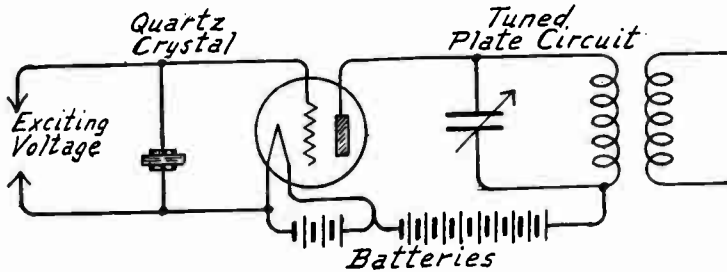

FIG. 2.—Crystal Control of Grid Circuit Frequency.

mines their natural frequency, the length not being used as a controlling dimension. The finished crystal may be round, square or oblong.

The crystal mounting consists of two plates of good conducting metal, such as copper or brass. The metal surfaces between which the crystal is carried are ground perfectly smooth. The crystal is usually held by the pressure of a light spring on one of the metal plates.

Crystal Controlled Oscillators.—The circuit of a crystal controlled oscillator is shown in Fig. 3. One side of the crystal is connected to a double-throw switch that may be thrown to either the plate circuit or the filament circuit. Operation will generally be better with connection to the filament circuit, although whichever connection works best may be used.

The grid circuit of the tube is completed through a radio frequency choke and a biasing C-battery whose voltage is adapted to the tube in use and to the applied plate voltage. The voltage of the A-battery or filament battery depends on the kind of tube used. Satisfactory results will be secured with from forty-five to ninety

CRYSTAL, FREQUENCY CONTROL BY

volts on the plate from the B-battery. Higher plate voltages are often used, but when the crystal is overloaded by the use of extremely high voltages, up around 400 volts, it will crack and be ruined.

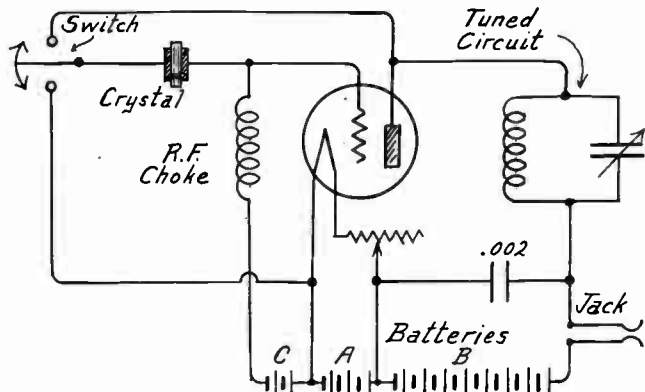

FIG. 3.—Crystal Controlled Oscillator with Tuned Plate Circuit.

The crystal should always be handled with care and its surfaces should be kept perfectly clean by washing with alcohol after becoming clouded. If the surfaces of the crystal become marred or scratched it will probably refuse to oscillate.

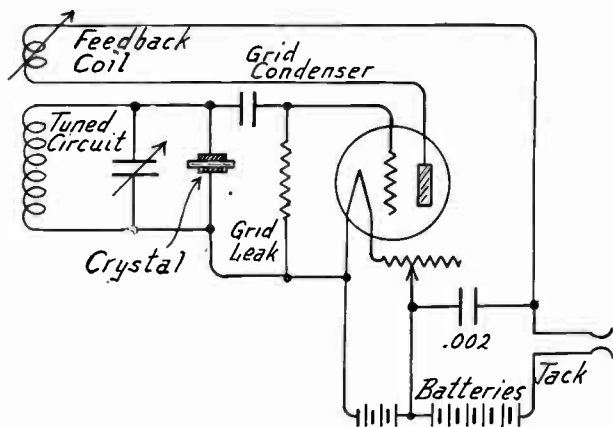

FIG. 4.—Crystal Controlled Oscillator with Tuned Grid Circuit.

The jack in the circuit of Fig. 3 may be used for the insertion of a milliammeter measuring up to five milliamperes for indicating resonance. This jack also may be used for the insertion of headphones.

The oscillator of Fig. 3 uses a tuned plate circuit. The condenser and coil should be chosen to tune to resonance at the frequencies to

CURRENT

be covered. Sizes for broadcasting frequencies are given under *Coil, Tuning, Sizes Required for.*

In operation of the oscillator the tuning condenser is varied while the milliammeter is watched. There will be little change of current until the tuning approaches the natural frequency of the crystal. The current will then drop rather suddenly. With minimum current the crystal is oscillating at its own frequency and slight changes of the condenser's capacity will not change this frequency which is determined by the characteristic of the crystal alone.

In actual practice the plate circuit is not tuned to the exact frequency of the crystal because the absorption of power will stop the tube from oscillating. With the tuning of the plate circuit slightly off the resonant point the oscillator will operate at the crystal's frequency continuously. Crystals are seldom used for frequencies higher than 3000 kilocycles. Higher frequencies are handled by using one of the harmonics of the crystal, of which a very complete series may be generated.

Fig. 4 shows the circuit connections of a crystal controlled oscillator using a tuned grid circuit with a tickler coil for feedback of energy from the plate circuit. The action and operation of this circuit is very much the same as for the one in Fig. 3.

CURRENT.—The flow of electricity through a circuit is called the electric current and is measured in amperes. The current through a circuit is increased when the voltage is increased. It is decreased when the resistance is increased, other things remaining the same.

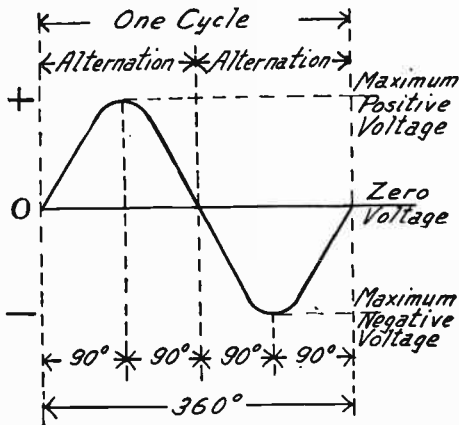

One Cycle of Alternating Current.

CURRENT, ALTERNATING.—In an alternating current the voltage rises from zero to its maximum value, whatever that may be, then falls back to zero and goes on below zero on the negative side just as far as it rose on the positive side. It then comes back

CURRENT, CALCULATION OF

to zero. This rise to positive and fall to negative which starts from zero and ends at zero is called one cycle. This is shown by the diagram.

The rise from zero to maximum positive voltage and the return to zero is one alternation. The drop below zero to the negative voltage peak and the return to zero is another alternation, therefore there are two alternations in one cycle.

One cycle is divided into 360 electrical degrees just as any circle may be divided into 360 degrees. Since one alternation is a half cycle it is 180 degrees. A quarter cycle is then 90 degrees. Any part of a cycle may thus be measured by the number of degrees covered.

Alternations which are maintained by alternating voltages steadily applied to a circuit are called forced alternations. Forced alternations may be maintained in any circuit. If the circuit is oscillatory, containing inductance and capacity, energy applied to the circuit will start alternations or oscillations at the natural or fundamental frequency of the circuit. These are called free alternations.

CURRENT, CALCULATION OF.—See *Law, Ohm's*.

CURRENT, DIELECTRIC.—The current that seems to pass into the dielectric of a condenser is called the dielectric current. See *Absorption, Dielectric*.

CURRENT, DIRECT OR CONTINUOUS.—An electric current which always flows in the same direction through conductors or a current which does not change its polarity is called a direct current or a continuous current. A direct current generally remains at constant voltage, that is, the voltage does not rise and fall. See also *Current, Alternating*.

CURRENT, DISPLACEMENT.—When there is a voltage difference impressed upon opposite sides of an insulator a slight amount of electricity moves in the insulator. This is called displacement current. See *Flux, Dielectric*.

CURRENT, EDDY.—Whenever there is a movement of electromagnetic lines of force through any piece of metal, electric currents are set up in the metal. These are called eddy currents. If

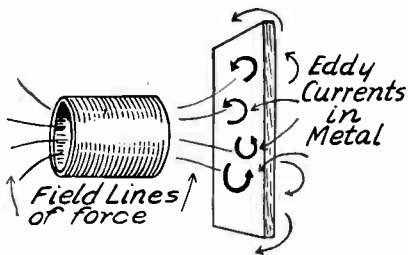

Formation of Eddy Currents in Metal.

the electromagnetic field caused by an alternating or oscillating current in a coil is allowed to pass through parts made of metal, eddy currents are caused to flow in these metal parts. Since it requires considerable energy to produce these eddy currents they place a load or an effective resistance on the circuit which produces them.

CURRENT, FILAMENT

Eddy current losses may be avoided by keeping all metal parts out of the fields or coils.

The loss of energy due to eddy currents increases with increase of resistance in the metal. Shielding a radio frequency coil with copper was found to double the coil's high frequency resistance, shielding with brass trebled the resistance, and with iron the resistance was nine times as great as without any shield.

CURRENT, FILAMENT.—The current which flows through the filament of a vacuum tube is called the filament current. The source of filament current may be the A-battery or any other source of direct current. See also *Circuit, Filament*.

CURRENT, GRID.—The current which flows in the grid circuit of a vacuum tube when the grid is at a positive potential or when the grid of the tube has a positive bias is called the grid current. No grid current will flow when the grid is at negative potential. See *Circuit, Grid; Bias, Grid; and Tube, Characteristics of*.

CURRENT, HIGH FREQUENCY.—Any alternating current at the frequencies used in radio reception is called a high frequency current. Frequencies above 15,000 cycles or 15 kilocycles are generally classed as high frequencies.

CURRENT, PLATE.—The currents which flow in the plate circuit of a vacuum tube are called plate currents. There are two kinds of plate current, one of which is alternating and the other direct.

The direct current is that supplied by the B-battery or other source of plate voltage. The direct current path is shown by full line arrows in the drawing. The alternating plate current is that set up in the plate circuit by the action of the grid in controlling the flow of plate current. The path of these alternating plate currents is shown by broken line arrows in the drawing.

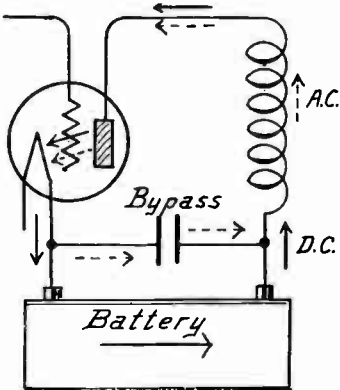

Plate Currents in Vacuum Tube.

The amount of plate current in the direct current circuit is increased by increase of plate voltage. The flow of alternating current in the plate circuit is controlled by the voltage changes on the grid of the tube. There is also an electron flow through the same circuit used by the alternating plate current. This electron flow passes around the circuit in a direction opposite to that of the current flow. See *Tube, Characteristics of*.

CURRENT, PULSATING.—A current which always flows in the same direction through a circuit but whose voltage rises and falls at regular intervals is called a pulsating current or a pulsating direct current. A rectified alternating current whose fluctuations of voltage have not been smoothed out by a filter is a pulsating direct

CURRENT SQUARED METER

current. Most forms of battery chargers which include a rectifier furnish pulsating current to the battery for charging purposes.

CURRENT SQUARED METER.—A meter in which indications vary as the square of current flowing. Under *Meters, Ampere and Volt* see *Types of Meters* for descriptions of thermocouple and hot wire meters.

CURVE.—See *Graph*.

CUSHION SOCKET.—See *Socket, Tube*.

CUTTER, PANEL HOLE.—See *Tools*.

C. W.—An abbreviation for continuous wave. See *Wave, Continuous*. Also an abbreviation for clockwise rotation.

CYCLE.—One complete change of an alternating current from zero to positive then to negative and back to zero is called a cycle. When a current is spoken of as of a certain cycle, the number refers to the number of cycles per second. For instance, a 60-cycle current has sixty complete cycles each second. See *Current, Alternating*.

CYPRESS.—See *Wood*.

D

d.—The symbol for density.

DAMPED WAVE.—See *Wave, Damped*.

DAMPING.—The damping in an oscillating electric circuit determines the rate at which the voltages decrease. This is illustrated in the drawing. Damping is the ratio of one maximum amplitude, such as *A* in the drawing, to the one preceding it in the opposite direction, such as *B* in the drawing. To damp a circuit means to impede the oscillations. The coefficient of damping is equal to the effective resistance in the circuit divided by twice the inductance. Therefore, the damping of a circuit depends on its resistance, being greater the larger the resistance. Damping is also increased by distributed capacity in the inductance coil of an oscillating circuit.

Whenever energy is subtracted from a circuit by any cause that cause is said to introduce damping. All forms of losses in coils and all losses in condensers increase the damping in the circuit. See *Coil, Losses in*, also *Condenser, Losses in*. Any of these forms of damping reduce the voltage or amplitude of the oscillations.

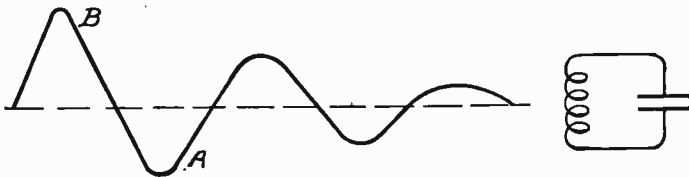

Effect of Damping.

The decrement of a circuit is the damping coefficient of that circuit multiplied by the time of one cycle. This is the logarithmic decrement that is generally called simply the decrement of the circuit.

If the damping effects in a circuit are exactly balanced by energy that is being added to the circuit, the amplitude of successive waves remains constant and there is no decrement or there is zero decrement. A continuous wave has zero decrement.

The decrement or damping in a circuit determines to a great extent the selectivity of that circuit because it determines the sharpness of resonance. Excessive damping of any kind will increase the range of frequencies to which a receiver will respond.

It is possible to have too little damping in a circuit. Tuning then becomes too sharp and the response curve of the receiver is not broad enough to take in a wave channel 10,000 cycles wide. When this condition exists the higher notes will be weakened or cut off.

It has been mentioned that damping is the ratio of the effective resistance to the inductance, being found by dividing the effective resistance by twice the inductance. Therefore, damping does not depend on resistance alone or on inductance alone, but on the ratio between the two.

In an attempt to reduce damping a larger size of wire might be used on a coil. But the larger wire would allow fewer turns per inch and would therefore reduce the inductance at the same time. Thus the resistance of the wire

D. C.

and the inductance would be reduced together and their ratio would show little if any change. Increasing the number of turns of the larger wire in order to regain the lost inductance would add to the wire length and its resistance. Thus the inductance and the resistance would increase together and their ratio would show little change. It is difficult to improve the ratio and reduce the damping, although either factor alone may be easily changed.

The damping so far spoken of is electrical damping but mechanical damping is also used in radio work. Mechanical damping impedes or hinders mechanical oscillatory motion such as the vibration of a loud speaker's diaphragm. Diaphragms used in loud speakers have a natural period or frequency at which they are resonant and they will respond much more strongly at this natural period than at any other period or frequency. Mechanical damping in the form of friction or clamping may be introduced to reduce the effect of this natural resonant period of the diaphragm.

Rooms of certain size and proportion are known to produce loud echoes of certain tones or notes. These echoes may be damped out by the use of heavy draperies or by the use of wall coverings of non-resonant material. This is an example of acoustical damping.

In building transformers it is generally found that the combination of inductance and distributed capacity will produce a stronger response at some one frequency than at other frequencies. This is called the resonance hump of the transformer. It may be reduced by the use of additional damping windings.

D. C.—An abbreviation for direct current. See *Current, Direct or Continuous*.

D. C. C.—Double cotton covered. See *Wire, Cotton Covered*.

DEAD END.—See *Coil, Dead Ends in*.

DECIBEL.—See *Transmission Unit*.

DECREMENT.—See *Damping*.

DECREMETER.—A decrometer is an instrument which measures directly the decrement or damping effect in oscillating circuits. The design and construction of the decrometer is very similar to that of a wave-meter or frequency meter.

DEMODULATION.—Demodulation is the opposite of modulation. In modulation the sound frequencies are added to the carrier wave. In demodulation the carrier wave is removed from the sound frequencies, leaving only the sound frequencies. Demodulation is detection, the function of the detector in the radio receiver. See *Detector, Action of*.

DESIGN.—See names of parts, also see *Construction, Receiver*.

DETECTOR, ACTION OF.—Before considering the action of the detector in a radio receiver it will be well to look into the need for such a device. The first question to arise is, "What is a radio telephone signal?" A radiophone signal is, first of all, a carrier wave coming from a broadcasting station. This carrier wave, as shown in Fig. 1, consists of a series of alternating voltages of equal amplitude at a frequency which is the frequency of the broadcasting station.

DETECTOR, ACTION OF

Modulation.—Sounds of voice or music which are to be transmitted have an effect on the electric current passing through a microphone somewhat as shown in Fig. 2. That is, the rise and fall of a musical note might be represented by a rise and fall of electric current as in Fig. 2. By the process of modulation at the broadcasting station the effect of Fig. 2 is added to the carrier wave of Fig. 1 and the amplitudes of voltages of the successive rises and drops are modified or modulated so that they become as in Fig. 3, this being called a modulated carrier wave.

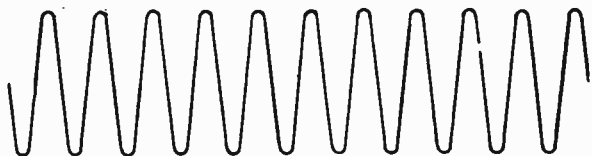

FIG. 1.—Carrier Wave of Constant Frequency and Amplitude.

The shape of the modulated wave is called the envelope. The envelope for the modulated carrier of Fig. 3 is shown by Fig. 4, just as if lines were drawn around and over the positive and negative voltage peaks.

Making the Signals Audible.—The signal or modulated carrier wave of Fig. 3 cannot be heard directly in headphones or a loud speaker for two reasons. First, the positive and negative alternations coming so fast after one another would tend to pull the diaphragm of a speaker first one way, then the other, and these opposite pulls would be so frequent that the diaphragm could move neither

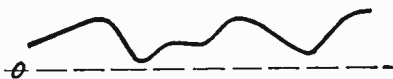

FIG. 2.—The Sound Frequency.

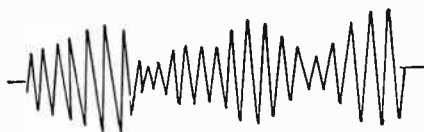

FIG. 3.—Carrier Modulated with Sound Frequency.

way and would stand still. Second, even were the diaphragm sensitive enough to be moved by these high frequency alternations, sounds of this great frequency would be of such high pitch that the human ear wouldn't hear them at all. The ear doesn't respond to sounds whose frequency is much more than 15,000 cycles a second and the lowest frequency used by any broadcasting station's carrier wave is 550,000 cycles per second.

DETECTOR, ACTION OF

So now the question arises, "What must be done to make the signals audible?" We must regain the envelope of Fig. 2, which is at audible frequency just as it went into the microphone which is similar to a telephone transmitter. To regain this envelope we may use either of the halves shown in Fig. 4. We may use the upper or positive half of Fig. 2 or the lower negative half of Fig. 5.



FIG. 4.—The Envelope of the Modulated Carrier.

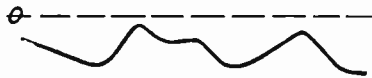

FIG. 5.—Lower Half of the Envelope.

That means we must eliminate the high frequency alternations of the carrier wave and must also remove one half of the remaining envelope. This is the work done by the detector and its associated parts which will be described. The detector receives a signal like the one in Fig. 3 and delivers one like that in Fig. 2 or Fig. 5. See also *Radio, Principles of*.

Kinds of Detectors.—The oldest style of detector still in use is the crystal type. The crystal is a sort of one-way electrical valve. It will let currents pass through in one direction, but not in the other.

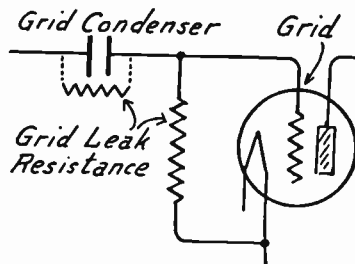

FIG. 6.—Grid Condenser and Grid Leak in Detector Tube Circuit.

This action of the crystal effectively cuts off one half the modulated carrier and then the impedance of the headphones, the loud speaker or an audio transformer eliminates the high frequency alternations of the carrier. See *Detector, Crystal*.

There are two types of vacuum tube detectors. They do not differ in the kind of tube that may be used, but they do differ in the way of using the tube. The most generally used system is one in which the detector tube is used in connection with a grid condenser and grid leak as in Fig. 6. This outfit is said to obtain detection by grid

DETECTOR, CRYSTAL

current rectification. Another system uses no grid condenser or leak, but provides means of adjustment for the grid bias, for the filament voltage, or for the plate voltage so that the bend of the grid voltage-plate current curve is utilized in obtaining detection by plate current rectification. See also *Tube, Detector Types of*.

The actions of the detectors are described in detail under their different headings. It requires some little time to read about one complete series of causes and results, but it should be remembered that the work of a detector must be done so rapidly that one complete series of changes takes place for each change in value of the envelope. These changes take place at audio frequencies, so they must be completed at the rate of from 25 to 10,000 for each second that the signal lasts.

DETECTOR, C-BATTERY TYPE.—See *Detector, with Grid Bias*.

DETECTOR, CRYSTAL.—Contacts between various minerals will allow electricity to flow quite freely through them in one direction but strongly oppose the flow in the reverse direction. An incoming radio signal consists of an alternating current with the voltage rising to positive then falling to zero and dropping to the same value negative that it formerly had positive.

When a crystal of certain minerals is inserted in a circuit carrying such an alternating current, the positive voltages will pass through the crystal and will be carried on to the part of the circuit on the



FIG. 1.—Effect of Crystal Detector on Carrier Wave.

other side of the crystal. But the negative voltages will be prevented from flowing so that the signal is changed from a series of positive and negative alternations to a series of positive rises with little or no trace of negative alternations remaining.

Action of Crystal.—The effect of a crystal detector on a signal such as that of Fig. 3 under *Detector, Action of* is shown in Fig. 1. The bottom halves of all the waves have been cut off, leaving only the rises or positive halves. These of course follow the signal's envelope. One of the simplest forms of crystal detector circuit is shown in Fig. 2. The antenna is coupled to a tuned circuit and the voltage changes across this tuned circuit are passed through the crystal detector, shown by its symbol. This leaves only the one-way pulses to affect the headphones.

The impedance of the headphone windings is so high that the high frequency alternations cannot pass through them. These high frequency alternations complete their path through the bypass condenser. This bypass condenser is of a capacity too small to allow the comparatively slow rises and falls of the signal's envelope to go through it. Therefore these slow rises and falls of the envelope pass through the headphone windings and the signal is heard.

Kinds of Crystals.—The crystal itself is an irregular shaped piece of mineral mounted in a cup as shown in Fig. 3. These cups are one-half inch in outside diameter and are filled in around the crystal with a metal alloy of low melting point. The sensitive face

DETECTOR, CRYSTAL

of the crystal is upward. Contact with this sensitive surface is through the tip of a small stiff wire called the cat whisker. The cat whisker is usually mounted on an adjustable screw pin of some kind. This adjustment allows the end of the cat whisker to be moved about until it finds a sensitive spot on the crystal.

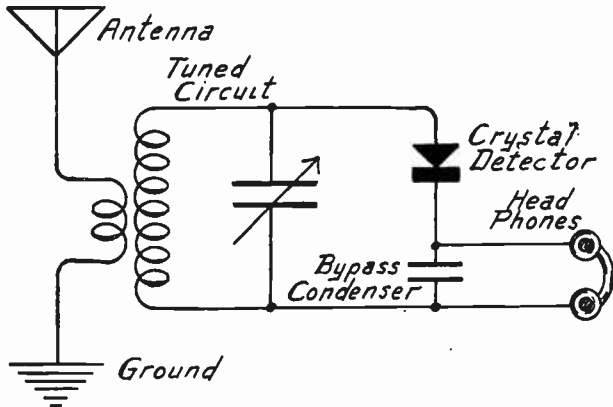

FIG. 2.—Simple Crystal Detector Circuit.

Some crystals have a fixed cat whisker which is placed in contact with a sensitive portion of the mineral and remains there. The crystal and the cat whisker may be protected from dirt and dust by a glass cover as in Fig. 4.

Galena, which is sulphide of lead, is used more than any other material as a crystal detector. It is very sensitive. Zincite and silicon also are used. With any of these materials the adjustment between the surface of the crystal and the wire bringing the current to it is very delicate and requires careful adjustment.

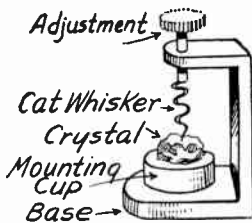

FIG. 3.—One Form of Crystal Detector.

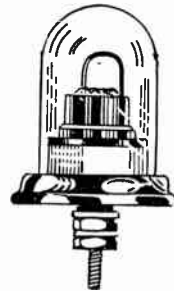

FIG. 4.—Crystal Detector with Fixed Cat Whisker.

A silicon crystal detector requires the use of an extra heavy cat whisker and its signals are not as loud as those from galena or pyrite. A galena detector is sensitive and gives a louder signal than either pyrite or silicon. Galena requires a very light cat whisker contact and is therefore not so reliable, requiring more frequent adjustment of the cat whisker to find a sensitive spot. Cat whiskers are made of any metal which does not corrode or rust. They are often gold plated or may be of solid gold.

DETECTOR, CRYSTAL

A very loud signal or a heavy burst of static will often destroy the sensitive point of contact between crystal and cat whisker. It is then necessary to move the cat whisker to a new point before detection will again take place.

A vacuum tube used as a detector not only operates as a detector but at the same time operates as an amplifier. This is the reason that louder signals are delivered by a vacuum tube detector than by a crystal detector because the crystal does not act as an amplifier.

Carborundum Detector.—There is another material, carborundum, which is not nearly so sensitive as galena but which is not easily thrown out of adjustment. With a galena crystal the pressure exerted by the point of wire, called the cat whisker, on the crystal is only a matter of an ounce or less. With carborundum this pressure may be around four or five pounds between the two parts. Contact with the carborundum is made through a fine steel point.

In order to obtain as sensitive an action with carborundum as with galena it is necessary to use a small battery called a biasing or polarizing battery in the circuit. The connections are shown in Fig.

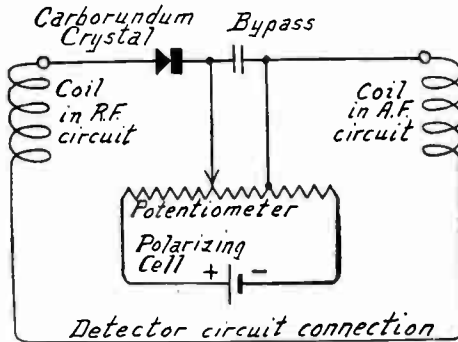

FIG. 5.—Use of Polarizing Battery with Crystal Detector.

5. The effect of this battery is to keep a small voltage continually applied across the crystal. The signal voltages and current waves are then added to and subtracted from this steady voltage.

With carborundum the conductivity increases greatly when the biasing voltage is made of a certain critical value. In other words the voltage lowers the resistance of the carborundum and allows the signals to come through with much greater strength.

The polarizing battery also causes the operation to take place at such a point on the characteristic curve of the carborundum that the mineral acts as a very efficient detector or rectifier of the alternating current. The curve of a carborundum detector is shown in Fig. 6. With a zero voltage the rises and falls of signal voltage are passed almost equally well through the carborundum, or rather they both are opposed about equally well. But when the polarizing voltage is made sufficiently positive, operation takes place at the greatest bend in the curve. Alternations of one polarity are then greatly opposed or almost entirely cut off while alternations of opposite polarity are passed through the carborundum with comparative freedom. At this point of the curve the best detection is obtained.

A satisfactory arrangement of a carborundum detector is shown in Fig. 5. The detector is used in connection with a dry cell and a potentiometer which

DETECTOR, POWER TYPE

allows various positive or negative voltages from the dry cell to be placed in series with the carborundum. A bypass condenser is placed across the potentiometer so that its high resistance is not inserted in the radio frequency circuit.

Adjustment of the biasing voltage is made to allow the most advantageous balance between selectivity and sensitivity. The range of voltage is from three-

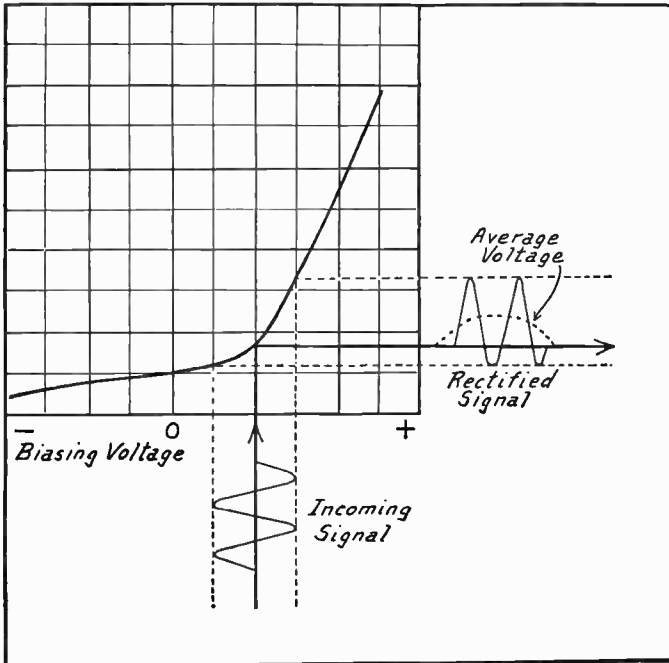

FIG. 6.—Effect of Biasing Voltage on Carborundum Crystal Detector.

quarter volt positive to three-quarter volt negative. The greater the positive voltage the less will be the resistance and the greater the negative voltage the higher will be the resistance. A fairly high resistance increases the selectivity. Operation of the potentiometer gives a certain control of regeneration and oscillation in a radio frequency tube preceding the detector.

See also *Receiver, Crystal*.

DETECTOR, POWER TYPE.—A power detector is a detector tube operated with high plate voltage and correspondingly high grid bias, allowing it to handle without distortion radio frequency input signal voltages much greater than can be handled with an ordinary detector. The output from a power detector is strong enough to satisfactorily operate a power amplifying tube without the use of an intermediate audio frequency amplifying stage between detector and power tube. Excellent tone quality results from high signal voltages on the detector grid. Consequently, the power detector should be preceded by a high gain radio frequency amplifying-

DETECTOR, WITH GRID BIAS

ing system. The quality on weak signals remains equal to that secured with ordinary low voltage detectors.

When power detection is used with a grid bias system (plate rectification) the plate voltage must be high enough to insure operation on a straight part of the curve and not on the bend as is done with low voltage detection. A weak input signal will force operation on the bend and will result in some distortion. The amount of negative grid bias should equal the peak voltage of the strongest signal to be handled.

A small power tube such as the "112-A" or an A. C. heater tube like the "227" will make a satisfactory power detector. A high "mu" amplifying tube is not satisfactory because of poor response at high audio frequencies. A power detector is operated with plate voltage and grid bias one-fourth or more above the highest values recommended when the tube is used as an amplifier. It is necessary that any transformer used in the plate circuit of one of these detectors have high primary impedance. The less the detector plate current the higher will be the transformer's primary impedance. Circuit connections for these detectors are no different from those used for low voltage detectors. The plate bypass condenser may have a capacity slightly greater than usual, but not great enough to bypass high audio frequencies.

Since the input voltage from the radio frequency amplifier to a power detector must always be high for good quality, volume controls in the radio frequency amplifier are not wholly satisfactory because they reduce the input to the detector. It is advisable to have the sole volume control, or at least an auxiliary control, in the form of a variable resistor across the primary of the coupling transformer which follows the detector tube.

The heater type of screen grid tube makes a satisfactory power detector as explained under *Tube, Screen Grid, A. C. Heater Type*. These tubes are used with a plate voltage of 180 and with a screen voltage of 75 for a control grid bias of 7.5 volts or with a screen voltage of 45 for a bias of 4.5 volts. The screen grid power detector may be coupled to the power amplifying tube by means of a transformer with high primary impedance. An alternative coupling method uses a plate impedance formed by a 500-henry choke shunted with a 250,000-ohm resistor in the detector plate circuit and connected to the power tube grid through a condenser of 0.1 microfarad capacity. A one-megohm grid leak is used on the power tube.

Power detection may be secured with grid rectification (grid leak and condenser) by applying suitable plate voltages to amplifying tubes such as those mentioned for grid bias detection. The plate voltage is made high enough to insure that the tube works on a straight portion of the plate current-grid voltage curve for all applied signals. Zero grid bias is used with the grid return end of the grid leak connected to the B-minus line. Power tubes with low amplification factors do not make satisfactory grid rectification power detectors because they allow too great flow of plate current with the zero grid bias. The grid leak for a power detector should be of less resistance than for a low voltage detector, one-quarter megohm being about the maximum value. The grid condenser also should be smaller, having a capacity between 0.0001 and 0.00015 microfarad.

DETECTOR, WITH GRID BIAS.—Under a preceding heading, *Detector, Action of*, it was mentioned that one method of using a vacuum tube as a detector employs what is known as plate current rectification. This simply means that advantage is taken of an offsetting or unbalancing of the plate current from the tube due to the fact that changes of grid voltage have unequal effects on the rises and falls of plate current.

To understand this action it is necessary to examine Fig. 1 which shows a plate current-grid voltage curve for a vacuum tube. That is, the curve of Fig. 1 shows the changes caused in the flow of plate

DETECTOR, WITH GRID BIAS

current by changes in the voltage applied to the grid. At the top of the curve or graph of Fig. 1 are shown various grid voltages from six volts negative at the left to four volts positive at the right. At the left of the graph are shown the plate currents in milliamperes that flow for the different grid voltages.

For example, suppose the grid were at one and one-half volts negative, as shown by the small arrow. Following down on this one and one-half volt line until it intersects the curve, then following a horizontal line from the point of intersection toward the left, it is seen that this horizontal line cuts the plate current scale at 0.5 or

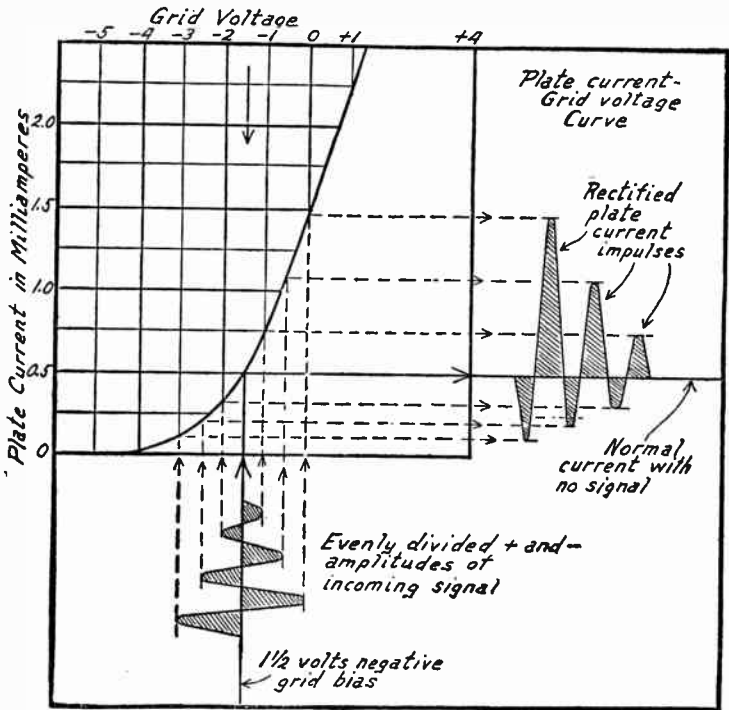

FIG. 1.—Action of Detector Using Grid Bias for Plate Current Rectification.

one-half milliampere. Assuming that the grid biasing voltage, or the grid's voltage with no signal coming in, is one and one-half volts negative, the steady plate current that flows under this condition is one-half milliampere.

Any signal coming to the grid of the tube will have its own voltage added to or subtracted from this grid voltage. Below the curve is shown a wave train of equal positive and negative amplitudes. The highest of these amplitudes, all of which start from the one and one-half volt negative bias line, will cause the grid's voltage to first drop down to about three volts negative, then to rise to about zero

DETECTOR, WITH GRID BIAS

voltage on the curve as shown by the broken lines drawn upward from the signal amplitudes to the plate current-grid voltage curve.

When the grid voltage is depressed to three volts negative, the corresponding plate current is about 0.1 milliamperes. When the grid voltage rises to zero, the plate current is about 1.5 milliamperes. Lines are drawn from the other grid voltage amplitudes up to the curve. The corresponding rises and falls of plate current are shown at the right hand side following the broken lines drawn toward the right from the intersections of the grid voltage lines with the curve.

Effect of Bend in the Curve.—A peculiar effect will be seen in the plate current impulses shown at the right of the curve. The rises of plate current above the normal current line are much greater than the drops of plate current below this normal line. Yet the amplitudes or voltage changes of the signal are equal on both sides of the grid voltage line. This is the effect called plate current rectification.

In Fig. 2 the fluctuations of plate current shown at the right of Fig. 1 are drawn to a larger scale. It will be seen that the average value of plate current rises or increases during the signal, this average rise being shown by the broken line curve of Fig. 2. At the bottom of Fig. 2 is shown the value of the changing plate current, or average current, and it may be seen that there is a net rise.

This peculiar effect is due to the bend in the plate current-grid voltage curve of Fig. 1. This bend is near the bottom of the curve. The grid voltage with no signal must be such that the operation is on this bend of the curve. Otherwise there would be no offsetting of the current and no rectification taking place. It is easy to see that were the normal grid voltage higher up on the curve, where the curve is practically straight, the rise and fall of plate current would be equal above and below the normal line. A rise of grid voltage caused by the signal would cause a change of plate current just equal to the change caused by a drop of grid voltage. The operating point of the detector is where the average grid voltage intersects the curve.

The sharper the bend in the curve the more effective will be the action of the detector in reducing the strength of the amplitudes in one polarity while increasing the strength of those in the opposite polarity. The tube's grid voltage-plate current curve indicates the effectiveness.

Operation on the Bend.—Since this detector action depends on getting the operating point onto the bend of the curve it is necessary to make whatever adjustments are required to satisfy this condition.

There are three ways in which the operating point may be moved up and down the plate current-grid voltage curve until the most

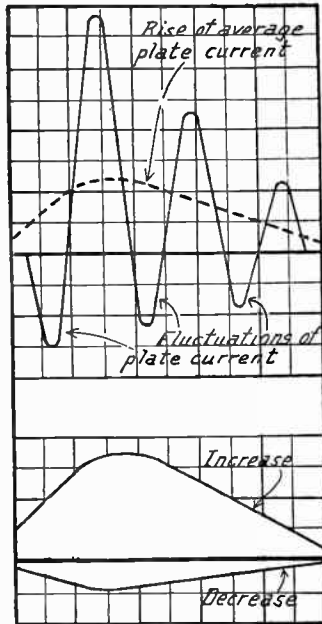

FIG. 2.—Average Rise of Plate Current from Detector with Grid Bias.

DETECTOR, WITH GRID BIAS

pronounced bend and most satisfactory detection are found. These are: first, by changing the grid bias; second, by changing the plate voltage or B-battery voltage on the detector tube; and, third, by changing the filament voltage or filament temperature.

It has already been found, from Fig. 1, that changing the grid bias voltage will move the operating point onto the bend or away from it. The effect of changes in plate voltage is shown in Fig. 3. Increasing the plate voltage moves the curve toward the left. In Fig. 3 it may be seen that eighteen volts on the plate brings the sharpest bend of the curve around zero grid voltage. Forty-five volts on the plate moves the bend so that its center is near two volts negative on the grid. One hundred volts on the plate moves the bend way over to nine volts negative on the grid.

Different tubes of the same identical type and make may have widely different operating points for best detection, consequently it is necessary to provide adjustment for change of grid voltage, plate voltage or filament

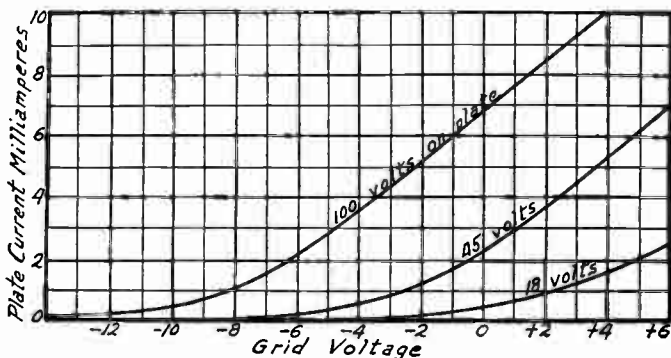

FIG. 3.—Effect of Plate Voltage Change on Grid Voltage-Plate Current Curve.

voltage, whichever method is used for changing the operating point. It will often be found that a tube may be an excellent detector but a poor amplifier, and a good amplifier may be a very weak detector. Used as a detector, a hard tube generally works best with from forty to forty-five volts on the plate. However this kind of a tube may work very well with twenty volts on the plate. A soft tube used for a detector almost always works best with from sixteen to twenty-two volts on its plate, and will hardly ever prove a satisfactory detector with a high plate voltage.

Methods of Biasing.—There are three different methods of changing or adjusting the amount of biasing grid voltage, these being shown in Figs. 4 to 7. In Fig. 4 is shown the use of a potentiometer in the grid return of the detector tube. The potentiometer arm is connected to the grid return and the two sides of the potentiometer are connected to the positive filament and negative filament lines of the tube. Moving the potentiometer arm toward the positive end will make the grid bias less negative or more positive. Thus the operating point as shown in Fig. 1 may be moved up and down the curve until best detection is secured.

DETECTOR, WITH GRID BIAS

In Fig. 5 is shown the use of a C-battery or biasing battery to obtain the necessary grid voltage. The grid return is connected to the negative side of the biasing battery and the positive side of the battery is connected to the negative filament terminal or negative filament line for the tube. The difficulty with this arrangement is that the grid voltage can be varied only in steps of $1\frac{1}{2}$ volts each,

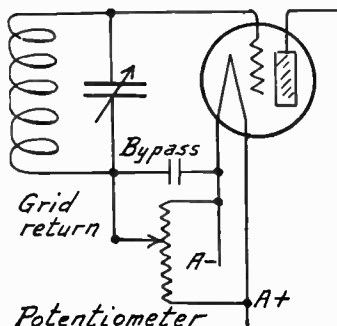

FIG. 4.—Detector Grid Bias with Potentiometer.

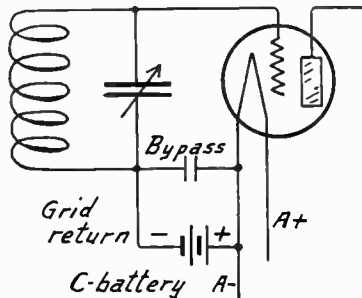

FIG. 5.—Detector Grid Bias with C-battery Alone.

this being the voltage of a single dry cell such as used in C-batteries. The ideal operating point may easily come midway between two of these steps and best detection cannot be secured.

This difficulty may be overcome and a gradual change of grid voltage secured by using the connection shown in Fig. 6. Here the positive side of the C-battery is connected to the battery side of the rheostat for the detector tube in place of being connected directly to the negative filament terminal of the tube. Now the voltage drop across the rheostat forms a

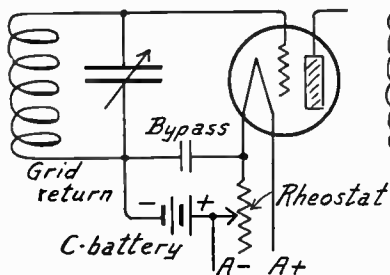

FIG. 6.—Detector Grid Bias with C-battery and Rheostat.

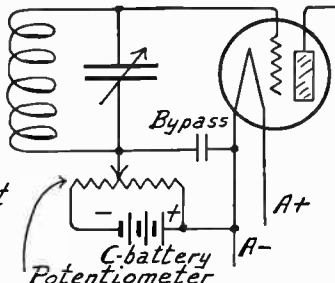

FIG. 7.—Detector Grid Bias with C-battery and Potentiometer.

negative grid bias of its own and this negative bias is added to the negative bias of the C-battery. The C-battery bias cannot be changed, but the rheostat arm may be moved to slightly change the total bias and secure an operating point on the sharpest part of the bend in the curve. In using either of the methods employing a C-battery, it is seldom if ever that more than two cells, or three volts, of the C-battery will be needed. In most cases, especially when using the rheostat drop also, one cell of C-battery will be ample for the work.

DETECTOR, WITH GRID BIAS

Another method of securing a gradual change of negative grid voltage is shown in Fig. 7. Here a potentiometer is connected across the C-battery and the grid return is connected to the arm of the potentiometer. The positive side of the C-battery is connected to the negative filament line or terminal of the tube as shown. With the potentiometer arm moved over to the positive side of the C-battery, the detector will have a zero grid bias, while moving the arm over toward the negative side of the C-battery will increase the negative bias up to the full voltage of the C-battery. This method is undesirable because the continual flow of current from the C-battery through the potentiometer will soon discharge the small C-battery.

A bypass condenser of at least .001 microfarad capacity should always be connected across a potentiometer so that the radio frequency currents will not have to pass through the high resistance of the potentiometer.

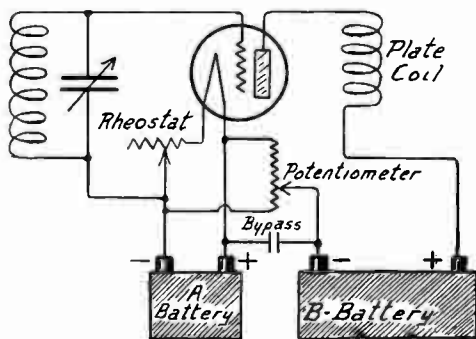

FIG. 8.—Detector Grid Bias with Potentiometer on B-Battery.

In Fig. 8 is shown a satisfactory method of obtaining gradual adjustment of the B-battery voltage or plate voltage on the detector tube. In place of connecting the negative side of the B-battery directly to either the positive or the negative terminal of the A-battery, as is usually done, the negative of the B-battery is attached to the arm of a potentiometer whose two sides are connected to the negative and positive sides of the A-battery lines or to positive and negative filament terminals of the tube. Here again a bypass condenser is placed across the high resistance of the potentiometer.

To make the initial adjustment, place the potentiometer arm at the center of its travel. Then try different B-battery voltages by changing the connection from one tap or one cell to another until good average results are obtained in detector action. The potentiometer arm may now be moved one way or the other to increase or decrease the B-battery voltage on the plate since the potentiometer will have the effect of inserting more or less of the A-battery voltage in the plate circuit.

In Fig. 8 there is a continual flow of A-battery current through the potentiometer while the receiver is in use. With the A-battery this is not a serious objection since the discharge through the potentiometer adds but little to the regular discharge for the tube filaments. It is best to use a high resistance potentiometer, one whose resistance is at least 400 ohms, to minimize the battery discharge.

DETECTOR, WITH GRID CONDENSER AND LEAK

It will be seen by the diagrams of Figs. 4 to 8 that neither grid condenser nor grid leak are used when employing plate current rectification. The grid of the detector tube is connected directly to its grid coil.

It was mentioned that change of filament voltage and temperature may be used when plate current rectification is employed for the detector. The results will not be as satisfactory as when using any of the methods shown in Figs. 4 to 8. A very low filament temperature is used, with most of the resistance of the rheostat in the circuit. A rheostat with twenty-five ohms resistance should be employed.

DETECTOR, WITH GRID CONDENSER AND LEAK.

—The circuit connections for the generally used type of detector are shown in Fig. 1. Following is a brief summary of the action which is described in more detail farther along in this section.

While the grid is positive it attracts electrons from the hot plate just as a positive plate would attract them. But when the grid is negative there is no attraction.

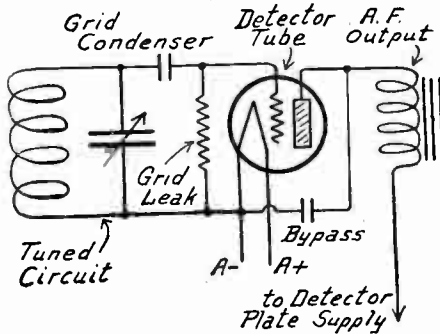

FIG. 1.—Typical Detector Tube Circuit with Grid Leak and Condenser.

The electrons are negative charges. Each of the positive alternations in the signal draws its share of negative charges over onto the grid. The grid continues to accumulate an increasing negative charge all through one of the series of waves which compose a signal.

This accumulation goes on because, so far as flow of direct current is concerned, the grid is connected to the filament circuit only through the high resistance of the grid leak. The accumulating negative charges or negative electricity cannot leave the grid through the grid condenser because a condenser will not pass direct current. These electrons, all of negative polarity, would necessarily form a direct current.

The resistance of the leak is so high, a million or more ohms, that the negative charge being piled up on the grid by the signal can flow away but slowly through the leak. Therefore, as long as the voltages in the signal continue to increase, the grid becomes more and more negative. This is because the negative charges accumulate

DETECTOR, WITH GRID CONDENSER AND LEAK

faster than the leak can carry them away. But, when the signal voltages start to diminish, the negative charge on the grid likewise diminishes since the electrons then flow away through the leak faster than they are added by the diminishing signal voltages.

Rise and fall of signal voltage thus causes a gradual fall and rise of grid voltage or of the negative charge on the grid. The changing value of negative charge on the grid causes corresponding changes of plate current. Thus the signal voltage changes are turned into plate current changes which exactly follow the signal.

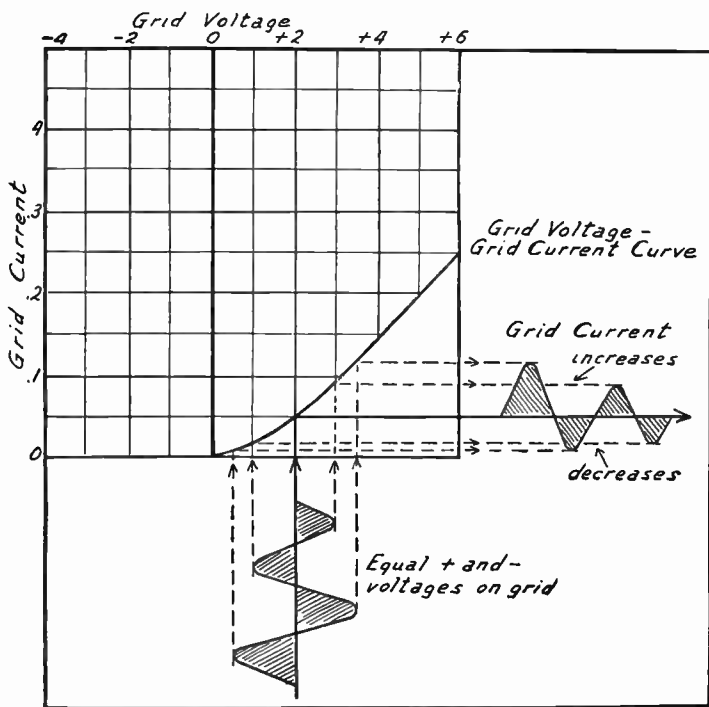

FIG. 2.—Effect of Grid Voltage on Grid Current with Grid Condenser.

Current Flow in Grid Circuit.—In explaining the detector's action it was mentioned that a detector tube employing a grid condenser and grid leak takes advantage of what is known as grid current rectification. This term refers to the effect of changes in grid voltage on the flow of current in the grid circuit of a vacuum tube. In Fig. 2 is a curve which shows the amount of grid current caused to flow with different values of positive voltage on the tube's grid.

The upper horizontal line represents grid voltages both above and below zero. Those above zero, at the right of the zero mark, are positive voltages and those below the zero at the left of the zero

DETECTOR, WITH GRID CONDENSER AND LEAK

mark are negative. Taking any voltage on this line and following straight down until the curve is met, the corresponding grid current is shown on the vertical scale of numbers at the left.

It will be seen that the curve starts at zero grid voltage. There is a flow of grid current when the grid is at a positive voltage but no flow of grid current when the grid is at a negative voltage. When the grid is at a positive voltage it attracts electrons and there is a flow of current between the grid and the filament.

We may now take a series of modulated alternations and see what effect these changing grid voltages will have on the flow of grid current. A series of alternations is shown in the lower part of Fig. 2. Broken lines are drawn from the peaks or maximum points of positive and negative grid voltages upward until they strike the grid current curve. Corresponding lines are drawn to the right from the points where the grid voltages intersect the curve. The resulting grid current fluctuations, increases and decreases, are shown at the right of the curve.

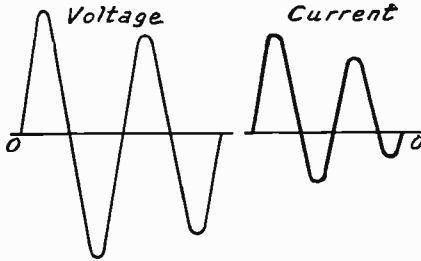

FIG. 3.—Corresponding Grid Voltages and Grid Currents in Detector with Grid Condenser.

Effect of Bend in Current Curve.—A careful examination of the grid current changes will show that the bend near the bottom of the grid current curve produces a peculiar result. The alternations of incoming grid voltage are of equal amplitude on both sides of the line. But the bend in the curve causes an offset or rectification effect and the increases of grid current are greater than its decreases. This effect is clearly shown in Fig. 3 where the equal alternations of grid voltages are shown at the left and the unequal changes of grid current are shown at the right. During one series of waves there is an average increase of grid current. This effect is essential to the operation of the tube as a detector and should be borne in mind during the following explanation.

Accumulation of Negative Charge.—The flow of grid current is from grid to filament as shown in Fig. 4. The average increase of grid current flows through the grid, the filament and the grid leak.

During the flow of grid current there is an accompanying passage of negative electrons in the reverse direction, that is, from filament to the grid. This is shown in Fig. 5. The only path through which these electrons may complete their circuit and pass back to the fila-

DETECTOR, WITH GRID CONDENSER AND LEAK

ment from which they started is through the high resistance of the grid leak.

Since, during a series of waves, there is an average increase of grid current, there must likewise be an average increase of electron flow. As the electron flow tends to increase it is held back by the high resistance of the grid leak and an accumulation of negative electrons collects on the grid and on the side of the grid condenser connected to the grid. This accumulation is indicated in Fig. 5. This increasing quantity of negative electrons on one side of the grid condenser and on the grid, causes the grid itself to become more and more negative.

The effects of a signal may be more easily understood by reference to Figs. 6 and 7. Fig. 6 represents the modulated carrier wave. The effects of a wave train acting upon the grid would, as shown by Fig. 7, cause an average rise of grid current as long as the signal amplitudes or voltages continue to increase. When the signal amplitudes begin to decrease there is a corresponding fall of average grid current. An average rise of grid current flowing as in Fig. 4 results in an accumulation of negative electrons on one side of the

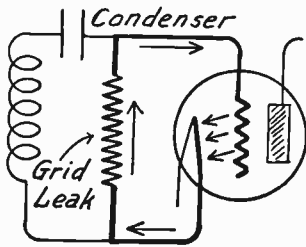

FIG. 4.—Path of Grid Current in Detector with Grid Condenser.

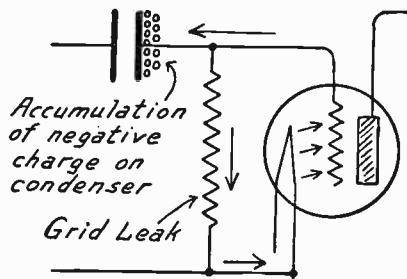

FIG. 5.—Electron Flow in Detector Grid Circuit with Grid Condenser.

grid condenser as in Fig. 5 and depresses the grid voltage or makes the grid voltage become more negative. This is shown in Fig. 7. As the average grid current decreases, the average grid voltage will rise or become less negative.

Signal Effect on Grid Voltage.—We have thus changed an incoming signal of equal positive and negative amplitudes, such as the signal of Fig. 6, into an average decrease and increase of negative grid voltage as shown in Fig. 7. This is the second important step in the action of this type of detector. The entire wave train with which we started in Fig. 6 has now been changed into a falling and rising of the average negative grid voltage such as shown in the lower part of Fig. 7. The changes in negative grid voltage are seen to follow exactly the shape of the envelope of the signal from which the detector action started.

Grid Voltage Effect on Plate Current.—The curve of Fig. 8 is somewhat similar to the curve of Fig. 2 but in Fig. 8 is shown the effect of the changing grid voltage on the flow of current in the plate circuit of the tube. The grid voltages, positive and negative, are shown along the upper horizontal line while the corresponding values

DETECTOR, WITH GRID CONDENSER AND LEAK

of plate current in milliamperes are shown along the left hand vertical line. Taking any value of grid voltage, either positive or negative, and following straight down until the line for this value intersects the curve, the corresponding plate current may be found directly at the left of this intersection. For example, in Fig. 8 one volt positive on the grid causes a flow of four milliamperes in the plate circuit.

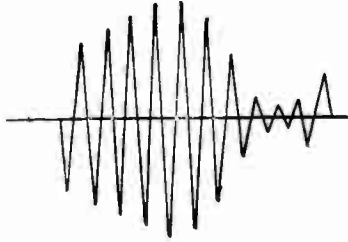

FIG. 6.—Equal Amplitudes of Modulated Carrier Wave Coming to Detector.

The average negative grid voltages which have resulted from grid current rectification such as in Fig. 2 and the consequent negative grid charge as in Figs. 5 and 7 are shown at the bottom of Fig. 8. Tracing all of these voltage changes upward to the plate current curve and then drawing lines from the intersections out toward the right will show the changes of plate current which result from these

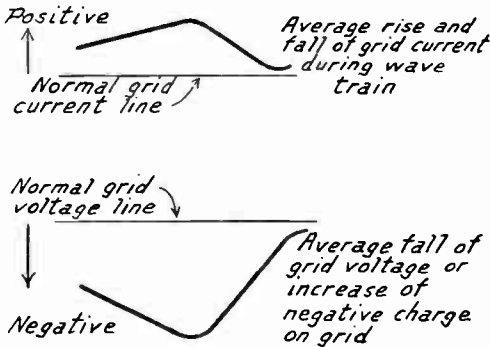

FIG. 7.—Effect of Signal on Grid Current and Grid Voltage in Detector.

average negative grid voltages. It will be seen that the changes in plate current shown at the right of Fig. 8 are an almost exact duplicate of one half of a signal envelope. The detector has completed its work, has taken the incoming high frequency alternations with equal positive and negative voltages and has produced the average rise and fall of plate current which represents one-half of the signal envelope.

DETECTOR, WITH GRID CONDENSER AND LEAK

Detection by Lowering the Plate Current.—A further examination of Fig. 8 will show that every time the grid becomes more negative there is a corresponding decrease of plate current and every time the grid becomes less negative in voltage there is a corresponding rise of plate current. But it should also be noticed from Fig. 8 that the value of the plate current in which is reproduced the signal is always less than the plate current with no signal being received.

At zero grid voltage it is seen from the curve of Fig. 8 that the flow of plate current will be about two and three-fourths milliamperes, this being shown by the line of plate current with no signal as drawn out toward the right from the curve. All of the changes in plate current fall below this line. Therefore, we say that detection with a grid condenser and leak is accompanied by decreases of plate current. Detection with a grid condenser is never accompanied by increases of plate current above the normal flow. This is one particular in which a detector using a grid condenser differs from a detector using a grid bias, the grid bias type causing increases of plate current.

Selection of Grid Bias.—Going back once more to Fig. 2 it will be noticed that the zero line or center line of the grid voltages in the wave train shown below the curve does not coincide with the line of zero grid voltage. The zero line between positive and negative alternations strikes the curve at about two volts positive. This two volt positive voltage is the voltage of the grid when no signal is being impressed, that is, it is the grid bias voltage.

It will be realized that the grid bias voltage determines the operating point on the curve. It determines the point on the curve from which either increases or decreases of voltage must start. If this operating point is on the positive side as in Fig. 2 any increase of grid voltage caused by an incoming signal will cause the grid voltage to be still higher while decreases of incoming voltage are subtracted from the grid bias voltage and thus lower the net voltage on the grid.

This grid bias voltage depends upon the connection of the grid return and grid leak. The grid return and grid leak may be connected to the positive end of the filament or to the negative end of the filament. Hard tubes used for detectors should have the grid leak or grid return connected to the positive end of the filament because this makes the grid bias positive and better detection is obtained than with a negative starting voltage.

The grid voltage is also affected by the voltage drop across the grid leak. It has been mentioned that the grid current, which is a direct current, must pass through the grid leak. The voltage drop is equal to the resistance of the leak in ohms multiplied by the grid current in amperes. This voltage drop combined with the voltage of the end of the filament to which the leak is attached determines the grid voltage.

The reason for desiring a positive grid voltage may be seen in Fig. 2. There is a decided flow and rapid rise of grid current while the grid is positive but there is no grid current whatever when the grid is negative. So if we were to use a negative grid voltage we would not be making use of that part of the grid current curve in which there is the greatest change of current for a given change of grid voltage.

DETECTOR, WITH GRID CONDENSER AND LEAK

Values of Grid Condenser and Leak.—At the end of each train of high frequency waves which have caused an accumulated negative charge on the grid and the grid condenser, this accumulated charge escapes by way of the grid leak, flowing to the filament where it is neutralized. This leaves the grid condenser discharged and ready to receive another accumulated negative charge from the following high frequency wave train.

The time that is required for the negative charge to leak away depends upon the resistance of the grid leak and on the capacity of the grid condenser. The time that it takes for all of the accumulated negative charge to leak

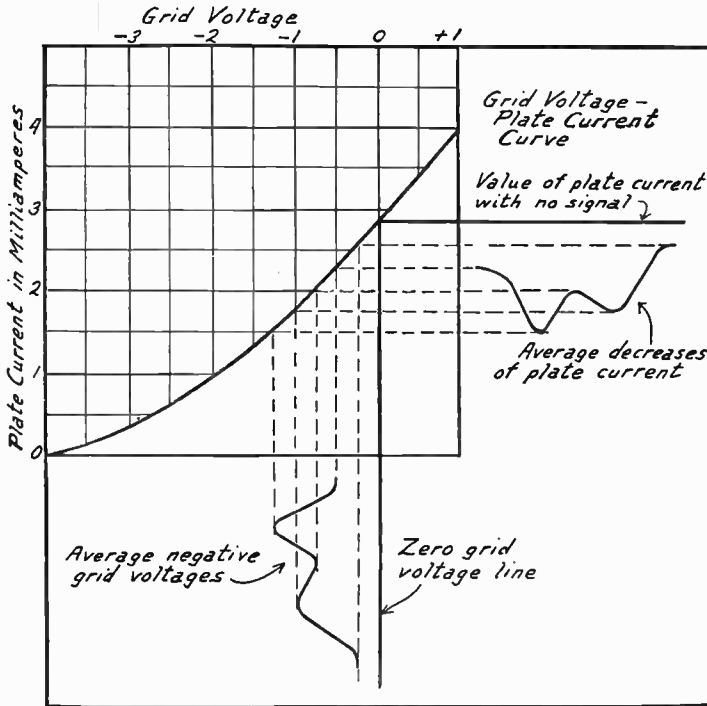

FIG. 8.—Effect of Detector Grid Voltage on Detector Plate Current.

away must be less than the interval of time between successive wave trains. If the previous negative charge has not completely disappeared and left the condenser discharged, the effect of the following wave train will be lessened because there is still some of the previous charge remaining on the condenser.

The greater the resistance of the grid leak the longer will be the time required for the negative charge to leak away because the high resistance of the leak prevents rapid dissipation of the charge. It is also true that the larger the grid condenser the longer will be the time required for discharge because the larger condenser holds a larger charge which naturally takes longer to leak away. A high resistance leak and a large capacity condenser are better for the reception of weak signals because the high resistance leak allows building up of a maximum possible negative charge while the large

DETECTOR, PLATE BYPASS FOR

condenser has sufficient capacity to receive and hold all possible charge. With the longer time required for discharge, the grid voltage is held negative for longer. Consequently the plate current is held depressed during a longer time and there is a stronger response to the signal.

An extremely high resistance in the grid leak may defeat its own purpose by preventing the flow of sufficient grid current to obtain the desired voltage drop across the leak. This reduced grid current will reduce the flow of negative electrons and reduce the amount of negative charge on the grid.

Should a strong signal be received while a high resistance leak and a large condenser are in use the strong signal may give such a large negative charge to the condenser and grid that this charge cannot leak away over the high resistance grid leak before the next strong wave train comes along. The condenser will retain such a large negative charge that the additional charge from an incoming signal will have comparatively little effect. The tube is then said to be blocking. See also *Leak, Grid*.

DETECTOR, PLATE BYPASS FOR.—It will be realized that while there is a gradual change of the average plate current from the detector, this average is composed of a great number of rapid rises and drops of current. In fact, the plate current is still a high frequency current.

High frequency currents will not easily pass through the high impedance of headphone windings, of audio frequency transformers, of resistance amplifiers, or of any unit that follows the detector tube. To act upon these units we want only low frequency changes or audio frequency currents as represented by the average rise and fall of plate current, not as represented by the high frequency fluctuations.

The detector tube changes the signal voltages into a gradual rise and fall of plate current corresponding exactly to part of the signal envelope. These rises and falls of average plate current are at audio frequency and will act through the impedance of whatever device follows the detector.

Such high frequency currents as might get through the coupling unit which follows the detector tube would not produce audible signals, since their frequency is far above the highest limits of audibility. Yet they would impose a load on the audio frequency amplifying tubes, being amplified by these tubes just as the lower frequencies are amplified. The work done by an audio amplifying tube on high frequency currents is of no value, in fact it is harmful since just that much of the tube's total amplifying ability is taken away from the useful task of increasing the audio frequency signals. Therefore, it is highly desirable to get rid of the remainder of the high frequency currents before they can enter the audio amplifier.

The method of separating the high frequency impulses of plate current from the audio frequency changes of average plate current is shown in the diagram. The plate of the detector tube is connected to the plate terminal of an audio frequency transformer, to headphones, to the audio amplifier resistance, or to some other unit. The plate of the detector tube is also connected to a small bypass condenser. The other side of this condenser is connected to the filament terminal of the tube.

DETUNING

The bypass condenser is of small capacity. The reactance of this small condenser is very great to the low frequency or audio frequency impulses, but its reactance or opposition to the flow of the high frequency impulses in the plate current is very low. On the other hand the impedance of the audio amplifying device or the headphone windings is high to the high frequency impulses, but is low and offers little opposition to the passage of the low frequency changes in plate current. Therefore, as shown in the diagram, the low frequency average rises and falls of current go to the amplifier or phones, while the high frequency impulses are bypassed through the small condenser.

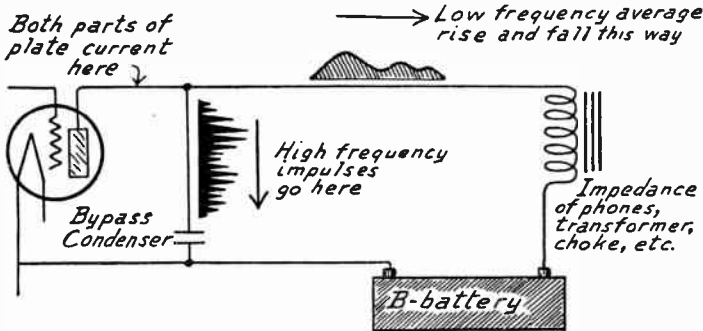

Separation of High and Low Frequencies with Detector Plate Bypass.

The best value for this bypass may be anywhere between .001 and .005 microfarad. Various capacities should be experimented with and when the best signals are received, that value should be adopted. Too large a capacity will bypass the higher notes of audio frequency, while too low a value will force radio frequency currents into the audio amplifying system, lowering the volume, impairing the tone quality and causing high pitched whistles to come through the audio amplifier.

When the receiver employs choke coupled or impedance coupled audio amplification the larger capacities of plate bypass condensers are required, that is, capacities up to .005 microfarad. The same is true of the second detector in a superheterodyne circuit. With transformer coupled audio amplifiers, the lower values, around .002 microfarad capacity, are generally best.

DETUNING.—As the word implies, detuning is the opposite of tuning. Tuning consists of making such adjustments that the resistance of the receiver to currents of a certain frequency is reduced to the lowest possible point, and the receiver with its circuits is then said to be tuned to this frequency.

When a circuit is detuned, either the capacity of a tuning condenser or the inductance of a tuning coil is changed so that the combination of capacity and inductance is no longer resonant or at lowest resistance to the frequency being received. In effect, resistance has been added for this frequency. The volume or loudness of the signal is reduced proportionately to the amount of detuning.

Detuning is often resorted to, to reduce the volume of the reception from nearby stations. Since the selectivity of any receiver depends on having its circuits tuned to the received frequency, detuning destroys the selectivity and other stations having frequencies near the frequency of the one being received will break through. Detuning is not a satisfactory method of volume control.

DIAGRAM, READING OF

DIAGRAM, READING OF.—See *Symbols, Radio and Electrical*.

DIAL, TUNING.—In order that the operator of a receiver may accurately adjust the tuning controls to the best position for reception, graduated and numbered dials are attached to the shafts of the tuning condensers or inductances. The graduations and numbers may be on the edge of the dial as in Fig. 1 at the left. The pointer or indicator then will be mounted on the panel. The dial itself may carry the pointer which is then movable, while the graduations and numbers are stationary on the panel as at the right of Fig. 1.

Dials for use with tuning condensers or inductances which rotate through only a half turn from minimum to maximum are provided with a numbered scale that extends only half way around the circle or through 180 degrees. The travel of the dial over this half circle may be divided into one hundred equal divisions, this being the usual practice, or it may be divided into graduations for the one hundred and eighty degrees of the half circle. Both graduations are shown in Fig. 2.

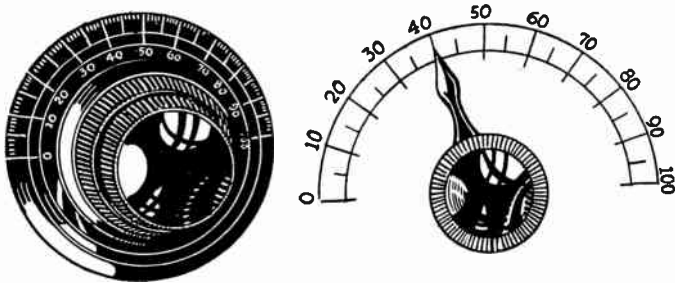

FIG. 1.—Graduations on Tuning Dial and on Panel.

With some types of condensers used for tuning, the shaft of the instrument may make a complete turn between minimum and maximum settings. The dial or pointer must then travel completely around a circle. This circle may be divided into one hundred divisions or sometimes into two hundred divisions. Then again it may be divided according to the degrees of the circle, showing the full three hundred and sixty degrees. Tuning over the full circle rather than over only half of it allows double the amount of separation on the dial between stations.

Some condensers turn toward the right, from left to right, in changing their capacity from minimum to maximum, others rotate to the left. The first are called right hand and the second left hand condensers. The same difference of rotation may be found in tuning inductances. Since it is customary for the numbers on a dial or scale to increase with increase of wavelength or with decrease of frequency of the station being tuned in, the zero point on the dial or scale should always be under the pointer when the condenser's capacity or the coil's inductance is at a minimum. The dial should be attached to the shaft of the tuning condenser so that, with the condenser plates all the way out of mesh, zero on the dial or scale is under the pointer. The highest

DIAL, TUNING

reading of the dial or scale should then be under the pointer when the condenser plates are fully in mesh.

This difference in direction of rotation calls for two styles of dials or scales; those which increase their readings when turned to the right or clockwise and those whose readings increase when turned to the left or anti-clockwise. Dials which turn to the right or clockwise are called right hand dials or clockwise dials; while the ones turning to the left with increase of

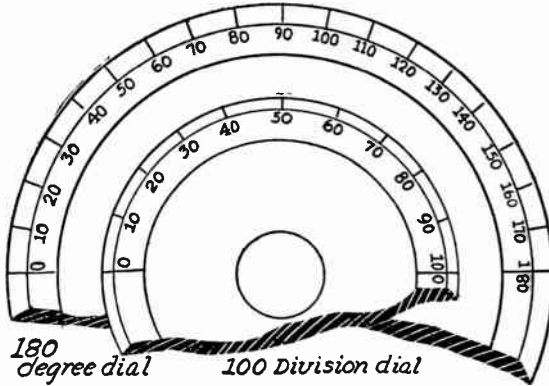

FIG. 2.—Tuning Dial Graduations from Zero to One Hundred and from Zero to One Hundred Eighty Degrees.

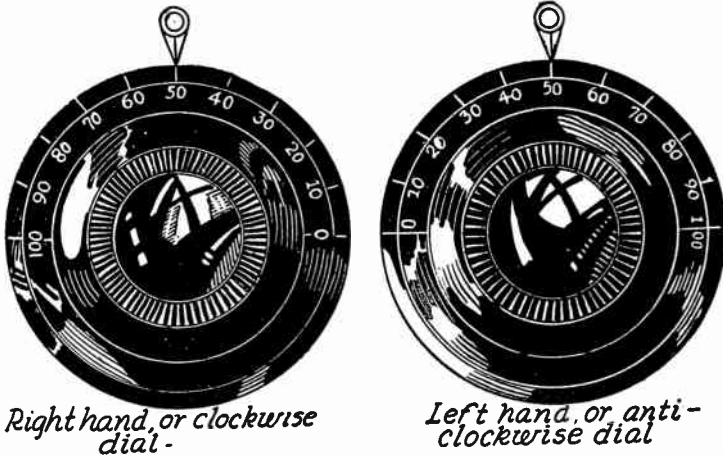

FIG. 3.—Right Hand and Left Hand Tuning Dials.

readings are called left hand dials or anti-clockwise dials. It is important to select the type of dial that will work properly with the tuning condenser or tuning inductance being employed in the receiver. Both rotations are shown in Fig. 3.

The dial may be made entirely of insulating material or only the knob for the operator's hand may be of insulating material with the main part of the dial and its scale made of metal. In any case there

DIAL, TUNING, VERNIER

is a metal sleeve in the dial's center, this sleeve fitting over the exposed end of the tuning unit shaft. After the dial is put in its proper position it is locked to the shaft with a set screw or by tightening the knob which clamps a split bushing down around the shaft. All dials should be built so that the operator's hand is well separated and insulated from the end of the shaft of the tuning unit.

The standard diameter for shafts of tuning condensers or inductances is one-quarter inch and dials have one-quarter inch holes in them. Some of the older instruments may be found to have shafts only three-sixteenths of an inch in diameter. A brass tubular bushing is then used between the inside of the hole in the dial and the outside of the shaft, thus taking up the extra clearance.

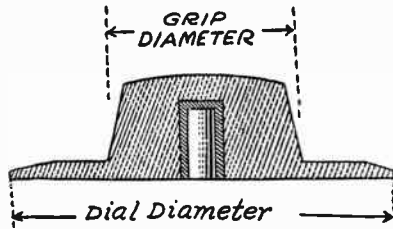

FIG. 4.—Tuning Dial Dimensions.

Dials are generally specified according to their outside diameter as shown in Fig. 4. Standard diameters are three, four and five inches. Three inches is used when space will not allow anything larger. Four-inch dials are the most popular. The larger the diameter of the dial, the easier will be the tuning. The size and diameter of the grip or extended portion of the dial should be as large as possible because a large grip prevents the operator's fingers from becoming tired when much tuning is to be done. A low or only slightly elevated grip of small diameter is always to be avoided.

DIAL, TUNING, VERNIER.—A vernier tuning dial is a dial which contains within itself a reduction gearing or friction device which reduces the motion of the knob under the operator's hand so that this knob must be given a number of turns in order to rotate the shaft of the tuning unit through one-half turn or a full turn as required.

Some vernier dials provide a reduction of as little as five or six to one, while others have been built with reductions as great as one hundred fifty to one. When a dial has but a low reduction, say from five to one up to around twelve to one, the vernier action is used for all tuning. But with very great reductions of motion it would take too long to get over the entire dial and provision is made whereby the dial may be used either as a plain non-reducing type (one-to-one ratio) or the vernier action may be employed at will. Rough or approximate tuning is then done without the vernier action in use and, after a station is once heard, the final setting is made accurately with the help of the vernier.

DIAMOND WEAVE COIL

There are literally dozens of different makes and types of vernier dials. Some use toothed gears in pairs or in trains. Others use the friction between the edge of a large disc and a groove cut into the circumference of a small disc attached to the operator's knob. There is no particular object in going into all these designs since the problem is a purely mechanical one. A ratio of as low as five to one will allow easy and accurate tuning, although ratios of ten to one and twelve to one may prove somewhat easier to operate for the novice in tuning.

Some verniers grip the shaft through a friction collar. This allows the main tuning dial to be rotated rapidly to an approximate setting after which the vernier moves the shaft to an exact setting.

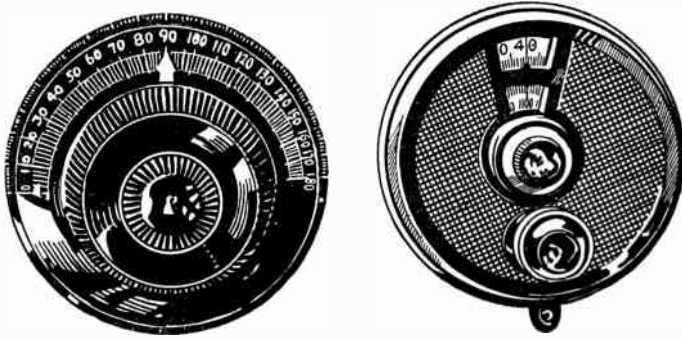

Two Types of Vernier Tuning Dials.

Back lash or lost motion may be very harmful or may do but little harm. If the back lash allows free back and forth movement of the shaft of the instrument being operated it is harmful and should not be tolerated. If, however, there is back lash or movement only in the hand dial or knob, while the shaft of the instrument remains stationary, the back lash will not be so harmful. The dial scale or other indicating device must be attached to the shaft of the instrument and not to the dial or knob when there is back lash in the dial or knob.

The back lash or play between gear teeth or in brackets or pivots is often taken up by springs. These springs hold the gear teeth always together on one side or hold a pivot always against one side of its bushing or bearing. This prevents any lost motion from affecting the tuning. Two common forms of vernier dial are shown.

See also *Condenser, Verniers for.*

DIAMOND WEAVE COIL.—See *Coil, Spiderweb.*

DIAPHRAGM.—See *Speaker, Loud.*

DIELECTRIC.—Any material through which electric force may act is a dielectric. All dielectrics are insulators, not conductors. A dielectric substance will allow the passage through it of induction, of magnetic lines of force, and of electrostatic lines of force.

Just as iron placed in a magnetic field will allow easier passage of the magnetic lines of force through itself, so will a dielectric placed in an electrostatic field allow easier passage of the electrostatic lines of force through itself. A dielectric placed in the electrostatic field of a condenser, between the plates of the condenser, will cause the field to become stronger and the condenser plates to become more

DIELECTRIC ABSORPTION

highly charged with the same impressed voltage than when air only is between the plates.

The power of the dielectric to thus increase the capacity of a condenser in which it is used is called the specific inductive capacity or the dielectric constant of the material. See *Constant, Dielectric*, under which heading are given the dielectric constants for most of the substances used in radio work.

The dielectric constant of a dielectric material is a measure of its ability to increase the capacity of a condenser. A substance may be a very good dielectric from the standpoint of increasing capacity, yet may be poor from the standpoint of radio work because of the losses it may introduce. The measure of a dielectric's value for radio work is its phase angle difference, that is, the amount it displaces the waves or oscillations passing through it.

The various properties and characteristics of the different dielectrics are discussed under the headings of the dielectric's name. Following are the most important which may be referred to:

<i>Air</i>	<i>Fibre</i>	<i>Porcelain</i>
<i>Celluloid</i>	<i>Glass</i>	<i>Quartz</i>
<i>Cloth, Insulating</i>	<i>Mica</i>	<i>Waxes</i>
<i>Binders</i>	<i>Oils, Insulating</i>	<i>Woods</i>
<i>Rubber</i>	<i>Paper</i>	<i>Insulation, Moulded</i>

All of these things are insulators as well as dielectrics. When they are considered from the standpoint of insulation, it is their resistance to voltage that is important. When they are considered from the standpoint of their dielectric properties, such as dielectric constant and phase angle, it is their effect on the electric force or electrostatic fields in radio that is of importance. Some materials are powerful dielectrics, others are strong insulators, and many fulfill both requirements at the same time.

Many parts of a radio receiver should be thought of from the standpoint of their dielectric properties. This applies to the insulation of wires and cables, which takes in cotton, silk, enamel and rubber. It also applies to all the insulating supports used in building condensers and coils, and to the sheets of insulation used for panels, sub-panels and cabinets; taking in such things as bakelite, hard rubber, fibre, glass, porcelain and woods. Then come the oils, waxes and binders used as insulators, and finally the mica and paper used because of their dielectric properties in condensers.

DIELECTRIC ABSORPTION.—See *Absorption, Dielectric*; also *Condenser, Losses In*.

DIELECTRIC CONSTANT.—See *Constant, Dielectric*.

DIELECTRIC CURRENT.—See *Current, Dielectric*.

DIELECTRIC HYSTERESIS.—See *Hysteresis*.

DIELECTRIC RESISTANCE.—See *Resistance, Dielectric*.

DIELECTRIC STRAIN.—See *Strain*.

DIELECTRIC STRENGTH.—See *Strength, Dielectric*.

DIELECTRIC STRESS.—See *Stress*.

DIFFRACTION.—An action by which waves of different frequencies are deflected or bent out of their original paths by differing amounts depending on their frequency. Long waves or low frequencies are diffracted or bent more easily than short waves. The long waves will pass around and almost completely envelope a small obstacle in their path while with short waves the obstacle will produce a comparatively "sharp shadow" because the waves pass on in almost straight lines.

DIODE

DIODE.—A vacuum tube having only two elements, one a filament and the other a plate. See *Tube, Rectifier Types of*.

DIRECT COUPLING.—See *Coupling, Conductive*.

DIRECT CURRENT.—See *Current, Direct or Continuous*.

DIRECT CURRENT CHARGER.—See *Charger, Battery, Direct Current Type*.

DIRECT CURRENT POWER UNIT.—See *Power Unit, D. C. Supply Type*.

DIRECTION FINDER.—See *Compass, Radio*.

DIRECTIONAL ANTENNA.—See *Antenna, Directional Effect*.

DIRECTIONAL LOOP.—See *Loop, Directional Effect of*.

DISPLACEMENT CURRENT.—See *Current, Displacement*.

DISTANCE, RECEPTION FROM.—See *Range, Receiver*.

DISTANCE, GEOGRAPHICAL.—The following list shows the approximate air line distances between principal cities in the United States, Canada and Mexico.

	Boston	Buffalo	Chicago	Cincinnati	Cleveland	Detroit	New York	Philadelphia	Pittsburgh	St. Louis	Washington
Ames, Iowa	1140	750	300	500	610	540	1000	965	720	285	900
Atlanta, Ga.	925	700	590	375	550	600	740	660	525	470	535
Atlantic City, N. J.	270	335	700	530	405	490	95	55	295	880	140
Baltimore, Md.	350	180	600	420	310	405	170	90	195	730	35
Beaumont, Texas	1510	1200	875	825	1035	1030	1325	1250	1050	645	1125
Birmingham, Ala.	1050	805	575	420	620	640	850	775	610	400	630
Boston, Mass.	—	400	835	725	540	600	190	265	475	1025	385
Bristow, Okla.	1400	1035	615	680	865	830	1235	1175	930	310	1065
Buffalo, N. Y.	400	—	450	390	175	215	295	285	180	650	295
Calgary, Canada	2080	1725	1380	1630	1650	1550	2000	1190	1750	1440	1950
Chicago, Ill.	835	450	—	250	300	235	705	655	415	255	590
Cincinnati, Ohio	725	390	250	—	220	225	555	495	255	315	400
Cleveland, Ohio	540	175	300	220	—	90	400	355	115	485	300
Columbus, Ohio	625	295	275	100	125	160	470	410	160	390	325
Dallas, Texas	1520	1180	795	800	1005	990	1350	1280	1060	545	1165
Davenport, Iowa	990	600	155	360	455	390	860	805	560	200	735
Denver, Colo.	1750	1350	900	1075	1205	1140	1600	1550	1300	775	1475
Des Moines, Iowa	1150	750	300	500	605	540	1010	965	705	260	890
Detroit, Mich.	600	215	235	225	90	—	475	440	210	450	395
Elgin, Ill.	870	480	30	275	330	265	735	685	445	255	620
Fort Worth, Texas	1550	1205	810	820	1025	1005	1375	1310	1085	560	1190
Galveston, Texas	1580	1270	945	890	1100	1100	1385	1315	1125	690	1200
Hartford, Conn.	90	325	750	630	460	525	150	175	375	960	300
Hastings, Neb.	1405	1005	560	735	860	795	1265	1210	960	445	1120
Havana, Cuba	1495	1390	1320	1100	1250	1320	1295	1270	1215	1165	1125
Hot Springs, Ark.	1280	945	575	550	765	745	1105	1030	820	340	925
Houston, Texas	1570	1260	925	890	1090	1085	1400	1315	1125	665	1200

DISTANCE, GEOGRAPHICAL

	Boston	Buffalo	Chicago	Cincinnati	Cleveland	Detroit	New York	Philadelphia	Pittsburgh	St. Louis	Washington
Indianapolis, Ind.....	790	425	160	100	255	235	630	575	325	235	480
Iowa City, Iowa.....	1045	650	200	405	510	435	910	855	605	210	785
Jefferson City, Mo.....	1130	750	325	420	585	540	975	910	665	110	810
Kansas City, Mo.....	1230	850	400	540	690	640	1075	1025	775	225	925
Lancaster, Pa.....	305	255	600	430	300	390	125	65	200	750	90
Lansing, Mich.....	675	275	170	235	170	80	550	520	285	400	470
Lincoln, Neb.....	1315	920	470	645	775	700	1175	1125	875	360	1145
Los Angeles, Cal.....	2550	2160	1725	1875	2015	1950	2425	2360	2115	1570	2255
Louisville, Ky.....	815	475	270	90	305	310	650	570	345	250	465
Madison, Wis.....	925	525	120	375	400	325	800	750	520	300	700
Memphis, Tenn.....	1125	800	475	410	625	615	950	875	650	240	750
Mexico City, Mexico.....	2300	2000	1680	1600	1800	1795	2125	2035	1860	1425	1850
Miami, Fla.....	1275	1185	1175	950	1080	1150	1100	1025	1015	1075	925
Milwaukee, Wis.....	840	450	80	325	335	250	725	685	450	320	625
Minneapolis, Minn.....	1110	725	355	600	625	540	1010	975	740	460	925
Montreal, Canada.....	260	320	740	700	490	515	340	400	475	975	490
Newark, N. J.....	195	285	700	550	390	470	8	75	300	875	195
New Orleans, La.....	1335	1075	825	700	915	930	1160	1075	910	605	950
New York City.....	190	295	705	555	400	475	—	80	305	870	200
Oakland, Cal.....	2650	2260	1825	2005	2125	2050	2525	2475	2230	1710	2400
Omaha, Neb.....	1260	875	425	625	735	660	1135	1080	835	350	1010
Ottawa, Canada.....	310	240	645	635	410	430	340	385	410	880	460
Philadelphia, Pa.....	265	285	655	495	355	440	80	—	250	800	120
Pittsburgh, Pa.....	475	180	415	255	115	210	305	250	—	560	190
Pontiac, Mich.....	615	230	225	240	110	20	490	450	225	450	410
Portland, Ore.....	2500	2120	1725	1960	2030	1935	2420	2375	2150	1745	2320
Providence, R. I.....	45	390	825	710	525	585	150	235	450	1000	355
Regina, Canada.....	1680	1325	1000	1250	1260	1160	1620	1600	1375	1095	1550
Rochester, N. Y.....	340	65	510	445	235	275	250	260	225	725	300
St. Louis, Mo.....	1025	650	255	315	485	450	870	800	560	—	705
Salt Lake City, Utah.....	2075	1675	1250	1440	1550	1475	1950	1900	1650	1150	1825
San Antonio, Texas.....	1735	1410	1035	1025	1235	1225	1565	1475	1275	765	1360
San Francisco, Cal.....	2640	2250	1815	1995	2115	2040	2515	2465	2220	1715	2390
Schenectady, N. Y.....	145	250	700	600	400	460	150	210	350	900	315
Scranton, Pa.....	245	230	615	490	315	390	100	105	230	790	200
Seattle, Wash.....	2460	2095	1710	1950	2000	1920	2385	2360	2115	1700	2300
Springfield, Mass.....	80	320	755	650	460	525	120	200	400	960	320
Tampa, Fla.....	1180	1050	1000	775	925	985	1000	925	865	860	815
Toronto, Canada.....	430	55	425	400	185	200	345	340	225	640	350
Troy, N. Y.....	135	265	710	605	415	475	140	205	360	910	325
Vancouver, Canada.....	2480	2115	1750	1990	2035	1945	2400	2375	2150	1745	2325
Waco, Texas.....	1585	1250	870	860	1075	1050	1400	1335	1125	615	1225
Washington, D. C.....	385	295	590	400	300	395	200	120	190	705	—
Winnipeg, Canada.....	1350	990	710	965	940	850	1285	1260	1050	850	1245
Zion, Ill.....	840	450	40	285	300	235	710	660	420	265	595

DISTORTION

DISTORTION.—Before it is possible to consider the causes of distortion and their remedies, distortion itself must be defined. It is to be presumed that the sounds originating in the broadcasting studio, whether they be speech or music, are good to listen to. Granting this, it is also necessary to grant that these sounds from the studio are amplified and sent out over the air as a true picture of themselves. Finally the waves must reach the receiver antenna just as sent from the transmitter. It is then up to the receiving equipment to reproduce these sounds from the loud speaker or headphones in exactly the same form that they originated. Any change between the studio and the loud speaker means distortion.

Many radio listeners are unable to recognize distorted signals upon listening to them because of having listened to so many receivers which do nothing much more than distort. The true test of distortion would be to have the receiver in a room adjoining the broadcasting studio and with a soundproof wall between them. It would then be possible to listen to the receiver and to then suddenly open the door, noting the difference between the original and the reproduction.

It may now be asked, what happens when a signal is distorted? Of course there are many kinds of distortion but the following are among the most common:

The higher notes or tones are weakened and the sound of consonants in speech is suppressed.

The signals are weak and thin on the lower notes but have good volume on the high notes.

There is a drum-like or muffled sound in all reception.

Certain notes or tones, generally those which are naturally high or shrill, are much louder than any other notes or tones.

All signals have a harsh sound.

All signals are mushy and blurred, having a ragged characteristic.

Some faults will produce but one of the foregoing types of distortion while other faults will produce several types at once.

There are at least eight different places in which causes of distortion may be found. Each of these places will be considered.

First of all the broadcasting station may be sending out distorted signals. It may as well be understood that such an occurrence is almost unheard of. However, if all stations with the one exception allow the receiver to give forth pure, clear, undistorted tones it may be assumed that the one offending station is at fault.

Looking at the receiving equipment, distortion may be due to the radio frequency amplifier, to the detector, to the audio frequency amplifier, to the wiring, to the batteries or power supply, or to the loud speaker.

Distortion in Radio Frequency Amplifier or Tuner.—Now to consider the radio frequency amplifier or the tuning circuit should the receiving equipment start with a detector. From the discussion given under the heading *Band, Wave*, it will be seen that a certain range of frequencies is required for the reproduction of natural sounds. With present broadcasting practice each station is allowed

DISTORTION

a frequency band or wave band 10,000 cycles wide. This allows the addition of frequencies of from zero to 5000 cycles both above and below the carrier frequency.

If the radio frequency circuits or the tuning circuits are tuned too sharply the necessary side bands are cut off from the signal because the peak of resonance is made so sharp that, in place of extending nearly to 5000 cycles, the band of frequencies actually amplified may be only 1000 or 2000 cycles wide. The high notes are not amplified. The remedy is to reduce the sharpness of tuning, generally by increasing the coupling.

A regenerative receiver or any tuned radio frequency receiver having an adjustable control for oscillation may be operated too close to the point of oscillation, that is, regeneration may be pushed too far. Of course this will bring in the distant stations very well but will cause distortion. Regeneration pushed so far that it becomes oscillation causes the production of a local oscillating current which combines with the incoming signal to produce beats or heterodynes. This allows only the carrier wave frequency to come through properly and badly distorts the side bands and high notes because on these side bands the locally generated oscillation does not exactly match the oscillation of the signal and the two try to destroy each other. The remedy is to avoid using so much regeneration.

Distortion in Detector Circuit.—The detector may next be considered. When strong signals from nearby broadcasters are being received it is very easy to overload the detector tube. By overloading is meant that the voltages furnished to the grid of the detector tube are so great that they cannot be handled without forcing the grid voltage either too far negative or too far positive. The remedy is to either detune or to provide some form of volume control which affects the radio frequency amplifier before the signals are passed on to the detector.

Still considering the detector, it is next in order to examine the resistance of the grid leak. A leak of too high resistance will cause the detector tube to block when powerful signals are being received. By blocking is meant an excessive accumulation of negative charges on the grid of the detector tube, this accumulation weakening the effect of an incoming signal and almost completely overcoming the effect of the signal amplitudes. The use of a grid leak with lower resistance will avoid this trouble because the negative charges are allowed to leak off or escape from the grid so that the next wave or impulse of the signal may do its proper work. Grid leaks of more than two megohms resistance are generally too large for strong signals. For local and nearby reception a grid leak of one megohm resistance is very satisfactory although resistance up to five megohms may be used for distance work. This is an argument for the use of a variable grid leak.

The next examination of the detector circuit is for the purpose of discovering the escape of radio frequency current into the audio amplifying circuits. This trouble results in two serious difficulties. First, the tone quality is damaged, and second, volume is decidedly reduced. The audio tubes are able to do just about so much ampli-

DISTORTION

ying. All of their power of amplification should be used to increase the strength of the audio frequency signals. But, when radio frequency currents get through into these tubes part of their amplifying power is wasted in building up the radio frequency. All of the effort expended by the tube on the radio frequency currents must be subtracted from its total ability with a consequent reduction of signals we wish to hear.

Practically all receivers have a bypass condenser of small capacity (.001 to .005 microfarad) connected between the plate terminal of the detector tube and one of the filament terminals of the tube as in Fig. 1. The purpose of this condenser is to bypass all radio frequencies from the plate of the detector, allowing only the lower audio frequencies to pass on to the first audio transformer or other coupling device. It may be possible that there is sufficient distributed capacity in the windings of the audio transformer to allow radio frequency currents to flow in the transformer. This distributed capacity is illustrated by the broken lines in Fig. 1. A similar escape of radio frequency currents into the audio amplifier may be allowed by wiring which is improperly placed so that detector plate leads have considerable capacity to other wires.

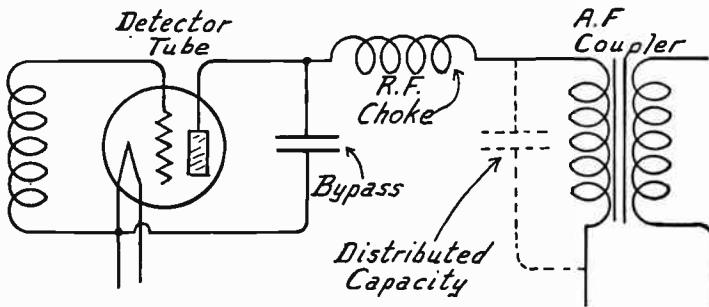

FIG. 1.—Detector Circuit with Bypass and Radio Frequency Choke to Prevent Distortion.

To prevent radio frequency currents from leaving the detector tube circuit it is advisable to insert a radio frequency choke coil at the position shown in Fig. 1, between the plate terminal of the audio transformer or other coupling device and the junction of the bypass condenser lead with the plate terminal of the detector tube. The reactance of this choke coil is great enough to prevent the passage of radio frequency currents through it, yet is not so high as to interfere with audio frequency currents.

Distortion in Audio Frequency Amplifying Tubes.—In the audio frequency amplifier, distortion may occur because of wrong conditions in the tubes, because of wrong conditions in the audio transformers or other coupling devices, or because of faults in the wiring.

Examination of the characteristic curve of a vacuum tube used as an amplifier will show that the straight portion of the curve is quite long, extending from some negative value of grid voltage up to zero grid voltage and quite a distance above zero on the positive side as in Fig. 2.

DISTORTION

It is not possible to use the straight part of the curve on the positive side of zero without distortion. The reason is as follows:

When the grid voltage becomes positive the grid really acts in the same way that the plate acts. Under this condition the grid as well as the plate has a positive voltage. Electrons from the filament are attracted to any positively charged body and the electrons do not care whether that positively charged body is the grid or the plate.

When the grid voltage is negative the grid itself is negative and no electrons will flow from the filament to a negatively charged body.

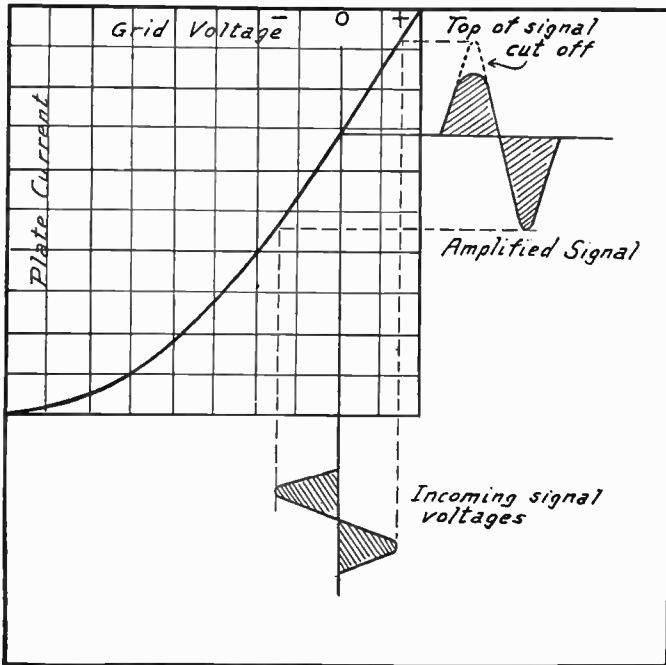

FIG. 2.—Distortion Caused by Zero Grid Bias.

Therefore, with signal impulses of negative voltage all of the electrons which permanently leave the filament pass to the plate. The plate current, which is composed of these electrons, reaches a value determined by this negative grid voltage. That is to say, the minimum current flowing in the plate circuit corresponds to the maximum negative voltage on the grid.

But, when positive signal impulses come along, making the grid positive, all of the electrons which permanently leave the filament do not flow to the plate because a part of them are attracted to the positive grid. Therefore, the current change in the plate circuit at the time of these positive impulses, which should be equal ex-

DISTORTION

actly to the change with negative impulses, is not equal because of the electrons which are subtracted from the plate circuit as they flow to the grid. For this reason the change of plate current with positive impulses will not be as great as the change with equal negative impulses and one-half the wave is amplified more than the other. This means distortion.

In Fig. 2 it will be seen that the incoming signal is of symmetrical or undistorted form on both sides of its zero line. Here the grid of the amplifier tube is assumed to have zero grid bias, something no audio amplifier tube should have. The positive signal impulses use that part of the curve on the right of the zero line, while the negative impulses use that part of the curve

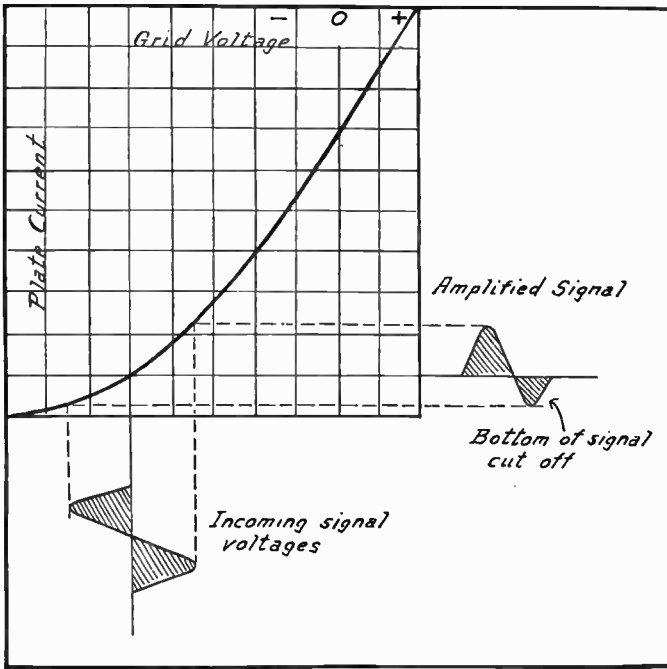

FIG. 3.—Distortion Caused by Excessive Negative Grid Bias.

to the left of zero, that is, on the negative side. Whenever the positive side of the curve is used current flows in the grid circuit and is subtracted from that which should flow in the plate circuit. Therefore, the tops of the amplified signals are cut off as shown and distortion takes place because of a change in the form of the signal.

Whatever current is thus caused to flow in the grid circuit must flow through the secondary winding of a transformer preceding the amplifier tube. The grid current might be great enough to saturate the transformer core, which would reduce the amplification and cause still greater distortion.

The condition just outlined and shown in Fig. 2 may be corrected by using a greater negative bias on the grid of the amplifier tube. This negative bias would generally be provided by using more cells of a C-battery. See *Bias, Grid*.

DISTORTION

The opposite condition from the one just considered is shown in Fig. 3. Here the grid of the amplifier tube has been given too great a negative bias. Now the operating point is so far down on the curve that the negative impulses of the incoming signals cause the plate current to drop almost to zero while the positive impulses are amplified in the usual way. Again it will be seen that the incoming signal is undistorted, being equal on both sides of its zero line. But the amplified signal is badly distorted because the decrease of plate current is only a fraction of the increase of plate current. The original form of the signal is greatly changed and distorted.

The remedy for this condition is to use less negative grid bias or less C-battery. Should the use of less negative bias cause the signal to use part of the positive side of the curve, as in Fig. 2, it is then necessary to increase the plate voltage or B-battery voltage which will have the effect of raising the curve, pushing it farther to the left and increasing the length of the straight portion.

Operation of the amplifier tubes with low plate voltage will generally cause the operating point to come on or near a bend in the curve. Operation on any part of the curve except a straight portion will result in distortion similar to that shown in Fig. 3. Once

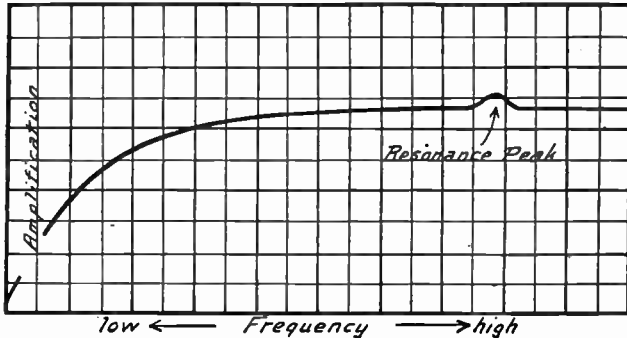

FIG. 4.—Resonance Peak Causing Distortion in Audio Frequency Coupler.

in a while an amplifier tube may not have a suitable curve for its use, that is, it may have no straight portion of its characteristic curve. Such a tube will be a poor amplifier but a good detector.

It is impossible to receive undistorted signals of great volume unless high voltage is applied to the plate of the tube and a correspondingly high negative biasing voltage applied to the grid. Proper plate and grid voltages are shown under *Tube, Amplifying Types of*.

The best results will always be obtained by using the highest plate voltage the tube will stand and by using the value of C-battery or grid biasing voltage recommended for this plate voltage. Volume and good quality together can be had in no other way.

Distortion in Audio Frequency Transformers or Chokes.—Distortion in audio frequency transformers may be due to three principal reasons. First; the core may be too small, of a poor grade of iron or with too heavy laminations. Second; the primary wind-

DISTORTION

ing may be so small that it has insufficient reactance. Third; the secondary winding may have too much distributed capacity.

A transformer built with a small core or a core of poor iron will lose both the high and low notes and will amplify unequally many of the intermediate tones.

A transformer having a small primary winding offers such low reactance to the lower audio frequency impulses, which represent the low notes, that these impulses pass on through the winding without producing the proper effect in the secondary. Consequently the low notes are lost. Transformers of high ratio generally have primary windings which are too small for their work unless the transformer is of large size.

A transformer with a large secondary winding, such as is generally found in high ratio instruments, will often have a rather large distributed capacity in the secondary winding. This is due to the large number of turns with small spacing between the wires. This distributed capacity acts as a bypass for high frequencies and causes such a transformer to lose the high notes.

This high distributed capacity in the secondary winding may combine with the inductance of the same winding to produce resonance at some frequency within the audible range. At this resonant frequency, which will be among the high notes of the musical scale, the resistance of the secondary circuit is greatly reduced and notes of this frequency will be amplified to a much greater extent than those of other frequencies. Thus the transformer or other coupling device depending on reactance will have a resonant peak as shown in Fig. 4.

The causes for these peculiar actions in transformers and impedances are discussed at greater length under the heading *Transformer, Audio Frequency*.

A drum-like or muffled sound especially noticeable in speech and the lack of consonant sounds in speech are generally due to poor amplification of high frequencies. Such poor amplification may be caused by excessive distributed capacity in the secondary of the audio transformer.

Placing a high resistance of 100,000 to 500,000 ohms in series with the grid return from the secondary of the audio transformer as in Fig. 5 tends to flatten its amplification curve and to give more uniform amplification over the entire range of frequencies. The amount of amplification is however reduced considerably by this method.

Distortion may be caused by operating the filaments of the tubes at too low temperature. When the plate voltage is exerting its full pulling power on the electrons emitted from the hot filament there must be a plentiful supply of electrons to make up the required plate current. If the filaments are operated at low voltage and consequent low temperature there will be enough emission for the high notes and for all comparatively weak signals. But when greater power is demanded for the amplification of low notes or for handling strong signals of any kind this power may be lacking.

With a limited filament emission the plate current can rise to a point represented by this emission, but can rise no higher under any conditions. The weaker notes will be fully reproduced but the stronger ones will fail to come through. Volume should not be controlled by reducing filament voltage and temperature.

Distortion Caused by Wiring and Batteries.—Discharged or weak B-batteries or C-batteries are bound to cause great distortion. A weak B-battery delivers a plate voltage lower than normal and brings the curve to such a point that operation is bound to be

DISTORTION

upon the bend which results in distortion similar to that shown in Fig. 3. Weak C-batteries reduce the amount of negative grid bias below that needed so that operation is on the positive part of the curve and distortion is caused similar to that shown in Fig. 2.

If the wiring in any part of the receiver is laid out in such a way that grid leads and plate leads run near to and parallel with each other there will be feedbacks of energy from one amplifying stage to the preceding stage. This, of course, may be avoided by proper wiring layout. Care should also be exercised to see that all battery leads are run close to each other or are cabled so that inductive loops are avoided.

To discover whether high frequency oscillations are taking place in an audio amplifier connect a fixed condenser of .002 microfarad capacity or less between the grid terminal and negative filament terminal of each of the audio tubes one after the other. The connection is shown in Fig. 6. With this condenser connected to some one of the audio tubes the volume may increase. The greatest effect will probably be found on the last audio tube.

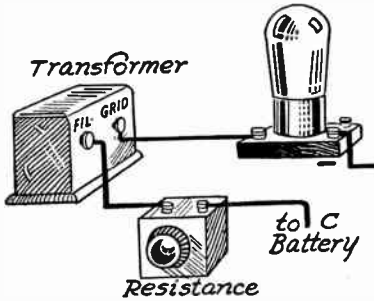

FIG. 5.—Resistance for Securing Uniform Amplification and Reducing Distortion.

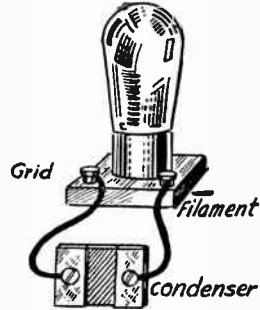

FIG. 6.—Distortion Reduction with Bypass Condenser for High Frequencies.

The condenser should be permanently connected to the grid and filament of the tube where it does the most good.

A condenser used in this way to bypass high frequency and keep it out of the tube may reduce the amplification of some of the higher musical notes and harmonics. A condenser larger than .002 microfarad should not be used and after the point of trouble is located it would be better to try condensers of .001, then .0005 and finally .00025 microfarad capacity. Use the smallest value that will allow full volume.

The omission of proper bypass condensers in the grid return circuits and more especially in the plate circuits will cause resistance feedbacks and oscillation in an audio amplifier. See *Condenser, Bypass*. Such oscillation may sometimes evidence itself by very weak and high pitched whistling or squealing heard by listening carefully at the loud speaker. These noises will be prevented by use of proper bypass condensers or by rearranging the wiring to prevent the feedbacks which are causing the trouble.

Distortion in Loud Speakers.—Distortion may be caused in any speaker having an adjustable diaphragm by setting this ad-

DISTORTION

justment at a point too critical in an effort to make the speaker more sensitive to weak signals. Noises and distortion may also be caused if any of the internal parts of the speaker have become loose, this applying especially to the diaphragm and its adjustment.

Any loud speaker may be overloaded by attaching it to a receiver which delivers more power from the last amplifying tube than can be handled by the speaker in question. Small speakers will handle only small amounts of power and can be expected to deliver only reasonable volume without distortion.

It is also possible to overload a loud speaker by allowing direct current from the B-battery or a power supply to flow through its windings. This direct current, especially when at high voltage used with power tubes, should be bypassed around the speaker. This is described under the heading *Speaker, Loud, Connections to Receiver*.

Considerable distortion may apparently be had from a loud speaker placed too close to walls or other flat surfaces which echo the sound. A loud speaker placed near heavy draperies will sound the best.

With horn types of speakers it may be found that the smaller sizes are in themselves resonant to certain tones just as one of the strings of a violin is resonant to its tone or note. These tones to which the horn is naturally resonant will be amplified far above all others. It may often be found that a small, light horn will vibrate noticeably at certain tones when the tips of the fingers are held upon it. These objections seldom apply to cone type speakers.

Some of the larger and more powerful speakers, especially those of the cone type, will rattle badly when operated from an ordinary amplifying tube in the last audio stage of the receiver. Ordinary quarter-ampere amplifying tubes will deliver maximum power amounting to only fifteen thousandths of a watt with ninety volts on its plate. This amount of power will not operate a large speaker and it is useless to try the experiment. A dry cell type of tube of the smaller type delivers only seven thousandths of a watt in power, yet many have tried to use them with large speakers. A power type of speaker can be successfully operated only with a power tube.

Frequency Distortion.—When the receiver, or any part of it, fails to uniformly amplify voltages at various frequencies the result is called frequency distortion. For example, take any portion of a receiver in which the voltage is to be stepped up and assume that an audio signal of 200-cycle frequency at two volts is fed to the input side. If it is found that the output for this frequency reaches four volts the amplification has been two, or there is a two to one step-up. Then if a two-volt signal at 1000 cycles is fed to the same amplifier and it is found that the result is an eight-volt output, the step-up ratio is here four to one. The various frequencies are not equally stepped up in voltage and there is frequency distortion. The voltage response of an amplifier producing frequency distortion is shown in Fig. 7. The amplification at lowest frequencies is about three, between 100 cycles and 1000 cycles the amplification is about six, then there is a peak amplification of a little more than eight and finally a drop to three. These are the

DISTORTION

values to which a given input voltage is amplified. The amplified voltage depends, of course, on the input voltage. An ideal frequency amplification, without any frequency distortion, would be a straight line.

Frequency distortion may be due to incorrect or insufficient impedances in the coupling devices between tubes which will reduce the low frequencies. It may be due to too much grid circuit capacity in these devices which will result in reduction of high frequencies. It may be due to excessive regenera-

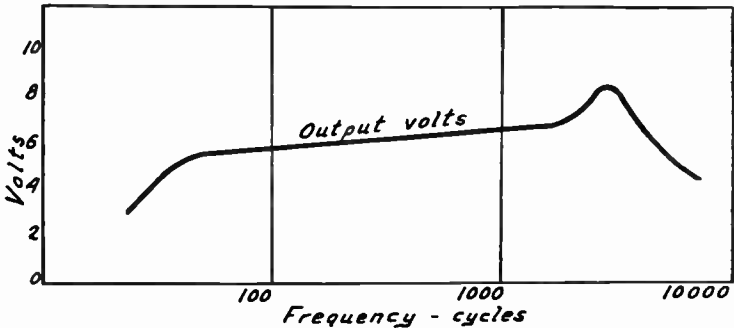

FIG. 7.—Result of Frequency Distortion in Amplifier.

tion or to radio frequency circuits which tune too sharply, both of these faults causing a reduction of high frequencies. Frequency distortion may be due to resonant peaks in audio coupling devices or to resonant peaks in the speaker, both of which cause amplification to be too great on certain frequencies where resonance takes place.

Amplitude Distortion.—The amplitude of a signal is its voltage at some particular instant. If some voltages are amplified more or less than other voltages the result is called amplitude dis-

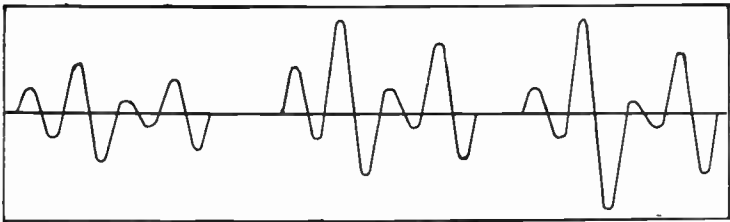

FIG. 8.—Result of Amplitude Distortion.

tortion or wave form distortion because the form or shape of the sound wave is changed. Equal changes in amplitude above and below a zero voltage line might be represented as at the left in Fig. 8. The increases of voltage might be amplified more than the decreases with a result like that in the center of Fig. 8. Here there is amplitude distortion or wave form change. Again, the amplifier might be incapable of handling low voltages or amplitudes effectively

DISTRIBUTED CAPACITY

with the result shown at the right hand side of Fig. 8. Here the higher changes are well amplified, but the low voltages are not correspondingly amplified resulting in reproduction which is not truthful. Still another amplifier might amplify the drops in voltage more effectively than the rises with a result just the reverse of that shown in the center of Fig. 8. Any of these conditions, or similar ones, constitute amplitude distortion.

The relations between voltages and amplification ratio for a unit having amplitude distortion are shown in the curves of Fig. 9. Voltage drops or

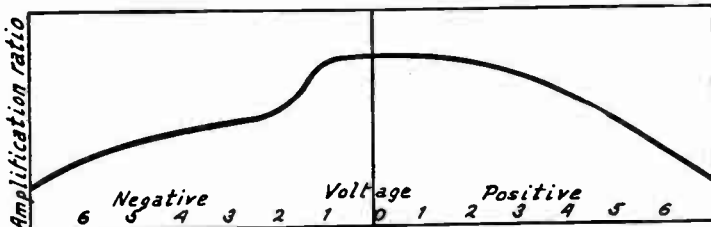

FIG. 9. Variation of Amplification with Changes of Input Voltage.

negative voltages receive less amplification than voltage rises or positive voltages. Also, high voltages, either positive or negative, are poorly amplified.

Amplitude distortion is most commonly caused by overloaded tubes or by tubes with incorrect relations between plate voltage and grid bias as shown in Figs. 2 and 3. This kind of distortion is also caused by old tubes or by insufficient filament emission from any cause. Wave form distortion may be due to transformers or chokes in which the cores saturate at times due to excessive direct current for the plate circuit or to the flow of current in the grid circuit when the grid voltage becomes positive. The greater the permeability of the core iron, the greater the danger of saturation with a given amount of current. Wave form distortion often results in the production of tones or harmonics which were not present in the received signal.

Apparent Distortion.—Apparent distortion may also be caused by various kinds of noises, by howling, by interference and by oscillation, all of which may be referred to under their respective headings. See also *Trouble, Receiver and Power Unit*.

DISTRIBUTED CAPACITY.—See *Capacity, Distributed*.

DIVIDER.—See *Tools*.

DOUBLE BUTTON MICROPHONE.—See *Microphone*.

DOUBLE-CIRCUIT JACK.—See *Jacks and Jack Switches, Types of*.

DOUBLE-CIRCUIT RECEIVER.—See *Receiver, Two-Circuit*.

DOUBLE IMPEDANCE AMPLIFIER.—See *Amplifier, Audio Frequency, Impedance, Double Type*.

DOUGHNUT COIL.—See *Coil, Closed Field, Toroid*.

DOVETAIL CONDENSER.—See *Condenser, Variable*.

DOWN LEAD.—See *Antenna, Lead-in for*.

DRILL.—See *Tools*.

DRILLING

DRILLING.—In the construction and assembly of radio receivers it becomes necessary to drill holes in various kinds of metals and of insulating materials. The following paragraphs give information needed in doing this work:

Machine Screw Tap and Clearance Holes.—Different sizes of machine screws are used in radio work. The following table shows the number of the screws, the number of threads per inch, their diameter, and the drills to be used in making holes either for threading (tapping) or for allowing the screw to pass through freely (clearance). Further information on such screws is given under Screws and Bolts, Types of.

SIZES OF TAP AND CLEARANCE DRILLS

Screw Number	Threads per Inch	Drill Number		Screw Number	Threads per Inch	Drill Number	
		<i>For Tap</i>	<i>Clearance</i>			<i>For Tap</i>	<i>Clearance</i>
2	48	No. 50	No. 42	7	28	No. 32	No. 21
2	56	49	42	7	30	31	21
2	64	48	42	7	32	30	21
3	40	47	38	8	24, 30	30	17
3	48	45	38	8	32	29	17
3	56	44	38	9	24	29	13
4	32	43	31	9	28	28	13
4	36	42	31	9	30	27	13
4	40	41	31	9	32	25	13
5	30, 32	40	29	10	24	25	8
5	36	38	29	10	30	22	8
5	40	37	29	10	32	21	8
6	30, 32	35	26	12	20	19	1
6	36	33	26	12	22, 24	17	1
6	40	32	26	12	28	15	1

Drilling Metals.—All metal drilling is done with round twist drills which may be secured in sizes designated by numbers as in the foregoing table or in sizes designated by fractions of an inch varying by sixty-fourths. When drilling steel the drill should be lubricated with light machine oil as it enters the hole. Brass, aluminum and cast iron are drilled dry without lubricant of any kind.

Drilling Insulating Material.—Moulded and laminated phenol compositions such as Bakelite, Formica, Redmanol, Celoron, etc., are best drilled with the point of the drill ground to the usual sixty degree angle but with the front of the cutting edge ground straight or flat to remove the hook. With hand drills any speed within the ability of the operator will be satisfactory. With power drills for holes not larger than one-half inch diameter speeds up to 1500 revolutions per minute may be used. These materials may be drilled dry or a small quantity of light machine oil or lard oil may be used as a lubricant. All phenolic substances of this class are very hard

DRIVER

on drills and dull the points quickly. The hole may be found two or three thousandths of an inch smaller than the drill size should the work be done so rapidly as to heat the material being handled.

To prevent the hole breaking around the edges when the drill comes through the back it is advisable to hold a block of wood solidly against the rear surface of the material being drilled. To prevent the holes from running off from the true position as marked with a punch it is best to first drill a small hole, about one-sixteenth inch diameter. The larger drill to make the finished hole will then follow this small hole as a guide.

Hard rubber is drilled in much the same manner as the other insulating materials just mentioned. The rubber is much easier to work than are the phenolic substances. It is essential to drill small guide holes first and to back up the rubber with wood blocks to prevent its breaking through around the hole.

Drilling Glass.—Plate glass in thicknesses of five-sixteenths inch and greater may be drilled successfully if plenty of time is spent and plenty of work applied. The drilling is done with emery dust kept wet with turpentine. A piece of drill rod is secured of proper diameter for the finished hole and the end of the rod is ground off perfectly flat. The rod is rotated at a few hundred revolutions per minute and is held against the glass with moderate pressure while the emery dust and turpentine are applied in liberal amounts until the glass is literally worn through by the process.

Laying Out Drill Holes.—It is advisable to lay out the positions of all holes for screws and control shafts with a pencil on a sheet of heavy paper the exact size of the panel or base board being used. This paper template is then fastened to the panel with library paste. Each point for drilling is marked by placing a sharp prick punch on the mark and striking the punch a single light blow with a hammer. The paper is then removed and all punch marks gone over with a center punch, again striking but a single sharp blow to avoid the possibility of working the mark out of place with added blows. The work is then ready for drilling.

See also *Tools*.

DRIVER.—A source of high frequency alternating current used to supply energy to radio circuits is called a driver since it supplies the necessary driving force for the work to be done. See *Oscillator*.

DROP, VOLTAGE.—See *Potential, Difference of*.

DRY CELL.—See *Battery, Dry Cell Type*.

DRY CELL TUBE.—See *Tube, Filament Current Supply for*.

DRY CONDENSER.—See *Condenser, Electrolytic*.

D. S. C.—An abbreviation for double silk covered. See *Wire, Silk Covered*.

DUOLATERAL COIL.—See *Coil, Honeycomb*.

DX.—An abbreviation standing for "distance" in radio work. Stations at a great distance from the receiver are called "DX stations," and working with such stations is called "DX work."

DYNAMIC LOUD SPEAKER.—See *Speaker, Loud*.

DYNATRON.—A tube in which increase of voltage applied

DYNE

between plate and filament causes a decrease in plate current. The action is opposite to that found with the ordinary three-electrode amplifying tube. There are three elements in the dynatron; first a heater filament or cathode, second a perforated anode which is positively charged, and third a plate to which positive voltage is applied. Electrons emitted by the cathode are attracted by the anode, pass through the perforations and reach the plate. Starting at zero voltage between plate and filament, a gradual increase of voltage first causes a gradual increase in plate current but after a critical voltage is reached, further increase causes a drop in the amount of plate current. This drop may continue until it reaches zero and becomes a negative flow. Beyond a second critical point increase of applied voltage will again cause an increase in plate current.

DYNE.—The unit of physical force. It is the force exerted by a weight of one milligram when acted upon by gravity. One milligram is equal to $1/454,545$ part of a pound.

E

e.—The symbol for electromotive force (instantaneous value).

E.—The symbol for electromotive force or voltage (effective value). See *Electromotive Force*.

EARTH.—See *Ground, Receiver*.

EBONITE.—See *Rubber, Hard*.

EDDY CURRENT.—See *Current, Eddy*.

EFFECTIVE RESISTANCE.—See *Resistance, Effective*.

EFFECTIVE VALUES.—See *Value, Average and Effective*.

ELASTANCE.—The reciprocal of the capacity of a condenser or anything having capacity is called the elastance of the condenser or other unit. The elastance is equal to 1 divided by the capacity in farads.

ELECTRICITY.—The cause of all electric and magnetic effects is called electricity. Many theories have been advanced from time to time to explain the nature of electricity itself, the most recent being known as the electron theory which is explained under the heading *Electrons*. The effects and action of electricity are used in radio and all electrical sciences.

ELECTRICITY, PRODUCTION OF.—See *Induction, Electromagnetic; Battery; and Thermo-Electricity*.

ELECTRODE.—Either one of the terminals of an electric source is called an electrode. The terminal, connection or conductor through which electric current or an electron stream enters or leaves anything is called an electrode. The terminal through which the current enters is called the anode, the terminal through which the current leaves being called the cathode. See *Anode and Cathode*.

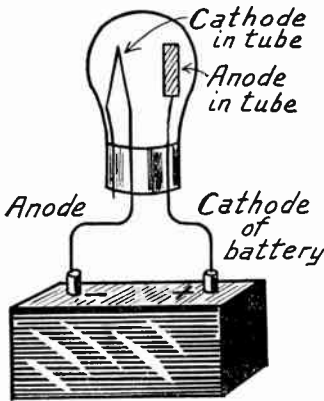

Electrodes of Tube and Battery.

Electrodynamics is the science of electric currents or of electricity in motion.

ELECTRODYNAMIC SPEAKER.—See *Speaker, Loud*.

ELECTROLYTE.—A liquid or solution in which the passage of an electric current causes chemical and electrical changes is called an electrolyte. An electrolyte must be an electrical conductor

ELECTROLYTIC CHARGER

whose atoms are broken up by the effect of the current. See also *Battery, Storage Type*.

ELECTROLYTIC CHARGER.—See *Charger, Battery, Electrolytic Type*.

ELECTROLYTIC CONDENSER.—See *Condenser, Electrolytic*.

ELECTROLYTIC RECTIFIER.—See *Charger, Battery, Electrolytic Type*.

ELECTROMAGNETIC FIELD.—See *Field, Magnetic and Electromagnetic*.

ELECTROMAGNETIC FLUX.—See *Flux, Electromagnetic*.

ELECTROMAGNETIC SPEAKER.—See *Speaker, Loud*.

ELECTROMAGNETISM.—See *Magnetism and Electromagnetism*.

ELECTROMOTIVE FORCE.—This is the force which will produce a flow of electric current in a conductor. Electromotive force is measured in volts. Its abbreviation is E. M. F.

Electromotive force acts when there is a difference of potential or difference of electric charge between two parts of a circuit. Electromotive force in an electrical circuit is similar to water pressure in a water circuit. Electromotive force may exist without there being a flow of current just as pressure may exist in a water system without there being any flow of water.

Electromotive force is produced by primary batteries which change the energy of their chemicals into electric pressure, by electric generators which turn mechanical energy into electric pressure, by thermocouples which turn heat into this pressure, and by certain crystals which turn mechanical pressure changes into voltages.

The term electromotive force means practically the same thing as either voltage or potential difference. Electromotive force is generally taken as meaning the total difference in electrical pressure throughout an entire circuit or the difference in pressure at the terminals of a source. Potential is generally used when mentioning the difference in pressure between two parts of a circuit. Voltage is often limited to designating the difference of pressure between a point and the earth which is assumed to be at zero voltage.

ELECTROMOTIVE FORCE, COUNTER.—See *Inductance, Self*.

ELECTRONS.—An electron is the smallest quantity of negative electricity that may move by itself between atoms of matter. The electron is a charge of negative electricity. All material substances as we know them are composed of molecules of the substance. Each molecule is made up of a number of atoms of the different elements which cannot be further subdivided into other substances. For instance, the finest division of water is a molecule of water; but this water molecule may be divided into atoms of hydrogen and

ELECTRONS

oxygen. Hydrogen and oxygen are elements and cannot be divided into anything else.

An atom of any substance contains both positive and negative electricity in equal amounts. When the smallest portion of some of this negative electric charge becomes detached from the atom, this detached charge is called an electron. An electron is not matter as we know it, nor has it any material substance of any kind. It is simply an electric charge.

An electron must be thought of as a charge of negative electricity rather than as any material form of matter of any kind. A study of electrons and their action is comparatively easy with an active imagination, otherwise it is difficult.

In a vacuum tube, electrons pass from the heated filament to the positively charged plate. The plate is positively charged because it is connected to the positive terminal of the B-battery or power unit. The number or amount of electrons flowing depends on several things. The hotter the filament the more will flow, the higher the plate voltage the more will flow, and the higher the degree of vacuum in the tube the more will flow. An increased flow of electrons is also caused by larger filaments and plates and by having the filament and plate closer together.

One reason for thinking of electrons only as charges of electricity is that no matter how long the electron flow continues from the filament to the plate, and no matter how great the flow, the plate never gains the slightest bit of weight.

The electrons are negative charges and flow toward a positively charged body such as the plate. That is, they flow from a point of lower voltage to another point of higher voltage. Electric current flows from a point of positive voltage to one of negative voltage. Therefore, in any circuit, the electron flow is in just the opposite direction to the current flow. The electrode from which the electrons flow is called the cathode. In the case of a radio tube the filament forms the cathode. The electrode to which the electrons flow is called the anode. In a vacuum tube the plate is the anode.

Atoms of matter of all kinds are composed of various numbers of electrons associated in the atom with a positive nucleus. The positive charge of the nucleus exactly balances the negative charge of the electrons. If one or more negative electrons are removed from an atom then the atom becomes positive. If the atom gains one or more negative electrons in addition to its normal number of electrons then it becomes negative or is negatively charged.

The flow of electrons from the filament in a tube when the filament is heated is often called the thermionic current. The amount of energy or voltage required to cause electrons to flow away from or leave the filament or cathode is called the equivalent voltage. The smaller the equivalent voltage for a certain cathode the larger will be the thermionic current which flows, that is to say, the less the energy that is required to cause electron flow the greater will

ELECTROSTATIC

be the flow. The equivalent voltage is a measure of the power required in heating the filament to cause a given electron flow.

When electrons leave the cathode and travel toward the anode they collide with the atoms of any gas which may be in the space between cathode and anode. Each time an electron collides with an atom it imparts some of its own energy to the atom.

The speed with which the electrons travel through the space is in proportion to the voltage between anode and cathode. The greater the voltage the greater the speed of the electrons. With high voltage the electron speed will be so great that enough energy is imparted to the atoms to detach some electrons from the atoms. The voltage at which this action takes place is called the ionization voltage and the process of breaking away of electrons from an atom by the collision or impact of other electrons is called ionization.

If the filament temperature or voltage in a tube is too high, ionization will be greatly increased and will be noticeable by a blue glow in the tube. This blue glow is caused by ionization due to the collisions of electrons with atoms. When ionization takes place under such conditions there is an excessive flow of thermionic current, this current being visible as the blue glow.

The movement or flow of electrons is always toward a positively charged body or toward a point of higher potential. That is, the electron flow is from negative to positive. Since electrons are themselves negative, they are attracted to and flow toward the positive or high voltage points. Before the electron theory was so widely accepted the convention was adopted which says the electric current flows from a positive point to a negative point in a circuit. Therefore, we find the electron flow from negative to positive and the current flow from positive to negative.

See also *Tube, Action of*.

ELECTROSTATIC.—Electricity may exist either in motion or at rest. Electricity in motion, either as an electric current or as a magnetic field, is studied under the names of induction and of electromagnetism. Electricity existing as a stationary charge, as it exists on the plates of a charged condenser, is studied under the name of electrostatics. Therefore, any action or effect that is associated with stationary charges of electricity is called an electrostatic or a capacitive action or effect. Any action or effect associated with the electric current is called an inductive or an electromagnetic action or effect.

An electrostatic field, such as that existing between the plates

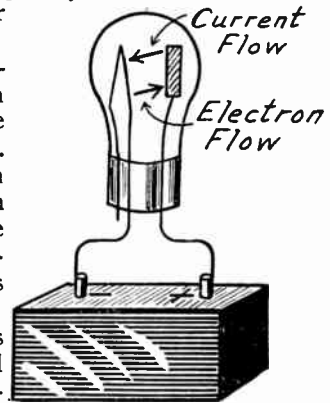

Electron Flow and Current Flow.

ELECTROSTATIC CAPACITY

of a condenser and extending through the dielectric, is a stationary field. It exists between the positive charge of one plate and the negative charge on the other plate. The two charges are always of opposite polarity and of equal quantity. The electrostatic field is between stationary charges of electricity.

Whenever the word electrostatic is used it refers to effects, to causes or to conditions having to do with condensers or with the capacitive effect between conductors.

ELECTROSTATIC CAPACITY.—See *Capacity*.

ELECTROSTATIC CHARGE.—See *Charge*.

ELECTROSTATIC COUPLING.—See *Coupling, Capacitive*.

ELECTROSTATIC FIELD.—See *Field, Electrostatic*.

ELECTROSTATIC INDUCTION.—See *Induction, Electrostatic*.

ELECTROSTATIC STRAIN.—See *Strain*.

ELECTROSTATIC STRESS.—See *Stress*.

ELIMINATOR, BATTERY.—See *Power Unit*.

ELIMINATOR, INTERFERENCE.—See *Trap, Wave*.

ELIMINATOR, STATIC.—See *Static*.

ELONGATION FACTOR OF COIL.—See *Coil, Inductance of*.

E. M. F.—An abbreviation for electromotive force. See *Electromotive Force*.

EMISSION, FILAMENT.—See *Tube, Filament Emission of*.

ENAMELLED WIRE.—See *Wire, Enamelled*.

ENERGY.—The ability to do work is called energy. While energy implies the ability or power to do work, this energy may not be in use but simply held available for use. There are many forms of energy such as electrical energy, mechanical energy, chemical energy, etc.

Kinetic energy is any form of energy contained in a body by virtue of the body's motion. The amount of kinetic energy contained in the body depends on its size and weight, also on its speed or velocity of motion. Thus a baseball thrown with speed contains more kinetic energy than is contained in a light feather dropping slowly through the air.

Potential energy is the energy contained in a body because of the body's position, shape, etc. Thus, a coiled spring contains potential energy because of its shape, a suspended weight contains potential energy because of its being held up in the air. If the spring is allowed to uncoil, its energy changes to kinetic energy and likewise if the weight is allowed to drop its energy changes from potential to kinetic energy. The magnetic field about a coil contains kinetic energy, the charge on the plates of a condenser is a form of potential energy.

ENERGY, TRANSFER OF.—See *Coupling*.

EQUALIZING CONDENSER

EQUALIZING CONDENSER.—See *Condenser, Balancing.*

EQUIVALENT RESISTANCE.—See *Resistance, Equivalent.*

ETHER.—It is supposed that all space is filled with a medium called the ether. The ether is not itself a material thing and therefore exists everywhere, even when the space is occupied by solids, liquids or anything else. The existence of the ether has not been proven, but by supposing it to exist explanations of many peculiar actions are made easier.

Radio waves and electromagnetic waves traveling through space with the speed of light are said to travel in the ether. Wave motion in radio is assumed to consist of movements or strains set up in the ether. A wave consists of alternating compressions and rarefactions passing through the ether. See *Radiation.*

EVACUATION OF TUBE.—See *Tube, Manufacture of.*

EXCITATION, SHOCK.—See *Selectivity.*

EXCITER.—See *Oscillator.*

EXPONENTIAL LOUD SPEAKER.—See *Speaker, Loud.*

F

f.—The symbol for frequency. See *Frequency*.

FACTOR.—See *Coefficient*.

FACTOR, POWER.—The power in a direct current circuit is measured in watts, one watt being equal to one volt pressure with one ampere flow. Therefore, the number of watts of power is equal to the number of volts multiplied by the number of amperes.

The actual power in watts in an alternating current circuit may be measured by a wattmeter. The apparent power may be calculated by multiplying the number of volts by the number of amperes. The apparent power in any alternating circuit, except a resonant circuit, is greater than the actual power. The ratio of the actual power to the apparent power or the actual power divided by the apparent power is the power factor of the circuit. Multiplying the volt-amperes or apparent power by the power factor will give as a result the actual power. This power factor may lie anywhere between zero and one. The power factor is equal also to the resistance of the circuit divided by the impedance of the circuit.

Dielectric power factor is a measure of the losses in a dielectric which are due to the volume leakage current and the dielectric hysteresis. In a condenser it is equal to the resistance divided by the capacitive reactance.

FADING.—When listening to a distant station the volume of the signal as heard from the receiver may suddenly begin to diminish and within a minute or less may have almost disappeared. No amount of readjusting the controls of the receiver will again bring back the signals when they have thus grown weak. Then, within the next minute or so the original volume may reappear and grow even louder than before; all this without a single thing about the receiver having been changed in the meanwhile. This action is called fading.

There is no explanation of fading which can be proven positively correct. However, there is a very interesting theory which seems to account for all of the freakishness of fading.

The action of the sun's rays produces an effect on the air which is called ionization. Ionized air is a conductor of electricity whereas ordinary air is an insulator. It seems that there is a layer of ionized air well up above the earth's surface. Radio waves will not go through this layer but when they strike it they are reflected back toward the earth in much the same way as light rays would be reflected back from a mirror. Of course, this ionized layer, called the "Heaviside" layer, is not smooth like a mirror but seems to roll and toss like waves of the ocean.

Radio signals or impulses sent out from the aerial of a broadcasting or transmitting station start out in every direction after leaving the aerial. They go east, west, north and south, also up and down. The waves that travel down are stopped by the earth, which is a conductor. That is to say, the waves do not penetrate the earth for any great distance. The waves that start out horizontally are absorbed by the atmosphere and various objects and

FADING

grow weaker and weaker as the distance from the transmitter increases.

The waves that travel upward continue until they strike the Heaviside layer and many of them are then reflected back toward the earth. Under some conditions the radio waves seem to slide along on the Heaviside layer for a tremendous distance before being reflected back to the earth. The signals coming to an antenna are a combination of those that travel directly through the atmosphere and those which have gone up to the Heaviside layer and have been reflected back.

In the daytime, due to the sunlight, the waves which go up in the air are absorbed and do not return and the only signals received are those called ground signals which come direct. But, at night both the ground wave and the wave from above come to a receiver which is comparatively near a transmitter, say within one hundred fifty to two hundred miles. It is evident that the signals which have gone up to the Heaviside layer and have then been reflected back have traveled a greater distance than those coming direct from the

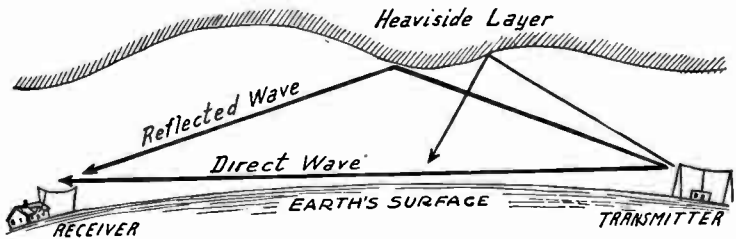

Effect of Heaviside Layer on Fading.

transmitter. Consequently the reflected signals may arrive just a little later than those coming direct. The combination may be such that the two waves balance each other out because the positive alternations of one arrive with the negative alternations of the other.

A shifting of the position or surface of the Heaviside layer will change this relation and signals may again be heard. This seems to be the most reasonable explanation of fading so far made. When at such a great distance from the transmitter that no ground wave is received fading is caused by movement of the Heaviside layer. The reflected waves are sometimes concentrated quite strongly and again are reflected hardly at all toward the antenna.

Fading is worst around 250 meters wavelength. Below this wavelength it is not so bad and above 400 meters there is very little fading and what does occur is not so pronounced as at low wavelengths. When within about one hundred fifty miles of a broadcaster the greater part of the signal strength is provided by the ground wave, both day and night, and fading is practically absent. Beyond this distance signals are received from the reflected wave more than from the ground wave and fading will take place. There is a certain distance from a broadcasting station where fading is worst for that one station. This distance generally runs between one hundred twenty-five and one hundred

FAHRENHEIT THERMOMETER SCALE

seventy-five miles. The signals from that one station will be received better at greater distances and also at less distances but there will be a band of comparatively dead spots forming a ring around the transmitter at some critical mileage. The critical mileage is sometimes called the skip distance.

Fading is noticed at night on distant reception because at night the overhead wave provides most of the signal strength from the distant stations, little coming from the ground wave. In the daytime the ground wave provides much of the strength and this part of the wave is not affected by fading. The worst fading of all seems to occur at sunrise in the morning and again at sunset in the evening.

Fading does not depend to any great extent upon the transmitter, the receiver, the weather, or anything under human control. When a signal fades there is nothing to be done about it until conditions change.

The following conclusions were drawn from tests on fading conducted by the Bureau of Standards and the American Radio Relay League. A changing barometer at the transmitting station does not affect the fading. The fading is greater when transmission takes place up or down the barometric gradient, although there seems to be no difference between transmission of signals traveling up and those traveling down. Waves which travel along the isobars or lines of equal barometric pressure produce stronger signals than waves crossing the lines. The same conclusions apply to transmission across and in line with the isotherms or lines of equal temperature. Best transmission is had when the signals can travel with a line of some one temperature.

It was concluded that clouds at the transmitting station have no effect on fading. Generally cloudy weather at and between the transmitter and receiver seems to increase the fading above the amount in clear weather. Clouds at the receiving station seem to cause stronger signals. When the signals are weak the fading is found to be slow and quite bad. Nearby wire lines were found to have no effect on fading.

FAHRENHEIT THERMOMETER SCALE.—See *Temperature, Scales of*.

FARAD.—The farad is the unit of measurement of electrical capacity. A condenser of one farad capacity would be of such size that a current of one ampere might flow into its plates for one second in charging the condenser to a pressure of one volt. A one farad condenser would be of tremendous proportions. Were the plates separated about three-eighths of an inch, with air for a dielectric, the two plates of this one farad condenser would each cover about three and four-tenths square miles. The practical units of capacity as used in radio work are the microfarad, which is equal to one millionth of a farad, and the micro-microfarad which is equal to one-millionth of a microfarad or the one-millionth part of a millionth of a farad.

FEEDBACK.—A transfer of energy from the plate circuit or output circuit of a vacuum tube back to the grid circuit or input of that same tube is called a feedback. Also, a passage of energy from any part of one stage of amplification to any part of the preceding stage or any other previous stage in a receiver is called a feedback. Feedbacks may take place from the parts of a receiver into the antenna of that receiver.

Regeneration is one form of feedback which is useful in radio. But an undesired feedback may so strengthen the impulses in the grid circuit of a tube as to cause local oscillations in the tube's circuits. Controlled feedbacks are useful while uncontrolled feedbacks are harmful.

FIBRE

Feedbacks may take place through any form of coupling, they may take place through condensers, through stray capacities or through the internal capacities of tubes; also through the electromagnetic couplings of coils or the windings of transformers and chokes. Feedbacks may take place through amplifying resistances or through the resistance of wiring and batteries.

Since the power in the output circuit is much greater than the power in an input circuit of a vacuum tube used as an amplifier, it is easier for this power to feed backward than for the desired forward progression to take place.

See also *Regeneration, Action and Principle of and Oscillation.*

FIBRE.—Fibre is a hard, tough material made from paper and cellulose, compressed and dried into sheets, rods and tubes. This is called vulcanized fibre and comes as red fibre, black fibre or natural gray fibre according to the coloring matter that is added. Fibre absorbs moisture and upon drying it warps badly.

The dielectric constant of fibres ranges between 5.0 and 8.0. Its dielectric strength varies between 200 and 400 volts per thousandth of an inch thickness, consequently it is a good insulator. Fibre is an undesirable and altogether poor material to use in radio receiver construction as may be gathered from the fact that its phase angle difference is from three to five degrees.

Coils are sometimes wound on fibre tubing and spiderweb coils are often wound on flat fibre forms. Fibre is sometimes used for supports and for bushings. All of this indicates the cheapest and least efficient type of construction.

FIELD, ELECTROSTATIC.—Between any two electrically charged bodies there exist lines of electric force which form an electrostatic field between the two charged bodies. Any two bodies

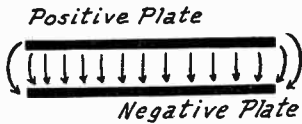

FIG. 1.—Electrostatic Field between Condenser Plates.

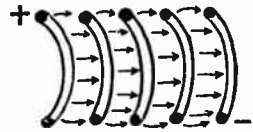

FIG. 2.—Electrostatic Field of a Coil Winding.

between which there is a difference of voltage are charged with reference to each other. The body at the higher voltage or positive voltage carries a positive charge and the one at the lower or negative voltage carries a negative charge. The space between them is placed

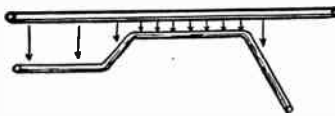

FIG. 3.—Electrostatic Field between Wires.

under a dielectric strain. Any insulating substance in this space forms a dielectric and the two bodies are then in effect the plates of a condenser.

The electrostatic field between two plates of a condenser is indicated by the arrows representing electrostatic lines of force in Fig. 1. The direction of

FIELD, MAGNETIC AND ELECTROMAGNETIC

these lines of force is assumed to be from the positively charged body to the negatively charged body.

In Fig. 2 is shown a cross section cut through the winding of a coil. If current is flowing through the coil there will be a drop in voltage from one turn to the next one. The wires forming the turns have therefore a voltage difference between them and electrostatic lines of force form small electrostatic fields between the turns.

Fig. 3 shows two wires which run parallel to each other through a part of their length. Assuming that the two wires are at different voltages there will be an electrostatic field between them as indicated by the arrows.

FIELD, MAGNETIC AND ELECTROMAGNETIC.—

The space in which are found the lines of force of a magnet is called the field of the magnet. If this field is produced by an electromagnet it is called an electromagnetic field, while if produced by a steel magnet or a permanent magnet it is called a magnetic field. There is no difference in the lines or in their action whether the field is produced by a permanent magnet or an electromagnet.

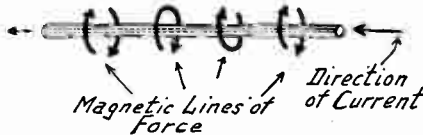

FIG. 1.—Electromagnetic Field Lines around a Conductor.

A conductor through which is flowing an electric current is surrounded by circular lines of force which whirl around the conductor as a center. These lines of force always travel around the conductor in one direction relative to the direction of current flow through the conductor as shown in Fig. 1. If the current flow is reversed through the conductor, the direction of the lines of force is also reversed

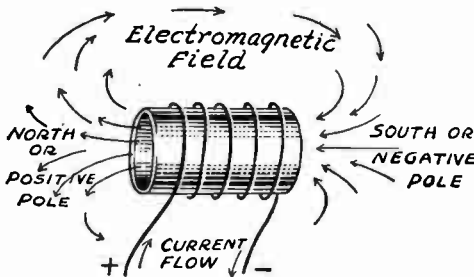

FIG. 2.—Electromagnetic Field around a Solenoid or Coil.

Should the conductor be made into a coil as shown in Figs. 2 and 3 the lines of force will not make complete circles around the turns of the conductor, but will pass completely through the coil, which is now a solenoid, and will then return in the other direction around the outside of the coil.

If a piece of iron be placed within the solenoid the lines of force that were traveling inside the coil will travel through the iron

FIELD, STRAY AND CONFINED

in the direction shown in Fig. 4, making the iron a magnet whose polarity corresponds to the direction in which current flows through the conductor. This combination of an iron core and a coil is called an electromagnet. The strength of the electromagnet depends on the number of amperes flowing through the coil and on the number of turns of the conductor around the iron core.

To produce a strong magnetic effect in iron or steel, the conductor is wound around the metal. The lines of force then go through the metal, called the core, and their direction through the core depends on the direction of current flow through the conductor and on the direction in which it is wound around the core.

The core of an electromagnet is made from soft iron, usually in thin sheets or lengths of wire in place of in a solid piece. Such a magnet retains its magnetism only as long as current flows through its winding. A small amount of magnetism remains in the core, no matter how soft the iron may be, and this remaining magnetism is called residual magnetism.

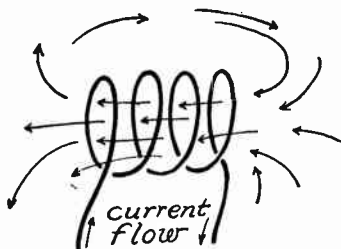

FIG. 3.—Electromagnetic Lines of Force around a Helix.

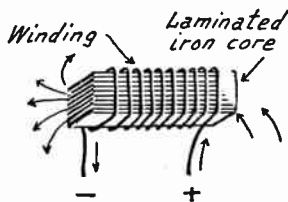

FIG. 4.—An Electromagnet with Its Field.

Every coil through which flows an electric current has around it an electromagnetic field. The coil may be wound around an iron core, it may be wound on an insulating tube, or it may be wound in the air; but the magnetic field exists nevertheless as long as current flows in the coil. The field rises out of the coil as the current starts, the field becomes stronger as the current becomes stronger, and then as the current drops away, the field lines of force shrink and recede back into nothing as the current stops. This action is called electromagnetic induction. See *Induction, Electromagnetic*. The same action takes place around any wire or other conductor in which current flows.

FIELD, STRAY AND CONFINED.—A stray field is either an electromagnetic or an electrostatic field which extends out to a considerable distance from its source of origin in a conductor carrying current or in conductors at different voltages. The stray field may interfere with the action of other parts of the receiver.

A confined field is an electromagnetic or an electrostatic field which is closely confined within a coil carrying current or between the plates of a charged condenser. Confined electromagnetic fields are such as found in closed field coils described under the heading *Coil, Closed Field Type*. Confined fields of any kind are closed fields.

FILAMENT

FILAMENT.—See *Tube, Design of* and *Tube, Filament Current Supply for*.

FILAMENT BATTERY.—See *Battery, A*.

FILAMENT CIRCUIT.—See *Circuit, Filament*.

FILAMENT CONTROL JACK.—See *Jacks and Jack Switches, Types of*.

FILAMENT CURRENT.—See *Current, Filament*.

FILAMENT CURRENT SUPPLY.—See *Power Unit, Filament Current Types of*.

FILAMENT EMISSION.—See *Tube, Filament Emission of*.

FILAMENT OF TUBE.—See *Tube, Filament Materials for*.

FILAMENT RHEOSTAT.—See *Rheostat*, also *Resistor, Filament Control*.

FILAMENT VOLTAGE.—See *Tube, Filament Current Supply for*.

FILAMENT VOLTAGE, EFFECT IN TUBE.—See *Tube, Characteristics of*.

FILAMENT VOLTMETER.—See *Meters, Ampere and Volt*.

FILES.—See *Tools*.

FILTER.—A filter is a combination of condensers and coils that will separate direct current from alternating current or that will separate alternating current of one frequency from alternating current of a different frequency.

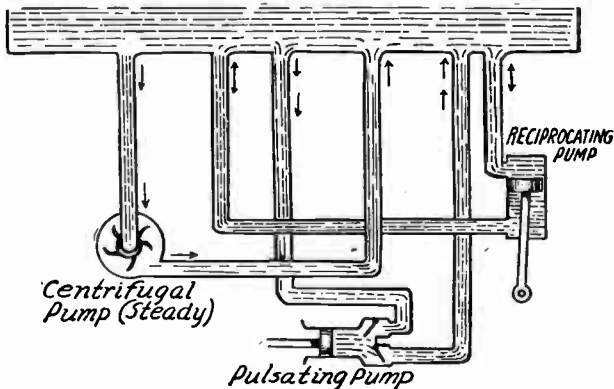

FIG. 1.—Three Water Circuits with One Common Tank.

It is possible to have a number of different currents flowing in the same wire at the same time. One wire or conductor may be common to almost any number of currents and may carry a part of many different electric circuits at the same time. This is illustrated by the water circuit in Fig. 1. Here is a large overhead tank partially filled with water and having six openings from the bottom. The centrifugal pump sends a steady flow of water in one direction through its pipe connections and the tank. The reciprocating pump sends water first one way and then the other through its piping and the tank. The pulsating pump sends water always in the same direction but in short pulses through its piping and the tank.

FILTER

All of the water circuits enter, pass through and leave the tank which is common to them all. Yet outside of the tank these circuits of the three pumps are separate and distinct.

In Fig. 2 are shown electric circuits similar to the water circuits of Fig. 1. The direct current generator sends a steady flow of electricity through its wiring connections and the common conductor. The alternator forces electricity first one way then the other through its wiring and the common conductor. The rectifier sends a pulsating direct current through its wiring and the common conductor. All of these electric circuits enter, pass through and leave the common conductor.

Between points *a* and *b* in the common conductor of Fig. 2 we find only direct current. Between *b* and *c* we find both direct and alternating current at the same time. Between *c* and *d* we have all three kinds of current. From *d* to *e* there is alternating current and also pulsating direct current. And between *e* and *f* there is only alternating current.

One side or one part of any number of electric circuits may be completed through one common wire or other conductor. It is the purpose of a filter to separate these currents at any desired point and to direct each of them separately into the conductors or wires

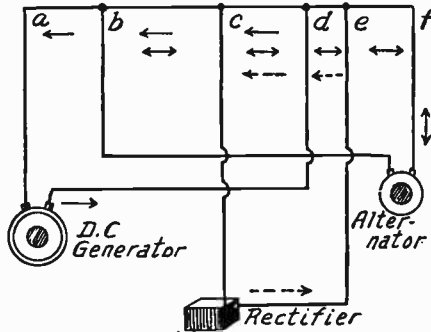

FIG. 2.—Three Electric Circuits with a Common Return.

through which we desire to have them flow and to keep them out of other wires or conductors.

A filter used to separate direct current and alternating current operates because of two facts. First, direct current will not pass through a condenser while alternating current will pass through a condenser. Second, direct current will pass freely through the windings of a coil while the same windings will offer opposition or reactance to the passage of alternating current through them.

Take the case shown in Fig. 3. Here, in the wire at the left, we have both direct current and alternating current coming along through the same wire. Then this wire divides, one part being connected to a condenser, the other to a choke coil. The dielectric which is between the plates of the condenser is an insulator as far as the direct current is concerned and the direct current cannot get through the condenser. But the direct current can pass through the winding of the choke coil with only the ohmic resistance of the

FILTER

wire to hinder its flow. So the direct current takes the path through the choke coil and avoids the path through the condenser.

But when the alternating current starts through the choke coil its alternations set up a strong electromagnetic field around the coil and the counter electromotive force set up in the coil windings so opposes the alternating current that it finds great difficulty in getting through. The condenser, if of large enough capacity, offers little opposition or reactance to the alternating current passing

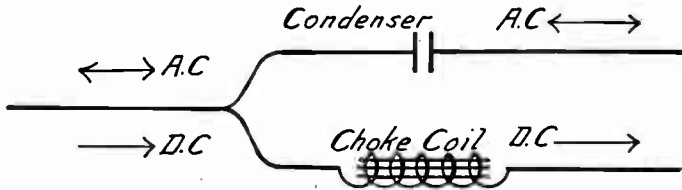

FIG. 3.—Filter Separation of Alternating Current from Direct Current.

right on through it. This is explained under the heading *Condenser, Action of*. So the alternating current takes the path through the condenser and avoids the path through the choke coil. At the right hand side of Fig. 3 the two kinds of current have been separated, each going its own way.

While it is of great advantage to be able to separate direct and alternating currents it is of equal importance to be able to separate

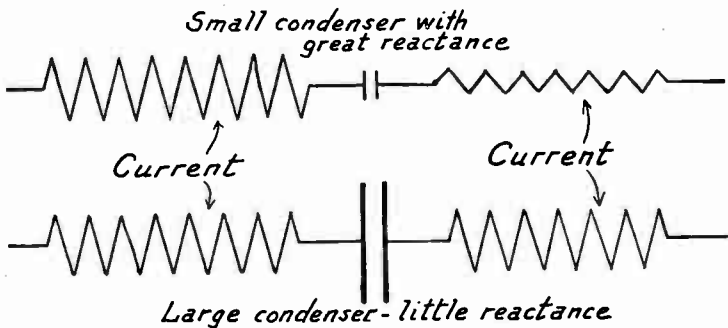

FIG. 4.—Effect of Large and Small Filter Condensers on Alternating Currents.

an alternating current of one frequency from an alternating current of a higher or a lower frequency when both frequencies are originally flowing in the same wire.

For separating different frequencies use is made of several rather peculiar properties of coils and of condensers.

In Fig. 4 an alternating current is shown passing through two condensers, one of small capacity, the other of large capacity. The condenser of small capacity offers a great reactance or opposition to any alternating current.

FILTER

The voltage or amplitude of any alternating current is reduced and the flow of current is reduced by a condenser of small capacity placed in a circuit.

At the bottom of Fig. 4 is shown the effect of a condenser of large capacity on an alternating current. The greater the capacity of a condenser, the less reactance or opposition it offers to any alternating current, consequently but little reduction in current is caused by the large condenser.

In Fig. 5 are two alternating currents passing through the same capacity or same condenser. One current is of high frequency, the other of low frequency. The high frequency current passes through the condenser with little

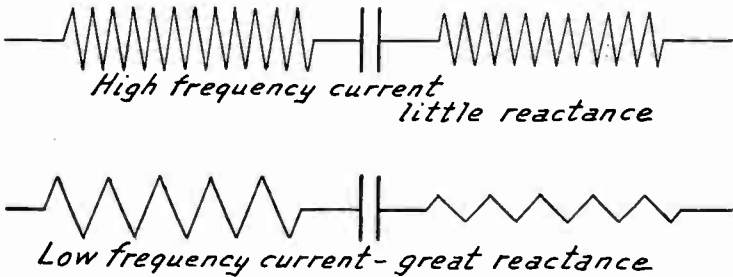

FIG. 5.—Effect of Filter Condensers on High and Low Frequencies.

reduction either in its amplitude or current flow. The condenser has little reactance or opposition to a high frequency current.

At the bottom of Fig. 5 is shown the effect of the low frequency current meeting the same condenser or capacity in its circuit. Now the current is greatly reduced. Any given size or capacity of condenser has greater reactance to low frequencies than to high frequencies. Thus it is possible to choose condensers which offer either large reactance or small reactance to alternating currents.

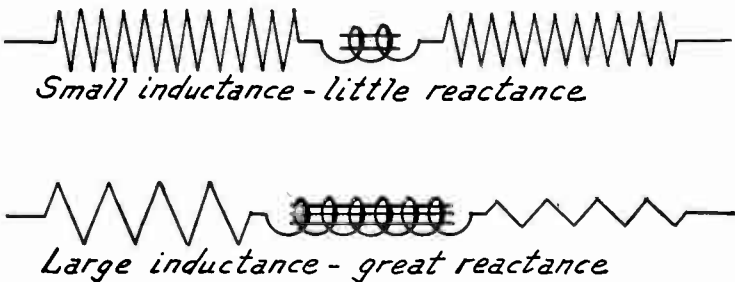

FIG. 6.—Effect of Filter Inductances on Alternating Currents.

Now to consider the effect of inductance as obtained in coils on the flow of alternating currents. At the top of Fig. 6 is shown an alternating current passing through a coil of small inductance. As may be seen, such a coil offers little reactance or opposition to the current, which passes through without much loss of voltage or amperage.

Should the amount of inductance be increased, as at the bottom of Fig. 6, and the same alternating current brought to the coil, there would be a great reduction of voltage and amperage because of the greater reactance of the larger inductance in the coil.

FILTER

Fig. 7 shows the effect of a given inductance on alternating currents of different frequencies. At the top is a current of high frequency trying to pass through the inductance coil. The coil has a large reactance to the high frequency and the flow of current is greatly reduced.

At the bottom of Fig. 7 is shown a low frequency current passing through the same inductance. Here we find but little reactance and the low frequency current passes with but small loss through the same inductance that nearly stopped the current of high frequency. So we may choose inductances or coils which offer either little reactance or great reactance to the flow of alternating currents of various frequencies.

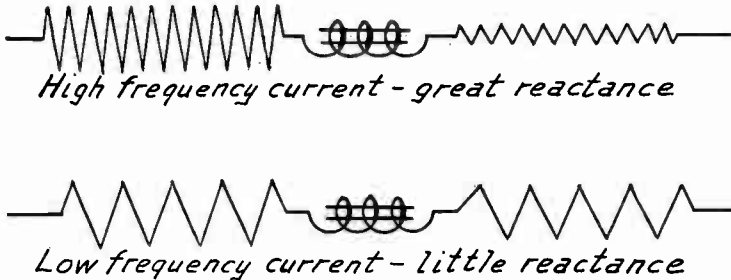

FIG. 7.—Effect of Filter Inductances on High and Low Frequencies.

The facts brought out in the foregoing examination of capacities and inductances in their effects on alternating currents of high and low frequencies are summarized in the following table:

		Amount of Opposition to Alternating Currents	
		At High Frequency	At Low Frequency
Condenser capacity.....	Small	Little	Great
	Large	Very Little	Little
Coil Inductance.....	Small	Little	Very Little
	Large	Great	Moderate

In addition to the effects produced by condensers and coils when used separately from each other, there are other valuable and useful effects to be secured by using capacities and inductances together. In Fig. 8 are shown the effects to be secured by employing series resonance and by employing parallel resonance.

At the left in Fig. 8 the circuit carries an inductance coil and a condenser connected in series. The combination of inductance and capacity will, at some certain frequency, become resonant or "tuned" to that frequency. In the con-

FILTER

dition of series resonance the reactance of the circuit drops to the lowest possible value. In fact, the opposition to current flow which is caused by the reactance of the coil and the condenser is completely balanced out and nothing remains to hold back the current except the ohmic resistance of the conductors.

At the right in Fig. 8 the coil and the condenser, the inductance and the capacity, have been connected in parallel with each other and the combination is placed in series with the rest of the circuit. Just as before, the combination of inductance and capacity will be resonant at some certain frequency. But now, in place of series resonance reducing the reactance we have parallel resonance increasing the reactance to an enormous extent. In fact the reactance in the circuit becomes so high that currents of this particular resonant frequency are practically stopped from passing through at all.

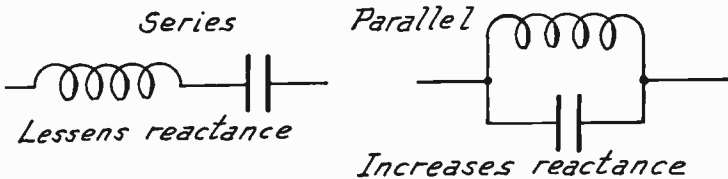

FIG. 8.—Effects of Series Resonance and Parallel Resonance in Filters.

Kinds of Filters.—Filters may be made to do almost anything in the way of passing or rejecting different frequencies of alternating current. Four principal types are in common use. These are; low pass filters, high pass filters, band pass filters and band exclusion filters. The purpose of each is shown in Fig. 9.

At the left of Fig. 9 the shaded square is supposed to represent a great number of different frequencies from low frequencies at the bottom to high frequencies at the top of the square.

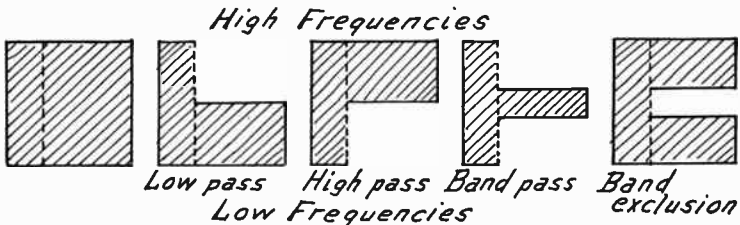

FIG. 9.—Types of Filters.

A low pass filter will allow the low frequencies to pass through the circuit but will oppose high frequencies.

A high pass filter will allow the higher frequencies to pass through the circuit but will oppose the lower frequencies.

A band pass filter will allow certain frequencies to pass through but will oppose frequencies which are either lower or higher than the band that the filter is designed to pass.

A band exclusion filter opposes certain frequencies but allows passage through the circuit of all frequencies which are either higher or lower than the band which the filter is designed to exclude.

FILTER

Low pass and high pass filters are used for the prevention of some kinds of interference and are also used in power units for supplying filament and plate current to receivers. Band pass filters are the basis of tuned radio frequency amplifier circuits and are used in the absorption type of wave traps. Band exclusion filters are used in the impedance type of wave traps.

Action of Filters.—Circuits generally consist of two sides and are composed of two conductors or wires which are called the line. As shown in Fig. 10 the line comes from the source and, after passing through the filter, goes on to the other devices in which the current is to be used.

Filter units are made up of coils, of condensers, or of both coils and condensers working together. A filter unit connected into the line may be called a line unit as in the diagram. The purpose of any unit in the line is to pass or encourage the flow of the desired

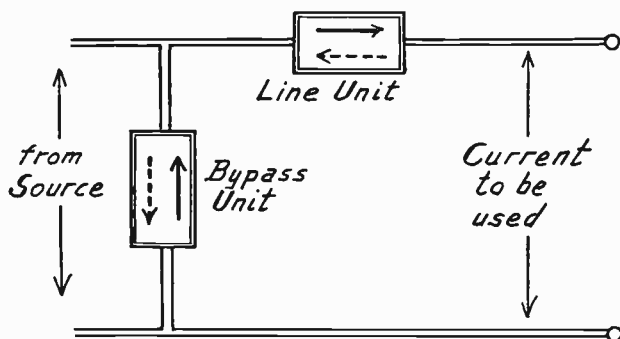

FIG. 10.—Connection of Filter Units in Circuit. Desired Frequencies in Full Line Arrows; Unwanted Frequencies in Broken Line Arrows.

frequencies and it may also resist or hold back the unwanted frequencies as indicated by the full-line and broken-line arrows in Fig. 10.

Many types of filters also employ coils, condensers, or both coils and condensers connected between the two sides of the line. Units so connected may be called bypass units. Their purpose is to bypass or to turn the unwanted frequencies back to the source without letting them go on with the current to be used. Another purpose of bypass units may be to oppose the flow of the desired frequencies so that they are forced on through the line, this also being indicated in Fig. 10.

In the types of filters to be shown it will be sufficient to illustrate the action by showing only one line unit and one bypass unit in most cases. However, it should be understood that the effectiveness of any filter will be improved if duplicates of line units are inserted in both sides of the line as in Fig. 11. Additional bypass units may also be connected as shown. The complete filter may be followed by another set of units exactly like the first set, thus further increasing the effectiveness of the whole device. This is shown at the right hand side of Fig. 11.

FILTER, BAND EXCLUSION TYPE

The capacity of bypass condensers is generally between one-half microfarad and two microfarads, although much larger capacities are often employed in the filters for power supply units and for special filters of various kinds. See *Condenser, Fixed*.

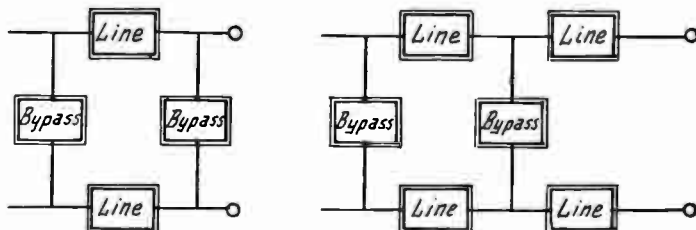

FIG. 11.—Filters Composed of Multiple Line Units and Bypass Units.

In the design of general purpose filters the reactance of the chokes is more than double that of the condensers. The ratio of condenser reactance to choke reactance usually runs between 1/10 and 1/50.

See *Coil, Choke; Condenser, Bypass; Power Unit; and Interference*.

FILTER, BAND EXCLUSION TYPE.—The purpose of a band exclusion filter is to oppose the flow of certain frequencies in a circuit while allowing the flow of frequencies both above and below the excluded band.

To prevent the passage of the unwanted frequency a coil and condenser in parallel with each other are placed in the line as shown at the left of the diagram. The inductance and capacity are of such values that the combination is resonant at the frequency to be excluded and this resonant condition offers great opposition to this frequency. Other frequencies flow through easily.

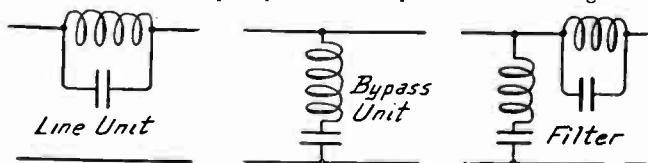

Band Exclusion Filter Units.

In the center of the diagram is shown a bypass unit consisting of a coil and a condenser in series with each other. The inductance of the coil and the capacity of the condenser are so selected that the combination is resonant at the frequency to be excluded from the main circuit. Therefore, at this frequency the bypass offers the lowest possible opposition to current flow and the unwanted frequencies go back through the bypass to the source, being thus prevented from going on through the filtered circuit.

At the right is shown the combination of line unit and bypass unit for the complete band exclusion filter. These units may be used in both sides of the line or may be repeated.

FILTER, BAND PASS TYPE.—The purpose of a band pass filter is to allow the entrance into a circuit of only a certain frequency or a narrow band of frequencies, excluding all frequencies either greater or less than those wanted.

FILTER, HIGH PASS TYPE

The combination of a coil and a condenser in series with each other will be resonant at a certain frequency. The inductance of the coil and the capacity of the condenser are selected so that they are resonant at the frequency to be passed through the circuit. Their reactance will then be least at this frequency and will be high at all other frequencies.

In the center of the diagram is shown the bypass unit for a band pass filter. This unit consists of a coil and condenser in parallel with each other. The

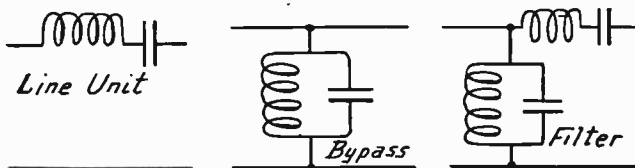

Band Pass Filter Units.

inductance of the coil and the capacity of the condenser are selected so that the combination is resonant at the desired frequency. The combination forms a case of parallel resonance which offers the greatest possible opposition to flow of current at the resonant frequency. Consequently this frequency is rejected by the bypass unit and is forced on through the circuit. All other frequencies, however, go back to the source through the bypass which offers little opposition to frequencies other than the one at which it is resonant.

At the right hand side of the diagram is shown the combination of line unit and bypass unit to form a complete band pass filter. These units may be repeated to increase the effectiveness of the filter.

FILTER, HIGH PASS TYPE.—A high pass filter is designed to allow all frequencies above a certain point to flow in a circuit and to prevent the flow of all frequencies below this point. A condenser will pass currents of high frequency much easier than currents of low frequency. A condenser is inserted in the line as shown at the left in the diagram, the capacity of this condenser being selected of such value as to allow passage of frequencies above the desired cut-off point and to hinder the flow of frequencies below this point.

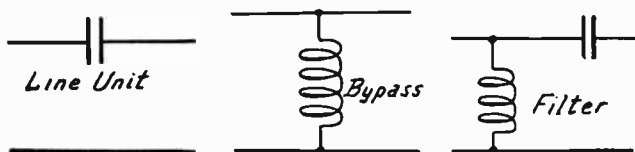

High Pass Filter Units.

In a high pass filter it is desired to return all frequencies lower than the critical point to the source and to accomplish this an inductance coil is used for a bypass as shown at the center of the diagram. An inductance will allow comparatively free flow of low frequencies through it while offering great opposition to higher frequencies. The inductance of this coil is of such value that it carries off the frequencies below the cut-off point, but rejects the higher frequencies which are thus forced to pass on through the circuit.

The combination of a line condenser and a bypass coil to form a high pass filter is shown at the right. As with all other filters, these units may be repeated. Since the cut-off points of coils and condensers with respect to frequency are not sharply defined it is necessary to build a high pass filter of repeated units if it is to be reasonably effective in its work.

FILTER, LOW PASS TYPE

FILTER, LOW PASS TYPE.—A low pass filter is used to allow all frequencies below a certain value to pass into a circuit while rejecting or turning back all higher frequencies. An inductance coil inserted in the line, as at the left hand side of the diagram, will allow low frequencies to pass through it with comparative ease while offering much greater opposition to high frequencies.

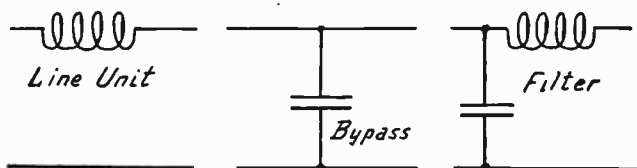

Low Pass Filter Units.

In order to turn the undesired high frequencies back to the source a condenser may be used as a bypass as shown in the center. The capacity of a condenser may be selected of such value that it offers little reactance or opposition to frequencies above a certain value, yet greatly impedes the flow of lower frequencies through it. Such a condenser is used for low pass filters.

At the right hand side of the diagram is shown the combination of a coil line unit and a condenser bypass unit, making a low pass filter. The inductance of the coil holds back the higher frequencies, which are bypassed through the condenser. The condenser rejects the lower frequencies, which are allowed to pass through the coil to the circuit.

The cut-off points of coils and condensers are not at all sharp with reference to passing or rejecting certain frequencies, therefore a low pass filter should be made up of a number of similar units as shown at the right.

FILTER, STATIC.—See *Static*.

FILTER, WAVE.—See *Trap, Wave*.

FINDER, DIRECTION.—See *Compass, Radio*.

FIRE INSURANCE RULES.—See *Rules, Underwriters'*.

FIXED CONDENSER.—See *Condenser, Fixed*.

FIXED COUPLER.—See *Coupler, Fixed Type*.

FIXED RHEOSTAT.—See *Resistor, Filament Control*.

FLASHING OF FILAMENT.—See *Tube, Restoration of*; also *Tube, Manufacture of*.

FLAT TOP ANTENNA.—See *Antenna, Forms of*.

FLEMING VALVE.—A two-element vacuum tube used as a detector. See *Tube, Rectifying Types of*.

FLUX, DENSITY OF.—See *Iron and Steel*.

FLUX, DIELECTRIC.—It is considered that when the plates of a condenser are charged with a certain quantity of electricity an equal quantity of electricity is displaced or moved through the dielectric which is between the plates of the condenser. This electricity that is displaced in the dielectric is called the dielectric flux. See *Current, Displacement*.

FLUX, ELECTROMAGNETIC.—The magnetism which flows in a magnetic circuit and forms the field of the magnet or coil is called the electromagnetic flux. The flux consists of the lines of force. See *Field, Magnetic and Electromagnetic*.

FLUX, LEAKAGE

FLUX, LEAKAGE.—In an electromagnetic circuit a part of the lines of force do not completely encircle all of the turns of the magnet coil. The part of the flux which is not useful in producing linkage is called the leakage flux.

FLUX, SOLDERING.—See *Soldering*.

FOIL, SHIELDING.—See *Shielding*.

FORCED ALTERNATION.—See *Current, Alternating*.

FORCED OSCILLATION.—See *Selectivity*.

FORM, COIL WINDING.—See *Coil, Design*.

FORMICA.—See *Phenol Compounds*.

FOUCAULT CURRENT.—See *Current, Eddy*.

FOUR-CIRCUIT RECEIVER.—See *Receiver, Four-Circuit*.

FOUR-ELEMENT TUBE.—See *Tube, Four-Element Type*.

FRAME.—See *Television*.

FRAME ANTENNA.—Another name for a loop. See *Loop*.

FRAME, RECEIVER.—In many of the more modern types of receivers all of the units are carried upon a strong metallic framework which is called the receiver frame.

This framework is generally made up of cast brackets of aluminum or of brass. Provision is made for supporting a sub-panel at some distance above the bottom of the cabinet when a sub-panel is included in the receiver's design. Otherwise the framework is built so that tuning condensers mount solidly in the framework and tuning coils may be supported at convenient points for proper connection into their circuits. The framework always carries the front panel which may be of metal or of some dielectric material. With all of the parts mounted on the frame a complete receiver is formed and this receiver may then be handled as a unit.

FREE ALTERNATIONS.—See *Current, Alternating*.

FREE GRID VOLTAGE.—See *Tube, Characteristics of*.

FREE OSCILLATION.—See *Oscillation*.

FREQUENCY.—The number of complete cycles that occur during one second in an alternating current is called the frequency of the current. A cycle includes the time between the rise of the current from zero to maximum in one polarity, its fall to zero, rise to maximum in the other polarity, and return again to zero. See *Cycle*.

Various frequencies are used in radio. Audible frequencies lie between 16 and 15,000 cycles per second. Broadcasting transmission frequencies or carrier wave frequencies vary from 550,000 cycles to 1,500,000 cycles. Visible light rays are measured in hundreds of trillions of cycles per second. The frequency of X-rays is far higher than that of the visible light rays.

The frequencies employed in various kinds of radio service are given under the heading *Channels, Radio*.

FREQUENCY, AUDIO.—Audio frequencies include all of the frequencies of vibration of sound waves which can be heard by the human ear. The lowest audible frequency is around 16 cycles per second while the highest audible frequency is somewhat higher than 10,000 cycles per second. The parts of a radio receiver which

FREQUENCY, BEAT

handle and amplify these audible frequencies are called the audio frequency parts of the receiver. Audio frequency is generally abbreviated "A. F." See also *Sound*.

FREQUENCY, BEAT.—See *Beats, Formation of*.

FREQUENCY CHANGER.—See *Changer, Frequency*.

FREQUENCY, CRYSTAL CONTROL OF.—See *Crystal, Frequency Control by*.

FREQUENCY DISTORTION.—See *Distortion*.

FREQUENCY, FUNDAMENTAL.—All radio circuits contain inductance and capacity. An antenna circuit contains the capacity of the antenna and the inductance of the antenna as well as the inductance of any coil connected in this circuit. All coils have inductance but have distributed capacity as well.

Any combination of inductance and capacity forms a resonant circuit at some frequency. No matter how small the inductance nor how small the capacity there will be a frequency, although it may be a high one, at which they form a resonant circuit. The frequency at which the natural inductance and capacity in any circuit or any unit are resonant is called the fundamental frequency. Another name for fundamental frequency is natural frequency. The fundamental or natural frequency is the frequency at which the unit or circuit is resonant without making any adjustments or intentional changes either in the capacity or the inductance and without adding either external inductances or external capacities.

FREQUENCY, FUNDAMENTAL OF ANTENNA.—See *Antenna, Fundamental Frequency of*.

FREQUENCY, GROUP.—The number of sets or groups of waves passing in one second is called the group frequency. The number of groups per second is usually low enough so that the group frequency is an audio frequency or the frequency of an interrupted continuous wave.

FREQUENCY, HIGH.—The terms high frequency and low frequency have a relative value only. Compared with the 60-cycle frequency ordinarily used in house lighting and power circuits a frequency of 500 cycles is considered to be a high frequency. Compared with a broadcasting frequency of perhaps 1,000,000 cycles per second a frequency of 15,000,000 cycles per second used in amateur radio is a high frequency. The radio frequency currents are often called high frequency currents while the audio frequency currents are classed as low frequency currents.

FREQUENCY, INTERMEDIATE.—In between audio and radio frequencies. See *Receiver, Superheterodyne*.

FREQUENCY, LOW.—See *Frequency, High*.

FREQUENCY, MEASUREMENT OF.—See *Meters, Frequency, Signal Frequency Measurement with*.

FREQUENCY, METERS FOR.—See *Meters, Frequency*.

FREQUENCY, NATURAL.—See *Frequency, Fundamental*.

FREQUENCY, RADIO.—Radio frequencies include all of the

FREQUENCY, RADIO

frequencies of radio waves which are used for the transmission of radio signals through space. These frequencies range from between 90,000 and 100,000 cycles per second in long wave transmission up to 400,000,000 or more cycles per second used in some kinds of amateur transmission. See *Channels, Radio*.

The parts of a radio receiver which take these frequencies from the waves coming through space, amplify them and deliver them to a detector tube, are called the radio frequency parts of a receiver. Radio frequency is generally abbreviated "R. F."

FREQUENCY, REACTANCE AFFECTED BY.—See *Reactance*.

FREQUENCY, RESONANT.—Any circuit in which are found inductance and capacity will combine its inductive reactance with its capacitive reactance so that the two balance out at some certain frequency, leaving only the ohmic resistance in the circuit. The frequency at which this balancing of the two reactances takes place is the resonant frequency for that circuit with its particular values of inductance and capacity. See *Resonance*.

A tuned circuit in a radio receiver has either its capacity or its inductance adjusted so that their reactances balance out and make the circuit resonant at the frequency which is to be received and to which the circuit is tuned. See *Resonance, Inductance-Capacity Values for*.

FREQUENCY, SUM.—See *Beats, Formation of*.

FREQUENCY, WAVELENGTH RELATION TO.—See *Wavelength, Frequency Relation to*.

FULL WAVE RECTIFIER.—See *Rectifier, Full Wave*.

FUNDAMENTAL FREQUENCY.—See *Frequency, Fundamental*.

FUNDAMENTAL WAVELENGTH.—See *Antenna, Fundamental Frequency of*.

FUSES AND PROTECTIVE DEVICES.—When using batteries as a source of filament voltage and of plate voltage for the tubes in a receiver there is considerable danger that the voltage of the plate battery will be accidentally applied to the filament circuit. The result will be an instantaneous burning out of the filaments in all tubes connected to circuits receiving this abnormally high voltage. Of course it is not the voltage that causes the filaments to burn out but is the greatly increased flow of current or increase in the number of amperes that pass through the filaments under the effect of the high voltage.

Various forms of fuses have been made for attachment to the filament circuits of vacuum tubes in such a way that any abnormal increase of voltage would immediately cause burning out of the fuse, this resulting in opening the filament circuit and protecting the filaments themselves. It is quite difficult to make a fuse which will be burned out by the increase of amperage which is sufficient to destroy a tube's filament.

FUSES AND PROTECTIVE DEVICES

A satisfactory method of preventing tube burnouts which might be caused by B-battery voltage is shown in the illustration. The line from the negative terminal of the B-battery to the receiver is detached from its terminal on the receiver. This line is then connected to one side of any ordinary 25-watt lamp bulb such as used for house lighting on 110-volt circuits. A wire is then run from the other side of this lamp to the receiver terminal from which the negative B-battery wire was removed. Such a lamp will not pass a current of more than one-quarter ampere unless the B-battery is in excess of 100 volts. This quarter-ampere, which is the maximum allowed in the B-battery circuit by the lamp, is not sufficient to burn out the filaments of ordinary quarter-ampere vacuum tubes. A lamp of this size will not protect three-volt tubes which are used with dry cells for filament batteries or A-batteries since such tubes require only six hundredths of an ampere through their filaments.

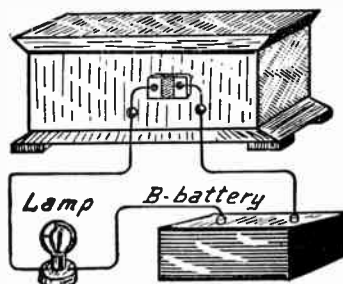

Incandescent Lamp for Protecting Tube Filaments.

When using this scheme it is essential to connect a bypass condenser of at least one microfarad capacity between the B-battery terminals on the receiver. This prevents forcing the high frequency currents through the resistance of the lamp. The bypass must be connected at the receiver as shown and not across the terminals of the batteries because it is necessary that the bypass include both the battery and the lamp.

When using plate power units rather than batteries for the plate voltage there is little or no danger of burning out the filaments of the tubes. Most plate power supply units will not deliver more than one-tenth of an ampere under any conditions and this small current is far below the amount which will burn out a tube filament. Filament power units deliver enough current to burn out a tube.

Protection against power line voltages when using certain types of battery chargers may be had by the use of a condenser in the grounded circuit of the receiver as described under *Ground, Receiver*.

G

G. g.—The symbols for conductance measured in mhos. See *Conductance*.

GAIN.—The ratio of the output power, voltage, or current to the input power, voltage, or current of a circuit or electrical system. See also *Unit Transmission*.

GALENA.—See *Detector, Crystal*.

GALVANOMETER.—An instrument which will measure or indicate very small electric currents is called a galvanometer.

GANG CONDENSER.—See *Condenser, Multiple*.

GANG CONTROL.—See *Control, Single*.

GANG SOCKET.—See *Socket, Receiver*.

GASEOUS DETECTOR.—See *Tube, Detector Types of*.

GASEOUS RECTIFIER.—See *Power Unit*.

GAUGE, WIRE.—See *Wire, Copper*.

GENERATOR, HIGH FREQUENCY.—See *Oscillator*.

GEOGRAPHICAL DISTANCES.—See *Distances, Geographical*.

GEOMETRIC.—A series of numbers which increase in value according to the same factor used as a multiplier in each case is called a geometric series. The geometric ratio of two numbers is the quotient obtained by dividing one by the other.

GERMAN SILVER.—See *Silver, Nickel*.

GLASS.—The dielectric constant of plate glass may run as low as 3.0 while the dielectric constant of ordinary window glass may be found as high as 8.0. The dielectric constant of glass classed as heat resisting is generally between 5.0 and 6.0.

Glass is a desirable insulator from the standpoint of radio losses, having a phase angle difference in plate glass of around 0.55 degree and as low as 0.30 degree in some types of heat resisting glass. The dielectric strength of glass as an insulator runs from 150 to 300 volts per thousandths of an inch thickness.

GLASS, DRILLING OF.—See *Drilling*.

GLOW LAMP.—See *Television*.

GLOW TUBE.—See *Tube, Voltage Regulator Type*.

GOLD.—Gold is a metal which is practically unaffected by moisture, by heat or by the common acids and alkalies. Gold is very soft when pure and is alloyed with copper or silver before being used in commercial work. The electrical resistance of gold is about 1.15 times that of copper.

Because of the fact that gold does not corrode or oxidize it is often used as the plating of copper wire in radio frequency work. Gold plated wire may be left bare of insulation, thus doing away with any of the losses due to insulating materials around the conductor.

GONIOMETER.—This is one form of direction finder or radio compass. It employs two loops set with their planes at right angles and mounted in a fixed position, that is, so that they do not rotate. Each of the loops is tuned with a condenser, the two condensers

GONIOMETER

being operated by one control. Each loop is connected to two coils, the two for each loop being in series with each other and the loop. The four coils for the two loops are arranged in the form of a square as shown by the drawing. Within the square is a small pickup coil which is connected to the input circuit of a receiver. This pickup coil may be rotated until the weakest signal is indicated by the receiver. The coil is attached to a compass dial and its position with reference to the dial indicator shows from which direction the signal is coming.

GRAINING, PANEL.—The smooth polished surface of any panel material may be given a dull, satiny appearance by graining. The panel surface is cleaned and the sheet laid flat on a solid surface. A block of wood three or four inches long is prepared by attaching a pad of felt about one-quarter inch thick to one side.

Over the felt is placed a sheet of number 0000 sandpaper. The panel surface is rubbed in one direction and in straight lines with the sandpaper backed with the felt pad. A few minutes' rubbing will produce the desired finish.

GRAM.—See *Metric System*.

GRAPH.—A graph, or as it is often called a curve, is a simple and easy method of showing how a change made in one thing will affect some other thing. Graphs may be used to show the relation between any two values or quantities, not only in radio work but in everyday life. For instance, a graph or curve might be drawn showing the relation between the weight of a loaf of bread and its size in cubic inches. Many graphs are made which show changes of business conditions with reference to months of the year.

A large number of graphs are shown under the heading *Tube, Characteristics of*. These graphs show the relation between various factors which affect the performance of the tube in its work of amplification, detection, modulation or oscillation. Two variable quantities are always considered in laying out any one curve on a graph. If more than two quantities or conditions are to be considered, two or more curves are shown. A single graph may show several different relations between quantities and these quantities may or may not be related to one another. Referring to the article mentioned, graphs may be examined in which are shown the effects of grid voltages on plate current, of plate voltages on plate current, of plate voltages on internal resistance and many others.

The graph is laid out on two scales, one vertical and the other horizontal. The horizontal distances are laid off on lines called abscissas and the vertical distances are laid off on lines called ordinates. Which of the values are placed on the abscissas and which on the ordinates is a matter of convenience or of adaptability of the graph sheet being used. The elementary principles governing the use of graphs in radio work are explained in the following pages.

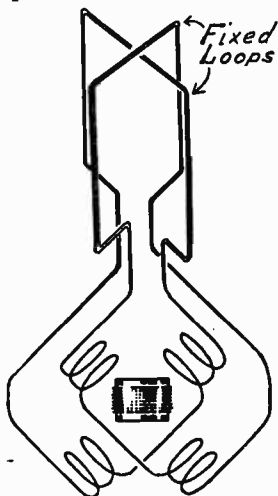

Principle of the Goniometer.

GRAPH

A graph consists of a sheet which is ruled off in squares by vertical and horizontal lines. Fig. 1 shows the general plan of all graphs. A square is divided into four equal parts by a vertical line and a horizontal line intersecting at the center of the square. The center of the square is considered to be of zero value or quantity. If it is desired to show increases these increases are shown above the horizontal line or to the right of the vertical line. Decreases in value or quantity are shown below the horizontal line or at the left of the vertical line. In Fig. 1 arrows pointing toward plus signs indicate positive values or increases while arrows pointing toward minus signs indicate negative values or decreases.

Curves which show increases or positive values use only the upper right hand quarter of the complete square. This upper right hand quarter is shown enlarged and off by itself in Fig. 2. The zero point is now in the lower left hand corner and moving away from zero, either horizontally or vertically, shows an increase in whatever quantity is being considered.

To show the use of graphs several curves will be developed showing the relations between the number of turns of wire required on a tuning coil and the diameter of the coil or the capacity of the condenser with which the coil is used. These values will be found written out in the table showing the turns required on tuning coils using number 20 double silk covered wire under the heading *Coil, Tuning, Sizes Required for*. For convenience this table is repeated below:

Condenser Capacity in Mfds.	Diameter of Coil Winding						
	2"	2½"	2¾"	3"	3¼"	3½"	4"
.00025	150	108	96	86	80	76	67
.0003	128	93	83	74	69	65	58
.00035	113	82	73	66	61	58	52
.0005	84	62	56	51	47	45	40
.001	48	39	35	32	30	28	25

Supposing it is desired to show the relation between the number of turns required and the diameter of the coil in inches. That is, we are going to show how the diameter of the coil affects the number of turns required. The graph will be laid out as in Fig. 3 with zero for both the number of turns and the diameter of the coil in the lower left hand corner. It will be convenient to use the vertical scale to indicate the number of turns on the coil and to use the horizontal scale to show the diameter of the coil. There is no reason why this could not be reversed and the coil diameter shown by the vertical scale with the number of turns on the horizontal scale.

It will be necessary to divide the vertical scale so that the greatest number of turns will come within the range of the scale. Inspection of the table shows 150 to be the highest number that must be handled. There are nine divisions in the vertical scale of the graph and if each division is assumed to represent 20 turns of winding the highest number, or 150, will come below the top of

GRAPH

the vertical scale. Consequently the vertical scale is laid off, 20, 40, 60, etc.

The horizontal scale must accommodate the greatest diameter to be considered. Inspection of the table shows this to be four inches. It is found that the horizontal scale, like the vertical, has nine divisions. If two divisions are allowed to represent one inch of coil diameter the greatest diameter, four

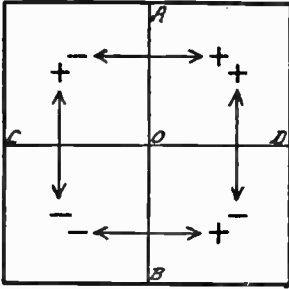

FIG. 1.—General Plan of All Graphs.

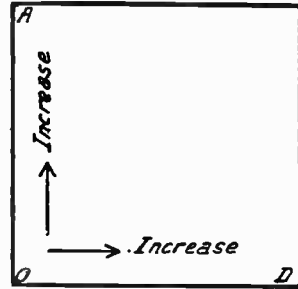

FIG. 2.—Quarter of Graph Used for Increasing Values.

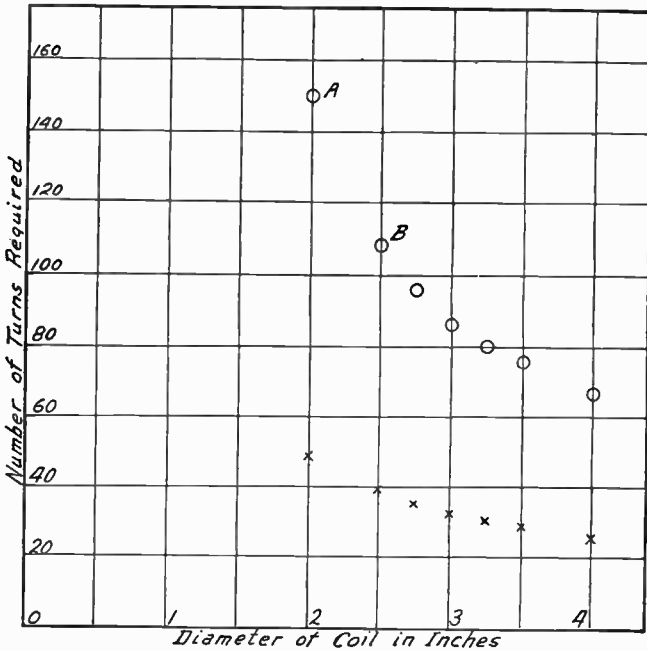

FIG. 3.—Laying Out the Points for a Graph.

inches, will be included on the horizontal scale. Therefore, each second division is marked off to represent one inch. The intermediate divisions will then present half inches of coil diameter. We are now ready to lay out the curve.

We will assume that it is desired to show the number of turns required for various diameters when using a .00025 microfarad tuning condenser.

GRAPH

This will take in all of the values shown in the top line of the table. A coil two inches in diameter is found to require 150 turns, therefore a small circle is made at the intersection of the vertical line representing two inches and a horizontal position that would represent 150 turns. This circle is marked *A*.

Following the table it is seen that a two and one-half inch diameter requires 108 turns, so another circle marked *B* is placed at the intersection of the two and one-half inch line and a horizontal line that would indicate 108 turns. The next value, 96 turns for two and three-quarter inches, is marked off by a third circle at the proper intersection. All of the remaining values are marked with small circles until 67 turns is indicated as the number for the four-inch coil. This makes a series of circles whose positions represent all of the relationships given in the top line of the table.

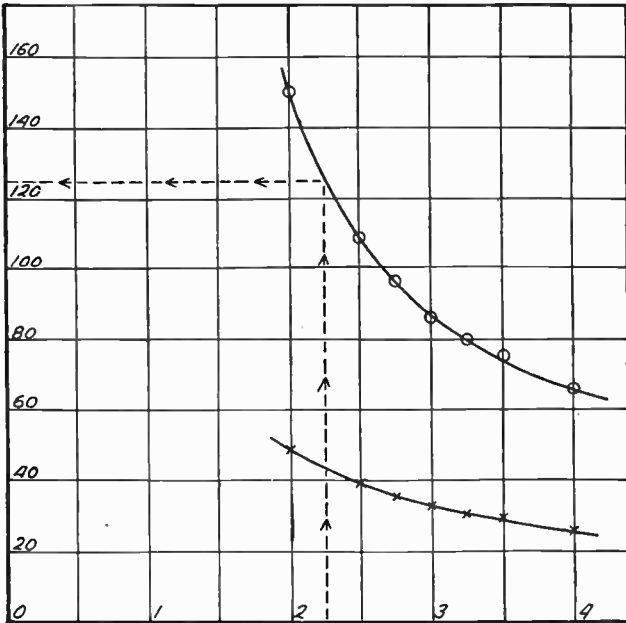

FIG. 4.—Drawing in the Curves and Determining an Intermediate Value for a Graph.

It might also be desired to show the number of turns required when using a .001 microfarad condenser, these values being shown in the bottom line of the table. When more than one curve is to be drawn on a single graph it is customary to lay off the points for one by using small circles, the points for a second by using small crosses, the points for a third by dots, and so on, the idea being to distinguish the points which apply to each curve.

In Fig. 4 the points laid out on Fig. 3 have been joined by curves drawn through them. It will be noticed that in place of drawing straight lines from the center of one point to the center of the next, a smooth curve of gradual slope is drawn so that it passes as nearly as possible through each of the points. It is assumed that the changing relation between coil diameter and number of turns is gradual and not as might be represented by a jagged line. It will often be found that one or more of the points are not exactly cut by the curve but this is neglected.

GRAPH

One of the most useful features of such curves is that they allow intermediate values, not shown in the table, to be determined very closely. As an example; suppose it is desired to know the number of turns required for a coil $2\frac{1}{4}$ inches in diameter used with a .00025 condenser, this being a value not given by the table. An examination of the upper curve in Fig. 4 will give the number. Following upward on a vertical line from the $2\frac{1}{4}$ inch position, it is found that this line cuts the curve opposite the point for 125 turns. That is, following across to the vertical scale for number of turns from the intersection of the vertical line for $2\frac{1}{4}$ inch diameter

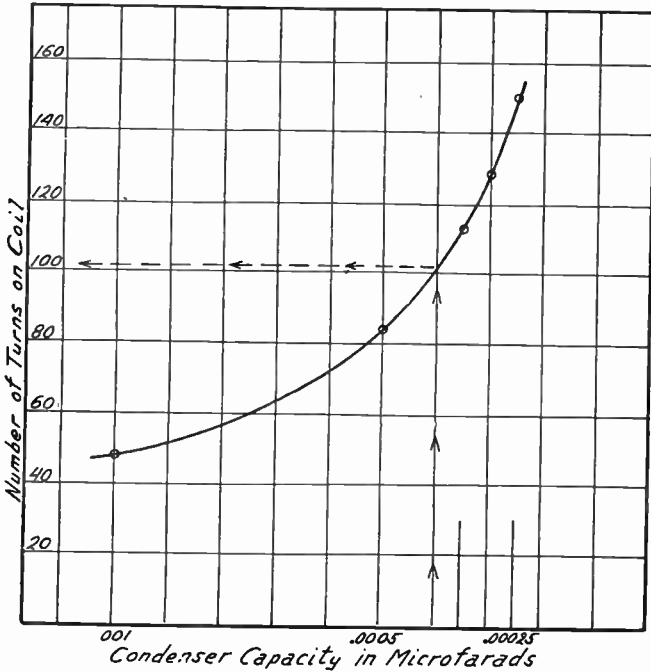

FIG. 5.—Graph Showing Condenser Capacity and Number of Turns.

brings us to a point on this vertical scale that represents 125 turns, which is the actual number required.

A person using the table alone might quite naturally suppose that the number of turns for $2\frac{1}{4}$ inch diameter would be midway between the numbers for 2 inches and for $2\frac{1}{2}$ inches diameter. But this would not be correct because the difference between 150 turns (for 2-inch diameter) and 125 turns as found for $2\frac{1}{4}$ -inch diameter is 25, yet the difference between 125 turns and 108 turns (for $2\frac{1}{2}$ -inch diameter) is not 25 but is only 17. Curves are used to avoid the necessity of many long and difficult calculations because they show the results instantly and with much less chance of error than by using the slower methods of calculation.

GRAPHITE

The graphs so far used have been laid off in squares, but graphs may be laid off in any kind of rectangles or oblongs as well as squares. This is brought out in Fig. 5. Here it is assumed that we wish to learn the relation between the number of turns required on a coil of given diameter and the capacity of the tuning condenser used with the coil.

Referring again to the table, it is found that the largest condenser capacity to be considered is .001 microfarad while the smallest capacity is .00025 microfarad. The curve of Fig. 5 is laid out to show the effect of changing the condenser capacity with a coil two inches in diameter. The vertical scale is again laid off to take care of the maximum number of turns on a two-inch coil, this being shown as 150 turns in the table.

It is not necessary that the lower left hand corner of the graph, or that any other part of the graph show zero value. It is only necessary that the total width and height of the graph take in the whole range of values to be considered. On the horizontal scale it is then necessary to include capacities between .001 and .00025, but it is not necessary to go either above or below these capacities. Therefore the horizontal scale starts in with .001 microfarad near the left hand side and goes only a little ways beyond .00025 microfarad at the right.

From the table it is found that a .001 microfarad condenser calls for 48 turns. Therefore, a point is marked on the graph at the intersection of the lines for .001 capacity and for 48 turns. The .0005 condenser calls for 84 turns so the second point is laid off at the intersection of .0005 microfarad capacity and 84 turns. This is continued for all other values given by the table. A smooth curve drawn through all these points shows the relation between the number of turns required on a coil of given diameter and the capacity of the tuning condenser.

Here again it is possible to learn values that are not given in the table from which the graph of Fig. 5 was prepared. Supposing a tuning condenser of .0004 microfarad capacity were available. Following up on the vertical line from this capacity to its intersection with the curve, and then from this intersection over to the scale for number of turns required it is seen that the two-inch diameter coil with the .0004 microfarad capacity condenser would need about 102 turns.

Curves are of the greatest value in all work such as done in radio and since they are really so simple and easy to understand they form one of the best possible ways of showing effects and causes in their relation to one another.

GRAPHITE.—See *Carbon*.

GREEK ALPHABET.—See *Symbols*.

GRID.—See *Tube, Action of*; also *Tube, Design of*.

GRID BIAS.—See *Bias, Grid*.

GRID CIRCUIT.—See *Circuit, Grid*.

GRID CONDENSER.—See *Detector, with Grid Condenser and Leak*.

GRID CURRENT.—See *Current, Grid*; also *Tube, Characteristics of*.

GRID CURRENT RECTIFICATION.—See *Detector, with Grid Condenser and Leak*.

GRID LEAK.—See *Detector, with Grid Condenser and Leak*; also *Leak, Grid*.

GRID MODULATION

GRID MODULATION.—See *Modulation*.

GRID-PLATE CAPACITY.—See *Tube, Capacities, Internal*.

GRID RESISTANCE.—See *Tube, Input Resistance and Impedance of*.

GRID RETURN.—See *Circuit, Grid; Return, Grid and Bias, Grid*.

GRID VARIOMETER.—See *Regeneration, Methods of Obtaining*.

GRID VOLTAGE, EFFECT IN TUBE.—See *Tube, Characteristics of*.

GRID WINDING.—See *Winding, Grid*.

GRIMES RECEIVER.—One type of reflex receiver. See *Reflexing, Principles of*.

GROUND, RECEIVER.—It is often found that a receiver connected to an antenna that has been constructed with high regard for all the rules is connected to a ground that is little better than nothing at all. The signals are received by both antenna and ground, which act together as the upper and lower plates of a condenser with the air between them for a dielectric. Nobody would think of using a tuning condenser with half of its plates perfectly built and insulated and with the other half thrown together in any kind of a haphazard way. Yet this is just what is being done when a receiver is connected between an excellent antenna and a defective ground.

The plates of any condenser must be made of a conductor. Therefore, the ground plate of the antenna condenser must be a conductor. Dry earth is not a good conductor. So the ground connection must be carried down to soil that is always moist. There are various ways of accomplishing this.

The most commonly used of all methods is to connect the ground lead to a cold water pipe as in Fig. 1. This generally forms an excellent ground because the water pipes run down deep under the surface and soil around them is generally moist because of leakage from the pipes themselves. If a water meter is in the system, the ground connection should be made on the street side of the meter. This is to avoid the resistance of any joints in the meter. For a similar reason, to avoid joint resistance, the ground connection should not be made to hot water pipes, to a radiator or to gas pipes.

If no water piping is available a long pipe or metal rod may be driven into the ground until its lower end is at least five or six feet below the surface. Also a metal plate of any kind may be buried in moist earth as in Fig. 2. Before either the pipe or the plate is put in place, a spot on its surface is thoroughly cleaned and one end of the ground lead is soldered to it.

Twenty or thirty feet of bare wire may be laid in the bed of a convenient small stream or lowered into a well. A cistern built inside of a building is often insulated by its own construction and a wire or plate put into a cistern may not make a ground connection.

Nothing will tell what available method may make the most effective ground, therefore, it is best to try everything within reach, retaining the connection that gives the best reception under all conditions. All conditions are men-

GROUND, RECEIVER

tioned because ground that is moist in the winter and spring may become dry during the summer and fall seasons. If no connection to permanently moist earth can be secured it will be best to build a counterpoise. See *Counterpoise*.

Ground Lead.—The connection from the ground binding post of the receiver to the pipe, plate or other object used for the ground itself is called the ground lead. Its importance is comparable with the importance of the antenna lead-in. Both must be given careful consideration.

The ground lead should, first of all, be as short as possible. It should be made of insulated copper wire, not smaller than number 14 gauge. Larger wire is still better. Every joint, from the receiver to the ground or the ground clamp, must be soldered and soldered well.

When making connections to cold water pipes and to other large bodies of metal it is not possible to solder the end of a ground lead directly to the pipe or metal because the large surface will carry the heat away faster than the soldering iron can apply it. This difficulty is overcome by using a ground clamp.

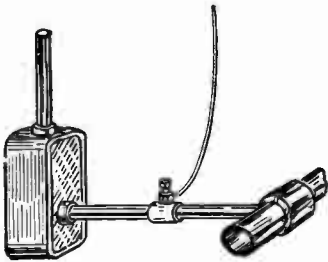

FIG. 1.—Cold Water Pipe Receiver Ground.

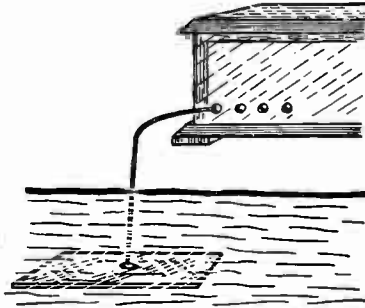

FIG. 2.—Buried Metal Plate for Receiver Ground.

A ground clamp should be sturdily made. It must have provision for making a permanently tight metallic connection with the pipe to which it is attached. As a general rule this kind of a contact is secured by providing the ground clamp with a pointed screw or corrugated grip that is made to dig into the metal of the pipe or other object so that all dirt is forced out and kept out.

The end of the ground lead must be soldered, not screwed or clamped, to the ground clamp. Ground clamps must always be used when a connection is made in damp locations where corrosion is sure to affect any kind of a joint except one that is properly soldered.

Ground Condenser.—Danger of accidental burning out of tube filaments may be greatly reduced by connecting a fixed condenser of one microfarad capacity between the ground terminal of the receiver and any wires in the receiver which would normally connect directly to the ground terminal. Any receiver may be thus re-modeled by disconnecting all wires attached to the ground terminal, connecting one side of the condenser to this terminal and then connecting the wires to the other side of the condenser as in Fig. 3. A

GROUND, RECEIVER

condenser of such large capacity will not affect the tuning in any way nor will it tend to upset the effect of any balancing scheme employed.

Without such a condenser in the ground lead it is quite possible to make a connection from the receiver's filament circuit to the

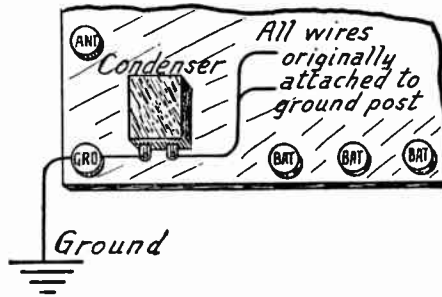

FIG. 3.—Connection of Ground Condenser.

power or light circuit of the building should some types of power supply units be used. With battery chargers utilizing an auto-transformer the tube filaments would be burned out should the receiver switch be turned on with the charger in operation.

GROUND CLAMP.—See *Clamp, Ground*.

GROUND SWITCH.—See *Switch, Grounding*.

GUTTA PERCHA.—A natural gum obtained from certain trees. It is very similar to rubber in all respects and is used principally as insulation for wires and cables.

H

h.—A symbol for henries of inductance.

H.—A symbol for magnetic field intensity.

HACK SAW.—See *Tools*.

HALF WAVE RECTIFIER.—See *Rectifier, Half Wave*.

HAMMER.—See *Tools*.

HARD RUBBER.—See *Rubber, Hard*.

HARD TUBE.—See *Tube, Hard*.

HARMONIC.—A harmonic is a frequency which is a multiple of another frequency. The first frequency is called the fundamental frequency. A frequency twice as great is called the second harmonic, one three times as great is the third harmonic, one four times as great is called the fourth harmonic, and so on.

Starting with a fundamental frequency of 600,000 cycles or 600 kilocycles, for an example, its second harmonic would be 1,200,000 cycles or 1200 kilocycles. Its third harmonic would be three times the fundamental, or 1800 kilocycles, the fourth harmonic being four times the fundamental of 2400 kilocycles.

In music, harmonics are desired since they make the tone difference between two different instruments sounding the same note. A certain note struck on a piano sounds different from the same note on a violin, yet the fundamental frequency is the same for both. The piano produces one series of harmonics along with the fundamental while the violin produces a different series of harmonics, thus making its note differ from that of the piano. Musical harmonics are called overtones.

In broadcasting it is desired that the transmitter send out a carrier wave of a fundamental frequency only. No harmonics are desired, in fact they are very harmful since they too are transmitted and may be received if sufficiently strong. A loosely coupled and properly controlled transmitter will not emit harmonics.

Taking the series of harmonics of the fundamental frequency of 600 kilocycles mentioned in a foregoing paragraph, it is interesting to trace the frequencies and wavelengths of the several harmonics. The second harmonic of 1200 kilocycles corresponds to 250 meters wavelength while the fundamental frequency of 600 kilocycles corresponds to 500 meters wavelength. The third harmonic of 1800 kilocycles forms a wavelength of 166.6 meters. The fourth harmonic of 2400 kilocycles is at a wavelength of 125 meters while a fifth harmonic of 3000 kilocycles would have a wavelength of 100 meters. In each case the approximate wavelength is found by dividing 300,000,000 by the frequency in cycles or by dividing 300,000, by the frequency in kilocycles. See also *Sound*.

HEADPHONE.—See *Phone, Head*.

HEAT.—See *Temperature, Scales of*.

HEAVISIDE LAYER THEORY.—See *Fading*.

HELIX.—A coil which is wound in spiral form is called a helix. See *Coil, Solenoid*.

HENRY.—The henry is the unit of inductance. If a current which is changing its flow at the rate of one ampere per second induces an electromotive force of one volt in a circuit that circuit

HETERODYNE

has an inductance of one henry. The henry is a rather large unit for use in radio. The inductance of iron-core coils used in this work is generally measured in millihenries. A millihenry is the one thousandth part of a henry. The inductance of air-core radio coils is generally measured in microhenries. One microhenry is the one millionth part of a henry.

HETERODYNE.—When currents of two different frequencies flow in the same circuit they will produce a new frequency which is equal either to the difference between the first two frequencies or is equal to the sum of the first two frequencies. When two different frequencies combine in this way to produce a new frequency they are said to heterodyne and the new frequency is called a heterodyne frequency. This is the principle upon which is based the action of the superheterodyne receiver. See also *Beats, Formation of*.

HIGH FREQUENCY.—See *Frequency, High*.

HIGH FREQUENCY BUZZER.—See *Oscillator, Buzzer Type*.

HIGH FREQUENCY CURRENT.—See *Current, High Frequency*.

HIGH FREQUENCY GENERATOR.—See *Oscillator*.

HIGH FREQUENCY RESISTANCE.—See *Resistance, High Frequency*.

HIGH MU TUBE.—See *Tube, Amplification of*.

HIGH PASS FILTER.—See *Filter, High Pass Type*.

HONEYCOMB COIL.—See *Coil, Honeycomb*.

HOOK-UP.—The method of connection between the various units which compose a radio receiver is called the hook-up of that receiver. This word is also applied to the diagram of connections used. The principle upon which the receiver action is based is often spoken of as the hook-up of the receiver; for example, a Neutrodyne receiver may be said to use a Neutrodyne hook-up.

HORN.—See *Speaker, Loud*.

HOT WIRE METER.—See *Meters, Ampere and Volt*.

HOWLING.—See *Noise*; also *Oscillation*.

HUM, REMEDIES FOR.—See *Trouble, Receiver and Power Unit*.

HYDROMETER.—See *Battery, Storage Type*.

HYSTERESIS.—When current commences to flow around the winding of an electromagnet the magnetism and the electromagnetic field do not appear in their full strength instantaneously but require a short time to rise from zero to maximum value. When the flow of current in the winding is stopped the magnetism and the electromagnetic field die away to zero but the speed with which this dying away takes place is less than the speed with which the magnetism built up. In other words there is a lag in completely demagnetizing the iron core of a magnet. This lag is called magnetic hysteresis. This lagging is caused by the residual magnetism which remains in the iron and must be destroyed.

HYSTERESIS

When an alternating electromotive force is applied to a dielectric between the plates of a condenser there is a lag in the dying away of the electrostatic field in the dielectric. This action is similar to the lag in the magnetic field of a magnet, and is called dielectric hysteresis.

I

i.—The symbol for current (instantaneous value) in amperes, etc.

I.—The symbol for electric current or for amperage (effective value). See *Current*.

I. C. W.—An abbreviation for interrupted continuous wave. See *Wave, Interrupted Continuous*.

IMPACT EXCITATION.—See *Selectivity*.

IMPEDANCE.—Impedance is the effective resistance or opposition to flow of current in an alternating current circuit when this circuit contains, in addition to ohmic resistance, inductance, capacity or both. Impedance is measured in ohms. The impedance of a circuit is the combination of the circuit's reactances and its resistance, but the impedance is not equal to the sum of the reactances and the resistance, both of which are also measured in ohms.

The total impedance in ohms bears the same relation to ohmic resistance and reactance that is borne by the hypotenuse of a right angled triangle to the two sides of the triangle. The square of the hypotenuse, representing the impedance, is equal to the sum of the squares of the other two sides which represent respectively the ohmic resistance and the net reactance.

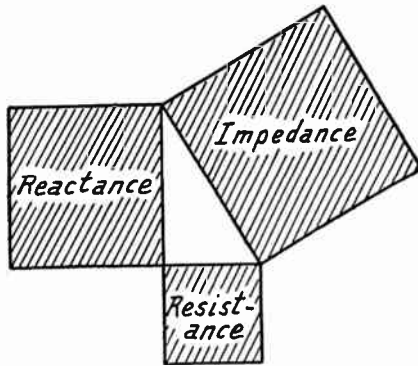

Relation of Impedance to Reactance and Resistance of a Circuit.

The impedance is equal to the square root of the sums of the squares of the resistance and the effective reactance. This is shown by the following formula:

$$\text{Impedance} = \sqrt{(\text{Ohmic Resistance})^2 + (\text{Effective Reactance})^2}$$

If the circuit contains only resistance and inductance the impedance is found by using the number of ohms resistance and the number of ohms inductive reactance, in the foregoing formula as shown.

IMPEDANCE, COUPLING BY

If the circuit contains only resistance and capacity the impedance is found from the ohms of resistance and the ohms of capacitive reactance, these values being used in the formula.

But if the circuit contains both inductance and capacity in addition to the resistance it is necessary to first compute the effective reactance of the inductance and capacity together. This net value of the total reactance is then used in the foregoing formula.

With both inductance and capacity in a circuit the tendency is for them to balance each other and the net reactance is the difference between the two reactances. If the inductive reactance is the greater, as is usually the case, the capacitive reactance is subtracted from it. If the capacitive reactance is greater than the inductive reactance then the inductive is subtracted from the capacitive reactance to obtain the net or effective reactance. See *Reactance*.

The current in amperes which flows in an alternating current circuit is equal to the number of volts divided by the number of ohms impedance, thus:

$$\text{Amperes} = \frac{\text{Volts}}{\text{Impedance}}$$

IMPEDANCE, COUPLING BY.—See *Amplifier, Audio Frequency, Impedance Coupled*.

IMPEDANCE, MATCHING OF.—Any electrical device which produces or delivers power, such as a vacuum tube, will put forth the greatest effort and will deliver the greatest possible power when the impedance of whatever unit forms the external load is at least equal to the internal impedance of the source of power, the tube in this case.

In the earlier days of radio reception little if any attention was paid to this subject of matching impedances. The results were manifested in poor performance.

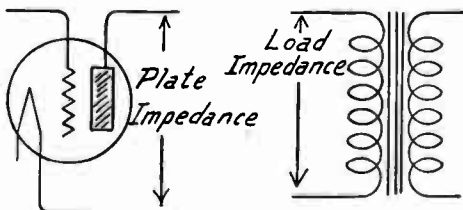

FIG. 1.—Impedances of Plate Circuit and of Load.

The principal concern in this matter of matching impedances is to obtain a balance between the plate impedance of a tube and the impedance of whatever unit is connected as a load in the external plate circuit. These impedances are shown in Fig. 1. The plate of a tube may be connected to any form of coupler such as an audio frequency transformer, an audio frequency impedance or an audio frequency resistance coupler. The plate circuit of the tube may also be connected to a loud speaker, to a pair of headphones or to a coupling transformer for a loud speaker. In any of these cases the impedance of the plate circuit in the tube, measured in ohms,

IMPEDANCE, MATCHING OF

should be equalled or exceeded by the impedance of the coupling device or speaker.

To attain this object is not quite so easy as it sounds because the impedance of the winding in any transformer, in any loud speaker, or in any other unit containing inductance or capacity changes with every change of frequency. The higher the frequency the higher becomes the impedance of a transformer, a choke or a speaker in which inductance is the chief factor in its impedance.

The impedance in the tube is composed principally of the resistance between plate and filament. In tables of tube characteristics it is the plate resistance which is usually specified and for the work of matching impedances sufficient accuracy will be obtained by matching the impedance of the load with the plate resistance of the tube, both being measured in ohms. In the following paragraphs the plate resistance will be spoken of as representing the plate impedance.

The impedance of the external load changes greatly with change of the frequency being handled but there is comparatively little change of the tube resistance with change of frequency. Therefore, it is impossible to match the load impedance with the plate resistance at all frequencies. The parts of the audio frequency range which are used the most run between 100 cycles and 3000 cycles. The impedance match may be made at a medium frequency, say around 1000 to 1200 cycles, and the results at lower and higher frequencies left to care for themselves. This is the most economical method because it allows the use of small inductance in the external load but it is not the most satisfactory.

Better all around results will be had by matching the impedance and resistance at much lower frequencies. This will call for a larger inductance in whatever unit follows the tube. At higher frequencies the impedance in the load will then be two, three or four times the resistance of the tube but this is an advantage rather than a disadvantage.

The plate resistance of a tube is changed by changes in the plate voltage or B-battery voltage. For example, a certain amplifying tube has a plate resistance of 5500 ohms with 135 volts on the plate, while with only 90 volts on the plate the resistance rises to 8800 ohms. It is generally quite easy to learn from information published by tube manufacturers the resistance of their various tubes with different plate voltages. Such information is given under *Tube, Amplifying Types of*. It is not always easy to learn the impedance of the windings in loud speakers, amplifying transformers and chokes.

It has just been stated that the impedance of the load should at least equal the resistance of the tubes. If there is any difference, the load impedance should be greater than the tube resistance, even up to double the value. Since the impedance of a speaker, choke or transformer becomes less at lower frequencies it follows that an insufficient amount of impedance causes these units to lose the low notes. For this reason it is best to use a speaker, choke or transformer whose impedance is equal to the resistance of the tube at the frequency of the lowest notes or tones to be reproduced. Of course, this would call for an impedance higher than provided in the great majority of coupling units.

Tube Resistances.—Starting with the smallest vacuum tubes, those employed with dry batteries for their filament current, we find plate resistances averaging around 15,000 ohms with 90 volts on the plate. The storage battery types of amplifying tubes which use one-quarter ampere for filament current and which were in almost universal use at one time, have an average plate resistance of around 11,000 to 12,000 ohms with 90 volts applied to the plate.

IMPEDANCE, MATCHING OF

The semi-power tubes, taking one-half ampere of filament current and operating with storage batteries, as a source of filament supply, have plate resistances of from 5000 to 9000 ohms with plate voltages between 160 and 90 volts respectively. More recent types of power tubes using up to 180 volts on the plate with a high biasing voltage have a low resistance of around 2000 ohms.

The lower the plate resistance of a tube the greater will be the flow of current in its plate circuit. The low resistance offers less opposition to the flow of current and the high plate voltage which is used in obtaining this low resistance acts to force still more current through the circuit. Dry battery tubes will not deliver more than five or six thousandths of a watt in power while the tube having a plate resistance of around 2200 ohms will deliver almost three-quarters of a watt of power, more than one hundred times as much as the power obtained from the dry cell tube. Yet many will try to force a dry cell tube to operate a loud speaker with the same volume that may be obtained with the best power tubes.

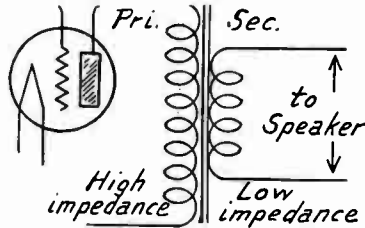

FIG. 2.—Matching Impedances with Special Transformer.

Regardless of the amount of power in watts that is put out by the tube, the advantages of this power cannot possibly be obtained unless it is given something to work upon. The impedance of whatever unit follows the tube must be high enough to consume almost all the power a tube is capable of delivering.

In a transformer it is only the power which is used up in the primary that is passed on into the secondary or the output circuit of the transformer. In a loud speaker it is only the power which is used up in the windings which reappears as energy to operate the speaker's diaphragm and produce sound. If a speaker or a transformer has so little impedance that power is not absorbed, then no energy can reappear.

Coupling Transformers for Loud Speakers.—When impedances of tubes and speakers cannot be properly matched by selection of suitable units, a match may be obtained by using an output transformer which is designed to have a primary impedance matching the tube resistance and a secondary impedance matching that of the speaker.

Thus, should it be desired to use a high resistance tube with a low impedance speaker the coupling transformer between them would require a high primary impedance and a low secondary im-

IMPEDANCE, MATCHING OF

pedance. In other words, the transformer would have a step-down voltage ratio as in Fig. 2. The voltage from the secondary would be less than the voltage into the primary, the power remaining about the same since power is a product of voltage and current.

If it is necessary to use a low resistance tube with a high impedance speaker the transformer characteristics would have to be reversed. That is to say, the transformer would have a small primary and a large secondary, thus producing a step-up of voltage and a reduction of current.

Impedance Match for Detector.—The matching of impedances is important not only in the output stage of a receiver but in all other stages as well. There is almost as much advantage in matching the plate resistance of the detector tube with a proper impedance in the transformer, choke or coupling resistance which follows the detector as there is in matching the resistance of the last audio tube by proper impedance in the loud speaker.

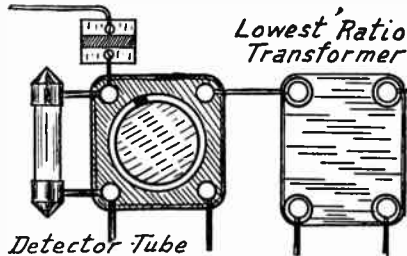

FIG. 3.—High Impedance Couplers Should Follow the Detector for Matching.

Most tubes used as detectors have a high plate resistance. This is due partly to the fact that the detector tube almost always operates with a low plate voltage. Furthermore, the detector is not a power tube but is a tube designed for voltage amplification. The plate resistance of an average detector tube is in the neighborhood of 16,000 ohms. Therefore, the detector should be connected to high impedance. If it is connected to a transformer, this transformer should have a large primary winding and will probably be a low ratio unit as in Fig. 3. If the detector is connected to an amplifying choke or impedance coil this coil should have a large number of turns and consequent high impedance. Likewise, a coupling resistance should be proportionately high when it follows the detector.

Impedance Matching Transformers.—The turns ratio for an impedance matching transformer may be determined from the following formula:

$$\text{Turns Ratio} = \sqrt{\frac{\text{plate resistance of preceding tube}}{\text{input impedance of following unit}}}$$

This formula is presumed to be used in determining the turns ratio of a transformer used to couple the plate circuit of a radio tube to some kind of load such as furnished, for example, by the

IMPEDANCE, PLATE

windings in a loud speaker. The plate resistance and the input impedance are to be measured in ohms.

The plate resistance of the tube is specified rather than its plate impedance because the resistance is a factor generally known from the published specifications of the tube and the resistance is near enough like the impedance so that the result of the calculation will be fairly accurate. The input impedance of the load is to be taken under working conditions. The impedance of loud speaker windings may generally be learned from published specifications. Many loud speakers contain transformers in which the primary impedance is already matched to the plate resistance of tubes usually employed. The formula determines only the ratio of the turns on the primary to the turns on the secondary winding.

The impedance should be as great as possible in both the primary and secondary of the transformer while remaining within the proper limits of turns ratio. The higher the primary impedance, the greater will be the proportion of the tube's power used in the transformer and the less will disappear in the tube itself. The higher the secondary impedance, the less will be its short-circuiting or bypassing effect on the input circuit of the following unit and the greater will be the power delivered into that unit.

The unit connected to the primary side of an impedance matching transformer is called the source and the part connected to the secondary is called the load or the sink. The purpose of the transformer is to make the impedance of the load appear equal to that of the source when looking from the source and to make the impedance of the source appear equal to that of the load when looking from the load. This relationship insures the optimum transfer of power between source and load.

It is allowable to use more than one transformer in securing the correct matching of impedances. For example, many dynamic loud speakers have incorporated in themselves a coupling transformer designed to match a tube having about 5000 ohms plate resistance. The transformer then has a primary to match an impedance of 5000 ohms and a secondary to match an impedance of about eight ohms for the average moving coil.

If a power tube is used in which the plate resistance is 2000 ohms a match may be secured with a second transformer between the tube and the transformer in the speaker. The second transformer will have a primary impedance to match 2000 ohms and a secondary impedance to match 5000 ohms with a turns ratio of about 63 to 100.

In practice the matching of impedances is often far from exact yet the results will be quite satisfactory to the average ear. A match within twenty per cent either way is usually passable. Preference is given to an impedance which is higher instead of lower than the plate resistance for the winding in the tube's plate circuit.

Radio Frequency Stages.—The matching of impedances in a radio frequency amplifier is almost impossible since the primary circuit of a radio frequency transformer cannot possibly be built with an impedance even approaching the resistance of the tube from whose plate circuit it is supplied. This is one of the reasons why radio frequency amplifiers are so remarkably inefficient.

For methods of comparing impedances see *Oscillator, Radio Frequency, Uses of*.

IMPEDANCE, PLATE.—See *Tube, Output Resistance and Impedance of*.

IMPEDANCE, TUBE

IMPEDANCE, TUBE.—See *Tube, Output Resistance and Impedance of*; also *Tube, Input Resistance and Impedance of*.

IMPULSE.—Any force acting during a short time is called an impulse. For example, a momentary rise of voltage would be called a voltage impulse.

IMPULSE EXCITATION.—See *Selectivity*.

INDICATOR, RESONANCE.—See *Meter, Frequency*.

INDOOR ANTENNA.—See *Antenna, Indoor Type of*.

INDUCTANCE.—Any change of current, either a rise or fall, in an electric circuit will cause the generation of an electromotive force or voltage in that circuit or in any nearby circuit. The property of a circuit which enables it to exercise this power is called inductance. The greater the ability of the circuit to cause voltages in itself or in neighboring circuits the greater is its inductance.

Inductance is measured in the unit called a henry or in millihenries or microhenries which are respectively the one-thousandth part and the one-millionth part of a henry. See *Coil, Inductance of*, for the factors which affect this property of a circuit and for its calculation.

Forming a conductor into a coil, turning it back upon itself many times, greatly increases the inductance. Because of this faculty of coils they are generally used when it is desired to obtain a maximum of inductance in a minimum of space. A coil used because of its property of inductance is sometimes called an inductance, although it is more properly called an inductor.

If the inductance in a circuit or in a coil causes the rise and fall of current to produce a voltage in the same circuit it is called self-inductance. The voltage produced by self-inductance has a polarity which acts against the polarity which is causing the flow of current in the circuit. That is, the voltage of self-inductance or the self-induced voltage opposes the original voltage in the coil or circuit and thereby opposes the change in flow of current. If the current is increasing, the induced voltage opposes this increase. When the current is decreasing the induced voltage opposes the decrease, that is, tends to keep the current flowing.

When the inductance in a circuit or a coil produces an electromagnetic field around the circuit or coil this electromagnetic field may pass through nearby circuits or other coils and will cause an electromotive force or voltage to appear in these nearby circuits. This is called mutual inductance. It is this property of mutual inductance that is used to obtain coupling between the primary and secondary windings of transformers. See also *Induction*.

The inductance of an oscillatory circuit at resonance may be expressed in terms of the capacity in the circuit and the frequency of resonance. The formula is as follows:

$$\text{Inductance} = \frac{(159.17 \div \text{Frequency})^2}{\text{Capacity}}$$

The inductance is in microhenries, the capacity in microfarads and the frequency in kilocycles.

Should the inductance be measured in henries, the capacity in farads and the frequency in cycles, the formula becomes:

$$\text{Inductance} = \frac{(0.15917 \div \text{Frequency})^2}{\text{Capacity}}$$

INDUCTANCE, ANTENNA

INDUCTANCE, ANTENNA.—See *Antenna, Capacity and Inductance of.*

INDUCTANCE, EFFECTIVE.—See *Coil, Inductance of.*

INDUCTANCE, MATCHING OF IN COILS.—See *Oscillator, Radio Frequency, Uses of.*

INDUCTANCE, MEASUREMENT OF.—See *Bridge, Measurements by; also Meters, Frequency, Capacity and Inductance Measurements with.*

INDUCTANCE, MUTUAL.—Mutual inductance is the property of a circuit or a coil whereby it is enabled to produce voltage in another nearby circuit or coil whenever there is a change of current, either a rise or fall, in the first circuit. If the neighboring circuit is a closed circuit a flow of current will take place in it because of the voltage set up by mutual inductance.

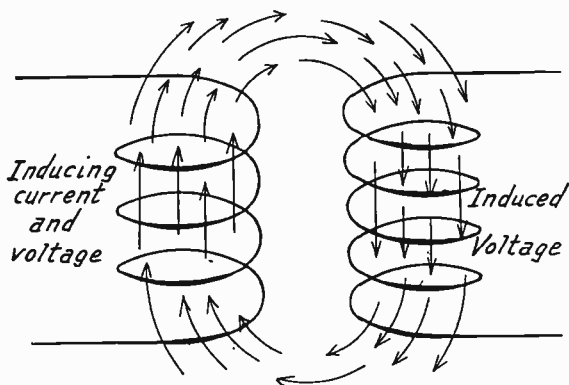

Mutual Inductance between Two Windings.

The induced voltage is produced in the second circuit or coil whenever current in the first one starts to flow, ceases to flow, changes its rate of flow, or changes its direction of flow. It may be said that any change whatsoever in the current of the first coil will, by means of mutual inductance, produce a voltage in the second coil. The intensity of the voltage induced depends on and is proportional to the rate at which current changes take place in the first coil. The greater the frequency the more rapid is the change of current and the greater will be the induced voltage. The greater the amplitude or rise and fall of current in the first coil with a given frequency the greater will be its rate of change and the higher will be the induced voltage.

Two coils may be placed with reference to each other so that a part of the electromagnetic field of one coil passes through or cuts through the conductors forming the other coil. Then as the electromagnetic field rises and falls, there is mutual inductance between the coils and they are said to be coupled. See *Coupling.*

INDUCTANCE, RESONANCE VALUES OF

The value of the mutual inductance is represented by the symbol M . The mutual inductance, or M , depends upon the size of the two coils, their distance apart and the angle which their axes make. The value of M is also affected by the induced voltage. The larger the coils the greater their mutual inductance. The closer they are to each other the greater their mutual inductance. And the more nearly their axes coincide the greater is the mutual inductance.

The calculation of mutual inductance when taking into account all of the foregoing factors is rather complicated, involving the use of logarithms to a considerable extent.

The inductive effect of the two coils on each other is called the coefficient of coupling and is usually represented by K . The value of K changes as the coils are moved with reference to each other, whether this movement changes their distance apart or whether it changes the angle of their axes. The value of K also depends on the sizes of the two coils, on their diameter and on their length.

The percentage changes of mutual inductance or coupling between two coils as they have their axes inclined to each other and also as they are moved lengthwise away from each other are given under the heading, *Coupling, Coefficient of*.

See also *Induction, Electromagnetic*.

INDUCTANCE, RESONANCE VALUES OF.—See *Resonance, Inductance-Capacity, Values for*.

INDUCTANCE, SELF.—The property which is called self-inductance causes the generation of a second electromotive force or voltage in any circuit whose current is changing its rate of flow. The flow of current in the circuit may be starting and then increasing, or it may be decreasing and coming to a stop, or it may be changing its direction of flow. Of course, there is a voltage being

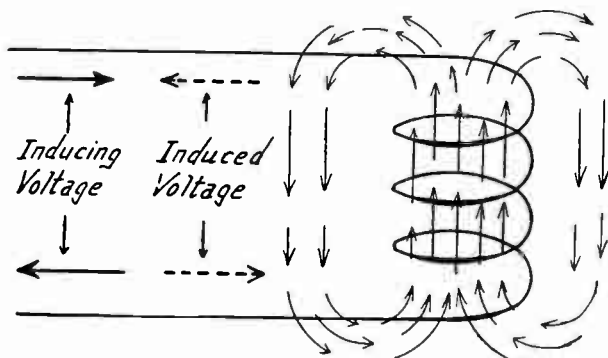

FIG. 1.—Effect of Self-Inductance in a Coil.

applied to the circuit in order to cause the flow of current, but the current itself causes a second and different voltage to appear. The ability of the circuit to generate this second induced current in itself is called the circuit's self-inductance or simply its inductance in most cases. The self-induced voltage is called counter electromotive force.

The induced voltage tries to prevent the current from doing whatever it may be doing at the time. If the current is on the increase.

INDUCTANCE, SELF-

the induced voltage tries to hold it back, tries to prevent its increase. If the current is already decreasing, then the induced voltage tries to keep it going, tries to keep it from decreasing.

Since self-inductance is an effect that a circuit has upon itself, the effect is greatly increased by turning the circuit around and around on itself; in other words winding the circuit into a coil. Whenever self-inductance is desired, coils are used to obtain it in a lumped form.

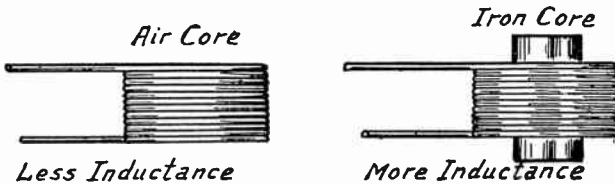

FIG. 2.—Iron Core for Increase of Self-Inductance.

Inductance in electricity is like inertia or momentum in mechanics. Adding inductance to an electric circuit is like adding weight to a pendulum; the weight prolongs the swings of the pendulum and makes them persist, while the inductance keeps the swings of electric current or the oscillations more persistent.

The energy which goes into a coil in the form of voltage and current reappears in the form of a magnetic field around the coil. The lines of force which form this magnetic field travel around through the center of the coil and the space around the outside of the coil. As soon as these magnetic lines of force have risen to their maximum they then start to collapse. If but few of them have been lost in the process and if nearly all collapse back into the coil, most of the original energy or voltage and current reappears in the windings of the coil.

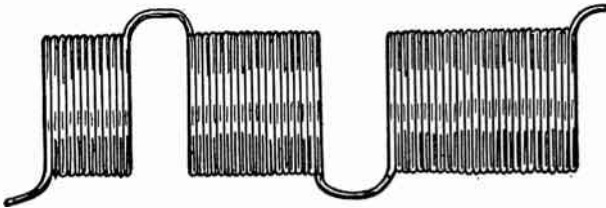

FIG. 3.—Inductance Coils in Series.

If it is easy for the magnetic lines to travel through the field then there is little loss and the coil will have great self-inductance. But if there is a great loss in the magnetic lines while they are in the field of the coil, then the self-inductance will be reduced.

The difficulty with which magnetic lines of force travel through any substance is called the reluctance of that substance. Reluctance is magnetic resistance. Anything that reduces the reluctance of the magnetic field will increase the inductance of the coil and anything that increases the reluctance of the field space will decrease the inductance. Iron has only a small fraction of the reluctance possessed by air, so making the core of the coil from iron as in Fig. 2 increases the inductance by decreasing the reluctance of the magnetic path.

INDUCTANCE, SELF-

Shortening the magnetic path, decreasing the size of the field of the coil, will also reduce the reluctance and give the coil greater self-inductance.

For the calculation of self-inductance in coils, see *Coil, Inductance of*.

Inductances in Series and Parallel.—Coils connected in series as in Fig. 3 simply add their self-inductances together. Three coils, having inductances of 100, 150 and 200 microhenries, would have a combined inductance when connected in series of 100 plus 150 plus 200, or 450 microhenries.

This adding together of the inductances of coils in series applies in the manner just stated when the coils are so far apart in space or are placed at such angles with each other that they have no magnetic coupling. Should there be magnetic coupling the effect of the mutual-inductance will be added to the self-inductances and the total will be greater than the sum of the self-inductances only.

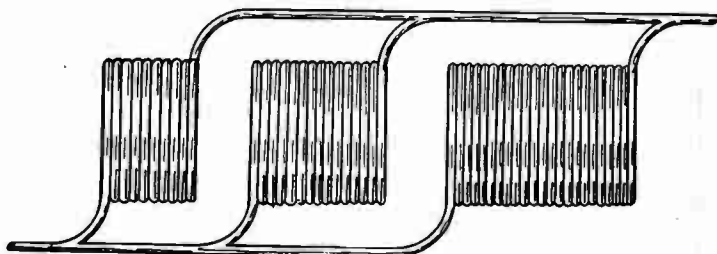

FIG. 4.—Inductance Coils in Parallel.

When coils are connected in parallel with each other as in Fig. 4 their combined inductance cannot be found by simply adding the separate inductances. The sum of the reciprocals of the separate inductances is equal to the reciprocal of the combined inductance. A reciprocal of any number is 1 divided by that number. The formula is as follows:

$$\frac{1}{L_t} = \frac{1}{L_a} + \frac{1}{L_b} + \frac{1}{L_c}, \text{ etc.}$$

When L_t is the total inductance of all coils in parallel, L_a , L_b , L_c , etc., are the separate inductances of the separate coils.

If the separate inductances are in microhenries, the total will be in microhenries, if the separate inductances are in henries the total will likewise be in henries.

Again taking the three coils whose separate self-inductances are 100, 150 and 200 microhenries; their combined self-inductance would be found as follows:

$$\frac{1}{\text{Total Inductance}} = \frac{1}{100} + \frac{1}{150} + \frac{1}{200} = \frac{13}{600}$$

The total inductance is then $600/13$ microhenries or approximately 46.15 microhenries. The combined self-inductance of coils in parallel will always be less than the smallest separate self-inductance of any one coil.

See also *Induction, Electromagnetic*.

INDUCTANCE, SWITCH FOR

INDUCTANCE, SWITCH FOR.—See *Switch, Tap*.

INDUCTANCE, UNITS OF.—The standard unit of inductance, whether of self-inductance or mutual-inductance, is the henry. One henry is the inductance of a circuit when one volt electromotive force is produced by a current changing at the rate of one ampere per second.

Except for the larger sizes of iron-core coils, the henry is a larger unit than is convenient to use. Therefore, most radio inductances are measured in millihenries and microhenries. One millihenry is one thousandth of a henry. One microhenry is one millionth of a henry.

INDUCTANCE, VARIOMETER FOR.—See *Variometer, Coupling with*.

INDUCTION.—Induction is the action by means of which an electric force is produced in a conductor by an electric field. The electric force produced may be an electromotive force or voltage in a conductor, it may be a charge on a condenser plate or it may be magnetism in a magnet. The field may be composed of lines of force about a conductor, of electrostatic lines of force about a charged body, or of magnetic lines of force about a magnet.

Induction is the act itself while inductance is the ability or property of a circuit to produce induction.

INDUCTION, ELECTROMAGNETIC.—A voltage and current may be produced in a conductor whenever it is cut by or is itself cutting through lines of force which are coming from a magnet, from a coil acting as a magnet, or from another conductor. The act of producing voltage and current in a conductor by any of these means is called electromagnetic induction.

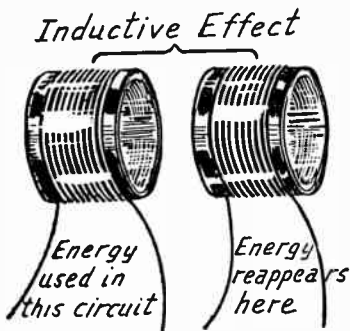

Energy Transfer by Electromagnetic Induction.

If the induction is brought about by the magnetic field around a conductor or coil, the voltage and current which are induced may be set up either in the conductor or coil having the field or in any other nearby conductor or circuit. If the induced voltage is in the same conductor whose field causes the induction, the action is called self-induction. If the voltage is induced in a nearby circuit the action is called mutual-induction.

Whenever there is any change of current in a conductor that change causes lines of force to appear around the conductor. As these lines arise out of the conductor and fall back into it they, of course, move. And in moving thus, either through the conductor itself or through any nearby conductor, they set up an induced voltage either in the same conductor which is carrying the current changes or in a neighboring conductor. Any movement of

INDUCTION, ELECTROSTATIC

lines of force through a conductor induces a voltage in that conductor.

Naturally enough, the same effect may be secured if the lines of force stand still and the conductor is moved through them. This is simply another way of making the lines of force and the conductor cut each other.

The intensity of the induced voltage and current depends on the rate at which the conductor cuts lines of force or on the rate at which lines of force cut through the conductor. The cutting of 100,000,000 lines of force in one second produces an electromotive force of one volt in the conductor.

The direction or polarity of the induced voltage is always such that it tends to retard or oppose the motion which produces it. This motion may be of the lines of force through the conductor or may be of the conductor through the lines of force, but the induced voltage always acts to retard this motion. See *Inductance, Self*.

Electromagnetic induction is one of the most important actions in the whole field of practical electricity, whether it is used to set up voltages in a radio coil or to operate the motors of an electric locomotive.

As utilized in radio receivers, electromagnetic induction may be considered as the action which produces a voltage and current in one conductor or coil when there is any change in the amount of current flowing either in the same circuit or in a nearby circuit.

INDUCTION, ELECTROSTATIC.—If any conductor is given a charge of electricity, of static electricity, and is then brought near another conductor, there will be two equal and opposite charges induced on the other conductor. On the part of the second conductor which is nearest the first one, there will be induced a charge of opposite polarity from the first one. And on the part of the second conductor which is farthest from the first one will be induced a charge of the same polarity as the first charge.

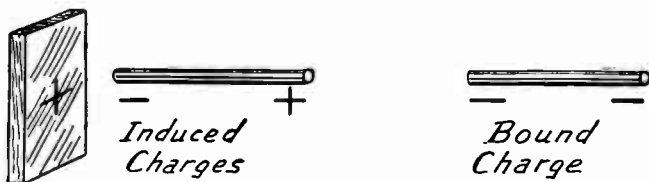

Charges Produced by Electrostatic Induction.

This is shown in the drawing. The plate is assumed to carry a positive charge. A metal rod is brought near the plate, but is not allowed to touch it. Two charges appear on the rod. At the end nearest the plate is found a negative charge and at the end farthest from the plate is found a positive charge. The positive charge on the one end of the rod just equals the negative charge on the other end, although neither will equal the original charge on the plate.

The like charge or positive charge on the far end of the rod may be removed by touching or connecting the rod to earth for a moment. The negative charge which was on the end of the rod nearest the plate will now travel along the rod and distribute itself evenly along the length of the rod.

INDUCTION, MAGNETIC

The positive charge which first appeared on the far end of the rod is called the repelled charge. The negative charge which remains on the rod after the removal of the positive charge is called a bound charge. The rod may now be taken away from the plate and will keep its bound charge until it is neutralized by an equal positive charge from some other source, this retention of the bound charge being possible provided the rod is properly insulated.

INDUCTION, MAGNETIC.—When a piece of iron or steel is brought into a field composed of lines of force the iron or steel becomes a magnet. If a field or lines of force are caused to pass through a piece of iron or steel here again the metal will become a magnet. This action of producing magnetism in the iron or steel by the action of lines of force or a magnetic field is called magnetic induction.

In a transformer the lines of force in the field set up by the primary winding will magnetize the core by magnetic induction. Soft iron loses its magnetism as soon as removed from the field or as soon as the field dies away. Hardened steel retains its magnetism. See also *Field, Magnetic and Electromagnetic*.

INDUCTIVE COUPLING.—See *Coupling, Inductive*.

INDUCTIVE FEEDBACK.—See *Oscillation*.

INDUCTIVE REACTANCE.—See *Reactance*.

INDUCTOR.—See *Coil*.

INPUT RESISTANCE.—See *Tube, Input Resistance and Impedance of*.

INSIDE ANTENNA.—See *Antenna, Indoor Type*.

INSULATION.—Electric voltages and currents are kept within their proper circuits and are made to follow the desired paths by the use of insulation around conductors. Any material or substance used for insulation must be a non-conductor having high resistance to voltage. The greater its resistance or the higher the voltage required to break through, the better is the material as an insulator.

The insulating ability of such materials is specified in either of two ways. The insulation resistance is measured by the number of ohms resistance offered by a piece of the material having a certain size. The dielectric strength is measured by the number of volts required to force a current through the insulation by breaking it down.

Many kinds of insulation are described under their respective headings, the following being the principal ones so treated:

<i>Air</i>	<i>Porcelain</i>	<i>Rubber</i>
<i>Fibre</i>	<i>Mica</i>	<i>Waxes, Insulating</i>
<i>Paper</i>	<i>Quartz</i>	<i>Cloth, Insulating</i>
<i>Glass</i>	<i>Wood</i>	<i>Oils, Insulating</i>

Insulation resistance is of two kinds; volume resistance or resistance to passage of voltage through the mass of the substance, and surface resistance or the resistance measured across the surface or across a film of the substance.

The dielectric strength or voltage required for breakdown is affected by heat, becoming less as the temperature increases; by the length of time the impressed voltage continues, becoming less with increase of time; and by the frequency of the applied voltage, becoming less as the frequency increases. As a general

INSULATION, MOULDED AND LAMINATED

rule the insulator will have greater dielectric strength if it is made up of a large number of thin layers or laminations. See also *Strength, Dielectric*.

INSULATION, MOULDED AND LAMINATED.—Very few of the materials used as insulators in radio work are employed in their natural state. Most of them are compounds of different substances treated under heat and pressure and with the aid of chemical reactions while they are moulded into desired shapes or while they are built up in layers or laminations to form sheets. Many kinds of raw materials enter into the composition of insulators. Among the more common are phenol base compounds, resins, shellacs, varnishes, waxes, powdered and sheet mica, clay, wood flour, rubber, vegetable fibres and asphalt.

The principal insulators used in radio receivers include phenol compounds, hard rubber, woods, and to some extent fibre. The characteristics of these materials and of others used for similar purposes are described under their respective headings to which reference may be made. See also *Panel, Materials for*.

INSULATION, RESISTANCE OF.—See *Resistance, Insulation*.

INSULATOR.—Any piece of insulating material which is used for its insulating properties and often as a support for other parts at the same time is classed as an insulator in the usual meaning of the word.

Such use of an insulator calls for high resistance, both volume and surface.

The volume resistance is taken care of by selecting materials of high ohmic resistance; glass, porcelain, hard rubber, and the better grades of moulded and laminated compounds being favored. The surface insulation is increased by corrugations and by extending rings or bosses such as seen on antenna insulators and on the insulating spacers of some variable condensers. Any shape which increases the distance measured over the surface between the two ends of the insulator will increase the surface resistance which is a desirable feature.

Since almost all insulators used around receiving equipment must withstand high frequencies it is important that they have a satisfactory dielectric constant and small losses from dielectric absorption and dielectric hysteresis.

Insulators used as supports, such as antenna insulators, must have good mechanical properties. They must not absorb moisture, they should not be too brittle, and they should be strong both in tensile strength and compressive strength. These qualifications are well cared for by porcelain, high grade moulded materials and glass.

INSULATOR, ANTENNA.—See *Antenna, Insulators for*.

INSURANCE RULES.—See *Rules, Underwriters'*.

INTENSIFIER.—See *Trap, Wave*.

INTERFERENCE.—By interference is meant any kind of an electrical impulse, other than the desired signal, which may be heard from the receiver. The kinds of interference to be considered under this heading are impulses which come through in spite of a receiver's having a satisfactory degree of selectivity. Signals from

INTERFERENCE

a broadcasting station whose frequency or wavelength is nearly the same as the one it is desired to hear are not here treated as interference because a receiver of great enough selectivity might tune out this unwanted station. See *Selectivity*.

All interference must arise from some electrical cause. By strict interpretation this definition of interference would include static disturbances. But static will not be considered here because it is given individual treatment under the heading *Static*.

The bothersome interference may come through the air from the outside, may come through circuits used for power, light or telephone service, may come from faults in electrical wiring and electrical devices within the building where the receiver is located, or may arise within the receiver itself. It is first in order to list the principal causes of all kinds of interference.

Interference coming through the air to the antenna:

Radio telegraph transmitters, either on shipboard or on shore, may emit a wave so broad and so overpowering that no receiver will tune them out. They are heard as the series of rapid dots and dashes that sooner or later becomes familiar to most broadcast listeners.

The receiving antenna may be close to, or may even run parallel with, electric power lines. Loud crackling noises will then be picked up whenever these lines are in use.

Discharges of lightning during any kind of electrical storm.

An oscillating receiver operated by some neighbor. See *Re-radiation*.

Interference coming through power, light or telephone circuits from outside:

Sparking commutators of motors, of oil burners, vacuum cleaners, sewing machines, or other household devices.

Sputtering arc lamps.

Sparking trolley wheels or third rail shoes.

Heating pads, curling irons, electric irons, and all other devices using electric heat.

Vibrating battery chargers.

Violet ray and X-ray machines.

Power or lightning circuits in which may be found accidental grounds through trees or guy wires, cracked or dirty insulators, defective switch contacts, grounded transformer neutrals, etc.

Interference from electrical parts within the building:

Sparking may be suspected in any electrical device which contains a motor.

Radiation of interference as well as of warmth may be suspected from any device which uses electricity to produce heat.

Practically all medical and physiological appliances for household use are likely to cause interference.

Loose connections or contacts anywhere in the house lighting circuit; this applying to switches, fuses, wall plugs, lamp sockets, and everything else about the wiring or fixtures.

Apparent interference within the receiver:

Faults of this kind will produce noisy operation. All of the causes and remedies for noise are treated under the heading *Noise*.

If interference of the kinds already considered is of considerable strength and comes from a nearby source it may be picked up by any long leads between the receiver and batteries.

INTERFERENCE

If the receiver is operated from any kind of a power supply unit attached to the lighting circuit of the building, disturbances in these circuits may be carried through into the receiver if the power supply unit has a faulty or poorly designed filter system.

Recognizing the Kind of Interference.—It is not sufficient to simply realize that some kind of interference is spoiling reception. It is quite necessary to be able to make an intelligent guess as to the cause of the interference. About the only thing on which such a guess may be based is the kind of sounds that are heard. Some of these will now be described although it is rather difficult to describe some of the sounds that are caused by interference.

A rapid and regular clicking noise which keeps time with the frequency of the power lines may be attributed to vibrating battery chargers or any other electrical device employing a vibrator.

A rapid whirring noise which rises in pitch immediately after it starts and then falls in pitch as it comes to a stop may be blamed to direct current motors using commutators.

An intermittent rasping and scratching noise of varying intensity may be caused by defective insulators, accidental grounds or loose contacts in any circuit.

A loud roar which dies out after a few seconds is usually caused by the charging of lightning arresters.

A more or less steady and continual crackling comes from arc lamps, medical devices or any electrical units in which there is a heating coil.

A rather faint buzzing which lasts for only a few seconds at a time is generally due to vibrating bells, door bells, telephone bells, etc.

A violent squeal which rises and falls in pitch when the receiver's dials or controls are not being touched is caused by a nearby oscillating and radiating receiver. The changes are caused by the operator of the offending receiver because he cannot be satisfied with his lack of success in tuning and is continually trying to do the impossible by changing his controls.

A loud crashing noise which rises in intensity and finally dies away after five or ten seconds is generally caused by trolley cars, elevated trains or subway trains whose contact wheels or shoes are sparking.

Rather musical long and short dashes and dots which rise and fall in pitch are caused by radio telegraph stations. These are especially noticeable when tuning at the highest wavelengths.

A steady, rapid, sharp buzzing may be caused by the small motors used in vacuum cleaners, electric sewing machines, oil burners, etc.

A low pitched, rather soft vibration, continuing as long as the receiver is used is almost always caused by the antenna or ground lead being near power lines or by the use of an improperly filtered power supply unit.

A cracking sound which recurs at regular intervals is generally due to electric sign flashers

INTERFERENCE

Locating the Position of the Source of Interference.—The first step in this part of the work is to decide whether the interference is in the receiver, in electrical parts within the building, in outside power, light or telephone lines, or in the air.

First disconnect the antenna. If the interference continues, disconnect the ground. If it still continues the fault is in the receiver itself, unless a power supply unit is being used. Of course, if the power supply unit were to be disconnected the receiver would no longer detect nor amplify either interference or signals and nothing would be gained. If the power supply unit furnishes current for the filaments only and contains a small storage battery it may be disconnected and the tubes operated from the storage battery for a short time. Should the interference continue with all possible outside connections removed from the receiver, the methods given under the heading of *Noise* should be followed.

If the removal of antenna or ground stops the interference the trouble may have been coming through the air or it may be due to faults in the antenna or ground. Reconnect both of these and then go over them while the receiver is in operation; moving and shaking all joints, insulators and supports. If this procedure has any effect on the interference it indicates that there are poor connections or poor insulators in the antenna or ground circuits.

To determine whether the interference comes from electrical equipment within the building, wait until the offending noises are decidedly noticeable and then open the main supply switch just inside of the building. This of course presumes that the receiver is operated from batteries and not from power supply units. If it is found that the interference may be stopped as the switch is opened the fault is within the building. The test should be made by opening the switch while the interference is bad and noting the result. Noting the effect of closing the switch is not so reliable because the interference may stop while the switch is open and may not start immediately after the switch is closed.

Should it be decided that the interference is in the building, try removing the fuses or opening the circuit breakers for any branch circuits, handling these circuits one at a time. Should the interference stop with any one circuit open, that is the circuit giving the trouble. It is then in order to go over this line of wiring; tightening all terminal screws, loose wire ends, fuse clips, switch contacts, service outlet plugs, lamp sockets, lamp bulbs in their sockets, wall switches, etc.

Interference Coming Through Wiring from Outside.—If none of the foregoing methods have stopped the interference and shown it to be in the receiver or within the building, it may be coming through the air to the antenna. The location of the antenna should be checked and if it runs near to or parallel with any power lines its position must be changed so that it is as nearly as possible at right angles to these lines. Using a shorter antenna or a lower antenna will help to reduce the effect of the interference although it will not eliminate it. The effect of the interference may be reduced by connecting a resistance of 50,000 to 100,000 ohms between the antenna binding post and the ground binding post of the receiver as in Fig. 1. This will bypass most interference of low frequency to ground, but it will also greatly reduce the sensitivity and distance getting ability of the receiver.

INTERFERENCE

If it is finally decided that the interference is coming from outside the building, either over power lines leading into the building or through the air to the antenna, it is advisable to attempt cooperation with other listeners in the neighborhood. Inquire of these neighbors whether they experience the same kind of interference and enlist their help in tracing it to its source.

Power and light companies, also all other companies using electrical apparatus which may be causing the interference, are almost without exception more than glad to help in its removal. This is true because the interference indicates that something is wrong with their equipment and any faults in the equipment generally mean a loss of money to its owners.

The interference may be reported to any of these companies. It is necessary to make an intelligent report if anything is to be gained. In writing to the company or talking with its representatives be prepared to describe as

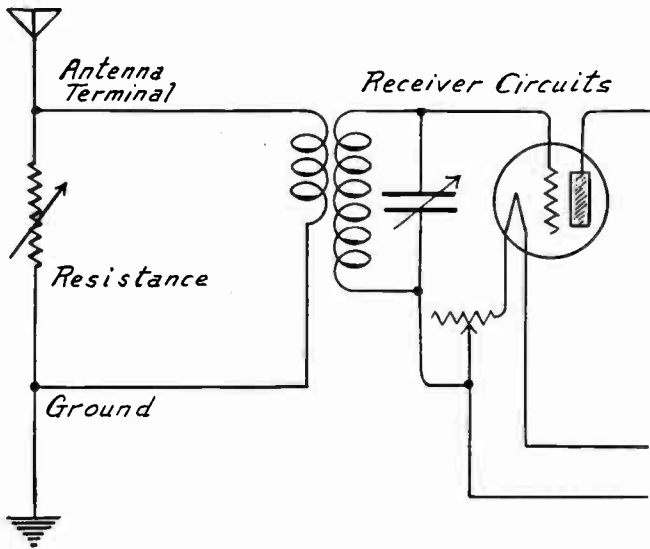

FIG. 1.—Using Resistance to Reduce Effect of Interference.

well as possible the sound of the interference, its tone or pitch and whether it is intermittent or continuous. Make a notation of the exact time down to the minute at which the interference starts and when it stops. Also make a note of weather conditions during the time of interference, whether rain was falling, whether there was a high wind, the temperature and any abnormal conditions. With this information the power company or any other organization interested will be enabled to trace down the interference and remove its cause in most cases.

Tracing Interference.—Should it become necessary to locate the point at which the interference is originating without help from other listeners this may be done with the help of a reasonably sensitive portable receiver equipped with a loop antenna. The receiver must be completely self-contained, batteries and all, within its cabinet. Nothing except the loop may appear outside. The cabinet

INTERFERENCE

must be completely shielded, top, bottom and sides, with no joints or openings at any point.

A receiver for this work may be of the three-tube regenerative type, using a detector regenerating with a tickler coil, followed by two stages of audio frequency amplification. Since headphones will be used in tracing the interference it is advisable to provide jacks for the phones so that they may be used either after the detector, after the first audio stage, or after the second audio stage. This is done because the sound from the interference may be too loud for comfort with two stages of audio amplification when the operator finally comes close to the source of the trouble. It is also possible to use a portable superheterodyne receiver for this work provided it is completely shielded and self-contained.

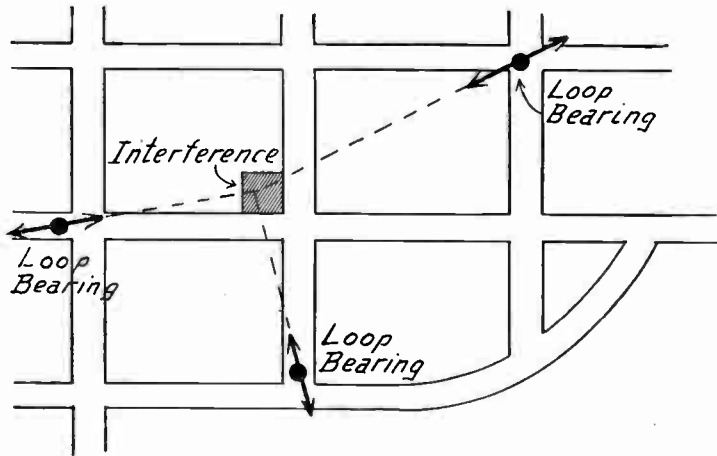

FIG. 2.—Locating Interference with Portable Receiver.

Unless the receiver is light enough to be carried about in the hands it is best to carry it in an automobile. The receiver is placed in operation and the tuning controls or regeneration controls are changed so that the sound of the interference is loudest. The loop is then rotated until the sound of the interference is at its maximum volume. The loop is then pointing toward the interference.

It is almost essential to have some kind of a map of the locality in which the work is being done. This map may be nothing more than a rough pencil sketch showing the principal streets but something of the kind should be used. The position of the portable receiver when the first bearing is made with the loop should be noted on the map and a short straight line laid off on the map in line with the plane of the loop. This line will then point toward the interference as in Fig. 2.

The portable receiver is now moved three or four blocks away from the first position, the loop is again turned until maximum interference is heard, and a second line is laid off on the map to coincide with this new position of the loop. A third and fourth bearing may be taken after moving the receiver into new positions each time. The map will now have three or four

INTERFERENCE

lines on it and if these lines are extended until they meet or until they come almost together at a central point the source of interference is at or very near the place on the map at which all the lines cross.

The receiver should then be taken to this indicated point of trouble and moved around while the loop is rotated. It will finally be possible to move the receiver all the way around one location with the loop being continually changed to point toward the center of this small area around which the receiver is being carried. The cause of the interference is somewhere around this point. It is then in order to go back to the list of causes of interference given at the beginning of this section and check over each one as to the possibility of its being present.

Reducing and Eliminating Interference.—If the interference is found to be in some electrical device such as a motor, a converter, a spark coil, a heater, or similar offending unit, various means may be taken to prevent its further radiation of troublesome waves through the air or surges through its supply lines. For this purpose use is made of choke coils and bypass condensers, most of the principles being described under the heading of *Filter*.

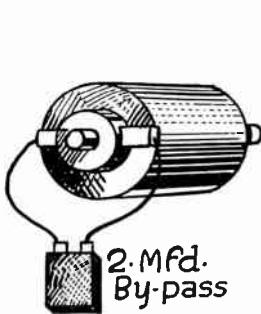

FIG. 3.—Bypass Condensers for Preventing Interference from Sparking Brushes on Motor

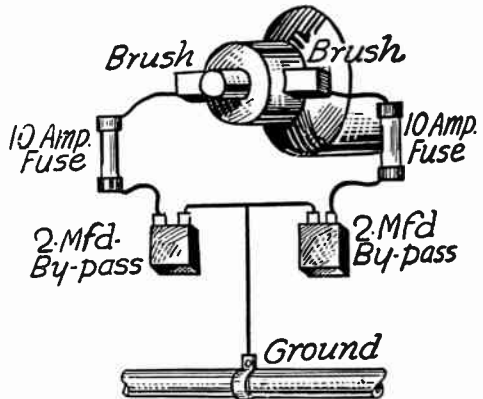

FIG. 4.—Use of Ground and Fuses on Interference Filter.

All bypass condensers which are used in connection with supply lines of from 110 to 220 volts must be able to stand one thousand volts of direct current. Should it be necessary to use bypass condensers in connection with 550-volt lines two of the thousand-volt condensers should be connected in series and inserted wherever a bypass condenser is called for.

Filter circuits used for eliminating interference must contain fuses which protect the power lines to which they are connected. Two fuses should be used, one placed in each side of the power line between the filter and the line. The fuses should not be larger than ten-ampere size unless more than ten amperes of current are used by the device being handled. Filters for any electrical unit which uses more than ten amperes of current require special construction to comply with insurance rules.

INTERFERENCE

Where the interference arises from nothing more serious than a slight sparking between the brushes and commutator of small motors it may be sufficient to connect a two-microfarad bypass condenser between the brushes of the motor as shown in Fig. 3. With larger motors, or if the simple bypass con-

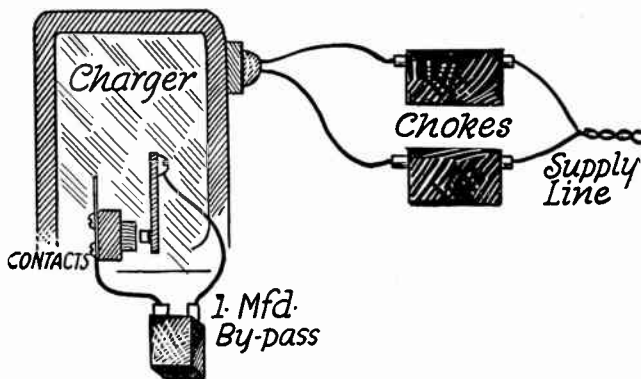

FIG. 5.—Handling Interference of Vibrators and Flashers.

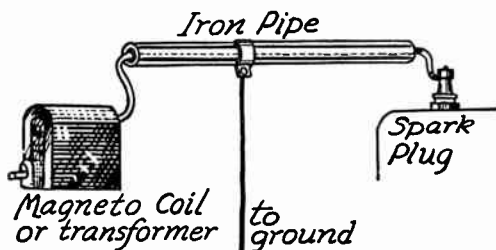

FIG. 6.—Shielding of Ignition Circuits to Prevent Interference.

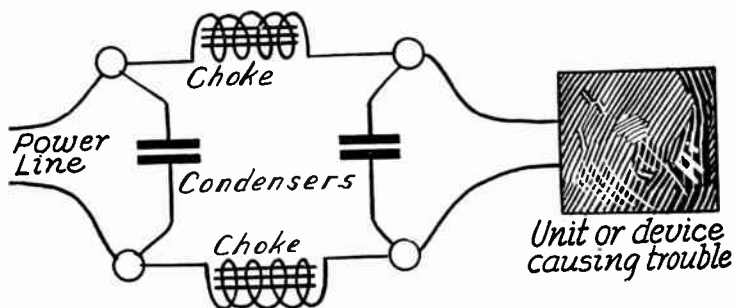

FIG. 7.—Filter Placed between Interfering Device and Power Line.

denser does not eliminate the interference, it may be necessary to use two condensers across the brushes with a connection made to ground from between the condensers. This is shown in Fig. 4. This illustration also shows the installation of protective fuses.

INTERMEDIATE FREQUENCY

Any electrical device using vibrating contacts, such as a vibrating battery charger, may be handled by the method shown in Fig. 5. A bypass condenser of at least one microfarad capacity is connected across the contacts and choke coils are inserted in each side of the supply line. The same method may be used with sign flasher contacts.

An ignition system such as used for farm light engines or for oil burners should have its high tension wiring between the spark plug and the magneto, coil, or transformer shielded by running the wires through an iron pipe which is grounded. This is shown in Fig. 6.

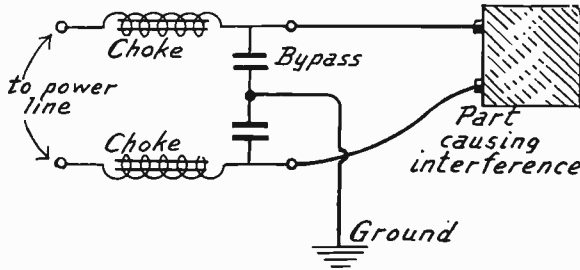

FIG. 8.—Interference Filter with Grounded Center Tap.

A low pass filter as shown in Fig. 7 and constructed according to the principles laid down under the heading *Filter, Low Pass*, may be placed between any electrical device which is causing interference and its power line. In Fig. 8 is shown a form of low pass filter which will often give excellent satisfaction. Here the disturbance is bypassed to ground through two condensers having the ground lead between them. The disturbance is prevented from going into the power line by choke coils in each line.

Any kind of filter system must be connected as close to the source of trouble as possible. The case containing filter chokes and condensers should be placed right alongside of the device which causes the interference, not four or five feet away.

Choke coils suitable for this work are described under the heading *Coil, Choke*.

INTERMEDIATE FREQUENCY.—See *Receiver, Super-heterodyne*.

INTERNAL CAPACITY OF TUBE.—See *Tube, Capacities, Internal*.

INTERNATIONAL CALL LETTERS.—See *Letters, Station Call*.

INTERSTAGE COUPLING.—See *Coupling, Interstage*.

INTERSTAGE SHIELDING.—See *Shielding*.

INVERSE DUPLEX SYSTEM.—See *Reflexing, Principles of*.

ION.—When a molecule is broken up into two parts the parts are called ions. One of the ions is minus one electron and therefore has a positive charge. The other ion is a negative charge. An ion may consist of one or more atoms of an element. Positive ions are called cations while negative ions are called anions. The cations move toward the cathode and the anions move toward the anode. This action takes place in electrolytes and in gases. See the following: *Anode; Cathode, and Electrons*.

IONIC TUBE

IONIC TUBE.—Another name for vacuum tube. See *Tube*.

IONIZATION BY IMPACT.—See *Electrons*.

IONIZATION IN AIR.—In its normal state air is an insulator. But when air is acted upon by waves of extremely high frequency such as some of those found in sunlight, part of the air molecules are broken up into positive and negative ions. When this happens the air is no longer an insulator but is a partial conductor. It is a conductor of rather high resistance, still it will transfer electricity. Air that has thus been made a conductor is said to be ionized.

A body or a layer of ionized air acts very much as a metallic shield when struck by radio waves. It either refracts, reflects or absorbs the waves. According to the Heaviside layer theory, ionized air accounts for many of the peculiar behaviors of radio waves, including their transmission around the curved surface of the earth for great distances and their fading under some conditions. See *Fading*, also *Radiation*.

IONIZATION IN TUBE.—See *Tube*, *Ionization in*.

IONIZED LAYER.—See *Fading*.

IRON AND STEEL.—Since steel is simply one form of iron, both metals will be discussed together. In considering the metal iron it must be looked at from two standpoints. First from the standpoint of its magnetic properties, second from the standpoint of its conductivity to electric currents or its properties as an ordinary conductor.

In radio work iron is looked upon as a magnetic material and any qualities as a conductor which may be possessed by the iron are only incidental. Before it is possible to make any intelligent comments upon the performance of iron in magnetic fields it is necessary to define some of the words and terms used in such a discussion.

Permeability is a measure of the iron's ability to carry magnetic lines of force. Permeability in magnetic circuits is similar to conductance in electric circuits. Permeability is generally measured by the ratio of the permeability of the metal to the permeability of air. The permeability of air is considered as being equal to one or to unity. See *Permeability*.

Reluctance is the opposite of permeability. It is similar to electrical resistance. Retentivity is a measure of the ability of iron to resist loss of its magnetism, to retain some of the lines of force even after the magnetizing current has been stopped. See *Reluctance*.

The effect of a magnet winding in producing lines of force in an iron core is called the magnetizing force. It is measured in ampere-turns per unit length of winding. Magnetomotive force is a term of similar meaning to magnetizing force.

Hysteresis is a measure of the power that is lost when iron is magnetized and demagnetized, it is a measure of the difference between the power applied by the magnetizing coil and the power which may be produced in a coil when the iron demagnetizes. The amount of magnetomotive force that is required to fully demagnetize the iron and to completely destroy any residual magnetism is called the coercive force. See *Hysteresis*.

The flux density in iron is a measure of the number of lines of force which are passing through a given area of cross section in the iron.

Various alloying substances are added to iron or steel which is to be used in magnetic circuits. Carbon decreases the permeability increases the coercive force and hysteresis losses and also increases

IRON CORE COIL

the electrical resistance of the iron. Silicon, which is often used in magnetic iron and steel, increases the permeability and reduces the hysteresis loss. Aluminum has very much the same effect as silicon, increasing the permeability to a slightly greater degree than silicon.

Tungsten and chromium harden the steel, greatly increasing its retentivity and making it suitable for permanent magnets.

The permeability of iron and steel is changed but little by moderate increases of temperature but when a temperature around 1,400 degrees Fahrenheit is reached iron becomes non-magnetic.

Ordinary iron and steel suffer from the effects of aging in increasing their hysteresis losses and decreasing their permeability. Silicon steel is practically non-aging under all ordinary temperatures.

Cast iron is not a satisfactory material for use in radio work when considered from the standpoint of magnetic qualities. Malleable iron is slightly better than cast iron. Cast steel is not suitable when the field strength is changing rapidly. Wrought iron is satisfactory from the standpoint of permeability but has rather high hysteresis losses.

It has been found in laboratory experiments that the desirable magnetic qualities of iron would be greatly increased were it possible to obtain the iron by electrolysis and to then melt it in a vacuum. Under such conditions it has been possible to obtain nearly four times the permeability with but one-third the hysteresis loss of ordinary transformer steel. This is mentioned simply to show what is possible under ideal conditions.

The electrical resistance of iron is of importance in its effect on eddy currents. The higher the resistance of the iron the less will be the loss in eddy currents. Silicon steel has advantages in this respect inasmuch as its resistance is about five times that of ordinary iron.

When iron is used in a field produced by a high frequency current its permeability does not change from the value found with low frequencies. It is fortunate that the great increase of skin effect at high frequencies tends to reduce eddy current losses far below their value at low frequencies.

IRON CORE COIL.—See *Coil, Iron Core Types*; also *Coil, Choke*.

IRON CORE TRANSFORMER.—See *Transformer*.

J

JACKS AND JACK SWITCHES.—Jacks and jack switches are devices employed for making various changes in the circuits of radio receivers. Among the more common uses of these devices are: Cutting in or cutting out additional stages of audio frequency amplification or radio frequency amplification, operating different combinations of loud speakers and headphones, changing from one antenna to another, control of power supply units, and the insertion of volt and ampere meters in vacuum tube circuits.

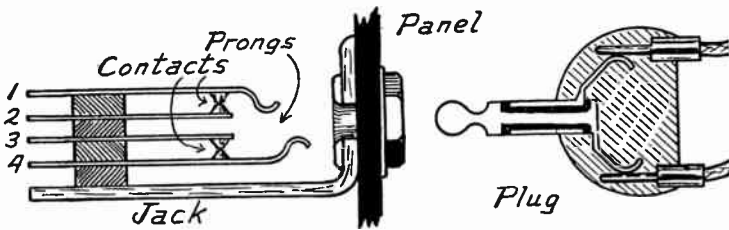

FIG. 1.—Construction of Jack and Plug.

The general construction of a jack is illustrated in Fig. 1. This particular type consists of four prongs, two of which are hooked at their ends. All four prongs carry contact points which are touching one another, as in Fig. 1. One circuit may thus be completed through prongs 1 and 2 and another circuit completed through prongs 3 and 4. The jack is mounted on a panel as shown.

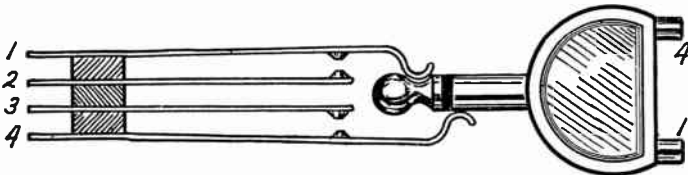

FIG. 2.—Plug Inserted in Jack.

At the right of the jack is shown a telephone plug constructed of an outer metallic sleeve within which is a metallic rod ending in a small ball. The sleeve and the rod are insulated from each other. At the right hand end of the plug are shown spring connections through which wires ending in telephone tips are inserted into the plug so that one wire makes contact with the sleeve and the other with the ball end.

In Fig. 2 the plug has been inserted in the jack. It will be seen that the ball tip is now in contact with the upper hooked prong, and that the sleeve of the plug is in contact with the lower hooked prong. The contact points in

JACKS AND JACK SWITCHES

the jack have now been separated so that the circuits which were completed in Fig. 1 have now been opened. Any wires connected to prongs 2 and 3 will remain open-circuited. A wire connected to prong 1 will complete a circuit through the ball tip and center connection of the plug. A wire connected to prong 4 will complete a connection through the sleeve of the plug. By the use of such a jack any unit connected to the wires leading into the plug may be put into a circuit between prongs 1 and 4.

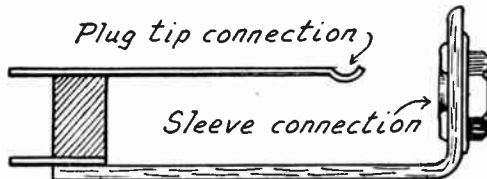

FIG. 3.—Mounting Bracket Used as Sleeve Connection for Jack.

The mounting bracket of a jack is sometimes used as a connection for the sleeve of the plug as shown in Fig. 3. The hooked prong of Fig. 3 makes contact with the ball tip of the plug while the mounting bracket makes connection with the sleeve of the plug.

Jack switches make circuit changes without the use of a telephone plug. The operating principle of a jack switch is shown in Fig. 4. This particular type has three prongs, the center one being much longer than the other two and extending over a cam. The cam is operated by a small knob or lever placed on the outside of the panel which carries the jack switch.

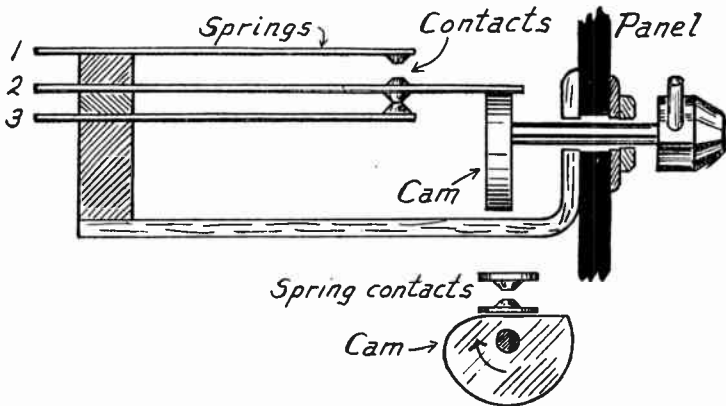

FIG. 4.—Operating Parts of a Jack Switch.

As the cam is turned, rotating to the right, it will close the upper pair of contacts and open the lower pair. This is shown more clearly by the sketch at the lower right hand side of Fig. 4. In one position of this jack switch a connection is made between prongs 1 and 2 while in the other position a connection is made between prongs 2 and 3.

JACKS AND SWITCHES, TYPES OF

The prongs of jacks and jack switches are held in position but are electrically separated from one another by blocks of fibre or other insulation. Wires are soldered to the extensions of the prongs. When mounting is upon a panel of insulating material any type of jack or switch may be used. But when one of these units is mounted upon a metal panel it is necessary to select a type in which the mounting bracket is insulated from all of the prongs. Such a type is shown in Fig. 1. The jack shown in Fig. 3 has a bracket which is electrically alive and it should not be used on a metal panel.

It is customary to make all connections for the positive side of circuits to the sleeve of a telephone plug. Positive circuits will then be connected with the jack prong or jack bracket making contact with the plug sleeve.

JACKS AND JACK SWITCHES, TYPES OF.—Fig. 1 shows the construction and operation of three types of jacks. The one at the top, *A*, is an open circuit jack whose prongs remain separated until connected through a telephone plug. The type shown at *B* has the two upper prongs connected until a plug is inserted.

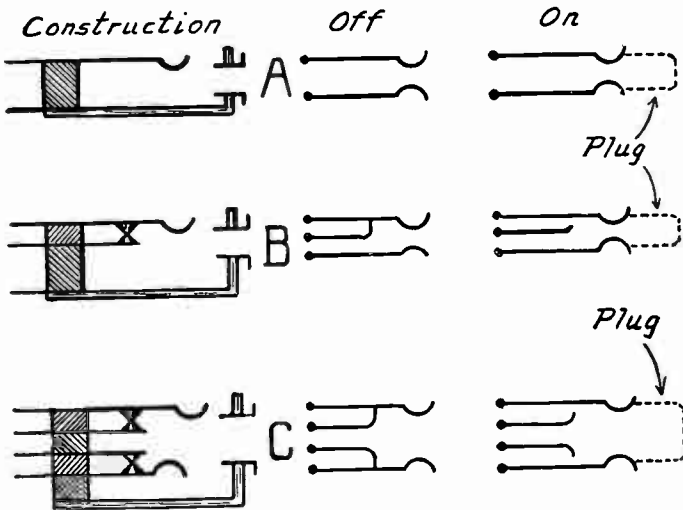

FIG. 1.—Operation of Jacks and Jack Switches.

The center prong is then disconnected and the plug circuit is completed through the upper and lower prongs. The type shown as *C* has two closed circuits, both of which are opened by insertion of a plug.

In Fig. 1 and in following illustrations showing types of jacks and jack switches the drawing at the left shows the construction of the unit. The drawing at the center shows the contact connections with no plug inserted in the jack or with the jack switch turned to the "off" position. The drawing at the right shows the connections made through the jack or jack switch when a plug is inserted or when the switch is turned to the "on" position.

The letters used to indicate the various types of jacks and switches will be used in following circuit diagrams which illustrate the em-

JACKS AND SWITCHES, TYPES OF

ployment of these units in numerous receiver circuits. By noting the letter appearing near the jack or switch in the receiver circuits it will be possible to refer to the diagrams of operating positions given in Figs. 1, 2, 3, 4, 5 and 6.

Filament Control Jacks.—A type of jack which automatically lights or puts out the filaments in certain tubes which it is desired to have operative or inoperative is called a filament control jack. Various types of filament control jacks are shown in Figs. 2, 3 and 4.

The lower part of jack *D* in Fig. 2 corresponds exactly to jack *A* in Fig. 1. The lower part of jack *E* corresponds to jack *B* and the lower part of jack *F*

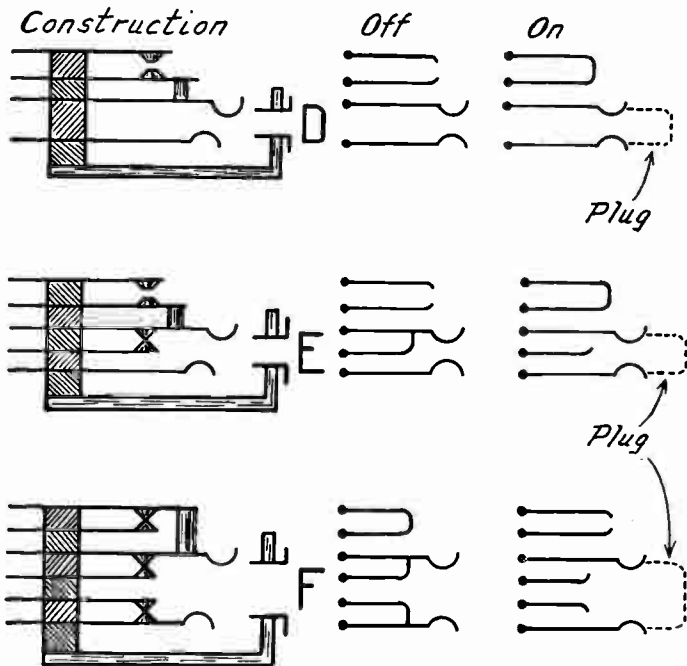

FIG. 2.—Jacks with Two Filament Control Contacts.

is the same as jack *C* in Fig. 1. Each jack in Fig. 2 has two more prongs than the corresponding jack in Fig. 1, these two extra prongs being used to open or close a filament circuit. As shown by the center sketches, the upper contacts of jacks *D* and *E* are normally open and are closed by inserting the phone plug. The upper contacts of jack *F* are normally closed and are opened by inserting the plug. The upper hooked prong operates the top contacts through a short piece of insulation as shown.

A different style of filament control jack is shown in Fig. 3. Here there are three prongs in the filament circuit portion of the jack. The lower part of jack *G* in Fig. 3 corresponds to jack *B* in Fig. 1. The lower part of jack *H* in Fig. 3 corresponds to jack *C* in Fig. 1.

JACKS AND SWITCHES, TYPES OF

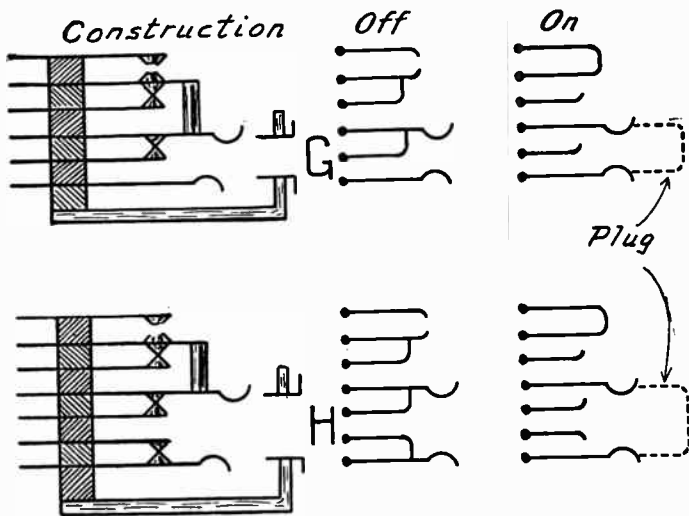

FIG. 3.—Jacks with Three Filament Control Contacts.

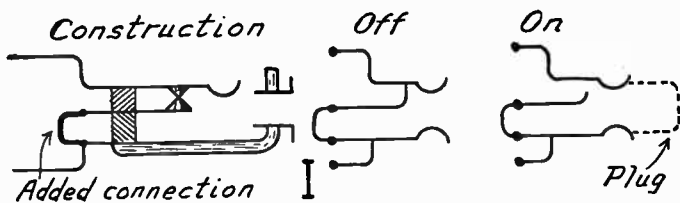

FIG. 4.—Jack Remodeled for Closed Circuit Work.

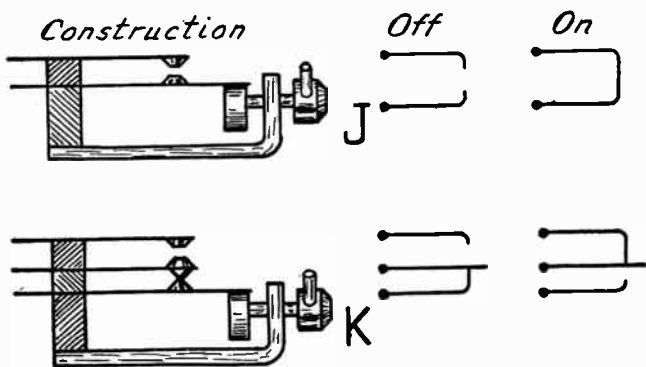

FIG. 5.—Single Pole Jack Switches.

JACKS AND SWITCHES, TYPES OF

The three upper prongs in the jacks of Fig. 3 are so arranged that one circuit is opened while the other is closed. The position of the contacts with no plug inserted is shown by the center sketches and the positions with a plug in the jack are shown by the right hand sketches.

Jack *I* of Fig. 4 is a modification of jack *B* in Fig. 1 made by permanently connecting two of the prongs of jack *B* together with a short piece of wire. This makes jack *I* into a closed circuit type in which connection remains complete between the two outside wires until the phone plug is inserted.

Jack Switch Types.—Fig. 5 shows the circuit changes made by a single-pole, single-throw switch *J*, and by a single-pole, double-throw switch *K*. These have respectively two and three prongs.

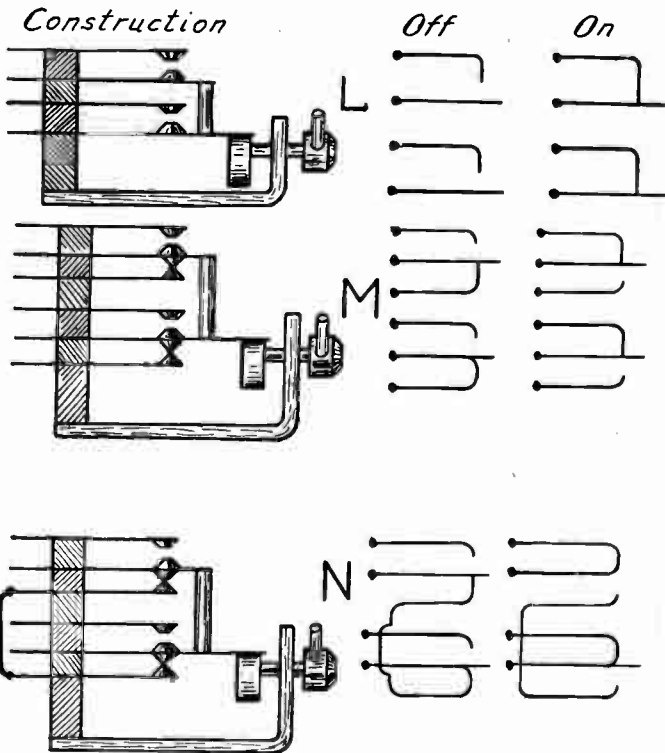

FIG. 6.—Double Pole Jack Switches.

Switch *L* in Fig. 6 is of the double-pole, single-throw type controlling two circuits at the same time. This switch either opens both circuits or closes both. Switch *M* is of the double-pole, double-throw type. With this switch it is possible to throw both sides of one circuit into two sides of either of two other circuits.

The switch marked *N* in Fig. 6 is a modification of switch *M* made by permanently connecting two of the prongs with a length of wire. It is useful in many special circuits.

JACKS AND SWITCHES, USES OF

JACKS AND SWITCHES, USES OF.—In all of the following diagrams showing the circuit connections for jacks and jack switches these units are designated by letters in circles alongside the jack or switch used. These letters correspond to the letters in Figs. 1 to 6 of the preceding section which show the construction and the contact positions both open and closed.

Cutting in Phones or Speaker.—Fig. 1 shows the connections for a type *B* jack to allow the insertion of headphones or a loud speaker following any one tube of a receiver having transformer or choke coil coupling. With this connection the B-battery or plate supply remains connected to the following coupling unit even when this unit is cut off from the plate. The method of Fig. 3 is preferred.

If resistance coupling is used, the resistance of the phones or speaker is so much lower than that of the resistance unit in the coupler that insertion of phones or speaker would destroy the am-

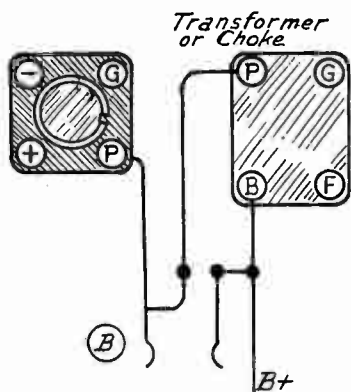

FIG. 1.—Jack for Phones or Speaker Following Any Tube.

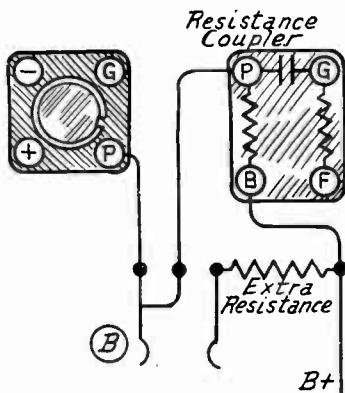

FIG. 2.—Jack for Insertion of Phones or Speaker with Resistance Coupling.

plification. To avoid this effect a resistance coupled amplifier is treated as shown in Fig. 2. A fixed resistance approximating the amplifying resistance in value is placed between the B-battery or power supply line and the jack as shown.

The use of the type *C* jack for inserting phones or speaker after any one tube is shown in Fig. 3. With phones or speaker inserted, both sides of the coupling unit are completely disconnected from both plate and battery. This type of jack is preferred for transformer or choke coil coupling but cannot be used for cutting in on resistance coupled stages. Were the scheme shown in Fig. 4 employed to serve the purpose of the resistance in Fig. 2 this resistance of Fig. 4 would be in series with the regular amplifying resistance at all times. This method is therefore not feasible and the additional resistance must be connected to the phones or speaker outside of the jack.

JACKS AND SWITCHES, USES OF

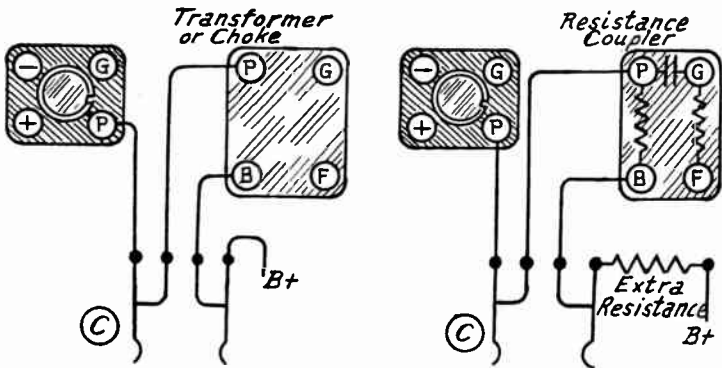

FIG. 3.—Jack for Phones or Speaker. FIG. 4.—An Unsatisfactory Method.

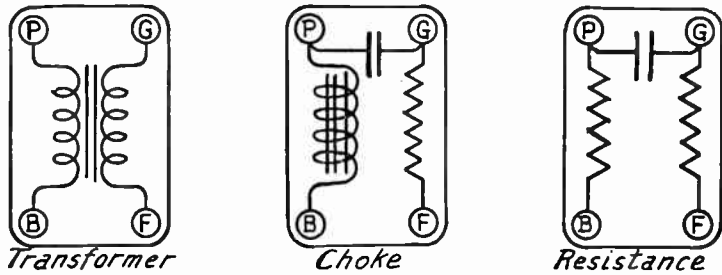

FIG. 5.—Similarity of Terminal Connections with Various Couplers.

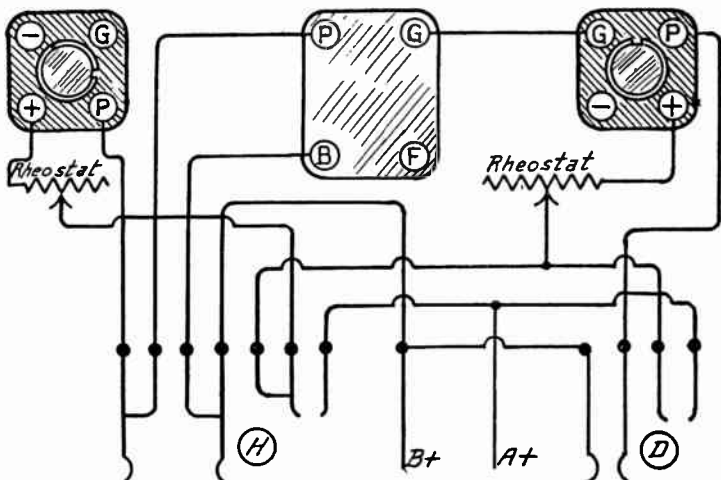

FIG. 6.—Filament Control Jacks on Two Stages.

JACKS AND SWITCHES, USES OF

The coupling units are shown simply as boxes having four terminals marked *P* for plate connection, *B* for B-battery or plate supply connection, *G* for grid connection, and *F* for filament or C-battery connection. This symbol represents either a transformer, a choke coil or a resistance coupler, whichever may be found in the receiver. The similarity of connections may be seen from Fig. 5 in which are shown the internal connections for the three types of coupling units, all with the same markings for their terminals.

Filament Control Jacks.—When inserting headphones or loud speaker in the output or plate circuit of any tube except the last amplifier it is advisable to open the filament circuits of all tubes not being used so that filament current is saved and so that all plate circuits connected to the inoperative tubes are dead. This may be done as shown in Figs. 6 to 10.

Fig. 6 shows the connections for one type *H* and one type *D* jack operating the last audio amplifying tube so that phones or speaker may be cut in on the plate circuit of the preceding audio amplifier. With the phones or speaker inserted in jack *H* the left hand tube will be lighted but the right

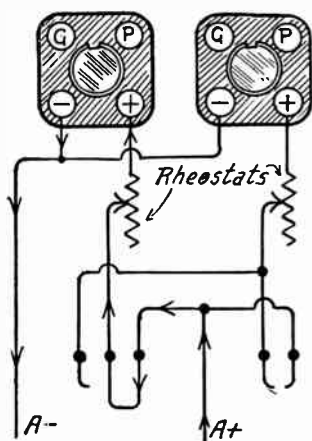

FIG. 7.—Filament Control Operating One Tube.

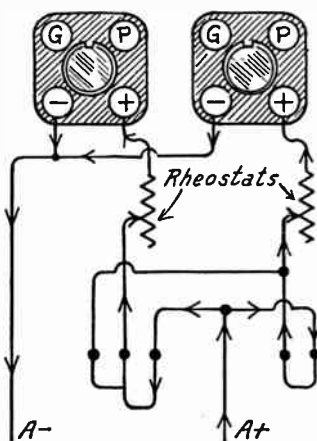

FIG. 8.—Filament Control with Two Tubes in Operation.

hand one will not. When inserted in jack *D* both tubes will operate and the output will be from the right hand tube.

Figs. 7 and 8 show in detail the action in the filament circuits of Fig. 6 with the plate and grid circuits omitted. The small arrowheads show the flow of current. Fig. 7 shows conditions when only the left hand tube is in operation. Both tubes are operative in Fig. 8.

Fig. 9 shows the connections of type *H* and type *D* jacks for cutting headphones into the detector output, at the same time opening the filament circuits of both the audio frequency amplifying tubes. With the phones or speaker inserted in the output jack *D*, both the audio amplifying tubes will be lighted. Both audio tubes are controlled by the filament connections on jack *D*.

Fig. 10 shows an extension of the scheme used for Fig. 9. Now the phones or a speaker may be cut in on the detector, on the first audio amplifying tube or on the second audio amplifying tube. When plugged in on the detector neither of the audio tube filaments will receive current, when plugged in on the first audio tube only this tube and the detector will be lighted, and when

JACKS AND SWITCHES, USES OF

plugged in on the output jack *D* all three tubes will be lighted automatically. This method makes the wiring quite complicated and is seldom used for that reason.

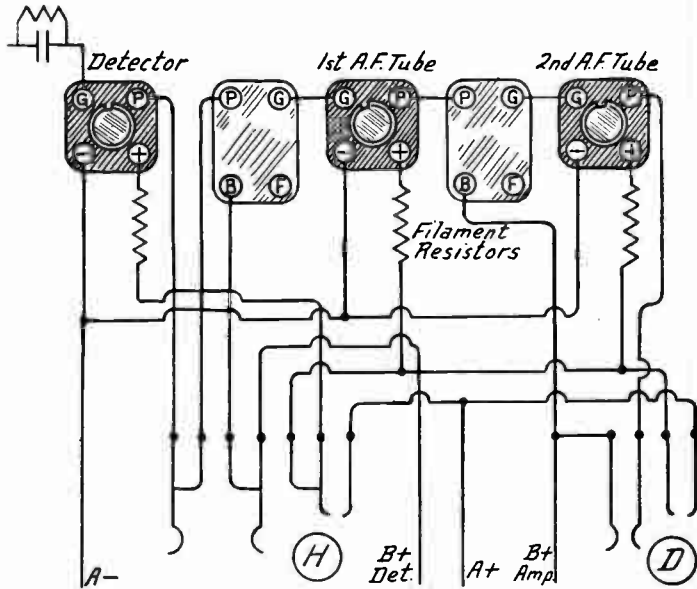

FIG. 9.—Filament Control Jack Following Detector Tube.

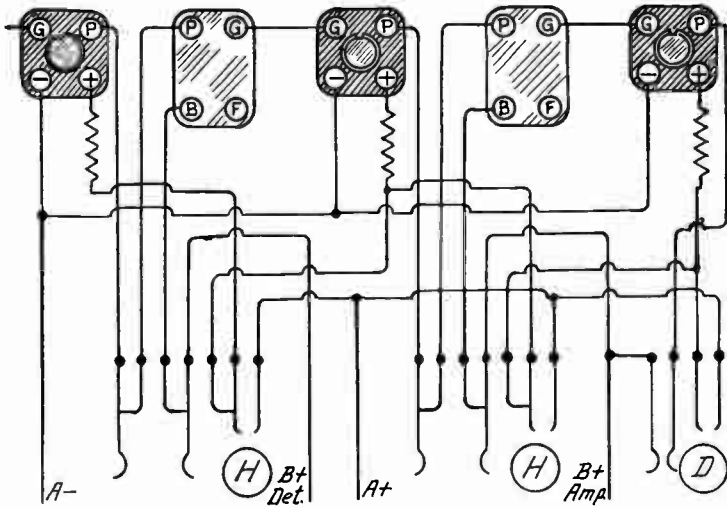

FIG. 10.—Filament Control Jacks for All Stages.

JACKS AND SWITCHES, USES OF

Cutting Out Intermediate Stages.—When a power tube is used as the last audio amplifying tube in a receiver this power tube always should be connected to the speaker if best results are to be obtained in tone quality. With a power tube in the last stage it would be inoperative when cutting a speaker into the first audio

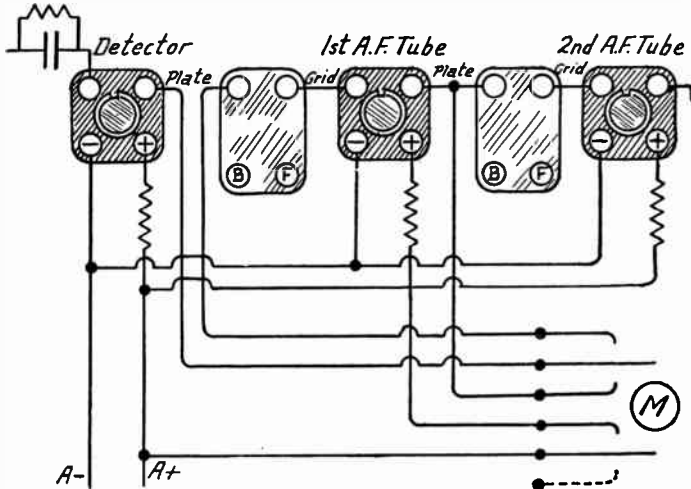

FIG. 11.—Jack Switch for Cutting Out Intermediate Audio Stage.

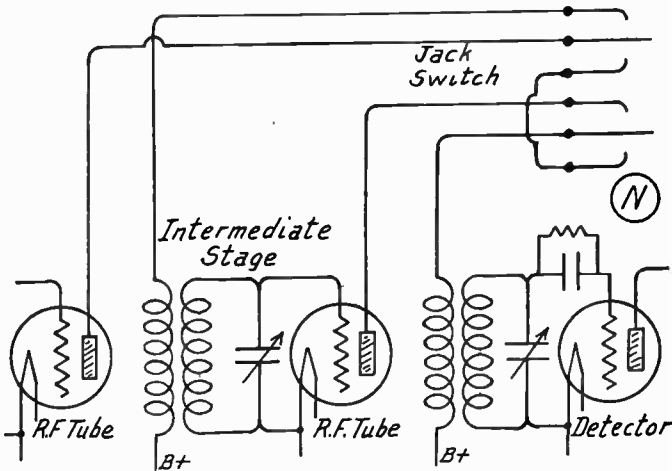

FIG. 12.—Jack Switch for Cutting Out Intermediate Radio Tube.

amplifying tube as in Figs. 6 and 10. It is better to cut out the intermediate stage, leaving the detector output connected directly to the power tube stage by using the methods of either Figs. 11 or 12.

JACKS AND SWITCHES, USES OF

The method of Fig. 11 is very satisfactory for the reason that it cuts off the filament current of the first audio amplifying tube when this tube is not in use. The change is made by using a type *M* jack switch. Only five of the six prongs are used and if a five prong switch is available it may be used in place of the type *M*. However, if only the regular double-pole, double-throw switch can be had, as is usually the case, the sixth prong may be ignored as shown by the broken lines indicating its position in Fig. 11.

The connections to the B-battery or power supply and to the C-battery from the coupling units are not shown since neither these circuits nor the grid circuits are altered when installing the intermediate stage control switch. This method may be applied to the first or the second audio amplifier tube in a three-stage amplifier as well as to the first tube in a two-stage amplifier.

The method of Fig. 11 may also be employed to cut out the second radio frequency amplifying tube in a two-stage or three-stage radio amplifier. Special precautions must be taken in radio stages to avoid extremely bad effects of feedback due to plate circuit wires from two stages coming into the

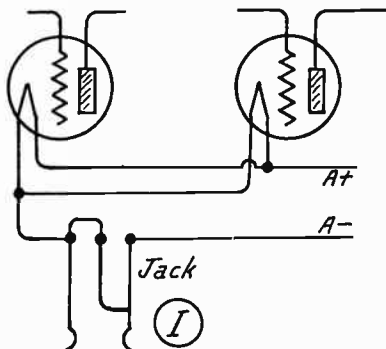

FIG. 13.—Jack for Filament Ammeter.

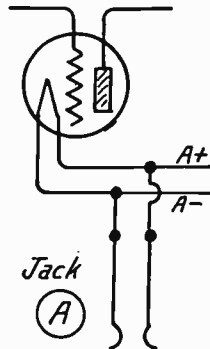

FIG. 14.—Jack for Filament Voltmeter.

same jack switch. If these wires are kept well separated right up to the switch and other usual precautions taken to avoid excessive feedback little trouble will be had in two-stage radio amplifiers.

Fig. 12 shows the use of a type *N* jack switch for cutting out an intermediate stage of radio frequency amplification. With the switch turned to its "off" position the plate of the left hand tube is connected through the switch to the primary of the second coupling transformer. With the switch turned to "on" the circuit from the plate of each tube goes to the transformer immediately following the tube. This method does not cut off filament current from the intermediate tube, consequently it is effective only in reducing volume, not in reducing the consumption of filament current.

Voltmeter and Ammeter Connections.—A filament ammeter having its terminals connected to a plug may be placed in series with the filament circuit of any tube or tubes by using a type *I* jack as shown in Fig. 13. A filament voltmeter with its terminals con-

JACKS AND SWITCHES, USES OF

ected to a plug may be placed in parallel with any filament circuit by connecting a type *A* open circuit jack as shown in Fig. 14.

If a filament ammeter is mounted permanently in a receiver it may be cut in or out of series with any filament circuit with a type *K* switch as in Fig. 15. A mounted filament voltmeter may be cut in and out of a parallel connection with a type *J* switch as in Fig. 16.

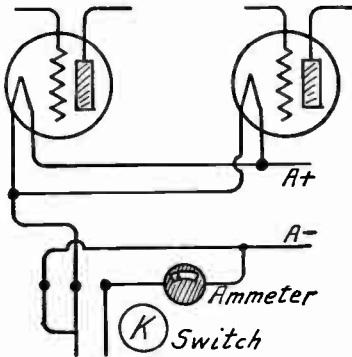

FIG. 15.—Switch for Filament Ammeter.

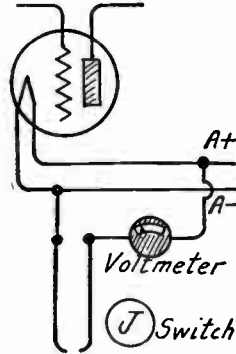

FIG. 16.—Switch for Filament Voltmeter.

A plate milliammeter connected to a plug may be inserted in any plate circuit by using a type *I* jack as in Fig. 17. A plate voltmeter connected to a plug may be put in parallel with any plate circuit by using a type *A* jack as in Fig. 18. It should be noted that this connection shows the voltage actually acting on the plate, not just the voltage of the plate supply unit or B-battery, which does not take into account the voltage drop through the plate circuit.

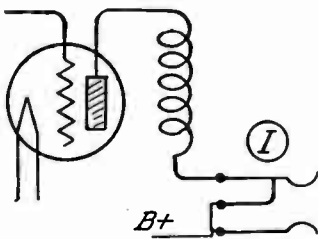

FIG. 17.—Jack for Plate Milliammeter.

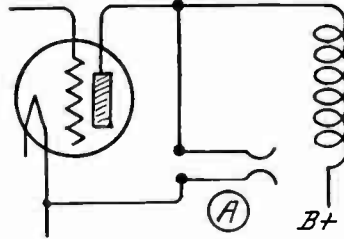

FIG. 18.—Jack for Plate Voltmeter.

A permanently mounted plate milliammeter may be cut in and out of series with any plate circuit with a type *K* switch as shown in Fig. 19. A mounted plate voltmeter may be operated with a type *J* switch to indicate true plate voltage as shown in Fig. 20.

Speaker Connections.—It is sometimes desirable to plug in a set of headphones for tuning and upon removing the headphones to have the loud speaker automatically start to operate. This may be done with the connections for a type *C* jack shown in Fig. 21. In-

JACKS AND SWITCHES, USES OF

section of phones in the jack completely disconnects the speaker which is re-connected upon withdrawal of the phones.

An exactly similar result may be obtained with a type *B* jack connected as in Fig. 22. With this type *B* jack the speaker remains connected to the B-battery or plate supply unit at all times.

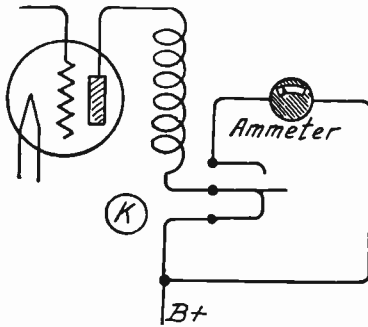

FIG. 19.—Switch for Plate Milliammeter.

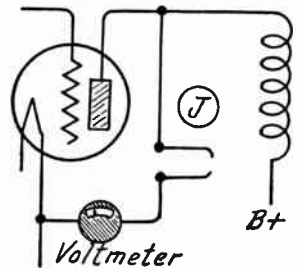

FIG. 20.—Switch for Plate Voltmeter.

Either one of two loud speakers may be operated from a type *M* switch connected to the output tube of an amplifier as shown in Fig. 23. The speakers may be located at considerable distances from each other and from the receiver, even fifty to one hundred feet from the receiver, if the two leads to the one speaker are

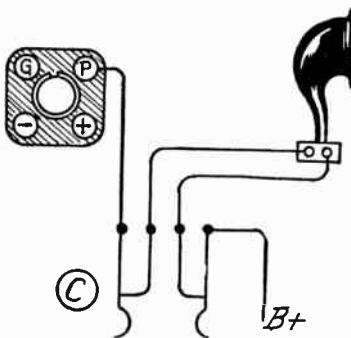

FIG. 21.—Jack for Completely Disconnecting Speaker.

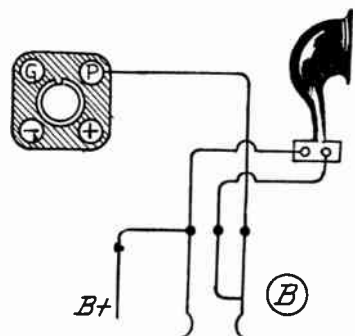

FIG. 22.—Jack Cutting Speaker Off Plate Circuit.

separated to reduce the capacity between them which may act as a partial bypass for the plate current.

Several speakers may be operated from one receiver through wiring run to points at which reproduction is wanted. The outlets for speaker connection are fitted with type *I* closed circuit jacks as shown in Fig. 24. With a speaker plug inserted in any one jack its

JACKS AND SWITCHES, USES OF

speaker is connected in series with the line. With the plug withdrawn the line is again completed so that the operation of other receivers is not interfered with.

If many speakers are to be operated on one line from a single receiver it may be found that a considerable reduction in volume takes place when all

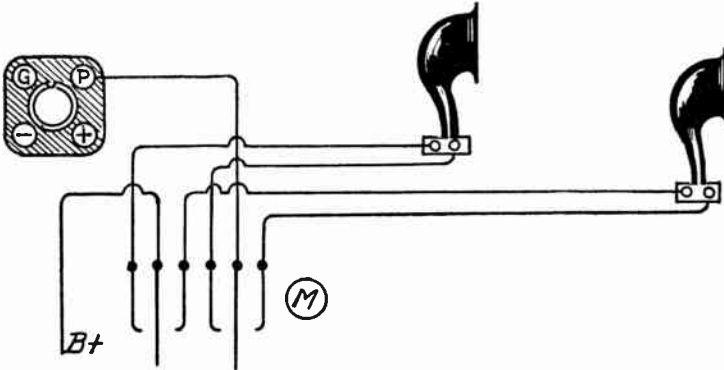

FIG. 23.—Switch for Changing from One Speaker to Another.

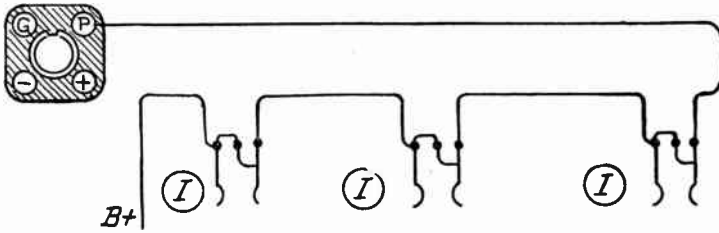

FIG. 24.—Plug-In Outlets for Several Speakers.

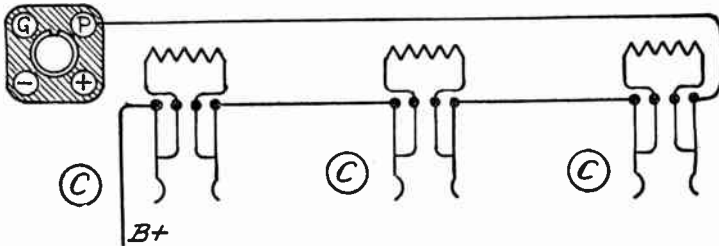

FIG. 25.—Plug-In Outlets with Compensating Resistances.

speakers are in operation at once. This is especially true if the speakers have rather high resistance in their windings.

This difficulty with the method shown in Fig. 24 may be avoided by using type C jacks as in Fig. 25. A resistance unit having approximately the same value as the resistance of one speaker is connected between the center prongs

JACKS AND SWITCHES, USES OF

of each jack. With the speaker out of the line and the jack closed, this compensating resistance is in circuit to take the place of the speaker resistance. With the speaker inserted, the resistance is cut out and operation goes on with practically no change in total resistance of the line.

With either the method shown by Fig. 24 or the one of Fig. 25 an output transformer or an output condenser and choke may be used following the last amplifier tube. See *Speaker, Loud, Connections to Receiver*.

Inserting Loop in Place of Antenna.—A receiver may be built to operate with an outdoor or indoor antenna or else with a loop. The loop may be fitted with a plug which can be inserted in a type C jack as in Fig. 26. This will cut off the antenna, the ground and the antenna tuning coil or coupler. The loop will be connected across the first tuning condenser so that the same condenser formerly used for antenna circuit tuning will be used for loop tuning. The only changed connections are those shown in Fig. 26.

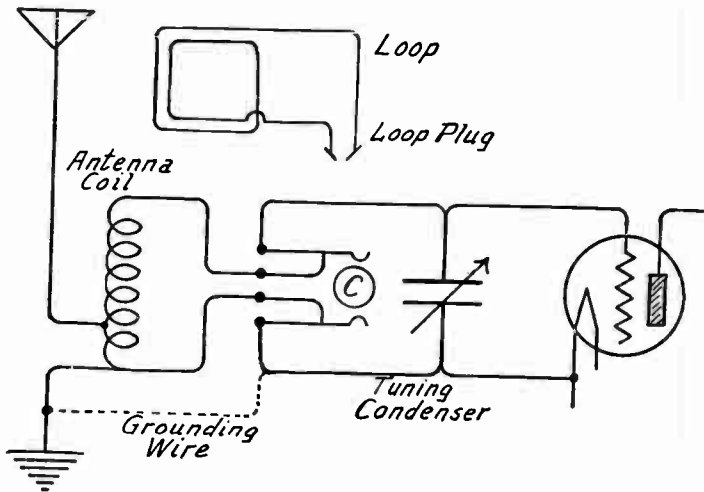

FIG. 26.—Jack for Changing from Antenna to Loop.

A similar result may be secured without the necessity of using a loop plug by employing a type *M* switch as in Fig. 27. With the switch thrown one way the antenna and ground are in use, while with the switch reversed the loop alone is in use. Both the loop and the antenna are then permanently connected to the receiver.

If it is desired to operate the loop with one side connected to ground it is only necessary to add the broken line connections shown leading to ground in both Fig. 26 and Fig. 27. The broken line connection for Fig. 26 diagram is conveniently made by connecting the two lower jack prongs permanently together with a short wire.

Insertion of Loading Coils.—When a tuned circuit is to be operated at higher wavelengths or lower frequencies it may be accomplished by inserting an additional inductance coil in series with the regular inductance. When the tuned circuit is to be operated at lower wavelengths or higher frequencies it is necessary to cut off part of the inductance.

JACKS AND SWITCHES, USES OF

Either of these things may be done with a jack as shown by Fig. 28. If the coil to be added or subtracted from the circuit is fitted with a plug the work may be done with a type *I* jack. The coil is completely disconnected from the circuit when the plug is removed.

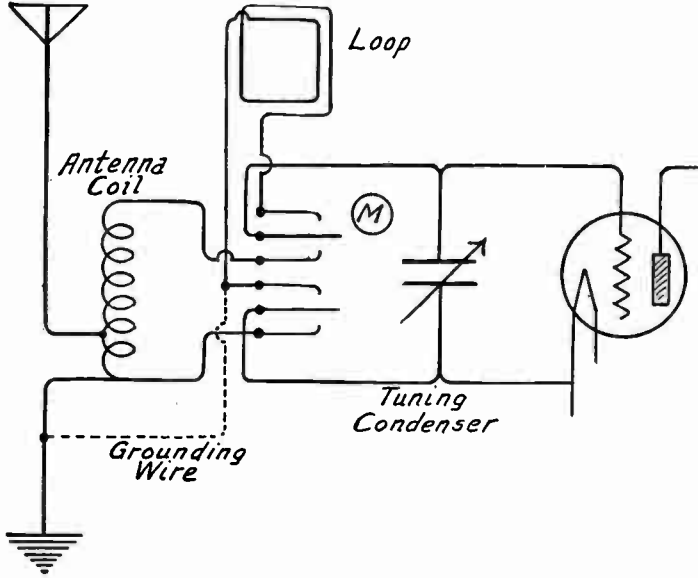

FIG. 27.—Switch for Using Either Antenna or Loop.

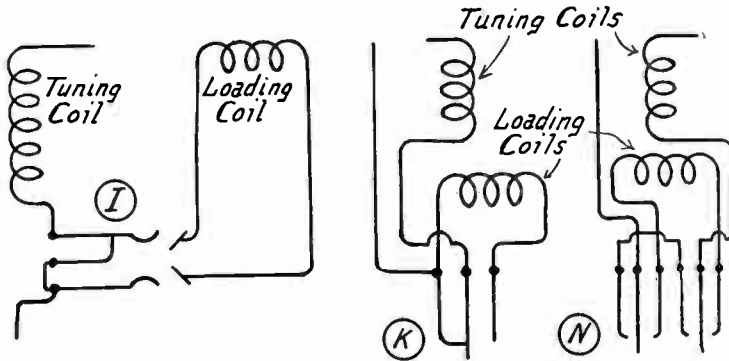

FIG. 28.—Jack for Insertion of Loading Coil.

FIG. 29.—Switches for Insertion of Loading Coil.

The method shown in Fig. 29 in which a type *K* switch is used, is not so very satisfactory for loading coils since the additional coil is left as a dead end when not completely in circuit.

JACKS AND SWITCHES, USES OF

If a switch is to be used for insertion of a loading coil the type *N* should be employed as at the right hand side of Fig. 29. With the switch in one position both inductances are in use and connected in series. With the switch in the other position only the main tuning coil is used, the other one being completely disconnected.

Series-Parallel Switch.—The type *N* double-pole, double-throw jack switch may be used as a series-parallel switch as shown by Fig. 30. With the switch thrown to the position at the left of the diagram the two units are in series with each other and with the line. With the switch in the right hand position the two units are in parallel on the line.

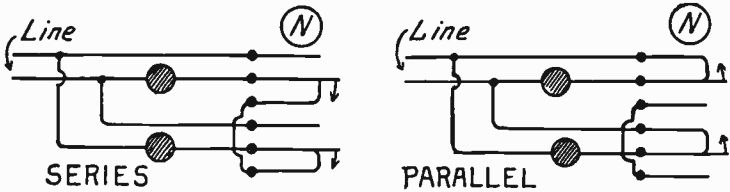

FIG. 30.—Double-Pole, Double-Throw Switch for Series-Parallel Work.

The two units indicated may be two condensers, two coils, two resistances, or any desired combination of condensers, coils and resistances.

Added Radio Stages and Intensifiers.—A number of units are marketed whose purpose is to make an existing receiver more powerful and more selective. These are mainly radio frequency amplifying units of one type or another. They usually employ one or more vacuum tubes and are provided with a filament or battery switch.

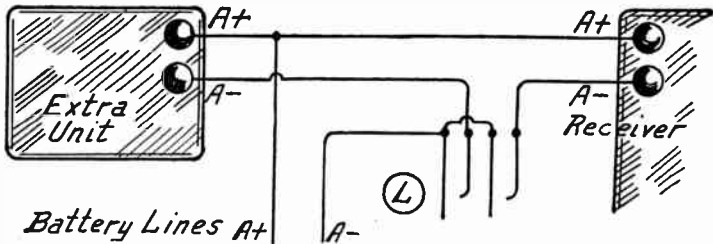

FIG. 31.—Switch for Control of Filament Current in Two Units.

To avoid the necessity of turning on and turning off two separate switches, one in the added unit and the other in the receiver, a type *L* switch may be used as shown in Fig. 31. The switches in the receiver and in the extra unit are allowed to remain turned on at all times, the type *L* switch providing the only needed control for both.

Power Unit Controls.—Two separate sources of power may be alternately connected to the one receiver by using a type *M* switch

JACKS AND SWITCHES, USES OF

as in Fig. 32. The two units may be two A-batteries as indicated or may be two B-batteries, two filament power units or two plate supply units. The connections toward the right go to the receiver.

When a power unit is used for plate voltage supply and a separate A-battery for filament current it is necessary to turn on the power unit at the same time the filament switch of the receiver is turned

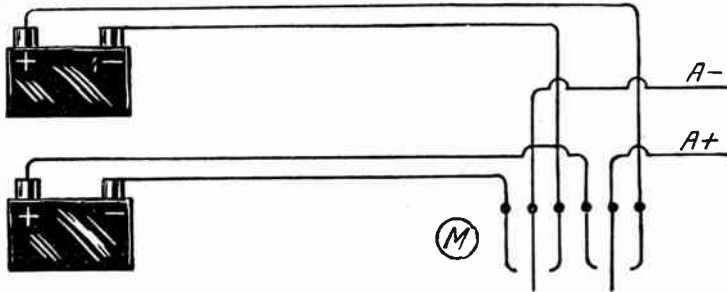

FIG. 32.—Switch for Using Either of Two Power Units.

on. Both operations may be done at the same time and with one motion of a type *L* switch as shown in Fig. 33.

Turning on the type *L* switch closes the circuit from the light and power line to the input of the plate voltage supply unit and at the same time closes the circuit between the A-battery and the receiver. The filament or battery switch of the receiver is placed in the "on" position and allowed to remain there at all times.

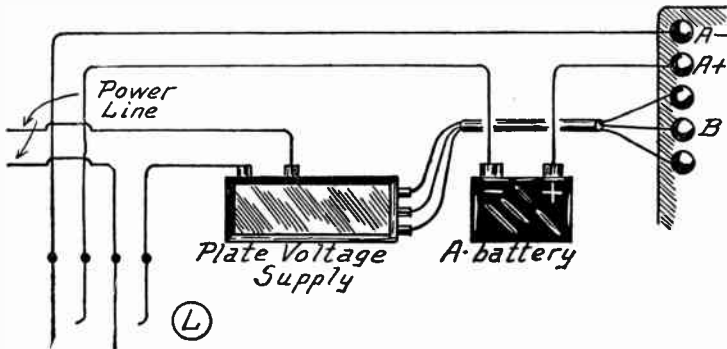

FIG. 33.—Switch for Control of A-Battery and Power Supply.

Receivers are sometimes operated with a battery for plate voltage and with a filament current supply unit consisting of a storage battery and a trickle charger to keep the storage battery continually charged. As the filament or battery switch of the receiver is turned on the trickle charger should be turned off to avoid an undesirable hum. This operating of two separate switches may be avoided by using a type *M* switch as in Fig. 34.

JAMMING

The filament or battery switch in the receiver is allowed to remain turned on all the time. As the type *M* switch is turned to its "on" position the circuit from A-battery to receiver is closed and the circuit from the power and light line to the trickle charger input is opened at the same time.

A receiver may be equipped with complete power supply for both filament current and plate voltage. This requires that with turning on of the receiver

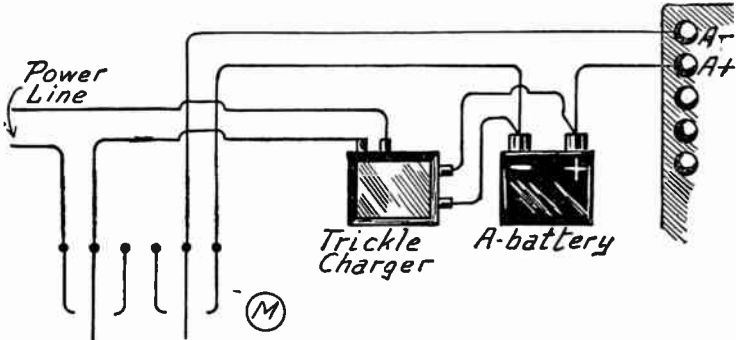

FIG. 34.—Switch for Control of Trickle Charger and Receiver.

the plate supply be turned on and the trickle charger turned off. To avoid this operation of three separate switches either a type *H* jack or a special switch of similar construction may be used as shown in Fig. 35. If the jack is used as a switch it is necessary to use an ordinary phone plug to operate it, but with no connections made to the plug itself.

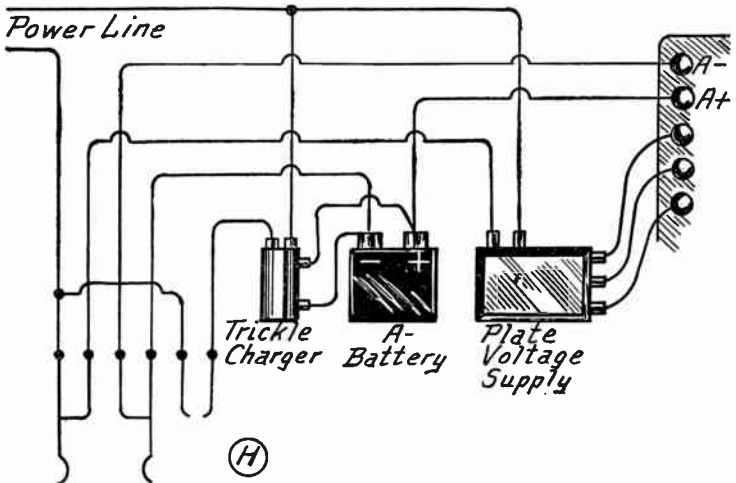

FIG. 35.—Jack Switch for Power Supply Control.

With the plug withdrawn as in Fig. 35 the receiver will operate; the A-battery being connected, the plate voltage supply turned on and the trickle charger turned off. With the plug inserted and left inserted the receiver will cease to operate, the plate supply will be disconnected from the power line and the trickle charger will be placed in operation.

JAMMING.—A name for interference. See *Interference*.

K

K.—The symbol for a constant or factor of various kinds such as dielectric constant, coefficient of coupling, etc.

KENOTRON.—A two-element type of rectifying vacuum tube containing only a filament and a plate. This tube is exhausted to a very high vacuum so that its action depends on the electron flow and not on any conductivity of ionized gas as in gas filled rectifier tubes.

The kenotron is made in various sizes, from small ones handling less than fifty milliamperes of current up to those which will rectify a number of kilowatts of power. The amount of rectified current that may be secured from one of these tubes depends on the filament emission and the voltage applied to the plates. The plate forms the negative terminal when the tube is considered as source of electric current. See also *Tube, Rectifier Types of*.

KEY.—A lever which operates contacts for the rapid opening and closing of an electric circuit is called a key. The key of a radio telegraph instrument controls the sending circuit.

KILO.—A prefix meaning "one thousand." It indicates that the value expressed by a word having kilo- as its first four letters is to be taken as one thousand times that of the unit which follows these four letters. Thus; a kilocycle is equal to 1000 cycles, a kilowatt is equal to 1000 watts, etc.

KILOCYCLES.—See *Wavelength, Frequency Relation to*.

KIT, CONSTRUCTION.—A collection of radio receiver parts for use in building a receiver of some type is called a kit. Kits generally contain the principal tuning elements such as condensers and coils and may also contain parts of the audio frequency amplifying apparatus. A few kits are put up in complete form, that is, with everything necessary to build a receiver, but the majority require additions whose value may be as much or even more than the cost of the kit.

KNIFE SWITCH.—See *Switch, Knife*.

KNOB.—A knob is a small dial-like attachment put on the end of the shaft for any variable control unit. Knobs seldom carry any marks of graduation but usually have arrows or pointers.

L

l.—The symbol for length.

L.—The symbol for inductance. See *Inductance*.

L-ANTENNA.—See *Antenna, Forms of*.

LAG, ANGLE OF.—See *Phase*.

LAMINATED INSULATION.—See *Insulation, Moulded and Laminated*.

LAMINATION.—Any part constructed of a large number of thin layers is said to be laminated and the layers are called laminations. Transformer cores are made of laminated iron, that is, of a large number of very thin sheets of iron. Insulators are often laminated to increase their resistance.

LAMP, PILOT OR PANEL.—A small incandescent lamp is often connected in parallel with the filament lighting circuit of a

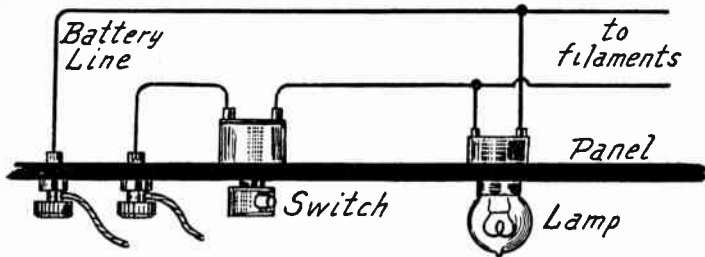

Pilot Lamp Connections.

receiver so that the lamp glows and indicates that the filament switch is closed. The connections for such a lamp are shown in the diagram.

LAMP SOCKET ANTENNA.—See *Antenna, Light and Power Circuit for*.

LATTICE WOUND COIL.—See *Coil, Honeycomb*.

LAW, OHM'S.—The relation between volts, amperes and ohms, from which any one of the values may be found when the other two are known, is called Ohm's law. The rules based on this law are among the most useful in electricity and it is best to become familiar with their application to practical problems.

In writing Ohm's law, use is made of symbols or letters which stand for volts, amperes and ohms. For volts the letter E is used, standing for Electromotive Force; for amperes the letter I is used, standing for Intensity of current; and for ohms the letter R is used, standing for Resistance.

The number of ohms resistance is equal to the number of volts divided by the number of amperes. Written in the form of a formula this would be:

LAW, OHM'S

$$\text{Ohms} = \frac{\text{Volts}}{\text{Amperes}}$$

Substituting the letters or symbols, the formula is:

$$R = \frac{E}{I}$$

The number of volts pressure is equal to the number of amperes times the number of ohms, and as a formula this would be:

$$\text{Volts} = \text{Amperes} \times \text{Ohms}$$

Then substituting the letters, the formula is:

$$E = I \times R$$

The number of amperes is equal to the number of volts divided by the number of ohms, and as a formula this is:

$$\text{Amperes} = \frac{\text{Volts}}{\text{Ohms}}$$

And substituting the letters:

$$I = \frac{E}{R}$$

If one of these formulas is true, then the others must also be true, as may be easily seen by taking certain values for the letters; for example, 3 amperes, 6 volts, and 2 ohms as the values in a certain circuit. Then, taking the first formula and substituting these numerical values, we have:

$$R = \frac{E}{I} \quad \text{or} \quad 2 \text{ (ohms)} = \frac{6 \text{ (volts)}}{3 \text{ (amperes)}}$$

It is seen that 2 is equal to 6 divided by 3, as the formula shows. Then, taking the second formula and substituting the numbers:

$$E = I \times R \quad \text{or} \quad 6 = 3 \times 2$$

And, taking the third formula with the numerical values:

$$I = \frac{E}{R} \quad \text{or} \quad 3 = \frac{6}{2}$$

Many problems encountered in receiver construction and in the location and remedy of troubles are simplified when considered in their relation to the facts of this law.

LAW, RADIO

A few applications of Ohm's law will be given. In Fig. 1 is shown the determination of the number of ohms resistance in a rheostat where this value is unknown. An ammeter is connected in series between the rheostat and any convenient battery and a voltmeter is connected across the terminals of the rheostat. The other side of the rheostat is then connected to the battery as shown. Supposing that the current is shown to be six amperes and the voltage to be 0.2 on the voltmeter. Substituting these values in the formula for resistance we would find that the number of ohms resistance in the rheostat is equal to 6 divided by 0.2, giving 30 ohms as the resistance to be found.

In Fig. 2 is shown the determination of the drop in voltage through a resistance of 20 ohms when the resistance is carrying a current of one-quarter ampere. Now substituting the known values in the formula for voltage we have $\frac{1}{4}$ (ampere) times 20 (ohms). One-quarter of 20 is 5, therefore, the voltage drop across the resistance is 5 volts.

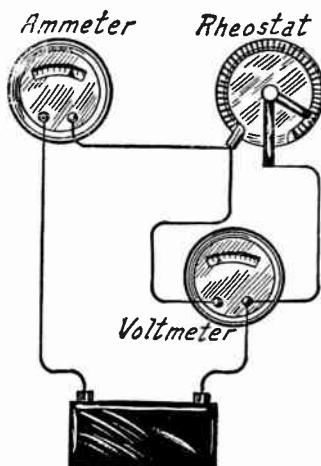

FIG. 1.—Determining Rheostat Resistance with Ohm's Law.

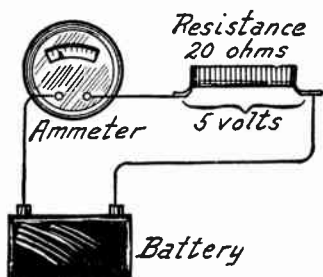

FIG. 2.—Determining Voltage Drop with Ohm's Law.

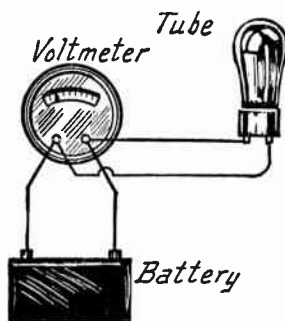

FIG. 3.—Determining Current with Ohm's Law.

Fig. 3 shows the determination of current flow in amperes through a known resistance connected to a known voltage. Assuming the tube to have a resistance of 24 ohms in its filament and to be connected across a battery giving 6 volts. Substituting these values in the formula for current we have the current as equal to 6 (volts) divided by 24 (ohms). Six divided by 24 equals $\frac{1}{4}$, so the tube will take a current flow of one-quarter of an ampere.

LAW, RADIO.—The law governing radio communication in the United States is known as The Radio Act of 1927. It became a law February 23rd, 1927.

Radio communication is defined as an electrically transmitted message, signal, picture, communication, intelligence or energy without the aid of connecting wires.

LAW, RADIO

A license is required for all transmitting apparatus and no such apparatus may be operated without a license. There can be no ownership of a radio channel and the right to use such a channel is waived before a license is granted. The granting of a license or the renewal of one, as well as any modification of an existing license, is determined according to the public convenience, interest or necessity. The applicant for a license is required to state technical and financial qualifications as well as the proposed station's purpose, location, frequency, power output, hours of operation, etc. Licenses are granted for a period not longer than three years.

A license may be revoked for any violation of the radio law, for unjust practices in service rendered, for failure to operate according to the license, etc. No license is granted to any foreign organization, foreign government, alien owner, to any body having an alien officer or one in which more than one-fifth the capital stock may be voted by aliens.

Five radio zones are created in the United States. Operating periods, frequencies and output powers are required to be equitably distributed among the states and communities.

The act created a radio commission of five members with power to regulate operating periods, frequencies, output power, type of apparatus, sharpness of tuning, etc. Changes are to be with the consent of the licensee unless the public interest requires otherwise. The commission is empowered to make investigations and to hold hearings. None of the commissioners may be financially interested in the sale or manufacture of radio material nor in broadcasting. No more than three of the five members may belong to the same political party.

After the first year following adoption of the act, the Secretary of Commerce has all the commission's powers except that of revoking licenses. The Secretary has full control over licensed operators. He is required to refer to the commission all disputes on applications and an appeal on any of his actions may be taken to the commission. Decisions of the commission may be appealed to the federal courts.

Radio communication is bound by the laws which regulate restraint of trade and monopoly. No license will be issued to an organization attempting establishment of a monopoly. For purposes of restraint of trade, no radio organization may control cable, telephone or telegraph lines. No cable, telephone or telegraph company may, for restraint of trade, control nor operate a radio station.

Minimum station power is to be used for all except distress signals, for which maximum power is allowed. There is no censoring allowed by the licensing authority and radio stations must give equal opportunity or may refuse all facilities to all candidates for certain offices. All furnished or paid broadcast matter must be identified as such. All obscene, profane or indecent language is prohibited. Rebroadcasting any material without permission is prohibited.

LAW, SQUARE

LAW, SQUARE.—The average plate current from a detector tube varies as the square of the voltage or amplitude of the signal impressed on the detector's grid. This is called the square law.

LAYOUT, RECEIVER.—See *Construction, Receiver*; also *Tools and Drilling*.

L-C VALUES FOR RESONANCE.—See *Resonance, Inductance-Capacity Values for*.

LEAD, ANGLE OF.—See *Phase*.

LEAD-IN, ANTENNA.—See *Antenna, Lead-in for*.

LEAK, GRID.—A grid leak is a high resistance unit connected between the grid terminal of a detector tube or an amplifying tube and some part of the filament circuit for that tube. Grid leaks have resistances from 50,000 ohms to ten megohms.

Many kinds and types of grid leaks have been used and are being used. The original grid leak consisted of a few pencil marks drawn on a piece of paper and placed between the points usually occupied by the leak. The resistance of this leak was reduced by adding more pencil marks and was increased by erasing pencil marks. Naturally such a leak is affected by every change in weather or temperature. More modern leaks are made with pieces of paper, fibre or cloth impregnated with or covered with some form of carbon. These resistance units are mounted inside of short lengths of glass tubing to which are attached metal end caps which fit into spring clips. Such leaks are quite satisfactory when the internal connections are electrically perfect and mechanically permanent. It is also necessary that the tube caps fit tightly to exclude moisture.

Recent types of grid leaks are made with units formed by depositing metal upon various kinds of insulating material, these units being enclosed in glass tubes similar to the type just mentioned. Still other grid leaks are made by depositing a metal coating of high resistance on the inside of a glass tube under the influence of great heat. These last two types are generally called metallic or metallized grid leaks.

Grid leaks are rated according to their resistance in megohms (millions of ohms) or in fractions of a megohm. Values in common use include $\frac{1}{4}$, $\frac{1}{2}$, $\frac{3}{4}$, 1, $1\frac{1}{2}$, 2, $2\frac{1}{2}$, 3, 5 and 10 megohms. One of the greatest troubles with grid leaks is the uncertainty and the unreliability of their resistance rating. With many kinds of leaks a certain rating in megohms may mean almost anything within several hundred per cent of this value.

Because of this uncertainty and because of advantages to be obtained by changing the grid leak resistance to suit changing conditions of reception, variable grid leaks have been designed and are in fairly common use. Considered from the standpoint of design and construction there are literally dozens of different types of variable grid leaks. Some of them are excellent and others are exceedingly poor in their operation. Variable grid leaks are made in different ranges, such as from $\frac{1}{10}$ to 5 megohms in one unit, from 2 to 10 megohms in another unit and so on for any ranges that are useful. See also *Resistor*.

Detector Grid Leaks.—A high resistance of between one and ten megohms is connected between the grid terminal of a detector tube and some part of a circuit leading directly or indirectly to one of the filament terminals, either positive or negative. The purpose of this leak is to assist in the control of the grid bias of the detector tube and also to allow dissipation of the excess negative charges

LEAK, GRID

that accumulate on the grid of this tube. For a discussion of the action of the detector grid leak see *Detector, with Grid Condenser and Leak*.

The grid leak is connected either from the grid terminal of the tube to one of the filament terminals or else is connected in parallel with and across the grid condenser. As shown in Figs. 1 and 2 these two connections amount to very much the same thing, since in either case one end of the leak connects to the grid terminal and the other end connects to the filament terminal either directly or through a coil in the grid circuit. Which method is adopted is mostly a matter of convenience.

The proper value of grid leak depends on the type of tube used as a detector, on the strength of signal being received, and on the characteristics of the receiver, especially those affecting its tendency toward oscillation.

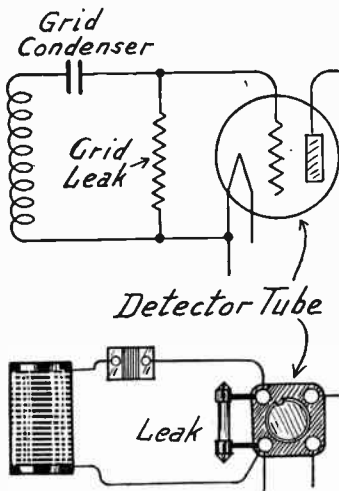

FIG. 1.—Grid Leak Connected to Detector Tube Terminals.

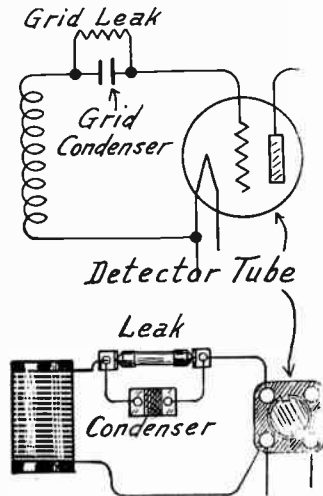

FIG. 2.—Grid Leak Connected Across Grid Condenser.

The weaker the signal being received the higher the resistance which should be used in the grid leak to secure maximum volume. On the other hand strong signals call for a comparatively low resistance leak in order to preserve good tone quality. With a hard tube in use as a detector, grid leaks of from two to five megohms are generally most satisfactory. The same values are suitable for use with the newer gas content or alkaline vapor detector tubes. The old style soft tube using one ampere of filament current requires a grid leak of only one-half megohm for proper operation. The best value of leak for a certain receiver under given conditions can be determined only by trial of a number of sizes.

If the grid leak is of too high resistance it will be indicated by a tendency of the receiver to howl and squeal without much provocation. The detector tube also tends to block, this blocking being indicated by a series of rapid

LEAK, GRID

clicks or by regular popping noises. These clicks or pops may occur very close together or may be separated by a considerable fraction of a second.

If the receiver is of the regenerative type or of a type using resistance control of regeneration under some other name, a grid leak of too high resistance will cause a very rapid increase of regeneration as the control is moved. Regeneration will tend to change into oscillation very easily. It should be borne in mind that the regeneration control of a receiver may go under the name of volume control, sensitivity control, or almost any other wording that indicates a control over the power or distance getting ability of the receiver.

If the resistance of the grid leak is too small the volume of reception from distance stations will be poor. It may be found quite difficult to make the receiver regenerate satisfactorily. When the regeneration control is brought up to a point of satisfactory reception the receiver will be quite likely to go into oscillation without any of the dials or controls being touched. This change into the oscillating condition may be caused by a strong signal, by static, or by any jarring or movement of the receiver. It is then necessary to move the regeneration control considerably below the point of satisfactory reception before oscillation stops. When the volume is again increased by increasing regeneration there is the same danger of oscillation all over again. This indicates a grid leak of too low resistance.

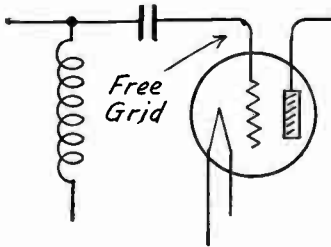

FIG. 3.—Grid Isolated by Condenser With No Leak in Use.

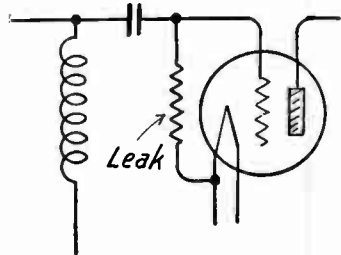

FIG. 4.—Application of Grid Leak to Stabilize Grid Circuit.

Amplifier Grid Resistance.—Grid leaks or resistances are also used for tubes in resistance coupled and in impedance or choke-coil coupled amplifiers. Whenever the grid of a tube is connected directly to a condenser of any kind a grid leak is required. The condenser may be a blocking or stopping condenser used to keep high voltage plate current from the grid of an amplifying tube.

With the grid connected to such a condenser it is impossible to apply a proper biasing voltage except through a resistance unit. A biasing voltage is a direct voltage, not an alternating voltage, and cannot act through a condenser which forms an open circuit for direct voltages.

As shown in Fig. 3, were the grid connected to a condenser alone its normal voltage without a signal coming in would be the free grid voltage. The action of the tube would then be very erratic since the grid would be released from the control effected by a biasing voltage. The application of a leak is shown in Fig. 4.

Under such conditions the biasing voltage for the grid of the tube is determined by the leak and by the point to which its filament end is connected. Connection to the negative filament line applies a negative bias while connection to the positive filament terminal applies a positive bias. See also

LEAKAGE FLUX

Amplifier, Audio Frequency, Impedance Coupled and Amplifier, Audio Frequency, Resistance Coupled.

LEAKAGE FLUX.—See *Flux, Leakage.*

LEAKAGE, SURFACE AND VOLUME.—The flow of current which occurs across the surface of an insulator is called surface leakage. It is distinguished from volume leakage which is the flow of current that takes place through the mass or body of an insulator. See also *Condenser, Losses in.*

LETTERS, STATION CALL.—Radio broadcasting stations are designated according to certain letters of the alphabet which

CALL LETTERS—ALPHABETICAL

First Letters in All Calls	Nation	First Letters in All Calls	Nation
AA to AM.....	Germany	N.....	United States
AQ to AW.....	Norway	OA to OB.....	Peru
AY.....	Venezuela	OC to OF.....	Great Britain
B.....	Great Britain	OG to OI.....	Denmark
CA to CE.....	Chile	OK.....	Czecho-Slovakia
CF to CK.....	British Colony	OM.....	Netherlands
CL to CM.....	Spain	ON to OT.....	Belgium Colony
CI.....	Great Britain	OU to OZ.....	Denmark
CP.....	Bolivia	PA to PI.....	Netherlands
CR.....	Portuguese Colony	PN to PP.....	Brazil
CS to CU.....	Portugal	PQ to PS.....	Portugal
CW.....	Uruguay	PT to PV.....	Brazil
CX.....	Spain	PW.....	Cuba
CY.....	Mexico	PX to PZ.....	Netherlands
DA to DS.....	Germany	RA to RQ.....	Russia
DU to DZ.....	Germany	RX.....	Panama
DT and KAZ.....	Danzig	SA to SM.....	Sweden
EA to EH.....	Spanish Colony	SN to ST.....	Brazil
EI to EZ.....	Great Britain	TF.....	Iceland
F.....	French Colony	TI to TO.....	Spain
G.....	Great Britain	TP to TU.....	Norway
HA.....	Hungary	TV to TZ.....	Netherlands
HB.....	Switzerland	UA to UM.....	French Colony
HC.....	Ecuador	UN.....	Serbia
HD to HE.....	Netherlands	UO.....	Austria
HF.....	Serbia	UP to UZ.....	Italy
HJ to HK.....	Colombia	VA to VG.....	Canada
HL to HNU.....	Spain	VH to VK.....	Australia
HO to HZ.....	French Colony	VL to VM.....	New Zealand
I.....	Italian Colony	VO.....	Newfoundland
J.....	Japan	VP to VS.....	British Colony
KA to KAY.....	Germany	VX to VZ.....	British Colony
KB.....	Germany	W.....	United States
KD to KZ.....	United States	XA to XD.....	Mexico
LA to LH.....	Norway	XE to XM.....	Great Britain
LI to LR.....	Argentina	XN to XS.....	China
LS to LU.....	Great Britain	XT to XZ.....	Great Britain
LW.....	Norway	Y.....	Great Britain
LX to LZ.....	Bulgaria	Z.....	Great Britain
M.....	Great Britain		

LETTERS, STATION CALL

form the station's call letters. A typical list of such call letters for several American stations is shown under the heading *Calibration of Receiver*.

All of the countries of the world in which are located radio transmitting stations have been assigned certain letters and combinations of letters. The preceding list shows the letters in alphabetical order followed by the name of the nation to which they are assigned. Only the first letter or the first two letters in all calls are given in

CALL LETTERS—BY COUNTRIES

Argentina.....	LI-LR
Austria.....	UO
Australia.....	VH-VK
Britain.....	B CO EI-EZ G LS-LU M OC-OF XE-SM XT-XZ Y Z
Colonies, etc.....	CF-CK VP-VS VX-VZ
Bolivia.....	CP
Bulgaria.....	LX-LZ
Belgium—Colonies.....	ON-OT
Brazil.....	PN-PP PT-PV SN-ST
Chile.....	CA-CE
Colombia.....	HJ-HK
Czecho-Slovakia.....	OK
Cuba.....	PW
Canada.....	VA-VG
China.....	XN-XS
Denmark.....	OG-OI OU-OZ
Ecuador.....	HC
France—Colonies.....	F HO-HZ UA-UM
Germany.....	AA-AM DA-DS DU-DZ KA-KAY KB
Danzig.....	DT KAZ
Hungary.....	HA
Iceland.....	TF
Italy.....	UP-UZ
Colonies.....	I
Japan.....	J
Mexico.....	CY XA-XD
Norway.....	AQ-AW LA-LH LW TP-TU
Netherlands.....	HD-HE OM PA-PI PX-PZ TV-TZ
New Zealand.....	VL-VM
Newfoundland.....	VO
Portugal.....	CS-CU PQ-PS
Colonies.....	CR
Peru.....	OA-OB
Panama.....	RX
Russia.....	RA-RQ
Spain.....	CL-CM XC HL-HNU TI-TO
Colonies.....	EA-EH
Switzerland.....	HB
Sweden.....	SA-SM
Serbia.....	HF UN
Uruguay.....	CW
U. S. Commercial Stations.....	KDA-KZZ WAA-WTZ WWA-WWZ
Army.....	WUA-WVZ WXA-WZZ
Navy.....	NAA-NZZ
Venezuela.....	AY

LEVEL, STATIC

this list, since it is the first letter or first two letters which determine the country from which the signal is being sent.

LEVEL, STATIC.—The static level or the noise level is the combination of all the noises coming into a receiver. These noises are caused by true static, by any kind of interference, by squealing and re-radiating receivers, or by anything that forms electrical impulses which may be picked up and amplified.

The static level determines and limits the distance from which reception may be had with a receiver capable of great amplification. As stations sought for become more and more distant, the strength of their signals which finally reach the receiving antenna is weaker and weaker. A point is reached at which the feeble signal of the far distant station has less strength than the impulses forming the static level. It is then impossible to receive such a station because, as the receiver attempts to amplify its signal into audibility, so will the noises be equally amplified and will continue to be louder than the signal sought for. See *Static*.

LIGHT.—See *Television*.

LIGHTNING ARRESTER.—See *Arrester, Lightning*.

LIGHTNING SWITCH.—See *Switch, Lightning*.

LINE RADIO.—See *Radio, Wired*.

LINE VOLTAGE REGULATOR.—See *Power Unit, Voltage Regulator* for.

LINES OF FORCE.—See *Field, Magnetic and Electromagnetic*.

LITZENDRAHT WIRE.—See *Wire, Stranded*.

LOAD.—Any form of resistance, reactance or impedance in a circuit is called a load. A load is that which forces a source of electric energy to do work. A load may consist of an ohmic resistance, a reactance, an impedance or any combination of these. That is to say, the load may consist of conductors, condensers, coils or any combination of these parts.

LOADING COIL.—See *Coil, Loading*.

LOCAL OSCILLATIONS.—See *Oscillation*.

LOCKING SWITCH.—See *Switch, Locking*.

LOG, OF RECEIVER.—See *Calibration of Receiver*.

LOGARITHMIC.—Any series of values, the change between successive numbers of which may be represented by logarithms, is said to be logarithmic.

The common logarithm of a number is the exponent indicating the power to which the number 10 is raised to equal the given number.

LOGARITHMIC LOUD SPEAKER.—See *Speaker, Loud*.

LONG WAVE RECEIVER.—See *Receiver, Long Wave*.

LOOP.—A loop consists of a number of turns of wire mounted upon a framework of insulating material. The diameter of the turns is large, being from one to four feet in most cases, and the adjacent turns are spaced from each other by one-quarter inch or more. The two ends of the loop are connected to a variable tuning condenser which makes the loop circuit resonant at frequencies to be received. It then acts as an antenna tuned to the frequency desired and connected to a vacuum tube grid.

LOOP, ANTENNA ACTION OF

LOOP, ANTENNA ACTION OF.—Any loop consists of vertical wires and horizontal wires. The loop might be circular or the wires placed at various angles, still we would have some wires running up and down or practically so and others running across or horizontally.

As shown in Fig. 1 a loop operates as a coil or an inductance in which the radio waves generate a signal voltage. On the other hand an open antenna, outdoor or indoor, is primarily a condenser on whose plates the radio waves build up electric charges.

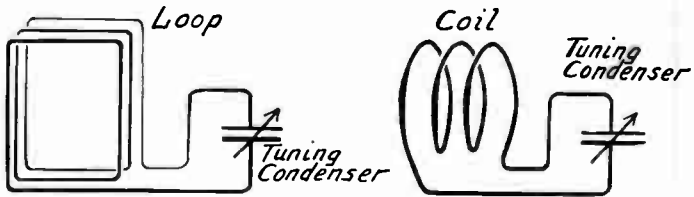

FIG. 1.—The Loop Is, in Effect, an Inductance Coil.

The radio signal may be considered as traveling horizontally away from the transmitting station. Oncoming radio waves will strike first one edge of the loop, then pass across to the other edge. As a wave strikes one side of the loop it causes a voltage to be generated in the vertical wires on that side. The wave then travels across the loop, strikes the other side, and causes an exactly equal voltage to be generated in the vertical wires on the other side of the loop. The two voltages oppose each other as may be seen from Fig. 2. Both voltages tend to force current up or both tend to force it down

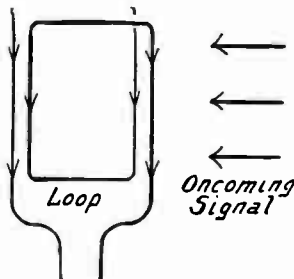

FIG. 2.—Equal Voltages Generated in Both Sides of Loop.

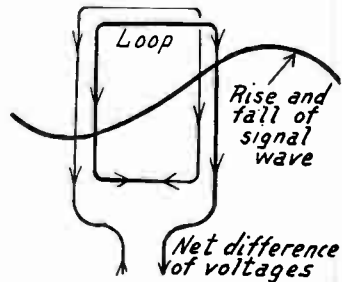

FIG. 3.—The Phase Difference Allows a Net Voltage to Be Delivered by a Loop.

on both sides of the loop. Naturally two currents flowing down on opposite sides of the coil formed by the loop will meet each other, and if they meet at exactly the same time and in equal quantities will balance each other completely. The same thing will happen with two currents both flowing upward on opposite sides of the loop.

LOOP, ANTENNA ACTION OF

The only reason the loop delivers any signal to a receiver is because the two voltages generated on opposite sides of the loop are not generated at exactly the same time. The voltage in the side of the loop toward the transmitting station, in the side the radio wave strikes first, rises to its maximum a little before the maximum voltage in the side of the loop away from the transmitting station. There is a difference in phase or in time between the two voltages.

Because of this difference in phase the voltage peak in one side of the loop will occur when the voltage in the other side is not quite at its peak as in Fig. 3. The difference between the higher voltage on one side of the loop and the lower voltage on the other side of the loop will be the net voltage that is available as signal strength in the receiver.

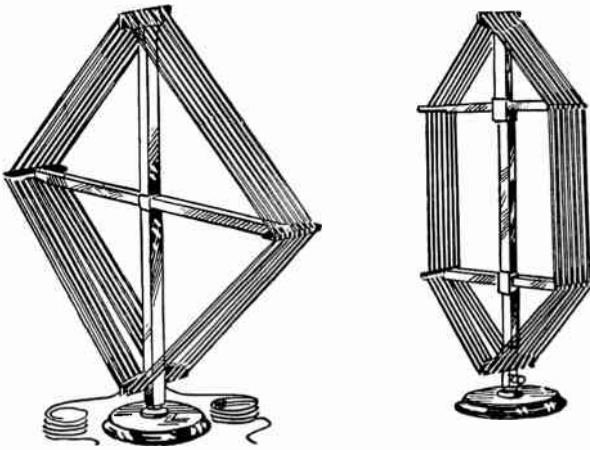

FIG. 4.—Box Type Loops.

Were it possible to build the loop with its sides so far apart that they would be separated by one-half the length of the wave we would have ideal conditions because the rise of the wave to positive voltage would then act on one side of the loop while the increase of the wave in negative voltage acted on the other side of the loop. To build loops as wide as one-half a wavelength would mean they would be of the general proportions of battleships and this is not practical. It is true however that the greater the distance between the sides of the loop the greater will be the power received.

The higher the loop the greater will be the length of the vertical sides. The greater the length of wire exposed to the radio wave the greater will be the voltage generated in such a wire. Therefore, the higher the loop or the longer its vertical sides the greater will be the signal strength received by the loop.

Thus the signal is increased by increasing the width of the loop and it is also increased by increasing the height of the loop. The greater the area of the loop the greater will be the signal strength it delivers.

The signal energy received by a loop increases with increase of the number of turns or with increase of the inductance of the loop. The signal energy increases with decrease of resistance in the loop. A loop will receive short

LOOP, ANTENNA ACTION OF

wave or high frequency signals with more power than it will receive long wave or low frequency signals. The average loop picks up less than one-tenth the signal strength that is picked up by the average outdoor antenna. Even though the total length of wire be the same on two loops of different area, the strength of signal from the loop of larger area will be much greater than from the one of smaller area. Under this condition the signal strength varies almost directly with the area.

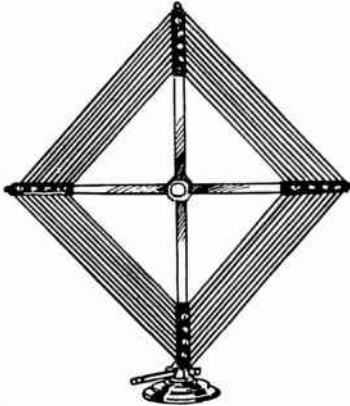

FIG. 5.—A Spiral Loop.

The resistance of a loop increases rapidly as its natural frequency is approached. The natural frequency is determined by the inductance and the distributed capacity of the loop. For best results the wavelength of the signal must be equal to at least three times the natural wavelength of the loop. For wavelengths closer to the natural wavelengths the results will be unsatisfactory. Therefore, for short waves or high frequencies the operation of a small loop may be better than that of a larger one.

The capacities between parts of the loop circuit cause it to act as an ordinary antenna as well as act as a loop. For this reason the actual strength of signal received by a loop is always greater than the strength that might be expected from calculation only. This antenna effect is one reason why the signal from a loop can never be reduced to zero no matter how the loop is turned with reference to the direction of signal travel. The loop effect or the coil effect might be completely eliminated but the antenna effect would remain. Under some conditions it is found that the antenna effect is stronger than the coil effect in the loop.

The approximate ratio between the signal strength from a loop and from an outdoor antenna is shown by the following formula:

$$\text{Signal Strength} = \frac{\text{Loop Area} \times \text{No. of Turns}}{\text{Antenna Height} \times \text{Wavelength in Meters} \times 0.1593}$$

Thus: assume a loop with an area of 3 square feet and with 15 turns to be compared with an antenna 30 feet high, both operating at a wavelength of 300 meters. The upper part of the ratio would be equal to 3×15 , or 45 as representing the strength of loop signal. The lower part of the ratio is equal to $30 \times 300 \times 0.1593$, or 1333.7 as representing the strength of antenna signal. The ratio of loop signal to antenna signal is then $45/1333.7$ or approximately one thirtieth in strength.

There are two principal types of loops, one called the box loop and the other the spiral loop. The box loop of Fig. 4 is made with its turns side by side around the outer circumference of a framework, and has approximately the shape of a single layer coil of

LOOP, ANTENNA AND GROUND CONNECTIONS

great diameter and little length. The spiral loop of Fig. 5 is wound on the spokes of a flat form, the inside turn of the winding being toward the hub or center and the following turns being wound around and around, progressing toward the outer edge of the framework.

LOOP, ANTENNA AND GROUND CONNECTIONS TO.—As a general rule a loop alone is sufficient to furnish signal energy for a receiver. Some receivers are constructed so that they

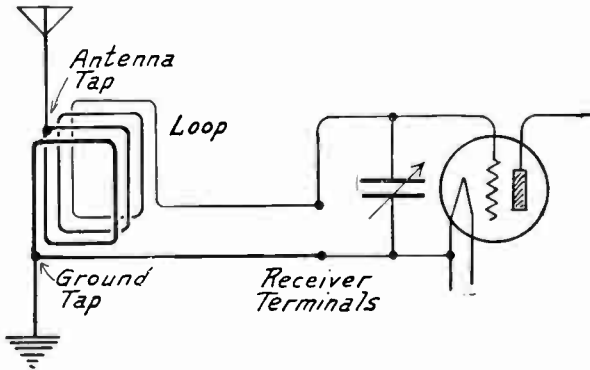

FIG. 1.—Using Antenna and Ground with a Loop.

may be operated either with the loop or with an antenna and ground connection, the loop being cut out while the antenna system is employed. The method of making such connections through a loop jack or a switch is shown under *Jacks and Switches, Uses of*.

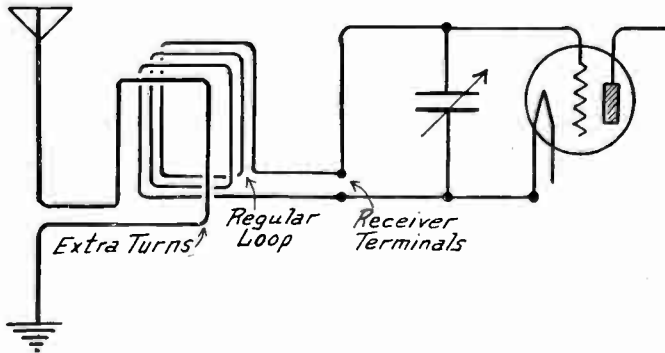

FIG. 2.—Additional Turns for Antenna with Loop.

It is also possible to use a loop and an antenna or ground at the same time. The loop may be used as if it were the secondary of a tuned coupler or tuned radio frequency transformer in any of the following ways.

LOOP, BOX TYPE

From the end of the loop already connected to the filament circuit of the receiver, make an additional connection to ground as in Fig. 1. Allow the loop connection to the receiver to remain in place. At a point in the loop which is two or three turns from this ground connection make a tap and connect this to the antenna. The other end of the loop is to remain connected to the grid of the first tube in the receiver. The loop tuning condenser is not touched or altered.

Another method is to wind two or three additional turns on the loop frame, placing them near the end or side of the loop that connects to the filament circuit in the receiver. Connect one end of these added turns to the antenna and the other end to ground. This principle is shown in Fig. 2.

It is also possible to use two separate loops of different size, one inside the other as in Fig. 3. The larger outside loop should be connected to the receiver in the usual way and the smaller inside loop should be connected to the antenna and to ground. Turning these two loops at greater angles to each other will reduce the coupling, reduce the power and increase the selectivity of the arrangement.

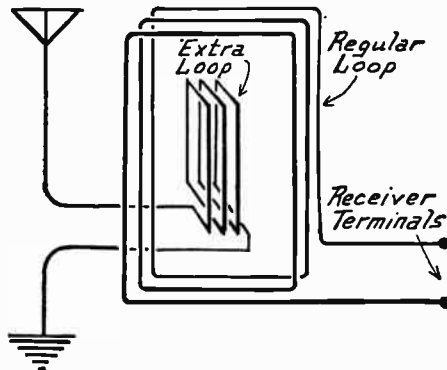

FIG. 3.—Use of Extra Loop for Antenna and Ground Circuit.

An increase of signal strength, but with a loss in selectivity, may be obtained by connecting one end of the loop to ground as in Fig. 1. Ground the end which does not lead to the grid of the first tube in the set, that is, ground the end which leads to the filament of the first tube, or to the filament circuit of the receiver. No antenna is used with this scheme.

All of these uses of an outdoor antenna and ground with the loop will reduce the selectivity and increase the distance range of the receiver.

LOOP, BOX TYPE.—A box type loop may be made to swing around a vertical axis, being then higher than broad. Or it may swing on a diagonal axis between two opposite corners. There is little difference in signal strength with any particular mounting.

The box type loop has greater inductance than the spiral type for a given length and resistance of wire. However, the box type has somewhat greater distributed capacity than a spiral type with equal spacing of the wires. This is because the terminals of a box loop are closer together than the terminals of a spiral loop of the

LOOP, DESIGN AND CONSTRUCTION

same inductance and because a box loop has less voltage drop between turns.

It is often claimed that the box loop has somewhat less directional effect or less selectivity than a spiral loop but in actual practice there is little if any difference between the two types on this score.

Box loops must generally be at least fifteen inches on a side if sufficient inductance is to be obtained without too many turns. The larger a box loop the more efficient it will be as a collector of radio energy. Loops having their sides four feet long do excellent work and still larger sizes may be employed if space permits.

LOOP, DESIGN AND CONSTRUCTION OF.—In building a loop for a receiver the safest method is to use an excess length of wire to begin with. After the loop is wound, a high wavelength or low frequency broadcasting station should be tuned in. If the dial setting of the loop tuning condenser is much too low, that is, if too little of the condenser is used for this wavelength, wire should be removed from the loop. Take off one-half turn at a time. The loop should be retuned after each alternation and wire should be removed until the dial setting is correct for the station being received.

The inductance of the loop and the maximum capacity of the tuning condenser used with it determine the highest wavelength or lowest frequency to which the combination will be resonant. It would be highly desirable to use a loop with large inductance and a very small tuning condenser because the large loop would collect much more energy than a small one and the voltage changes across it would be greater than those across a small one.

However, it is unfortunate that such ideal combinations cannot be made to handle the entire range of broadcasting frequencies. The small condenser has not sufficient change of capacity between minimum and maximum settings to change the L-C value over the necessary amount for tuning. Furthermore, the distributed capacity of the loop winding forms a much larger proportion of the whole capacity in the circuit when the variable condenser is a small one and this distributed capacity in the loop is not subject to variation for tuning.

It will be found that a tuning condenser of .00025 microfarad capacity is slightly too small for loop work in many cases. With a carefully constructed loop having the wires well spaced a .00035 condenser will generally cover the entire broadcasting range. A condenser of .0005 microfarad capacity will be still easier to tune and the signal power will be only slightly reduced. It should hardly be necessary to use a .001 microfarad condenser to tune a loop.

Condenser Capacities.—Loops with few turns have a greater range of tuning than those with many turns. The big problem in designing and building a loop is to reach the lower wavelengths or higher frequencies when a small condenser is used. It is desirable to use the largest loop and smallest possible condenser because the larger the loop in area and number of turns the greater will be the signal strength collected. With such a combination the minimum capacity of the condenser must be small and the distributed capacity of the loop must likewise be small, otherwise the two capacities combined will prevent tuning to low wavelengths because of the combination of the capacity with the large inductance in a big loop. By using a larger condenser and a smaller loop the change of capacity in the condenser between minimum and maximum settings

LOOP, DESIGN AND CONSTRUCTION

is great enough to avoid trouble in tuning, but the signals will not be as strong.

The wires on the sides of the loop may be run in two banks staggered with reference to each other as at the left in the illustration. They may also be run at angles with one another as at the right in the same drawing. Either of these methods reduces the distributed capacity of the loop but reduces the inductance at the same time.

Length of Wire on Loop.—The length of wire on a loop has no direct bearing on the frequency or wavelength to which the loop will respond. The frequency depends on the inductance of the loop just as the frequency to which a coil will respond depends on its inductance and not directly on the number of feet of wire in the coil.

Loops of average size and construction, when used to receive broadcasting stations, require about eighty-five feet of wire when the loop sides are short, and about one hundred feet with long sides. This wire should be flexible stranded, double silk covered. Loop wire generally consists of thirty to sixty strands of very fine bare copper wire such as number 38. Solid or stranded wire may be of number 14 or number 16 gauge.

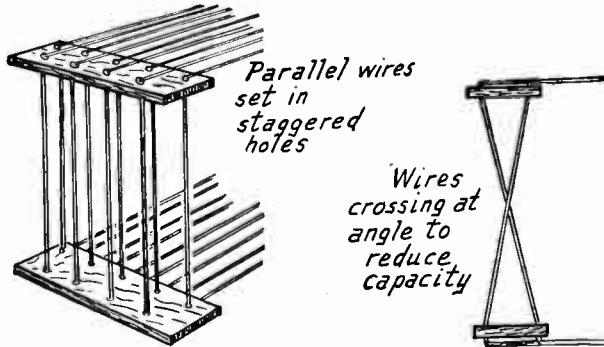

Arrangement of Wire on Loop Framework.

Construction of Frame.—The framework of a loop should have no metal inside of the turns of wire. Any metal within the loop is, in effect, inside the field of a tuning coil and the eddy currents set up in the metal cause a loss of energy. The framework of the loop should contain the least possible material of any kind and whatever material is used should have low dielectric losses. That means that the most suitable materials are the high grade moulded and laminated compounds such as Formica, Bakelite, Celoron, etc., also well prepared woods and glass.

All supporting points for the wire windings should be made of the best of insulating material. It is not sufficient to depend on the insulating covering of the wire alone. If wood is used for supports the wires should not rest directly against the wood but should be carried upon some insulation of greater resistivity.

The two ends or terminals of the loop winding should be kept at the greatest possible distance from each other. They should never

LOOP, DESIGN AND CONSTRUCTION

be connected to a duplex cable, a cable with two conductors, on their way to the receiver but should be kept well separated. This is to avoid the bypassing effect of the capacity between parallel wires and terminals that are close together.

Spacing of Wires.—A loop, like any other coil, has inductance which is desirable, and distributed capacity which is undesirable. Therefore, we do everything possible to increase the inductance for a given length of wire or resistance and do everything possible to decrease the distributed capacity without too greatly affecting the inductance.

Inductance is increased by using more turns, greater length in each turn, and less spacing between turns. Distributed capacity is reduced by using fewer turns and more spacing between turns.

It will be seen that these requirements are opposed to one another. We want more turns to increase the inductance, but fewer turns to reduce the capacity. We want less spacing to increase the inductance and more spacing to decrease the capacity.

There is a more or less critical spacing beyond which additional spacing does not greatly reduce the distributed capacity. For a loop only two feet square the gain with spacing greater than one-eighth of an inch becomes less noticeable. For a loop four feet square this critical spacing is somewhat less than one-quarter of an inch, while for a loop eight feet square the wires should be at least three-eighths of an inch from one another.

As the number of turns on the loop is increased the distributed capacity becomes greater. At first this increase in capacity is quite rapid but as more and more turns are added to the loop, bringing its ends farther apart, the increase of capacity does not keep pace with the number of turns.

Turns Required on Loops.—The following table shows the number of turns required on box loops of various dimensions when used with tuning condensers from .00025 to .001 microfarad capacity. The loops are considered as being square, that is, with four sides of equal length. These sizes run from ten inches square up to thirty-five inches square.

Dimensions are given both for length of the sides of a square loop and for the area in square inches of the side of an oblong rectangular loop. A rectangular loop having the same area as a given square will operate satisfactorily with the number of turns specified for the square loop. The longer dimension of the loop should not be more than twice its shorter dimension.

As an example, a loop having sides of 16 inches and 25 inches has an area of 400 square inches. A loop 20 inches square likewise has an area of 400 inches. The numbers of turns given in the columns for loops 20 inches square are applicable then to loops with sides 16 and 25 inches long or to any other combination of dimensions which yields an area of approximately 400 square inches.

In winding loops which are longer than they are wide and using the following tables in determining the number of turns, it is always advisable to place at least one extra turn in the beginning to care for changes brought about by the difference in shape. The extra wire may then be removed if it is found unnecessary, this being known when the loop is tried out with the tuning condenser which will be regularly used. The added turn or turns may be supported in a temporary manner while testing.

LOOP, DIRECTIONAL EFFECT OF

TURNS REQUIRED FOR RECTANGULAR LOOPS

Length of Side in Inches—Square Loop or Area of Rectangular Loop										
Condenser Capacity in Mfds.	Spacing $\frac{1}{4}$ -inch Between Turns									
	10x10 100	12x12 144	14 x14 196	16x16 256	18x18 324	20x20 400	25x25 625	30x30 900	35x35 1225	
.00025	—	—	—	25	23	21	17	15	13	
.00035	—	—	—	22	18	17	14	12	11	
.0005	—	21	18	16	15	13	11	10	9	
.001	16	13	11	10	9	9	7	6	6	
Spacing $\frac{1}{2}$ -inch Between Turns										
Condenser Capacity in Mfds.	Spacing $\frac{1}{2}$ -inch Between Turns									
	10x10 100	12x12 144	14x14 196	16x16 256	18x18 324	20x20 400	25x25 625	30x30 900	35x35 1225	
.00025	—	—	—	—	—	—	20	17	15	
.00035	—	—	—	—	23	20	16	14	12	
.0005	—	—	24	20	18	16	13	11	10	
.001	22	17	14	12	11	10	8	7	6	
Spacing $\frac{3}{4}$ -inch Between Turns										
Condenser Capacity in Mfds.	Spacing $\frac{3}{4}$ -inch Between Turns									
	10x10 100	12x12 144	14x14 196	16x16 256	18x18 324	20x20 400	25x25 625	30x30 900	35x35 1225	
.00025	—	—	—	—	—	—	24	20	17	
.00035	—	—	—	—	—	25	19	16	13	
.0005	—	—	—	26	22	19	15	12	10	
.001	—	21	17	14	12	11	9	8	7	

LOOP, DIRECTIONAL EFFECT OF.—If a loop is turned so that it is pointed edgewise toward the transmitting station, radio waves from that station will travel the greatest distance between the

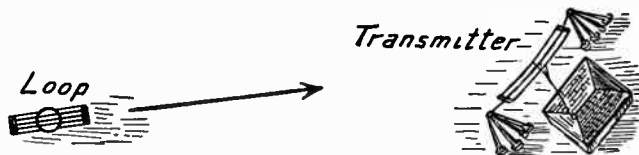

FIG. 1.—Loop Pointed at Most Favorable Direction Toward Transmitter.

LOOP, DIRECTIONAL EFFECT OF

two sides of the loop. This is shown in Fig. 1 with the loop turned at the most favorable position toward the transmitting station.

When the loop is finally turned so that its flat side is toward the transmitting station the signal strength will be least. Under this

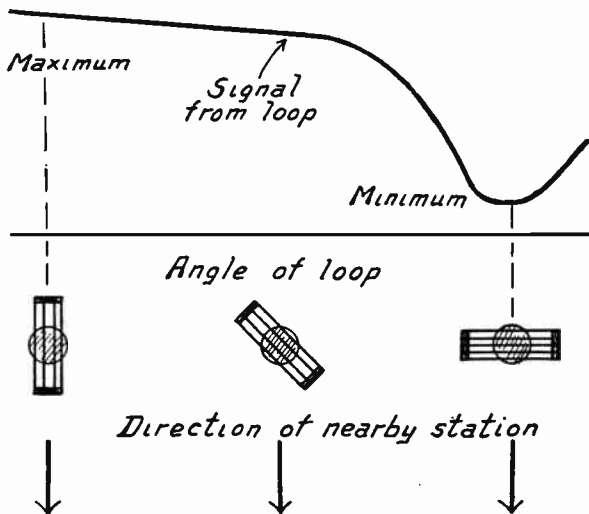

FIG. 2.—Effect on Signal of Turning Directional Loop with Reference to Nearby Transmitting Station.

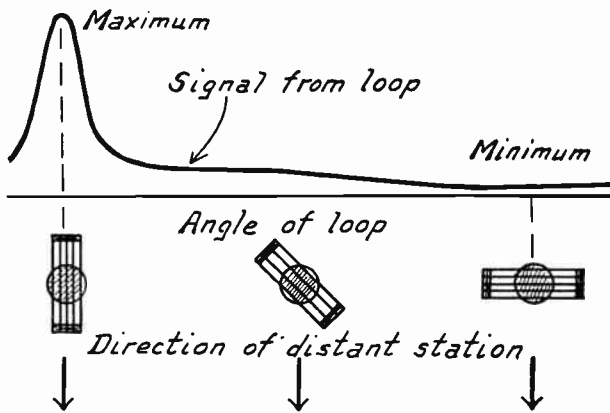

FIG. 3.—Effect of Turning Directional Loop with Reference to Distant Station.

condition the advancing radio wave strikes both sides of the loop at the same instant, generates exactly equal and opposite voltages which balance each other out completely, leaving no signal for the receiver except that due to loop capacity.

LOOP, PRECAUTIONS IN USE OF

It will be seen from the foregoing that the strongest signal will be delivered by a loop which is pointed directly toward the transmitting station, that is, when its edge is toward the station. The least signal strength is received when the loop is broadside toward the station.

Therefore, it is possible to partially or wholly tune out an undesired station by turning the loop broadside toward it. Pointing the loop will greatly increase the signal strength from a distant station. One of the greatest advantages of the loop is in this ability to tune out unwanted signals while receiving the desired signals with maximum strength.

In using a loop it will be found that the signal strength from a nearby station remains approximately the same until the loop is turned almost exactly at right angles to the station. The signal strength will then show a sudden and decided decrease during the last few degrees of loop movement. This is shown in Fig. 2 for various angles of a loop.

On the other hand the signal strength from a distant station will show a very gradual increase as the edges of the loop are brought into line with the direction of the radio waves. But during the final few degrees of loop movement, the movement that brings the loop directly in line with the station, a decided and sudden increase in signal strength will be noticed. This is shown in Fig. 3.

LOOP, PRECAUTIONS IN THE USE OF.—A loop will not receive signals with any satisfaction from stations whose fre-

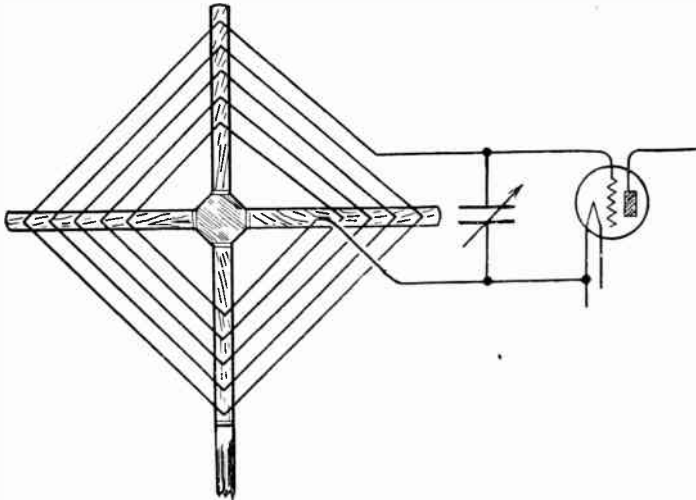

Connections from Spiral Loop to Receiver.

quency is above the fundamental frequency of the loop. This fundamental frequency of the loop is determined by the combination of its inductance and its distributed capacity. Whatever the frequency at which these two produce resonance, that is the limit of

LOOP, RECEIVERS FOR

the loop's usefulness on the lower wavelengths. This is the reason for taking every care to reduce distributed capacity.

In making connections between a spiral loop and its receiver the inside of the spiral should always be connected to the filament circuit in the receiver, as in the drawing. The outer end of the spiral will then be connected to the grid of the first tube.

It is necessary that the loop be protected from the field of any radio frequency coil or oscillator coil in the receiver. These coils often have a wide-spread and rather powerful field. A loop placed close to the receiver will pick up energy from such a coil and oscillation will be difficult to control. In a loop receiver it is often necessary to shield the radio frequency or oscillator coils or to shield the entire receiving set.

A loop receiver used in the same room with another receiver connected to an antenna and ground will be broad tuning. Experiments show that an antenna wire ten or twelve feet away from a loop will so strongly affect the loop that a station tuned in on the antenna may be heard regardless of change in loop tuning. In buildings having steel framework it may be found that a short indoor antenna is much better than a large loop.

LOOP, RECEIVERS FOR USE WITH.—See *Receiver, Loop.*

LOOP, REGENERATION WITH.—Since the amount of energy collected by a loop is very small even under the most favorable conditions, it is of great advantage to employ regeneration. This greatly reduces the effective resistance of the loop circuit at the frequency being received. Regeneration may be obtained in a loop by any of the methods which would allow regeneration in a tuned radio frequency transformer.

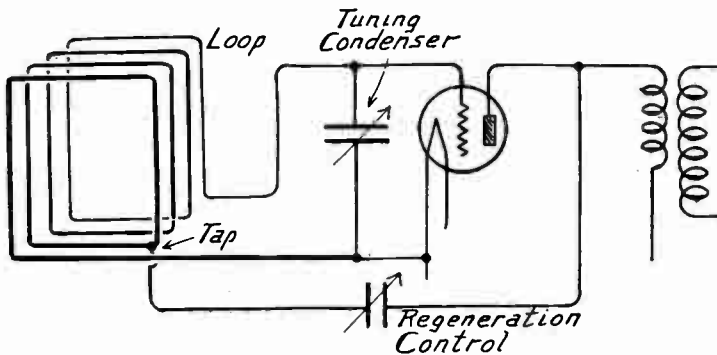

One Method of Regeneration with a Loop.

Energy from the plate circuit of the first tube may be fed back into the loop through a variable condenser of small capacity. The connections are shown in the diagram. One end of the loop is connected to the grid of the first tube. Two or more turns away from the connection to the filament circuit at the other end a tap is used. From the tap, connection is made through the small condenser to the plate circuit.

LOOP, SPIRAL TYPE

With another method a few additional turns are placed on the loop and used as a tickler winding. Current through this tickler may be controlled with a high resistance, a variable condenser or any other means generally adopted for control of tickler effect. See also *Regeneration, Methods of Obtaining*.

LOOP, SPIRAL TYPE.—A spiral type loop may be mounted to swing either upon its long or short horizontal axis or upon a diagonal axis. Spiral loops are often made of circular or oblong shape.

A spiral loop has less inductance than a box loop for the same outside dimensions and for the same length of wire used. The spiral loop has slightly less distributed capacity than a box loop, spacing and other factors being the same. See also *Loop, Box Type*.

LOOP, TAPS IN.—Dead ends are very harmful in a loop. They reduce the power and broaden the tuning. If a loop is built with a dead end and the dead end turns then removed, the wavelength to which the loop responds with a given condenser setting will be lowered, that is, the loop will respond to higher frequencies. Short circuiting the dead end turns will only make matters worse.

LOOP, WAVE TRAP WITH.—Any form of wave trap may be used in connection with a loop. A series or impedance wave trap may be placed in the lead from the loop to the filament connection in the set. An absorption wave trap may be connected in this same lead which goes to the filament connection in the receiver. See *Trap, Wave*.

LOOSE COUPLING.—See *Coupling, Loose*.

LORENZ COIL.—See *Coil, Basket Wound*.

LOSSES IN COIL.—See *Coil, Losses In*.

LOSSES IN CONDENSER.—See *Condenser, Losses In*.

LOSSES IN CONDUCTORS.—See *Resistance, High Frequency*; also *Skin Effect*.

LOSSES IN TRANSFORMERS.—See *Transformer*.

LOUD SPEAKER.—See *Speaker, Loud*.

LOW FREQUENCY.—See *Frequency, High*.

LOW-LOSS.—Radio units and parts which are described as low-loss are understood to have low radio frequency resistances and slight absorption of energy. See the following: *Coil, Losses in*; *Condenser, Losses in*; and *Resistance, High Frequency*.

LOW PASS FILTER.—See *Filter, Low Pass*.

M

m.—A symbol for mass.

M.—A symbol for mutual inductance.

MACHINE SCREWS.—See *Screws and Bolts, Types of.*

MAGNET WIRE.—See *Wire, Magnet.*

MAGNETIC CIRCUIT.—See *Circuit, Magnetic.*

MAGNETIC COUPLING.—See *Coupling, Inductive.*

MAGNETIC FIELD.—See *Field, Magnetic and Electromagnetic.*

MAGNETIC HYSTERESIS.—See *Hysteresis.*

MAGNETISM AND ELECTROMAGNETISM.—Like electricity, magnetism can be described best by telling of its actions and effects. The action most commonly thought of is that by which a magnetic piece of iron or steel attracts another piece of iron or steel to itself.

Magnetism is assumed to flow in magnetic lines of force and these lines of force travel in magnetic circuits through the magnet and through the space immediately surrounding the ends or poles of the magnet.

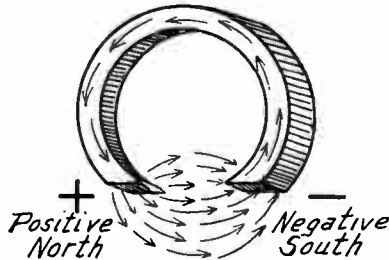

FIG. 1.—The Poles and Field of a Magnet.

These lines of force pass through the metal of the magnet from one end to the other and after issuing from the magnet travel through the surrounding space to re-enter again, thus keeping up a continuous travel or magnetic circuit as shown in Fig. 1. The end of the magnet from which the lines of force leave the magnet is called its positive pole, and the end at which they re-enter is called the negative pole.

A piece of iron or steel may be made a magnet through the influence of another piece that is already magnetic or by being acted upon by the electrical influence from a conductor carrying current. A magnet shows attraction for another magnet or for any piece of iron or steel near it.

The end at which the lines of force enter, the negative pole in other words, may also be called the south pole, while the end from

MAGNETISM AND ELECTROMAGNETISM

which the lines of force leave is called either the positive or north pole. The space in which the lines of force travel outside the magnet is called the magnetic field.

While all metals are conductors of electric current, in practical work only iron and steel can become magnets. However, lines of force easily pass through all other substances, metal or otherwise, almost as if the substances did not exist. Magnetism can be controlled only by providing paths of iron or steel for it to travel through, there being no materials that confine magnetism as insulators confine electric current.

A hard steel magnet retains magnetism until heated, violently jarred, etc., and is called a permanent magnet. Soft iron will not retain magnetism and remains magnetic only while in the field of another magnet or of a current-carrying conductor. Soft iron in contact with a magnet becomes magnetic itself.

Magnets brought near each other with like poles together show repulsion for each other; with unlike poles together, they attract each other. Two positive or two negatives repel, while a positive and a negative attract.

Magnets placed together with like poles together form a compound magnet stronger than a one-piece magnet of the same weight as all the parts together. Magnets placed together with unlike poles (positive and negative) next one another, neutralize each other's strength and there is no useful outside magnetic field.

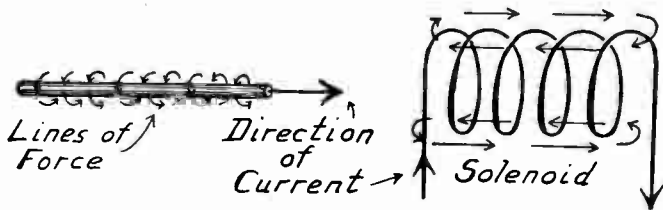

FIG. 2.—Electromagnetic Lines of Force Around a Conductor and a Coil.

Electromagnetism.—A conductor through which is flowing an electric current is surrounded by circular lines of force which whirl around the conductor as a center. These lines of force always travel around the conductor in one direction relative to the direction of current flow through the conductor and as shown in Fig. 2. If the current flow is reversed through the conductor, the direction of the lines of force is also reversed.

Should the conductor be made into a coil as shown at the right in Fig. 2, the lines of force will not make complete circles around the turns of the conductor, but will pass completely through the coil, which is now a solenoid, and will then return in the other direction around the outside of the coil.

If a piece of iron be placed within the solenoid the lines of force that were traveling inside the coil will travel through the iron in the same direction as shown in Fig. 3, making the iron a magnet whose polarity corresponds to the direction in which the current flows through the conductor. This combination of an iron core and a coil is called an electromagnet. The strength of the electromagnet depends on the number of amperes flowing through the

MAGNETOMOTIVE FORCE

coil and on the number of turns of the conductor around the iron core.

To produce a strong magnetic effect in iron or steel, the conductor is wound around the metal. The lines of force then go through the metal, called the core, and their direction through the core depends on the direction of current flow through the conductor and on the direction in which it is wound around the core.

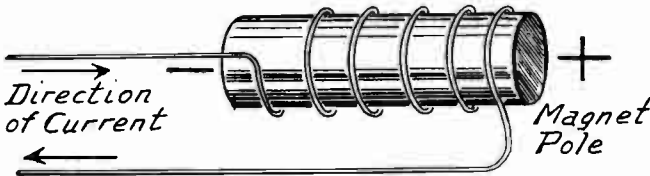

FIG. 3.—Current Flow Around an Electromagnet.

The core of an electromagnet is made from soft iron, usually in thin sheets or lengths of wire in place of in a solid piece. Such a magnet retains its magnetism only as long as current flows through its winding. A small amount of magnetism remains in the core, no matter how soft the iron may be, and this remaining magnetism is called residual magnetism. See also *Induction; Circuit, Magnetic; Field, Magnetic and Electromagnetic; and Iron and Steel.*

MAGNETOMOTIVE FORCE.—See *Iron and Steel.*

MANGANIN.—An alloy metal commonly used for its resistance properties in rheostats and resistors. It is composed of about 84 per cent copper, 12 per cent manganese and 4 per cent nickel. See *Resistance, Materials for.*

MAPLE WOOD.—See *Wood.*

MATCHING COILS AND CONDENSERS.—See *Oscillator, Radio Frequency, Uses of.*

MATCHING IMPEDANCES.—See *Impedance, Matching of.*

MAXIMUM COUPLING.—See *Coupling, Close; also Coupling, Optimum.*

MECHANICAL RECTIFIER.—See *Charger, Battery, Vibrating Type.*

MEG.—A prefix meaning one million. These letters before a word indicating a certain value mean that the value expressed by the word alone is to be taken one million times its unit value. Thus, a megohm is equal to one million ohms.

MERCURY.—A heavy, silver colored metal; the only metal which is liquid at ordinary temperatures. A column of pure mercury is used as a standard of resistance. See *Ohm.* The specific gravity of mercury is 13.55. The resistance of this metal is 576.23 ohms per mil foot.

MERCURY CONDENSER.—See *Condenser, Variable.*

MERCURY RECTIFIER.—See *Rectifier, Mercury Arc Type.*

MERESHON CONDENSER

MERESHON CONDENSER.—See *Condenser, Electrolytic*.

METALS.—See names of various metals; also *Resistance, Materials for*.

METER.—A unit of length in the metric system of measurement. One meter is equal to 39.37 inches, 3.281 feet, or 1.094 yards in English units of length. Commonly used fractions of the meter include the centimeter, which is one one-hundredth of a meter, and the millimeter, which is one one-thousandth of a meter. For conversion values of metric and English units of length, area, volume and mass see *Metric System*.

The meter is the unit in which the length of radio waves is measured. See *Wavelength*.

METER-AMPERE.—A measure of the strength of a radio transmitting station. The number of meter-amperes is found by multiplying the number of amperes of maximum current in the antenna by the number of meters of height of the antenna.

METERS.—Any instrument which measures electrical values is called a meter. An ammeter measures the current in amperes, a voltmeter measures the electromotive force in volts, a wattmeter measures electrical power in watts. A milliammeter measures current in milliamperes or thousandths of an ampere. The potentiometer is wrongly named since it does not measure potential but divides potential between different circuits. Frequency meters measure the frequency of alternating fields.

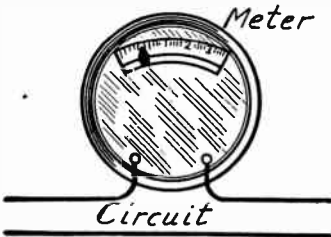

FIG. 1.—Ammeter in Series with Circuit.

METERS, AMPERE AND VOLT.

—An ampere meter or ammeter measures electric current flow in amperes, its scale being graduated in amperes and parts of amperes. A voltmeter measures electric pressure, potential or electromotive force in volts with a scale divided into divisions representing volts and parts of volts. The principles upon which ammeters and voltmeters operate are the same. The ammeter allows the current to flow practically unhindered and indicates the effect of the current passing in a circuit. The voltmeter offers such high resistance to the flow of current that this flow is practically stopped. The voltmeter then measures the effect of the voltage or pressure acting upon its terminals.

Ammeters are connected in series with the circuit in which the current is to be measured. That is, the circuit is opened and the ammeter inserted between the opened ends, as in Fig. 1. Voltmeters are connected in parallel across the two sides of a circuit without opening the circuit when the voltage difference between the two sides is to be measured. Voltmeters are also connected across any two points in a circuit when the voltage drop between these points

METERS, AMPERE AND VOLT

is to be measured. A voltmeter may be connected between any two points whose voltage difference is to be measured, either in an open circuit or a closed circuit. Such connections are shown in Fig. 2.

Ammeters may be used in a receiver to measure the flow of current to the filaments of the tubes, although this is seldom done. Milliammeters are often used to measure the flow of direct current in the plate circuits of the tubes, this being an indication of considerable value in the proper operation of a receiver.

Voltmeters are often used to measure the voltage across the tube filaments and other voltmeters or a double range meter may be used to measure the voltage applied to the plate circuits.

More current flows through the filament of a new tube than flows when the same tube is older. While the current in amperes for best reception decreases with age, the voltage across the filament remains the same for best reception practically regardless of age or at least until the tube is in such condition it should be discarded. For these reasons a reading of the filament voltage is of greater value in a receiver than a reading of filament current. A filament voltmeter is to be recommended in place of a filament ammeter.

Voltmeter connections may be made by using an open circuit jack between positive and negative filament connections at or near the tube, making the connection on the tube side and not on the battery side of any resistor in

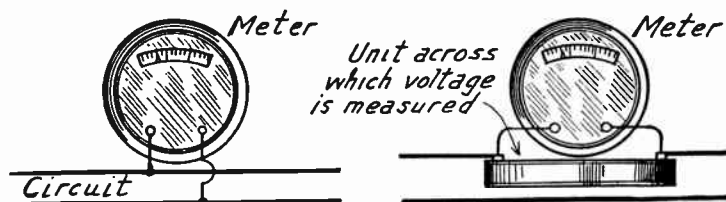

FIG. 2.—Voltmeter Connected Across a Circuit.

the circuit. Ammeter connections may be made by placing a closed circuit jack in series with the line whose current or amperage is to be measured. Methods of inserting voltmeters and ammeters into the various receiver circuits are shown under *Jacks and Switches, Uses of*.

Ranges of Meters.—The range of a meter is the greatest value it will measure, either in amperes or volts. For instance, a voltmeter which reads from zero up to eight volts is said to have a range of eight volts. For measuring filament voltages when using storage batteries the voltmeter should have a range of at least $0-7\frac{1}{2}$ volts and this may well be $0-10$ volts. For measuring plate voltages when using batteries for this work a voltmeter of $0-150$ volts range is generally employed, since voltages greater than 150 are seldom secured from batteries. Voltmeters having two or more ranges combined in the one instrument are often used with a switch-over connection so that either range may be employed. These double range meters generally have the first range of from $0-7\frac{1}{2}$, $0-10$ or $0-15$ volts and the other of $0-150$ volts.

Plate milliammeters for measuring the flow of direct current to plate circuits have ranges depending on the total plate current consumption of the receiver. Some receivers use very little plate cur-

METERS, AMPERE AND VOLT

rent and a meter of 0-30 milliamperes range will be sufficient. But with some of the larger power tubes a meter showing up to 50 milliamperes or even higher may be required.

Voltmeters Used as Ammeters.—It will be found that many voltmeters may be used as plate milliammeters although the voltmeter scale will not read correctly for milliamperes. Because voltmeters have a very high resistance this is not good practice. The high resistance cuts down the plate voltage and may cause resistance coupled feedbacks and howling.

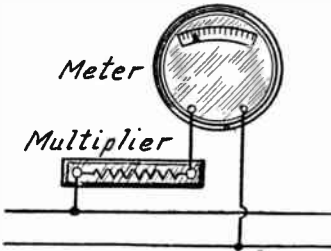

FIG. 3.—Multiplier Used with Voltmeter.

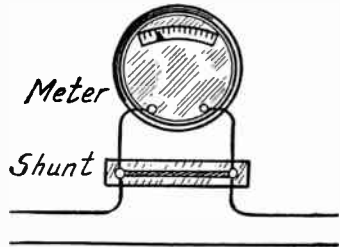

FIG. 4.—Shunt Used with Ammeter.

A voltmeter originally intended to read comparatively low voltages may be used to read higher voltages which are multiples of the lower ones by inserting a resistance unit in series with the voltmeter as in Fig. 3. These resistances are called multipliers. They may be bought ready made of proper value for many high grade meters and serve the purpose of making the instrument one of several ranges.

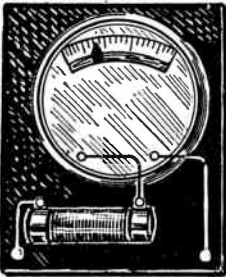

FIG. 5.—Milliammeter Used as Voltmeter.

Ammeters Used as Voltmeters.—A milliammeter may be used as a voltmeter by connecting a high resistance unit in series with the milliammeter as in Fig. 5. The number of ohms resistance will determine the maximum voltage that may be measured with the remodeled instrument.

Milliammeters generally have a full scale reading of one, five, ten, twenty, thirty or fifty milliamperes. It will be convenient to

A voltmeter may be used as an ammeter by placing a rather low resistance unit between its terminals. Of course, the meter scale must then be calibrated for the new purpose. An ammeter made for one range may be used for measuring higher ranges by adding a low resistance element called a shunt between its terminals. These ammeter shunts may be bought for the better grade instruments just as voltmeter multipliers may be bought. Fig. 4 shows a shunt in use. The meter scale readings must then be multiplied by some number, generally 2, 5, 10 or similar numbers, to give correct indications.

METERS, AMPERE AND VOLT

make the meter read a maximum voltage which is some even multiple of the maximum number of milliamperes since it will then be comparatively easy to translate the scale readings into voltages. For example, a milliammeter reading up to ten milliamperes may be changed to a voltmeter reading up to one hundred volts. Each milliamperere on the scale will then indicate ten volts and the entire ten milliamperes will become equal to the entire one hundred volts.

The number of ohms resistance to be placed in series with various milliammeters to change them over into voltmeters is given in the following table. The resistance is shown at the intersection of the lines for the present maximum reading of the milliammeter scale and the desired maximum voltage reading.

The less the range of the milliammeter to begin with the more efficient it will be as a voltmeter. This is because the meter must always carry enough current in milliamperes to cause its pointer to move and it takes more current to get a full scale deflection from a meter originally intended to measure comparatively large currents. To operate a meter with a range of ten milliamperes takes ten times the current required to operate one having a range of one milliamperere.

The resistance used must be capable of carrying the number of milliamperes which the meter is originally designed to indicate with full deflection. As a general rule none of the leak type resistors will carry more than twenty milliamperes without overheating, and the only sizes that will carry this much current are those of lowest resistance. The table of resistance shows only the combinations that may be made within the current carrying ability of high grade resistors of the types sold for resistance couplers.

Any other combination may be figured out by dividing the desired full scale voltage by the decimal indicating the maximum number of amperes handled by the milliammeter. The result will be the required resistance in ohms.

RESISTANCES FOR MILLIAMMETERS USED AS VOLTMETERS

Present Full Scale in Milliamperes	Desired Full Scale Voltage Reading							
	10	20	30	50	100	200	300	500
1	10000	20000	30000	50000	100000	200000	300000	500000
5	2000	4000	6000	10000	20000	40000	60000	—
10	1000	2000	3000	5000	10000	—	—	—
15	667	1333	2000	3333	6667	—	—	—
20	500	1000	1500	2500	—	—	—	—
25	400	800	1200	—	—	—	—	—
30	333	667	—	—	—	—	—	—

The combination of milliammeter and fixed resistance should be tested with several known voltages, such as B-battery voltages, to ascertain the accuracy of the device and to make a record of its error due to the use of resistances not of the exact number of ohms specified.

If the milliammeter has a full scale reading of more than five milliamperes, the arrangement will be of little use for testing the voltages of plate power supply units because the meter combination will then take more current than all the tubes together in many receivers. This current through the meter will drop the voltage far below its actual value when the power unit is working only on the receiver.

METERS, AMPERE AND VOLT

Requirements of Meters.—Cheap meters, either voltmeters or ammeters, are generally unsatisfactory. In a voltmeter high resistance is desired. Only very little current should flow through the meter to operate it and its mechanism must be very delicate and fine. Such construction cannot be put into a cheap meter. In an ammeter we want the least possible resistance and the meter's movement is shunted across a low resistance conductor carrying the current. Again the mechanism must be delicate and costly.

A poor voltmeter of low resistance will allow so much current to flow through itself that this load will reduce the voltage in the measured circuit below its proper value without the voltmeter in use. Small, low-cost voltmeters are worthless for measuring the voltages from plate power supply units because many of these voltmeters take far more current than all the tubes in the receiver combined.

Various types of meters will measure either alternating currents and voltages or direct currents and voltages, but one meter is not always suitable for both direct and alternating. Meters for use in alternating circuits give greatest satisfaction when of the hot-wire or thermo-couple type. Both of these types depend on the heating effect of a current and heating is independent of whether the current is direct or alternating. Hot-wire meters operate because of the expansion of a wire which is heated by the current to be measured. Thermo-couple meters operate from the electricity generated at a joint between two different metals, this electricity operating a small galvanometer which indirectly indicates the conditions in the main circuit.

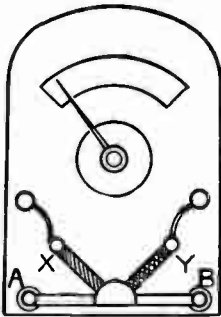

FIG. 6.—Thermocouple Meter.

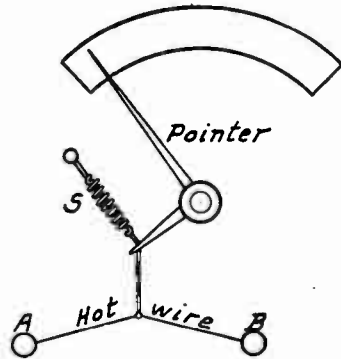

FIG. 7.—Hot Wire Meter Movement.

For high frequency measurements it is customary to use hot wire meters or thermo-couple meters. The principle of a thermo-couple is explained under the heading *Thermo-electricity* and the principle of a thermo-couple ammeter or milliammeter is shown in Fig. 6. Two dissimilar metals, *X* and *Y*, are joined as indicated. High frequency current flows between terminals *A* and *B* and in doing so flows across the junction between metals *X* and *Y*. The current in *A-B* produces heat which causes a voltage to be generated at the thermo-couple. This voltage sends a small current through the galvanometer, which is a very sensitive moving coil instrument. Move-

METERS, FREQUENCY

ment of the galvanometer pointer indicates the amount of current flowing in *A-B*.

The action of a hot-wire ammeter or milliammeter may be understood from Fig. 7. Current to be measured flows between terminals *A* and *B* through a wire which is heated by the power consumed in causing the current to flow through it. As the wire heats, it expands or lengthens correspondingly. Near the center of the hot wire is a connection to a pointer and a small spring. The spring maintains a steady pull so that lengthening of the hot wire allows the spring to move the pointer over its scale in proportion to the lengthening of the current carrying wire. This lengthening is proportional to the heating, and the heating is proportional to the amount of current so that the meter may be calibrated to indicate amperes or milliamperes.

Both of the meters just described operate because of heating effects. Heat developed in a circuit varies as the square of the current. Increasing currents will then cause a greater and greater proportional movement of their pointer as the current goes through a uniform rate of increase. Since the indications of these instruments vary as the square of the current they are sometimes called "current squared meters." On the scales, divisions for equal changes of current will be farther apart at the high readings than at the low readings.

METERS, FREQUENCY.—Frequency meters or wavemeters are among the most useful instruments to be found in a radio laboratory or radio shop. Among the many applications of such meters are the following: They may be used for measuring the unknown frequency of signals being received, for the measurement of unknown inductances and capacities, for the measurement of the frequency ranges of circuits containing inductance and capacity, and for the calibration of the settings for receivers without the necessity of waiting for broadcasting stations to be heard.

A frequency meter or a wavemeter is a device by means of which an unknown frequency or wavelength may be measured. The frequency meter or wavemeter generally consists of a coil of fixed inductance and a condenser of variable capacity as its chief parts. The device may also include some means of indicating the flow of current in the oscillatory circuit formed by the condenser and coil. The method of connection is shown in Fig. 1 for the simplest form of meter using an indicator.

The range of the frequency meter is determined by the inductance of the coil and the capacity of the condenser. Many of these meters are built so that the coil may be changed for other sizes. Higher frequency ranges are then handled by substituting a coil of less inductance and lower ranges are handled with a coil of greater inductance. The condenser remains unchanged except as its capacity is varied by moving the plates.

The frequency meter thus consists of a tuned circuit which may be brought into resonance at the frequency to be indicated or measured. At resonance the flow of current in the frequency meter cir-

METERS, FREQUENCY

cuit is at a maximum and this maximum flow of current generally operates some sort of indicating device which shows that resonance has been attained. The indicating device may be some form of meter, a lamp bulb, or a set of headphones.

The indicating device may be in series with the coil and condenser as in Fig. 1 or it may be in a separate circuit which is coupled to the resonant circuit formed by the coil and the condenser. This is shown in Fig. 2.

Frequency meters which include only a coil and condenser without any indicating device have a limited range of usefulness since the only indication of their resonance is the effect on another circuit whereby the meter's circuit absorbs power from the other circuit to which it is coupled or brought near.

A frequency meter employing a condenser of the straight line frequency type will measure approximate frequencies directly on its scale, while if wavelengths are to be measured they must be computed from the frequency. If the instrument uses a condenser of the straight line wavelength type, its scale will read directly in approximate wavelengths, corresponding frequencies being arrived at by computation.

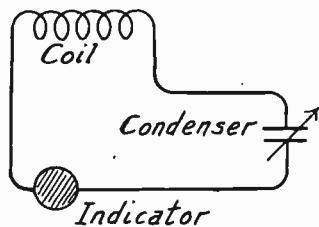

FIG. 1.—The Simplest Frequency Meter Circuit.

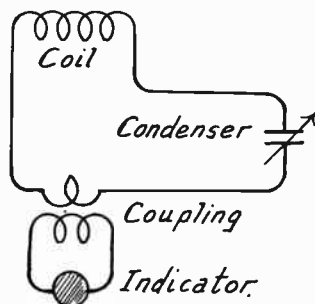

FIG. 2.—Frequency Meter with Coupled Indicator Circuit.

Calibrating the Frequency Meter.—The condenser dials of frequency meters or wavemeters are seldom marked directly in frequencies or wavelengths but are graduated over half of the circle of the dial, from zero up to one hundred or up to one hundred and eighty. Therefore it is necessary to have some means of translating the dial readings to frequency or to wavelength. This is done by preparing a graph or curve such as the one in Fig. 3 which shows the relation between the dial setting and the frequency. Instructions for plotting curves are given under the heading *Graph*.

It should be distinctly understood that the coupling between a frequency meter and the circuit with which the frequency meter is being made resonant must always be as loose as possible. The coupling depends on the nearness of the frequency meter coil to any coil in the circuit being tested or measured and also depends on the angle of these two coils with each other. Frequency meter coupling may sometimes be made as close as six inches when very feeble currents

METERS, FREQUENCY

exist in the circuit being tested, but with stronger currents the coupling may be several feet.

With too close coupling between the two units, sharp indications of resonance cannot be obtained and the measurements will be inaccurate. A close coupling broadens the resonant peak or may even make two distant peaks separated considerably from each other. The proper method is to bring the frequency meter close enough to the other circuit to obtain a decided indication of resonance in the meter. Then move the meter farther and farther away, continually testing for resonance until the least indication is received

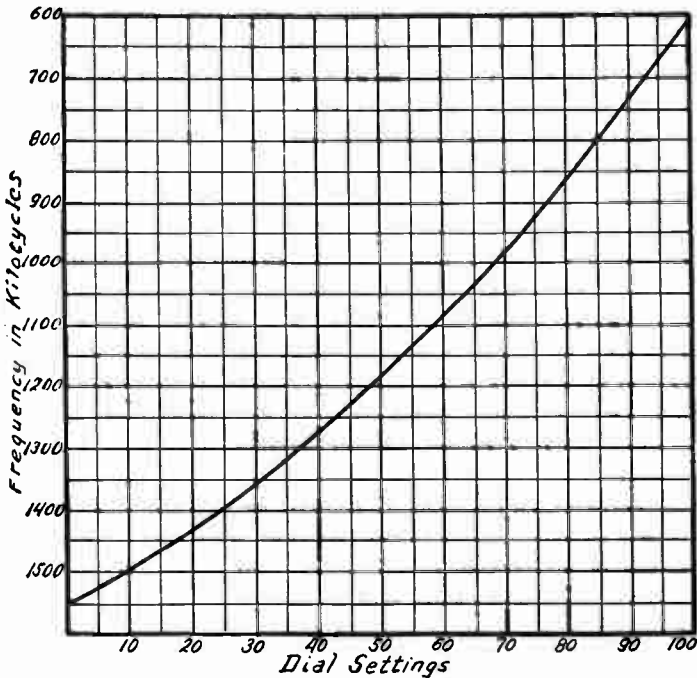

FIG. 3.—Curve for Reading Frequencies from Frequency Meter Dial Settings.

which is distinctly noticeable on the meter. Then continue the work with this coupling and no more.

It is absolutely essential that any frequency meter be calibrated while using the same resonance indicator and wiring connections that will be used whenever the frequency meter is employed. This applies to headphones, lamps, milliammeters, phone cords and all other similar parts.

If the frequency meter contains only a condenser and coil but no indicating device, it may be calibrated from a receiver by tuning the receiver to broadcasting stations of known frequency. With

METERS, FREQUENCY

this method the receiver must not be allowed to oscillate. The frequency meter is rather loosely coupled to the antenna circuit of the receiver or is brought close to the first coil in the receiver as in Fig. 4. The meter dial is now turned until the signal being heard from the receiver is reduced to its lowest possible volume. At this point the frequency meter is resonant at the frequency of the station being heard on the receiver. A number of settings are thus made and a curve plotted similar to the one in Fig. 3.

It is possible to calibrate an indicating frequency meter from broadcasting station signals with the help of an oscillating receiver. The receiver is accurately and sharply tuned to a broadcasting station of known frequency or wavelength. The meter, including a pair of headphones, is then brought near the receiver until it is possible to hear a click in the phones when the meter's condenser is turned. The meter is kept as far away from the receiver as will still give readable signals in the phones. The receiver itself should be in an oscillating condition and while in this oscillating condition should be tuned to zero beat, that is, until heterodyne whistles disappear, yet will reappear as the receiver tuning controls are turned either way.

As the meter's condenser is turned, a click will be heard in the phones when the meter's setting passes by the frequency corresponding to that of the re-

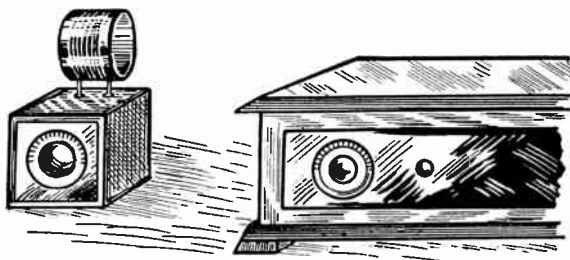

FIG. 4.—Coupling between Frequency Meter and Receiver.

ceiver. Two clicks slightly separated from each other mean that the meter is too close to the receiver. The reading on the meter dial at the exact position at which the click occurs indicates that the meter is set at the frequency of the station being heard over the receiver.

The receiver is then tuned to various stations of known frequency and each time a station is tuned in, the meter's setting is changed until the click occurs in the phones. These various settings of the frequency meter are plotted on a curve which will apply to the frequency meter when in use.

If a calibrated oscillator of the vacuum tube type is at hand, the frequency meter may be calibrated directly from this oscillator as described under *Oscillator, Radio Frequency, Uses of*. The oscillator is set at some frequency and allowed to remain there. The frequency meter is brought near the oscillator until it is found that the meter indicates resonance as the meter dial is tuned across the point corresponding to the oscillator's frequency.

The frequency meter is now moved away from the oscillator, making the coupling looser, until the least readable indication is secured on the meter. The meter's condenser is set to give maximum deflection or indication under these conditions, and a record is made of the condenser reading which corresponds to the meter's setting for the frequency of the oscillator. The oscillator is then changed to another frequency and the same procedure gone through with, obtaining another calibration point for the meter. When eight or ten points have thus been determined a curve is plotted for the meter.

METERS, FREQUENCY

Resonance Indicators.—The characteristics of the various kinds of resonance indicating arrangements determine their selection according to the use to which the frequency meter will be put. It may be desired to obtain a measurement of the strength or energy of a signal at a given frequency as well as to learn of the frequency itself. More generally, however, it is only the frequency that need be recognized. Of course, the resonance indicator must be very sensitive so that it will respond to the minute energy available.

In working with high power, such as from a transmitter's circuits, the resonance indicator generally consists of a small incandescent lamp bulb or a neon filled bulb inserted in series with the coil and condenser as shown in Fig. 1. A sensitive galvanometer or milliammeter having a full scale deflection of from one to three milliamperes may be used in place of the lamp bulb.

Indicators formed by thermo-couples with galvanometers, by crystal detectors and galvanometers, and by hot-wire meters are also suited for operation where the received power is considerable.

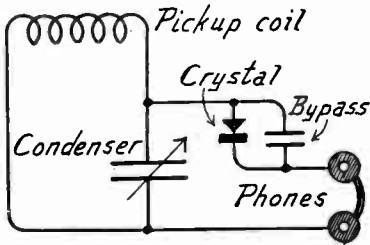

FIG. 5.—Frequency Meter with Direct Coupled Indicator Circuit.

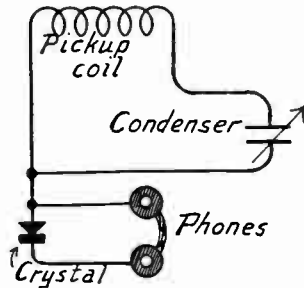

FIG. 6.—Frequency Meter Indicator Coupled through Single Wire.

Methods which are better for work with broadcast receiving equipment employ a pair of headphones and a crystal detector coupled directly to the resonant circuit of the frequency meter as in Fig. 5 or coupled through a single wire as in Fig. 6. Either of these methods of coupling is more sensitive than the inductive coupling of Fig. 7.

Fig. 8 shows a very satisfactory method of placing the resonance indicator in a separate circuit which is loosely coupled to the frequency meter circuit. The coupled circuit includes a small coil, a crystal detector and a pair of headphones. Coupling is obtained by connecting one wire from any point in the frequency meter circuit to a point in the coupled circuit. The connection to the coupled circuit may be made between the coil and detector as shown, between the detector and the phones or between the phones and the coil, the connection which gives the best indications on the headphones being the one retained.

The coil in the coupled circuit should consist of only thirty or forty turns of medium size wire, such as number 20, close wound on a two-inch tube. This coil is placed two or three inches from the frequency meter coil, the two coils being in the same box.

METERS, FREQUENCY

If the small coil in the coupled circuit is made with too many turns, the calibration of the meter will be changed when the crystal is adjusted to new points. If the small coil has too few turns, the meter will not show sufficient indication of resonance. This coil should be made so that it gives the best

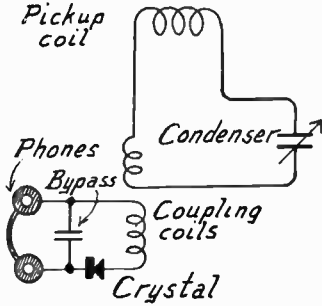

FIG. 7.—Inductively Coupled Indicator Circuit for Frequency Meter.

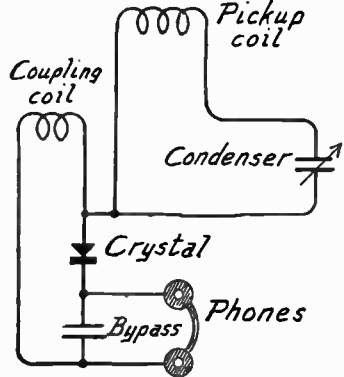

FIG. 8.—Frequency Meter with Special Coupling for Indicator.

indications without causing a change in the frequency meter setting with changes in adjustment of the crystal detector. The layout is shown in Fig. 9.

If it is found impossible to secure sufficient sound in the phones, more

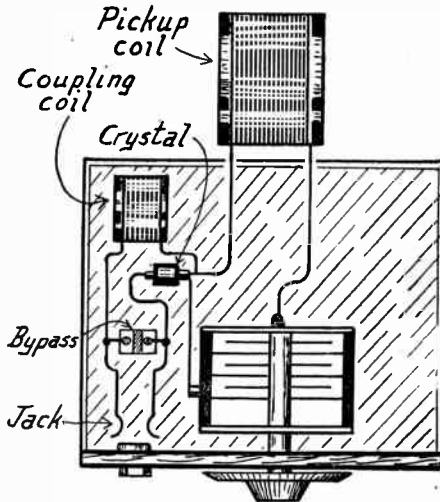

FIG. 9.—Layout for Frequency Meter with Special Indicator Coupling.

energy may be introduced into the coupled circuit by mounting a metal plate about two by three inches or three inches square near the stator plates of the frequency meter condenser and connecting this plate to a point in the coupled circuit. This circuit was designed at the Bureau of Standards.

METERS, FREQUENCY

Autodyne Frequency Meter.—The action of producing beat frequencies in two circuits may be employed in a frequency meter constructed as shown in Fig. 10. This construction is simply that of a vacuum tube oscillator whose frequency of oscillation is controlled by the variable condenser in the grid circuit. A pair of headphones is connected to the jack in the plate circuit. The pick-up coil should be loosely coupled to the circuit whose frequency is to be measured.

By listening in the headphones a squealing noise will be heard similar to that produced in a receiver which is oscillating. As the tuning condenser is moved, a point will be found at which this sound disappears. At this point the frequency produced in the meter is exactly the same as that in the circuit being measured.

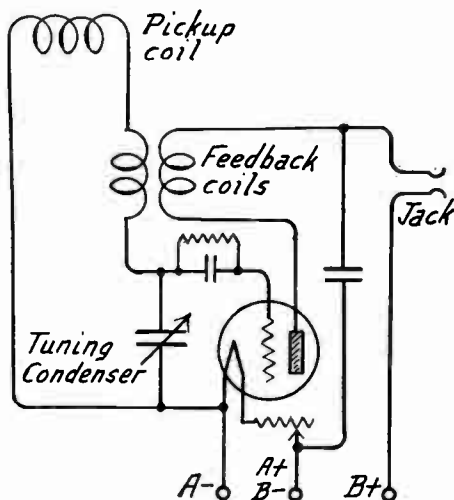

FIG. 10.—Circuits of Autodyne Frequency Meter.

The setting of the frequency meter condenser will then indicate the frequency of the circuit being measured.

The accuracy of this type of meter depends somewhat on the grid to filament capacity of the tube which is in parallel with the capacity of the frequency meter tuning condenser. Changing tubes will make a change in the meter's calibration and a new set of values will have to be determined. Any change in filament voltage across the tube will likewise have an effect upon the meter's indication. Consequently, the filament voltage should always be maintained at the same point.

Construction of Frequency Meters.—All of the parts used in building a frequency meter should be of the best obtainable quality and so proportioned as to allow the smallest possible radio frequency losses in coils, condensers, resonance indicator and wiring. All wiring and internal connections should be short, rigid and

METERS, FREQUENCY, CALIBRATING RECEIVERS WITH

securely fastened. Connections should never be made with long twisted cables.

Satisfactory coils may be made by winding number 20 or 22 double cotton covered wire on suitable sizes of tubing. The number of turns of wire for various tubing sizes may be found under the heading *Coil, Tuning, Sizes Required for*. Frequency meter coils are generally made for use with a condenser of .001 microfarad capacity. The coil should be solidly built and solidly mounted outside of the case containing the condenser.

Frequency meter condensers must always be of the variable type with air as the dielectric. The .001 microfarad size is common in this work. These condensers should be strongly built, having large bearings and heavy or stiff plates. The condenser may advantageously be enclosed in a metal housing or in a shielded box with the shield connected to the rotor plates.

It is necessary to use either a vernier condenser or a vernier dial. The dial markings may be from zero to one hundred or from zero to one hundred and

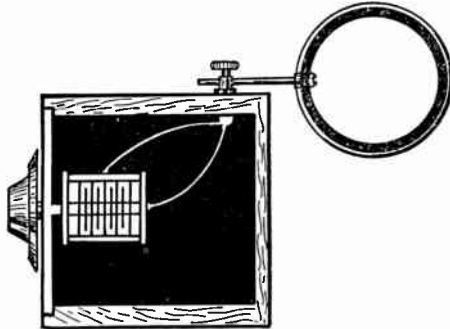

FIG. 11.—Frequency Meter with Shielded Cabinet.

eighty. The markings should be made with fine, sharp lines and a hair-line marker provided for accurate reading. It is not advisable to attempt having the dial of the frequency meter read directly either in frequencies or wavelengths. It should be numbered from zero up as just mentioned. This is because in time the calibration of the frequency meter may change. A new calibration curve may be made easily but it would not be so convenient to alter the markings on a dial.

A crystal detector used in a frequency meter should be of the most sensitive type obtainable, should have the lowest possible resistance and should be adjustable.

The frequency meter condenser and all necessary terminals are mounted in a shielded cabinet as in Fig. 11. The panel to which the condenser is fastened should be of a high grade dielectric material such as used for panels in receivers. Coils are mounted outside of the cabinet so that they may be able to pick up the energy which operates the frequency meter.

See also *Oscillator*.

METERS, FREQUENCY, CALIBRATING RECEIVERS AND CIRCUITS WITH.

—By the use of a frequency meter it is possible to determine the frequency range of any oscillating cir-

METERS, FREQUENCY, CALIBRATING RECEIVERS WITH

cuit composed of a coil and condenser. The method is shown in Fig. 1. The circuit to be excited is connected to a high frequency buzzer unit or to an audio frequency oscillator. The frequency meter is then brought near the excited circuit and the frequency meter condenser is varied until the indicator shows the greatest response. If the action of the indicator is not sharp, it shows that the frequency meter is too close to the excited circuit.

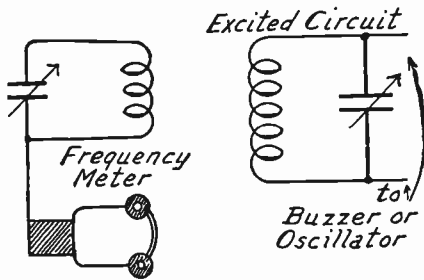

FIG. 1.—Calibration in Measuring Tuning Range of Excited Circuit with Frequency Meter.

With the greatest response in the frequency meter indicator the meter is adjusted to the natural frequency of the excited circuit. These frequencies may be read for both minimum and maximum settings of the variable unit, condenser or inductance, in the excited circuit, thus giving the range over which the excited circuit may be tuned.

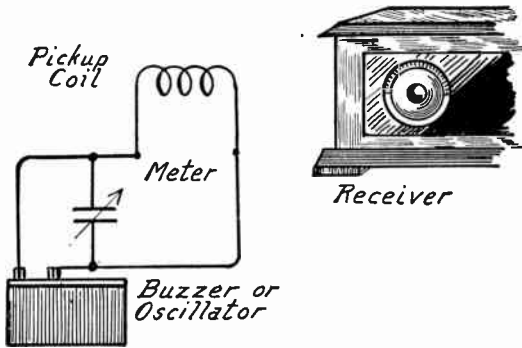

FIG. 2.—Calibrating Receiver with Frequency Meter.

A receiver may be completely calibrated for all frequencies within the broadcasting band by using the frequency meter excited by a buzzer or audio oscillator according to the method shown in Fig. 2. The coil of the frequency meter is brought near the antenna circuit of the receiver. The frequency meter dial is then set at the various frequencies or wavelengths which it is desired to tune in on the receiver. With each setting of the meter the receiver's tuning controls are changed to bring in the signal at maximum volume.

METERS, FREQUENCY, CALIBRATION OF

These settings of the receiver controls are those at which a broadcasting station will be received when it is operating at the frequency or wavelength shown by the frequency meter dial.

METERS, FREQUENCY, CALIBRATION OF.—See *Oscillator, Radio Frequency, Uses of.*

METERS, FREQUENCY, CAPACITY AND INDUCTANCE MEASUREMENTS WITH.—Either the inductance or the capacity in an oscillatory circuit may be measured with the help of a frequency meter. That is, an unknown inductance may be measured if a known capacity is at hand, or an unknown capacity may be measured if the inductance is known.

The circuit containing the inductance and capacity is excited by an audio oscillator or buzzer as indicated. The coil of the frequency meter is brought near the inductance in the circuit being measured and the frequency meter condenser is varied until maximum resonance indication is obtained. The reading of the frequency meter then gives the frequency of the circuit being tested.

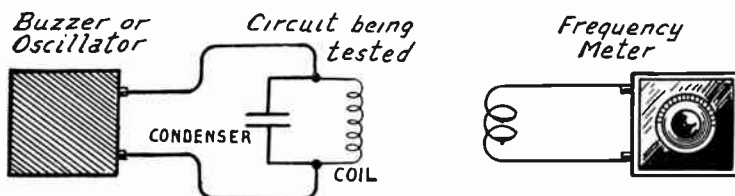

Measuring Inductance and Capacity with Frequency Meter.

Of the three values: frequency, inductance and capacity; two are known. The frequency from the meter setting and the known inductance or the known capacity may be inserted in the following formulas to learn the third or unknown value. The numerator in the second term of both formulas is the "L-C Value for Frequency." The number to be placed in this position in completing the formulas will be found in the table under *Resonance, Inductance-Capacity Values for*. The frequency being used is found in the left hand column of that table and then, in the column headed *L-C Value*, will be found a corresponding number for insertion in these two formulas. The frequency is in kilocycles, the inductance in microhenries, and the capacity in microfarads.

$$\text{Unknown Capacity} = \frac{\text{L-C Value for Frequency Used}}{\text{Known Inductance}}$$

$$\text{Unknown Inductance} = \frac{\text{L-C Value for Frequency Used}}{\text{Known Capacity}}$$

METERS, FREQUENCY, OSCILLATOR USE OF.—A frequency meter may be used for an oscillator with which to excite radio circuits or radio receivers for purposes of calibration. A high frequency buzzer or an audio oscillator is connected to the frequency meter as shown in Fig. 2 under *Meters, Frequency, Cali-*

METERS, FREQUENCY, SIGNAL MEASUREMENT WITH

brating Receivers and Circuits with. With the buzzer or oscillator in operation the frequency meter's circuit will oscillate at whatever frequency is indicated by its setting. Radiation from this oscillator may be employed in the same manner that radiations from any other form of oscillator would be used. See *Oscillator*.

METERS, FREQUENCY, SIGNAL FREQUENCY MEASUREMENT WITH.—The unknown frequency of a signal being heard in a receiver may be determined with a frequency meter as shown in the illustration. With the receiver tuned to the signal, the frequency meter coil is brought near a coil in the antenna circuit of the receiver and the frequency meter condenser is set at the point which gives maximum resonance indication if the

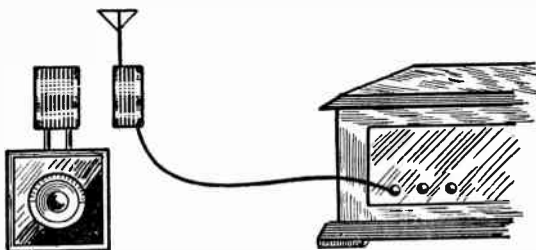

Measuring Signal Frequency with Meter.

frequency meter uses headphones or other indicator. Otherwise the meter is set at the point where the receiver signal is reduced to the lowest volume if the frequency meter has no indicator. At this point, the frequency meter indicates the frequency of the signal being received.

METERS, KILOCYCLES RELATION TO.—See *Wavelength, Frequency Relation to*.

METERS, MILLIAMPERE.—An ammeter for the measurement of very small currents and whose scale is graduated to milliamperes (thousandths of an ampere) and fractions is called a milliammeter. See *Meters, Ampere and Volt*.

METERS, VACUUM TUBE.—A vacuum tube voltmeter is an instrument for the measurement of peak voltages of alternating current at any frequency through the utilization of change of plate current in a vacuum tube with change of voltage applied to the grid circuit of that tube. This form of meter has many advantages. It will measure voltages practically without regard to their frequency; handling the low power circuit frequencies, audio frequencies and radio frequencies. Unlike other voltage measuring devices, the vacuum tube meter consumes practically no power from the circuit tested and takes practically no flow of current from that circuit. Therefore, the voltage is unaffected by the meter itself. This type of meter is often used for measurements on amplifying devices.

METERS, VACUUM TUBE

The circuit for a very simple vacuum tube meter is shown in Fig. 1. The voltage to be measured is applied across terminals *A* and *B* so that it acts upon the grid-filament circuit of the tube. The *C*-battery maintains the grid at a negative voltage so that no current will flow through the grid circuit. When the connections are completed and the tube is lighted, there will be a flow of current in the plate circuit. The amount of this current depends on the characteristics of the tube used and on the plate voltage applied by the *B*-battery. The plate current will be indicated by the milliammeter.

The milliammeter is also connected across the *A*-battery through the potentiometer and the fixed resistor. Moving the potentiometer arm toward the right applies positive voltage from the *A*-battery on the negative terminal of the milliammeter, whereas the *B*-battery voltage acts the opposite way. Adjustment of the potentiometer balances these opposing voltages so that the meter is caused to read zero before any tests are made.

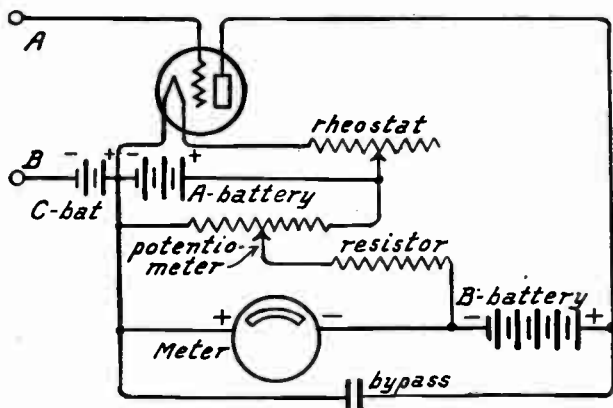

FIG. 1.—Circuits of Simple Vacuum Tube Voltmeter.

The *C*-battery voltage is such that the tube is operating on the lower bend of its grid voltage-plate current curve and is really acting as a *C*-bias detector. Any voltage applied to terminals *A* and *B* will raise the average voltage on the grid and cause an increase of plate current. This increase of plate current is proportional to the peak value of the applied voltage and a calibration curve may be prepared to show the relationship between the applied voltage and the plate current shown by the meter.

This type of meter is suitable for very simple tests, but it has two rather serious disadvantages. First, the calibration curve will be found to show but little change of plate current for low values of applied voltage in comparison with the changes for higher voltages. Second, any direct current voltage applied to the meter along with the high frequency alternating voltage will not only affect the reading but may seriously damage the delicate milliammeter in which the full scale reading is not more than one milliamper.

The circuit for a type of meter which has a more uniform scale and with which direct current voltage cannot enter the grid circuit is shown in Fig. 2. The arrangement of parts and the wiring for such an instrument is shown in Fig. 3. The plate current change is

METERS, VACUUM TUBE

read by the milliammeter with maximum scale reading of one milliampere, around which is connected a 1000-ohm potentiometer with one end attached to one terminal of a two-way switch and the slider attached to the other side of this switch. Adjustment of this potentiometer allows more or less of the total plate current to flow through the meter, the remainder being bypassed through the potentiometer. The slider is set at such a point that, with the two-way switch on the high point, the reading for a given voltage is from one-tenth to one-quarter of the reading for the same applied voltage

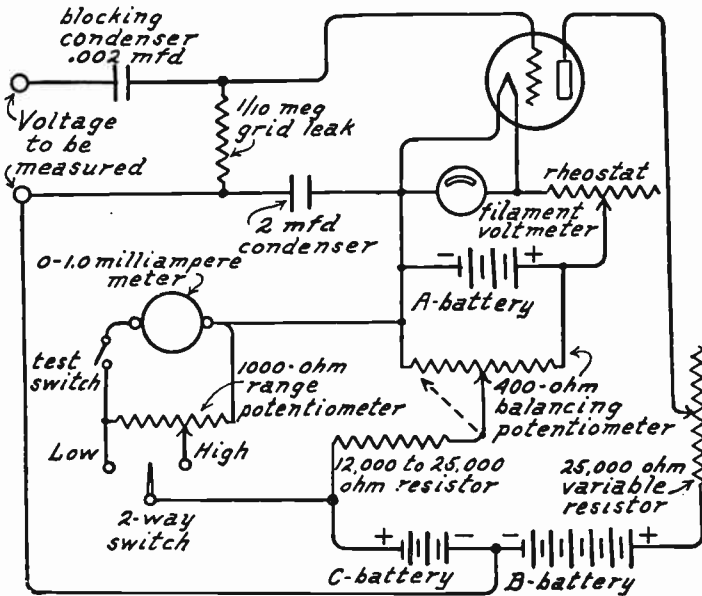

FIG. 2.—Circuits of Two Range Vacuum Tube Voltmeter.

with the switch on the low position. This arrangement gives a two-range meter, one range being well suited to low voltages and the other equally well suited to high voltages.

Current for balancing the normal plate current and for thus bringing the meter pointer to zero as a start is controlled by the 400-ohm potentiometer of which the center tap is connected through a 12,000 to 25,000-ohm fixed resistor to the two-way switch. A C-battery is connected between the grid and the filament circuit. A grid leak of one-tenth megohm or 100,000 ohms resistance completes the grid biasing circuit.

The alternating or high frequency voltage to be measured is placed across the marked terminals. Direct current which may be in the circuit on test cannot enter the grid circuit because of the blocking condenser in the grid lead. Since the measurement is made of a part of the plate current flowing between B-minus and A-minus, a blocking condenser is placed between these

METERS, VACUUM TUBE

two points to prevent short-circuiting the direct current type of milliammeter used.

Any voltage amplifying type of tube may be used. The small 199 dry cell tube allows the best range of measurement with the smallest B-battery and C-battery equipment for a given range of measurement. The common 201-A type or the high μ 240 type will give satisfactory results. When using the 199 tube it should be operated with forty-five volts of B-battery and with six volts of C-battery. Either of the other tubes may be operated with about sixty-five volts of B-battery and with six volts of C-battery for all ordinary work. Higher values of C-voltage on these latter tubes will allow the measurement of much higher voltages.

When the meter is ready for use the batteries are connected, the tube put in place and the rheostat turned to a point such that the filament voltmeter indicates normal filament voltage; three volts for the 199 tube or five volts for the larger tubes. The input terminals, across which are placed voltages to be measured, are then short circuited with a wire. The balancing potentiometer is set at the negative side of its circuit and the two-way switch is placed on the high side. The test switch is then closed and the meter should

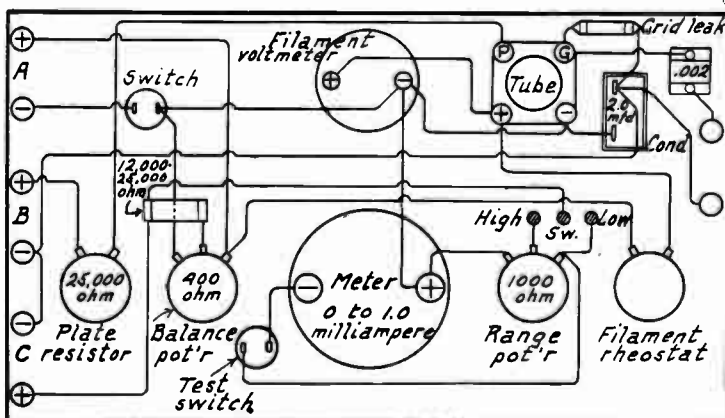

FIG. 3.—Layout of Parts for Vacuum Tube Voltmeter.

show some current flow. If no current is shown, the C-battery voltage is reduced slightly since there must be some current to start with. If the amount of current is small, the switch is placed on the low side and the test switch again closed. The balancing potentiometer is then moved until the meter pointer stands at zero.

Any small alternating voltage is then applied across the input terminals, of course, with the short circuiting wire removed. This voltage should not be more than two or three volts to start with. The test switch is again closed and the meter pointer should move across its scale to a position which should be noted. With the same voltage applied, the two-way switch is placed on the high side and a second reading taken. The range potentiometer is then moved to a point such that this second reading is from one-tenth to one-fourth the value of the first one. The smaller the second (high side) reading in proportion to the first (low side) reading, the higher the maximum voltage which may be measured but the less easily the differences between high voltages may be read off the meter scale.

This completes the preparation of the meter for its calibration. In Fig. 4 is shown a calibration curve for such a meter with the small type of tube

METERS, VACUUM TUBE

mentioned and with the recommended B-battery and C-battery voltages. The calibrations are made by applying known alternating current voltages to the input terminals and preparing a graph showing the relation between applied voltage and meter scale readings. With the blocking condenser in the grid circuit the meter indications will vary slightly with the frequency of the applied voltage. The lower the frequency, the greater the condenser's impedance and the smaller will be the meter reading. For example, a 60-cycle voltage will give comparatively low readings, an audio frequency voltage will give higher readings and a radio frequency voltage will give still higher readings, all with the same actual value of applied voltage. If the grid block-

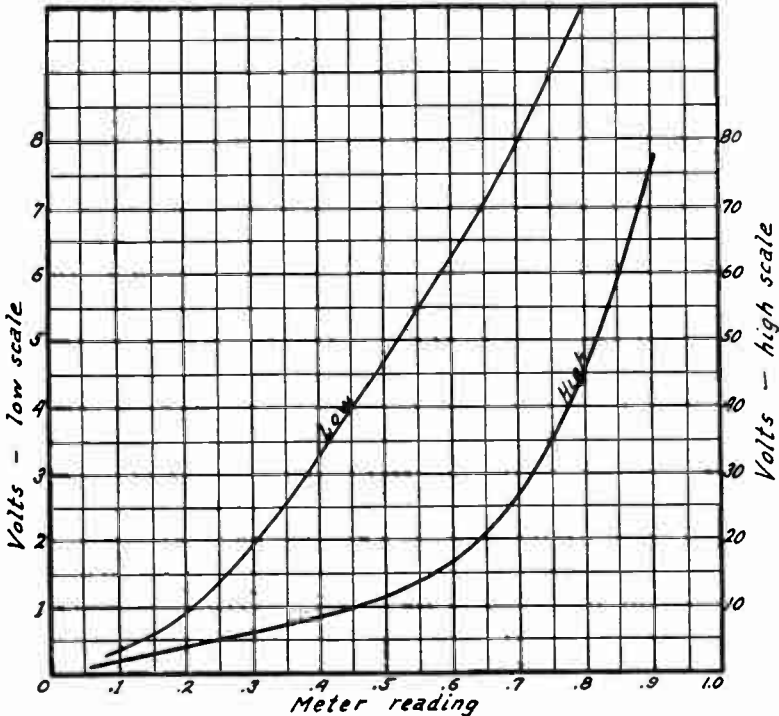

FIG. 4.—Calibration Curve of Vacuum Tube Voltmeter.

ing condenser is short circuited, as may be done when it is certain that no direct current voltage is in the measured circuit, the readings will be more nearly independent of frequency.

A 60-cycle calibration may be made by applying the voltages from filament supply transformers used for alternating current tubes. These transformers are made to give voltages of approximately $1\frac{1}{2}$, $2\frac{1}{2}$, 5 and $7\frac{1}{2}$ volts. With center tapped transformers it will be possible to obtain corresponding voltages of $\frac{3}{4}$, $1\frac{1}{4}$, $2\frac{1}{2}$ and $3\frac{3}{4}$ between the center taps and either side of their winding.

In making such a calibration it must be remembered that the voltages marked on transformers are effective voltages and are not the same as the peak voltages which are to be indicated by the

METERS, VACUUM TUBE

vacuum tube voltmeter. The peak voltage is 1.4144 times the effective voltage, so the marked voltages must be multiplied by this number to give the peak voltages or by 1.4 to give approximate peak voltages. Ordinary alternating current voltmeters indicate effective voltages so in case their readings are used in the work of calibration they must be multiplied by 1.4 to get peak voltages which correspond. See *Value, Average and Effective*.

A vacuum tube voltmeter provides a means for measuring the voltage amplification of amplifying stages in any part of a receiver as well as a means for the measurement of all high frequency voltages. The connections for measuring the voltage amplification of a tube and its coupling device are shown in Fig. 5.

A four-pole, double-throw switch is connected as shown to a source of voltage, a vacuum tube voltmeter, a resistance load and the unit to be tested. The voltage source should be an audio frequency oscillator or a radio fre-

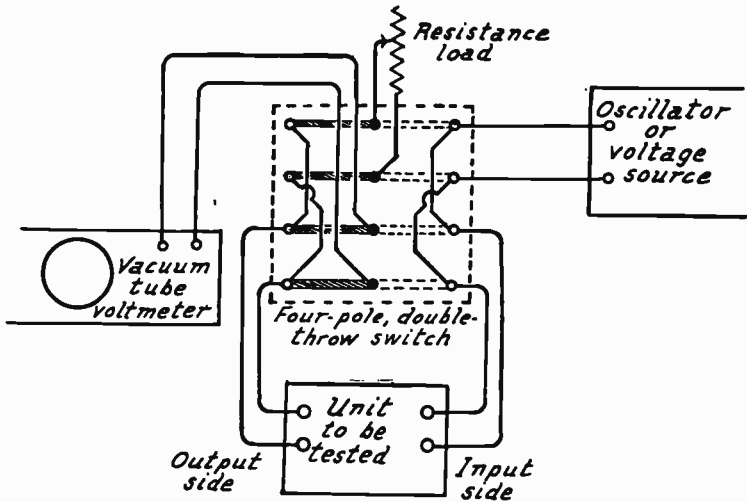

FIG. 5.—Amplification Measurement with Vacuum Tube Meter.

quency oscillator. The resistance should be of the variable type, adjustable from a few thousand ohms up to several hundred thousand ohms. This resistor is set at a value which approximates the load to which the amplifying device is usually connected. Throwing the four-pole switch to the right measures the input voltage while throwing it to the left measures the output voltage after amplification. The ratio of the two voltages is the voltage amplification of the device on test at the particular frequency and load resistance being used. Before throwing the four-pole switch to the left it is advisable to set the tube voltmeter for readings of high voltages.

Slide-back Voltmeter.—In the slide-back type of vacuum tube voltmeter the peak voltage of alternating current to be measured is balanced with an opposing direct current grid biasing voltage which is equal to the peak voltage under certain conditions. The circuit for one such meter is shown in Fig. 6.

METERS, VOLT

With the exception of the grid biasing arrangement, this meter is like the one in Fig. 1. The potentiometer across the A-battery controls the balancing voltage to bring the plate milliammeter to zero and the resistor in series with the slider protects this meter. Across the C-battery is a second potentiometer and a grid voltmeter is placed so that it measures the applied bias.

In operation, the bias potentiometer is adjusted to bring the plate current to zero and the grid voltmeter reading is noted. The correct adjustment may be checked by turning on and off the B-battery voltage, when there should be no change in reading of the plate milliammeter. The voltage to be measured is then connected across terminals A and B. This will cause a deflection of the plate milliammeter corresponding to the strength of the applied voltage. With the voltage to be measured still applied, the bias potentiometer is then readjusted to bring the plate current reading back to zero or to its reading before the voltage on test was applied. The difference between the two readings of the grid voltmeter should be equal to the peak voltage applied and which is to be measured.

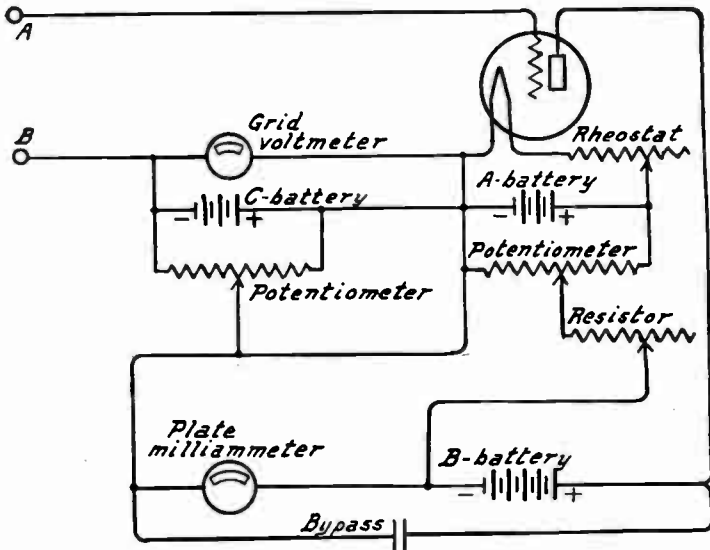

FIG. 6.—Slide-back Type of Vacuum Tube Meter.

METERS, VOLT.—See *Meters, Ampere and Volt.*

METERS, WAVE.—See *Meters, Frequency.*

METRIC SYSTEM.—The metric system of units and measurements is universally used throughout the world of science. The following tables show the relation between the metric units and English units of length, area, volume and weight.

In the metric system of measurement each unit is equal to ten times the next smaller similar unit and is equal to one-tenth of the next larger similar unit. Thus; one meter is equal to ten centimeters and one centimeter is equal to ten millimeters. The centimeter is then equal to ten millimeters, the next smaller unit, and is equal to one-tenth meter, the next larger unit of length.

MFD.

METRIC UNITS TO ENGLISH UNITS

1 millimeter	=	0.03937 inch	=	0.003281 feet	
1 centimeter	=	0.3937 inch	=	0.032808 feet	
1 meter	=	39.37 inches	=	3.280833 feet	= 1.094 yds.
1 kilometer	=	3281.0 feet	=	0.6214 mile	
1 sq. centimeter	=	0.1549 sq. inches	=	0.001076 sq. feet	
1 sq. meter	=	1549.9969 sq. inches	=	10.76387 sq. feet	
1 cu. centimeter	=	0.0610 cubic in.	=	0.0000353 cu. ft.	
1 liter	=	33.8147 fluid oz.	=	1.05671 liquid qt.	= 0.2642 gals.
1 gram	=	15.43 grains	=	0.03527 avoird. oz.	= 0.0022 lbs.
1 kilogram	=	35.274 avoird. oz.	=	2.20462 pounds	

ENGLISH UNITS TO METRIC UNITS

1 inch	=	25.4 millimeters	=	2.54 centimeters	= 0.0254 meters
1 foot	=	30.48 centimeters	=	0.3048 meters	
1 yard	=	91.44 centimeters	=	0.9144 meters	
1 mile	=	1.609 kilometers	=	1609.347 meters	
1 square inch	=	6.452 square cm.	=	0.00065 sq. meters	
1 square foot	=	929.034 square cm.	=	0.0929 sq. meters	
1 cubic inch	=	16.387 cubic cm.			
1 cubic foot	=	0.0283 cubic meters			
1 liquid qt.	=	0.9463 liters			
1 gallon	=	3.7853 liters			
1 ounce (Av.)	=	28.3495 grams	=	0.02835 kilogram	
1 pound	=	453.592 grams	=	0.45359 kilogram	

MFD.—An abbreviation for microfarad. See *Capacity, Units of*.

MHO.—A unit of measurement for conductivity, the opposite of resistance. A mho is the reciprocal of an ohm. The number of mhos conductivity is equal to 1 divided by the number of ohms resistance. The word mho is formed by spelling the word ohm backward.

MICA.—Mica is one of the most important dielectric materials used in radio and electrical work generally. Mica is a mineral which occurs in laminated crystalline form, it being possible to split sheets of mica along the laminations into layers of about one-fourth of one thousandth of an inch in thickness.

Mica has a dielectric constant of 3:0 to 6.0. It has low radio frequency losses, some grades showing only about 0.05 degree phase angle difference. As a dielectric, built-up mica is not so good, having a phase angle of around one degree. The dielectric strength of mica ranges from 700 to 1200 volts per thousandth of an inch thickness for the grades of lower resistivity. Some mica shows dielectric strength as high as 2000 to 3000 volts per thousandth of an inch. See also *Resistance, Insulation*.

MICA CONDENSER.—See *Condenser, Fixed*.

MICA DIAPHRAGM.—See *Speaker, Loud*.

MICARTA.—See *Phenol Compounds*.

MICRO-

MICRO.—A prefix meaning the one-millionth part of. When these letters form the first part of any value, the value is the one-millionth part of the unit forming the last part of the word. Thus a microfarad is the one-millionth part of a farad, a microvolt is the one-millionth part of a volt, and so on. The prefix “micro-micro” means the one-millionth part of a millionth part, one micro-microfarad being the one-millionth part of a microfarad.

MICROMETER DIAL.—See *Dial, Tuning, Vernier.*

MICROPHONE.—A microphone is a device which produces electrical variations in voltage or current which correspond to sound variations in air pressure acting upon the unit. The microphone receives the sounds to be transmitted and translates these sounds into electrical changes which are used to actuate the grid circuit of an amplifying tube. The output of this tube is used, generally after further amplification, to modulate the radiation of the transmitter. See *Modulation.*

Various types of microphones are in use. The most common is the ordinary telephone transmitter. All microphones receive the sound pressures on a thin

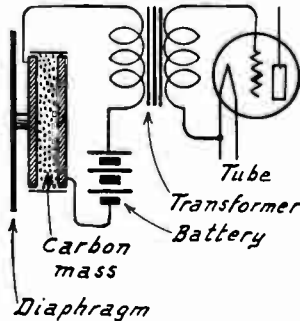

FIG. 1.—Simple Type of Microphone.

diaphragm which is thus set into motion. In the carbon type microphone, motion of the diaphragm alternately compresses and releases pressure on a mass of carbon particles. The changing degree of compression on the particles causes changes of electrical resistance of the mass. The changing resistance causes changes in current through a circuit connected to the vacuum tube. Such a simple arrangement is shown in Fig. 1. The amount of battery current flowing through the transformer primary changes according to the microphone's changing resistance and the current changes in the transformer primary cause corresponding changes in the transformer secondary circuit which is connected to the tube's grid circuit.

To secure a more uniform response with sounds of various frequencies, the “double-button” type of carbon microphone is used in place of the single button type just described. The circuit connections and operating principle of a double-button microphone are shown in Fig. 2. The diaphragm is placed between two units, each of which contains carbon particles. Motion of the diaphragm toward the right compresses the right hand mass and releases the pressure on the left hand mass. This lowers the resistance in the right hand

MICROPHONE

half and raises it in the left hand half. Current from a battery is led to both masses of carbon where it divides and returns through the two halves of a split primary winding on the transformer to the battery.

It will be seen that the steady battery current flows in opposite directions

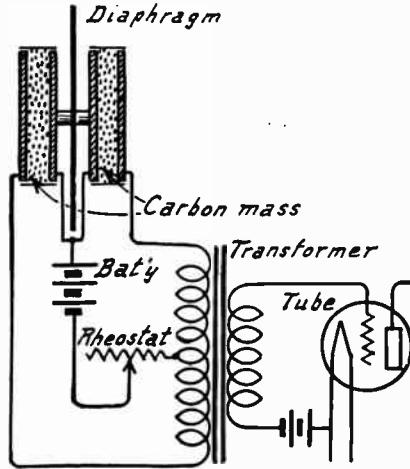

FIG. 2.—Double-button Carbon Microphone.

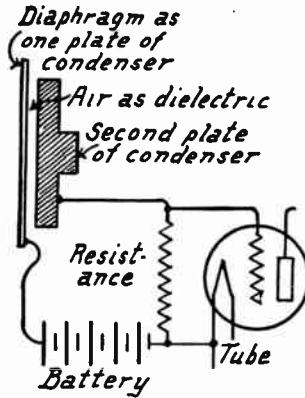

FIG. 3.—Condenser Microphone.

through the two parts of the transformer primary winding so that the magnetizing effect of this current is balanced out. This prevents core saturation in the transformer and prevents changes in battery voltage from affecting the result. The difference in resistance between the two parts of the microphone when in operation causes a change of voltage across the transformer primary which in turn causes a corresponding change to appear in the secondary winding connected to the grid circuit of the tube.

MICROPHONE

The principle of the condenser type microphone is illustrated in Fig. 3. A condenser is formed by the microphone diaphragm as one plate, a solid metal piece as the second plate and the air between them as the dielectric. Sound waves cause motion of the diaphragm toward and away from the fixed plate. The changing distance between the condenser plates causes a changing capacity. The condenser is connected to a battery of high voltage and to a resistor. The battery impresses voltage across the condenser through the resistor and the condenser takes a charge proportional to its capacity. Changing the capacity causes changes in charging current through the resistor and the current flow through the resistor causes voltage differences across it. The ends of the resistor are connected to the tube's grid circuit so that the voltages across the resistor are amplified by the tube.

The action of a moving coil or electrodynamic microphone is shown in Fig. 4. A diaphragm carries a coil of wire in a very strong field produced between the poles of a magnet energized by a battery or other source of current. Sound waves move the diaphragm and the coil. Motion of the

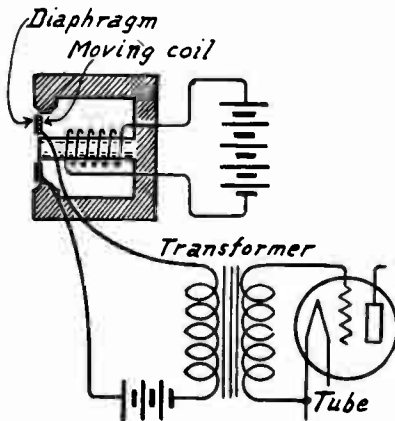

FIG. 4.—Moving Coil Microphone.

coil in the electromagnetic field produces voltages in the coil which is connected through a transformer to the grid circuit of an amplifying tube.

The similarity of the microphone of Fig. 4 to a moving coil or dynamic loud speaker is very apparent. The action in practically all loud speakers is reversible to a greater or less extent so that any of them will form a microphone. The frequency response of loud speakers used as microphones is not well suited for work in which uniformity of response is important.

In a microphone it is desired that the electrical changes be proportional to the sound intensities at all frequencies, that there be no frequencies at which the electrical variations become much too small or much too great in comparison with the sounds applied. To prevent resonance of the diaphragm itself, which would intensify the sound at some frequencies, this part of the microphone is drawn very tightly so its natural frequency of vibration is above audibility. In securing uniformity of response a great deal of the natural sensitivity of a microphone is lost and, therefore, it is always necessary that the microphone output be considerably amplified with tubes before being used for modulation.

As a further precaution against resonance in the diaphragm it is usually placed in an air chamber so that the resistance of the air as it is set in motion will damp the motion of the diaphragm or place a load upon it. This damp-

MICROPHONIC NOISES

ing prevents free vibration of the diaphragm at any particular frequencies. The maximum motion of the diaphragm is but little more than the ten-thousandth part of an inch in usual designs.

In the two-button carbon type microphone it is essential that the currents flowing in the two halves be exactly equal to prevent distortion. The currents are balanced by means of a potentiometer in the transformer and battery circuit. Rough handling or long continued use will cause packing of the carbon particles in these microphones and a consequent loss of sensitivity. Gently shaking the microphone will loosen the carbon. Because of a slight electrical action between the carbon particles as the current flows, there is always a slight hissing sound produced by this type of unit.

The diaphragms of commercial microphones are about one five hundredth of an inch thick and are made from some light material such as duraluminum. The separation of the two plates in a condenser microphone is in the neighborhood of one and one-half thousandths of an inch.

See also, *Modulation*.

MICROPHONIC NOISES.—See *Noise*.

MIKE.—Slang for *Microphone*.

MIL, CIRCULAR.—The area of a circle which is one-thousandth of an inch in diameter. The one-thousandth part of an inch is called one mil. The circular mil as a unit of area is used in measuring the cross sectional area or size of conductors.

MILEAGE DISTANCES.—See *Distances, Geographical*.

MILLI.—A prefix meaning the one-thousandth part of. When it precedes a word which indicates a certain value or quantity, that value or quantity is to be divided by one thousand. For example, one milliamperere is the one-thousandth part of an ampere.

MILLIAMMETER.—See *Meters, Volt and Ampere*.

MILLIMETER.—See *Metric System*.

MMFD.—An abbreviation for micro-microfarads of capacity.

MODIFIED SINGLE CONTROL.—See *Control, Single*.

MODULATION.—Modulation is the process of varying the amplitude of a carrier wave so that the average rise and fall in amplitude, or the envelope of the carrier, represents the rise and fall of the sound waves which are to be sent out from the transmitter. See *Radio, Principles of* and *Detector, Action of*.

Grid Modulation.—The simplest method of modulating the output of an oscillator tube or generator tube is shown in Fig. 1. A microphone and a battery are connected in the primary circuit of a transformer whose secondary winding is in the grid circuit of the tube to be modulated. Sounds reaching the microphone change its resistance and the changes of resistance change the current through the transformer primary. The secondary circuit of the transformer changes the voltage on the tube's grid, and the plate circuit output of the oscillator tube varies to correspond with the sound frequencies sent into the microphone. This is called grid modulation.

Absorption Modulation.—The absorption method of modulation is shown in Fig. 2. The right hand tube is an oscillator or generator whose output is absorbed according to sound frequencies by the left hand tube which is the modulator or absorber. The plate circuits of the two tubes are in parallel. The grid voltage of the

MODULATION

modulator tube is changed in accordance with sound frequencies impressed on the microphone transformer by the microphone in the transformer's primary circuit. In practice a bypass condenser is placed across the microphone transformer secondary.

The output of the oscillator or generator tube would normally be constant, since there is no variation of its grid voltage. Part of the output of the oscillator tube goes to the regular output circuit and part of it goes to the plate circuit of the modulator tube. The amount of power going to the plate circuit of the modulator tube varies with the sound frequencies reaching the microphone and the remainder of the total power passes to the output of the transmitter. The net output from the transmitter is thus the difference between a constant value and the power required by the modulator, and this difference, of course, corresponds to the power being taken by the modulator.

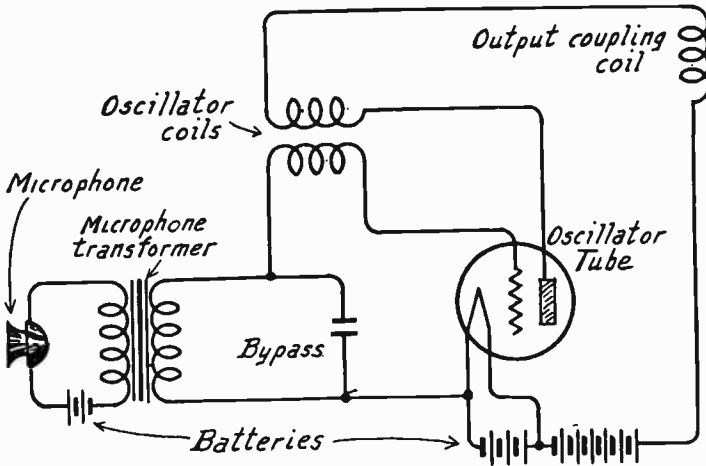

FIG. 1.—Grid Modulation of Oscillator Tube.

Variation of Input Power.—A more practical and efficient method of modulation than either of those preceding is by variation of the input power to the plate of the oscillator or generator tube. This system is shown in Fig. 3. The tube at the left is the oscillator or generator. Its plate and grid coils are coupled in the manner which is usual for any oscillator and the modulated output is secured by a coupling to these coils. See *Oscillator*. The tube at the right is the modulator with a microphone and transformer in its grid circuit.

Plate current for both tubes is furnished through the choke coil of large inductance and reactance. This choke keeps the total plate current practically uniform. There are two resistances in parallel attached to this choke, these two resistances being the plate resistance of the modulator and the plate resistance of the oscillator. The microphone circuit causes changes of grid

MODULATION

voltage on the modulator tube, and since the plate current in any tube depends on the grid voltage, the plate current of the modulator tube varies according to the sound frequencies in the microphone circuit. Here again a bypass condenser is placed across the secondary of the microphone transformer.

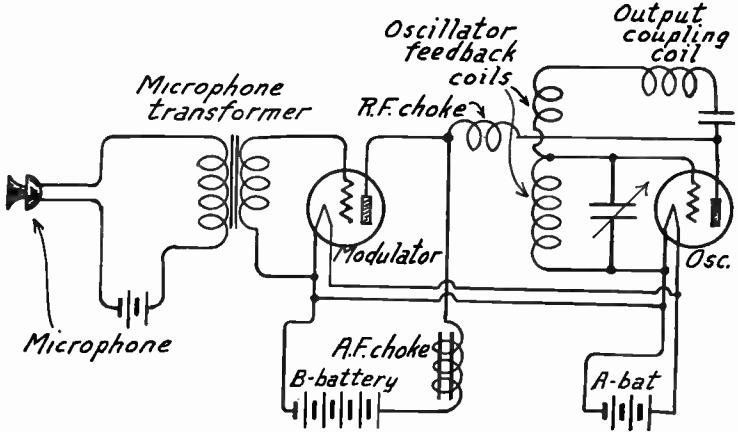

FIG. 2.—Absorption Method of Modulation.

Thus, in effect, the resistance of the plate circuit of the modulator varies at sound frequencies. With two resistances in parallel, the current through each will depend on their relative resistances at any one instant. Change of plate resistance of the modulator therefore changes the current through its own

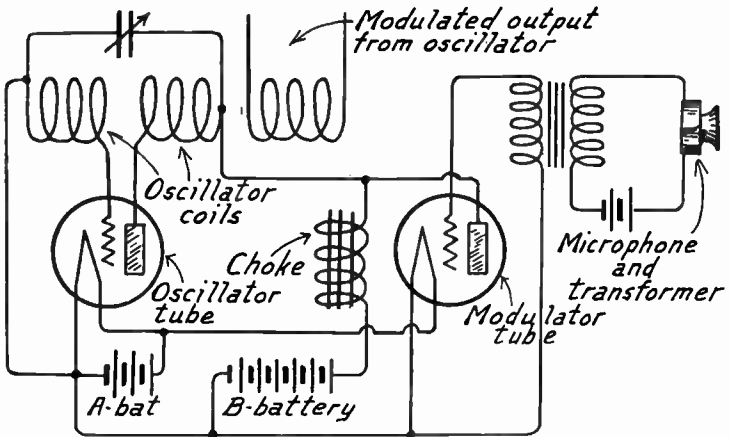

FIG. 3.—Modulation by Variation of Input Power.

plate circuit and also changes the amount of current or plate voltage to the plate circuit of the oscillator tube at the same frequencies.

Variation of the plate supply to the oscillator tube causes sound frequency variations in the output of this tube and its output is modulated according to

MODULATION

the sound frequencies impressed on the microphone in the first place. The radio frequency waves emitted by the oscillator carry the sounds which it is desired to transmit.

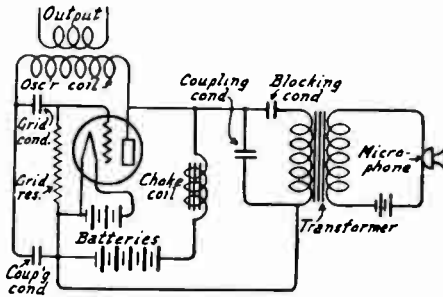

FIG. 4.—Plate Circuit Modulation.

In the three circuits shown so far the modulation is impressed on the grid circuit of the oscillator, but it is also possible to directly modulate the plate circuit. One such circuit is shown in Fig. 4. An oscillatory circuit is formed by the oscillator coil and the coupling condensers, this circuit being connected across the plate-filament circuit of the tube. The grid circuit of the tube is connected to this oscillatory circuit through the grid condenser to provide the feedback necessary to maintain oscillations. The secondary winding of the microphone transformer is connected between the plate and filament of the tube so that the variations of voltage in this secondary are added to and subtracted from the steady plate voltage. This variation of the plate voltage produces corresponding variations or modulation in the strength of the output. Such a method is often called power modulation.

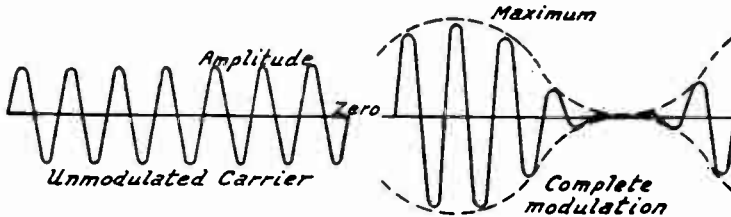

FIG. 5.—Complete Modulation of Carrier Wave.

Percentage of Modulation.—The carrier wave sent out from a transmitter may be represented as at the left in Fig. 5, all the waves being of equal amplitude. If a modulating voltage equal in strength to the carrier amplitude be applied, the carrier amplitude will be alternately reduced to zero (as the modulating voltage is subtracted) and will be doubled (as the modulating voltage is added to the carrier amplitude). This is called complete modulation or one hundred per cent modulation and is indicated at the right in Fig. 5.

MODULATION OF OSCILLATOR

If the modulating voltage is greater than the carrier amplitude the effect will be as at the left in Fig. 6 and the radiated wave will not correspond to the modulating voltage. Voltages or amplitudes within the space enclosed by the broken lines are partially reversed in polarity with the result that the signal is badly distorted. Neither complete modulation nor excessive modulation may be used in broadcasting. The modulating voltage must always be less than the carrier amplitude or voltage so that the carrier is never reduced to zero and so that the increase and decrease of carrier amplitude will correspond to the modulation applied. Such an effect is shown at the right in Fig. 6.

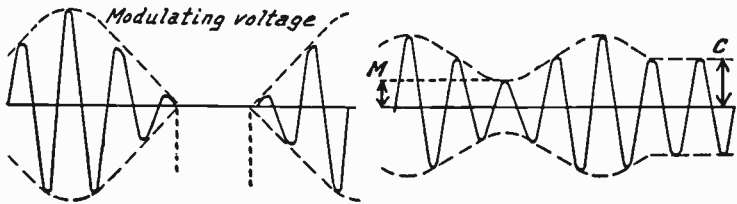

FIG. 6.—Percentages of Modulation.

The percentage of modulation depends on the amplitude of the unmodulated carrier, as at C in Fig. 6, and on the minimum amplitude of the modulated carrier, as at M in Fig. 6. The difference between these two values, divided by the unmodulated amplitude C and multiplied by 100 gives the percentage of modulation. Thus, with value C equal to 125 and value M equal to 75 there would be forty per cent modulation because the difference, 50, divided by 125 equal 0.4 and this multiplied by 100 equals 40. The greater the percentage of modulation the greater the signal strength from a transmitter.

MODULATION OF OSCILLATOR.—See *Oscillator, Audio Frequency, Uses of.*

MONEL METAL.—A natural alloy composed of 68 to 70 per cent nickel, 28 to 30 per cent copper and 2 per cent iron. Its resistance is 256 ohms per mil-foot.

MORSE CODE.—See *Code.*

MOTORBOATING.—A regular “putt-putt” or rise and fall of volume at the loud speaker. It is due to low frequency oscillations produced by feedbacks or regeneration in the audio amplifying and power supply system or to incorrect filament and plate voltages.

The trouble sometimes may be eliminated by increasing the capacity of the condenser nearest the receiver in the B-power supply unit, also by increasing the capacity of the bypass condensers between the various plate voltage terminals and the negative side of the power supply unit. These condensers may be identified in the diagrams under *Power Unit, Plate Voltage Types.* With battery power the motorboating may be caused by lack of the battery bypasses shown under *Condenser, Bypass.* A separate bypass condenser must be placed between each plate voltage terminal and the negative line.

Motorboating is more apt to occur with all audio amplifying stages exactly alike in units and wiring than when combinations of transformer, impedance and resistance coupling are used. Reversing connections on the grid side of one transformer or impedance may help. Blocking of a tube due to too high grid leak resistance will cause a motorboating effect.

MOTOR-GENERATOR

When using a plate power supply the usual voltage divider may be replaced with the system illustrated in Fig. 1 to reduce the tendency to motorboat. Separate adjustable resistors control the voltage to each tap and bypass condensers of one microfarad or greater capacity are placed between B-minus and the receiver side of each resistor. The resistor R allows a steady drain on the power supply for the purpose of maintaining a reasonably steady voltage with varying loads. The flow through this resistor should be between ten and twenty mils. The required number of ohms is found by multiplying the maximum voltage from the filter by 1000 and by then dividing this result

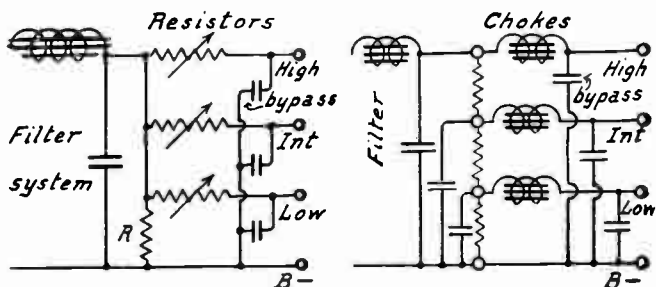

FIG. 1.—Use of Series Resistors. FIG. 2.—Connection of Chokes.

by the number of mils desired as a steady drain. The greater the number of mils the better will be the voltage regulation but the greater load will be placed on the power supply.

Another plan for the reduction of motorboating is shown in Fig. 2. Iron-cored choke coils having an inductance of at least ten henries each are connected between each voltage tap and the receiver terminals. Bypass condensers having one microfarad or greater capacity are connected from the receiver side of each choke to the B-minus terminal. This plan requires no changes in the power supply, calling only for the addition of outside chokes and condensers.

MOTOR-GENERATOR.—An electric motor and a generator are often connected together with the motor driving the generator for the production of suitable voltages for plate circuits, filament circuits or both in either receivers or transmitters. The generator is always of the direct current type, the motor being alternating or direct current type according to the available supply current for driving it.

MOULDED INSULATION.—See *Insulation, Moulded and Laminated.*

MOUNTING, COIL.—See *Coil, Mounting of.*

MOVING COIL LOUD SPEAKER.—See *Speaker, Loud.*

MU.—The name of the Greek letter which is a symbol for the amplification constant of a vacuum tube. See *Tube, Amplification of.*

MULTIPLE CONDENSER.—See *Condenser, Multiple Types.*

MULTIPLE ELEMENT TUBE OR MULTIVALVE.—See *Tube, Multiple Element.*

MULTIPLE REGENERATION

MULTIPLE REGENERATION.—See *Regeneration, Methods of Obtaining.*

MUSIC.—See *Sound.*

MUSLIN, VARNISHED.—See *Cloth, Insulating.*

MUTUAL CONDUCTANCE.—See *Tube, Mutual Conductance of* and *Tube, Characteristics of.*

MUTUAL INDUCTANCE.—See *Inductance, Mutual.*

N

n.—A symbol for number of turns, revolutions, etc.

NATURAL FREQUENCY.—See *Frequency, Fundamental.*

NAVY SOCKET.—See *Socket, Tube.*

NEATSFOOT OIL.—See *Oils, Insulating.*

NEGATIVE.—An electrical pressure less than that of the earth is called negative. The negative parts of a circuit are those toward which the current is assumed to flow, they are the parts having lower electrical pressure than other parts which are said to be positive. Negative is the opposite of positive. A negative current is a current flowing toward the source, a negative conductor is one carrying negative current. Parts which are negative are marked with the negative or minus sign “-”.

NEGATIVE BIAS.—See *Bias, Grid.*

NEGATIVE RESISTANCE.—See *Resistance, Negative.*

NEON LAMP.—See *Television.*

NEUTRAL.—Neither negative nor positive.

NEUTRALIZING.—See *Balancing.*

NEUTRALIZING CONDENSER.—See *Condenser, Balancing.*

NEUTRODYNE RECEIVER.—See *Balancing.*

NODE.—A point in a series of vibrations or waves at which there is no motion in any direction. In the rise and fall of electromagnetic or electrostatic waves, the nodes are the points between

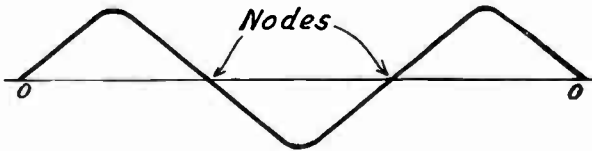

Nodes in a Wave.

risers and falls, the zero points. In an alternating current or voltage the nodes are the points at which there is no flow of current either way or at which there is no voltage.

NODEN VALVE.—One cell of an electrolytic rectifier. See *Charger, Battery, Electrolytic Type.*

NOISE.—In considering the subject of noise and its elimination from radio reception it is first necessary to distinguish between different kinds of noises. The kinds of noises discussed in this section are those which are not due to interference, to static, to distortion or to uncontrolled oscillation.

NOISE

If the noise is simply a case of poor reproduction with some notes over-emphasized and others slighted, see *Distortion*. If the noise consists of howling, squealing and high pitched whistling and if it is reduced or eliminated by using less plate voltage or B-battery voltage, see sections on *Oscillation*; *Condenser*, *Bypass* and *Leak*, *Grid*.

If the noises continue after the antenna and ground have been disconnected from the receiver and are not of the kinds mentioned in the foregoing paragraph, they are properly classified as receiver noises. The receiver should first be tuned to resonance with some broadcasting station or some broadcasting frequency at which the noises are apparent, because without the receiver being so tuned the tracing of trouble is not so easy.

Thumping, Regular Ticking Noise and Vibrations.—Such noises are caused by oscillation starting and stopping at intervals corresponding to the frequency of the ticking, the vibrations or the regular thumping.

The oscillation may be produced by turning the regeneration or volume control up too far. It may also be caused by a grid leak of too high resistance or by a grid leak that is disconnected or otherwise completely out of the circuit. A rare cause of this trouble is a grid condenser that is too large.

Microphonic Noises and Howling.—It is sometimes found that a howling noise starts when the receiver is performing satisfactorily and this howling noise may steadily grow in volume until it completely drowns out the music or speech being received. This is called microphonic noise and is caused by vibration of some of the parts in the detector tube or in the audio amplifier tubes. The detector is the usual offender in this respect.

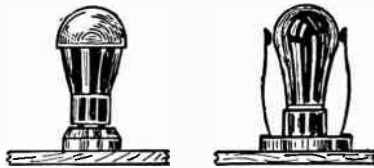

Noise Prevention with Devices for Deadening Vibration in Tubes.

The grid, the plate or the filament of the offending tube may be insecurely fastened so that the vibration of the sound waves from a loud speaker is sufficient to make these parts move inside the tube. This changes the distance between the grid and the plate or filament so that the plate current must follow the rapid vibrations. The plate current changes are amplified by following stages and the vibrations are reproduced in the speaker with great volume.

If the trouble is due to microphonic feedbacks of the sound vibrations to the tube elements, it may be stopped or greatly reduced by taking hold of the suspected tube with the fingers so that the vibrations are damped. The permanent remedy is to use a tube that is better constructed, or to use cushion sockets or cushion tube bases.

NON-INDUCTIVE WINDING

The noise may sometimes be prevented by moving the loud speaker into a different position with relation to the receiver.

The use of properly constructed tubes in cushion sockets or with cushion bases will prevent this trouble, but neither a good tube nor a good socket will always do the work alone. A tube should not give forth excessive and continuing howls when lightly tapped with the finger nail while the receiver is in operation. If it is impossible to use cushion sockets, the microphonic effect may be prevented by the use of various devices on the market for the purpose of holding the tube against rapid vibration. It is not necessary that the tube and its elements remain perfectly still, only that they do not vibrate at frequencies so high as to be within the audible range.

Rasping and Crackling Noises.—This class of noise is due to poor construction or poor design in the parts of the receiver. It is the kind of noise that is made worse or more noticeable when the receiver is jarred or vibrated as when the cabinet is struck or even when someone walks near the receiver.

If the noise becomes worse when any one control is turned, as when a condenser, a variometer or a rheostat is moved, that one part should be examined for bearings that are loose or dirty, for contact springs that are loose or have dirt under them and for pigtail connections that have become loose. If there is a decided rasping or clicking when a tuning condenser is moved over one part of its range, it may be found that the stator and rotor plates are bent and touching each other.

All batteries and battery connections should be examined. The B-batteries or the A-battery may be run down. It is more than likely that battery connections have become loose and that storage battery terminal connections have become eaten and corroded.

Each tube should be removed from its socket and replaced again. While the tube is out, clean the tips of the prongs on the tube base and make sure that the socket contacts are clean and have sufficient tension to make firm contact with the tube prongs. The tubes may possibly be of such poor quality that their low grade filament wire will cause noise whenever it is heated. This may be determined by substituting another tube for a noisy one.

The detector tube grid leak may be at fault. First try turning it around in its clips or tighten its connections. Substitute another leak if possible. Cheap grid leaks are notoriously noisy.

While examining inside the receiver remove dust and dirt from all bare metal parts, especially from between the plates of tuning condensers. The plates may be cleaned easily with an ordinary pipe cleaner.

It may finally be necessary to test every terminal connection and wire joint in the receiver. This is most easily done by taking a long thin piece of wood or any other insulating material with which every suspected joint and wire may be pushed back and forth and pulled if necessary. Should the noise become much worse or should reception be stopped when any one point is thus tested, the seat of the trouble has been found. Look especially for corroded and loose soldered joints and for worn or displaced insulation. During this examination test the cords leading to loud speakers and batteries by pulling them and bending them while the receiver is in operation. See also *Interference and Trouble, Receiver, Location and Remedy of*.

NON-INDUCTIVE WINDING.—See *Coil, Non-inductive*.

OAK WOOD.—See *Wood*.

OHM.—The unit of measurement for electrical resistance to flow of current. One ohm resistance in a circuit will allow a pressure of one volt to send a current of one ampere through the resistance. There is one ohm resistance in 156.6 feet of ordinary number 18 copper bell wire at ordinary temperatures. One thousand feet of number 10 copper wire has a resistance of almost exactly one ohm. The number of ohms resistance in a circuit may be found by dividing the number of volts pressure across the circuit by the number of amperes flowing through it.

One ohm is defined as the resistance of a body of mercury having a weight of 14.4521 grams when formed into a thread of this metal 106.3 centimeters long and while maintained at the temperature of melting ice. See *Law, Ohm's*; also *Resistance*.

OHMIC RESISTANCE.—See *Resistance, Ohmic*.

OHM'S LAW.—See *Law, Ohm's*.

OILED CLOTH.—See *Cloth, Insulating*.

OILED PAPER.—See *Paper*.

OILS, INSULATING.—Various oils may be used as insulators or as dielectrics. Those commonly employed include castor, neatsfoot, olive, petroleum, and turpentine oils. One advantage in the use of oil either as an insulator or as a dielectric is that the film of oil instantly renews itself between two conductors after a momentary breakdown or puncture by high voltages. The following table gives the average dielectric constants of common oils and also gives their dielectric strengths in volts per thousandth of an inch or volts per mil:

DIELECTRIC CONSTANTS AND STRENGTHS OF OILS

	Dielectric Constant	Dielectric Strength Volts per Mil
Castor Oil.....	4.5 to 4.8	325
Neatsfoot Oil.....	3.0 to 3.2	225
Olive Oil.....	3.0 to 3.3	190
Petroleum Oil.....	2.0 to 2.2	125
Sperm Oil.....	3.0 to 3.2	225
Turpentine Oil.....	2.1 to 2.3	275

OLIVE OIL.—See *Oils, Insulating*.

ONE DIAL CONTROL.—See *Control, Single*.

OPEN ANTENNA.—See *Antenna, Open*.

OPEN CIRCUIT.—See *Circuit, Open*; also *Trouble, Circuit, Open, Location of*.

OPEN CIRCUIT JACK

OPEN CIRCUIT JACK.—See *Jacks and Jack Switches, Types of.*

ORDINATE.—See *Abscissa.*

OSCILLATION.—Everyone who has operated a receiver, unless it is of some thoroughly balanced type, such as any of the bridge circuits, has found that there is a decided tendency to howling and squealing when tuning in stations at low wavelengths or high frequencies. Most receivers have some means of controlling this howling or squealing which is caused by oscillation.

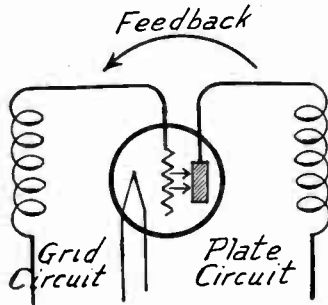

FIG. 1.—Oscillation Caused by Feedback from Plate Circuit to Grid Circuit.

When a part of the signal strength in the output or plate of a vacuum tube circuit is sent back to the input or grid side of this circuit it increases the strength of signal fed into the grid and increases the amplification. The feedback idea is shown in Fig. 1. This is called regeneration.

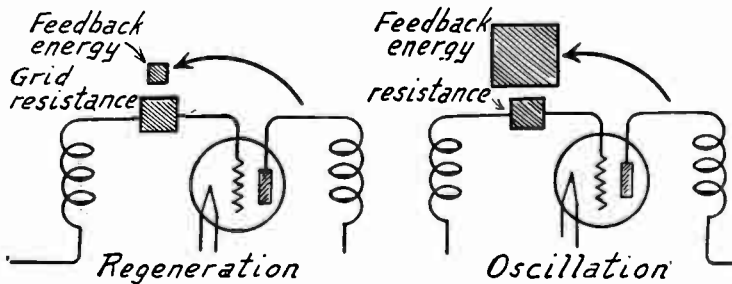

FIG. 2.—Oscillation Producing Feedback Energy Compared with Grid Resistance.

Regeneration, the feeding back of energy from the output to the input of the same tube, greatly increases the signal strength. It adds power to the input of the tube and greatly increases the signal voltage. The power added to the input side overcomes more and

OSCILLATION

more of the resistance in the grid circuit. It is possible to feed enough of the output power back into the input or grid side to more than overcome all of the resistance in the grid circuit. We have then passed the point of maximum regeneration and have reached the point of oscillation. Excess of feedback is illustrated in Fig. 2.

Until oscillation is reached, or as long as we have regeneration only, the grid circuit is absorbing power because of its resistance. But when the point of oscillation is reached we are furnishing more power to the grid circuit than it absorbs and this circuit then has an excess of power. This excess of power is amplified in the tube and increases the plate current. This increased plate current feeds back to the grid circuit and there is a still greater increase all over again.

Regeneration greatly increases the signal strength, but used in moderation it does not cause distortion. When the circuit starts to oscillate it may be impossible to hear the music or speech or, if they can be heard, they are badly distorted. Regeneration is desirable but free oscillation must be avoided. The distinction between regeneration and free oscillation should be kept clearly in mind.

Things Which Affect Oscillation.—The tendency to oscillate increases as the frequency increases or as the wavelength decreases, other things remaining the same. This is also true of regeneration. A receiver may deliver very weak signals from high wavelength stations, which are of low frequency. The same receiver may be very satisfactory at medium frequencies and wavelengths and may be almost impossible to control or to prevent from howling at low wavelengths and high frequencies.

We may have oscillation with radio frequency amplifier tubes, with detector tubes or with audio frequency amplifier tubes. In a receiver which includes all three kinds of tubes the greatest tendency to oscillate is found in the second radio frequency tube or in the third radio frequency tube if a third one is used. The next greatest tendency toward oscillation is found in the detector tube. The tubes in the audio amplifier have the least tendency to oscillate.

As a general rule the tendency toward oscillation is increased by low resistance, that is, by good design in the grid circuits. It is also increased by using large tuning coils with small condensers, although this is good practice. The tendency to oscillate is generally increased by close coupling in radio frequency transformers because the close coupling allows a greater transfer of power and increased signal voltage in the grid circuit to begin with. Loose coupling of the antenna circuit increases the oscillation tendency because the loose coupling removes some of the load from the grid circuit of the first coupled tube, or reduces the loss of energy from the coupled circuit into the antenna. Tube filaments lighted at normal brilliancy further increase the likelihood of oscillation.

The tendency to oscillate is increased by increase of plate voltage. The higher the voltage the more easily will the circuit oscillate. Oscillation is increased by connecting two or more radio frequency or audio frequency stages to the same B-battery or power unit.

Of course, this is the common practice. The reason for this increased oscillation is that the resistance of the common power supply forms a resistance coupling between the stages and there is a feedback of energy through this resistance coupling.

The converse of all of the above causes of increased oscillation will naturally reduce oscillation.

OSCILLATION

FACTORS CONTROLLING OSCILLATION

Tendency toward Free Oscillation Is Increased by—	Tendency toward Free Oscillation Is Decreased by—
Higher frequencies or lower wavelengths Additional radio frequency stages Low resistance, good design Large tuning coils and small condensers Close coupling between coils Loose coupling of antenna circuit Normal filament voltage High plate voltages Using common B-battery or power unit	Lower frequencies and higher wavelengths Fewer radio frequency tubes or stages High resistance, poor design Small tuning coils and large condensers Loose coupling between coils Close coupling of antenna circuit Reduced filament voltages Lower plate voltages Using separate B-batteries

Controlling or Preventing Free Oscillation.—Oscillation may be controlled by four principal methods. First we may eliminate couplings through which energy can feed back from the output to the input circuits. These couplings may be inductive, such as the coupling between the coils. They may be capacitive, as in the coupling between nearby wires, coils or other parts which are at different voltages. The couplings may also be through resistance such as that of batteries or power units connected to more than one stage.

A second method of control balances the feedback with a second feedback whose effect is the opposite to that of the first one. Such methods are used in all bridge circuits. In these circuits we allow the undesired feedback to take place but add another feedback which sends energy into the grid circuit in the opposite direction and in the same amount as the undesired feedback so that the two balance each other. See *Balancing*.

The third method reduces the power either in the grid circuit or in the plate circuit below the point at which there is sufficient excess energy to cause oscillation. With such methods we can use maximum regeneration but can prevent enough power or energy from appearing in the circuits to cause oscillation.

The fourth method introduces resistance or losses into the circuits, either into the grid circuit or into the plate circuit. This resistance absorbs the excess of power that is fed back from plate to grid circuit or absorbs so much power that too little is left as a feedback to cause free oscillation. Such resistance is usually put into the grid circuit since it does its work more effectively here than in the plate circuit.

The introduction of resistance does not mean only resistances formed by lengths of resistance wire such as in rheostats, but it means any added high frequency resistance or any loss that acts as an effective resistance.

OSCILLATION

Increasing Oscillation Tendency.—It is possible to increase the tendency toward oscillation in several different ways. Anything that increases the tendency to oscillate also increases the ability of the circuit to regenerate before oscillation sets in. Aids to oscillation which may be controlled so that regeneration is not allowed to pass into oscillation are desirable, while aids to uncontrolled oscillation are undesirable.

The first great class of aids to oscillation is that composed of means to lessen the resistance in the grid circuit. Lowered resistance in the grid circuit means a great gain in selectivity, in signal strength, and in distance-getting ability. The grid circuit resistance is reduced by using coils made of the proper size wire properly insulated and mounted or built on forms whose construction and material do not add resistance. All of these points are taken up under the heading of *Coil, Design, and Coil, Losses in*. Grid circuit resistance is also reduced by using high grade tuning condensers. A well built tuning condenser in connection with an efficient coil will always make a circuit which oscillates readily when tuned to resonance at the received frequency.

Finally the grid circuit resistance is reduced by using less coupling in the radio frequency transformers or between the antenna coil and the first tuned circuit. This coupling should be close enough to obtain a satisfactory transfer of power between the two circuits but should not be so close that the high resistance of the antenna circuit or of a coupled plate circuit is placed on the grid circuit. We do not want to reduce the tendency to oscillate by increasing resistance in any form. See *Coupling, Optimum*.

The second great classification of aids to oscillation is in the increase of power, and here again we want to do everything possible to increase the power, even though the receiver will oscillate more readily.

Power is increased by using coils of large inductance with condensers of small capacity in the tuned circuits. The voltage drop across a large coil is greater than across a small one and it is this voltage drop that is impressed on the grid of the next tube. The increased voltage results in increased signal strength.

Normal heating of the filament, that is, operating a filament at its normal rated voltage will increase the tendency to oscillate when compared with tube operation at reduced filament heating and voltage. All tubes should be operated at their normal filament voltage because it is then only that the tube works at maximum efficiency.

Finally we obtain an increase of power and increase in the tendency to oscillate by increasing the plate voltage applied to the tubes. Yet it is only by applying a normal or proper plate voltage to the tubes that we can cause a sufficient flow of electrons in the plate circuit to obtain real volume and distance-getting ability from the receiver. While it would be desirable to operate all tubes at maximum possible plate voltage, this cannot always be done because the power might be so great with certain designs that no available means would be sufficient to prevent free oscillation. Therefore, in some well designed receivers, oscillation is controlled by reducing the plate voltage.

We now find that there are certain well understood practices by means of which the efficiency of a receiver is improved while the tendency toward oscillation is increased at the same time. A list follows:

OSCILLATION

AIDS TO OSCILLATION

Lower Resistance in Grid Circuit,	Coils so built as to reduce high frequency resistance losses of all kinds. Condensers having low losses. Moderate coupling in transformers.
Increasing Power,	Large inductance in coils. Small capacity in condensers. Use of normal filament voltages on tubes. Use of high plate voltages.

Eliminating Uncontrolled Oscillation.—Now we come to the causes of oscillation which are wholly undesirable and which we wish to eliminate or counterbalance. They include all the uncontrolled causes of feeding energy backward from the plate circuit to the grid circuit of the same tube or from the plate of any tube to the grid of another tube preceding it in the receiver.

A note should be made here that in receivers of the regenerative type there is provided an intentional feedback from plate to grid circuit but this feedback in a regenerative set is under control and is adjustable. It is used to bring the circuit up to maximum regeneration while keeping it below oscillation. In talking of feedbacks we are not concerned with these intentional feedbacks but only with feedbacks which are not adjustable and which are not under the control of the operator after the receiver is designed and built.

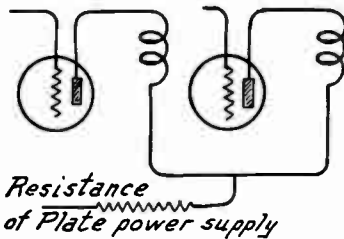

FIG. 3.—Feedback through Plate Supply Resistance to Cause Oscillation.

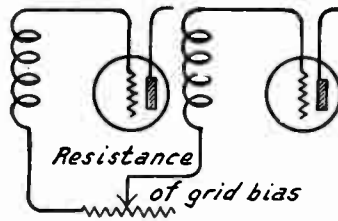

FIG. 4.—Feedback through Grid Bias Resistance to Cause Oscillation.

There are three kinds of undesired feedback. One kind occurs through resistances which are common to more than one circuit and these are called resistance feedbacks. Another feedback is caused by coupling between parts which have inductance such as coils and loops of wire. These are called inductive feedbacks. Then we have the feedbacks caused by capacity effects between all of the various parts in the circuit, that is, between all parts which are conductors.

Resistance Feedbacks.—Whenever two or more circuits come together at a resistance there is a resistance feedback because we have a resistance coupling at this point. An explanation of this coupling is given under the heading *Coupling, Resistance*. It will be recognized that the act of connecting the plate circuits of two or more tubes to a common B-battery provides a coupling between

OSCILLATION

these tubes by means of the resistance of the battery as shown in Fig. 3. Whenever we connect the grid return of the grid circuit of two or more tubes to a common C-battery or to the battery side of a common rheostat we have a resistance coupling through the resistance of the C-battery or the rheostat as in Fig. 4. With any of these resistance couplings there is a chance for energy from one stage or tube to be transferred back to a preceding stage or tube.

Now for the elimination of resistance feedbacks. It would be possible to use separate A-batteries, B-batteries and C-batteries for each tube in the set and this would eliminate many resistance feedbacks. Of course such a procedure is out of the question because of the space and expense involved.

Fortunately it is comparatively easy and not so very expensive to complete each plate circuit and each grid circuit without their going through the B-battery or the C-battery. In the ordinary receiver the plate circuit may be considered as starting at the filament. Electron flow is from filament to plate, then through the plate and

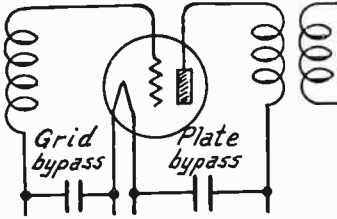

FIG. 5.—Bypass Condensers for Reducing Feedback Couplings and Oscillation.

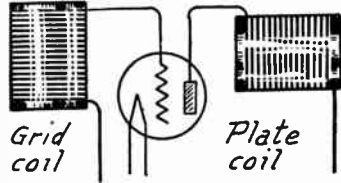

FIG. 6.—Coils Placed to Have Minimum Inductive Coupling in Reduction of Oscillation.

the external coupling in the plate circuit which may be a coil or a resistance. From here the electron flow is to and through the B-battery or power unit back to the connection to the A-battery and then to the filament, thus completing the circuit. If two stages or more are connected to one B-battery or power unit, the electron flow from both or from all of them is through the same unit.

The proper procedure is to place a large capacity condenser across the B-battery or, when building the receiver, to connect this condenser between the tube filament and the B-battery or power supply end of the coil or resistance in the plate circuit as in Fig. 5. Flow of plate electrons is then from plate to coupling coil or resistance, through this large condenser and back to the filament without going through the B-battery. When each tube or each stage is provided with such a bypass the resistance coupling will be practically eliminated.

The capacity of such a bypass condenser for radio frequency tubes should be at least .006 microfarad and may well go as high as .01 microfarad. The capacity of the bypass condenser in detector and audio circuits should be one microfarad. It is not sufficient to use only one bypass if the feedback is to be eliminated. A separate bypass must be used on each stage or tube of the receiver. The connections of all these bypasses are shown under *Condenser, Bypass*.

OSCILLATION

The coupling through C-batteries is eliminated by connecting a bypass condenser of large capacity, such as one-half to one microfarad, between the negative filament terminal of each audio frequency tube socket and the filament or "F" terminal on the audio frequency transformer which is ahead of this tube. The grid terminal on that transformer connects to the grid terminal on the socket of the tube in question.

If the grid returns from the secondaries of the radio frequency transformers are connected to the battery side of a rheostat which controls all radio frequency tubes, there will be a back coupling through this rheostat unless the bypass condensers are installed.

Inductive Feedbacks.—It is well known that the magnetic fields of two coils will couple with each other unless the coils are a very great distance apart, a distance greater than could be provided in a radio receiver.

When two coils have their axes in line their coupling will depend on the separation between the coils. While they are in line, moving them closer together will increase the coupling and moving them apart will decrease it.

If the separation of the two coils remains the same, turning them so that their center lines or axes are at an angle with each other will

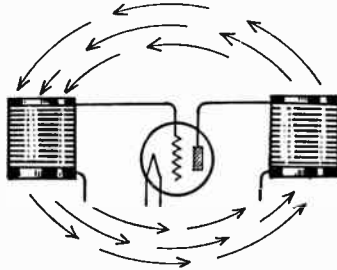

FIG. 7.—Feedback Coupling between Parallel Coils Causing Oscillation.

reduce the coupling and when the two coils are at right angles, as in Fig. 6, the coupling will be as near zero as it can be made. Therefore, one method of reducing inductive feedback due to magnetic fields is to place the coils at right angles to each other and another method is to place them as far apart as possible.

There is a third method of reducing inductive feedback. If two or more coils are placed parallel to each other, the magnetic field from one of them will pass through the other as shown in Fig. 7. Whenever lines of force cut through or pass through one side of the turns of wire on a coil, and do not also cut through the opposite side of the same turns, there will be a voltage induced in the turns. But if all of the lines of force which cut through one side of a coil also cut through the other side, then equal and opposite voltages are induced in the two sides of the same turns of wire. These voltages balance each other and there is no induced current and no inductive coupling.

By inclining the center lines of the coils, still keeping them parallel but changing the angle or inclination of the coils from a line drawn through all

OSCILLATION

of them, more and more of the magnetic lines of force sent out by adjacent coils will cut through both sides.

This angle or inclination may be increased until the point is reached at which all of the lines of force cutting through one side of a coil also cut through the other side as in Fig. 8. At this particular position there will be minimum magnetic coupling. The exact angle for this absence of coupling varies with the coil diameter and coil length. It is often said that the proper angle is fifty-four degrees and fifty-seven minutes because in some of the first Neutrodyne receivers the coils happened to be of such proportion that this particular angle was required.

To determine the proper angle for any receiver the quickest and most practical method is to try various inclinations while receiving a station whose wavelength is around 350 to 400 meters. See also *Coil, Angle of Mounting*.

There is a fourth kind of inductive feedback which is present in the great majority of poorly designed receivers and in a great many of the home-made variety. This is an inductive feedback through closed loops in the wiring.

A closed loop is formed whenever the wire for the positive side of any circuit is some little distance from the wire for the negative side of the same circuit as in Fig. 9. This applies to all of the filament circuits, that is, to all circuits connected to the A-battery.

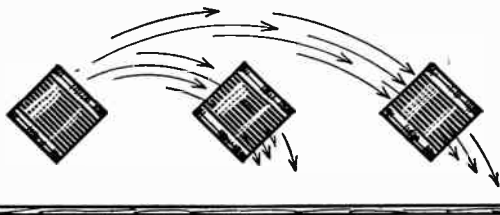

FIG. 8.—Coils in Position of Minimum Coupling and Minimum Oscillation.

It also applies to all plate circuits or circuits connected to the B-battery and finally it applies to grid circuits or circuits connected to the C-battery.

It is very easy to eliminate this form of coupling by bunching or cabling the battery wires. It is true that connections between coils and grids of the tubes should be well separated from all other leads. It is also very desirable that all connections attached to the plate terminal of tube sockets be well separated from all other wires. But all the remaining wires which run to or from any of the batteries should be run close together, in fact it is best to use insulated conductor and to actually bind all of these wires together into one cable. It is better to make the battery leads long and cable them than to make them short and have them run by themselves.

Various remedies and preventatives for most of the feedbacks have been suggested. There is one method that has not yet been mentioned. It is not only the most effective method of preventing capacity couplings between coils or condensers but also of preventing the least trace of inductive coupling between coils. This method consists of using metal shields between the parts which must not couple. Shielding is generally made of copper or aluminum and the shields are grounded. This subject is taken up under the heading of *Shielding*.

OSCILLATION

Capacity Feedbacks.—Capacity feedbacks are the most troublesome of all because they are hardest to locate and hardest to remedy. It is unfortunate that a certain capacity feedback in a receiver becomes worse and worse the higher the frequency or the lower the wavelength. There are capacities inside the tube between filament, plate and grid; also between the windings of transformers and of all coils. There are also capacities between condensers and between all of the separate wires in a receiver. At ordinary broadcast frequencies some of these capacities form a path almost as easy as a piece of metal for the high frequencies to follow.

Much of the work in preventing oscillation is in attempts to avoid a feedback of energy from the plate circuit of a tube to the grid circuit of the same tube. Yet within the tube itself there is a fairly large capacity between the plate and the grid. This capacity varies somewhat with different tubes but always amounts to a few micro-microfarads and is plenty large enough to carry considerable high frequency current from the plate back to the grid.

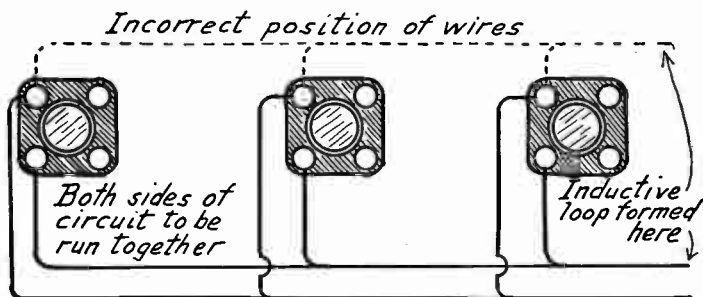

FIG. 9.—Wires Run Together to Avoid Loops Which Cause Oscillation.

An effective way to overcome the feedback between plate and grid is to use another feedback which sends energy in the opposite direction through an additional circuit outside the tube. This is the principle used in all bridge circuits and balanced circuits. The external feedback, which is to balance out the internal feedback in the tube, is made of opposite phase to the tube feedback. Each positive alternation passing through the tube capacity is balanced by an equal negative alternation through the external feedback. The various methods of accomplishing this result are described under *Balancing*.

It is said of many receivers that they are self neutralized or that they do not require special control of oscillation. Such receivers contain sufficient resistance or loss in their circuits to prevent oscillation.

Most builders of radio receivers realize that there is an inductive feedback caused by the magnetic fields of coils but they sometimes forget that there is also a capacity feedback between coils. Any two coils wound with metal wire and separated by an air space form the two plates of a condenser separated

OSCILLATION

by the dielectric air. There is an electrostatic field as shown in Fig. 10. This capacity is reduced by separating the coils a greater distance.

Toroid or closed field coils of any type have practically no inductive coupling because they have practically no external magnetic field, yet two such coils have a capacity coupling in proportion to their size and nearness to each other. The less the bulk of two coils the less will be the capacity between them and the greater their distance apart the less will be the capacity between them.

Finally we have capacity feedbacks between the different wires in a receiver. The most troublesome are between plate and grid wires. Such feedbacks are easily eliminated by keeping all plate and grid connections as far apart as possible and, when they must come near to one another, running plate wires at right angles to grid wires or at least running them so that they are not parallel with grid wires. This is one great disadvantage with the beautiful appearing parallel and square-cornered wiring in many receivers. It would be far better from the standpoint of radio reception to run plate and grid wires as directly as possible between the two points they connect and not to lengthen them and run them all parallel.

The tuning condensers should be placed at the greatest possible distance from each other. The tuning condensers include large masses of metal and if condensers in successive stages are close to each other, there will be a large capacity feedback between them.

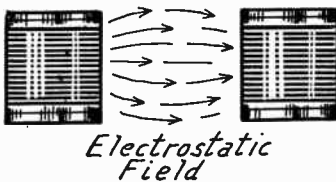

FIG. 10.—Capacity Effect between Coils Which Causes Oscillation.

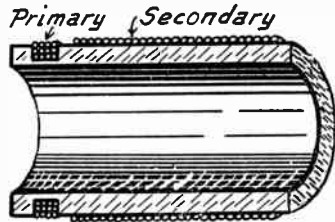

FIG. 11.—Primary and Secondary with Minimum Capacity Coupling to Reduce Oscillation.

Capacity Feedbacks in Radio Frequency Transformers.—The primary and secondary windings of radio frequency transformers may be closely coupled inductively but should have a very loose capacity coupling because there will be a considerable feedback with close capacity coupling. If we can make the coils small and compact and then keep them far apart, we will have little capacity coupling.

Capacity coupling between two coils or between the primary and secondary of a radio frequency transformer is determined by the size or surface area of the two coils and by their closeness to each other. The greater the size or surface area the greater will be the capacity coupling and the closer these comparatively large bodies are together the greater will be the capacity coupling. It is not practical to make the secondary coil of very small size because to do so would mean the use of super-imposed turns or very small sizes of wire. These things would increase the distributed capacity or resistance of the coil which would mean greater losses.

OSCILLATION

Resistance in the transformer primary circuit is of no great importance and it may be increased considerably without any great harm resulting. Therefore the primary should be made small in size. At the same time the primary may have a great deal of inductance because it may be made of a large number of turns of very small wire and these turns may be wound one over the other as in Fig. 11. A primary made in this way will have a very small surface area and regardless of how close it is placed to the secondary the capacity coupling between the two will be small.

Feedbacks through Plate Tuning Effect.—In a radio frequency transformer the inductance and distributed capacity of the winding connected to the plate may form a circuit which is resonant at some high frequency. The tube will then oscillate freely at this frequency. The winding may be made of less inductance, the change preventing this self-tuning effect.

In a radio frequency transformer using moderately close coupling or very close coupling the primary winding cannot be considered as entirely separate from the secondary. Tuning of the secondary winding with a condenser really serves to tune the primary winding to the same frequency when the coupling between the two is close. Under this condition the tube connected to the primary winding will oscillate when the secondary is tuned to the same frequency as the grid circuit of the preceding tube.

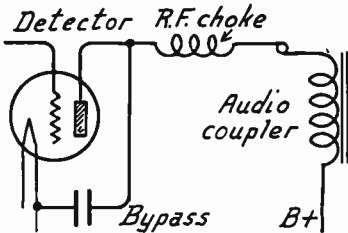

FIG. 12.—Radio Frequency Choke and Bypass on Detector for Prevention of Oscillation.

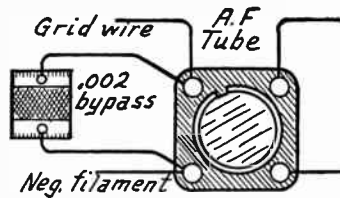

FIG. 13.—Bypass in Grid Circuit of Tube for Prevention of Oscillation.

Feedbacks in Audio Amplifiers.—Disagreeable howling is often caused by feedbacks from the audio frequency stages to preceding amplifying stages. Such trouble may be avoided by using short wiring connections in the audio amplifier. It is highly desirable to use not only a proper bypass from the detector tube plate to its filament circuit but also to insert a radio frequency choke as in Fig. 12 between the detector and the first audio amplifier coupling unit which may be a transformer, resistance or choke coil. See *Detector, Plate Bypass for*.

A loud speaker cord or connection that is brought from the audio frequency end of a receiver back toward or around the radio frequency end of the same receiver will almost always give rise to persistent howling. Howling due to high resistance feedbacks between audio stages is often due to run down plate or B-batteries. An open circuited grid return from any amplifier tube will cause similar howling.

OSCILLATION

Interstage feedback in an audio amplifier may show itself in a rather faint and high pitched whistling noise. This whistle may be noticeable only when listening carefully for it but its elimination will increase the volume and improve the tone quality. Trouble such as this may be located by temporarily connecting a .002 fixed condenser from the grid of one audio tube after another to the negative filament terminal of the same tube as in Fig. 13. The connection of this condenser at one of the tubes will either greatly reduce or entirely eliminate the whistle. In this particular case the whistling noise is caused by a high frequency feedback. The fixed condenser bypasses this high frequency current to ground through the negative filament line.

Even though no whistling be audible under any conditions, there still may be high frequency oscillation taking place in the audio tube. This oscillation is harmful to the tone quality and reduces the volume obtainable. The test shown in Fig. 14 may be applied to locate this trouble.

With the tube in proper operation there will be no rise or fall of average plate current caused by the signal. The plate current indicated by a milliammeter should be the same with and without a signal impressed on the grid. The milliammeter is cut into the circuit as shown and a reading taken. The grid and negative filament terminals are then shorted on each other and another meter reading taken. This second reading will be the same as the first if no oscillation is taking place.

Prevention of Feedbacks.—It is now possible to tabulate the methods employed for preventing uncontrolled oscillation due to various kinds of feedbacks. The following is a summary of methods just described:

FEEDBACK PREVENTATIVES

Resistance Feedbacks,	Use bypass condensers in plate and grid circuits. Avoid common grid returns to rheostat.
Inductive Feedbacks,	Place coils at right angles or at non-coupling angle. Place coils far apart. Avoid closed loops in wiring. Use interstage shielding.
Capacity Feedbacks,	Use external balancing feedbacks for tubes. Place coils far apart. Use coils of small physical dimensions. Do not run plate and grid wires parallel. Make plate and grid leads short. Place tuning condensers well apart. Make transformers with little capacity coupling between primary and secondary windings. Do not use excessively close inductive coupling in radio frequency transformers.
Audio Feedback,	Make all wiring leads short. Use detector plate bypass and radio frequency choke. Keep speaker cord and leads away from radio frequency Do not use run-down plate or filament batteries. Use proper plate and grid circuit bypasses in audio amplifier.

Methods of Preventing Free Oscillation.—Any method which absolutely prevents a receiver from oscillating under any condition

OSCILLATION

will at the same time prevent that receiver from using the maximum possible regeneration because of the small change required in any one circuit to change regeneration into oscillation. Since regeneration, properly used and controlled, is one of the most effective means of increasing a receiver's sensitivity, selectivity and power all at the same time it is generally true that some of these desirable qualities must be sacrificed to some extent if oscillation is to be absolutely prevented and put beyond the control of the operator.

Under the heading of *Regeneration, Methods of Obtaining* are described most of the ways in use by which regeneration is controlled. All of those methods control regeneration and if pushed too far will cause oscillation. In one sense those methods will therefore prevent oscillation because they need not be carried so far as to cause oscillation. When considering the control of oscillation or its prevention the methods described under *Regeneration, Methods of Obtaining* should be taken into account.

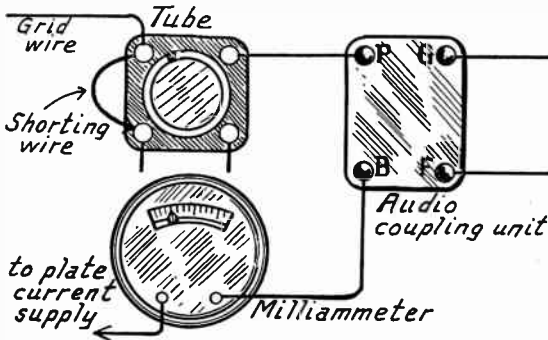

FIG. 14.—Testing Plate Current for Oscillation.

Free oscillation is most troublesome in intermediate radio frequency stages. The average tuned radio frequency set uses two stages of radio frequency amplification before the detector. There is very little trouble with free oscillation in the circuits attached to the first tube because the grid circuit of this first tube is coupled to the antenna circuit. This places a load on the grid circuit which quite naturally prevents oscillation. The second radio frequency tube has no such load and it is in this tube and its circuits that trouble is encountered. In applying preventatives of oscillation to only one tube they should be applied to the grid circuit or plate circuit of the second radio frequency tube.

Methods which absolutely prevent oscillation under any condition fall into two classes. In the first class are all the balancing or neutralizing methods by means of which the capacity feedback through the tube is balanced or neutralized by another external feedback of equal voltage but opposite phase. The source of this external feedback voltage may be from the secondary winding of the transformer following the tube, as in the Neutrodyne receiver; from the plate of the tube, as in the Rice circuit; or from an additional winding

OSCILLATION CONSTANTS

on the transformer, as in the Roberts circuit. This balancing feedback may be properly adjusted once for all by small condensers or high resistances in the feedback circuits. These methods are described in detail under *Balancing*.

The methods of controlling plate circuit power and those which control regenerative feedbacks are under the control of the operator and are classed as controls of regeneration, not as preventatives of oscillation.

In the second class of oscillation preventatives we have the methods of placing intentional resistances or losses, either apparent or disguised, in the various grid or plate circuits. One of the most common types of loss method is to place the coils so that their fields pass through the end plates of tuning condensers, these end plates being of metal. The eddy currents set up in the end plates prevent oscillation by absorbing power.

Another common method of preventing oscillation is to use a radio frequency transformer whose primary is made of only a very few turns, usually not more than six or eight, and sometimes even fewer turns being used. The transfer of energy in such a transformer is too small to support sustained oscillation. It is a method of failing to use available power which gives good results at high frequencies and poor results at low frequencies unless used with a very efficient antenna.

In a few receivers a resistance is placed permanently in the grid circuit or in the tuned circuit connected to the grid. This resistance absorbs or dissipates so much energy that oscillation cannot persist. At the same time it reduces both sensitivity and selectivity of the receiver.

When oscillation is caused by magnetic feedback between the transformer coils of two radio stages the trouble may be reduced or eliminated by reversing the connections to the primary winding of any one of the transformers. This reversal should be made with only one primary because if all are reversed the effect will be the same as before.

The magnetic feedback is similar to the feedback from a tickler coil to a grid coil in a regenerative receiver. Reversing the connections then produces a reversed feedback.

OSCILLATION CONSTANTS.—See *Resonance, Inductance-Capacity Values for*.

OSCILLATOR.—Any device which will produce and emit alternating radio waves or oscillations is called an oscillator. Oscillators are used as sources of either radio frequency or audio frequency energy. Oscillators may be operated either by means of a magnetic buzzer and battery or by means of a vacuum tube of the same kind generally used for amplifying or detecting in receivers.

A source of either radio or audio frequency which is always available and ready for use makes it possible to do practically all of the testing and experimental work that might be done while listening to broadcasting stations, but without the necessity of receiving signals from such a station. Such a source, in the form of a suitable oscillator, also makes possible many tests that otherwise could not be performed at all.

An oscillator may be used in calibrating frequency meters, in making predetermined logs or calibrations of receivers, in balancing radio frequency amplifying circuits and in testing the operation of

OSCILLATOR

a receiver in almost any way that it might be tested while in its accustomed use.

Various radio devices and units may be tested with the help of an oscillator. An audio oscillator may be used in trying out loud speakers and all audio frequency amplifying units. The oscillator is also useful in comparing high frequency resistances and losses in coils and condensers and with the help of a suitable bridge it is possible to measure capacity and inductance.

In effect an oscillator is a miniature broadcasting station which may be made to operate at any desired frequency or tone for any length of time required in the completion of tests and experiments.

The principle of a radio frequency oscillator is shown in Fig. 1. In its simplest form we have only the oscillatory circuit composed of the inductance or coil L , and the capacity or condenser C . When an alternating voltage or a pulsating voltage of any kind is applied across the terminals of this circuit oscillations will take place between the coil and condenser at a frequency determined by the values of its inductance and capacity.

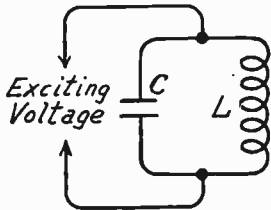

FIG. 1.—Principle of the Oscillator.

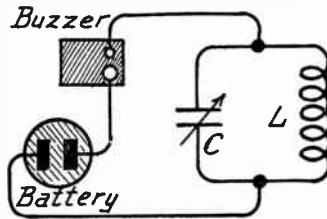

FIG. 2.—Buzzer Excited Oscillator Circuit.

One of the simplest methods of applying an exciting voltage is shown in Fig. 2. A battery or a single cell is connected through a buzzer to the terminals of the oscillatory circuit. The battery current is interrupted by the action of the buzzer and the battery's circuit is completed through the inductance coil L . The rapidity or frequency with which the buzzer operates has nothing to do with the frequency at which the circuit LC will oscillate. The frequency of oscillation is dependent on the values of inductance and capacity and not on the frequency of the buzzer action.

In place of exciting the oscillator circuit with a buzzer it may be excited by any other source of alternating current, either low frequency or high frequency. In Fig. 3 the plate circuit of a vacuum tube is used to excite the oscillatory circuit connected to the grid of the same tube. The coil in the grid circuit is coupled to a coil in the plate circuit so that energy from the plate circuit is fed back into the grid circuit. This will be recognized as a case of regeneration. The grid circuit will oscillate at a frequency determined by its inductance and capacity and this oscillation will be maintained by energy secured from the plate circuit.

In a case of this kind it does not matter which of the two circuits, grid or plate, is the tuned circuit. Fig. 4 shows the tuned coil and condenser in the plate circuit. Otherwise the connections are the same as in Fig. 3. The action is similar to that in Fig. 3 but now the frequency of oscillation is determined by the values of inductance and capacity in the plate circuit.

The close coupling between plate and grid coils in Figs. 3 and 4 will cause the tuned circuit to be strongly affected by the coil in the untuned circuit. If the coil in the plate circuit of Fig. 3 has sufficient distributed capacity to

OSCILLATOR

produce resonance with the plate circuit inductance at a natural frequency of this coil, the entire system may oscillate at this natural frequency rather than at the frequency of the tuned circuit. Such trouble may be avoided by loose coupling between the two coils or by coupling them through intermediate circuits.

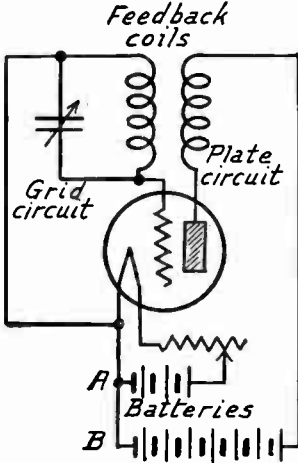

FIG. 3.—Oscillator with Tuned Grid Circuit.

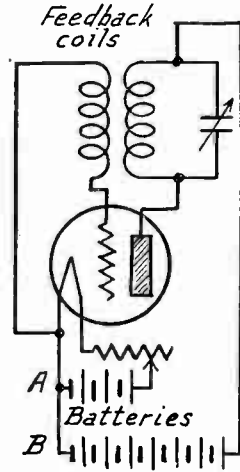

FIG. 4.—Oscillator with Tuned Plate Circuit.

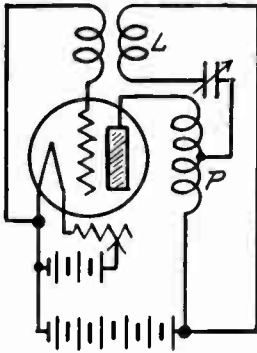

FIG. 5.—Oscillator with Part of Plate Coil in Tuned Circuit.

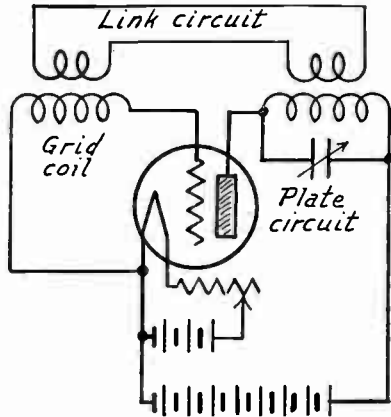

FIG. 6.—Link Circuit Coupling for Oscillator.

One method of preventing oscillation at a natural frequency of one of the coils is shown in Fig. 5. Here the tuned circuit includes only a small part of the coil *P* which is connected directly between the plate and the plate battery. Oscillation will not take place in the coil *L* of the tuned circuit

OSCILLATOR, AUDIO FREQUENCY

until there is an oscillating current through the plate coil *P* and the tuned circuit will then oscillate at its own proper frequency.

Still another method of obtaining loose coupling is shown in Fig. 6. Here the coil in the plate circuit is far removed from the coil in the grid circuit. The two are coupled through an intermediate circuit or a link circuit which may or may not be tuned.

The coupling between plate circuit and grid circuit must be close enough to produce an energy feedback sufficient to maintain oscillation, yet it must not be so close that the inductance and capacity of the untuned circuit will seriously affect the resonant frequency of the tuned circuit.

It is a well-known fact that any coil which is carrying oscillating current will radiate waves having the same frequency as that of the oscillating circuit containing the coil. Therefore, any of the schemes shown in Figs. 2 to 6 will radiate waves having a frequency determined by the inductance and capacity of the tuned circuit. Additional coils are sometimes used to obtain greater radiation but for most of the work done with oscillators additional coils are not required.

OSCILLATOR, AUDIO FREQUENCY.—An audio frequency oscillator produces or generates oscillations at audio frequency, not at radio frequency. The audio frequency oscillator does not radiate its energy in the form of electromagnetic waves as does the radio frequency oscillator. It is true that some interference may be caused by an audio oscillator if it is placed close to a broadcast receiver, but this effect is not a part of the intentional operation of the audio oscillator.

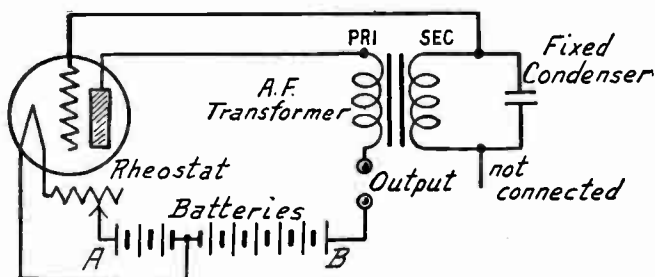

FIG. 1.—Simple Form of Audio Oscillator.

The output of the audio oscillator, in the form of audio frequency alternating current, is taken from the terminals of the oscillator and led through conductors to whatever device is to be operated from the oscillator.

Oscillator Design.—There are many satisfactory designs for audio oscillators. One of the simplest is shown in Fig. 1. For the construction of this unit the only parts required are an audio frequency transformer, a fixed condenser, a vacuum tube, a socket and a rheostat. The plate circuit of the tube is connected through the primary winding of the transformer to the B-battery. The grid of the tube is connected to one of the secondary terminals of the

OSCILLATOR, AUDIO FREQUENCY

transformer and the fixed condenser is placed across the transformer's secondary. The remaining terminal of the transformer's secondary is left unconnected. The output is taken from a point between the positive of the B-battery and the audio frequency transformer.

The circuit for a more satisfactory type of audio frequency oscillator is shown in Fig. 2. The base-board layout for this unit is shown in Fig. 3. The parts required are as follows:

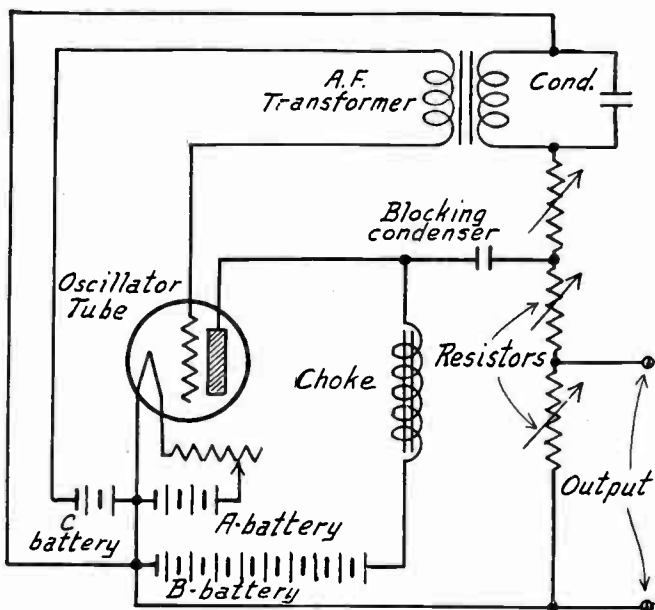

FIG. 2.—Circuits of Practical Audio Oscillator.

- One vacuum tube of the amplifier type.
- One tube socket.
- One rheostat of from twenty to thirty ohms resistance.
- One iron-core choke coil having from twenty to thirty henries inductance.
- One bypass condenser of one or more microfarad capacity.
- One audio frequency transformer.
- Several small fixed condensers in capacities ranging from .0001 to .006 microfarad and larger if available.
- Three variable high resistance units giving up to 100,000 ohms.
- Necessary terminals and wiring.

All of the connections should be made as indicated in Fig. 3.

This type of audio oscillator has the advantage of sending no direct current into its output circuit. Direct current in the output circuit makes most tests less reliable because the permanent magnets of speakers and the iron cores of many devices under tests are harmfully affected by high voltage direct current. Because of this feature

OSCILLATOR, AUDIO FREQUENCY

of the oscillator it is possible and quite desirable to use high plate voltages, either from B-batteries or from power supply units.

If the audio frequency transformer has a step-up ratio, if it is anything but a one-to-one unit, the grid of the oscillator tube should be connected to the primary winding at the plate terminal. The plate circuit of the oscillator tube comes through the coupling resistance and should be connected to the grid terminal in the secondary winding of the transformer. This allows a better range of frequencies and prevents the oscillating system from operating at the natural frequency of the winding connected in the grid circuit of the tube.

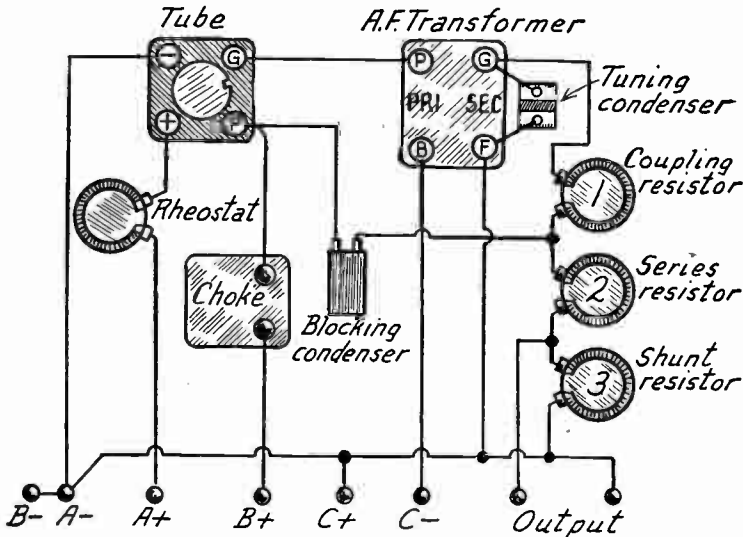

FIG. 3.—Layout for Practical Audio Oscillator.

Adjusting the Oscillator.—To test the operation of the oscillator a pair of headphones or a loud speaker unit may be connected to the output terminals. With proper batteries attached and a tube in the socket the rheostat is turned up until the tube lights at normal filament temperature. A note should then be heard from the phones or speaker. If no sound is heard, check the batteries, making sure the C-battery is in circuit and that the plate voltage is at least sixty, preferably more. It may be necessary to try a different tube since some tubes do not oscillate readily at audio frequencies, yet are satisfactory in a receiver.

Still failing to hear a note from the speaker or phones it is in order to try reversing the connections to either the primary side or secondary side of the audio frequency transformer, but not to both sides. This is to make sure that the feedback is in the right direction to produce regeneration and oscillation. Finally increase the resistance of the coupling resistor number 1, increase the resistance of the series resistor number 2 and lower the resistance of the shunt resistor number 3. Unless there is a fault in the parts used or in

OSCILLATOR, AUDIO FREQUENCY

the wiring a loud clear note will be heard from any reproducing unit connected to the output terminals.

The coupling resistor number 1 determines the amount of coupling between the plate circuit and the grid circuit of the tube. The less the resistance at this point the greater the degree of coupling. The proper coupling is determined by experiment, since it depends on the tube being used and on the impedance of the transformer winding to which this coupling leads. It will be found that less resistance is allowable when the oscillator is working at the lower frequencies. A high resistance, which is perfectly satisfactory for the higher frequencies, will prevent oscillation altogether on the low notes.

A wide range of frequencies may be obtained with adjustment of the series resistor number 2. With all other adjustments remaining the same, increasing the resistance of number 2 will lower the frequency of oscillation very decidedly while lessening this resistance will increase the frequency until it reaches very high notes. This makes a gradual increase or decrease of frequency possible with any one value of tuning condenser in use.

The shunt resistor number 3 is in shunt or in parallel with the load connected to the output terminals. The higher the resistance at 3 the more of the oscillator's output must flow through the load. The less this number 3 resistance the more of the oscillator's output will be bypassed around the load and the less will flow through the load. This resistance is adjusted to suit the characteristics of the load applied, making it possible to handle all types of speakers, transformers, chokes, amplifiers, etc.

Changing the filament voltage on the tube will make a very noticeable change in frequency and in power of the oscillator. In order to obtain results that may be used as a basis of comparison at different times the filament voltage should always be the same as long as any one tube is being used. To make sure of this point it is advisable to connect a filament voltmeter across the filament terminals of the tube socket. The correct voltage is then noted or is marked on the voltmeter scale so that the rheostat may be set for this voltage each time the oscillator is used.

The frequency at which the oscillator operates is determined by the inductance of the transformer windings and by the capacity of the fixed tuning condenser. Obviously it is impossible to change the transformer windings, so the easiest way of obtaining different frequencies for testing is to change the tuning condenser. The fastenings for this condenser should be such that different ones may be quickly slipped in place or removed.

While the tuning condenser in Fig. 3 is shown on the side of the transformer connected to the tube plate, it may be placed on either side or used alternately on both sides. Higher frequencies will be obtained by using a fixed condenser of given capacity on the smaller winding of the transformer. This would be the winding marked "Primary" and originally intended for connection in the plate circuit of an audio frequency amplifying tube. The highest frequency of which the oscillator is capable with given adjustments of the resistors will be obtained with no tuning condenser on either side of the transformer. For still higher frequencies it is necessary to change either number 1 or 2 resistance.

The greater the number of condenser capacities available the greater will be the number of different frequencies at which the oscillator may be operated. It is desirable to have as many values as possible between .0001 and .02 microfarads capacity. Condensers of quarter microfarad and larger capacity are of no use since they simply bypass all the energy.

OSCILLATOR, AUDIO FREQUENCY

Beat Frequency Oscillator.—A beat frequency oscillator produces an audible frequency by combining the oscillations from two radio frequency oscillators to produce beat notes at the lower frequency. This type of oscillator provides a continuously variable frequency over the entire audio range by means of one tuning condenser. This feature, together with a reasonably constant voltage output makes the beat frequency oscillator a most generally desirable and useful type for experimental work and testing.

The principle of this instrument is illustrated in Fig. 4. Each oscillator tube has its grid and plate circuits closely coupled to produce sufficient feedback for maintaining oscillation. The frequency of the first oscillator is fixed, being determined by the inductance of the coils and the capacity of the fixed condenser C across the grid coil. The frequency of the second oscillator is adjustable by means of the variable tuning condenser across the grid coil. With the tuning condenser at minimum capacity the frequencies of the

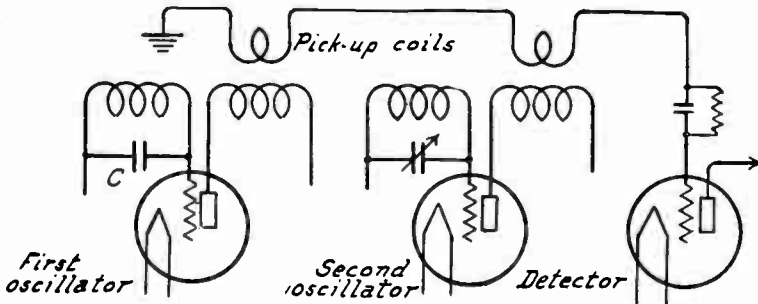

FIG. 4.—Principle of Beat Frequency Oscillator.

two oscillators are the same. Increasing the capacity of the tuning condenser will lower the frequency of the second oscillator.

Two pick-up coils are coupled to the two oscillator circuits and are connected together in the grid circuit of a detector tube. As the frequency of the second oscillator is made to depart from that of the first the two frequencies will beat together to produce a new and much lower frequency which is impressed on the grid of the detector tube. This action is explained under *Beats, Formation of*. At first the beat frequency will be very low but it will increase as the oscillator frequencies are made to differ more and more. The circuits are designed to provide beat frequencies from ten or fifteen up to fifteen thousand or more, thus covering the audio frequency range completely.

The schematic diagram for a beat frequency oscillator with a single stage of audio amplification is shown in Fig. 5. Tuning of the first oscillator is accomplished by means of a fixed condenser of 0.001 mfd. capacity in parallel with an adjustable condenser which may be varied from 0.0003 to 0.001

OSCILLATOR, AUDIO FREQUENCY

mfd. capacity, giving a total range of from 0.0013 to 0.0020 mfd. capacity. The second oscillator is tuned by means of a fixed condenser of 0.0015 mfd. capacity and a variable condenser of 0.00025 mfd. capacity, the latter being

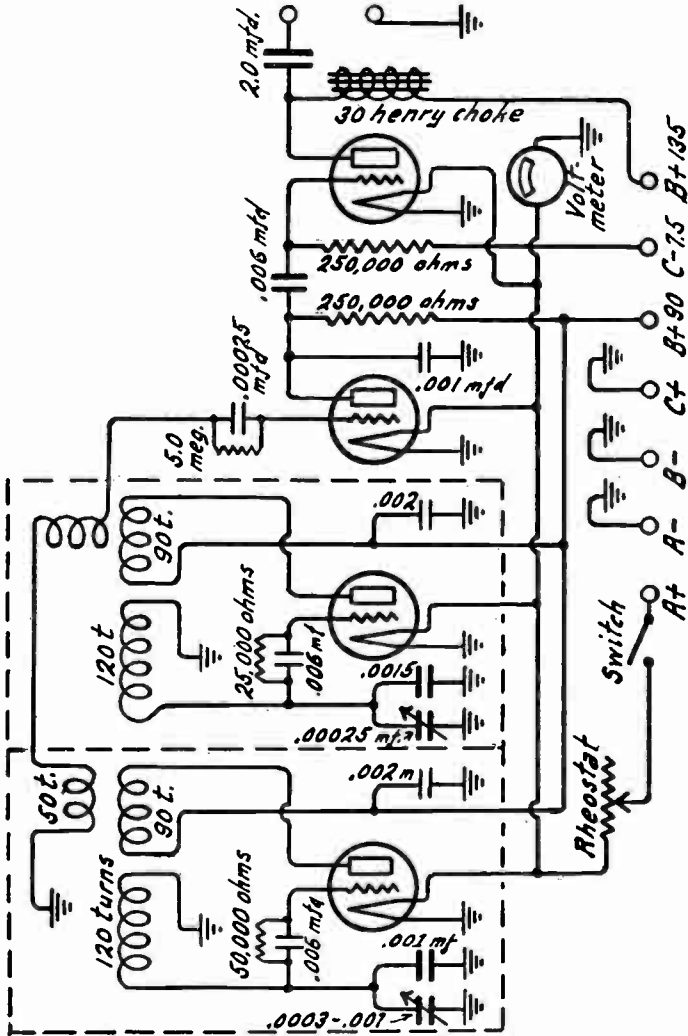

Fig. 5.—Circuit Diagram of Beat Frequency Oscillator.

of the type generally used in receivers for tuning radio frequency stages. The range of the second tuning unit is from about 0.00152 mfd. to 0.00175 mfd. capacity. The tuning range of the first oscillator extends both above and below that of the second.

OSCILLATOR, AUDIO FREQUENCY

The oscillator coils are alike. Each is made by winding on a $2\frac{1}{2}$ inch diameter tube 120 turns of number 30 double silk covered wire for the grid coil and 90 turns of the same kind of wire for the plate coil. A space of five-eighths inch is left between the ends of the coils. The tubing is $3\frac{3}{4}$ inches long.

The pick-up coil for the first oscillator is made by winding 50 turns of number 30 double silk covered wire on a $2\frac{1}{2}$ inch diameter tube which is $1\frac{1}{4}$ inches long. This coil is placed inside the plate end of the oscillator coil to provide a close coupling. The pick-up coil for the second oscillator is made by winding 25 turns of the same kind of wire on a $2\frac{1}{2}$ inch diameter tube $\frac{3}{4}$ inch long. This pick-up is placed at the plate end of the oscillator coil with its axis at right angles to the oscillator coil to provide exceedingly loose coupling. The two oscillator circuits are completely shielded.

Resistance coupling is used between the detector and the audio frequency amplifying tube. Direct current is prevented from reaching the output terminals by the use of a choke and condenser in the plate lead of the audio tube. A suggested layout for this oscillator is shown in Fig. 6.

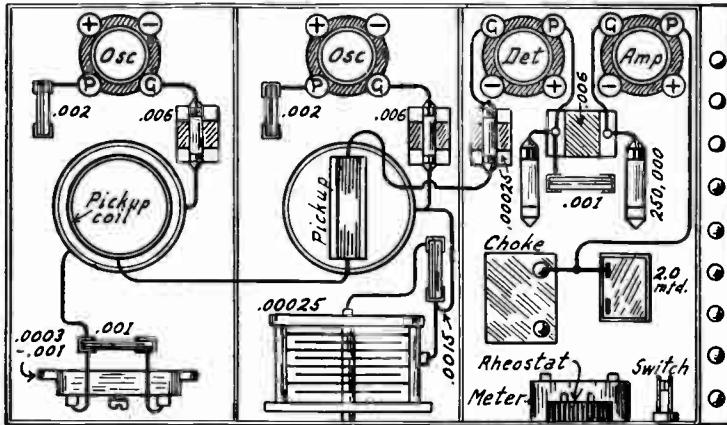

FIG. 6.—Layout for Beat Frequency Oscillator.

When the device is ready for operation the battery switch is closed and the rheostat adjusted so that the meter indicates 5.0 volts. The B-battery and C-battery voltages should be measured and thereafter maintained at the same values when the oscillator is used. With a loud speaker connected across the output terminals an audible note will be heard. The adjustable condenser for the first oscillator is then varied until a position is found at which a low setting (small capacity) of the tuning condenser for the second oscillator produces a low note in the speaker. Increasing the capacity of the tuning condenser for the second oscillator should then increase the frequency as this condenser's capacity is increased. The condenser for the first oscillator frequency will make it possible to secure the lowest note with the tuning condenser plates nearly out of mesh and for the note to gradually increase as this condenser's capacity is increased. The condenser for the first oscillator is to remain as adjusted and the oscillator may be calibrated for frequency by comparing the audible notes with the notes of a piano, another oscillator already calibrated, a series of tuning forks or similar means. With the same tubes always in use and with the filament and plate voltages at which

OSCILLATOR, AUDIO FREQUENCY

the oscillator is calibrated this instrument will maintain its accuracy and voltage for long periods of use.

Tuning Fork Oscillator.—An audio oscillator of fixed frequency utilizes a tuning fork set into vibration by magnetic action as illustrated in Fig. 7. A U-shaped fork is magnetized by the field coil connected to a battery. Battery current also flows through a microphone button, the metal of the tuning fork and the primary winding of the input transformer. Vibration of the fork alternately compresses and releases the carbon particles in the microphone button. The consequent change of resistance in the button varies the cur-

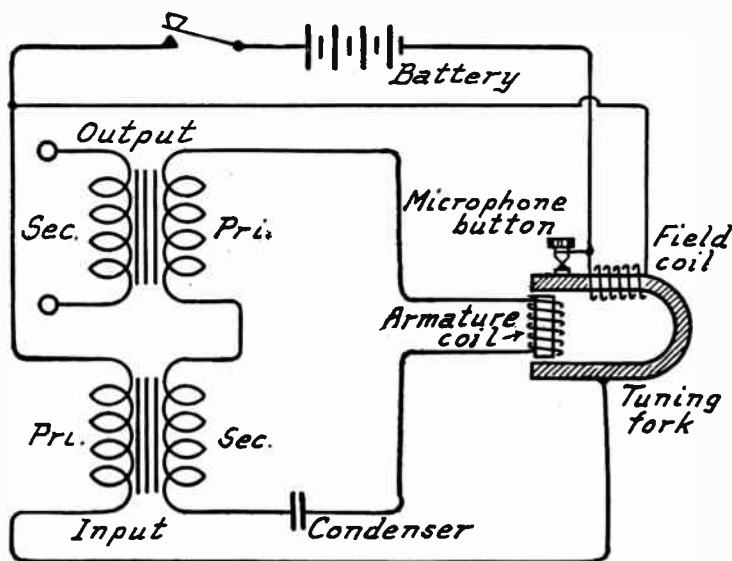

FIG. 7.—Tuning Fork Oscillator.

rent through the input transformer primary. A voltage is thus set up in the secondary of the input transformer and passes through the armature coil and the primary winding of the output transformer.

The alternating voltage and polarity of the armature causes it to attract and repel the tuning fork since the ends of the fork are the poles of a magnet produced by the field coil. Vibration of the fork at its natural frequency is maintained by this action. The circuit including the input transformer secondary, the output transformer primary and the armature coil is tuned to resonance at the fork's frequency by the condenser shown. The output of this oscillator is taken from the secondary terminals of the output transformer.

OSCILLATOR, AUDIO FREQUENCY, USES OF

OSCILLATOR, AUDIO FREQUENCY, USES OF.—The principal uses for the audio frequency oscillator are as follows:

To test the amplifying characteristics at various frequencies of audio frequency transformers, chokes, resistance couplers and all forms of combination couplings for use in the audio frequency stages of receivers.

For testing the tone reproducing qualities of all forms of loud speakers.

For testing the operation of complete audio frequency amplifiers and of devices for coupling loud speakers to power tubes.

For use as a source of sound with the bridge described under *Bridge, Measurements by*.

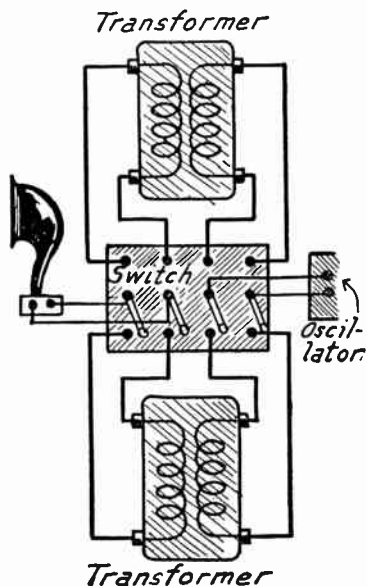

FIG. 1.—Comparative Test of Amplifying Transformers with Audio Oscillator.

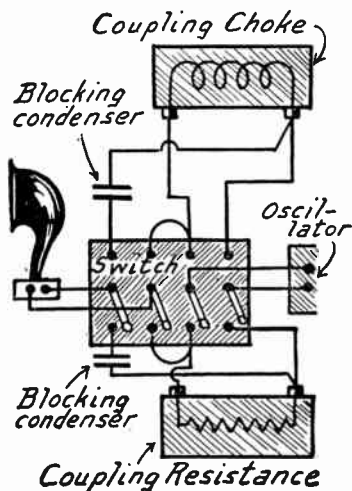

FIG. 2.—Comparative Test of Chokes or Resistances with Audio Oscillator.

For use with a pair of headphones in tracing open circuits and grounded circuits.

For modulating the output of a radio frequency oscillator with an audible note.

Testing Audio Frequency Transformers.—The connections for comparing two audio frequency amplifying transformers are shown in Fig. 1. A four-pole, double-throw switch is used with one transformer connected to one side and the other transformer connected to the other side of this switch. The oscillator is set to operate at the desired tone for the test and allowed to remain without

OSCILLATOR, AUDIO FREQUENCY, USES OF

change. Throwing the switch from one side to the other will operate the speaker through one of the transformers when on one side and the other transformer when on the other side. The results may be compared by the sound from the speaker as the switch is quickly changed from one position to the other.

Testing Choke Coil and Resistance Couplings.—Amplifying choke coils or resistances may be tested with the connections through the four-pole, double-throw switch shown in Fig. 2. The condenser should be of the same capacity as one ordinarily connected between the choke or resistance and the grid of the tube which would follow the coupling unit in a receiver. Since the operating principles of choke coil coupling and of resistance coupling are the same, the same connections are used for either type of unit.

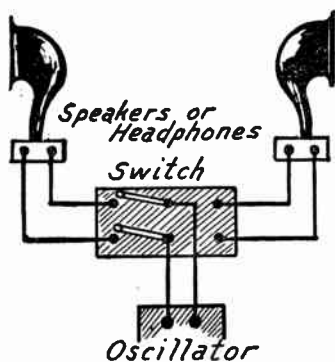

FIG. 3.—Comparison of Speakers or Headphones with Audio Oscillator.

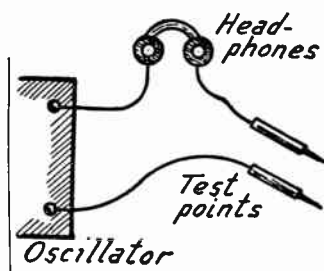

FIG. 4.—Using Audio Oscillator as a Circuit Tester.

It is possible to compare one method of coupling with a different method. A choke coil may be placed on one side and a resistance coupler on the other as in Fig. 2 or a transformer might be placed on one side with the connections of Fig. 1 while either a choke or resistance might be on the other side at the same time for a comparative test.

Testing Loud Speakers and Headphones.—For a comparative test of two loud speakers or two sets of headphones the connections of Fig. 3 are used. Here the switch is of the double-pole, double-throw type. One half of the switch used in Figs. 1 and 2 may be used in Fig. 3. Throwing the switch from one side to the other will first operate one speaker or headset then operate the other unit under identical conditions of power input.

Circuit Testing.—For testing circuits to locate points that are open, points of high resistance and accidental grounds the audio oscillator may be used with a pair of headphones and a pair of test points as shown in Fig. 4. The exact methods of procedure are described under *Trouble, Circuit*.

OSCILLATOR, AUDIO FREQUENCY, USES OF

Testing Complete Audio Amplifier.—The audio amplifying end of a receiver may be tested without operating the detector or the radio frequency amplifier. The method is shown by Fig. 5. The detector tube is removed from its socket and the B-battery or power unit is disconnected from the detector plate circuit terminal. This terminal is usually marked "B+Det" on the receiver. The output terminals of the audio oscillator are then connected to the plate terminal of the detector socket in the receiver and to either positive or negative filament terminal on the detector socket.

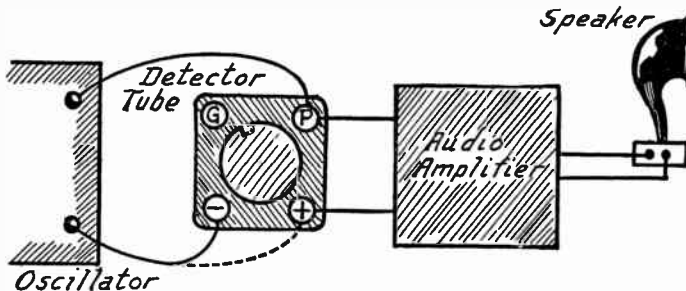

FIG. 5.—Testing Complete Audio Amplifier with Audio Oscillator.

With the audio frequency amplifying tubes in operation and a speaker connected to the receiver in the usual way, the tone of the audio oscillator may be changed to test the operation of the audio frequency amplifier at various frequencies.

Modulating Radio Frequency Oscillator.—The output of a radio frequency oscillator is not easily audible through a receiver unless its transmitted waves are modulated at an audio frequency. This may be done as shown in Fig. 6.

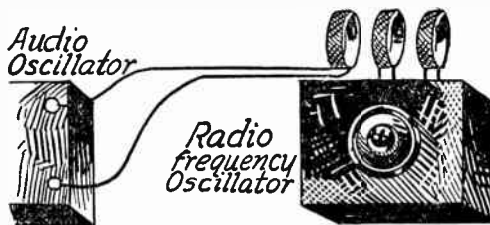

FIG. 6.—Modulating Radio Frequency Oscillator with Audio Oscillator.

To the two coils regularly found on the radio frequency oscillator a third coil is coupled by placing it in line with and close to the radio oscillator coils. This third coil is not directly connected with the radio oscillator but its two ends are attached to the output terminals of the audio frequency oscillator as shown.

OSCILLATOR, BUZZER TYPE

The output of the radio oscillator will then be a carrier wave having a frequency determined by the setting of the radio oscillator condenser, but this carrier will be modulated by the audio frequency note at which the audio oscillator is adjusted. This modulated carrier will be heard in any receiver which is close to the radio oscillator and which is tuned to the frequency of the carrier wave. The radio oscillator for this work is described under *Oscillator, Radio Frequency*.

OSCILLATOR, BUZZER TYPE.—The tuned circuit of a radio frequency oscillator may be operated by the interrupted impulses of current from a battery and a small high frequency buzzer, the circuit used being shown in Fig. 1. The layout of the apparatus is shown in Fig. 2.

If not already contained within the buzzer, a bypass condenser of about one-half microfarad capacity should be connected across the contacts as shown. This condenser will prevent excessive arcing at the contacts and will help to sharpen the tuning of the oscillator. It must be confessed that the tuning

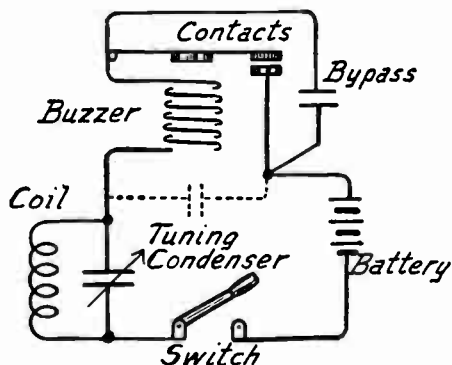

FIG. 1.—Circuits of Buzzer Type Oscillator.

of this type of oscillator is not any too sharp at its best. The condenser should be connected across the contacts as shown and not across the terminals of the buzzer as indicated by broken lines.

A variable tuning condenser is connected across the terminals of a tuning coil to form the oscillating circuit. The condenser is usually of the .001 microfarad capacity size, although any other available size may be used. The coil should be of a size which will tune over the broadcasting range with the condenser selected. Coil sizes are given under *Coil, Tuning, Sizes Required for*. The condenser should be mounted on a panel of dielectric material and fitted with a dial and pointer.

One terminal of the coil and condenser unit is connected to one terminal of the buzzer. A battery of one or two dry cells, just enough to operate the buzzer, is connected between the remaining terminal of the coil-condenser unit and the buzzer with a switch placed between the battery and the coil-condenser unit.

OSCILLATOR, BUZZER TYPE

When the switch is closed, battery current flows through the tuning coil and the buzzer magnet winding. The buzzer starts to operate and opens and closes the battery circuit at a high rate of speed. This sets the tuned circuit into oscillation at a frequency determined by the capacity setting of the tuning condenser and the inductance of the coil. Radio impulses or waves are now emitted by the tuning coil and they will affect any tuned circuit which may be brought into the field of the coil.

The frequency at which the buzzer excited oscillator is operating may be determined by coupling it to or bringing it near a frequency meter or wavemeter that is already calibrated. With the oscillator's tuning condenser set for any desired frequency as determined by the frequency meter, the oscillator may be used at this frequency for any of the work usually handled with radio frequency oscillators.

The buzzer excited type of oscillator may be classed as a modulated radio frequency oscillator because the high frequency radiations from the coil are modulated by the audio frequency impulses from the buzzer. Should an

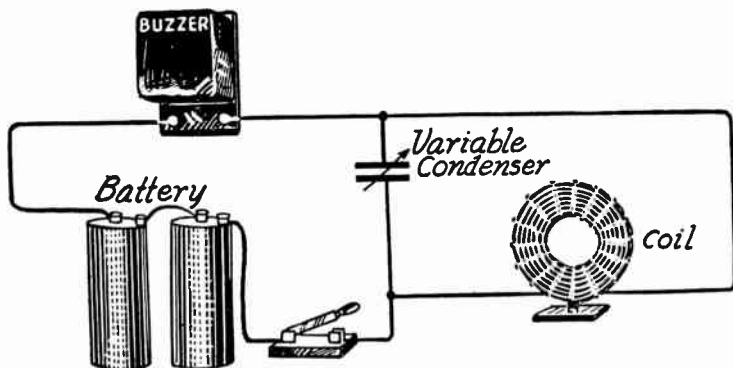

FIG. 2.—Layout of Buzzer Oscillator.

oscillator of this type be set up and its radiation be tuned in on a receiver, the modulated high frequency will be detected in the receiver and the sounds of the buzzer will be carried into headphones attached to the detector tube or will be amplified by an audio frequency amplifier in the receiver. The note of the buzzer may be changed by a screw adjustment.

Radiation from a buzzer excited oscillator may therefore be heard in a receiver even though the radiated waves from the buzzer are at radio frequency and not at audio frequency. In this respect the buzzer type of oscillator differs from the pure radio frequency oscillators. The radio frequency oscillators emit an unmodulated continuous wave at high frequency or radio frequency. Such a high frequency wave cannot be heard in a receiver unless it is used to produce beat notes or whistles by heterodyne action.

A buzzer type of oscillator may be used for any of the work done with a vacuum tube type of radio frequency oscillator. The buzzer type is somewhat simpler and is cheaper to build and operate than the vacuum tube type. It is not capable of the fine work and close regulation to a certain frequency that is possible with the vacuum tube type of audio frequency oscillator but for rough work it makes a satisfactory outfit. See also *Buzzer*.

OSCILLATOR, CRYSTAL CONTROLLED

OSCILLATOR, CRYSTAL CONTROLLED.—See *Crystal, Frequency Control* by.

OSCILLATOR, RADIO FREQUENCY.—The radio frequency oscillators shown under *Oscillator* are practical types, and devices built according to these circuits will operate satisfactorily. In order to obtain a greater current in the oscillating circuit, coupling much closer than shown in those diagrams is often used. Oscillator circuits which are generally adapted for use with low power tubes such as receiving tubes are shown in Figs. 1 and 2. Here the two coils, plate and grid, are joined together and from the junction a connection is made to the filament circuit of the tube, this connection forming both a grid return and a plate return for the tube.

In Fig. 1 the plate part of the double coil is included in the tuned circuit while in Fig. 2 the entire coil is shunted by the variable

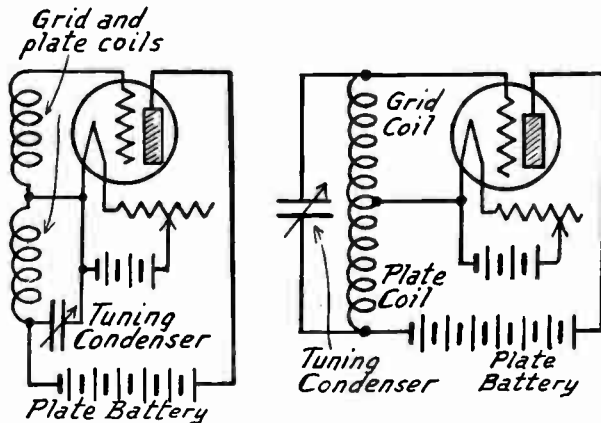

FIG. 1.—Radio Frequency Oscillator with Tuned Plate Coils. FIG. 2.—Radio Frequency Oscillator with One Condenser for Both Coils.

condenser and consequently is included in the tuned or oscillating circuit. The coupling, which is close enough to cause a strong current in the oscillating circuit, may cause a radiation which is too powerful to allow the oscillator's use close to a circuit to be tested. This is especially true when close coupling with coils of the oscillator would change the tuning of the circuit under test. Under such conditions the scheme shown in Fig. 3 may be used. Here a coil composed of a few turns of wire is closely coupled to the oscillator coil and is connected through long leads to another coil, also of a few turns, which may be coupled loosely or closely to the circuit being tested.

The oscillators shown in Figs. 1 and 2 may have their dial settings calibrated according to the frequency at which they are operating.

OSCILLATOR, RADIO FREQUENCY

This calibration is made by setting a frequency meter at any of the frequencies to which it is desired to calibrate the oscillator. The oscillator condenser is then varied until indication of resonance is secured on the frequency meter. The coupling between the oscillator and the frequency meter is then reduced by moving the two farther apart until it is just possible to obtain a sharp indication of resonance on the meter. The oscillator dial is then set at a point for the frequency shown by the meter. The same process is repeated for any desired number of points on the oscillator dial and a curve of the settings is prepared. See *Meters, Frequency, Calibrating Receivers and Circuits with*.

It is rather difficult to maintain the frequency calibration of an oscillator because it depends on a number of variables such as the internal capacities of the tube in use. If fairly close coupling is used, the operating frequency of the oscillator will be changed by the load applied. Change of coupling also changes the frequency. A reliable frequency meter should always be available for use with the oscillator and for this reason it is not really necessary to accurately calibrate the oscillator itself.

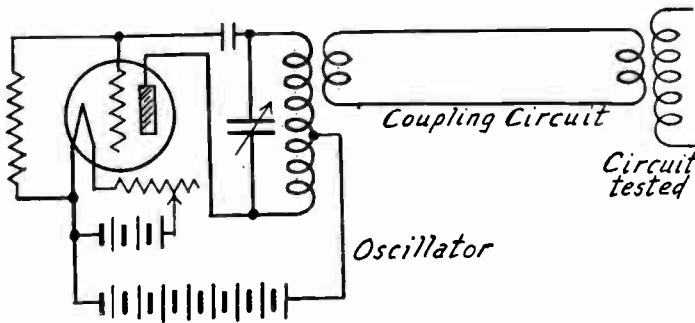

FIG. 3.—Link Circuit for Radio Oscillator Coupling.

Construction of Oscillator.—The circuit of a practical and easily constructed radio frequency oscillator is shown in Fig. 4. The layout of the parts and the connections of this oscillator are shown in Fig. 5.

The tuning condenser may be of any type, although values between .0005 and .001 microfarad capacity are generally used. The tube is equipped with a two-megohm grid leak and with a .00025 fixed condenser in its grid circuit. The terminals for the two coils should be on top of the cabinet and connected as shown. The inductance of these two coils taken together should be such that the condenser will tune over the broadcast range of frequencies. See *Coil, Tuning, Sizes Required for*. A jack is inserted in the plate circuit so that headphones may be connected when obtaining indications of resonance.

OSCILLATOR, RADIO FREQUENCY

The output or radiation from an unmodulated radio frequency oscillator is not audible in a receiver unless it is heard as a heterodyne whistle. When it is desired only to operate a frequency meter from the oscillator, it is unnecessary to modulate the output since the radio frequency energy sent out from the oscillator will produce an indication of resonance in the frequency meter.

A valuable addition to the radio frequency oscillator may be made by connecting a milliammeter in circuit between the positive terminal of the B-battery and the battery connection between the coils. This connection is indicated by the broken lines in Figs. 4 and 5. This ammeter should read from zero to thirty milliamperes because an ordinary amplifying tube of the quarter-ampere type will draw twenty-five milliamperes in its plate circuit while oscillating with ninety volts applied to the plate. Such a tube will draw five or six milliamperes when it is not oscillating. If the plate voltage

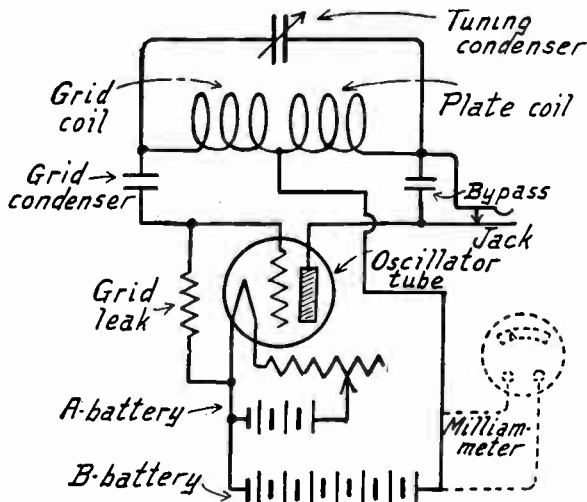

FIG. 4.—Circuits of Radio Frequency Oscillator.

is reduced to about twenty, the tube will draw around five milliamperes while oscillating and only one or two milliamperes when not oscillating. A dry-cell tube of the type using three volts on the filament will draw about three milliamperes when oscillating with twenty volts on the plate circuit.

It is possible to tell when the tube is oscillating by observing the reading of the milliammeter. When the oscillator is closely coupled to another circuit and is tuned to resonance with that circuit, the reading of the milliammeter will drop sharply when resonance has been reached and oscillation ceases.

A milliammeter reading from zero to one milliampere may be connected in the grid circuit of a tube if no grid condenser is used. The action of the grid milliammeter will be similar to that of the meter in the plate circuit when the tube grid is given a positive bias.

Any type of coil may be used with a radio frequency oscillator. Solenoid coils of few turns and large diameter are satisfactory and spiderweb types may be substituted with equal satisfaction. The oscillator may be made portable by using dry-cell tubes, either those requiring three volts or those requiring one and one-tenth volts for their filaments. More accurate work

OSCILLATOR, RADIO FREQUENCY

may be done if the box or cabinet containing the tuning condenser and the tube is completely shielded with the shield grounded to the negative side of the A-battery.

Operation of Radio Frequency Oscillator.—If no plate or grid milliammeter is fitted to the oscillator, it will be necessary to use other means for determining when the oscillating condition exists. With a receiver which is in operation a click or a heterodyne

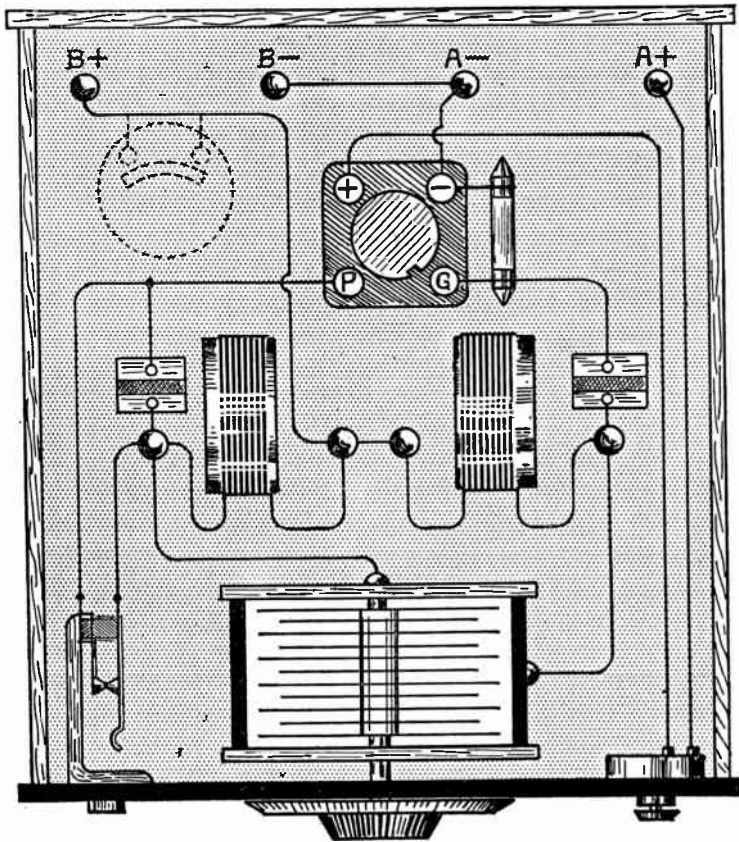

FIG. 5.—Layout and Plan of Radio Frequency Oscillator.

whistle is heard from the receiver if the tube is oscillating and the oscillator dial turned to the frequency of the receiver. Oscillation may be induced or encouraged by increasing the plate voltage on the oscillator tube or by using a closer coupling between the oscillator coils. Some tubes will oscillate more readily than others but it is generally found that any tube which will work in any socket of a receiver will oscillate freely at radio frequencies.

OSCILLATOR, RADIO FREQUENCY, USES OF

The rheostat should have twenty to thirty ohms resistance so that the filament voltage may be reduced below the point of oscillation in numerous tests made with the oscillator as a radiator of low power radio frequency energy. The jack is of the closed circuit type so that its circuit is complete when the phone plug is withdrawn. The phone bypass condenser of .002 microfarad capacity is necessary to prevent the high resistance of the headphone windings from being placed in the radio frequency plate circuit of the oscillator. This jack is not essential and may be omitted when the oscillator is used with a frequency meter having an audible or visible means of showing the resonant point. Modulation of the radio oscillator's output may be made through a coil or transformer connected in the plate circuit through the jack, or this modulation is easily obtained by using the audio frequency oscillator as a source of audible sounds.

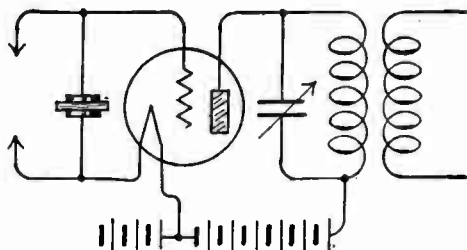

FIG. 6.—Principle of Crystal Control of Radio Oscillator Grid Circuit.

The radio frequency oscillator may be controlled by a quartz crystal which will maintain an absolutely constant frequency. This system is described under *Crystal, Frequency Control by*. The principle is illustrated in Fig. 6.

OSCILLATOR, RADIO FREQUENCY, USES OF.—In order to make full use of a radio frequency oscillator it is essential to have a frequency meter available. The frequency meter is used for setting the oscillator to operate at certain desired frequencies. For tests which require that the oscillator operate exactly at a certain frequency the meter is indispensable. For other tests requiring only that the oscillator operate at a relatively high or low frequency, without necessitating an exact setting, the oscillator may be set without the use of the frequency meter. For this latter work it is advisable to have the oscillator dial roughly calibrated to frequencies or wavelengths.

Calibrating Oscillator from Frequency Meter.—Place the oscillator and the frequency meter within six or eight inches of each other. Turn on the oscillator tube. Insert headphone in the jack of the frequency meter shown in Fig. 9 under *Meters, Frequency*. Set the frequency meter dial for the frequency to be transferred to the oscillator. Then rotate the oscillator dial while listening to the phones. A steady note will be heard at all settings of the oscillator dial except at one point where there is a sharp change in tone which indicates resonance between meter and oscillator. This setting of the oscillator corresponds in frequency to the setting of the meter.

Calibrating Oscillator with Frequency Meter and Receiver.—This is a much easier and more accurate method of obtaining a desired setting of the oscillator than the one just described.

OSCILLATOR, RADIO FREQUENCY, USES OF

Place the frequency meter and the oscillator within six or eight inches of each other and place both of them several feet from the receiver. Place the receiver in operation by turning on its switch. It is not necessary to have the receiver at any particular setting, just as long as it is in operation, and the receiver may itself be oscillating or not. Then set the frequency meter at the frequency to be transferred to the oscillator.

Next light the tube of the oscillator, turning the rheostat up to a point that causes squealing in the receiver. Turn the rheostat back to a point where the squealing stops. Now rotate the dial of the oscillator and it will be found that two clicks are heard from the receiver, either in a loud speaker or in headphones. Loosen the coupling between oscillator and meter by moving them farther apart and continue turning the oscillator dial to produce the two clicks. As the coupling is loosened the clicks will come closer together on the oscillator dial until they finally merge into one. This point of a single click or a point midway between the two is the setting of the oscillator which corresponds to the frequency setting of the meter.

This general method may be followed with the oscillator rheostat turned up to a point that produces a steady squeal from the receiver. As the oscillator dial is turned it will be found that the squeal stops between two points. Loosening the coupling between oscillator and meter will make this silent spot narrower on the oscillator dial. The middle of the silent spot on the oscillator dial denotes the frequency at which the meter is set.

Calibrating Frequency Meter with Oscillator.—This work requires the use of a broadcast receiver to pick up a carrier wave or signal of known frequency as a starting point. The oscillator and frequency meter are placed near together and both are kept at a distance of six or eight feet from the receiver.

The receiver is placed in operation and a broadcasting station of known frequency or wavelength is carefully tuned in, making all settings on the receiver dials as accurately as possible. The oscillator is then turned to produce a heterodyne whistle in the receiver and a setting of the oscillator dial is found which produces zero beat in the receiver. The reception of the broadcasting station will be very badly distorted by the oscillator, which is now tuned to the frequency coming in on the receiver. If the oscillator itself is being calibrated, the point of zero beat on its dial is the setting for this particular frequency.

Leaving the oscillator and receiver settings alone, the frequency meter is now carefully tuned to the oscillator. That is, the frequency meter dial is turned to a point that gives maximum indication of resonance with the oscillator. If the meter, shown in Fig. 9 under *Meters, Frequency*, is used, this point will be determined by headphones in the frequency meter circuit. It is advisable to very carefully retune the receiver and oscillator for zero beat and again check the frequency meter setting for resonance indication. The final setting of the frequency meter is at the received frequency.

OSCILLATOR, RADIO FREQUENCY, USES OF

Several frequencies or wavelengths are thus brought in on the receiver and each one is transferred to the oscillator and then to the frequency meter as described. A note of each setting of the meter dial is made and these settings form the basis for plotting a curve showing the relation between dial settings and either frequencies or wavelengths for the meter.

Determining Frequency of Incoming Signal.—If the frequency meter is already calibrated, it is possible to determine the frequency or wavelength of a signal being heard on a receiver. The accuracy of frequency meters in common use is not better than five per cent, although some carefully built and carefully calibrated meters may vary not more than two per cent from correct readings. Therefore it should not be assumed that a broadcasting station is not operating at its correct frequency simply because a frequency meter shows a variation from the station's assignment. The principal use of frequency meters is not for determining the frequency at which broadcasting stations are operating but for setting the radio frequency oscillator and for measuring frequencies of operation in resonant circuits of receivers and various radio accessories.

To determine the frequency of an incoming signal the method is exactly like that just described for calibrating the oscillator up to the point of setting the frequency meter. The meter is set in resonance with the receiver and oscillator and the setting of the meter dial is translated into wavelength or frequency from the previously prepared curve. This is the signal frequency.

Logging or Calibrating Receiver with Oscillator.—If either a completely calibrated oscillator, or an uncalibrated oscillator together with a frequency meter, is available it is possible to make a complete calibration or log of settings for the controls of a receiver. These settings will be within two or three per cent of those which will later tune in broadcasting stations at the various frequencies or wavelengths when the receiver is placed in operation. The calibration, however, is made without listening to any stations.

The receiver is placed in operation by turning on the necessary switches. The tube of the oscillator is lighted and the rheostat of the oscillator turned just below the point at which squeals are caused in the receiver. The oscillator dial is then turned to the various points which correspond to the frequencies of broadcasting stations to be heard on the receiver. If the oscillator is not calibrated, it will be necessary to employ a frequency meter for this work. The calibration of the oscillator with the help of a frequency meter has already been described.

With the oscillator operating at one of the desired frequencies the receiver controls are moved until a whistle from the oscillator is heard from the loud speaker or headphones of the receiver. The receiver controls are then brought to the position at which the receiver will tune in a station operating at the frequency in use on the oscillator.

Adjusting Regeneration Control of Receiver.—With the help of the radio frequency oscillator the regeneration control of any receiver may be adjusted to prevent oscillations and squeals from the receiver at all settings. It should be remembered that regeneration controls are called by various names, among the more common being volume control.

OSCILLATOR, RADIO FREQUENCY, USES OF

The oscillator should be located ten to twenty feet away from the receiver. The oscillator is first set at a low frequency or high wavelength and the receiver is tuned so that the oscillator is heard as a whistle or heterodyne. The oscillator rheostat is then turned down to a point just below that at which the whistle is no longer heard in the receiver. The receiver is again tuned to get the oscillator note clearly and without a heterodyne whistle. Under these conditions the regeneration control of the receiver should be able to bring about receiver oscillations (squeals) or should prevent oscillation so that only the clear note is heard.

It is next in order to set the oscillator at a high frequency or low wavelength. The receiver is again tuned until the heterodyne whistle is heard, following which the oscillator rheostat is turned down just enough so this whistle disappears. With the receiver tuned to the oscillator's frequency, the regeneration control should again be able to start or stop oscillation in the receiver circuits.

In making these tests do not set the oscillator at the frequency of a nearby broadcasting station which is in operation because the carrier from the broadcasting station and the carrier from the oscillator will heterodyne with each other and produce an uncontrollable whistle from the receiver.

Balancing Radio Frequency Circuits in Receiver.—The balancing condensers of Neutrodyne or other receivers using a capacitive feedback to balance the tube capacity may be adjusted at all broadcast frequencies with the help of a radio frequency oscillator, avoiding the necessity of waiting to receive broadcasters.

The oscillator is located twenty feet or more from the receiver to be adjusted. The oscillator is set at a low frequency, the receiver is tuned to the heterodyne whistle from the oscillator, and the oscillator rheostat is then turned just low enough to prevent this whistle in the receiver.

The clear note from the oscillator should still be heard from the receiver. While this note is coming through the receiver, the balancing condensers are adjusted according to the usual methods. These methods are explained under *Balancing*. The work is done by leaving the radio frequency tubes in their sockets with current shut off from their filaments while the balancing condensers are set to eliminate the signal.

Comparing High Frequency Impedances of Coils and Condensers.—This work is done by placing the condensers or the coils to be compared in a link circuit between the radio frequency oscillator and a frequency meter of the type shown in Fig. 9 under *Meters, Frequency*.

The radio frequency oscillator is provided with an additional coil as shown in Fig. 1. This coil is now to be used as a pick-up coil in the link circuit. The link circuit is coupled to the frequency meter by winding three or four turns of insulated wire around the same coil form that supports the frequency meter coil. There is no connection between the additional turns of wire placed on the frequency meter coil form and the internal circuits of the meter except through the inductive coupling of the coils. The oscillator and the frequency meter should be placed far enough apart so that no indication of resonance can be obtained on the meter without the link circuit in

OSCILLATOR, RADIO FREQUENCY, USES OF

operation; that is, there should be no direct pick-up of energy from the oscillator by the frequency meter.

The pick-up coil at the oscillator may be of ten to twenty turns on a form having the same diameter as the regular oscillator coils. The pick-up coil on the oscillator and the small coupling coil of a few turns on the meter are connected as shown in Fig. 1. The meter is then tuned to resonance with the oscillator. Tests may be made at both high and low frequencies. A condenser to be tested is connected across the link circuit, in parallel with its coils. The greater the impedance of the condenser, the less effect it will have on the resonance indication in the frequency meter. If the condenser is leaky, it will form a bypass for part of the energy from the oscillator and the indication in the meter will be less pronounced than with another condenser having lower leakage losses.

Condensers being thus compared should be of equal capacity because a larger capacity will naturally offer less impedance than one of small capacity. If variable condensers are being tested with their plates partly out of mesh, both condensers under test should be set at the same capacity.

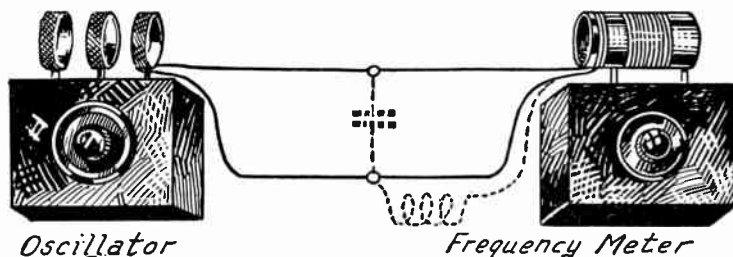

FIG. 1.—Comparing Impedances of Coils, and Condensers with Radio Oscillator.

Coils whose relative impedances are to be tested are connected in series with either side of the link circuit, this connection being indicated by the broken lines in Fig. 1. The greater the impedance of the coil placed in the link circuit, the less pronounced will be the indication of resonance in the frequency meter. The lowest possible impedance would be a straight conductor, while a very high impedance would be offered by an iron-core coil with many turns in its winding.

By substituting different condensers, either fixed or variable, and different coils in the position shown in Fig. 1 the resonance indication in the frequency meter will be a rough measure of the relative impedance in the units being tested.

Matching Coils for Inductance.—When building a receiver it is generally necessary to obtain two or more tuning coils whose inductances are alike. By using a radio frequency oscillator and a frequency meter connected through a link circuit as in Fig. 1 the inductance of different coils may be indicated by settings of the frequency meter dial. The principle of this test is shown in Fig. 2.

OSCILLATOR, RADIO FREQUENCY, USES OF

The oscillator and frequency meter are again placed far enough apart so that there is no pick-up of energy in the meter except through the link circuit. One of the coils to be tested is connected across the terminals of the frequency meter condenser without disturbing the connection of the meter coil to this condenser. The coil to be tested and the regular coil of the frequency meter are now in parallel across the condenser. The inductance of the two together is therefore less than the inductance of either one taken alone.

The frequency meter dial is now set near the center of its scale, at fifty when the scale has a total of one hundred divisions. The oscillator dial is turned until the frequency meter gives a resonance indication. Leaving the oscillator at this setting, the frequency meter dial is carefully adjusted for resonance. A note of the frequency meter dial setting should then be made.

The coil just tested is disconnected and another one put in its place.

The setting of the oscillator is not to be changed. With the new coil in place the frequency meter dial is turned until a maximum resonance indication is once more obtained. If this indication comes at exactly the same point on the meter dial as with the first coil tested, the two coils are exactly alike in inductance and also in distributed capacity. If the frequency meter reading is higher for the second coil, this coil has less inductance than the first one tested; if the meter reading is lower, the second coil has more inductance.

Some coils have much more distributed capacity than others, even though their inductance at a certain frequency may be the same. When two coils have been matched at one setting of the oscillator it is advisable to use a new

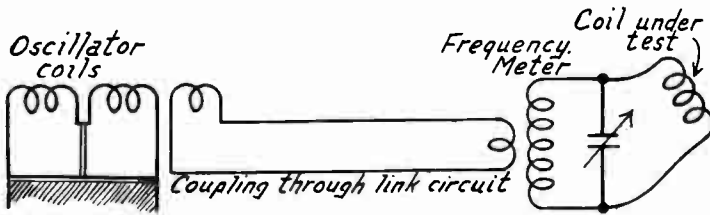

FIG. 2.—Measuring Distributed Capacity of Coil with Radio Oscillator.

oscillator adjustment for a second test so that it may be learned whether the two coils will tune evenly over the broadcast range of frequencies. The two coils may be matched for inductance by removing wire from the coil which has the greater inductance in the first place. This test is of value when building single control receivers.

Matching Fixed Condensers for Capacity.—There is an astonishing variation between the actual capacities of fixed condensers and their nominal capacities. Poorly constructed condensers and those which are readily affected by moisture and weather conditions may vary by as much as fifty per cent from their rated capacity. A large number of high grade, well built and well protected fixed condensers may be tested and the extreme variation between the lot will often be less than ten per cent. Therefore, it is desirable to pick condensers of the same actual capacity, especially when they are used as tuning condensers with variable inductances.

The method of comparing condenser capacities is shown in Fig. 3. The radio frequency oscillator and the frequency meter are coupled through a link circuit as shown in Figs. 1 and 2. The fixed condenser to be tested is connected across the terminals of the variable condenser in the frequency meter so that the two con-

OSCILLATOR, RADIO FREQUENCY, USES OF

densers, fixed and variable, are in parallel and add their capacities together.

The frequency meter condenser is set at the middle of its dial scale and the oscillator is adjusted to produce a maximum indication of resonance with the meter in this position. The oscillator is allowed to remain at this setting until the test is completed.

Since the two condensers in parallel as shown in Fig. 3 form a rather large capacity, it is quite possible that the resonant frequency of the meter will be too low when using all the frequency meter coil. Either of the schemes shown in Fig. 4 may be used. The frequency meter coil may be tapped so that only a part of its winding is used. The easier method is to place an additional fixed condenser in series with the condenser under test. This extra condenser will reduce the capacity of the part formed by itself and the condenser under test so that the total capacity across the frequency meter coil will allow tuning within the range of the oscillator. The extra condenser should have a capacity about equal to that of the frequency meter variable condenser.

With the condenser to be tested inserted in the frequency meter circuit by any of the methods indicated in Figs. 3 and 4 the frequency meter dial is

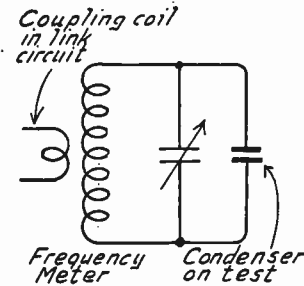

FIG. 3.—Matching Fixed Condensers with Radio Oscillator.

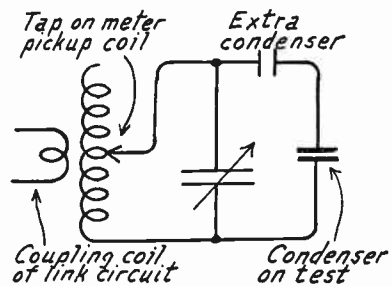

FIG. 4.—Variations of Test for Matching Condensers with Radio Oscillator.

carefully adjusted for maximum resonance. The first condenser being tested is then removed from the circuit and another one inserted in its place. The frequency meter dial is again adjusted for resonance. If the dial reading is higher for the second condenser, it indicates that this second condenser has less capacity than the first one tested. If the dial reading is lower, it indicates that the second condenser has more capacity than the first one. A series of eight high grade fixed condensers tested according to this method gave the following readings on the frequency meter dials: 44, 45, 49, 51, 52, 56, 59, 61.

Measurement of Distributed Capacity.—The distributed capacity of a coil may be measured as shown in Fig. 5. Make a circuit including the coil to be tested and a high grade condenser calibrated according to capacity. The coil should be loosely coupled to the oscillator. Adjust the oscillator to a low frequency, selecting one which may be exactly doubled. Set the condenser connected to the coil so that resonance is obtained and make a note of the capacity in micro-microfarads. The resonance indication may be obtained from a milliammeter in the coil and condenser circuit or by the use of a frequency meter.

OSCILLATOR COUPLER

Now set the oscillator at exactly twice the first frequency. For instance, if the first frequency was 560 kilocycles, change to a frequency of 1120 kilocycles. If the first setting was at a frequency of 600 kilocycles, make the second one at 1200 kilocycles. Make a note of the capacity now being used on the condenser connected to the coil.

The distributed capacity of the coil may now be found by multiplying the second reading on the attached condenser by four and subtracting this product from the first capacity read on the condenser. Divide the number thus secured by three which will give the approximate distributed capacity of the coil in micro-microfarads.

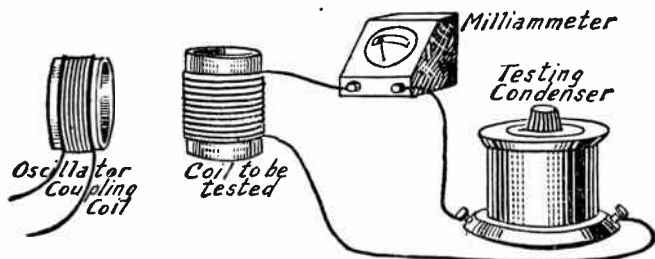

FIG. 5.—Measuring Distributed Capacity of Coil with Radio Oscillator.

As an example, supposing the first setting to be 600 kilocycles with a capacity of 200 micro-microfarads on the condenser and the second setting to be at 1200 kilocycles with 45 micro-microfarads on the condenser. Multiply 45 by 4, obtaining 180, and subtract this from the first reading, 200, leaving 20. Divide 20 by 3, giving 6.66, which is the distributed capacity of the coil in micro-microfarads.

The calculation of distributed capacity is expressed in the following formula:

$$C = \frac{X - (4 \times Y)}{3}$$

in which C is the distributed capacity of the coil in micro-microfarads, X is the capacity in micro-microfarads required with the lower frequency, Y is the capacity in micro-microfarads required for the higher frequency.

OSCILLATOR COUPLER.—See *Receiver, Superheterodyne*.

OSCILLATOR TUBE.—Any vacuum tube used for the production of oscillating currents either at radio frequency, at audio frequency or at an intermediate frequency is called an oscillator tube. One of the tubes in a superheterodyne receiver is an oscillator tube.

OSCILLATORY CIRCUIT.—See *Circuit, Oscillatory*.

OSCILLOGRAPH.—An oscillograph is a device which makes a pictorial or visible record of the changes in current or voltage in an electric circuit. This record may be impressed upon a photographic film or may simply be observed upon a piece of ground glass or in mirrors.

OUTDOOR ANTENNA

One type of oscillograph operates by means of a beam of light reflected from a mirror, the mirror being moved by fluctuations of current or voltage in a circuit. Other types of oscillograph make use of special forms of vacuum tubes giving a direct indication of changes in a circuit connected to the tube. Oscillograph records may be made of currents at the highest frequencies and the behavior of these currents may be studied from the oscillograph indication.

OUTDOOR ANTENNA.—See *Antenna*.

OUTPUT CIRCUIT.—See *Circuit, Output and Input*.

OUTPUT IMPEDANCE.—See *Tube, Output Resistance and Impedance of*.

OUTPUT TRANSFORMER.—See *Transformer, Output*.

OXIDE COATED FILAMENT.—See *Tube, Filament Materials for*.

P

p.—The symbol for power (instantaneous value) in watts.

P.—The symbol for electrical power (average value) measured in watts. See *Watt*.

PAD.—A pad is a network or connection of resistors placed between two circuits or two parts of a circuit for the purpose of reducing the amount of energy transferred from one to the other. The pad, also called an attenuation network, generally includes resistors in series with and others in parallel with the two sides of a circuit.

PANCAKE COIL.—See *Coil, Spiderweb Type*.

PANEL.—The part of a radio receiver on which are carried the controls for tuning, for volume, for selectivity, etc., also any necessary switches. The panel is usually vertical or slightly inclined, forming the front of the receiver. It may also be in a horizontal position. The control panel is often called the front panel or main panel. Panels are made either of dielectric material or of sheet metal.

Sub-panels are supplementary panels or shelves inside the receiver, generally behind the main panel and approximately at right angles to it. Sub-panels carry tube sockets, coil mountings, audio frequency amplifying apparatus, resistances, etc.

PANEL, DRILLING.—See *Drilling*.

PANEL, GRAINING.—See *Graining, Panel*.

PANEL, MATERIALS FOR.—The most generally used materials for panel work are those of the phenol base class which includes Formica, Bakelite, Celoron, etc. From the mechanical standpoint all of these are excellent since they are unchanged by weather and temperature and have practically no tendency to warp or bend even when rather heavily loaded. These materials are made in various finishes and colors, many of which imitate the graining of fine woods. All instruments may safely be mounted directly on panels of these materials since they have high resistance, both surface and volume, and they have reasonably low power losses.

Hard rubber has been used rather extensively for panels, but due to its tendency to bend under strain and to compress underneath screw heads and other fastenings it is not so desirable as the phenol base class from the standpoint of mechanical permanence. From the standpoint of electrical losses of all kinds, hard rubber is even better than the phenol products.

If hard rubber is exposed to strong sunlight for considerable periods of time, it may lose its fine deep black lustre and take on a grayish or brownish hue. This is caused by the sulphur used in manufacture. This surface layer is of much lower resistance than the original form of the rubber and considerable surface leakage may take place. If hard rubber is used for paneling, only the very best grades should be considered at all.

PANEL SHIELDING

At rather frequent intervals there appear on the market cheap imitations of hard rubber and of phenol base insulators. As a general rule these imitations have such low resistivity and such great leakage and other high frequency losses that they ruin the operation of a receiver which might otherwise be satisfactory. Experimenting with them is poor economy.

Various kinds of hard woods, treated to make them proof against moisture, dirt, dust and weather temperature changes, have been found satisfactory as panel materials aside from a tendency to warp. In some of these woods the original beauty of their grain is well brought out. Panels may be made from hard maple or white oak. The wood is first formed and drilled with all necessary holes, after which it is treated with hot paraffin and beeswax mixtures.

The advantages gained by shielding make it logical to employ sheet metal panels of aluminum, hard copper or brass. Any parts which are electrically alive must be well insulated from metal panels with washers and bushings of good insulating properties. Fibre and paper washers are not satisfactory. The panel is grounded to the low voltage side of the filament circuit and thus forms an effective shield. Coils should be kept well away from metal panels because of eddy current losses.

PANEL SHIELDING.—See *Shielding*.

PAPER.—Used as an insulator, paper has the disadvantage of a liking for moisture, which it retains unless especially dried and treated with oils and waxes. Dry paper is an excellent insulator, withstanding from 100 to 250 volts per thousandth of an inch thickness. Moist paper is a conductor, though a poor one. The dielectric constant of insulating paper before treatment is between 1.6 and 2.5.

Paper that has been treated with oils or paraffin wax has its dielectric strength raised to between 400 and 600 volts per thousandth of an inch thickness and its dielectric constant ranges from 2.0 to 3.2.

PAPER CONDENSER.—See *Condenser, Fixed*.

PARAFFIN WAX.—See *Waxes, Insulating*.

PARALLEL CAPACITIES.—See *Condenser, Capacity of*.

PARALLEL CIRCUIT.—See *Circuit, Parallel*.

PARALLEL FEED AMPLIFIER.—See *Amplifier, Audio Frequency, Transformer Coupled*.

PARALLEL INDUCTANCES.—See *Inductance, Self-*.

PARALLEL RESONANCE.—See *Resonance, Parallel*.

PARALLEL-SERIES.—A circuit in which two or more parts are connected together in parallel to form parallel circuits and in which these circuits are then connected together in series so that both methods of connection appear.

PARALLEL-SERIES SWITCH.—See *Switch, Series-Parallel*.

PARALLEL TUBE OPERATION.—See *Tube, Parallel Operation of*.

PARAMAGNETIC.—Having the ability to become a magnet. Iron and steel are strongly paramagnetic. Nickel and cobalt have this property to a lesser degree.

P. D.—An abbreviation for potential difference. See *Potential, Difference of*.

PEAK VOLTMETER

PEAK VOLTMETER.—See *Meter, Vacuum Tube.*

PEAKED TRANSFORMER.—See *Transformer, Audio Frequency.*

PEANUT TUBE.—See *Tube, Peanut Type.*

PELTIER EFFECT.—The change of temperature which occurs at a joint between two dissimilar metals when there is a flow of electric current through the joint. The reverse effect is used in producing *Thermo-electricity*, which see.

PERIOD.—The time which is required to complete any action. The period of an alternating current is the time required for the current to pass through one complete cycle. Periods are expressed in fractions or multiples of a second. Thus, the period of a current whose frequency is 500 per second, would be $1/500$ second.

PERMALLOY.—An alloy consisting of iron and nickel in various proportions, having a magnetic permeability which is high in comparison with ordinary kinds of iron and steel. The proportion of nickel is between forty per cent and eighty-five per cent, the remainder being iron.

The chief use of permalloy for radio work is in the cores of audio frequency transformers and in coils where high inductance is an advantage. Since inductance increases directly with increase of permeability, the use of permalloy allows more inductance with a given size of core or the same inductance with a smaller core.

The permeability of this alloy with about forty-five per cent nickel is in the neighborhood of 2,500 which is five to six times the permeability of silicon steel in the grades generally used for transformers. Still greater percentages of nickel produce a still greater degree of permeability until a maximum point is reached with slightly less than eighty per cent nickel.

Very careful heat treatment and the addition of small amounts of certain other metals will allow permeabilities as high as 100,000. When the metal has been thus conditioned it must be handled carefully because mechanical shock will destroy the effect of the heat treatment and lower the permeability. These alloys suffer saturation with comparatively small currents and there is little advantage in their use unless the magnetizing forces are small.

The effect of continuous or direct current through windings on permalloy cores is very pronounced. It takes but a small amount of such current to produce saturation with consequent failure to give desired results. To avoid such trouble it is customary to use parallel feed circuits for audio amplifiers which include permalloy core transformers.

PERMEABILITY.—A measure of the ease with which any material, usually iron, carries electromagnetic lines of force or flux. Permeability in magnetism is similar to conductivity in considering electric currents. The permeability of a material is the ratio of the number of lines of force it carries with a certain magnetomotive force or certain number of ampere-turns to the number of lines carried by air with the same magnetomotive force in effect.

The permeability of the iron or steel used in transformers may be 500 or even higher, that is, this iron will carry four thousand or more times the

PERMITTANCE

number of magnetic lines of force that would be carried by air under the same conditions.

See also *Iron and Steel*.

PERMITTANCE.—The capacity of a condenser is called the condenser's permittance.

PETROLEUM OIL.—See *Oils, Insulating*.

PHASE.—A fraction representing the portion of a cycle through which an alternating current has progressed since passing through a zero position.

Phase is measured in electrical degrees, of which a full cycle contains 360 and an alternation 180. Phase may be measured in the number of electrical degrees that a wave has progressed from zero. Two waves which start from zero at the same time, rise together and reach maximum at the same time, then fall together to

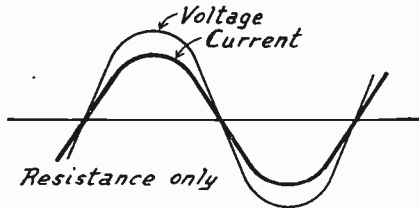

FIG. 1.—Current and Voltage in Phase.

zero are said to be in phase with each other. If the maximum points do not come together in time or electrical degrees, the two waves are said to be out of phase.

Phase relations between voltage and current are generally shown by curves which represent the rise and fall of both values. When one value passes through the maximum point after the other, it is said to lag; and if it passes through maximum first, it is said to lead. If the current passes through

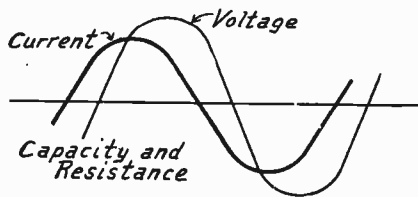

FIG. 2.—Current Leading Voltage.

maximum before the voltage passes through maximum, it is said to be a leading current and if it passes through maximum after the voltage has done so, it is said to be a lagging current.

If a circuit contains resistance only, no inductance and no capacity, the current that is caused to flow will be in phase with the voltage that causes the flow as in Fig. 1.

If the circuit has capacity in series with the resistance, but no inductance, the current leads the voltage impressed on the circuit as in Fig. 2.

PHASE ANGLE, DIFFERENCE OF

If the circuit has inductance in series with its resistance, but no capacity, the current lags behind the voltage as in Fig. 3.

If the circuit has inductance, capacity and resistance, all in series, the current may either lead, lag or be in phase. Which condition actually exists depends on the relative values of inductance and capacity in the circuit. If the inductive reactance is greater than the capacitive reactance, the total re-

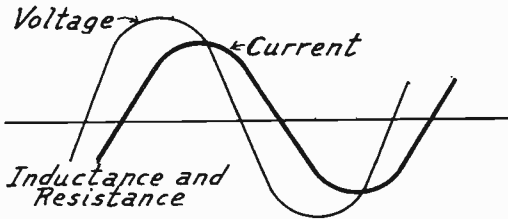

FIG. 3.—Current Lagging Behind Voltage.

actance is said to be positive and the current lags. If the capacitive reactance is the greater of the two, the total reactance is negative and the current leads the voltage. When the two reactances balance each other, only the effect of the resistance remains and the current and voltage are in phase. This last is the condition of resonance.

PHASE ANGLE, DIFFERENCE OF.—See *Condenser, Losses in.*

PHASE, RELATIONS IN TRANSFORMER.—In a transformer having its coils or windings magnetically coupled the phase relations are as follows:

The voltage in the secondary winding is opposite in phase or is 180 degrees out of phase with the voltage in the primary winding. As the primary voltage rises from zero to its positive maximum value the secondary voltage is falling from zero to its negative maximum value. This is true in both iron-core and air-core transformers.

Therefore, when two tubes are coupled through a transformer the grid voltage of the secondary circuit will be opposite in polarity to the plate voltage in the primary circuit. As the primary voltage is becoming more strongly positive, the secondary voltage is becoming more strongly negative, and when the primary or plate voltage has arrived at its maximum positive value, the secondary or grid voltage for the following tube has reached its maximum negative value.

On the page following are shown three curves indicating the phase relations between primary current, primary voltage and secondary voltage in a transformer.

PHASE, RELATIONS IN TUBE.—The relations between rise and fall of grid voltage, plate current and plate voltage in a vacuum tube are as follows:

As the grid voltage rises the plate current rises with it, the grid voltage and plate current being in phase. A fall of grid voltage

PHENOL COMPOUNDS

is accompanied by a corresponding fall of plate current. This is shown in the curves.

The plate circuit voltage and plate current are 180 degrees out of phase with each other. As the plate current rises the voltage in the plate circuit falls proportionately and as the plate current decreases the plate voltage rises.

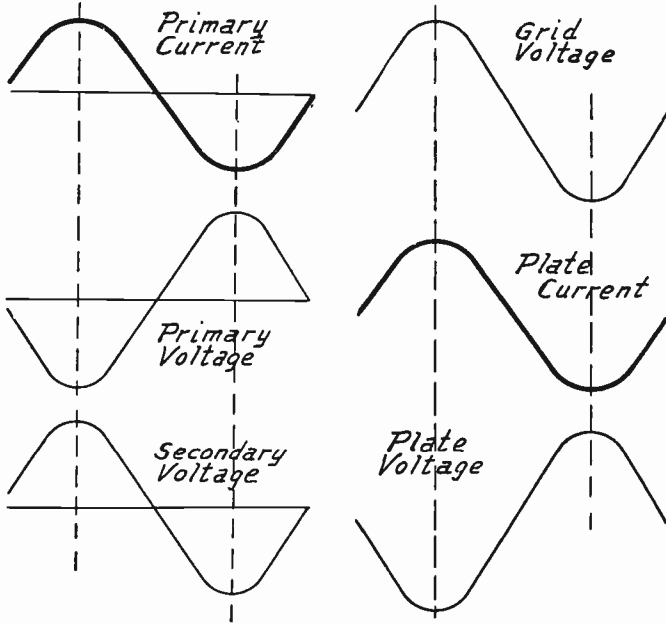

Phase Relations in Transformer.

Phase Relations in a Tube.

From the foregoing it may be seen that the grid voltage and plate voltage are 180 degrees out of phase with each other. The grid voltage and plate current are in phase, but the plate voltage is out of phase with the plate current; therefore, the grid voltage and plate voltage pass through opposite polarities at any one time.

All of these relations between voltage and current in grid and plate hold true for any circuits connected to the grid and plate of the tube being considered.

PHENOL COMPOUNDS.—Much of the insulation used in radio work is of the phenol compound type. This class includes Bakelite, Formica, Condensite, Celoron, Micarta, Redmanol, Phenolite, etc. All are products of phenol and formaldehyde. Phenol has a characteristic odor like carbolic acid or creosote. It is secured from the distillation of substances such as coal, wood and organic materials of various kinds. Under the action of heat the phenol and formaldehyde form a kind of resin which, at this stage, may be dissolved with acetone or alcohol to form a varnish.

PHENOLITE

The resin may be further treated with heat and pressure in moulds to form moulded insulation parts of almost any desired shape. Metal parts may be inserted into the mould and will be mounted securely in the finished articles. Filling materials such as asbestos, mica and wood flour are added to the resin before moulding and any desired color may be had from dyes. The powder which results from the mixing is placed in the moulds and pressure of about one ton per square inch is used together with about 350 degrees of heat. A few minutes of this treatment causes the final chemical changes with result in a strong, solid piece of insulating material.

Laminated types of insulation are made by applying a phenol binder to sheets of paper, fibre, canvas and asbestos which are built up into panels or slabs of the desired thickness. The binder is the varnish formed by dissolving the resin with alcohol or acetone. After the sheets which form the base are impregnated with the varnish they are subjected to heat and pressure. This drives off the solvents and completes the chemical changes which end with a solid laminated piece of insulation.

Among the principal advantages of the phenol compounds are uniformity of the products, exceedingly high resistivity, good appearance, mechanical strength and durability, and resistance to the effects of heat, moisture and acids to a satisfactory degree. A test on a laminated panel three-eighths inch thick showed no permanent set or distortion under a four hundred pound load applied for twenty-four hours between supports twenty-two inches apart. The panel used was eighteen by twenty-four inches. No such strain is ever imposed in receiver construction.

All of the phenol compounds may be cut, turned, drilled and threaded satisfactorily with ordinary machine tools. These materials dull the tools more quickly than mild steels.

The phase angle difference of phenol compounds ranges between one and one-half and four degrees. This is considerably greater than the phase angle of hard rubber which averages around one-half of one degree. The dielectric constants of moulded phenol compounds run from 5.0 to 7.5 while the constants of the laminated materials run from 4.5 to 6.0. The dielectric strength in volts per thousandth of an inch runs between 650 and 1200 volts for the laminated materials and between 225 and 1000 volts for the moulded types. The electrical losses increase slightly with increase of frequency and the resistivity decreases with increase of frequency.

None of the phenol compounds are readily inflammable and they will withstand continuously a temperature of 300 degrees Fahrenheit. Long continued heating at high temperatures tends to drive off some of the remaining volatile substances and when cooled the material may shrink with danger of splitting.

PHENOLITE.—See *Phenol Compounds*.

PHONE, HEAD.—A headphone is a device which changes rise and fall of current in a circuit into sound waves. The ordinary headphone is very similar in construction to the receiver of a telephone. Each headphone unit consists of an electromagnet near the poles of which a diaphragm of thin and flexible metal is placed. There is a minute air gap between the end of the magnet core and the surface of the diaphragm and the magnetic attraction of the electromagnet acts through this gap to move the diaphragm in pro-

PHONE, HEAD

portion to the strength of currents flowing through the magnet winding. This movement of the diaphragm produces sound waves.

The electromagnet is composed of a permanent magnet with soft iron pole pieces carrying windings of very fine wire, enamelled or silk covered. The magnet is carried in a cylindrical case of metal or of insulating material. The diaphragm is a circular piece of thin metal and it fits over the rim of the case so that its surface is held just the right distance from the pole pieces of the magnet. The diaphragm is locked in place by the rim of the phone which usually screws in place.

Two of these phone units are generally used together, being connected in series to increase their resistance and to force all of the current through both sets of magnets. The sensitivity of the phones is proportional to the number of turns of wire in the windings and the number of amperes flowing through them, the product of the two forming the ampere-turns, a direct measure of magnetic strength.

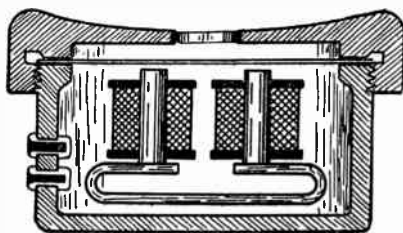

Construction of Headphone Unit.

Granting that the construction of a headphone unit is electrically correct and that a high quality of wire is used, the higher the resistance the greater the sensitivity. High grade units have resistances in excess of 1000 ohms. The sensitivity of such an arrangement may be realized when it is known that it will produce sound with far less than a millionth part of an ampere of current flow.

PHONE, HEAD, CONNECTIONS FOR.—See *Jacks and Switches, Uses of.*

PHONE JACK.—See *Jacks and Jack Switches.*

PHONE PLUG.—See *Jacks and Jack Switches.*

PHONOGRAPH ADAPTER.—See *Adapter, Phonograph.*

PHONOGRAPH AMPLIFIER.—See *Amplifier, Phonograph.*

PHOTO-ELECTRIC.—Pertaining to the effect of light on electric circuits. See *Television.*

PHOTOELECTRIC CELL.—See *Television.*

PICK-UP, ELECTRIC.—See *Amplifier, Phonograph Type.*

PICTURES, RADIO.—See *Television.*

PIGTAIL.—A pigtail is a flexible electrical connection between a moving part and a stationary part of a radio device such as a condenser or a variometer. In a variable condenser the pigtail connects the rotor shaft and rotor plates to the stationary framework of the condenser. In a variometer or variocoupler the two windings are connected by the flexible pigtail while one winding rotates and the other remains stationary.

PILOT LAMP

Pigtails are made from stranded or braided flexible copper wire which may be either bare or silk covered. They are also made from loosely coiled spirals of thin, narrow brass or copper strips. The ends of pigtails are generally soldered to the parts they connect, although they are sometimes only bolted or screwed in place.

The purpose of a pigtail connection is to avoid the rather high and very uncertain resistance of connections made through bearings and sliding contacts. A pigtail formed into a small coil, as is usually done, has practically no inductance perceptible in the action of broadcast tuning units.

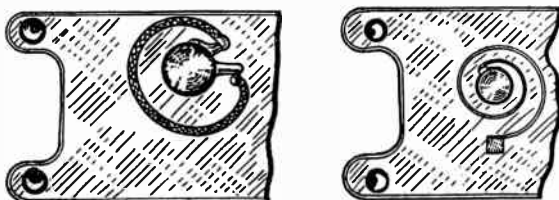

Pigtail Connections for Rotor Shafts.

Any condenser, variocoupler, variometer, tickler or other unit having a pigtail connection must be provided with stops which prevent its turning more than so far in one direction. This is to avoid twisting and breaking the pigtail.

PILOT LAMP.—See *Lamp, Pilot or Panel*.

PITCH.—The frequency of a tone. See *Sound*.

PLATE.—One of the principal elements in a vacuum tube as explained under *Tube, Action of and Tube, Design of*. Also a part of a condenser as explained under *Condenser, Design and Construction of*.

PLATE BATTERY.—A battery furnishing plate current. See *Battery, B-*.

PLATE CIRCUIT.—See *Circuit, Plate*.

PLATE CONDENSER.—A condenser having plates in sheets or flat. See *Condenser, Dielectric for*.

PLATE CURRENT.—See *Current, Plate*; also *Tube, Characteristics of*.

PLATE CURRENT RECTIFICATION.—One method of detection. See *Detector, with Grid Bias*.

PLATE CURRENT SUPPLY UNIT.—See *Power Unit*.

PLATE-FILAMENT CAPACITY.—See *Tube, Capacities, Internal*.

PLATE-GRID CAPACITY.—See *Tube, Capacities, Internal*.

PLATE IMPEDANCE.—See *Tube, Output Resistance and Impedance of*.

PLATE RESISTANCE.—See *Tube, Output Resistance and Impedance of*; also *Tube, Characteristics of*.

PLATE VARIOMETER.—A variometer used in the plate circuit. See *Regeneration, Methods of Obtaining*.

PLATE VOLTAGE

PLATE VOLTAGE.—See *Tube, Plate Voltages for*; also *Tube, Characteristics of*.

PLATE WINDING.—See *Winding, Plate*.

PLATINUM.—A heavy, white metal which withstands very high temperatures and resists the action of all acids except a mixture of nitric and hydrochloric. This metal is used for contacts where sparking may occur and for filament wires in some types of tubes. The specific gravity of platinum is 21.37. Its resistance is 60.15 ohms per mil-foot.

PLATINUM FILAMENT.—See *Tube, Filament Materials for*.

PLIERS.—See *Tools*.

PLUG, PHONE.—See *Jacks and Jack Switches*.

POINTS, SWITCH.—See *Switch, Tap*.

POLARITY.—The relative value of electrical pressure when referred to the earth's pressure as zero. Points of higher pressure than that of the earth are said to be of positive polarity while those at a pressure lower than that of the earth are said to be of negative polarity.

Polarity may refer to flow of electric currents, the current being assumed to flow from positive points to negative points in the circuit, flowing away from positive points and toward negative points.

Polarity may refer to the magnetic field. The magnetic lines of force issue from the positive pole of a magnet and flow around the outside of the magnet to the negative pole. Inside the magnet the magnetic flow is from negative to positive. See also *Negative* and *Positive*.

If two wires attached to a source of direct current have their ends placed in water to which has been added a small amount of any salt or any acid, a large quantity of bubbles (hydrogen) will rise from around the negative wire and only a very few bubbles (oxygen) will rise from the wire attached to the positive of the source. If the two wires from a direct current source are stuck into a piece of raw potato, a green spot will appear around the wire attached to the positive. Polarity may also be determined with the aid of a voltmeter on which the terminals are marked positive and negative. With the positive terminal connected to the positive wire the meter's pointer will move across the scale in the proper direction.

PORCELAIN.—Porcelain for use as an electrical insulator is made by mixing silica, clays and various feldspars with water, the mixture being pressed or likewise formed to shape and dried in a kiln under great heat. Most porcelain for insulators is glazed to allow it to better resist the action of weather and time. Porcelain has a dielectric constant of 4.0 to 6.0.

POSITIVE.—Any electrical pressure greater than the earth's pressure is called positive. The earth is considered as being at zero electrical pressure. In an electric circuit the current is assumed to flow away from positive points and toward negative points. A current flowing away from the source is called a positive current.

POSITIVE BIAS

Points which are negative are marked with the positive or plus sign "+." See also *Negative*.

POSITIVE BIAS.—See *Bias, Grid*.

POST, BINDING.—A screw or spring fastening to which one end of a wire is attached more or less permanently and to which one or more other wires may be temporarily fastened to complete a circuit.

Binding posts are made up of a threaded stud or screw which passes through a support such as a sub-panel or a binding post strip, a nut or threaded washer which holds the screw solidly in place, and a binding nut or cap with which the temporary wire is fastened. The binding nut or cap has a threaded metal core covered with moulded insulating material. This describes the screw type of post.

Spring posts are similar to the screw type except that the cap is held with a spring so that it may be lifted or depressed for insertion of the temporary wire and allowed to spring back, locking the wire in place.

The caps of binding posts are either left plain or are marked with symbols and abbreviations for the circuits which they are intended to complete. The following marks are in common use:

Ant.	Antenna connection
Loop	Loop connection
Grd.	Ground connection
Phone	Headphone connection
Input	Any incoming circuit
—	Negative
+	Positive
A—	A-battery negative
A+	A-battery positive
A+B—	A-battery positive and B-battery negative
A—B—	A-battery negative and B-battery negative
B—	B-battery negative
B+	B-battery positive
B Det+	Detector B-battery connection
B Amp+	Amplifier B-battery connection
C—	C-battery negative
C+	C-battery positive
Speaker—	Negative loud speaker lead
Speaker+	Positive loud speaker lead

See also *Battery, Connection of A- and B-*.

POTENTIAL.—A measure of the electrification or degree of electric charge of a point in a circuit or an electric field. Potential has a meaning very similar to voltage and is measured in volts. The word voltage is generally used when referring to the number of volts pressure between a point and the earth, which is considered as having zero pressure or zero voltage. Potential is generally used to express the difference in volts between two points in an electric current or electric field. For further explanation see *Voltage* and *Electromotive Force*.

POTENTIAL, DIFFERENCE OF

POTENTIAL, DIFFERENCE OF.—The difference in voltage between two points which acts to cause a flow of current from the point of higher potential to the point of lower potential. The potential difference is the voltage drop.

POTENTIAL, GRADIENT OF.—The rate at which potential or voltage changes through a certain distance or the rate at which it changes between two points. This rate may be uniform or it may be greater at one place between the two points than at another place between them. Potential gradient is best shown by a curve such as the one drawn between the plate and filament of a vacuum tube.

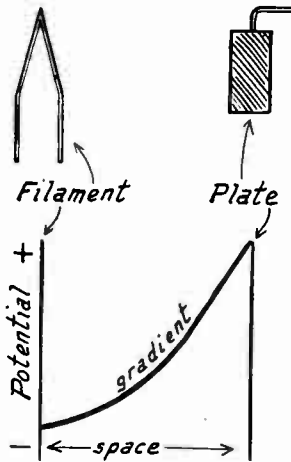

Potential Gradient in Vacuum Tube.

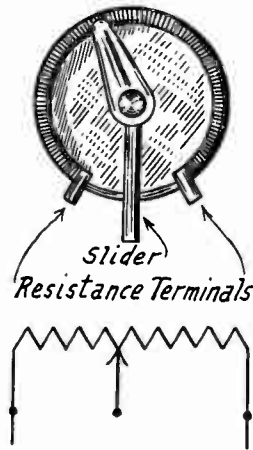

FIG. 1.—A Potentiometer and Its Symbol.

POTENTIOMETER.—The name potentiometer would seem to mean a device for measuring potential, a voltmeter. Common usage has given another meaning to the word potentiometer and the device itself is a voltage divider, a means for dividing a certain potential difference between two different circuits or between parts of the same circuit.

A potentiometer consists of a resistance formed either of wire or some other material. This resistance in commercial potentiometers is usually 200, 400, 600 or 1000 ohms. The resistance unit is formed into part of a circle so that a solid arm or slider may move from one end of the resistance to the other. A potentiometer has three terminals, one terminal at each end of the resistance and a third one connected to the slider arm as in Fig. 1. There are many uses for potentiometers. In fact it may be used under any conditions where a gradually changing or variable voltage or voltage drop is required.

POWER AMPLIFICATION

The two terminals at the end of the resistance unit are connected to the two terminals of a battery or other source of voltage when the unit is used as a potentiometer or voltage divider and not simply as a variable high resistance in series with a circuit.

The operation of a potentiometer may be easily understood by referring to Fig. 2. One end of the resistance is connected to the negative terminal of the battery, and the other end of the resistance to the positive terminal of the battery. Therefore, a current flows through the resistance at all times.

When the slider is at the negative end of the resistance there is no difference of voltage between the slider and the potentiometer terminal at the negative end. If the slider is moved all the way to the positive end of the resistance the voltage difference between the slider and the negative end is equal to the full voltage of the battery. If the slider is now placed half way along the resistance the voltage between the slider terminal and the negative battery terminal is one-half of the battery voltage. One-third of the way across the voltage is one-third that of the battery and so on for any position.

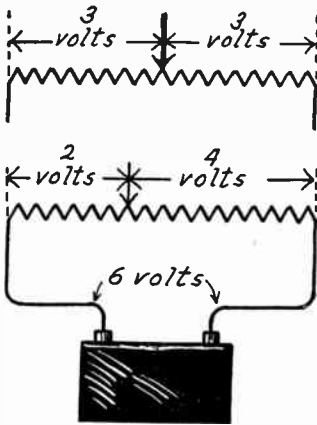

FIG. 2.—Division of Voltage with a Potentiometer.

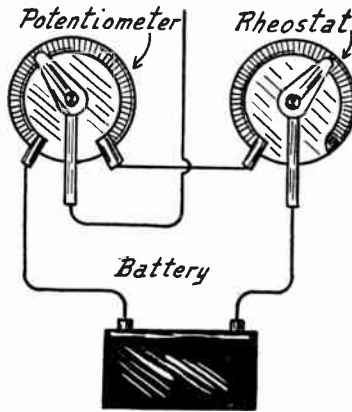

FIG. 3.—Rheostat for Fine Control with Potentiometer.

Between the negative terminal and the slider we can obtain any voltage from zero up to the full voltage of the battery. And between the positive battery terminal and the slider we may likewise obtain any voltage from full battery voltage down to zero.

Under certain conditions it is desirable to obtain variations of voltage finer than those between adjacent turns of wire on a wire-wound potentiometer. This fine variation may be obtained by connecting an ordinary rheostat in series with the potentiometer as shown in Fig. 3. The rheostat arm may then be moved one way or the other to give a slight change in voltage.

POWER AMPLIFICATION.—See *Amplification, Voltage and Power.*

POWER AMPLIFIER.—See *Amplifier, Audio Frequency, Power Type.*

POWER DETECTOR.—See *Detector, Power Type.*

POWER FACTOR.—See *Factor, Power.*

POWER LINE INTERFERENCE

POWER LINE INTERFERENCE.—See *Interference*.

POWER, RECEIVER.—See *Sensitivity*; also *Volume*.

POWER TRANSFORMER.—See *Transformer*.

POWER TUBE.—See *Tube, Amplifying Types of*.

POWER TUBE, ADAPTER FOR.—See *Adapter, Power Tube*.

POWER TUBE, FILAMENT SUPPLY FOR.—See *Power Unit, Filament Current Types of*.

POWER UNIT.—Power units of various types are used for furnishing filament lighting current, for furnishing plate current and also for furnishing grid bias voltage. These power units take alternating current from a public service circuit and change it into a smooth flow of direct current, into a smooth direct voltage.

The two principal types of power supply units include devices which furnish filament current and those which furnish plate voltage. The grid biasing arrangement requires no additional important parts. It is possible to combine any type of filament current supply

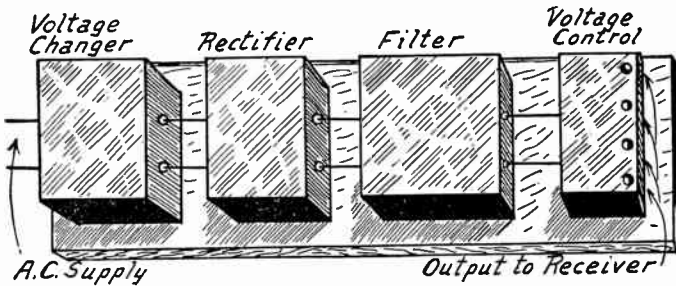

FIG. 1.—Principal Parts of All Power Units.

with any type of plate voltage supply, this giving rise to what appears like an endless variety of power units. When these units are looked upon as being composed of their separate component parts this apparent confusion of types disappears.

Principal Parts of Power Units.—All power units consist of the four principal parts of Fig. 1. Starting from the alternating current supply line, the first part of the power unit is designed to change the incoming voltage to a voltage suitable for use in the receiver. This first part may be a transformer to either increase or decrease the voltage for use on the plates, or to reduce the supply voltage low enough for use in the filaments of the tubes. When it is required only to reduce the voltage, and but small currents are to be used, the work may be done by a number of incandescent lamps connected in series, in parallel, or in series-parallel.

Following the voltage change part of the power unit comes the rectifier which takes the alternating current at proper voltage and makes it into a pulsating direct current. Many kinds of rectifiers

POWER UNIT

are in use. The majority include some kind of rectifying tube, that is, some form of two-element vacuum tube. These tubes are made either to rectify only one-half of the alternating current wave or to rectify both halves, being called half-wave or full-wave rectifiers. Electrolytic rectifiers also are used in many forms of power supplies.

After the rectifier comes a filter which removes the pulsations from the pulsating direct current furnished by the rectifier and leaves a smooth flow of direct current. These filters are built according to the principles outlined under the heading *Filter, Low Pass Type*. They consist of choke coils in series with the lines carrying current to the receiver and of condensers or resistances placed across these lines.

The last part of the power supply unit, the part which follows the filter and comes just ahead of the receiver, is the voltage con-

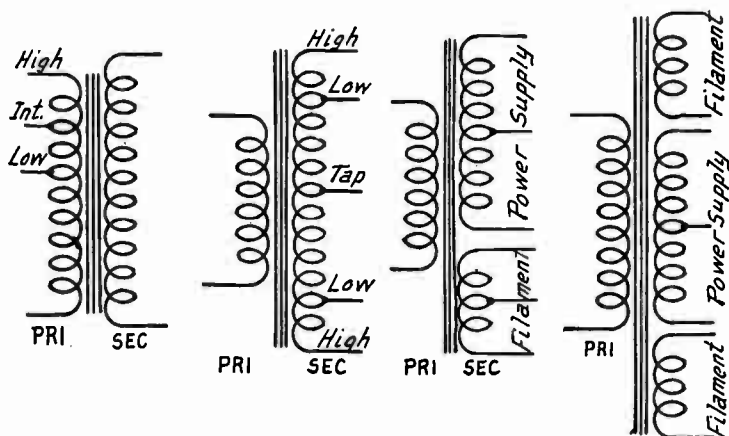

FIG. 2.—Types of Tapped Transformers for Power Units.

trol device. This voltage control allows the furnishing of voltages which are suitable for the plates of detector tubes, for plates of middle stage amplifying tubes, or for power tubes. The voltage control may also handle the filament supply. Voltage control is furnished by various combinations of resistances or by special voltage regulating vacuum tubes.

Voltage Changers for Power Supply Units.—Transformers for use in power supply units as shown in Fig. 2 are of the iron-core, power type. They are quite generally made with a primary winding having one or more taps so that the output voltage may be set approximately at the value required for maximum voltage in the receiver. For full-wave rectifiers the secondary winding of the transformer is tapped at its electrical center. For half-wave rectifiers this center tap is not required. Additional secondary windings may be placed over the same core and used for furnishing

POWER UNIT

filament lighting current, either for tubes in the receiver or for rectifying tubes. Transformers used in this work should have a copper shield between the primary and secondary windings. This shield is grounded. It improves the voltage regulation of the transformer.

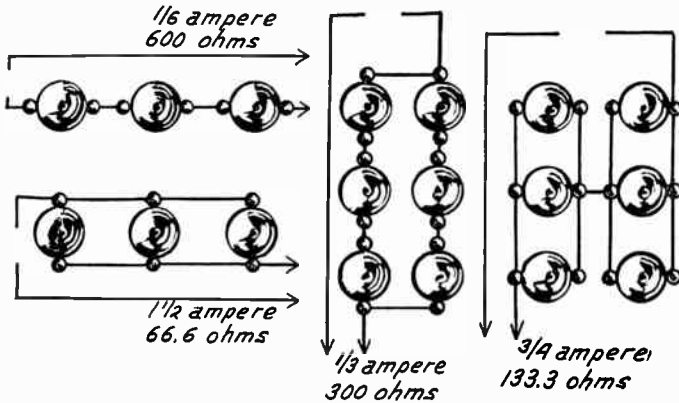

FIG. 3.—Lamp Bank Resistances for Voltage Reduction in Power Units.

If banks of lamps are used for reducing the voltage and limiting the current, it must be remembered that the number of lamps in series determines the drop of voltage, while the number of lamps in parallel determines the current in amperes that will pass into the receiver circuits. This is illustrated in Fig. 3.

Electrolytic Rectifiers.—The principle and action of the electrolytic rectifier are explained under the heading *Charger, Battery, Elec-*

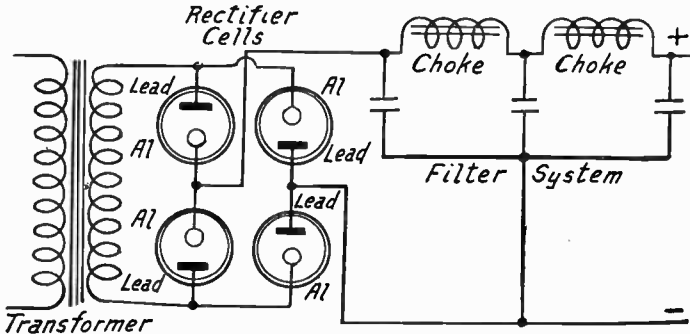

FIG. 4.—Power Unit with Electrolytic Rectifier.

trolytic Type. An electrolytic type of rectifier has the disadvantage that it must be treated with care to avoid spilling. An electrolytic rectifier of given current handling ability is more bulky than a tube rectifier of equal ability. On the other hand the falling off of volt-

POWER UNIT

age with increase of load in milliamperes is less with electrolytic rectifier than with most tube types of rectifiers. This good regulation of the electrolytic rectifier is due to the very low internal resistance of the cells. The regulation is fully as good and even a little better than most of the better types of tube rectifiers and is far superior to the regulation of rectifiers using ordinary receiving tubes.

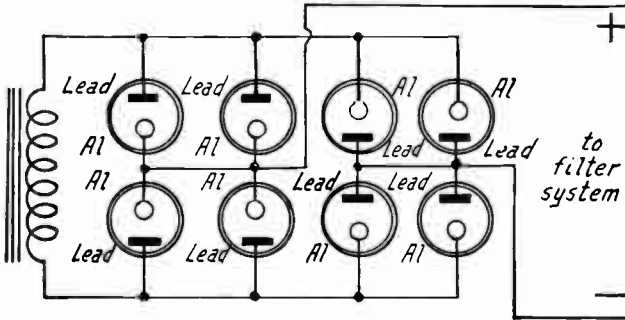

FIG. 5.—Electrolytic Rectifier with Cells in Parallel.

An electrolytic rectifier using only one cell might be used, but the filter required with it would be so much more costly than the smaller filter required with two or more cells that the total cost of the outfit would be greater for the single cell. With one cell it is necessary to use at least thirty microfarads of condenser capacity. A filter for use with a four-cell outfit will not handle a single-cell outfit. The voltage from a single rectifier cell should not exceed from seventy to eighty whereas one hundred twenty volts may be drawn from four cells where two are always in parallel on each side as in Fig. 4. For one hundred and fifty volts it is necessary to use eight cells as in Fig. 5.

Tube Rectifiers for Large Currents.—A satisfactory quarter-ampere filament supply unit may be made with two 2-ampere battery charging tubes so connected that they rectify both halves of the incoming alternating current.

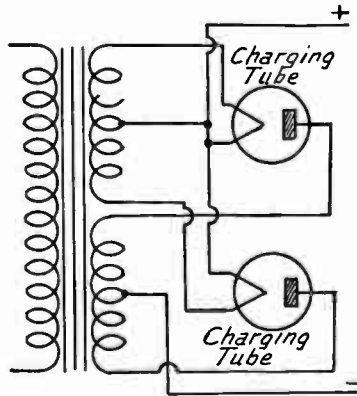

FIG. 6.—Charging Tubes Used as Filament Supply Rectifier.

The connections are shown in Fig. 6. The tubes are called upon to furnish only the quarter of an ampere required for operating a number of filaments in series. The filaments of the rectifying tubes are lighted from an additional secondary winding on the transformer. With this system it is necessary to use a filter having large condensers and large chokes.

When a rectifier such as that just described is used with a receiver having dry-cell tubes the two-ampere rectifying tubes may be replaced with smaller

POWER UNIT

sizes such as those used for trickle chargers. The chokes and condensers in the filter may then be made proportionately smaller. For handling a receiver with small tubes it is possible to equip a rectifier with the plate voltage type of rectifying tubes of proper current handling ability. Such tubes, when designed to furnish plate voltage only, will handle sixty milliamperes or more and are not overloaded to carry the sixty milliamperes needed for the filaments of dry cell tubes.

Tube Rectifiers for Plate Current Only.—Several types of thermionic rectifying tubes are available for use in plate supply power units. These operate according to the principles explained under the heading *Tube, Rectifier Type*. Their symbols are shown in Fig. 7. For rectifying only half of the wave such tubes have only one plate. For rectifying both halves of the wave the tube has two plates. Tubes of this type which are in common use will deliver currents up to eighty-five milliamperes and will handle in excess of 400 volts. For still larger currents two of the half-wave rectifying tubes are used together as shown in Fig. 6. This combination will deliver currents up to one hundred and twenty milliamperes at voltages over 400.

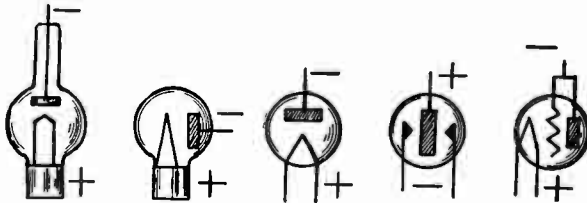

FIG. 7.—Symbols for Various Rectifying Tubes.

Any vacuum tube may be made over into a rectifier tube by simply connecting the plate and grid together. This connection would naturally be made between the terminals on the socket. The ability of a receiving tube to act as a rectifier is limited by the current demands. An ordinary receiving tube cannot be expected to supply plate current for more than two tubes of the same type used as amplifiers if any reasonable length of life is to be secured. By using larger tubes of the power amplifier type much greater plate currents may be drawn.

Gaseous Rectifying Tubes.—A number of full-wave rectifying tubes have been especially developed for use in plate and filament power units. In this type of tube the gas between the electrodes is ionized to start the action by the voltage from a transformer applied across the electrodes. A comparatively low voltage starts the ionization.

In these tubes the action takes place by flow of current through an ionized gas, while in the thermionic or vacuum type of tube rectifier the action takes place by electron flow through the vacuum. In the gaseous tube there is a very small separation between the electrodes, the atoms of gas, which is at low pressure, being in this space where they are struck and ionized by the electrons traveling between the electrodes. The ionization is seen as a faint light from the tube.

POWER UNIT

In the gaseous tube, were the two kinds of electrodes of equal size, current would flow with equal ease in either direction under the influence of the alternating voltage which is to be rectified and passed to the filter.

By making one of the electrodes very small in comparison with the other and using the smaller electrode as negative only a few millionths of an ampere will flow from the large one to the small one. But with the small electrode made positive many thousandths of an ampere would flow from the small electrode to the large one. It is this fact that allows the gaseous tube to act as a rectifier, passing current very easily in one direction but only with the greatest difficulty in the other direction.

The tube is connected to the secondary winding of the transformer as shown in Fig. 8. With the transformer winding at one polarity during half of the alternating current wave one of the small cathodes is positive and the other one is negative. Current will then flow from the positive cathode to the large anode and out into the circuit. There will be practically no flow from the anode to the other small cathode which is held negative on this half of the wave. On the following half of the wave through the transformer, the polarities of the small cathodes are reversed and this half of the wave is likewise rectified because we then have a flow of current from the second small cathode to the large anode and out into the circuit.

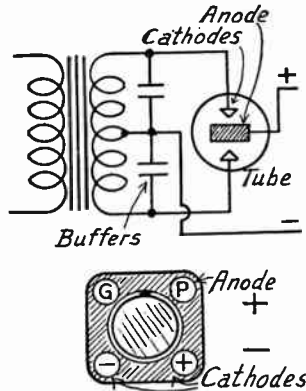

FIG. 8.—Connections for Raytheon Rectifier.

What little current does flow from the large anode to the small cathode which is at negative polarity during half of the wave is called the back current. The smaller the area of the cathodes with respect to the area of the anode the less will be this back current. Back current in a rectifier breaks down the gas insulation and increases the load on the filter circuit so that it is more difficult to eliminate the hum. Finally the greater the back current the less useful current can be taken from the rectifier and the greater will be the drop in voltage under load.

In normal operation the temperature in the gaseous tube is about 200 degrees Fahrenheit. Overloading the circuit will cause the parts to become red hot. This tube fits in a standard vacuum tube socket. The filament terminals of the socket connect to the two cathodes in the rectifying tube and the plate terminal of the socket connects to the anode in the tube. The grid terminal on the socket is left unconnected as in Fig. 8.

Various types of these rectifying tubes have been in use as development progressed. The first units handled a maximum current of about sixty milliamperes, this type being followed by another capable of handling eighty-five milliamperes. Still other tubes now rectify several hundred milliamperes.

POWER UNIT

In the circuit diagram of Fig. 8 will be seen two condensers connected between the center tap of the transformer and the end terminals of the secondary winding. These are called buffer condensers. They stabilize the operation of the rectifier by balancing the impedance to ground of each half of the secondary. They ground the small inequalities of output from the two halves of the transformer.

Filter System.—Upon the excellence of design and material in the filter system depends the successful operation of any power supply unit. A filter system using condensers of too small capacity will fail to handle the load of loud signals, while with chokes that are too small an annoying alternating current hum is almost certain to appear in the receiver's output. The principles upon which filters operate are explained under the headings *Filter* and *Filter, Low Pass Type*.

All of the larger condensers in the filter circuit act as reservoirs for voltage. The chokes oppose changes in flow of current through them. Part of the alternating voltage which attempts to force changes of current through the chokes is stored up in the condensers. As the current through the chokes starts to fall the voltage stored in the condensers maintains the flow. The output

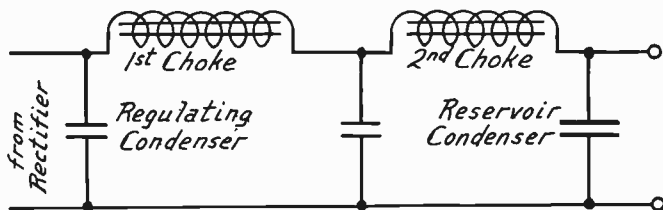

FIG. 9.—Power Unit Filter System with Three Condensers.

from the first choke in a filter is therefore more steady and has less voltage change than the output from the rectifier. The second condenser of the filter acts as another reservoir, storing excess voltage until this voltage is required to maintain current flow through the second choke. The last condenser in the filter, which should be the largest of all, is a final reservoir of voltage from which the circuits of the receiver are supplied.

The action of the chokes is to prevent the current from rising to the maximum value found in the alternating current wave and also to prevent it falling to zero. The chokes hold the current back as the rectified wave comes through. Part of the energy is stored as a magnetic field around the choke. As the pulse of current from the rectifier dies away, this magnetic field collapses, returns its energy to the choke and this energy tends to keep the current flowing as the pulsating wave dies out.

In the commonly used filter circuit of Fig. 9 which has three condensers it may be said that the first condenser, the one toward the rectifier, stores up the pulsations of voltage from the rectifier. It is easy to see that the pulsating current cannot flow through the first choke coil as fast as it comes from the

POWER UNIT

rectifier. Were no condenser used, only a small part of the rectified current would get through the first choke but the condenser acts as a reservoir for this energy so that the condenser and rectifier together feed a fairly constant pulsating current to the choke coil.

Therefore it may be said that this first condenser controls the regulation of the filter.

At the other end of the filter, the condenser next to the output controls the volume and the quality of the audio amplifier. The milliamperes of current required by the plate circuit of the audio amplifier vary within wide limits. With powerful signals the demand for current may go as high as thirty or more milliamperes and it may then drop as low as five or ten milliamperes. The last condenser forms a reservoir of energy to take care of this great fluctuation. The larger this condenser within reasonable limits the better it will be able to care for the changing load upon it.

The middle condenser of the filter serves simply to assist the other two in their work. That is, it improves the general all-around ability of the filter. In the usual design of power units an improvement may be made by increasing the capacity of the first and last condensers.

Half-wave rectifiers require chokes and condensers much larger than those required with full-wave rectifiers, both types being assumed to have the same output. Some types of rectifiers, both tube

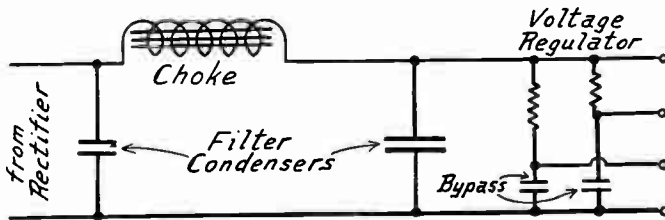

FIG. 10.—Power Unit Filter System with Single Choke.

and electrolytic, allow a considerable back current to flow. These back currents not only make it more difficult to filter the output of the rectifier but they also increase the heating of the choke coils.

The condensers used in power supply units, especially in units furnishing plate voltage, must themselves be able to withstand at least 600 to 700 volts. It will be better if these condensers are built to stand 1000 volts across their terminals. It is sometimes difficult to obtain high voltage condensers of large capacity. A number of small condensers whose total capacity is that required may be connected in parallel to form the equivalent of one condenser of large capacity. Various types of filters are shown in Figs. 10 and 11.

Methods of regulating the plate voltages applied to the various circuits of a receiver are described under *Power Unit, Plate Voltage Types*.

Construction of Power Supply Units.—All condensers and choke coils used in the filter system should be enclosed in metal cases and all of those cases should be grounded to the negative

POWER UNIT, COMPLETE RECEIVER SUPPLY

side of the circuit. The condensers may be bound together into one unit with their cases touching.

Since many parts of the circuits in power supply units are at high voltage well insulated wire must be used. Rubber covered flexible stranded wire is satisfactory or the work may be done with bus wire covered with rubber tubing. Leads used for filament current circuits should be made from twisted double-conductor cable which will reduce pick-up of alternating current hum.

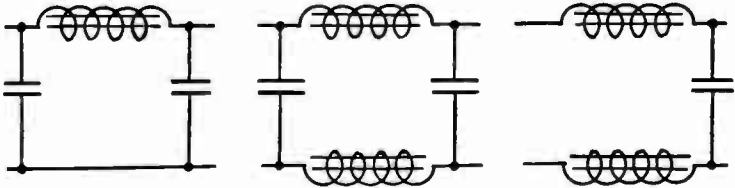

FIG. 11.—Arrangements of Power Unit Filter Condensers and Chokes.

While it is true that all of the condensers used in the filter system should be grounded, the cases of bypass condensers used in the output plate circuit or loud speaker circuit of a power tube should not be grounded or connected electrically to any other part. This is mentioned here because a power amplifier is often combined with a power supply unit.

Filter systems may be built with a so-called choke input by omitting the first condenser as in Fig. 12. This arrangement reduces the strain placed on the rectifier tube by the high voltage surge and also allows the use of condensers built for lower voltages than those required to immediately follow the rectifier. The voltage from the rectifier is lowered by the first choke and is smoothed out to a great extent so that the condenser placed between the chokes has to withstand a comparatively low voltage. See *Tube, Rectifier Type* for tables of comparative voltages.

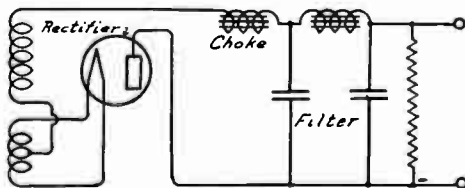

FIG. 12.—Filter with Choke Input.

When three condensers are used, as in the ordinary filter, the maximum voltage impressed on the first condenser is the maximum amplitude of the alternating voltage from the transformer, this being equal to about 1.4 times the effective alternating voltage. The voltage impressed on the second condenser in the filter is only ten to fifteen per cent higher than the output voltage to the amplifier, while the voltage on the third condenser is the same as that furnished to the amplifier.

A circuit developed for use with Raytheon gaseous rectifier tubes is shown in Fig. 13. The small buffer condensers placed across the

POWER UNIT, COMPLETE RECEIVER SUPPLY

transformer terminals as in Fig. 8 are replaced with condensers of smaller capacity placed across the tube terminals. The two chokes are replaced with a single unit having two windings on a single core so arranged that the two direct current fluxes cancel.

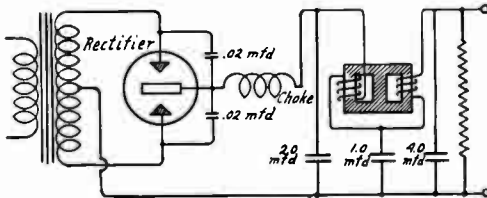

FIG. 13.—Connection of Bucking Coil Filter Choke.

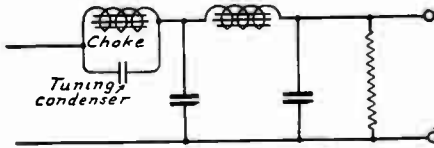

FIG. 14.—Principle of Tuned Filter.

In an attempt to prevent passage of the rectifier frequency through a filter some units are constructed with tuned circuits to offer maximum reactance. Such a plan is illustrated in Fig. 14. A condenser is placed across one or more of the filter chokes, the capacity being such that it tunes with the choke's inductance to the frequency which is to be reduced.

See also *Rules, Underwriters' and Trouble, Receiver and Power Unit.*

POWER UNIT, COMPLETE RECEIVER SUPPLY.—

From the explanations of the principles of power supply units it may be realized that combinations are possible which will furnish filament current, plate voltage and grid bias, all from the one alternating current source.

Any desired negative grid bias may be obtained by proper connection of grid returns when series connected filaments are operated from a power unit. Practical applications of this method are shown under *Power Unit, Filament Current Types of.*

The negative grid biasing voltage for power tubes may be secured from any type of plate voltage supply by providing a negative tap as shown in Fig. 1. The grid return to be biased is connected to the negative terminal of the voltage supply unit. The next higher terminal is used as the regular A— and B— point for connection of the filament negatives. No separate unit is needed to obtain a biasing voltage.

POWER UNIT, COMPLETE RECEIVER SUPPLY

Methods of furnishing filament current to the final power tube or output tube of a receiver are described under *Power Unit, Filament Current Types of*. Such a power tube supply may be used in connection with any plate voltage unit simply by connecting the *B-* (or *A-B-*) terminal of the power tube amplifier to the *B-*

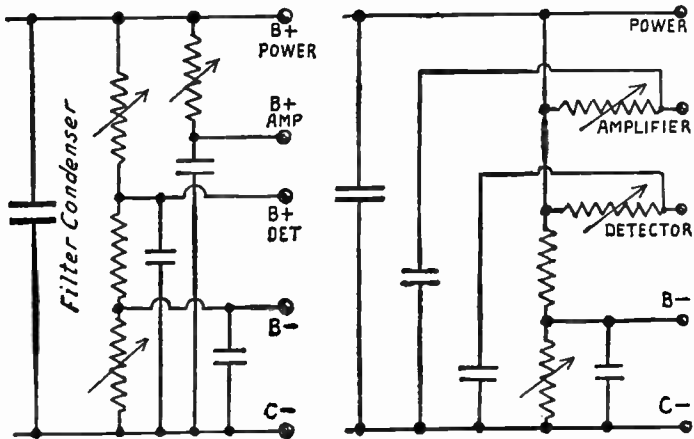

FIG. 1.—Obtaining Grid Biasing Voltage from Plate Supply Unit in Complete Receiver Supply Type of Power Unit.

terminal of the plate voltage supply unit or directly to the receiver. This is shown in Fig. 2.

A power unit which furnishes filament current to tubes in series and also furnishes plate voltage does not differ in any material way

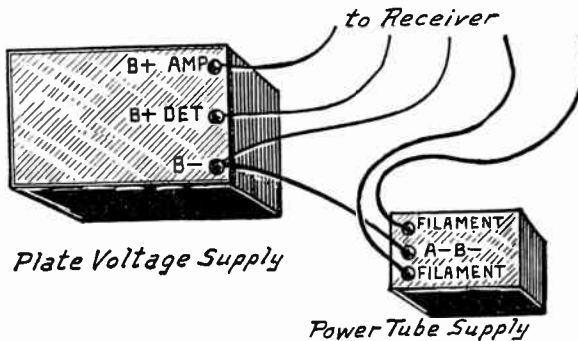

FIG. 2.—Filament Transformer Used with Plate Voltage Unit to Form Complete Receiver Supply.

from the unit made to furnish only plate voltage. Fig. 3 shows the general method by which the combination unit furnishes both filament and plate supply at the same time. The *A+* connection

POWER UNIT, D. C. SUPPLY TYPE

is made through a resistance which has a large current carrying ability. That is, the resistance must be able to carry the sixty milliamperes for small tube filaments or the quarter ampere for larger tubes without undue heating. The plate voltage or "B-battery" connections and resistances are made in the usual way. The biasing connection for a single tube is shown in Fig. 4.

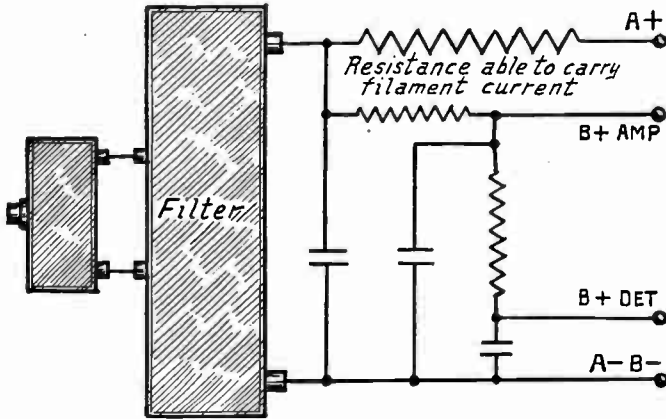

FIG. 3.—Voltage Control for Filament Current in Complete Receiver Supply.

Combination units do not introduce any new principles whatever. They are primarily made up by connecting the various types of filament, plate and biasing arrangements to one set of terminals so that they may be conveniently connected to a receiver and so that they may all be assembled in one housing or box. It is possible to make up such a combination unit just as it is possible to make up a receiver. In the power unit this is done by selecting the desired

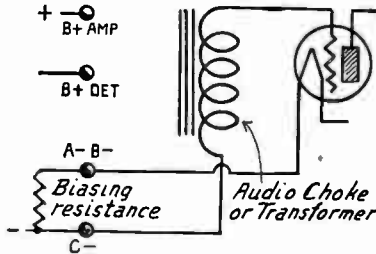

FIG. 4.—Biasing Resistance in Grid Return Used in Complete Receiver Supply.

type of filament supply, plate supply and grid bias method and building them all together. In a receiver the thing is done by selecting the desired type of radio frequency amplification, detector and audio frequency amplification and building them all together. It is just a matter of looking at the completed job as an assembly of parts, all connected to one common set of terminals.

See also *Jacks and Switches, Uses of.*

POWER UNIT, D. C. SUPPLY TYPE.—A power unit for supplying plate and filament current may be operated from 110-volt

POWER UNIT, FILAMENT CURRENT TYPES

direct current supply lines by using the design shown in Fig. 1 or by the use of equivalent circuits including filter and voltage regulating devices. Since the voltage of a direct current cannot be stepped up with a transformer as can alternating current, the maximum plate voltage will be somewhat lower than the supply voltage.

The filament supply flows through the filament resistor and the 20-ohm rheostat. The rheostat is used to compensate for line voltage variations, the tube filament voltage being indicated at all times by the voltmeter. The value of the filament resistor depends on the number and kind of tubes used. Using quarter-ampere tubes the resistance at this point should be 125 ohms for three tubes, 90 ohms for four tubes, 70 ohms for five tubes, 55 ohms for six tubes, 45 ohms for seven tubes and 37 ohms for eight tubes. Ripple in the filament current is reduced by the 2000 microfarad electrolytic condenser.

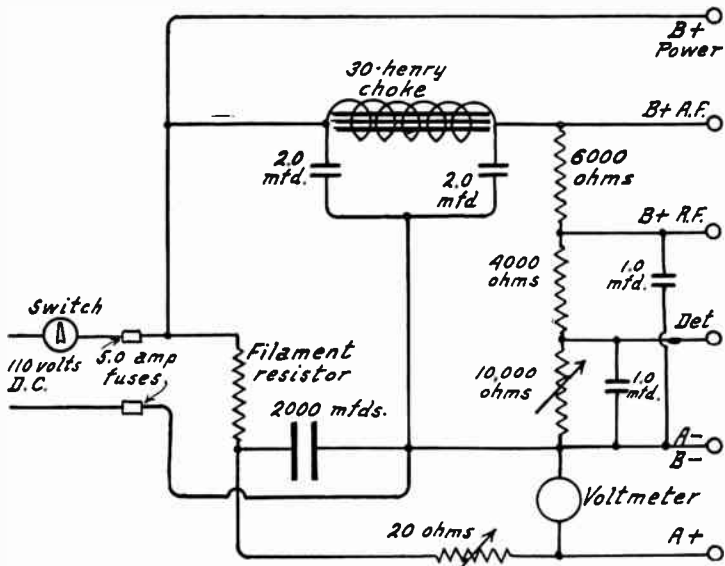

FIG. 1.—Power Unit Operating from D.C. Supply.

This unit is of the high capacity, low voltage type generally used in filament supply circuits. Any capacity from 1500 microfarads upward will be satisfactory.

Plate current for the power tube or tubes is taken directly from the supply line to secure maximum voltage. The remaining plate supply taps are handled through a filter consisting of one 30-henry filter choke capable of carrying at least twenty mils, and two filter condensers of two microfarads capacity each. The voltage divider includes two fixed resistors and one adjustable resistor as shown.

It is necessary that the unit be connected to the supply line with due regard to polarity. Should the voltmeter read backward the connecting plug should be reversed.

POWER UNIT, FILAMENT CURRENT TYPES OF.—
The power units which are to be considered at this time do not in-

POWER UNIT, FILAMENT CURRENT TYPES

clude those filament supply or A-supply units which employ a small storage battery and a rectifying trickle charger. Such units are described under the heading *Charger, Battery, Trickle Type*. Power units which furnish plate voltage may be combined with filament current supply units but are often built and used separately.

The necessary negative grid bias is obtained for amplifier tubes having filaments in series by connecting the grid return for the tube to be biased to the negative side of the filament in one of the preceding tubes. The voltage drop to the filament of the preceding tube forms a biasing voltage.

Filament current supply units are made for use with various types of receiving tubes. It is possible to operate any number of the small three-volt tubes designed for dry cell filament supply by connecting their filaments in series with each other so that the entire filament circuit takes only the sixty milliamperes current required for any one of the filaments. This is shown in Fig. 1. It is also possible to use a similar arrangement of series connected filaments with the

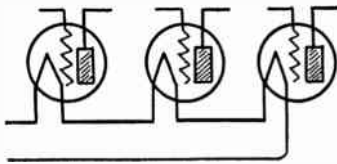

FIG. 1.—Filaments in Series to Use Filament Supply Power Unit.

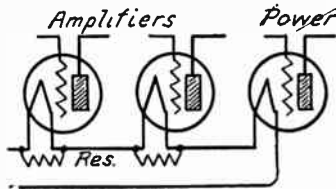

FIG. 2.—Bypassing Resistances for Tubes When Using Filament Power Unit.

larger quarter-ampere receiving tubes, sending the required quarter-ampere through the entire circuit.

Connecting the filaments in series is feasible only when all the tubes require the same flow of current. A difficulty arises when the receiver is equipped with an output tube of the power type, taking one-half ampere or more. If the filament of such a tube is to be operated in series with tubes requiring smaller currents, the smaller tubes must have bypassing resistances as in Fig. 2. These resistances take care of the additional current which must not go through the filaments of the small tubes. Resistances of 45 ohms each are suitable for the small three-volt tubes when using a power tube taking 0.125 ampere filament current.

A more generally used arrangement for handling a single power tube is to equip the power supply unit with an additional source of alternating current at a voltage suitable for the filament of the power tube. Proper balancing of the grid return circuit with a potentiometer or split transformer winding allows satisfactory use of the alternating current for the power tube filament without the need of changing it to a smooth direct current.

A supply of filament current for quarter-ampere tubes in series may be secured from the unit shown in Fig. 3. The two rectifier tubes, which are of the battery charger or trickle charger type, are connected to a transformer having two tapped secondary windings.

POWER UNIT, FILAMENT CURRENT TYPES

The filament sides of the tubes are connected to the positive side of the filter circuit and the plates of the tubes are connected to the negative side. This makes a full-wave rectifying outfit. Electrolytic condensers may be used.

If the arrangement of Fig. 3 is to be used only for filament supply, the secondary voltage from the transformer need be only enough to

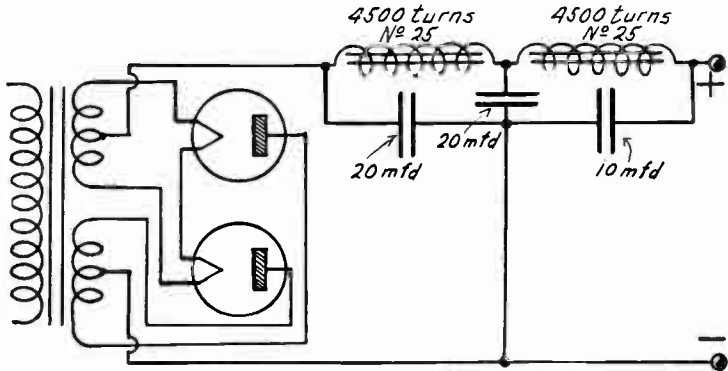

FIG. 3.—Using Two Charging Tubes for Filament Supply Power Unit.

handle the filaments of the receiver to be operated. This required voltage is found by multiplying the total number of tubes in the receiver by the voltage required for one of them, then allowing enough additional voltage to overcome the voltage drop through the rectifier tubes and the filter chokes.

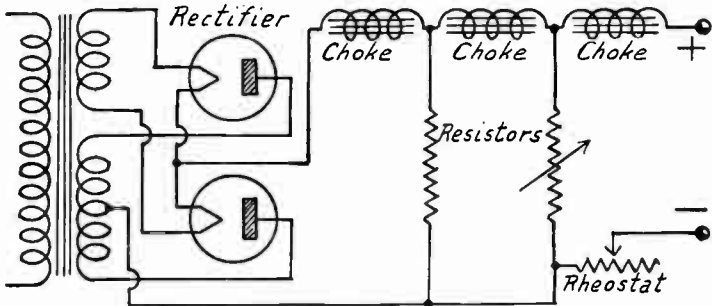

FIG. 4.—Filament Supply with Resistors in Filter System.

If quarter-ampere tubes are to be operated, it will be found advisable to use two-ampere battery charging tubes for the rectifier. If the receiver uses dry-cell tubes taking only sixty milliamperes, then the rectifier tubes may be of the trickle charger size.

If this general method of Fig. 3 is used for both filament and plate supply, it will require that the transformer deliver a terminal voltage at no load which is at least double that of the highest plate

POWER UNIT, FILAMENT CURRENT TYPES

voltage. At the same time the transformer windings must be of wire large enough to carry the total of filament and plate currents together without heating.

Fig. 4 shows the use of tubes like those of Fig. 3 but here the filter system is composed of chokes and resistances in place of chokes and condensers. The filament control rheostat of Fig. 4 may be inserted in the filament current supply line of any type of unit.

The use of a full-wave rectifying tube for filament current supply is shown in Fig. 5. It will be seen that the connections and the principle of operation are exactly like those for a plate supply unit using a similar tube. For filament current, as in Fig. 5, the rectifying tube is of larger current carrying ability and the chokes also are wound to carry the increased current without overheating. When this outfit is used for combined filament and plate supply purposes the output terminals are attached to any of the voltage control systems shown under *Power Unit, Plate Voltage Types*.

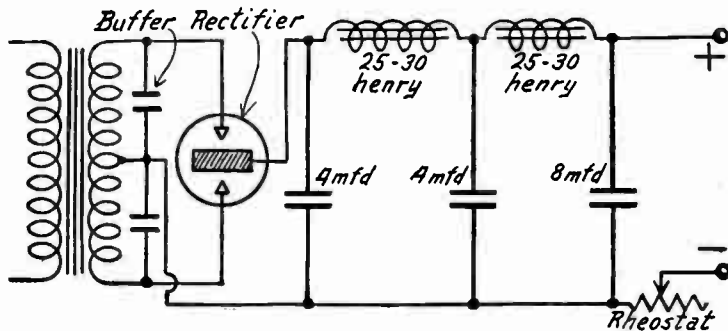

FIG. 5.—Full Wave Rectifying Tube for Filament Supply.

Power Tube Supply.—When the last tube in the receiver is of the power type it is possible to furnish this power tube with filament current directly from a small additional transformer used as shown in Figs. 6 and 7. This system really applies alternating current to the tube filament because this current does not pass through a rectifier of any type. By proper balancing of the grid return circuit through a potentiometer it is possible to so reduce the alternating current hum that it is not noticeable.

Such a unit as shown in Figs. 6 and 7 may be made up separately and connected to follow either the detector or the first audio amplifying tube of any receiver. It may also be incorporated in the receiver when built in the first place. There is no difference in the connections either way.

The power tube grid is operated from an audio frequency transformer as shown or from any other type of coupling generally used for audio amplification. The primary of the coupling unit is connected to the plate of the

POWER UNIT, FILAMENT CURRENT TYPES

preceding tube and to the B-battery or plate supply unit. A small transformer, with internally shielded windings, has its primary connected directly to the alternating current lines. The secondary of this transformer

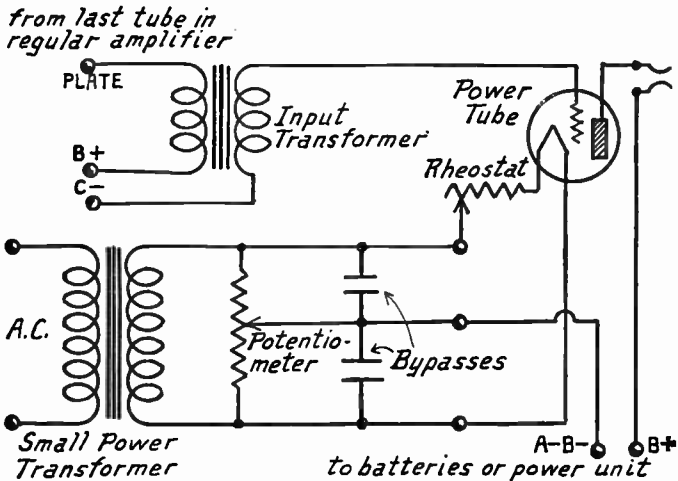

FIG. 6.—Power Tube Filament Current from Untapped Transformer.

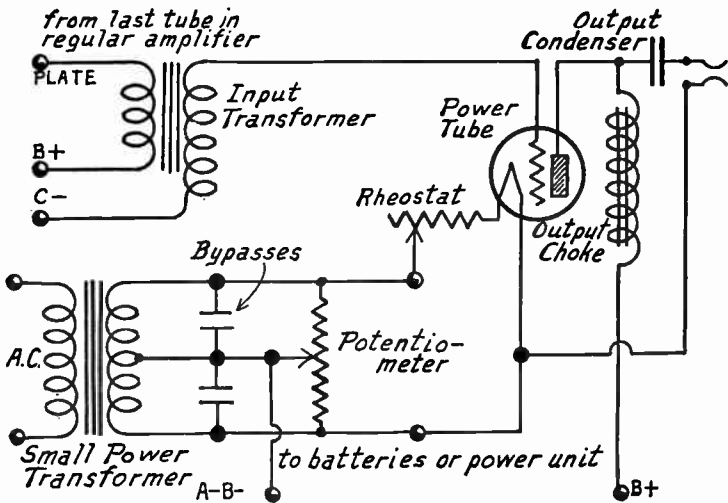

FIG. 7.—Power Tube Filament Supply from Tapped Transformer.

is bridged with a potentiometer and bypass condensers as shown. Fig. 6 shows a transformer with an untapped secondary while Fig 7. shows the connections used with a tapped secondary.

POWER UNIT, FILAMENT CURRENT TYPES

The outer ends of the transformer secondary are connected to the filament terminals of the power tube with the usual rheostat in series. Since the current is alternating, it is not necessary to pay any attention to the positive and negative markings of the filament terminals on the power tube socket. The grid return for the power tube runs to a C-battery or to the biasing tap of a plate supply unit. The center of the potentiometer is connected to the A— or B— terminal of the batteries or plate supply unit used with the receiver. With the power tube in operation the slider or arm of the potentiometer is moved until the point of least hum is found.

Since a power tube invariably uses a high plate voltage, the loud speaker connection indicated in Fig. 7 should always be used in preference to the method of Fig. 6. In Fig 6 the high voltage direct current flows through the speaker windings and tends to demagnetize the speaker magnets. In Fig. 7 the alternating current part of the plate output goes through the speaker, the direct current passing through the choke.

Grid Bias with Filament Supply Units.—By making the proper connections of grid returns to the filament circuit of a number of filaments operated in series any needed amount of bias may

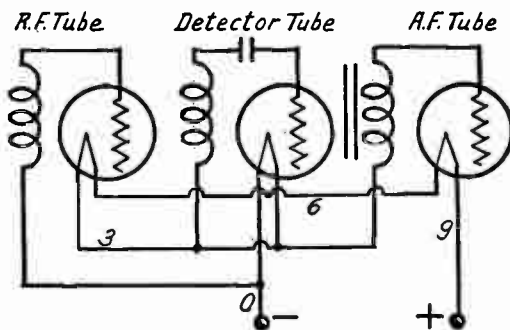

FIG. 8.—Grid Biasing with Three-Volt Tubes in Series on Filament Current Power Unit.

be secured from the voltage drop through the filaments. The principle is shown in Fig. 8.

In following out this method of biasing it is advisable to attach the positive side of the current supply unit to the positive terminal of the last audio tube being handled in the series circuit. And it is also advisable to make the negative connection from the current supply unit to the negative terminal of the detector tube. This puts the least likelihood of hum from the power unit at the detector end of the circuit where hum would be most harmful. The last audio amplifier tube can best stand any hum that may come through the power unit and such hum is most noticeable at the positive end.

Fig. 8 shows a receiver employing one radio frequency amplifying tube, one detector tube and one audio frequency amplifying tube, all three having their filaments in series. Before going further it should be mentioned that a power tube with a separate filament current supply as in Figs. 6 and 7 might be added to any of the

POWER UNIT, FILAMENT CURRENT TYPES

circuits to be shown here without in the least altering the grid biasing of the tubes preceding the power tube.

Assuming the three tubes of Fig. 8 to be of the three-volt type (dry cell tubes) it will be evident that the three will require three times three volts or nine volts across the positive and negative terminals shown. Between the negative terminal of the power unit and the positive side of the audio frequency tube we will then have nine volts, between the audio frequency tube and the radio frequency tube we will have six volts, between the radio frequency and the detector we will have three volts and from the detector back to the negative terminal there is zero voltage. All these voltages are with reference to the voltage at the negative terminal which is considered as zero.

Now to secure the proper biasing. The negative side of the filament in the audio tube is at six volts potential. To obtain a three-volt negative bias for this audio tube its grid return must be made

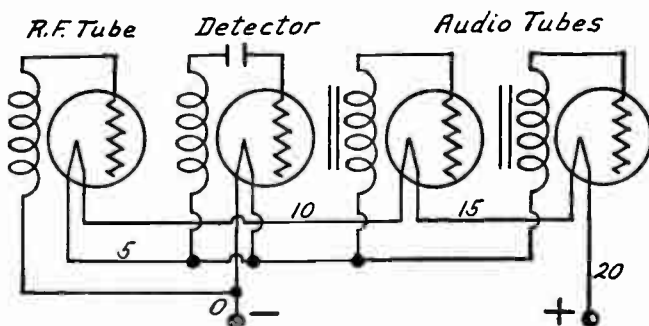

FIG. 9.—Grid Biasing with Five-Volt Tubes in Series.

to some point in the filament circuit whose potential is lower than its own negative side. This connection is shown, all the lines being marked with their potentials.

The negative end of the filament in the radio tube is at a potential of three volts and to secure three volts negative bias the grid return for this tube is connected to a line at zero voltage, this also being shown. In Fig. 8 it is assumed that a hard tube is used for a detector and the needed positive grid bias is secured as usual by making the grid return of the detector to the positive side of the detector filament.

The same general method of biasing is applied to a four-tube receiver in Fig. 9 having one radio frequency tube, one detector and two audio frequency tubes. Here it is assumed that the tubes are of the five-volt type, consequently four of them will require twenty volts. There is a five-volt drop through each filament and the resulting potentials are marked on the various parts of the circuit. In order to show the possibilities of this method the last audio tube of Fig. 9 has been given a ten-volt bias. The negative end of the filament in the last audio tube is at fifteen volts and its grid return is

POWER UNIT, FILAMENT CURRENT TYPES

made to a five-volt line, giving the desired ten-volt drop for the grid. The first audio tube, with ten volts at its negative filament terminal, has a grid return to a five-volt line, giving five-volt negative grid bias. The radio tube uses the difference between five volts and zero voltage, giving it a five-volt negative bias and the detector return is to the positive of its filament as before.

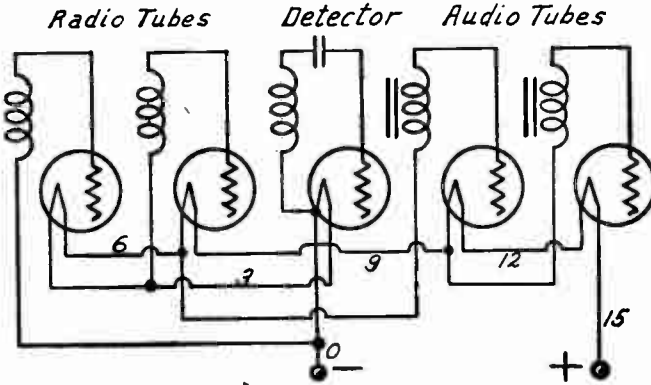

FIG. 10.—Biasing for Five Tube Receiver with Three-Volt Tubes When Using Filament Current Power Unit.

Fig. 10 illustrates a five-tube system, two radio, detector and two audio, with each tube carrying a three-volt negative bias. Here the detector return has been made to the negative side of the detector filament, this being a practice followed with gas content or soft detector tubes. Fig. 11 shows a

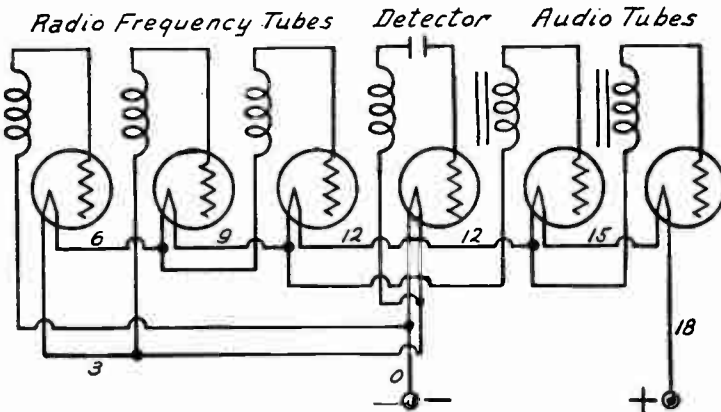

FIG. 11.—Biasing for Six Tube Receiver with Three-Volt Tubes Using Filament Power Unit.

six-tube circuit using three-volt tubes, each tube having a three-volt negative grid bias except the detector which, being a hard tube, uses a positive return.

To apply this method to any receiver it is only necessary to determine the desired amount of negative bias for each tube, then

POWER UNIT, FILAMENT CURRENT TYPES

make its grid return to a point whose voltage is lower than the negative side of that tube's filament, the difference in voltage being equal to the desired bias. The voltages may be calculated according to known voltage drops across the filaments. The drop may be determined by the use of a voltmeter having its negative side connected to the negative terminal of the power supply unit while the meter's positive side is touched to the negative filament socket terminals and to the lines to be used for biasing grid returns until suitable voltages are located.

Low Voltage Filament Supply.—Many filament supply units are made with low voltage copper oxide, copper sulphide or electrolytic rectifiers and with dry or wet type electrolytic filter condensers of very large capacity. See *Condenser, Electrolytic* also *Rectifier*,

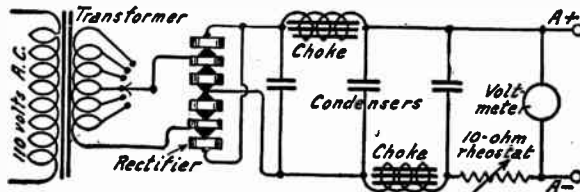

FIG. 12.—Typical Circuit for Low Voltage Filament Supply.

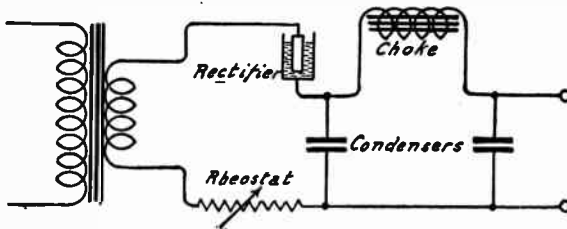

FIG. 13.—Filament Supply Unit with Electrolytic Rectifier.

Copper Types. The circuit for a typical unit of this kind is shown in Fig. 12. The transformer is of the step-down type delivering 2.5 to 3.0 amperes at twelve to sixteen volts. The secondary is tapped to compensate for the number of tubes supplied and for line voltage variations. The rectifier, of the full-wave type, consists of a series of copper oxide or sulphide couples arranged so that the center is negative and the two ends positive.

The two chokes are alike. Each is built to carry from two to three amperes, since the output must be at least two amperes to handle all types of receivers. The inductance ranges from one-twentieth to one-tenth of a henry and the direct current resistance is in the neighborhood of one-third ohm. The dry type condensers have from 1500 to 2500 microfarads capacity each. In some cases the capacity of the first and second condensers is made smaller than that of the third or output condenser.

POWER UNIT, PLATE VOLTAGE TYPES

In Fig. 13 is shown the circuit for a filament supply unit employing a half-wave electrolytic rectifier and two electrolytic condensers with a single choke. These condensers have enormous capacity, greater than 100,000 microfarads each, which makes possible the use of but a single choke.

Chokes for these units are constructed with large wire to reduce heating and are provided with comparatively large air gaps to prevent core saturation by the larger current to be carried. In assembling the power supply the two chokes should have the axes of their windings at right angles for minimum coupling. The dielectric film of the condensers may be kept in good condition by operating the power unit for several hours occasionally with the receiver filament switch turned off. The low voltage rectifiers will require replacement after one thousand or more hours of use.

POWER UNIT, PLATE VOLTAGE TYPES.—Like all other power units the plate voltage type is made up of a voltage changing device, a rectifier, a filter and a voltage control. The voltage changing device is usually a transformer, although it may be a bank of incandescent lamps in some cases. The rectifier may be of either the tube type or the electrolytic type. Transformers, rectifiers and filters are described under *Power Unit*. The plate voltage type of power supply unit requires a voltage control somewhat more complicated than the simple methods suitable for control of filament voltage.

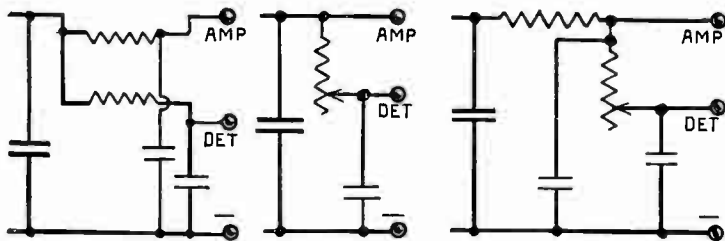

FIG. 1.—Plate Voltage Control Resistors in Series with Receiver Lines.

Output Voltage Control.—Resistances for the control of the voltage output from a power supply unit may be of the fixed or variable type. They may be connected in series between terminals of the power unit and the corresponding B-battery terminals of the receiver as in Fig. 1 or they may be connected as shunts across the total output of the power supply as in Fig. 2. When connected as shunts the resistances act as potentiometers, dividing the total voltage unequally between several paths.

More or less trouble is always encountered when dividing the output of a power supply unit between the various parts of a receiver by the use of variable resistors. This trouble arises because of the fact that a unit of this kind has not a large reserve supply of power such as found in a battery. The power supply unit has available a certain number of watts and watts are equal to volts multiplied by amperes. If the receiver makes an extra demand for current, more current may flow but the voltage must drop so that the power remains practically the same.

POWER UNIT, PLATE VOLTAGE TYPES

As an example in drop of voltage, a certain rectifier unit will deliver twenty milliamperes at 135 volts but when the current demand is raised to fifty milliamperes this is delivered at only seventy volts.

When two or more resistances are used for voltage control in a single power supply unit a change of any one resistance with the intention of changing the voltage at its terminal will change the voltage at all of the other terminals even though their resistances are not touched.

A fixed resistance is often used between the negative side of the filter circuit and the terminal leading to the detector plate circuit. This resistance should be of the lowest value that will give satisfactory detector voltage because any changes in the current drawn by the amplifying tubes will then cause a smaller corresponding change in the voltage furnished to the detector.

All resistances used for voltage control should have bypass condensers across their terminals unless the receiver is completely equipped with bypass condensers in all of its plate circuits. Bypass condensers across the resistance units should be of one microfarad capacity at the least. An exception may

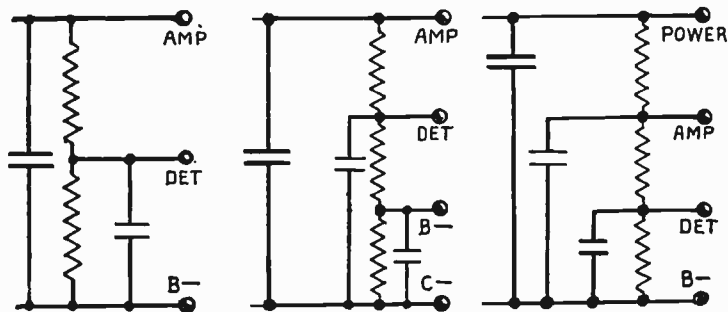

FIG. 2.—Plate Voltage Control Resistors as Shunts Across Power Output.

be made for the detector resistance across which a one-half microfarad bypass is sufficient. All resistance units must be of a type which will carry the required number of watts without overheating. Graphite resistances or metalized resistance units may be obtained with sufficient current carrying ability for this work.

Determination of Regulating Resistances.—The necessary values of shunted resistances such as those shown in Fig. 2 may be determined from Ohm's Law. It is necessary to know the voltage drop across each of the resistors and the amount of current that must flow through each in handling the plate circuits of the tubes attached to the tap terminals. The values are inserted in the following formula:

$$\text{Resistance in Ohms} = \frac{\text{Number of Volts Drop}}{\text{Number of Amperes Carried}}$$

Determination of the number of volts drop is very simple. The voltage to be applied to the detector plate is the drop across the resistor connected between the B- tap and the B+ Det tap. For 22 1/2 volts on the detector

POWER UNIT, PLATE VOLTAGE TYPES

the drop is 22 1/2 volts, for 45 volts on the detector the drop is 45 volts and so on. The voltage drop across the next resistor, the one between the *B+* *Det* tap and the lowest amplifier tap is equal to this amplifier voltage less the detector voltage. With 22 1/2 volts on the detector and 90 volts on the first amplifier, the drop will be 90 minus 22 1/2, or 67 1/2 volts. The voltage drop across the next higher resistor will be equal to the number of volts at the high end minus the number of volts at the lower end. If the higher voltage is 135 and the lower one is 90, then the drop is their difference, or 45 volts.

The number of amperes to be carried through the resistors is determined as follows: An arbitrary current flow is assumed for the resistor between *B-* and *B+* *Det*. To avoid excessive variations of voltage to the detector this resistance is made low enough so that about five milliamperes or .005 ampere will flow through it. The first resistor then carries .005 ampere.

The next resistor, between *B+* *Det* and the first amplifier terminal, will carry all of the current through the first one (.005 ampere) plus the plate current taken by the detector tube. With 22 1/2 volts on a hard tube detector this current will average one-half milliampere or .0005 ampere. With 45 volts on a hard detector the plate current will be about one milliampere or .001 ampere. The new gaseous detectors take about one milliampere or .001 ampere. The detector plate current is added to the steady current through the lowest resistor to give the total current through the resistor between *B+* *Det* and the first amplifier tap. Depending on the detector used and on the voltage applied this current will generally be around .0055 to .006 ampere.

Each of the following higher resistors carries all of the current flowing through the one next below plus the plate current for the tubes connected to its lower terminal. Thus, if the first amplifier terminal feeds two amplifying tubes, each taking two and one-half milliamperes or .0025 ampere, the plate current will amount to their sum or .005 ampere. This, added to the previously determined current through the next lower resistor, will make up the total current to be considered. For example, if the total current for the next lower resistor were found to be .006 ampere, adding this .005 ampere would give a total current of .011 ampere flowing through the resistor next above the first amplifier terminal. The number of amperes plate current taken by various tubes with all the usual plate voltages and biasing voltages will be found in the table under *Tube, Amplifying Types of*. The current in amperes found from that table is multiplied by the number of tubes connected to the tap being considered to find the total number of amperes drawn off at this point. The following tabulation indicates the method used for determining the currents carried by the resistors.

1st Resistor (<i>B-</i> to <i>B+</i> <i>Det</i>)005 ampere
2d Resistor (<i>B+</i> <i>Det</i> to <i>Amp</i>)....	Detector plate current plus .005 ampere
3d Resistor (<i>Amp</i> to <i>Power</i>)....	Amplifier plus detector plus .005 ampere
4th Resistor (if used)....	Added tube plus sum of all other plate currents.

Knowing the voltage drops across each resistor and the current in amperes flowing through each one, it is now possible to use these values in the formula first given. As an example, the voltage control at the right hand side of Fig. 2 will be calculated. Assumed conditions are as follows: Detector voltage, 45; plate current, .001 ampere. Tubes connected to "*Amp*" terminal, three with 90 volts on their plates and each drawing two milliamperes or .002 ampere. The current flowing to the power tube from the "*Power*" terminal does not enter into the calculation but it will be assumed that this terminal delivers 180 volts.

The voltage drops are as follows: 45 volts from *B-* to *Det*, 45 volts from *Det* to *Amp*, and 90 volts from *Amp* to *Power* terminals. These voltages are found by subtraction of each voltage from the next higher value.

POWER UNIT, PLATE VOLTAGE TYPES

The currents in amperes are as follows: From *B-* to *Det*, .005 ampere assumed value. From *Det* to *Amp*, .005 ampere plus .001 ampere to detector, making total of .006 ampere. From *Amp* to *Power*, .006 (the preceding total) plus .006 ampere for the three tubes each drawing .002 ampere, making a total of .012 ampere.

For the resistor between *B-* and *Det*, using the formula, we have 45 (volts drop) divided by .005 (amperes carried), giving 9,000 ohms required resistance. For the resistor between *Det* and *Amp* we have 45 (volts drop) divided by .006 (amperes carried), giving 7,500 ohms resistance required. For the resistor between *Amp* and *Power* we have 90 (volts drop) divided by .012 (amperes carried), giving 7,500 ohms required resistance. The three resistances are thus found to be 9,000 ohms, 7,500 ohms and 7,500 ohms. Any other case may be calculated in a similar manner.

Voltage Regulating Tube.—The changes of voltage in one part of the output circuit of a power unit with change of load, of resistance of voltage in another part may be avoided by the use of

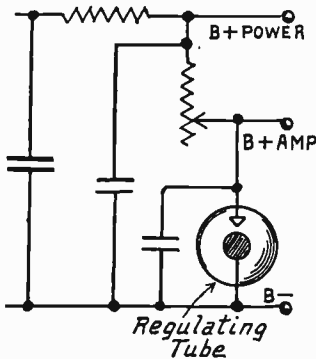

FIG. 3.—Voltage Regulator Tube on Intermediate Plate Voltage.

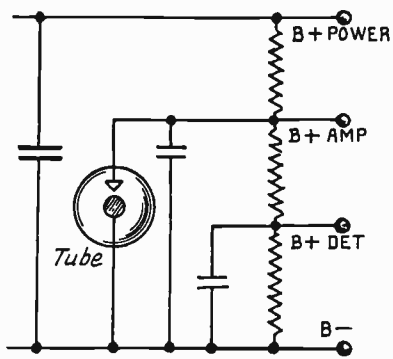

FIG. 4.—Regulator Tube in Unit with Three Plate Voltages.

what is called a voltage regulating tube. The purpose of such a tube is to absorb power, to absorb all of the power that is not required by the receiver at any instant. The use of a voltage regulating tube allows the power supply unit to deliver an unchanging amount of power at all times. The receiver takes whatever it needs of this power and the balance is taken automatically by the voltage regulating tube. Changes of voltage make a decided change of current through this tube.

These regulating tubes are designed so that a certain voltage across their terminals will cause a flow of current between the anode and cathode elements of the tube. As a greater voltage is impressed across the terminals of the tube there will be a greater flow of current through it. If such a tube follows a filter which delivers a constant output in watts, the additional flow of current through the regulating tube instantly drops the voltage across its terminals. In practice the tube takes sufficient current to maintain a voltage

POWER UNIT, PLATE VOLTAGE TYPES

across its terminals which does not vary by more than three or four per cent within the operating limits of the tube.

Of course if an excessively high voltage should be applied to the tube it will take only its rated maximum flow of current and its terminal voltage will rise after this value of current has been reached.

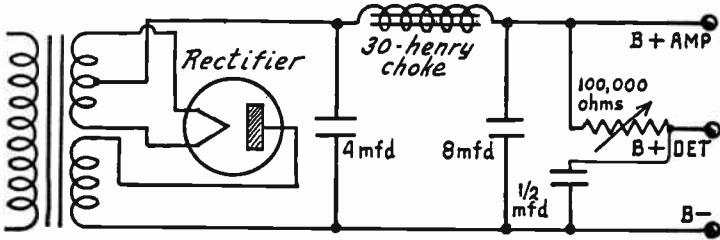

FIG. 5.—Half Wave Rectifier with Single Choke in Filter for Plate Voltage Supply.

When such a tube is inserted as in Fig. 3 between the negative side of the power supply circuit and a tap from which it is desired to take ninety volts, as an example, the total current from the power supply filter will remain the same at all times. Whatever current is required through the ninety-volt circuit of the receiver will flow through that circuit and the difference between the receiver current and the total output current will pass through the regulating tube since the voltage across the tube's terminals must remain at ninety. This tube performs another valuable service in bypassing any remaining ripples which are caused by slight variations of voltage through the filter. A power tube circuit is shown in Fig. 4.

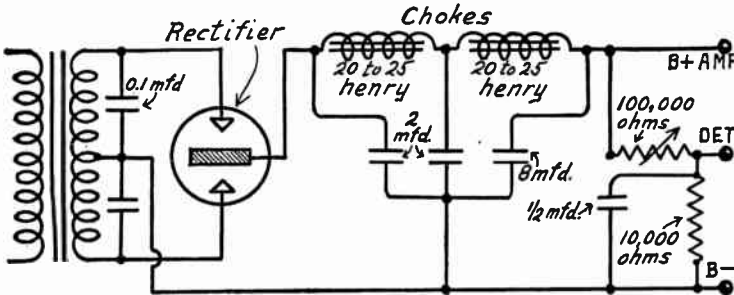

FIG. 6.—Full Wave Rectifier with Two Chokes in Filter.

Types of Plate Voltage Units.—Fig. 5 shows the connections for a half-wave rectifier using a single tube. This tube may be any of the types mentioned under *Power Unit*. While the filter shown is fairly satisfactory, any other filter circuit may be substituted. The same advice applies to the voltage regulating resistances, either the one shown may be employed or this may be replaced with any of those in preceding diagrams.

POWER UNIT, PLATE VOLTAGE TYPES

The unit of Fig. 6 uses a single tube of the full-wave type in connection with one of the most popular filter circuits. Here again it is possible to substitute other filters and if more than two plate voltages are wanted they may be secured by the use of any voltage control method shown in Figs. 1 and 2.

In Fig. 7 is shown a full-wave arrangement formed by two half-wave rectifier tubes on one transformer. There is practically no other difference between this unit and the one of Fig. 6.

Fig. 8 shows the use of a full-wave rectifier tube of the type employing two filaments and one plate. This style of rectifier is equivalent in action to the tube of Fig. 6. Any type of filter and voltage

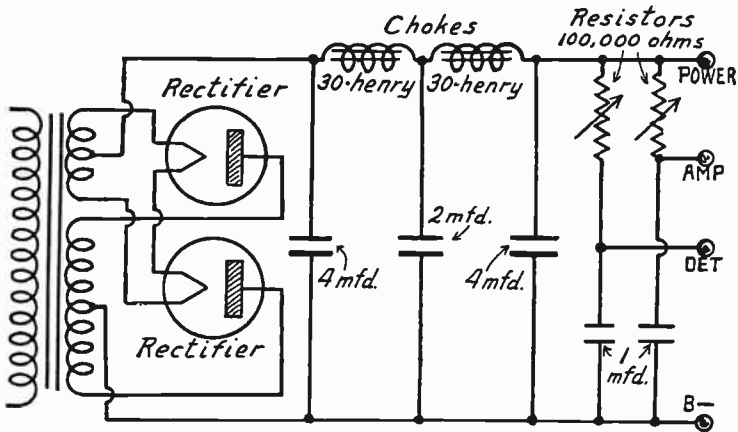

FIG. 7.—Two Half Wave Tubes Used for Full Wave Rectification in Plate Voltage Unit.

control arrangement may follow this rectifier tube. As drawn, the filter employs one choke in the positive line and another similar choke in the negative line. This method is often used as an alternative to the one placing all chokes in one side of the filter circuit.

In Fig. 9 are shown the connections for using two standard transformers and two full-wave rectifier tubes, such as Raytheons, so that the rectifiers act in series to practically double the output voltage. The transformers and tubes are the same as those shown in Fig. 6. The chokes in the filter may be of standard construction but the filter condensers must be able to stand the extra high voltage. Any type of voltage control resistor arrangement may be used with this outfit, such controls being shown in Figs. 1 and 2.

Switch controls for power units in various combinations are shown under *Jacks and Switches, Uses of*.

Grid Bias from Plate Voltage Units.—Any desired grid biasing voltage may be secured from a plate voltage unit by providing a negative biasing terminal or terminals at a lower voltage than

POWER UNIT, PLATE VOLTAGE TYPES

the B— terminal which is connected to the negative end of the filament circuit.

The negative terminal of the power unit forms the negative biasing terminal. Between this terminal and the one used as the B— terminal a resistance is connected as in Fig. 10. The entire plate

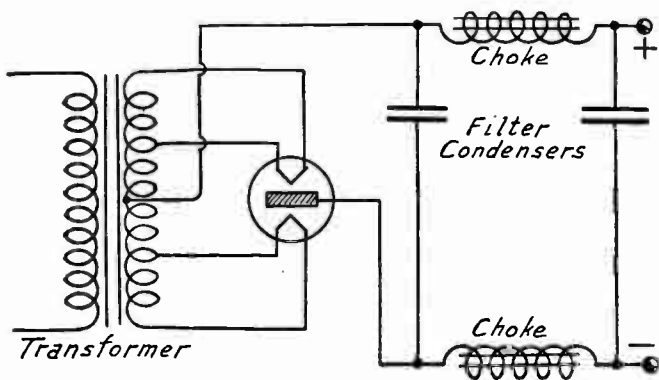

FIG. 8.—Full Wave Rectifier with Chokes in Both Lines.

current for the receiver passes through this resistance, consequently there is a drop of voltage across it. This voltage drop depends on the number of ohms resistance and the number of amperes of current flowing through the resistance. The voltage is equal to the number of ohms multiplied by the number of amperes. The re-

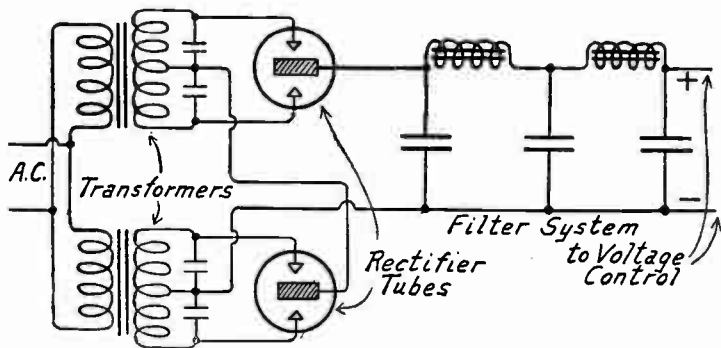

FIG. 9.—Two Standard Rectifiers and Transformers in Series for High Voltage Plate Supply.

quired resistance is equal to the number of volts divided by the number of amperes.

As an example, supposing it is desired to provide a negative bias of twenty volts from such a circuit. The current is first measured. It might be ten milliamperes, or 0.010 ampere. Dividing the required voltage, 20, by the cur-

POWER UNIT, VOLTAGE REGULATOR FOR

rent in amperes, 0.010, gives 2,000 as the required number of ohms resistance. A variable resistance unit may be used so that the number of ohms may be made of any required value.

If two biasing voltages are needed, the resistance is made in two parts as in Fig. 11. The first or lesser negative voltage will depend on the number of ohms resistance in the unit between the B— terminal and the first biasing tap. The greater negative biasing voltage will depend on the total resistance in ohms of both parts. The voltage drop is found by multiplying the number of ohms by the number of amperes.

Assume that the biases are to be six volts and fifteen volts. The current is measured. Assume the current to be fifteen milliamperes or 0.015 ampere. To find the value for the first part of the resistance, the first voltage, 6, is divided by the number of amperes, 0.015. The result is 400, this being the required number of ohms for the first part of the resistance.

To find the value for the second bias, the required voltage, 15, is divided by the current in amperes, 0.015, giving 1000 as the number of ohms. Since the first part of the resistance is 400 ohms, the second part must be 600 ohms so that the total resistance is 1000 ohms to provide the 15 volt bias. Any number of biasing voltages may be obtained in this manner.

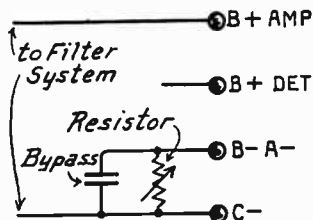

FIG. 10.—Grid Bias from Plate Voltage Supply.

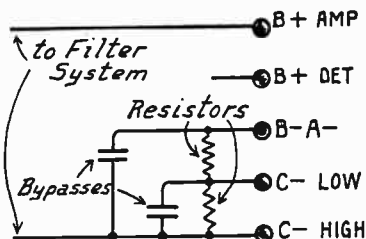

FIG. 11.—Two Grid Biases from Single Plate Voltage Supply.

It should be understood that the biasing voltage is subtracted from the total available voltage of the power unit. Thus, with a power unit capable of furnishing a maximum of 200 volts a bias of 20 volts taken off leaves the voltage remaining for application to the plate circuits as 200 less 20, or 180. With power tubes calling for high biasing voltages the subtraction may make quite a serious reduction in the plate voltage remaining. The power unit must be able to deliver a maximum voltage equal to the sum of the maximum plate voltage and the maximum biasing voltage.

As mentioned under *Power Unit, Filament Current Types of*, the biasing voltages for tubes with filaments in series are obtained by connecting the grid returns to various points in the filament circuit. See also *Bias, Grid, Methods of Obtaining*.

POWER UNIT, VOLTAGE REGULATOR FOR.—For the best operation of a receiver it is essential that the voltages supplied to the filament circuits and to the plate circuits be those at which the tubes will operate most efficiently. While a small change in the plate voltages will work no serious harm, changes in filament voltage will greatly affect the quality and general performance of the receiver while at the same time shortening the life of the tubes should they be operated at voltages much above normal values.

In many localities the power and lighting line voltage varies considerably

PRE-SELECTOR CIRCUIT

due to variation in the demand for current and to shortcomings in the generating and distributing system. On lines which are supposed to remain between 110 and 115 volts it is not uncommon to find the actual voltage running from 90 to as high as 130. With line voltage variations of any magnitude it is impossible to maintain the filament voltages within correct limits. These limits are from ten per cent below the rated voltage to five per cent above this value.

Many special arrangements are adopted to compensate for line voltage variation. One of the simplest methods is to provide the power transformer with several taps in the primary winding, the tap which gives nearest to correct output voltage being used. Adjustable or tapped resistors are sometimes used in the transformer primary circuit. Resistors, of course, can only lower an excessive voltage and cannot raise a voltage which is too low. Special ballast tubes have been made with a length of iron wire placed in the gas hydrogen. With current flow in excess of an amount determined by the iron size, this metal increases its resistance very rapidly and thus provides protection against excessive voltage.

To be satisfactory, a line voltage compensator should operate automatically according to the voltage impressed on it, should operate instantaneously or as quickly as changes take place in the supply voltage, and should be thoroughly reliable in action. Designs which are used include transformers with special windings, some bucking others. Use has also been made of the property of a magnetic circuit by which equal changes in magnetizing current produce unequal changes in flux, in other words saturation of the core.

The decided change in resistance in iron when a critical temperature is reached has been utilized by placing such a regulating resistance in the primary circuit of a transformer which is designed to operate normally on about seventy-five volts pressure. The resistor reduces the line voltage from a nominal 110 or 115 volts to the required lower voltage and by its automatic compensation holds the voltage applied to the transformer within quite narrow limits. The action of an iron wire resistor is shown under *Resistor, Filament Control*.

When any of these devices are used, the power unit is designed to operate correctly at the lowest expected voltage and the regulating system then reduces all higher values to this selected voltage.

PRE-SELECTOR CIRCUIT.—See *Circuit, Band Selector*.

PRESSURE, ELECTRICAL.—See *Electromotive Force*.

PRICK PUNCH.—See *Tools*.

PRIMARY WINDING.—See *Winding, Primary*.

PROTECTIVE DEVICES.—See *Fuses and Protective Devices*.

PUBLIC ADDRESS AMPLIFIER.—See *Amplifier, Audio Frequency Power Type*.

PULSATING CURRENT.—See *Current, Pulsating*.

PUNCH, CENTER AND PRICK.—See *Tools*.

PUSH-PULL AMPLIFIER.—See *Amplifier, Audio Frequency, Push-Pull Type*.

PYRITE CRYSTAL.—See *Detector, Crystal*.

Q

Q.—A symbol for quantity of electricity in coulombs or ampere-hours.

QUALITY, TONE.—See *Tone, Quality of*.

QUARTZ.—Quartz is one of the most desirable materials for use as a dielectric and insulator in parts carrying high frequency currents since it has very low losses at radio frequencies. Quartz is a mineral, a variety of silica which is found in crystalline masses. It may be clear and colorless or may be tinted with a variety of colors. The dielectric constant of quartz is between 4.5 and 5.0.

QUARTZ CRYSTAL CONTROL.—See *Crystal, Frequency Control by*.

R

R. r.—The symbols for electrical resistance. See *Resistance*.

RADIATING RECEIVER.—See *Reradiation*.

RADIATION.—The action by which radio waves are sent out from the aerial of a transmitter into space is called radiation. The exact means by which radiation takes place is still a subject for controversy and all explanations of this action are merely theories. Many of these theories are plausible and withstand the tests of close examination and experiment. But still they remain theories because they cannot be proven beyond a reasonable doubt.

Radiation differs from induction. With induction a current through a conductor causes a magnetic field to rise around the conductor. Then the collapse of this field causes a current in the conductor. Thus induction is an exchange of energy between the conductor and its magnetic field. The energy stays in the vicinity of the conductor. With radiation the energy sent into the conductor leaves it and does not return to that conductor.



FIG. 1.—Radiation of Sound Waves from Vibrating Body.

The emission of radio energy from an aerial may be compared with the emission of sound from any object which is set into vibration. Sound is transmitted in a series of compressions and rarefactions in the air very much as shown in Fig. 1. The air itself does not move from place to place in carrying the sound but only a changing condition of the air moves away from the source of sound and to the receiver of the sound. The alternate compression and rarefaction of the air may be represented by a wave form.

Radio energy passes through the ether which is assumed to be all pervading. The radio waves pass almost without loss of strength through all kinds of good dielectric. But when the radio waves try to go through a conductor of any kind their energy changes into electric currents which may be used to good purpose or which may simply be wasted as eddy currents. This explains one reason for the diminished strength of radio signals during daylight. The sunlight partially ionizes the air and any ionized gas is a conductor of a sort. The radio waves are thus dissipated by the conductivity of the ionized air.

RADIATION

The energy of a transmitter in its aerial consists of two parts, one electromagnetic and the other electrostatic. In the circuits of the transmitter, which include the aerial and ground, these two parts are ninety degrees out of phase and therefore oscillate back and forth. As in any oscillatory circuit, either form of energy will change into the other. The energy is first in electromagnetic form, then in electrostatic form as it moves back and forth between the coils and the condensers.

According to one theory these two components of the radio energy leave the aerial out of phase but after traveling for a fraction of a wavelength they are in phase with each other as in Fig. 2. When in phase the two parts of the energy work together and are therefore freed from the need of conductors or condensers to contain or carry them. The radio wave then travels away through the ether, still including both electromagnetic and electrostatic components.

As the wave travels through space the inductive or electromagnetic part of its energy drops rapidly in strength, far more rapidly than the electrostatic part. The drop in the electrostatic part is only in direct proportion to the distance traveled while the electromagnetic part drops in proportion to the square of the distance.

In a certain sense the two parts of the energy support each other and carry each other along. It may be said that the electromagnetic portion of the wave provides the momentum driving the wave along its course while the electrostatic portion provides the needed elasticity between the parts of the wave which correspond to the compressions and rarefactions of a sound wave.

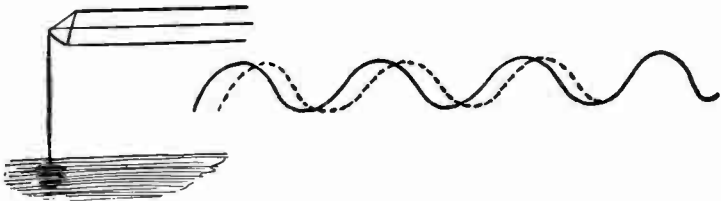

FIG. 2.—Phase Relations of Electromagnetic and Electrostatic Portions of Radiated Wave.

To produce a series of waves some kind of an elastic medium or body is required. For sound waves this body is the air. For water waves it is the water. For radio waves it is the ether. The radio waves are started by the vibrations in an oscillating electric circuit and they displace electricity somewhat in the manner that lines of force are assumed to act.

As already mentioned the strength of the inductive field diminishes rapidly with increasing distance from the antenna. With the usual elevated antenna the strength of the radiation field is greater than the strength of the inductive field at all distances greater than the wavelength in meters divided by 6.28. With the elevated antenna the strength of the radiation field is directly proportional to the frequency, while with a loop antenna the strength is proportional to the square of the frequency. This is the reason why high frequencies or "radio frequencies" are used for the carrier wave. The radiation field from a frequency of fifteen hundred kilocycles is 25,000 times as strong as the radiation field from sixty cycles. This advantage of the higher frequencies is somewhat reduced by

RADIO BEACON

the fact that the absorption of power from high frequency waves is greater than the absorption from low frequencies.

Radio waves act in a manner very similar to light waves. The radio waves appear to pass through some materials as though those materials were transparent. Other materials appear to reflect the radio waves just as light is reflected from a mirror. Still other substances seem to refract the radio waves just as light waves are refracted in passing through thick glass or through liquids. The reflection of radio waves forms one explanation of why these waves travel around the surface of the earth in place of moving away from the transmitter in perfectly straight lines which would soon bring them far above the earth's surface because of the curvature of this surface.

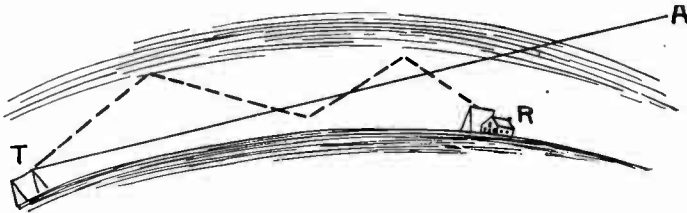

FIG. 3.—Reflection of Radiated Waves.

This idea is shown in Fig. 3. Radio waves leaving the transmitter *T* rise up until they strike the layer of ionized air a few miles above the surface of the earth. The waves are reflected from this layer as shown by the broken lines, coming back to the earth's surface to again be reflected. This continues until the reflected waves reach the distant receiver. Were the waves to pass away from the transmitter in perfectly straight lines, as along the line *T-A*, they would be far out of reach of the receiving station by the time they passed over it.

RADIO BEACON.—See *Beacon, Radio*.

RADIO COMPASS.—See *Compass, Radio*.

RADIO FREQUENCY.—See *Frequency, Radio*.

RADIO FREQUENCY AMPLIFIER.—See *Amplifier, Radio Frequency*.

RADIO FREQUENCY CHOKE.—See *Coil, Choke*.

RADIO FREQUENCY TRANSFORMER.—See *Transformer, Tuned Radio Frequency* and *Transformer, Untuned Radio Frequency*.

RADIO, HISTORY OF.—Some of the principal events in the progress of radio science are given here under the years in which they occurred.

1831.—Faraday discovered electromagnetic induction.

1840.—Henry produced high frequency oscillations and pointed out that a condenser discharge is oscillatory.

1867.—Maxwell explained the theory of electromagnetism and predicted the existence of electric waves as now used in radio.

1870.—Von Bezold found that oscillations from a condenser discharge cause interference.

1877.—Microphone invented by Emile Berliner.

1879.—Hughes discovered the phenomena on which depends the action of the coherer, a kind of detector.

RADIO, HISTORY OF

1882.—Professor Dolbear secured a patent on wireless apparatus and predicted that communication might be established between points more than a half mile apart.

1883.—Fitzgerald suggested a method of producing electromagnetic waves in space.

1885.—Preece maintained telephonic speech between two insulated circuits one quarter of a mile apart.

1887.—Hertz founded the theory upon which all modern radio is based. Heaviside established communication between the earth's surface and an underground chamber.

1892.—Preece established communication between two points by uniting conduction and induction. Branly devised the coherer, an early form of detector.

1896.—Marconi communicated over a distance of $1\frac{3}{4}$ miles. Directional reflectors were demonstrated.

1897.—Marconi maintained communication first up to 4 miles, then 10 miles, and then $14\frac{1}{2}$ miles. Signals were received at Bath, England, from Salisbury, 34 miles away.

1898.—First use of radio by a newspaper; Dublin, Ireland.

1899.—British warships exchanged messages at a distance equal to 85 land miles.

1900.—DeForest was granted numerous radio patents.

1901.—Marconi received the letter "S" at St. Johns, Newfoundland, from Poldhu, England, a distance of 1800 miles.

1902.—Signals were received by steamship *Philadelphia* up to a distance of 2099 miles from the Poldhu station.

1904.—The first press message was transmitted across the Atlantic. Dr. Fleming took out his original patent on the vacuum tube.

1906.—DeForest was granted a patent on a vacuum tube rectifier, the audion. Dunwoody discovered the rectifying property of carborundum and Pickard discovered this property in silicon, both of which form crystal detectors.

1908.—Professor Fessenden maintained radiophone communication between Brant Rock, Mass., and Washington, D. C., about 600 miles.

1910.—A steamship received messages at a distance of 6735 miles from their source.

1911.—Radio service was organized in the Department of Commerce and Labor.

1914.—The French and American Governments experimented between Paris and Washington to compare the speed of electromagnetic waves with that of light. Radiophone experiments between ships were successful up to a distance of 44 miles and continued for twelve hours without interruption. Armstrong was issued a patent on the regenerative circuit.

1915.—The American Telephone and Telegraph Company, working with the Western Electric Company, telephoned from Arlington to Hawaii, nearly 5000 miles, and also from Arlington to Paris.

1918.—Radiophone communication progressed rapidly due to development of vacuum tubes for transmission and reception. The United States Government took over, with few exceptions, all land stations. Radio telegrams were sent from Carnarvon to Sydney, Australia, 12,000 miles away.

1919.—The war-time restrictions on private radio stations were removed.

1921.—Many American amateurs communicated with British amateurs on the short wavelengths in tests under the direction of the American Radio Relay League. The first broadcasting station licenses were issued.

1922.—Successful radiophone communication was maintained from ship to land stations up to 400 miles.

1923.—Professor Hazeltine was granted a patent on his Neutrodyne circuit. The Westinghouse station at Cleveland successfully repeated short-wave signals from the Pittsburgh station, KDKA. Great progress was made in the development of vacuum tubes, and in the use of short wavelengths. Many foreign

RADIO LAWS

countries took up broadcasting, American broadcasts were heard in England and English broadcasts were heard here. Station KDKA transmitted a short-wave program to Great Britain.

1924.—A concert sent from station KDKA was relayed from London and heard in Calcutta, India. The ship *Arctic* reported reception of messages within 11° of the North Pole. Signals from the Pittsburgh station were repeated from a station in Cape Town, South Africa.

1925.—The Pittsburgh and Hastings, Nebraska, stations of the Westinghouse Electric & Manufacturing Company showed that short-wave transmission could be picked up and relayed at its original power or greater power from repeater stations. Radio transmission of pictures was demonstrated clearly. Experiments were conducted with piezo-electric crystals for frequency control.

1926.—Commercial radiophone service was experimented with between New York and London, being later put into regular operation. The single control receiver gained popularity. The United States Attorney General rendered an opinion that the Secretary of Commerce has no jurisdiction as to wavelength or power used by broadcasters, many of whom changed frequency and power.

1927.—The number of broadcasting stations increased to 733 in the United States. A law was passed providing for control of radio by a commission of five men. After the first year the commission will act only in the settlement of disputes, direct control being given to the Secretary of Commerce.

1928.—Television became popular with experimenters and several stations commenced television broadcasts. Receivers completely operated from A. C. supply lines were accepted by the public. Chain broadcasting developed greatly and station powers were greatly increased. The Radio Commission began rearrangement of broadcast allocations according to definite plans. Wired radio became popular in some localities.

RADIO LAWS.—See *Law, Radio*.

RADIO, PRINCIPLES OF.—A radio broadcasting station or any other radio transmitter consists of devices which are designed to send electricity out onto a wire or collection of wires called the aerial and to make the electric impulses leave this aerial and travel away through space.

One end or one terminal of the apparatus in the broadcasting station is connected to the aerial as shown in Fig. 1 and the other end is connected to the earth or to ground. The electric impulses act between the aerial and the ground to produce radio waves which leave the aerial and ground combination and pass out from the station with the speed of light. The speed of light is approximately 186,000 miles per second so it doesn't take the radio waves or radio signal very long to travel from the transmitter to all the radio receiving sets within range.

Various qualities of electricity may be measured in various units just as various properties of steam or water or any other medium for carrying energy may be measured in suitable units. The two measures of electric energy most commonly used are those called volts and amperes, just as the two most commonly used units in talking of water power are pressure in pounds to the square inch and gallons of flow per minute.

Just as pounds per square inch measure the hydraulic pressure of water so do volts measure the electrical pressure of electricity. And just as gallons per minute measure the rate of flow of water through a pipe, so do amperes measure the rate of flow of electricity through a wire. We measure water pressure with a pressure gauge and we measure electrical pressure with a voltmeter. We measure water flow with a water meter and we measure electrical flow with an ampere meter or ammeter.

RADIO, PRINCIPLES OF

It is necessary to understand that volts and voltage in electrical work refer only to electrical pressure and have nothing to do with the quantity of electricity or its rate of flow. Water pressure is measured in pounds per square inch, although the water may not be flowing or moving at all. Just so with electricity; its pressure may be measured as so many volts although there may be no electricity flowing. It is equally necessary to realize that amperes and amperage refer only to the flow of electricity, to the amount that is passing a given point in a circuit, and do not in any way measure the pressure on the electricity.

In explaining radio sending and receiving it will be necessary to refer frequently to the voltage and to the amperage of the electricity. It will be necessary also to refer to the frequency of the electric current. Except for the current used on parts of the vacuum tubes and for the current sometimes used to light these tubes, the electric currents in radio are alternating currents, as alternating current is a current that reverses its direction periodically, flowing first in one direction then in the other direction.

The number of times the electric current goes through a complete change of direction in one second is called the frequency of the current. If the electricity or the electric current flows in one direction sixty times during one second and also flows in the opposite direction sixty times in the same second, it has gone through sixty complete changes or sixty complete cycles. This current is then said to have a frequency of sixty cycles, meaning sixty cycles or complete changes per second. Electric current generally used for lighting and power has a frequency of sixty cycles.

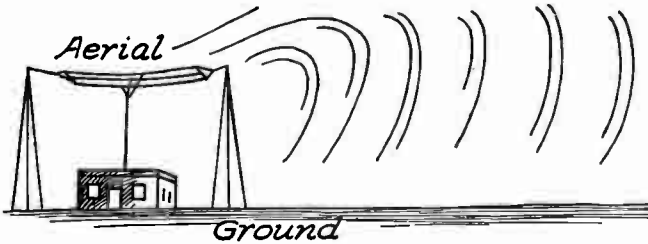

FIG. 1.—Radio Waves from an Aerial.

Radio Waves.—The impulses of electricity sent out from the broadcasting station are not of high voltage and are of very small amperage. But they are of extremely high frequency. The lowest frequency used by a broadcasting station is one of 550,000 cycles per second and the highest broadcasting frequency is 1,500,000 cycles. It is difficult to comprehend the tremendous rapidity of these changes in direction of the current, yet even these frequencies are very low when compared with the frequencies used by amateur transmitters. In these amateur sending sets we find frequencies running into hundreds of millions of cycles per second.

In making one complete cycle the voltage rises from zero to maximum in one direction, then falls to zero, rises to maximum in the other direction and again falls back to zero ready to start over again. Of course the current does likewise. These rises, falls and reversals may be represented as shown in Fig. 2 and this kind of a wavy line is generally used to represent the radio waves sent out from a broadcasting station.

Modulation.—The human ear can distinguish as sounds all vibrations having frequencies between about sixteen per second and

RADIO, PRINCIPLES OF

fifteen thousand per second. Frequencies greater than these do not affect the average ear as sounds. If we were able to make the radio waves, at their great frequency, affect a telephone receiver, the ear listening at that receiver would hear nothing at all because in place of being below fifteen thousand vibrations per second the vibrations would be well up into the hundreds of thousands per second. Therefore it is necessary to use modulated radio waves.

The waves of Fig. 2 are all of the same height and depth above and below the zero line. This indicates that the rises of voltage and amperage are equal to the drops of voltage and amperage and also that they never change their voltage or amperage.

By means of apparatus called the modulator in the transmitting station the voltage and current in the wave of Fig. 2 are caused to gradually rise and fall as shown in Fig. 3. Fig. 2 represents what is called the carrier wave, while Fig. 3 shows the modulated carrier wave.

The modulations themselves have frequencies, but these frequencies are low enough to be audible to the ear. In the broadcasting station the sounds of voices or instruments are allowed to

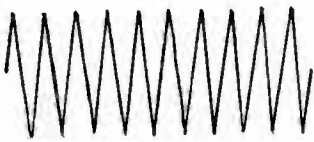

FIG. 2.—Representation of Radio Wave.

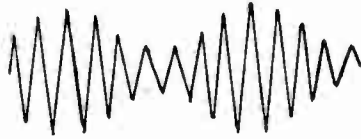

FIG. 3.—A Modulated Radio Wave.

affect an electric circuit just as a voice will affect the electric circuit through a telephone. These changes, at audible frequency, are impressed on the carrier wave so that its voltage and amperage are made to rise and fall to correspond with the rise and fall of the sounds going into the microphone of the broadcasting station.

We now have a modulated carrier wave going out from the aerial system of the transmitter in the broadcasting station and traveling with the speed of light to points many miles distant where the carrier will affect the antenna of a radio receiver. It is next in order to look into the processes whereby this modulated carrier wave is caused to operate a loud speaker at the receiving end.

The Oscillatory Circuit.—The foundation of radio is a peculiar electric circuit called an oscillatory circuit. This circuit consists of a coil of wire having its two ends connected to a number of metal plates called a condenser. The coil of wire gives us an electrical property called inductance. The metal plates of the condenser are separated from each other by insulating material called the dielectric of the condenser. This arrangement gives the condenser another electrical property called capacity or capacitance.

RADIO, PRINCIPLES OF

The coil and condenser combination which forms an oscillatory circuit is shown in Fig. 4. If the electric current is caused to flow in such a circuit, some very strange things take place. As the electric current passes through the coil it causes the coil to act like a magnet and a magnetic field forms itself about the coil. This magnetic field is composed of invisible lines called magnetic lines of force. Practically all of the energy originally in the form of electric current finally appears as a different form of energy in the magnetic field of the coil. The inductance of the coil has had the effect of stopping the flow of current and of changing the energy of the current into a magnetic field.

Unless a magnetic field is formed by a permanent magnet of steel or by a steady current of electricity flowing through a coil the magnetic field cannot long continue to exist. In the coil of Fig. 4 the flow of current has been practically stopped and there is nothing to maintain the magnetic field. Consequently the field collapses, disappears or seems to go back into the coil.

As the magnetic lines of force drop back through the wires forming the coil they set up a new electric current in the coil. Now the magnetic energy has changed back to electric current. The current flows through the coil winding and through the connections over to the condenser.

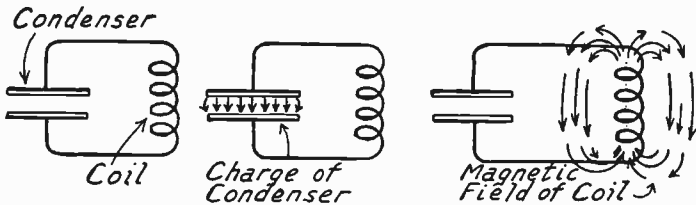

FIG. 4.—An Oscillatory Circuit and Its Action.

The plate or plates of the condenser to which the current is flowing soon are given a surplus of electricity, they have more than their normal amount of electricity. While current is flowing toward one set of plates it must be flowing away from the other set of plates so this other set finally has a deficiency of electricity, less than the normal amount.

The plates of the condenser have now been charged. The plates that have more than enough electricity are said to have a positive charge while those that have too little electricity are said to have a negative charge. The condenser is the only device that actually stores electricity in its original form. A storage battery does not store electricity but only provides materials which are changed chemically by a flow of electric current through them so that they may produce another electric current when the chemical change is reversed. The condenser however actually stores a charge of electricity on its plates.

Assuming that one set of plates in the condenser has a charge of positive electricity and the other set has a charge of negative electricity, it may be realized that these two charges are going to come

RADIO, PRINCIPLES OF

together and neutralize each other. The charges come together as the positive charge flows from the condenser around through the coil to the other set of plates. Both sides of the condenser are then again in a normal condition. But, as the electric current from the condenser flows through the coil another magnetic field is built up and so the action goes on.

The energy oscillates or swings back and forth between the coil and the condenser and it keeps on oscillating until all the energy has been dissipated by the resistance in the parts of this oscillatory circuit. If the action of an oscillating circuit is understood, many of the apparently mysterious actions in radio will lose their mystery and be easy to understand.

Getting the Energy Started.—In the foregoing explanation of the action that takes place in an oscillatory circuit it was taken for granted that an electric current was flowing in the circuit to start with. Naturally enough something must be done to get this current started.

Fig. 5 starts off with the same oscillatory circuit shown in Fig. 4, that is, a circuit composed of a condenser and a coil. In place of the small condenser it is possible to use a very large condenser with

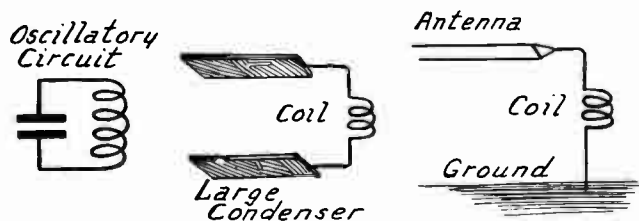

FIG. 5.—Oscillatory Circuit Formed by Antenna and Ground.

large plates placed far apart. The air between the plates forms the dielectric of this condenser. Between the plates of this large condenser is connected a coil just as in Fig. 4. The oscillating action between this new combination of a large condenser and small coil is no different from the action in any other oscillatory circuit as already described.

Now another change will be made in the coil and condenser. The upper plate of the condenser is replaced, at the right hand side of Fig. 5, by an antenna composed of one or more long wires suspended some distance above the earth. The lower plate of the large condenser has been replaced by the earth itself. Between these two parts, which form the two plates of a condenser, is connected the small coil.

In Fig. 6 a radio transmitting station is represented at the left while the antenna, ground and coil combination is shown at the right. The aerial of the transmitting station is sending out energy in the form of radio waves. These waves finally reach the condenser formed by the antenna and ground. As the waves pass through the condenser's dielectric, which is composed of the air between the antenna and ground, they set up an electrical stress in this air. The result is a charge on the antenna.

RADIO, PRINCIPLES OF

The antenna charge flows through the coil to ground and in passing through the coil produces an electromagnetic field whose energy eventually may be used to produce sound from a radio receiver. This gives the initial energy for operating a receiver and it is possible to build a practical receiver which requires no other energy than that received through the air from a distant transmitting station.

Transfer of Energy from One Circuit to Another.—At one time or another everyone has used a small magnet with which to attract and hold pieces of iron or steel. A wire nail may be laid

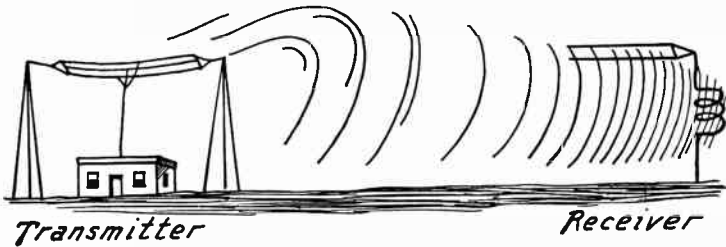

FIG. 6.—Transfer of Energy from Transmitter to Receiver.

upon a table top and a magnet slid along the table toward the nail. While the two are still some distance apart the nail will jump to the magnet. This proves that there is some invisible force acting between the magnet and the nail. This force is magnetism and it exists as a magnetic field formed by magnetic lines of force around the magnet. The nail jumps to the magnet because it is easier for these lines of force to travel through iron than through air and by the nail's attaching itself to the magnet the magnetic field of the

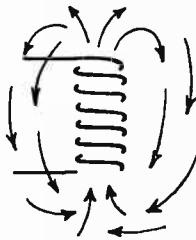

FIG. 7.—Electromagnetic Lines of Force Around a Coil.

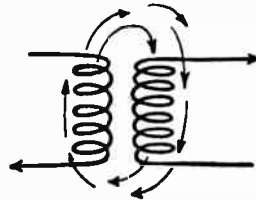

FIG. 8.—Two Coils Coupled by Induction.

magnet has been made to include more iron and less air through which to flow.

A coil through which is flowing an electric current acts in every way like a magnet. The magnetic effect produced by a coil of wire is called electromagnetism and the lines of force about the coil are called electromagnetic lines of force. These lines follow paths as shown in Fig. 7.

Fortunately it is a fact that a flow of current through a coil will produce a magnetic field about the coil and also that a magnetic field which is in motion around a coil will produce an electric current in the winding of the

RADIO, PRINCIPLES OF

coil. If a second coil is brought near the coil of Fig. 7 so that the second coil is within the electromagnetic field of the first one, an electric current will be caused to flow through the winding of the second coil as in Fig. 8. This action is called induction. The two coils are said to be coupled.

In Fig. 9 we have taken the antenna, the ground and the coil as shown in Fig. 6 and have coupled the antenna circuit coil to another coil so that the energy received through the antenna by the first coil is transferred over into the coupled coil. The broken lines represent part of the cabinet of a radio receiver and the two coupled coils represent the first two coils in the receiver to be built up.

Into this receiver will come the voltage changes represented by the modulated carrier wave of Fig. 3. The rises and falls of voltage will follow exactly the rises and falls sent out from the transmitter, the only change being that the pressure or voltage is almost unbelievably small. The greater the distance of the receiver from the transmitter, all other things being equal, the weaker will be the voltage of the received impulses at the receiver. The received impulses are measurable only in millionths of a volt.

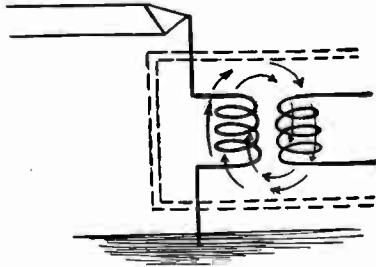

FIG. 9.—Coupled Coils as First Circuit in Receiver.

Resonance.—Because the received energy is so small to begin with, every precaution must be taken not to lose any more of it than absolutely necessary. Electrical energy of any kind is lost as it passes through resistance because in the resistance the electrical energy is changed into heat. All materials have more or less resistance to the flow of electricity. If their resistance is very small, the materials are called conductors. All metals are conductors, copper and silver having the least electrical resistance. If the resistance of a material is very great it is called an insulator and is used to prevent the flow of electricity into places where it should not go.

Ordinary resistance is the only thing that tends to stop the flow of electricity and turn its energy into heat when the electricity flows as a direct current. A direct current is a current whose voltage and amperage neither rise nor fall and which never reverses its direction but always flows in the same way.

When we handle alternating currents, as in radio work, we have another effect called reactance. This reactance exists in condensers and in coils. Its effect on an alternating current is similar to the effect of resistance in reduc-

RADIO. PRINCIPLES OF

ing the voltage and amperage of the current. Alternating currents are also affected by resistance just as direct currents are affected. The combination of resistance and reactance, both opposing the alternating current, is called impedance.

In order to preserve the minute strength of the radio signal voltage we must reduce the impedance. That is, we must reduce the resistance by using good conductors and we must also reduce the reactance of the coils and condensers.

Now it is perfectly evident that it is going to be more difficult to produce a large magnetic field around a large coil than the smaller field around a small coil. Also it is going to be harder to charge a big condenser than a small one. By a big condenser we mean one with its plates of large size or with many plates.

A current of high frequency changes its direction at such short intervals that it has not sufficient time to fully magnetize a large coil or to fully charge a large condenser. Large coils and large condensers thus respond more easily to currents of low frequency. This is not a complete explanation of the reasons for this effect, but it makes a preliminary understanding easier to grasp than would be the case when going into all the details affecting reactance.

In order to form an oscillatory circuit we must have inductance in a coil and capacity in a condenser. But we want to use such values of inductance and capacity that the reactance will be the lowest possible for the frequency of the carrier wave being received. To obtain maximum current and voltage from a given frequency and still have the lowest reactance we may use a large coil and small condenser, a small coil and a large condenser, or a medium size coil and a medium size condenser. It is the product of the inductance multiplied by the capacity that counts. For each frequency there is a certain product that gives best results. This product may be obtained either by using large or small coils or condensers, just so the other unit is of a size to give this necessary product.

When the condenser capacity and the coil inductance multiplied together give a value such that a certain received frequency meets the least possible reactance the coil and condenser circuit is said to be resonant to this frequency. By producing resonance we can practically eliminate the effect of reactance, leaving only the resistance to oppose the flow of alternating current. When this condition is reached, the condition of resonance to the frequency being received, the small impulses received from the antenna will do their best possible work in the receiver.

Tuning.—Different broadcasting stations send out their signals at different carrier wave frequencies. This is the difference between the signals of different stations that makes it possible to receive one station while excluding another. In the words usually used, we tune in one station and tune out another.

Tuning is done by adjusting either the inductance or the capacity of the oscillatory circuits in the receiver so that they become resonant to the frequency we desire to receive. While resonant to one frequency, the coil and condenser combination will offer very high impedance to all other frequencies, and thus the receiver is tuned to only one station at any one time.

Tuning is generally done with a condenser whose capacity may be gradually changed by turning dials or control knobs on the panel

RADIO, PRINCIPLES OF

of the receiver. The coil inductance is allowed to remain at a fixed value at all times. It is possible, and is just as effective, to use a condenser whose capacity remains fixed and change the inductance of the coil in the oscillatory circuit. When either a condenser capacity is variable or a coil inductance is variable the fact is indicated in circuit diagrams by drawing an arrow through the usual symbol for the condenser or the coil. This is shown in Fig. 10.

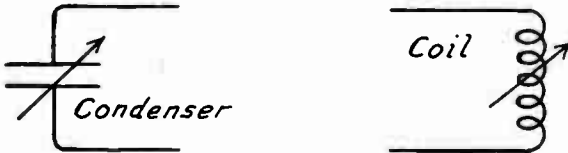

FIG. 10.—Variable Condenser and Variable Inductance Coil.

Now we are ready to take one more step in the construction of the receiver started in Fig. 9. In Fig. 11 the antenna is shown by the accepted symbol for an antenna and the earth or ground connection is shown by the symbol for ground. The two coils are coupled in Fig. 11 just as in Fig. 9. But in Fig. 11 we have connected a variable condenser across the second coil, making it possible to tune this second circuit to resonance with any carrier wave to be received.

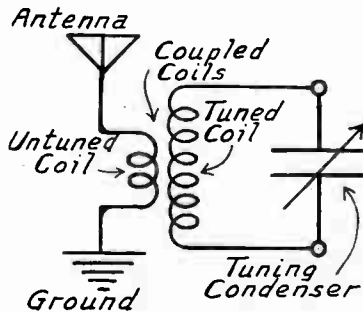

FIG. 11.—Tuned Circuit Coupled to Antenna Circuit.

As previously explained the coil in the antenna circuit together with the capacity of the antenna produce an oscillatory circuit. In Fig. 11 this antenna circuit is not tuned with a variable condenser nor with a variable inductance coil. The reception would be stronger were the antenna circuit tuned but in order to reduce the number of receiver controls we usually use an untuned or an aperiodic antenna circuit as shown in Fig. 11. In actual practice the coil in the tuned circuit is very large in comparison with the untuned coil in the antenna circuit, say about fifty turns on the tuned coil to four or five turns on the untuned one. The effect of the large coil is so overpowering on the small one that the antenna circuit is partially tuned to the resonant frequency of the tuned second coil.

RADIO, PRINCIPLES OF

Now we have coupled a tuned circuit to the antenna circuit and the voltage impulses in this coupled circuit will be quite strong when it is resonant to the frequency to be received.

Detection.—Even though we have a gradual rise and fall of the modulated carrier wave shown in Fig. 3, we still have a high frequency alternating current. And such an alternating current won't affect a telephone receiver or a loud speaker, which is built on the same principle. A loud speaker consists of a diaphragm which is moved by a small electromagnet. Changes of current in the windings of the electromagnet cause the diaphragm to move and this movement of the diaphragm moves the air to produce audible sound waves.

If the alternating current is run through the magnet winding of a loud speaker, the diaphragm will be pulled first one way and then the other with such rapidity that it hasn't time to move far enough in either direction to produce sounds. In order to let the speaker do its appointed work it is next necessary to change the alternating current into a unidirectional current, into a current that always flows in the same direction even while its voltage and amperage rise and fall. One way of doing this is by cutting off half of the wave of Fig. 3, leaving the other half as in Fig. 12. This is done by the part of the receiver called the detector.



FIG. 12.—Half of Modulated Carrier Wave.



FIG. 13.—A Crystal Detector and Its Symbol.

One of the simplest forms of detector is that called the crystal detector. It is a one way electrical valve which lets current flow through practically unhindered in one direction but greatly hinders or stops the flow in the other direction. The crystal consists of a small piece of some mineral such as galena or iron pyrites, with the tip end of a fine wire resting on the surface of this mineral or crystal. Current will flow through this combination in one direction but is stopped when trying to flow in the other direction. A crystal and its symbol are shown in Fig. 13.

By adding this crystal and a pair of headphones or telephone receivers to the circuits of Fig. 11 we will have produced Fig. 14 which represents a complete radio receiver of the simplest type, but one which will actually receive and render audible the programs from nearby broadcasting stations. The voltages oscillating between the coil and tuning condenser are impressed on the circuit containing the crystal and the phones. The crystal rectifies, demodulates, or detects the signals so that the average rise and fall of voltage in the carrier wave will move the diaphragms of the phones. The sounds going into the broadcaster's microphone are now reproduced in the headphones of the crystal receiver.

The Vacuum Tube as an Amplifier.—It is perfectly true that the crystal receiver of Fig. 14 will make it possible to listen to broadcast programs, but this receiver has no energy to work with

RADIO, PRINCIPLES OF

except that coming in over the antenna. This energy is so small that it will not operate a loud speaker nor will it make possible the reception of signals from a broadcaster more than a few miles away.

To be able to listen to distant stations and to operate a loud speaker we must strengthen or amplify the incoming signal strength. For many years there were no successful means of amplifying or strengthening the signal. This condition of things remained until the invention of the vacuum tube which has made modern radio reception possible and enjoyable. The vacuum tube easily ranks as one of the greatest advances in modern electrical science.

This tube consists of a glass bulb about the size of a small electric lamp bulb. Below the glass bulb is a cylindrical base from the bottom of which protrude four contact pins. Inside the bulb are three parts made of metal, these parts being called the filament, the plate and the grid. After the parts of the tube are assembled the air is pumped out before the glass part is sealed, this leaving a vacuum inside the tube.

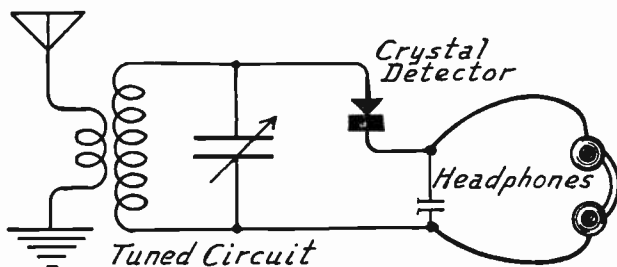

FIG. 14.—Detector Connected to Tuned Circuit, Forming a Receiver.

Near the center of the tube is the filament. The filament is made of thin wire which extends from bottom to top of the bulb or which forms an inverted "V" with its point at the top and the two ends at the bottom. Wound around the filament, but not touching the filament at any point, is a coil or network of fine wire which is called the grid. Around the outside of both filament and grid, but not touching either one, is a sheet of thin metal which is called the plate. These parts are shown in Fig. 15 at the left. At the right of Fig. 15 is the symbol for this three-electrode vacuum tube.

Two of the pins coming out from the bottom of the tube base are attached to the filament, the third pin is connected to the grid, and the fourth pin is connected to the plate. It will be seen that the symbol indicates the position of the grid between the filament and the plate.

Many years ago it was discovered that a peculiar action may take place when a wire filament and a metal plate are enclosed in a glass bulb from which the air is exhausted. In this combination, shown by Fig. 16, the filament is connected to a battery from which current flows through the filament and causes it to become red hot or white hot in the same way that the fila-

RADIO, PRINCIPLES OF

ment of an ordinary electric light bulb glows white hot when current flows through it.

When another battery is connected with its positive or high voltage side leading to the enclosed plate of Fig. 16 and the negative or low voltage side of this extra battery attached to the hot filament, there is a flow of electric current from the plate to the heated filament through the vacuum inside the tube.

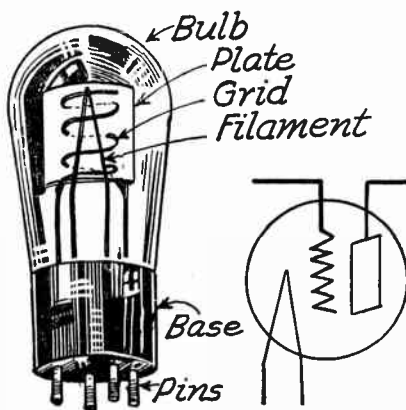

FIG. 15.—The Vacuum Tube and its Symbol.

This plate current is secured from the battery connected between the plate and the filament. This plate battery is entirely separate from the battery used to heat the filament. If the filament is allowed to become cold, no ordinary voltage applied to the plate will cause any flow of current, but just the instant the filament temperature rises above a certain point the flow of current

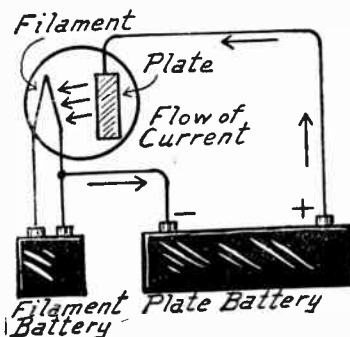

FIG. 16.—Current Flow from Plate to Filament in Vacuum Tube.

from the plate battery commences. In Fig. 16 the amount of current flowing in the plate circuit depends principally on the voltage of the battery connected to the plate, the higher the voltage the greater being the flow of current.

If the two-electrode or two-element vacuum tube of Fig. 16 is changed by the addition of the grid between filament and plate, we are able to control

RADIO, PRINCIPLES OF

the flow of plate current not only by changing the voltage of the plate battery but also by the effect of any voltages applied to the grid.

The receiver of Fig. 14 may now be changed by inserting the vacuum tube between the crystal circuit and the tuned circuit containing the coil and the variable condenser. We then have the arrangement of Fig. 17, a practical one-tube receiver.

The voltage from the tuned circuit which was applied to the crystal of Fig. 14 is now applied to the grid of the vacuum tube. The crystal detector and the headphones are now connected between the plate of the vacuum tube and the plate battery. The filament lighting battery is connected to the filament just as in Fig. 16.

Whenever a voltage being applied to the grid drops to a lower value, the grid acts to lessen the flow of current in the plate circuit. Whenever the voltage applied to the grid rises, the flow of plate current increases. The rise and fall of voltage being applied to the grid is thus followed exactly by rise and fall of current in the plate circuit of the vacuum tube.

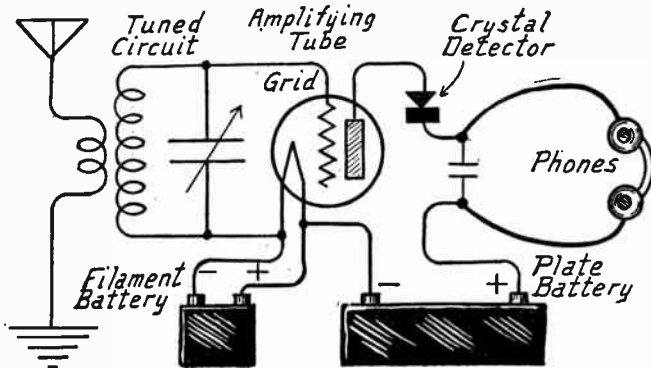

FIG. 17.—One-Tube Receiver with Crystal Detector.

Now, in place of having only the small voltages from the antenna to operate the headphones, we have the comparatively large and powerful effect of the changes in current from the plate battery. A vacuum tube will allow the smallest imaginable grid voltages to produce comparatively large changes in plate current. The grid acts just like a valve in the plate circuit. The exceedingly small voltages applied to the grid open and close this valve so that the comparatively strong plate current is made to rise and fall in time with the rise and fall of grid voltage.

The gain of signal strength by passing the signal through a single vacuum tube may be anywhere from six to twenty times. The signal strength in the plate circuit of the tube may be anywhere from six to twenty times as powerful as in the grid circuit of the same tube. The tube allows the weak signals from the antenna to control the power from the plate battery and this power from the plate battery operates the headphones.

RADIO, PRINCIPLES OF

Stages of Amplification.—It is not necessary to end the process of amplification with only the one tube since the plate current from this first tube may be used to affect the grid of a second tube as in Fig. 18. If the original signal strength be represented by 10 and we assume the amplification constant of the tube to be 8, the strength in the plate circuit of the first tube will be equal to 80. If this be then amplified by a second tube, also having an amplification constant of 8, the result will be represented by 640 which is sixty-four times the power of the incoming signal.

In Fig. 18 the plate of the first tube is connected to a small coil similar to that in the antenna circuit. The changes of plate current through this coil cause corresponding changes in voltage and since this coil is coupled to another one there are voltages induced in this coupled coil. The coupled coil is also provided with a tuning condenser to obtain resonance and the combination applies its voltage changes to the grid of the second tube. The batteries and their connections have been omitted from Fig. 18 since they do not affect the operation of the tubes and would only make the diagram seem more complicated.

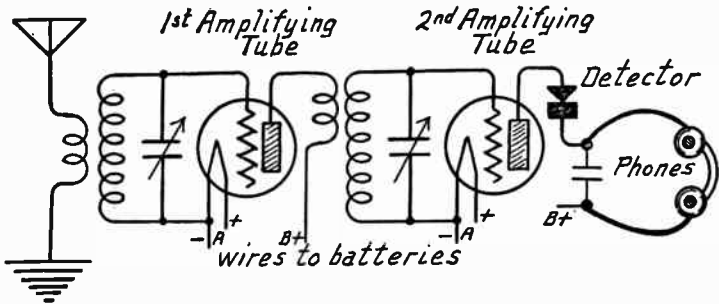

FIG. 18.—Two Stages of Amplification Before the Detector.

The Vacuum Tube as a Detector.—The three-element vacuum tube not only makes the most efficient kind of radio amplifier but may also be used as a detector to change the form of the incoming carrier wave into one that is audible.

By selecting the proper plate battery voltage for use with the tube it will amplify rises of voltage in the grid circuit to a far greater extent than it amplifies drops of grid voltage. The tube will receive the form of signal shown in Fig. 19 and, by amplifying the top half more than the bottom, will deliver the changes from its plate circuit as shown in Fig. 20.

The grid voltages are equal above and below the zero line of Fig. 19, consequently the average of these voltages is zero. We have already seen that an alternating voltage of this kind will not operate headphones or a loud speaker. But in Fig. 20 the top impulses have been amplified all out of proportion to the lower ones. The average current then shows a rise as indicated by the heavy line at the bottom. This average rise of plate current will operate the dia-

RADIO, PRINCIPLES OF

phragm of the phones or speaker very nicely and we have the vacuum tube operating as a detector.

The tube becomes a more sensitive detector if a condenser is inserted in its grid connection and a high resistance, called a grid leak, placed between the grid and one of the filament terminals of the tube. The condenser causes a large number of the incoming voltages to pile up on the grid so that the total effect is much greater in changing the grid voltage than the effect when using the tube as a detector without the grid condenser and grid leak. The purpose of the grid leak is to allow this accumulation of voltages to leak away as the applied voltages gradually die down, the grid then being left in a condition to respond to the next series of waves applied to it. These connections for using the tube as a detector are shown in Fig. 21.

Radio Frequency and Audio Frequency Amplification.—In all of the circuits shown so far we have used headphones but no loud speaker. This is because the strength of the currents in the plate circuits of the tubes have not been strong enough to operate a loud speaker in spite of the amplification given by the tubes. The amplification we have been using is called radio frequency amplification because we are amplifying the high frequency voltages as received from the antenna circuit.

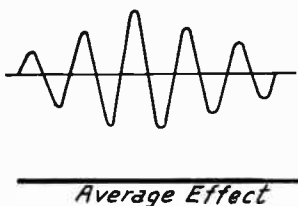

FIG. 19.—Voltages as Received by Detector Tube.

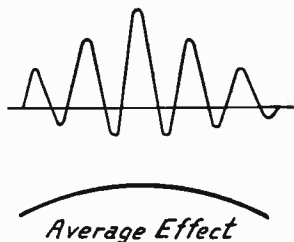

FIG. 20.—Voltages Delivered from Detector Tube Circuit.

The frequencies used for the carrier waves are called radio frequencies. The frequencies that are audible are below 15,000 cycles per second and are called audio frequencies. Everything as far as the detector is at radio frequency while everything following the detector is at audio frequency.

We may take the plate current changes from the detector tube and amplify them at the lower audio frequency in practically the same manner as used for the radio frequency tubes which precede the detector.

The gain in signal strength when amplifying at audio frequencies, or low frequencies, is far greater than the gain at radio frequencies. Not because the tubes do any better work at audio frequency than at radio frequency, but because it is easier to keep the audio frequency currents within bounds. Currents at radio frequency will wander off through the air and through insulators in spite of all we can do, while audio frequency currents are comparatively easy to confine to their proper conductors.

RADIO, PRINCIPLES OF

For coupling between tubes used at audio frequencies we are able to use iron-core transformers. The iron-core transformer consists of two windings or two coils, both wound around a single core of iron. The iron is magnetized some thousands of times easier than the air which surrounds the coils used at radio frequencies. Consequently we can obtain really good coupling and a very large transfer of energy from one coil or winding to the other.

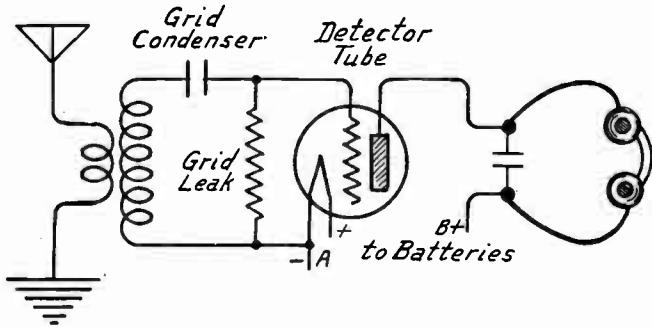

FIG. 21.—Detector Tube with Grid Condenser and Grid Leak.

Coupling of two tubes at audio frequency, one being the detector, is shown with an iron-core transformer in Fig. 22. While only one audio frequency tube is shown, another one may be coupled through a second audio frequency transformer. Transformers are not the only means of coupling in audio frequency circuits. Equivalent results may be obtained by using resistances or choke coils as described under *Amplifier, Audio Frequency*. Fig. 22 shows a three-tube receiver consisting of one radio frequency amplifying tube, one vacuum tube detector, and one audio frequency amplifying tube. The output of this receiver is powerful enough to operate a loud speaker with considerable volume from broadcasting stations.

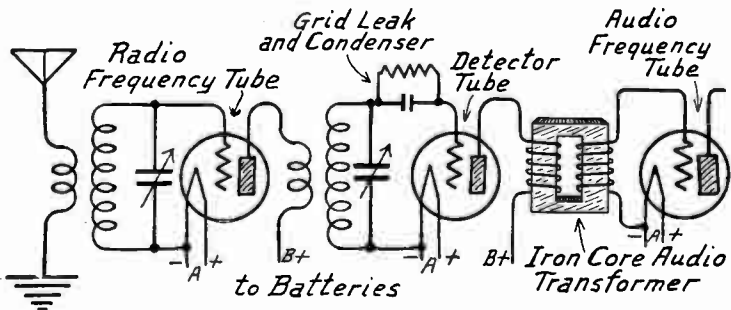

FIG. 22.—Audio Frequency Coupling with Iron-Core Transformer.

The foregoing explanation of the action taking place in radio reception has covered only the principal features. In the actual design, construction and operation of radio receivers there are many detail refinements and additional controls which make for satisfaction. All of these other points are treated in detail under their

RADIO TELEGRAPHY

respective headings. Complete descriptions of all the receiver parts that have been mentioned and detailed explanations of all the electrical words and terms that have been used are also given under their own headings.

RADIO TELEGRAPHY.—Radio communication by means of the dots and dashes of the telegraphic code is called radio telegraphy. Radio telegraphy may make use of the antiquated spark system or of the more modern continuous wave transmission from vacuum tubes. See also *Code*.

RADIO TELEPHONY.—Radio transmission and reception of the sounds of voice and music as in broadcasting is called radio telephony. By means of radio telephony it is possible to send and receive any sounds that might be handled by wire telephony.

RADIO WAVE.—See *Wave, Radio*; also *Radiation*.

RADIO, WIRED.—Radio waves may be guided by wires between a transmitter and a receiver rather than being allowed to radiate freely through space. This system is called by many names, among them being; wired radio, wired wireless, line radio, carrier current telephony and guided wave telephony. With the output of a transmitter connected to one end of a pair of wires and the receiver connected to the other ends, communication may be maintained often up to distances twenty times as great as without the help of the wires.

The carrier frequency employed in wired radio is generally less than the frequencies employed without wires. The carrier must, of course, be above audibility and is generally somewhere between 20,000 and 500,000 cycles. By proper selection of carrier frequencies so that the side bands do not overlap and so that there is no interference between their harmonics it is possible to use a single set of wires for carrying many different messages at one time, each message using one of the frequency channels. While carrying the wired radio messages the wires may at the same time be in use for ordinary telephony and telegraphy. Power lines, lighting circuits, trolley lines and other electric circuits may all be used for wired radio.

RANDOM WINDING.—See *Winding, Random*.

RANGE, METER.—See *Meters, Ampere and Volt*.

RANGE, RECEIVER.—The range or distance in miles over which a receiver will be responsive to signals from broadcast stations depends on things too numerous to be counted. Were it possible to use two receivers under identical conditions at one time and the same place the relative distance range would depend on the relative sensitivity of the two receivers. The more sensitive one would, of course, have the greatest range of reception. But aside from receiver sensitivity there are dozens of known influences on reception and probably several dozen unknown influences. Atmospheric conditions have a decided effect.

Among the many factors affecting distant reception may be mentioned first of all the weather. There is a difference between results during warm weather and cold, between weather that is undergoing a change and weather that is constant. The location of the receiver is of importance, also its general condition, such as the age of the

RANGE, RECEIVER

tubes, the condition of power supply units or batteries, the antenna and ground connections, etc.

Recent researches seem to show that a weather map may form a rather reliable guide to probable radio reception just as it does to probable weather conditions. At least it seems true that reception will be best when the signals may travel along the lines of equal barometric pressure and will be poorer when the signals must travel from a point of high pressure to one of lower pressure or from a low pressure area to a high pressure area.

This theory may account for the fact that in a given locality the reception may sometimes be best from the South, then again from the West, or the East or the North. It is impossible to be sure of any particular distance range at any particular time because conditions never remain the same for very long even though the set be unchanged and continue in the care of the same operator.

The location of a receiver with reference to the broadcasting station determines to a great extent the reception that may be consistently expected. This is because of the effect of attenuation of the radio waves. Attenuation is the loss of energy due to dielectric losses and eddy current losses taking place in materials and obstacles which the waves must pass through or around on their way to the receiver. For this reason a receiver located way out in the country will generally do much better distance work than a similar receiver operated in a city. The difference is usually measured by a thousand miles or more. A receiver surrounded by steel buildings is decidedly handicapped.

The power of the broadcasting station has a great effect on the distance at which it may be received. Reliable night-time reception under fair conditions with a sensitive receiver may be expected from 100-watt stations up to about 40 miles, from a 1000-watt station this distance will be between 150 and 200 miles, from 2000-watt stations it will run between 250 and 300 miles, from 5000-watt broadcasters the distance will increase to between 350 and 500 miles, while 10,000-watt stations should be heard quite regularly from 500 to 700 miles away. The distance to which a broadcaster reaches out depends not only on the power put into the aerial but also on the general excellence of the station and on the degree of modulation.

Where a station gives fairly consistent reception at night up to 300 to 400 miles its daytime range will be about 100 to 150 miles. A good average receiver will bring in stations up to a distance of 500 miles with some regularity, will occasionally hear stations 1000 to 1200 miles away and very rarely will bring in signals from a distance of 2000 miles. The very distant stations may come through with real volume for a few minutes and may not be heard again for months.

Taking the volume given on a certain receiver from a broadcasting station one hundred miles away as being represented by the number 100, the effect of greater distances on the strength or volume will drop approximately according to the following table, all other things being equal:

RATIO

DISTANCE EFFECT ON VOLUME

Miles	Volume	Miles	Volume
100	100%	600	10%
200	48%	700	7%
300	24%	800	6%
400	16%	900	5%
500	14%	1000	4%

This is sometimes called the inverse distance effect, since the volume of received signal varies inversely with the distance from the transmitting station.

Extended observations under average conditions show that reception is best from distant stations in January. Taking the January reception as represented by 100 per cent, the other months in the average year rate as follows:

EFFECT OF SEASON ON VOLUME

January	100%	March	80%	May	49%
December	96%	October	77%	August	48%
February	94%	April	64%	June	45%
November	92%	September	62%	July	44%

Excellent radio reception may be expected from November to February and poor reception from May to August. Reception during the remaining months should be fair. These figures are for average years, but many years prove to be decided exceptions.

Observation seems to show that distance reception is comparatively poor during the time of full moon. At this time the reception will also be more noisy. On a night during which the moon shines only in the early part of the evening, reception will greatly improve after the moon has set.

See also *Sensitivity*.

RATIO.—The quotient obtained by dividing one number by another number is called the ratio of the numbers. Thus the ratio of 10 to 5 is 2 because 10 divided by 5 equals 2. The ratio of 5 to 10 is $\frac{1}{2}$ because 5 divided by 10 equals $\frac{1}{2}$. A ratio may be written as a fraction, as the fraction $\frac{1}{2}$ just given, or it may be written with a colon between the numbers, as 5:10, which is read “the ratio of five to ten.”

RATIO, TRANSFORMER.—See *Transformer*.

RATIO, VOLTAGE.—See *Transformer, Audio Frequency and Transformer*.

RAYTHEON RECTIFIER.—See *Rectifier, Raytheon Types*.

REACTANCE.—Reactance is the name given to the opposition to flow of alternating current when this opposition is caused by the inductance of a coil or by the capacity of a condenser. Re-

REACTANCE

actance is measured in ohms. The reactance of a circuit with the resistance of that circuit makes up the circuit's impedance. Reactance is called the reactive component of the circuit's impedance.

Reactance caused by a coil's inductance is called inductive reactance. Reactance caused by a condenser's capacity is called capacitive reactance. Any reactance caused by inductance, whether in a coil or in any other conductor is likewise called inductive reactance while any reactance caused by capacity between parts is called capacitive reactance. Either kind of reactance may act to hinder the flow of alternating currents.

Inductive reactance, the reactance of a coil, increases with increase of frequency and is often called positive reactance. Capacitive reactance, the reactance of a condenser, grows less with increase of frequency and is often called negative reactance. Therefore, the value of inductive reactance may be preceded by the positive sign +, while the value of capacitive reactance may be preceded by the negative sign -.

When the frequency is measured in kilocycles and the inductance in millihenries the inductive reactance in ohms is as follows:

$$\text{Inductive Reactance} = 6.2832 \times \text{frequency} \times \text{inductance}$$

The same formula holds true when the frequency is measured in cycles and the inductance in henries.

If the frequency is measured in kilocycles and the inductance in microhenries, the formula becomes:

$$\text{Inductive Reactance} = 0.0062832 \times \text{frequency} \times \text{inductance}$$

The number 6.2832 is the approximate value of two times π , the Greek letter which stands for the ratio of a circle's circumference to its diameter.

When the frequency is measured in cycles and the capacity in microfarads, the capacitive reactance in ohms is as follows:

$$\text{Capacitive Reactance} = \frac{159,155}{\text{Frequency} \times \text{Capacity}}$$

If the frequency is measured in kilocycles and the capacity in microfarads, the formula becomes:

$$\text{Capacitive Reactance} = \frac{159,154,600}{\text{Frequency} \times \text{Capacity}}$$

If the inductive reactance, which is considered as a positive quantity, just equals the capacitive reactance, which is considered a negative quality, the two will balance each other so that there is no effective reactance remaining in the circuit. The only opposition then remaining to the flow of alternating current at the particular frequency being considered is the resistance, and the circuit is resonant at that frequency. See also *Resonance*.

Reactance is one of the components or parts of impedance in an alternating current circuit. The other part is resistance. Resistance opposes the flow of both alternating and direct currents through a circuit. The energy required to overcome resistance causes heat and is beyond recovery.

Reactance opposes the flow of an alternating current through a circuit but the energy required to overcome reactance may be stored in the circuit, is not lost, and may be recovered.

REACTIVATION OF TUBE

When only direct current flows through a circuit it is opposed only by the resistance of the conductors, but when alternating current flows it is opposed by both the resistance and the reactance.

We can say that inductive reactance is the effect that a coil of wire has on an alternating current. Every coil of wire has inductance, that is, any change of current in a coil causes a voltage which opposes the change of current. The effect of a coil of wire on alternating current is to hold back the current or to temporarily choke it. This reactance effect which appears in a coil is called inductive reactance because it is caused by inductance. The inductive reactance turns part of the energy of the alternating current into a magnetic field around the coil or causes such a field to be built up. As this magnetic field collapses it returns energy to the circuit and that is why we say that reactance differs from resistance in not losing energy but in storing energy.

A condenser also has reactance to alternating current. To a direct current a condenser has exceedingly high resistance. In fact, to direct currents whose voltage is not great enough to break through the dielectric, the condenser forms an open circuit, or an infinitely high resistance.

A condenser does not offer this infinitely high resistance to alternating current but offers only reactance. Here again the reactance does not cause a loss of energy but stores it on the plates of the condenser in the form of electric charges which will return the energy to the circuit.

To an alternating current of given voltage and amperage a large condenser has less reactance than a small one and the larger the capacity of a condenser the less is its reactance to a given current and voltage.

REACTIVATION OF TUBE.—See *Tube, Restoration of*.

REACTOR.—A coil used to oppose the flow of alternating current by its property of reactance is called a reactor. Choke coils are reactors. See *Coil, Choke*. Reactance coils are used in many forms of filter circuits. See *Filter*.

REAMER.—See *Tools*.

RECEIVER.—A combination of parts which receives radio waves and makes them audible is called a receiver. A receiver may consist only of a crystal detector or of a vacuum tube detector with the necessary tuning parts and a set of headphones. The receiver may also include one or more stages or radio frequency amplification between the antenna and the detector and it may include one or more stages of any type of audio frequency amplification following the detector.

There are a number of different types of receivers in common use, the difference between them lying principally in the design of the tuning elements and of the radio frequency amplifying stages.

The fundamental types are as follows:

1. Receivers with regenerative detectors.
2. Super-regenerative receivers.
3. Receivers with reflexing.
4. Superheterodyne receivers.
5. Tuned radio frequency receivers with an adjustable control for oscillation.
6. Tuned radio frequency receivers with balanced circuits such as the Neutrodyne.
7. Receivers using screen grid tubes.

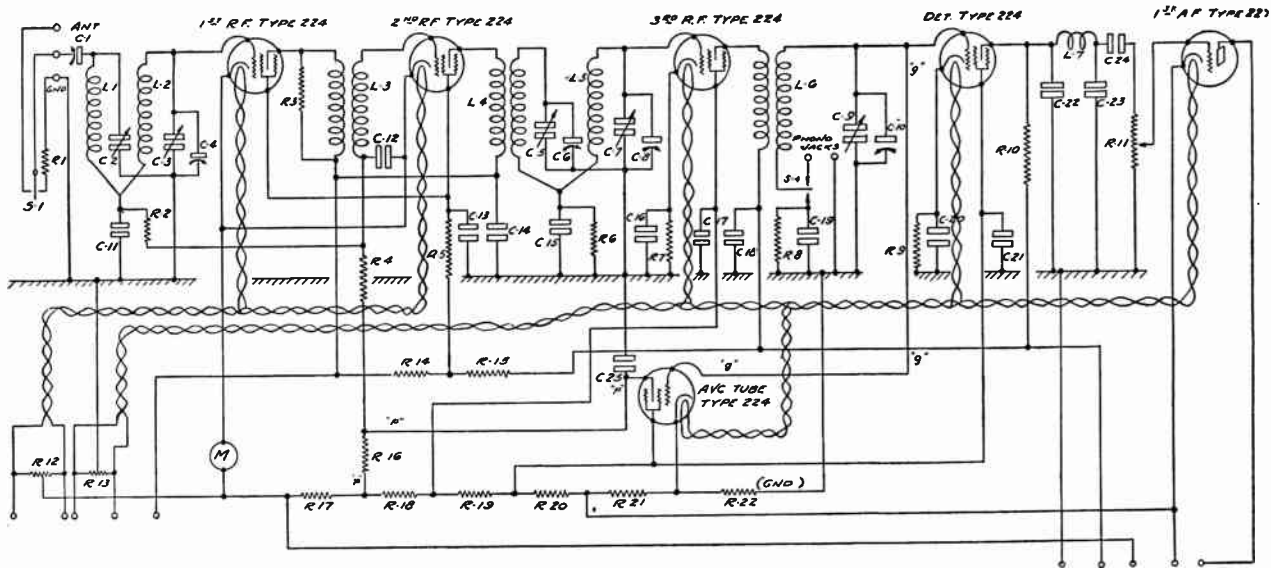

RECEIVER—BOSCH "60"

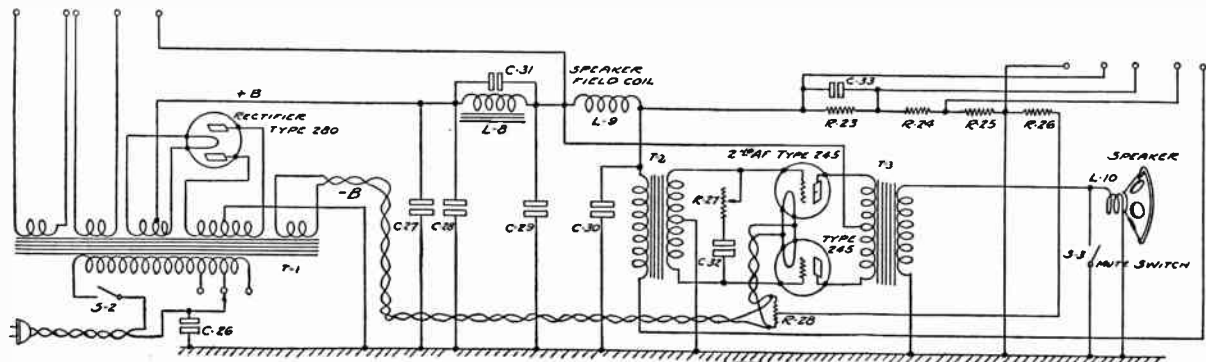

Resistor

R-1	500	ohms
R-2-6-7-8	1,000	"
R-3-9	50,000	"
R-4-10-11-16-27	500,000	"
R-5-14	20,000	"
R-15	10,000	"
R-17	900	"
R-18-20	5,000	"
R-19	25,000	"
R-21-22	2,000	"

R-23	1,300	ohms
R-24	2,380	"
R-25	160	"
R-26	950	"

Condenser

C-11-15-19	0.04	mfd
C-12-21	0.5	mfd
C-13-14-16-17-18	0.25	mfd
C-20	1.0	mfd
C-22-23	0.0001	mfd
C-24-25-32	0.006	mfd
C-26	0.1	mfd
C-27-28-30-33	2.0	mfd
C-29	4.0	mfd
C-31	0.075	mfd

Automatic volume control-	Resistors R-16-19-22	Condenser C-25
Manual volume control-	Resistor R-11	
Tone control-	Resistor R-27	Condenser C-32

RECEIVER—BOSCH "60"

RECEIVER—BRUNSWICK "S-14, 21"

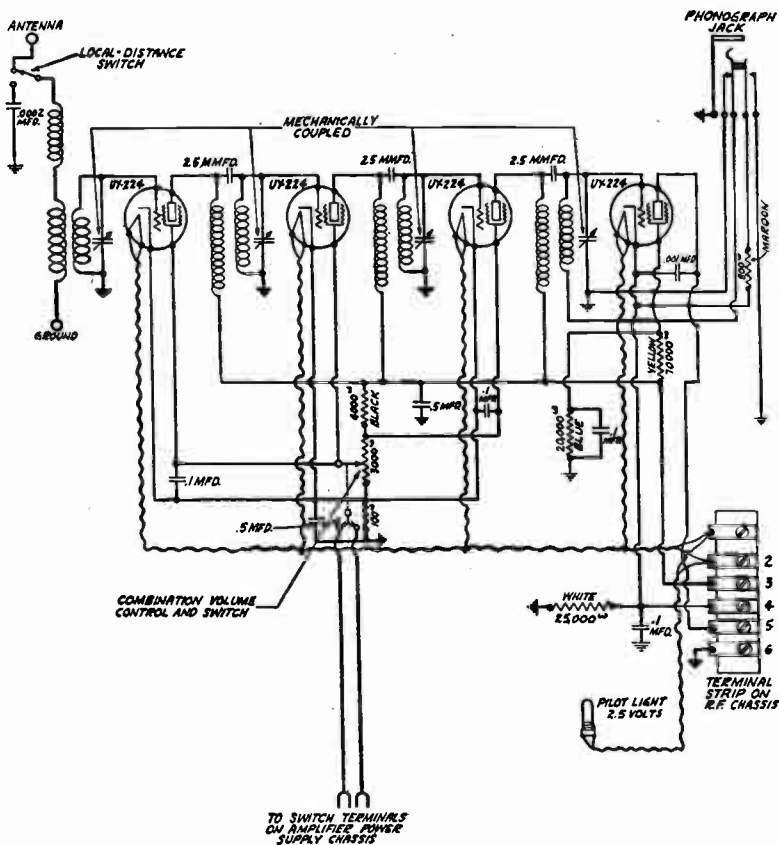

RECEIVER—BRUNSWICK "S 14, 21, 31"

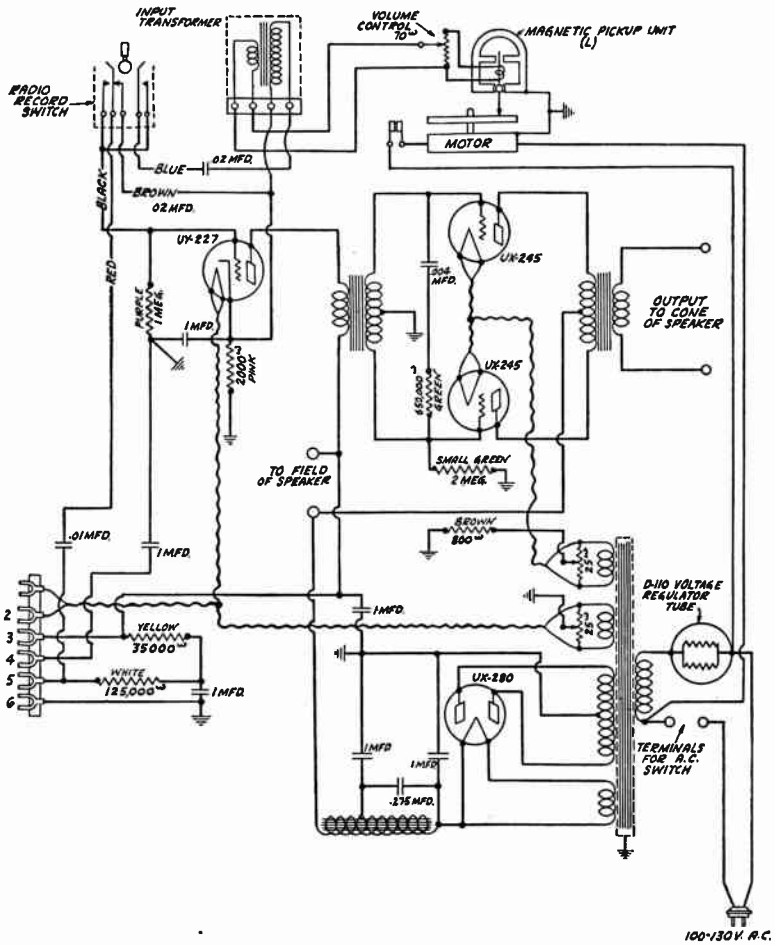

RECEIVER—CLARION "51, 53, 55"

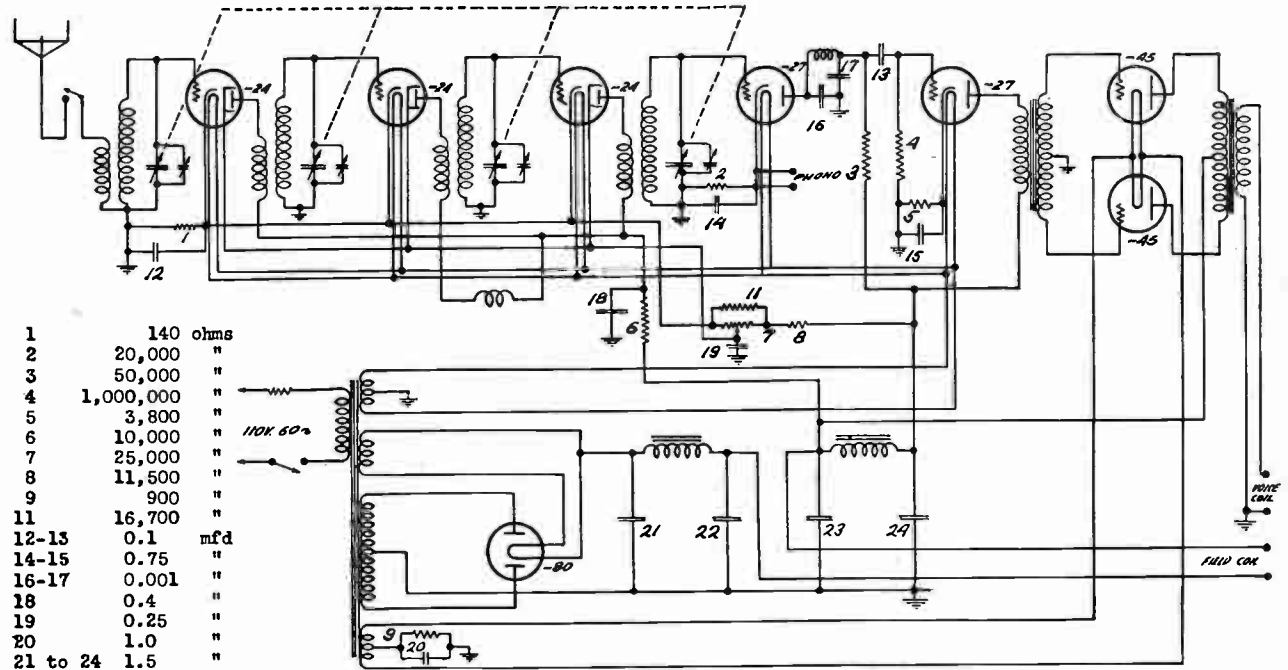

1	140	ohms
2	20,000	"
3	50,000	"
4	1,000,000	"
5	3,800	"
6	10,000	"
7	25,000	"
8	11,500	"
9	900	"
11	16,700	"
12-13	0.1	mfd
14-15	0.75	"
16-17	0.001	"
18	0.4	"
19	0.25	"
20	1.0	"
21 to 24	1.5	"

PHONE
C.M.A.
FULL COM.

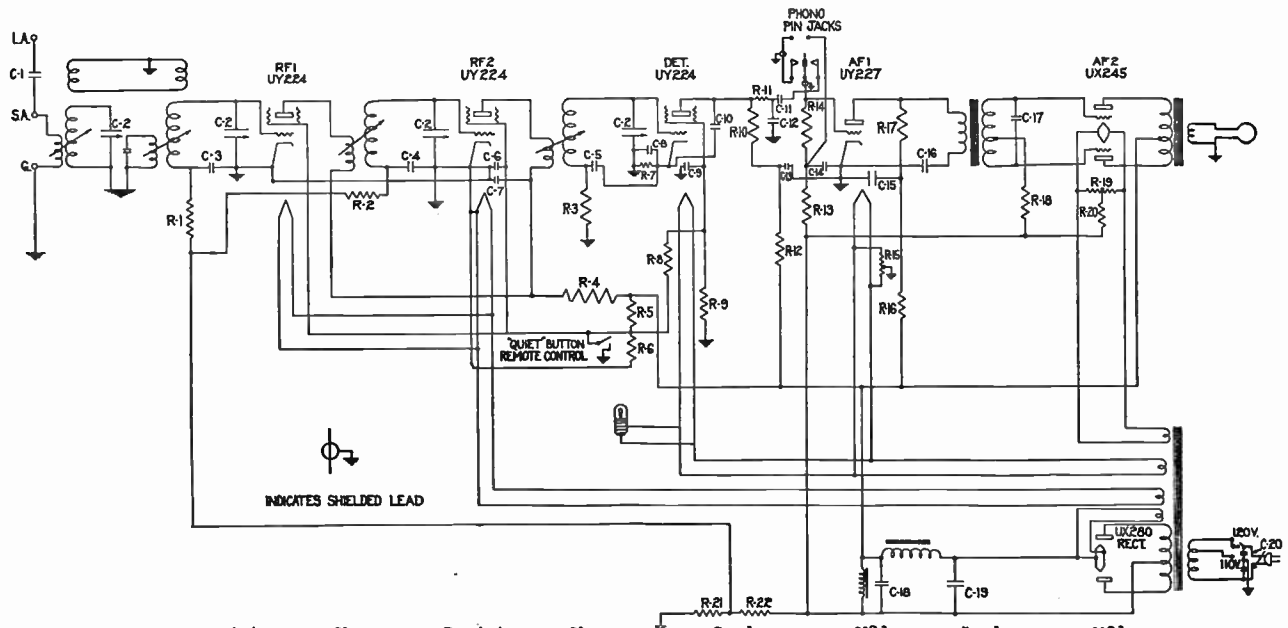

Resistor	Ohms	Resistor	Ohms	Condenser	Mfds	Condenser	Mfds
R-1-2-18	100,000	R-10-12	200,000	C-1	0.00025	C-11	0.006
R-3-8-9	750,000	R-13	400,000	C-2	0.0003	C-13-20	1.0
R-4	11,000	R-14	1,000,000	C-3-4-5-7-8-14-16	0.2	C-15	0.25
R-5	60,000	R-15-19	20	C-6-9	0.5	C-17	0.0005
R-6-11-17	50,000	R-20	800	C-10-12	0.0001	C-18-19	8.0
R-7-16	20,000	R-21-22	210				

RECEIVER—COLONIAL "33"

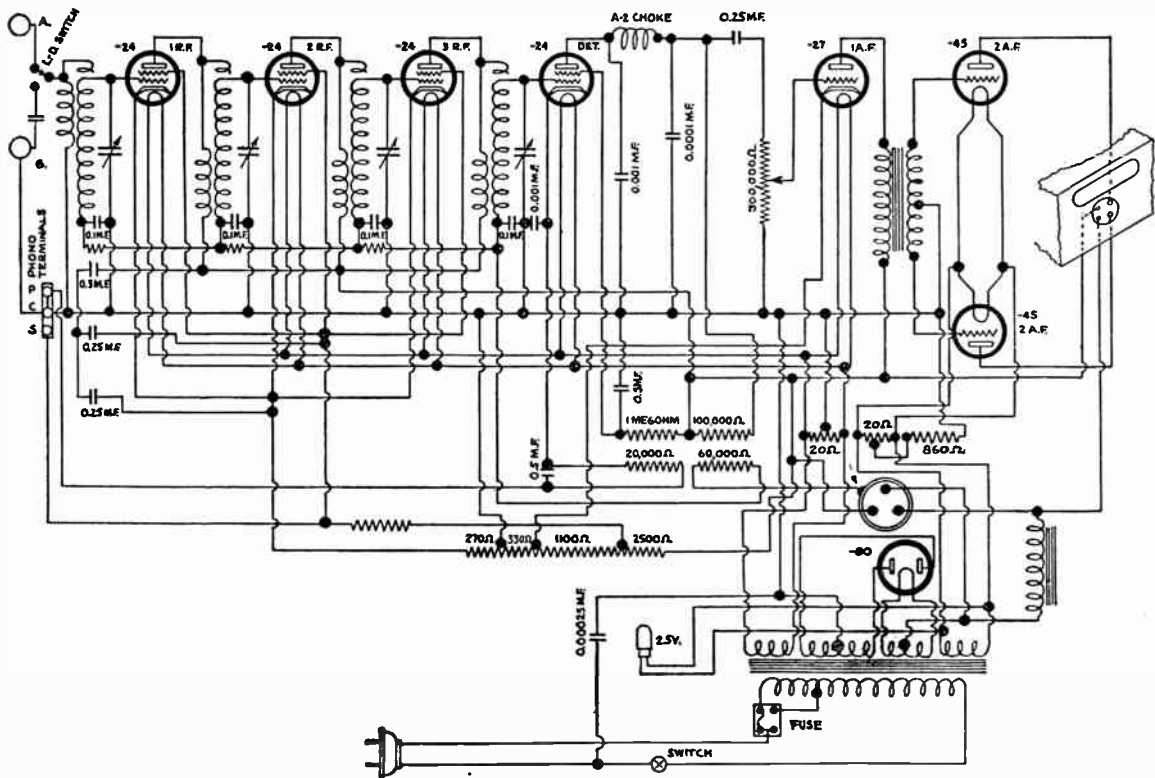

RECEIVER—CROSLLEY "84"

RECEIVER—EDISON "R4, R5, C4"

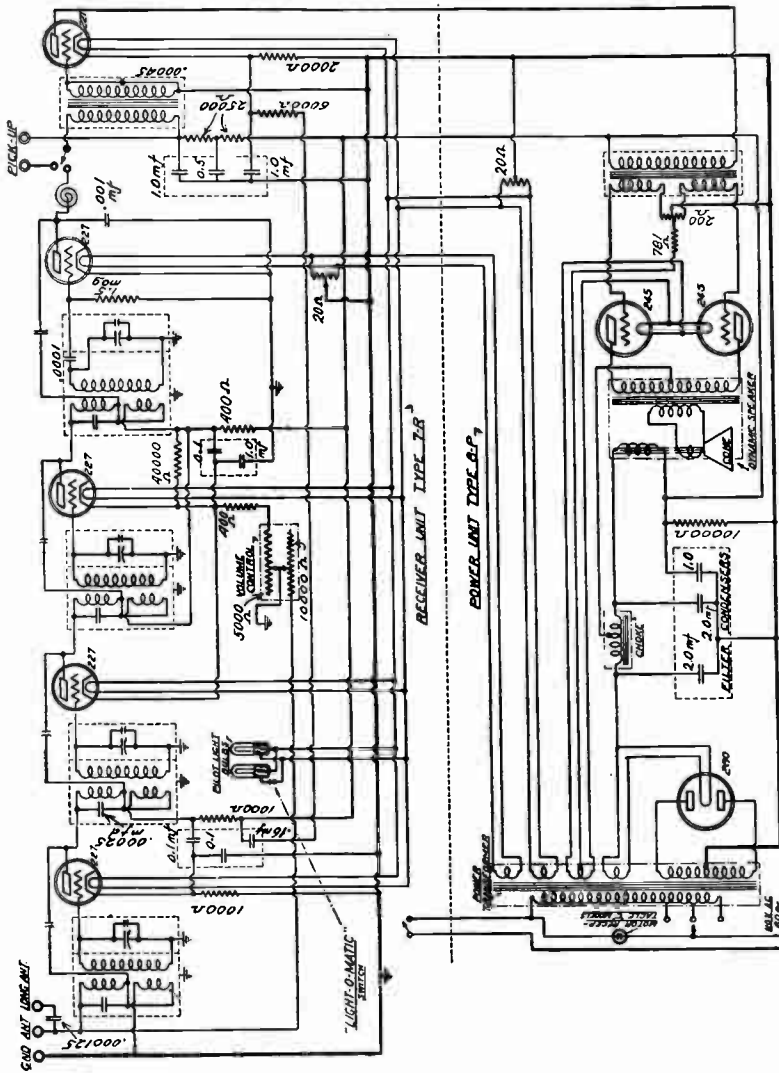

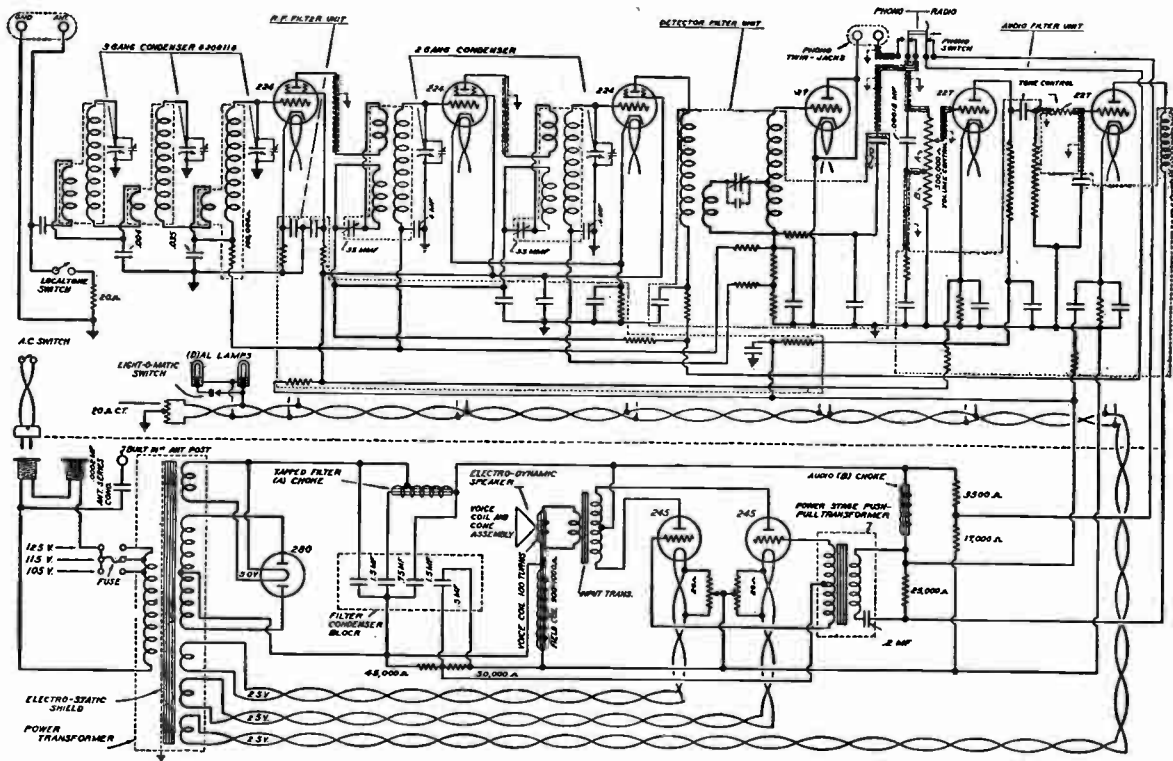

RECEIVER—EDISON “R6, R7”

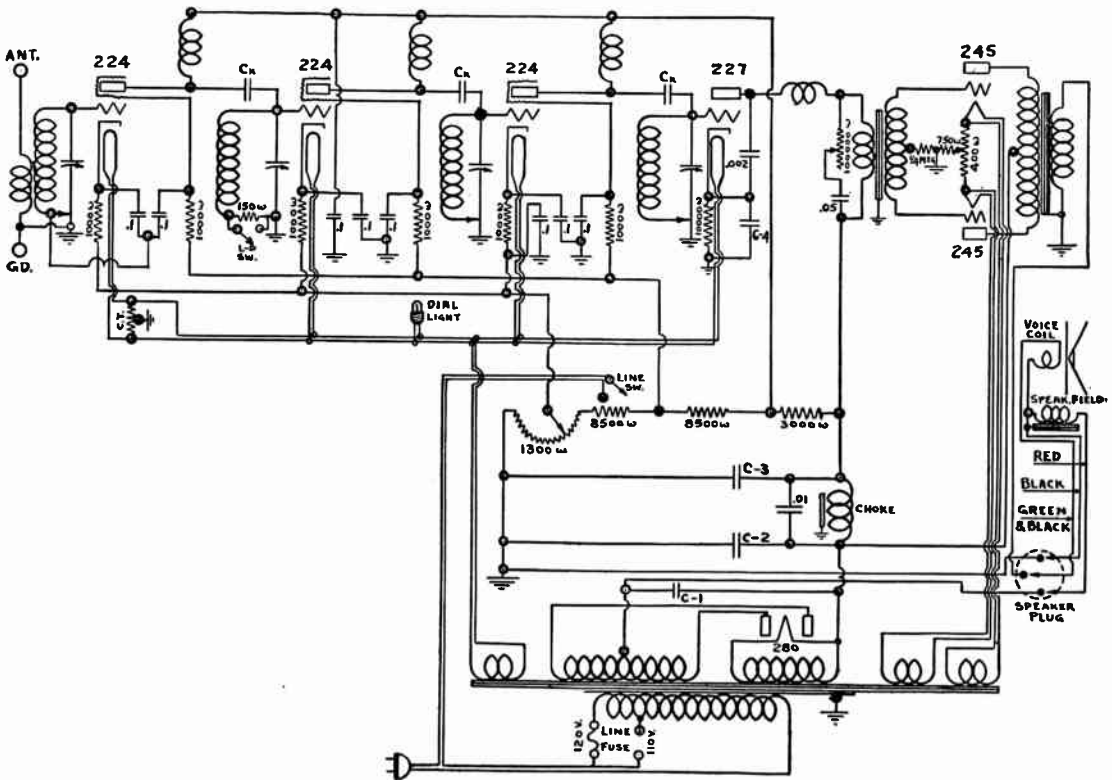

RECEIVER-GREEB "AH1"

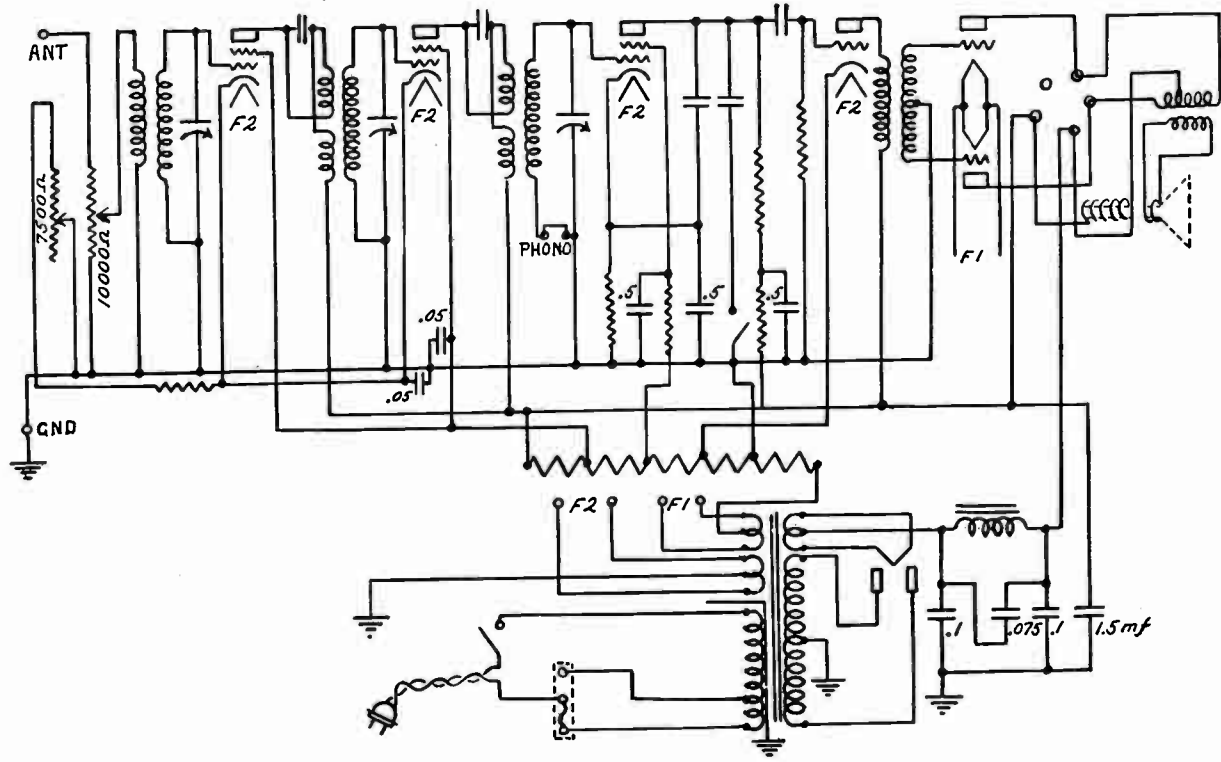

RECEIVER-LYRIC "D"

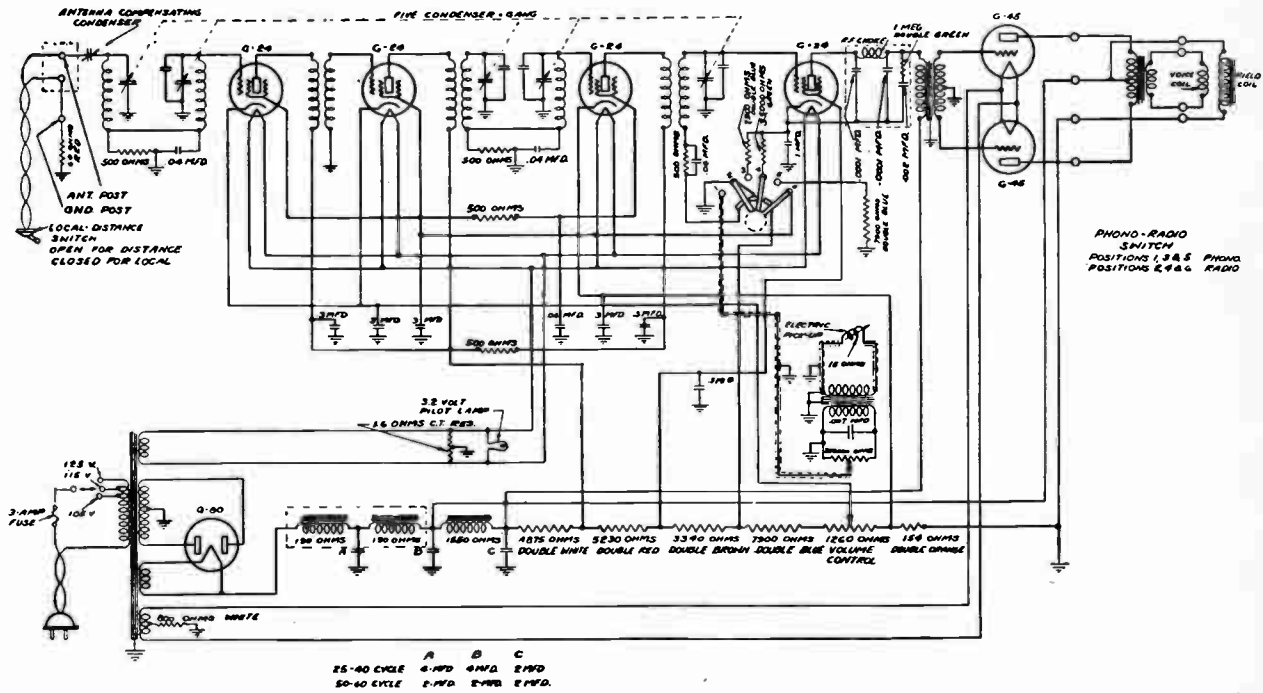

RECEIVER—MAJESTIC "230A"

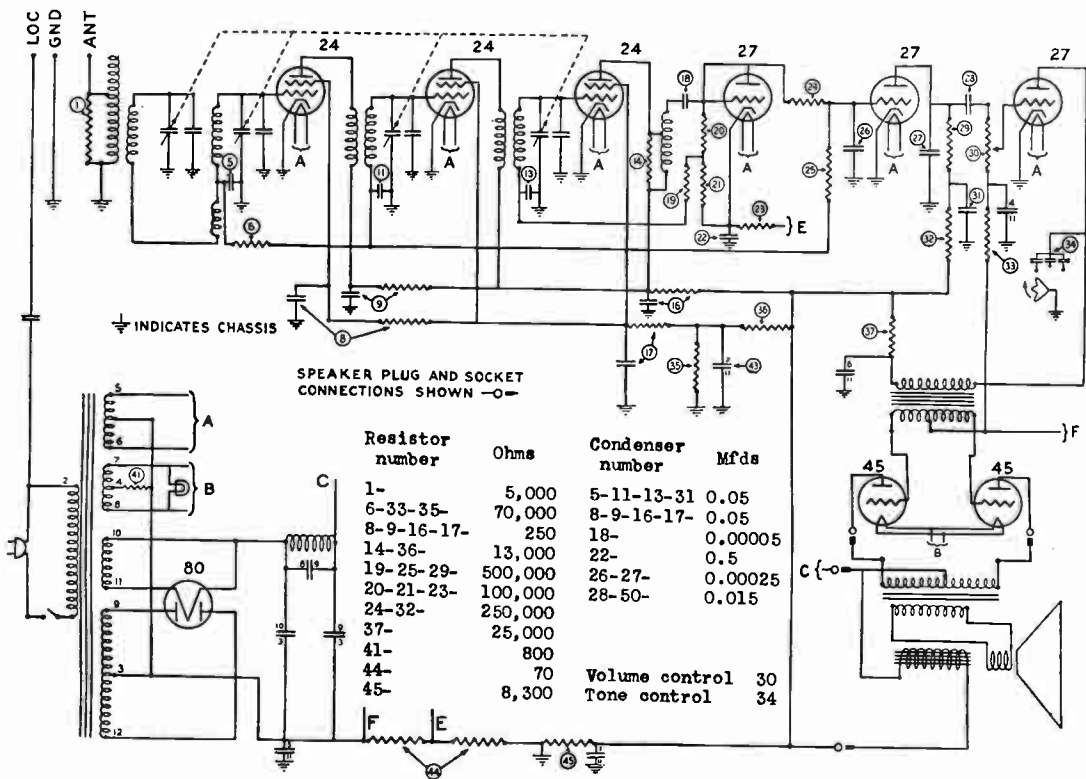

RECEIVER—PHILCO "96, 96A"

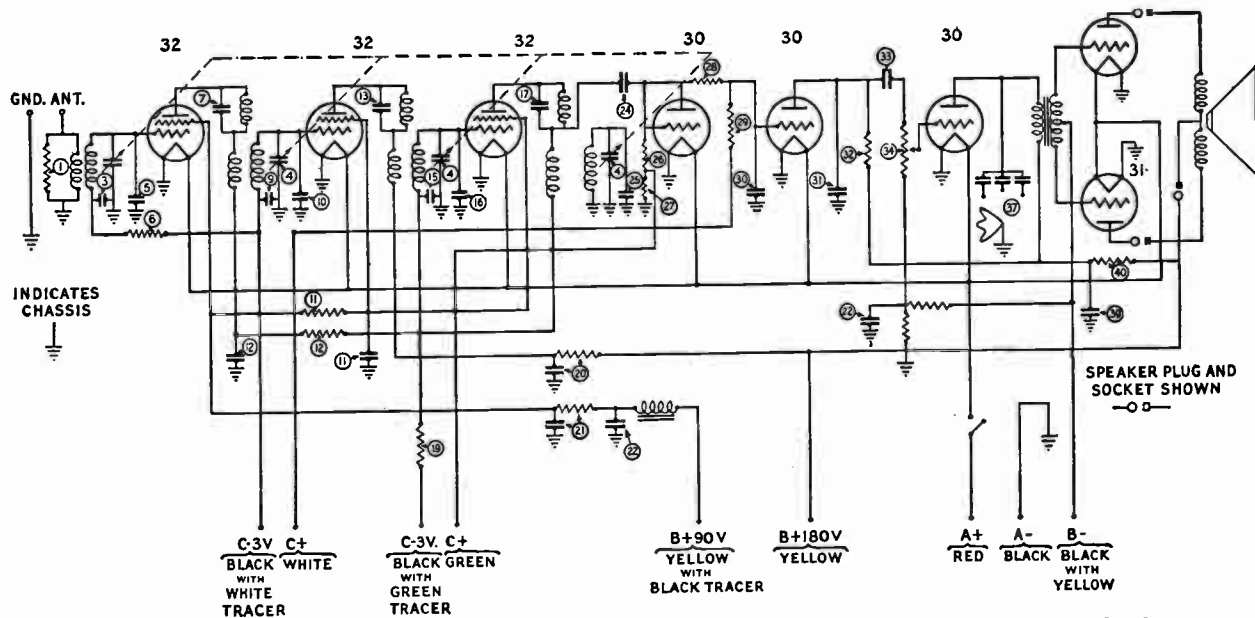

- | | | | | |
|---------------------|-------------------|------------------|------------------|--------------------|
| 1- 5,000 ohms | 7-13-17- coupling | 19- 500,000 ohms | 27- 100,000 ohms | 33- 0.01 mfd |
| 3- 0.05 mfd | condensers | 20- 0.05 mfd | 28- 250,000 ohms | 34- volume control |
| 5-10-16-25- compen- | 9- 0.05 mfd | 21- 0.05 mfd | 29- 500,000 ohms | 37- tone control |
| sating conds | 11- 0.05 mfd | 22- two 0.25 mfd | 30- 0.00025 mfd | 39- 0.25 mfd |
| 6- 7,000 ohms | 12- 0.05 mfd | 24- 0.00005 mfd | 31- 0.00025 mfd | 40- 25,000 ohms |
| | 15- 0.05 mfd | 26- 100,000 ohms | 32- 500,000 ohms | |

RECEIVER—PHILCO "30"

RECEIVER—RADIOLA "80"

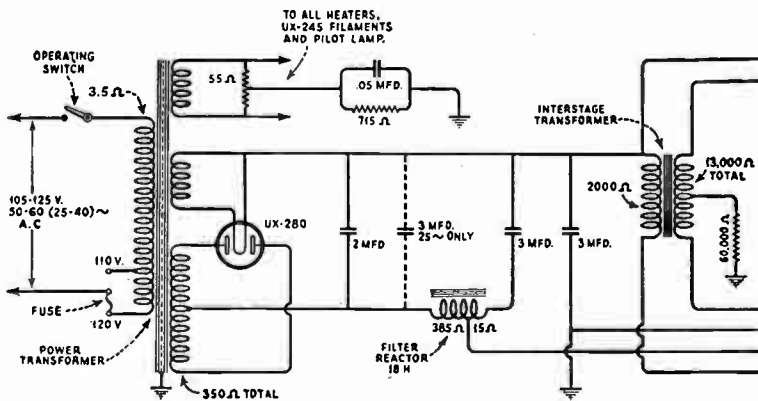
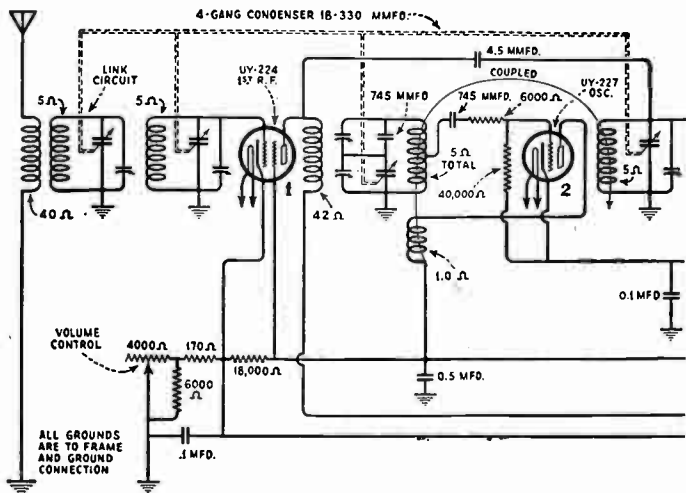

RECEIVER—RADIOLA "80"

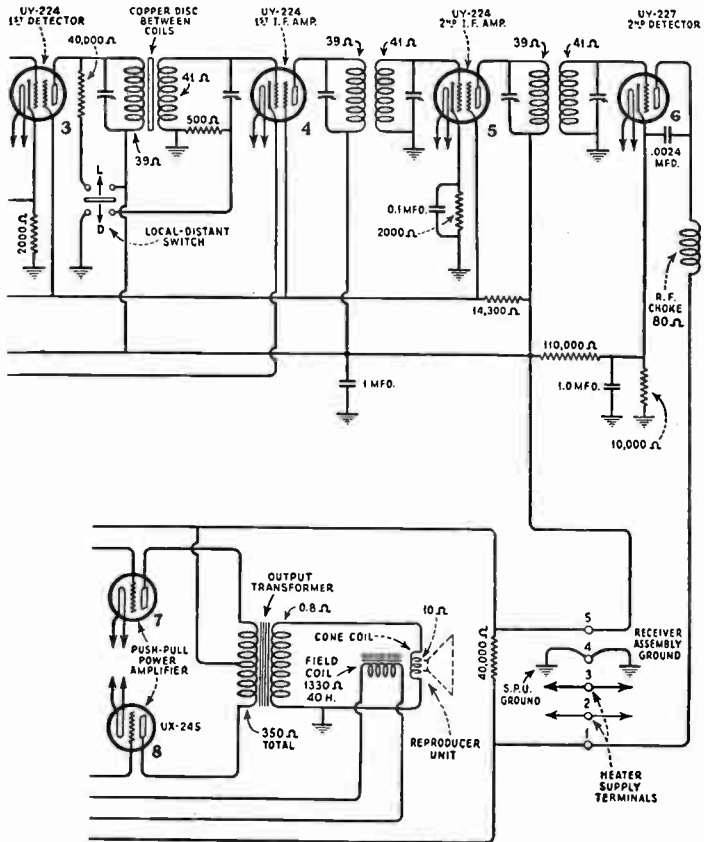

RECEIVER—REMLER "CAMEO"

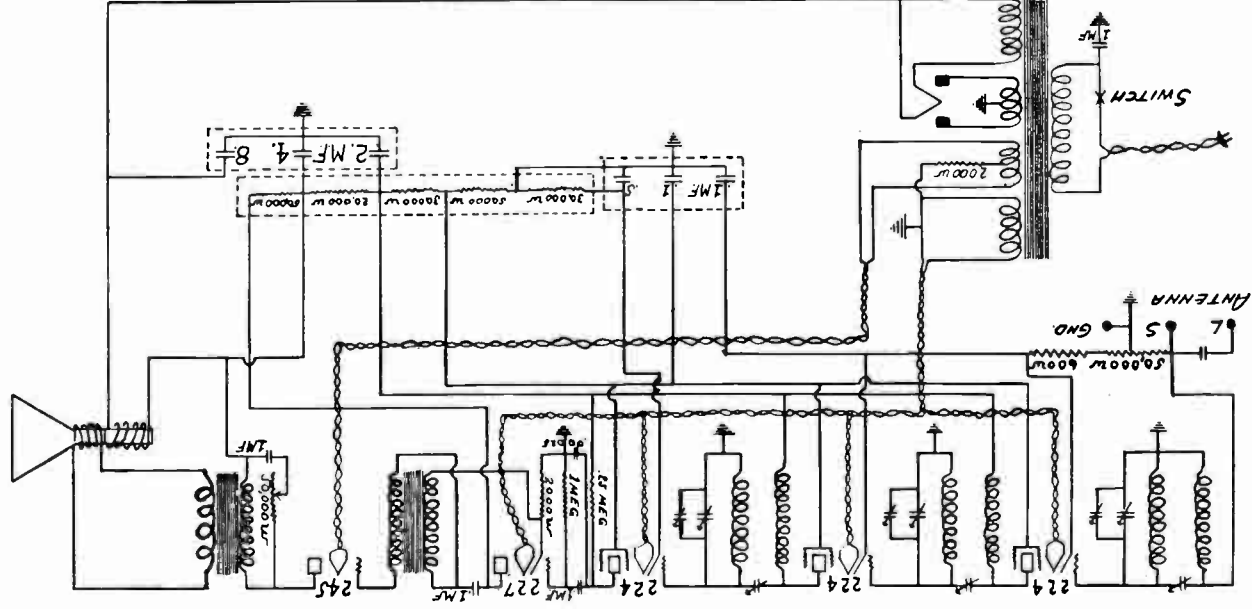

RECEIVER—SILVER-MARSHALL "36A"

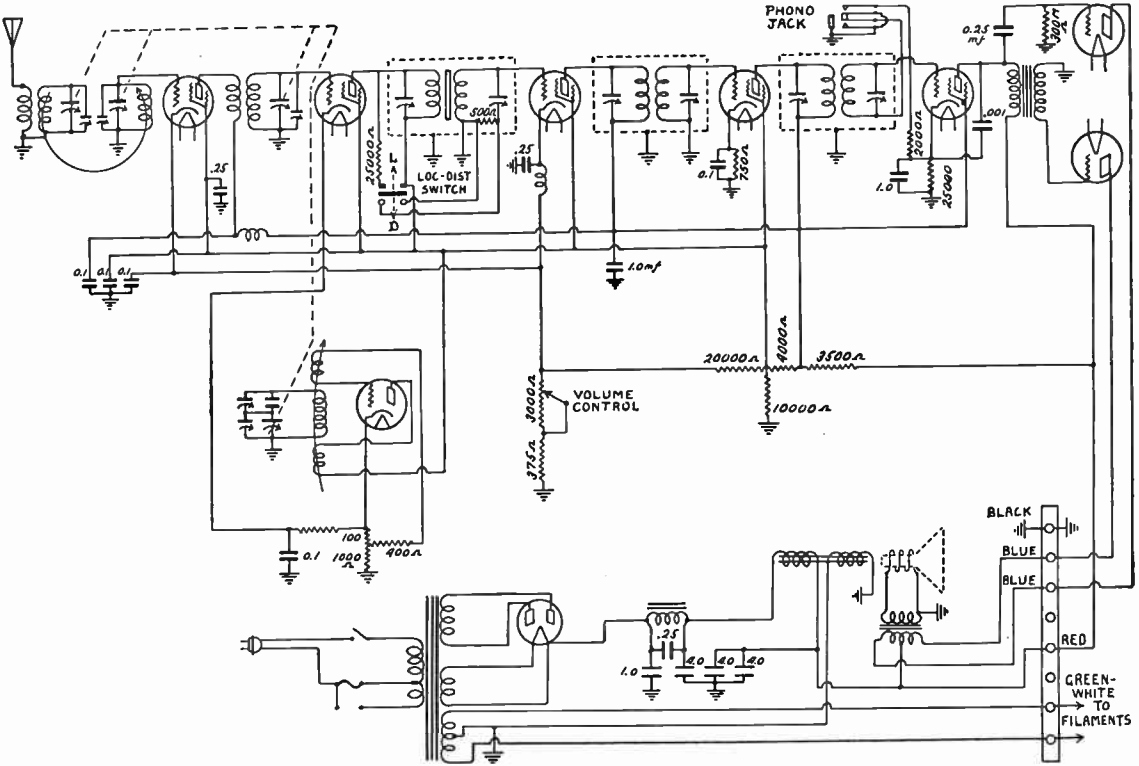

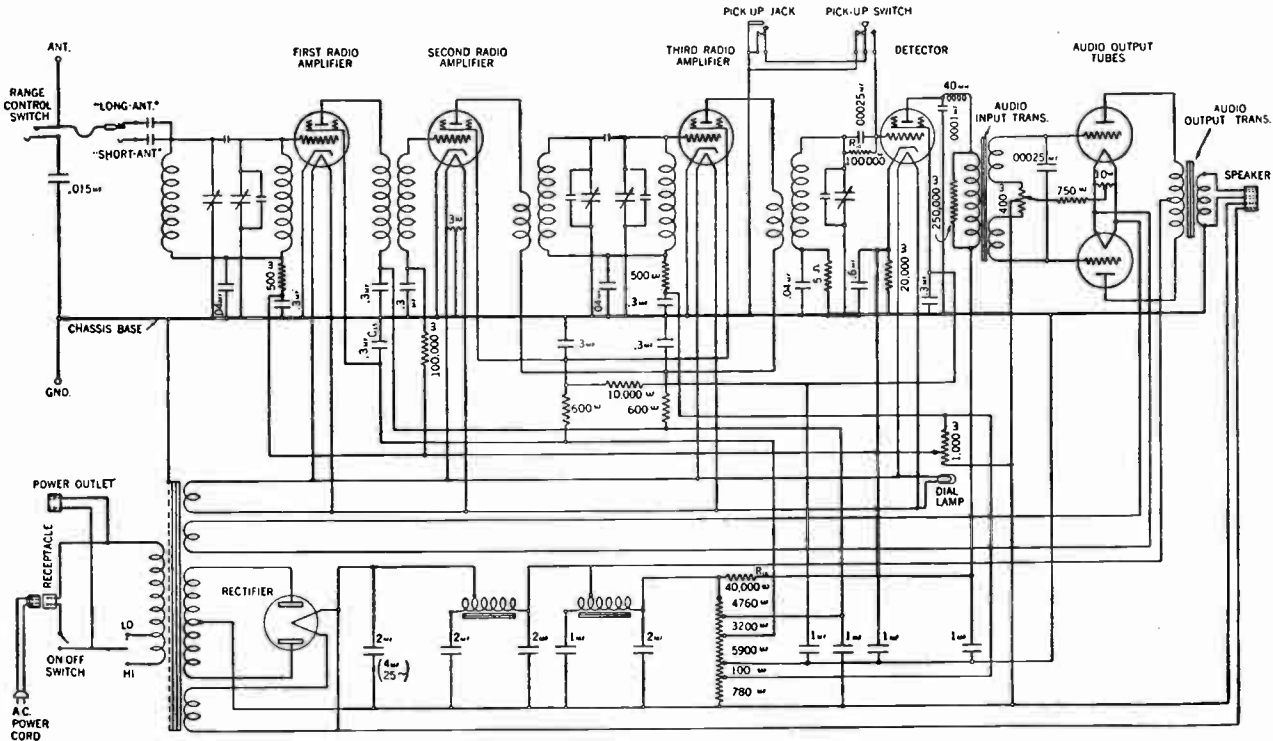

RECEIVER—STROMBERG-CARLSON "10, 11"

RECEIVER—WESTINGHOUSE "WR6"

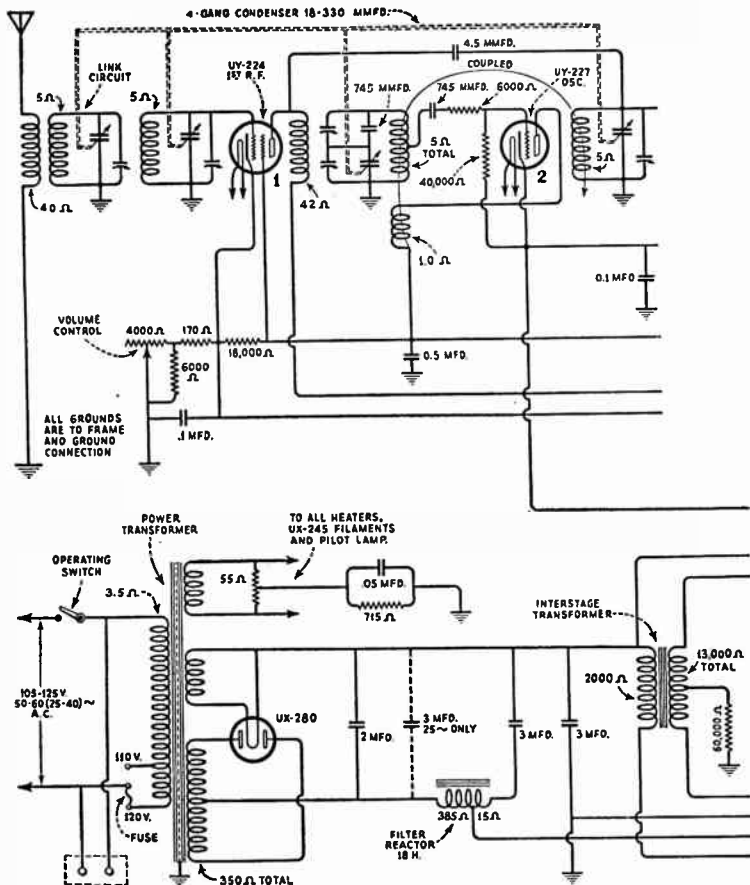

RECEIVER—WESTINGHOUSE "WR6"

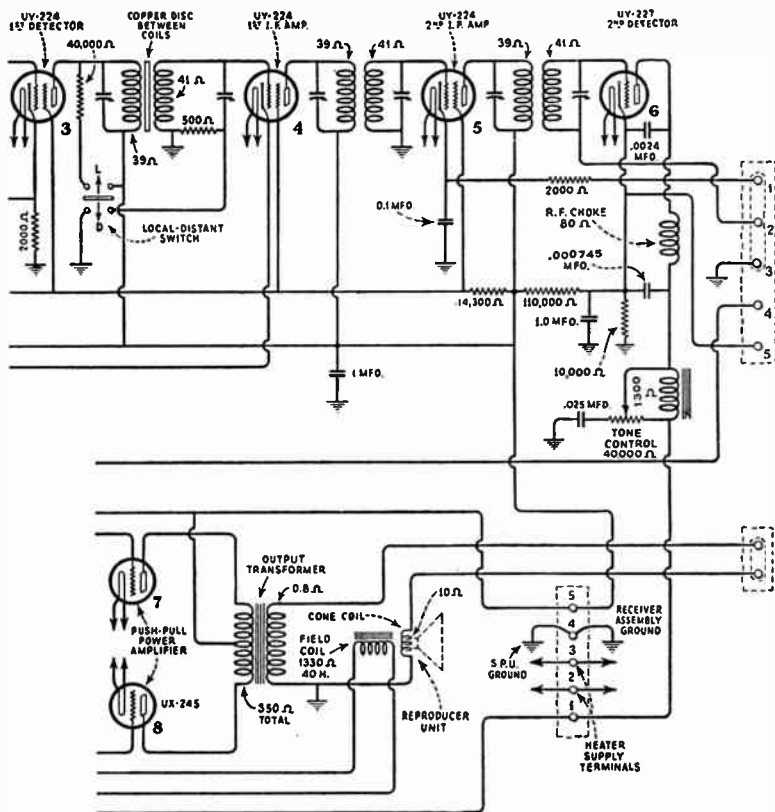

RECEIVER, CRYSTAL

RECEIVER, CONSTRUCTION OF.—See *Construction, Receiver.*

RECEIVER, CRYSTAL.—The operation of the crystal as a detector is explained under *Detector, Crystal.*

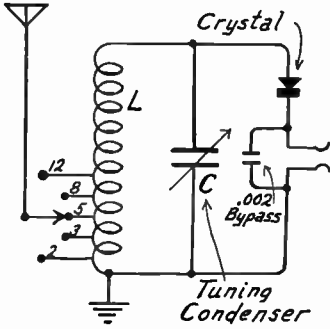

FIG. 1.—Simplest Type of Crystal Receiver.

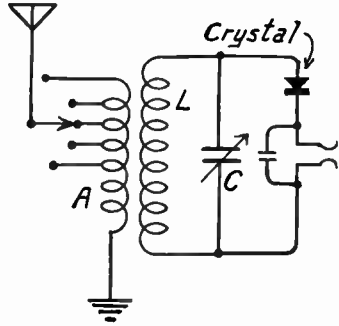

FIG. 2.—Crystal Receiver with Loosely Coupled Antenna Circuit.

The simplest type of crystal receiver is shown in Fig. 1. The coil L and condenser C should be chosen to cover the broadcast band according to specifications given under *Coil, Tuning, Sizes Required for*. The antenna taps may be made at 2, 3, 5, 8 and 12 turns as

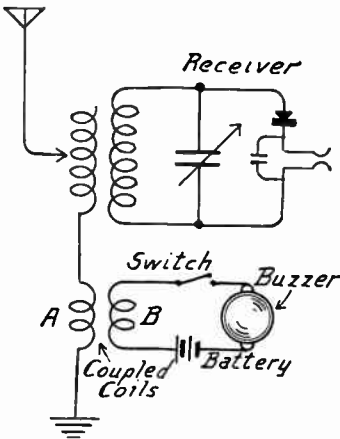

FIG. 3.—Circuit for Adjusting Crystal Contact.

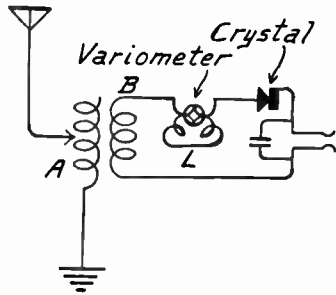

FIG. 4.—Variometer for Tuning Crystal Circuit.

shown, thus providing a good range of adjustment between extremes of selectivity and sensitivity. Like all receivers using no vacuum tubes this type will provide headphone reception only.

A receiver with loosely coupled antenna circuit is shown in Fig. 2. The antenna coil A may be built as shown and tapped at about

RECEIVER, CRYSTAL

every fifth turn or it may be untapped and mounted so that its coupling with the secondary coil L may be varied to provide the required selectivity. The coil L and condenser C are of such sizes as will cover the broadcasting band.

Fig. 3 shows a convenient method for allowing adjustment of the crystal to maximum sensitivity. The upper part of this circuit may be any kind of a crystal receiver. Between the ground and the tuning coil are two additional coils A and B each composed of three or four turns and loosely coupled with each other. Coil B is in series with a buzzer, a small battery for the buzzer and a switch. With the switch closed and the buzzer operating the buzzer signals may be heard in the headphones while the crystal contact is adjusted. The switch is then opened and the receiver is used for reception as usual.

The circuits of Figs. 1 to 3 use a variable condenser for tuning to resonance. It is also possible to use a variable inductance as

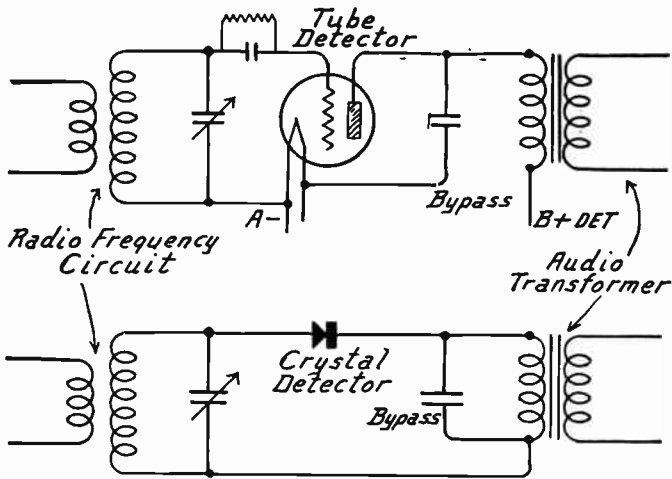

FIG. 5.—Substitution of Crystal for Tube Detector.

shown in Fig. 4. A variometer is used at L . The antenna coil A may be tapped as in Figs. 1 or 2 or it may be arranged for rotation in securing variations of coupling for selectivity. The coil B need be of only ten or twelve turns at the most.

Changing from Tube to Crystal.—It is sometimes desired to substitute a crystal detector in place of a vacuum tube detector already built into a receiver. This may be done as indicated in Fig. 5. The upper part of the drawing shows the detector stage of any vacuum tube receiver. At the left is the radio frequency transformer or antenna coupler with its tuning condenser. At the right is shown an audio frequency transformer which might be replaced with either a resistance or choke coil coupling.

In the lower part of Fig. 5 the crystal has been inserted in place of the tube. The tube and its grid leak and condenser are disconnected. The crystal is placed between the end of the tuned cir-

RECEIVER, FOUR-CIRCUIT

circuit formerly connected to the grid of the tube and the plate connection of the audio transformer or other coupler. The small bypass condenser formerly connected from the plate of the tube to one of its filament circuits is now connected across the primary of the audio transformer or coupler. The B-battery or power unit is disconnected from the detector plate terminal of the receiver and a wire is placed between this terminal and the tuned circuit.

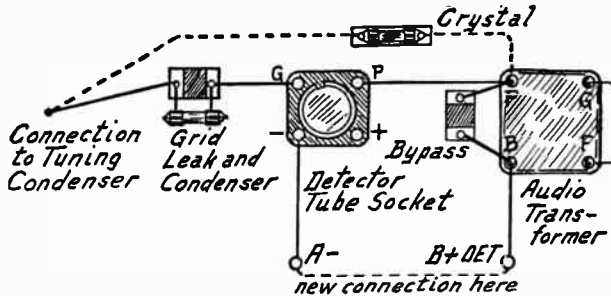
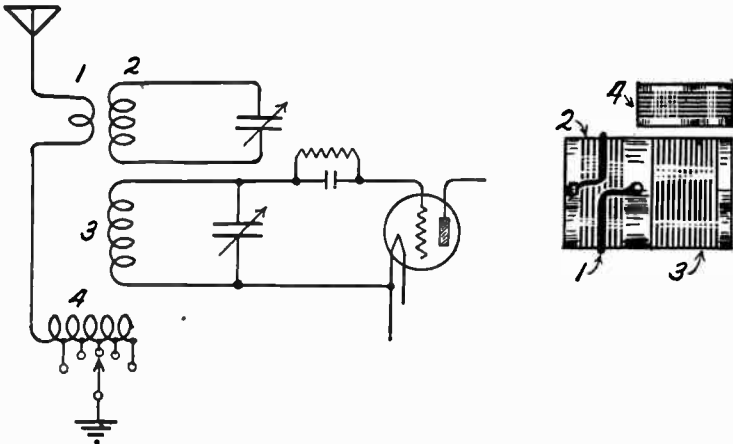

FIG. 6.—Using Crystal in Place of Tube Detector.

These changes as actually made in the receiver are shown in Fig. 6. The tube is removed from its socket. The battery wire is taken off the *B+ Detector* terminal. The crystal is connected from the tuned circuit at the left to the audio transformer at the right, jumping the grid leak and condenser. If the leak is connected from the grid terminal to the negative or positive filament terminal of the tube, the leak should be removed entirely. The bypass condenser is connected across the audio coupling device and the *B+ Detector* of the transformer is connected to the *A-* terminal on the receiver.

RECEIVER, FOUR-CIRCUIT.—The connections for a four-circuit or link circuit receiver are shown in the diagram. The antenna is roughly tuned by the tapped coil 4 and the antenna circuit



Circuits of Four-Circuit Receiver.

RECEIVER, LONG WAVE

is coupled to the grid circuit of the first tube through coils 1 and 2. Coil 1 consists of a single turn. Coil 2 is tuned to resonance with a variable condenser, this coil 2 providing a link coupling between 1 and 3. Coil 3 is likewise tuned to resonance with a second variable condenser, this combination being connected in the grid circuit of the detector tube.

The arrangement of the coils or windings is shown at the right. Coil 4 is placed in non-inductive relation with coil 3 and has an exceedingly small coupling with coils 1 and 2.

RECEIVER, LINK CIRCUIT.—See *Receiver, Four-Circuit.*

RECEIVER, LONG WAVE.—A great deal of the commercial and Government radio telegraph communication is carried on with the so called "long waves," the wavelengths above 600 meters and extending to 15,000 meters. The circuits of a receiver suited for these long waves or low frequencies are shown in the diagram. Layout, wiring and specifications are also given.

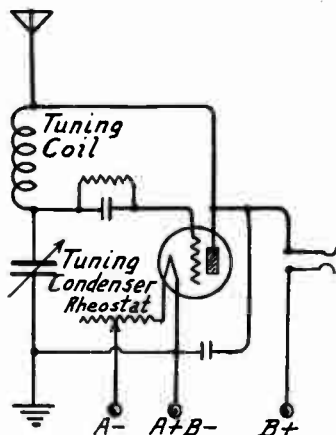

Long Wave Receiver.

The tube may be any of the usual amplifying types. Receiving is done with the tube in an oscillating condition so that a beat note is produced between the tube and the incoming signal. The variable tuning condenser is of .001 microfarad or 1000 micro-microfarad capacity. The tuning coil is made of various sizes according to the wavelength to be received. The mounting for this coil should be such that the coil itself is easily removed and replaced with a different size.

For listening to transmission at 600 meters a honeycomb coil of 100 to 150 turns is used; for use between 2600 and 5000 meters it is of 750 turns; and for 5000 to 15,000 meters 1500 turns are required.

The rheostat should be of from twenty to thirty ohms resistance, since it is used to control regeneration and oscillation. The grid condenser is of the usual .00025 microfarad capacity and the leak may be of two megohms re-

RECEIVER, SHORT WAVE

sistance. About forty-five volts should be used for the plate when employing a hard tube. All receiving with the outfit shown is with headphones, although one or more stages of audio frequency amplification may be added for loud speaker work. The antenna should be 100 feet or more in length.

There is little tendency for regeneration in circuits and tubes used on long wavelengths or low frequencies and when signals are to be received from stations of comparatively low power, or from those at great distances, it often is necessary to use additional radio frequency amplification or else to provide additional feedback in the detector circuits.

The majority of messages transmitted on long waves are in the telegraphic code, very little telephone work being handled on frequencies lower than those which limit the broadcast band. Marine signalling is carried out on a wavelength of 600 meters or a frequency of 500 kilocycles for distress calls and for other work which does not interfere with such calls. Radio beacons operate between 950 and 1050 meters and radio compass service is carried on in the wavelengths between 770 and 850 meters.

Trans-oceanic telegraphy is handled to a large extent on the still longer waves. The international calling wave for air service is 333 kilocycles or 900 meters wavelength.

RECEIVER, SHORT WAVE.—Wavelengths below those in the broadcasting band are used for radio telegraphy and also for a considerable amount of radio telephone work among the amateurs and for such work as rebroadcasting. Receivers for use on these short waves or high frequencies must be designed to avoid the harmful effects of uncontrolled oscillation from the many feedbacks that take place easily at the high frequencies.

Practically all short wave receivers consist of a regenerative detector without any radio frequency amplification other than that provided in the action of regeneration. Radio frequency amplification, except with screen grid tubes, is so hard to control that its use adds little if any to the sensitivity of such receivers. One or more stages of audio frequency amplification may be added if desired for loud speaker operation.

The regeneration should be obtained with a fixed tickler, that is, with a tickler which is not turned or rotated to change the amount of regeneration. Several forms of fixed tickler are shown under *Regeneration, Methods of Obtaining*. The types controlled with a variable condenser in the feedback circuit will be found satisfactory or the resistance controlled types may be used if preferred. The condenser control may be better for the shorter wavelengths.

One type of short wave receiver is shown in Fig. 1. The antenna coil *A* must be very loosely coupled to the grid coil *L*. The grid coil *L* is tuned by the variable condenser. The tickler coil *T* consists of a few extra turns on the end of the grid coil. Regeneration is controlled by the variable condenser *R*. A radio frequency choke coil is placed between the audio transformer and the plate of

RECEIVER, SHORT WAVE

the detector tube. The grid leak may be of from two to ten megohms resistance and the grid condenser of .00025 microfarad capacity.

Another type of short wave receiver is shown in Fig. 2. The filament circuit of this outfit is grounded. The antenna coil *A* should be very loosely coupled to the grid coil *L* and the tickler coil *T* may be placed very close to the grid coil. The number of turns in the tickler coil may be from one-third the number of turns in the grid coil up to the same number as in the grid coil. Tuning is done with a variable condenser and regeneration control is with variable condenser *R*. The radio frequency choke is placed as in Fig. 1. This radio frequency choke may often be replaced with a resistance of from 25,000 to 50,000 ohms with good results.

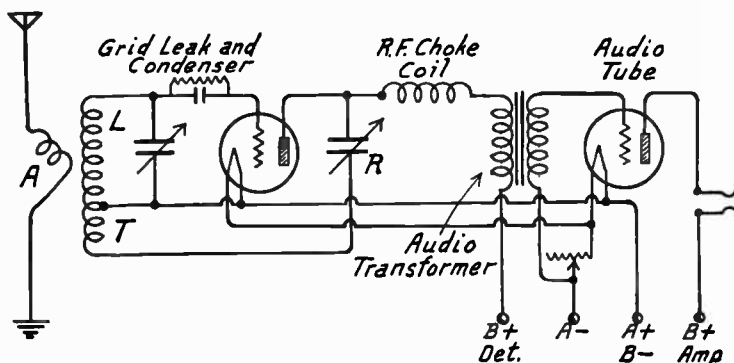

FIG. 1.—Short Wave Receiver.

All three coils; antenna, grid and tickler; should be wound on high grade tubing. The supports must contain the least possible amount of dielectric and no metal. The windings may be held together with a little collodion. Single or double cotton covered wire of 14 or 16 gauge is satisfactory. The turns are space wound. The following table shows the number of turns required in coils of three-inch diameter when wound ten turns to the inch (spaced) and when used with tuning condensers of various maximum capacities.

The number of turns specified in the table applies to coil *L* in the receivers. The coils must be changed in order to receive the several wave bands in which short wave transmission may be heard.

TURNS REQUIRED FOR SHORT WAVE COILS

Coils 3-inch diameter, spaced 10 turns per inch, with minimum dielectric					
Maximum Capacity of Condenser in Microfarads	Tuning Range in Meters				
	200 to 65	150 to 50	100 to 35	50 to 17	25 to 8
0.0001	61	38	20.5	8	3
0.00015	44	28	16	6	2
0.00025	29	19	11	4	1.5

RECEIVER, SHORT WAVE

Almost any antenna may be used. Outdoor antennas from twenty-five to fifty feet long give good results and indoor antennas may often be used with success. All antenna connections must be well made and of low resistance. If operation is found to be uncertain at some wavelengths, due to the natural frequency of the antenna system, the trouble may be overcome by connecting a fixed condenser of from .0001 to .00025 between the antenna lead-in and the antenna terminal on the receiver. The layout and specifications for a short wave receiver are shown.

For receiving radiophone signals, speech and music, the receiver is kept just below the oscillating point. Regeneration is used, but is not allowed to break over into oscillation. When receiving radio telegraph signals the receiver is used in an oscillating condition.

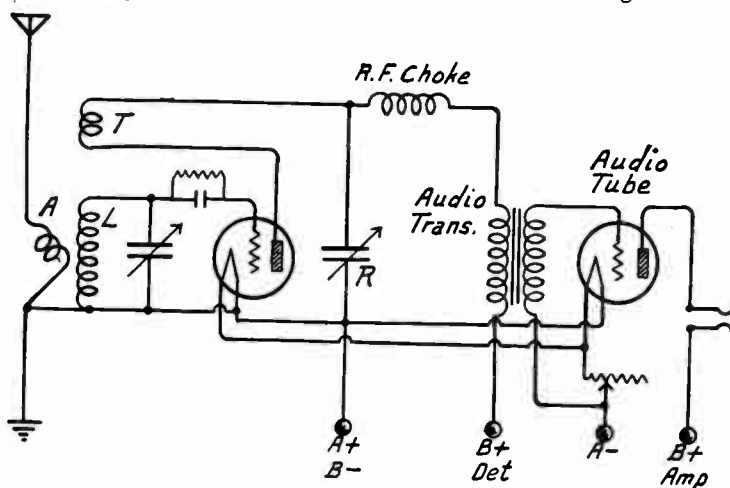

FIG. 2.—Second Type of Short Wave Receiver.

The oscillation or regeneration control is turned up until oscillation starts and is then turned back until just above the oscillation point for most satisfactory reception.

Since the coils of short wave receivers are generally of the plug-in variety, they may be subjected to rather rough handling. This makes it advisable to sacrifice some electrical efficiency to gain the needed mechanical strength. Binders of good quality should be applied to hold the turns in place. Either phenol compounds or hard rubber may be used in the coil form or tubing.

Shielding is almost always helpful in receivers of this type and is found to introduce but very slight loss. Wire sizes around number 14 and number 16 show the best all-around efficiency. Still larger sizes are also good but the resistance increases very rapidly from number 18 up, a number 26 wire showing three times the resistance of number 14.

RECEIVER, SINGLE CIRCUIT

RECEIVER, SINGLE CIRCUIT.—A single circuit receiver is one in which the antenna is directly connected to the grid circuit of the detector tube. In two-circuit, three-circuit or four-circuit

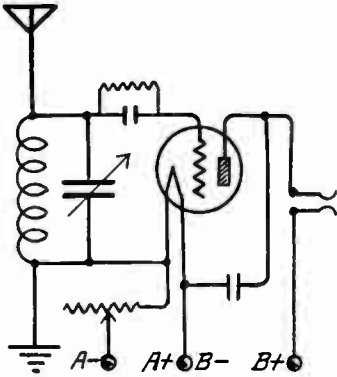

FIG. 1.—Single Circuit Receiver with Parallel Condenser.

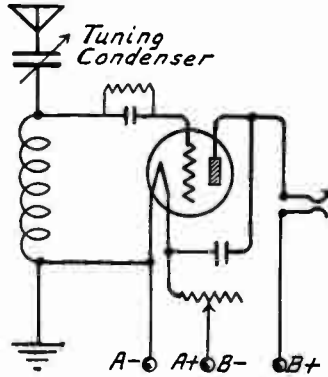

FIG. 2.—Single Circuit Receiver with Series Condenser.

receivers the antenna is more or less loosely coupled with the grid circuit of the detector. Single circuit receivers may be used when regeneration is not employed. With regeneration they become transmitters and re-radiate badly.

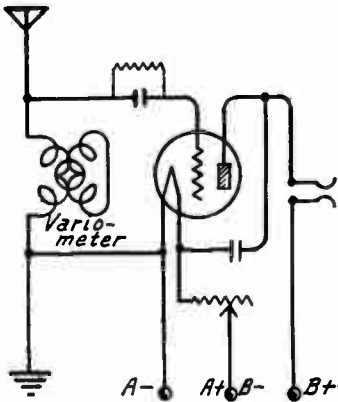

FIG. 3.—Single Circuit Receiver with Variometer Tuning.

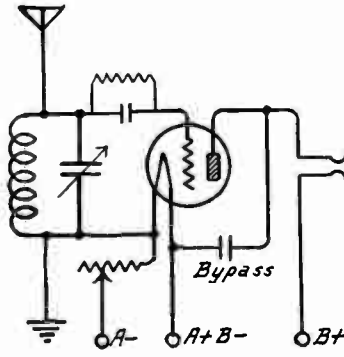

FIG. 4.—Single Circuit Receiver with Negative Grid Return for Soft Detector Tube.

Fig. 1 shows a single circuit receiver with a tuning condenser across the grid coil. Fig. 2 shows a receiver of this type tuned by means of an antenna series condenser. Fig. 3 shows a single circuit receiver with variometer tuning. Fig. 4 shows a negative grid return for the receiver of Fig. 1.

RECEIVER, SUPERHETERODYNE

RECEIVER, SUPERHETERODYNE.—In the superheterodyne type of receiver the incoming signals are changed from their original frequency to a new frequency at which they are amplified. This new frequency is much lower than the frequency of the carrier wave coming to the antenna or loop of the receiver, yet it is well above any audible frequency. All signal frequencies are changed into the new frequency at which all of the amplifying stages of the superheterodyne receiver are designed to operate most efficiently. For example, if a superheterodyne receiver is designed to amplify

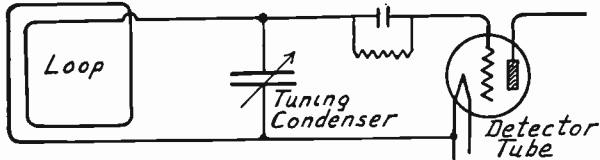

FIG. 1.—Tuned Loop Connected to a Detector as Used in a Superheterodyne Receiver.

at a frequency of thirty kilocycles, all incoming signals are first changed to thirty kilocycles before amplification. Signals of 1500 kilocycles or of 550 kilocycles all are changed to the same thirty kilocycles. This change of signal frequency is the principal difference between the superheterodyne and other receivers. A much greater degree of amplification is obtainable at the comparatively low amplifying frequency than can be had at the usual radio frequencies used in tuned radio frequency amplifiers.

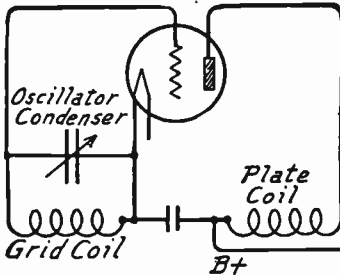

FIG. 2.—Simple Form of Oscillator Used in Superheterodyne.

The foundation of the superheterodyne principle is shown in the circuits of Figs. 1 and 2. Fig. 1 is the simplest possible radio receiving circuit consisting of a loop tuned with a condenser and connected to a detector tube. With the loop and condenser tuned to resonance at a certain frequency, signals of that frequency will be received and impressed on the grid of the tube in the usual manner.

Fig. 2 shows one of the simplest forms of oscillator. A coil in the plate circuit of a tube is inductively coupled to a coil in the grid circuit of the same tube so that energy from the plate circuit will be fed back into the grid circuit. The coil in the grid circuit is tuned with a variable condenser and the system will oscillate at the frequency to which the grid coil and variable condenser are tuned to resonance. This frequency may be made anything within the range of the coil's inductance and the condenser's capacity. The operation of such oscillators is described under *Oscillator*.

RECEIVER, SUPERHETERODYNE

In the circuit of Fig. 1 we may receive the frequency of any signal, that is, we may have in this circuit the frequency at which the signal is coming to the loop. In the circuit of Fig. 2, the oscillator, we may produce any desired frequency independently of all external forces or signals. If the circuit of Fig. 2 is coupled to the circuit of Fig. 1, the two frequencies, one in each circuit, may be made to produce a new and different frequency, a beat frequency. The production of a beat frequency from two other frequencies is explained under *Beats, Formation of*.

In Fig. 3 the two circuits have been coupled. The oscillator circuit is exactly like that of Fig. 2. The only change between the loop circuit of Fig. 1 and the loop circuit of Fig. 2 is in the insertion of a coupling coil or pickup coil between the loop tuning condenser and the detector tube grid. The detector of Fig. 1 is now properly called the frequency changer but is generally called the "first detector" of the superheterodyne.

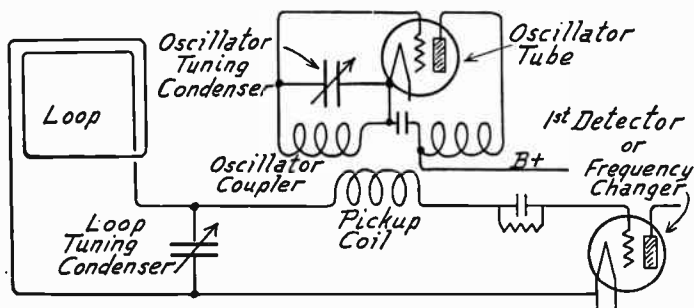

FIG. 3.—Oscillator and Loop Circuit Coupled for Frequency Changing in Superheterodyne.

In Fig. 3 we have two tuning condensers. One is the oscillator tuning condenser and the other is the loop tuning condenser. The oscillator coupler consists of three coils; one in the plate circuit of the oscillator, one in the grid circuit of the oscillator and the third in the grid circuit of the frequency changer of first detector tube.

The rise and fall of current in the plate circuit of the frequency changer or first detector will be in accordance with the beat frequency produced by the mixing of the loop tuned frequency and the oscillator tuned frequency. This beat frequency will still carry the modulation of the signal received by way of the loop. Various beat frequencies are selected by designers of these receivers. Some superheterodynes use beat frequencies as low as thirty kilocycles, others use as high as two hundred cycles.

The beat frequency is called the intermediate frequency and it is amplified by several stages of amplification which make up the intermediate frequency amplifier. A typical intermediate frequency

RECEIVER, SUPERHETERODYNE

amplifier is shown in Fig. 4. The first detector is at the extreme left. This tube feeds into the first of three intermediate frequency transformers and the transformer in turn feeds into the first intermediate frequency amplifying tube. This tube is followed by another transformer, a second intermediate tube, still another transformer and then comes the second detector.

This second detector, at the right in Fig. 4, is a true detector and acts in just the same way that a detector tube acts in any radio receiver. The particular circuit of Fig. 4 utilizes two intermediate frequency tubes. It is general practice to use at least three intermediate tubes and four or even more are sometimes found. The number of intermediate stages does not in any way alter the principle of operation since they are all practically alike.

The intermediate frequency transformers may be either of the iron-core or air-core type. Iron-core construction is quite generally

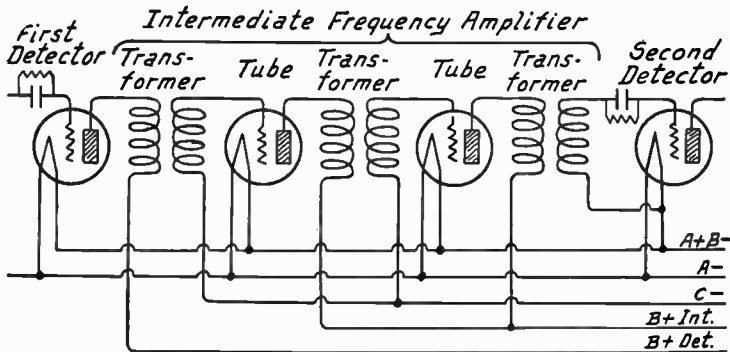

FIG. 4.—Two-Stage Intermediate Amplifier of Superheterodyne.

used for all except either the first or last transformer in the intermediate frequency amplifier. One of these transformers may be of air-core construction with its secondary tuned by a fixed or variable condenser.

The intermediate transformers are constructed to amplify the chosen frequency very efficiently by having their inductances suited to handle this frequency with greatest transfer of power. They are tuned rather broadly to the intermediate frequency used in the receiver so that each intermediate stage increases the strength of the desired signal while at the same time filtering out all other signals that might have come through the first detector. It is the number of amplifications and filtering processes at the intermediate frequency that gives the superheterodyne its fine selectivity and extreme sensitivity.

The audio amplifier that follows the second detector may be of any type. The audio amplifier has nothing to do with the operation of the receiver as

RECEIVER, SUPERHETERODYNE

a superheterodyne since all the peculiarities of this receiver are contained in the circuits shown in Figs. 3 and 4. The audio amplifier may be of the transformer coupled type, the resistance type, the impedance type or any other arrangement that appeals to the designer or builder.

The principle of the superheterodyne may be summarized in Fig. 5 where all of the units are shown. Signals are picked up by the loop and pass into the frequency changer or first detector. Current at a different frequency is generated in the oscillator and this too passes into the frequency changer.

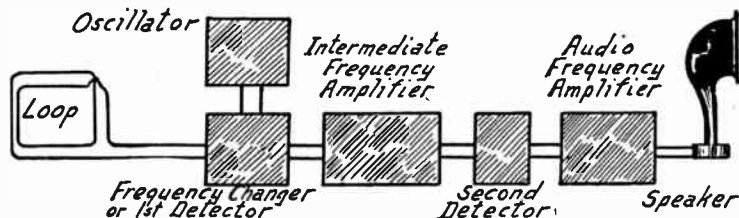

FIG. 5.—Principal Parts of the Superheterodyne System.

The new beat frequency or intermediate frequency comes out of the frequency changer and passes into the intermediate frequency amplifier. This intermediate frequency or beat frequency still carries the modulation of the original signal. The amplified intermediate frequency passes to the second detector where the audio frequency is separated from the intermediate frequency. The audio frequency from the second detector is then passed through the audio frequency amplifier where its strength is built up to operate the speaker.

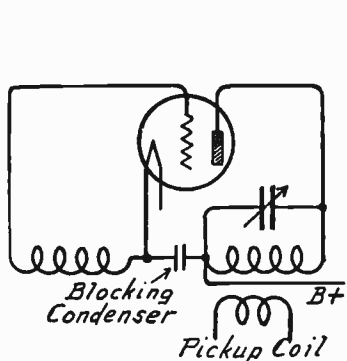

FIG. 6.—Oscillator with Tuned Plate Circuit in Superheterodyne.

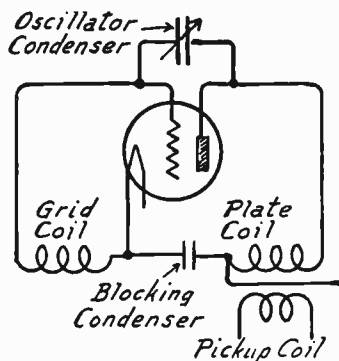

FIG. 7.—Oscillator with Tuning Condenser Across Both Coils in Superheterodyne.

Frequency Changers.—Almost any kind of oscillator circuit may be used with a superheterodyne receiver. One type is shown in Fig. 2. The oscillator in Fig. 6 uses a tuned plate, having the tuning condenser across the plate coil in place of across the grid coil as in Fig. 2. The oscillator of Fig. 7 has the tuning condenser connected across both coils. In all oscillator circuits it is necessary to use either the tuning condenser or separate fixed condensers as

RECEIVER, SUPERHETERODYNE

blocking condensers so that the direct high voltage for the plate circuit cannot reach the grid circuit which is connected to the filament of the tube. The only thing required of the oscillator is that it produces a strong output at the required frequency.

Some superheterodyne receivers do away with the separate oscillator tube entirely. This is accomplished by making the first

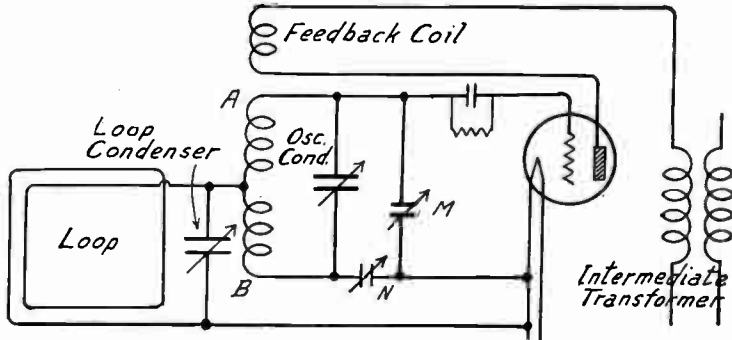

FIG. 8.—Autodyne Combination of Detector and Oscillator Tube.

detector tube or frequency changer into an oscillator. A regenerative circuit does the work of changing this tube into a self-heterodyne type so that it produces the frequency which is mixed with the signal frequency to form the intermediate frequency or beat frequency.

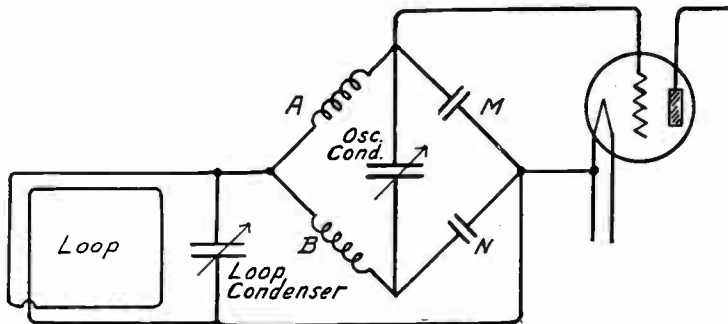

FIG. 9.—Bridge Circuit Equivalent of Autodyne Circuit.

The autodyne method of combining the first detector and the oscillator is shown in Figs. 8 and 9. The circuit connections are made as in Fig. 8. The loop is tuned by a condenser. Loop signals are carried through the circuit containing coil *A* and are impressed on the grid of the tube. The oscillator circuit is composed of coils *A* and *B* which are tuned by the oscillator condenser connected across both of them. Energy for exciting the oscillator circuit is introduced through the feedback coil which is in the plate circuit of the tube. The frequency at which the oscillating circuit operates is determined

RECEIVER, SUPERHETERODYNE

by the inductance of coils *A* and *B* and the capacity of the oscillator condenser, the feedback coil serving only to furnish the required energy. This oscillator circuit is connected to the grid circuit of the tube so that oscillating voltages of the required frequency are impressed on the tube's grid.

It is thus seen that the grid of the tube is acted upon by the signals from the loop and by the oscillator frequency at the same time. The first intermediate frequency transformer is shown. The remainder of the receiver does not differ from the system shown in Fig. 4.

The action may be made clearer by an examination of Fig. 9. Here coils *A* and *B*, also the oscillator condenser and condensers *M* and *N*, are the same as similar parts bearing the same designations in Fig. 8. Coils *A* and *B* together with condensers *M* and *N* form the four arms of a bridge circuit which is balanced by setting the small variable condensers *M* and *N*. The action of

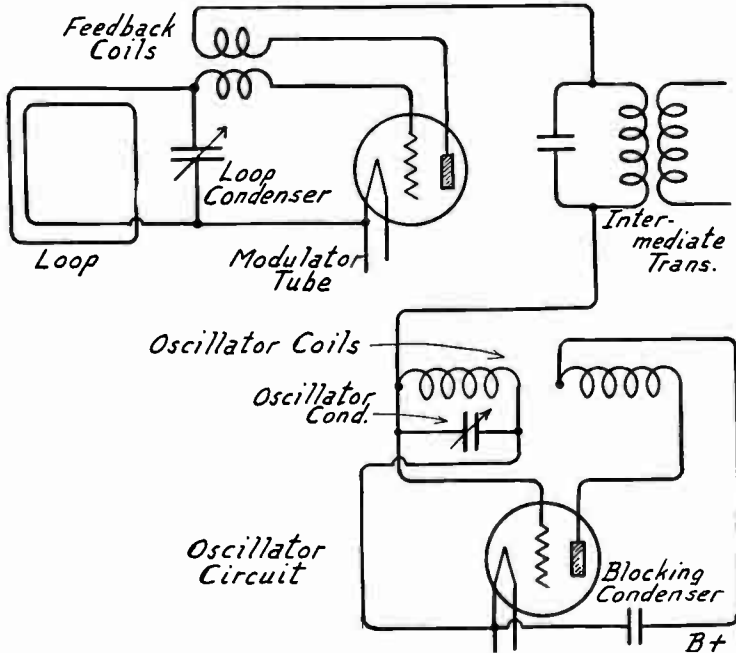

FIG. 10.—Circuits of Ultradyne Frequency Changer.

a bridge circuit is explained under *Balancing*. Signals from the tuned loop pass through the bridge circuit without being affected or changed by the parts included in the balance. The tuning of the oscillator circuit, which is the bridge circuit, is not affected by the loop signals which are passing through it. Therefore it is possible to impress the two frequencies on the grid of the one tube at the same time.

Still another method of producing the beat frequency or intermediate frequency is shown in Fig. 10 which illustrates the principle of the Ultradyne receiver. The loop is tuned by the variable condenser in the usual way and the signals are impressed on the grid of the modulator tube which takes the place of the first detector or frequency changer.

RECEIVER, SUPERHETERODYNE

A separate frequency is generated in the oscillator shown in the lower part of Fig. 10. The grid circuit coil is tuned by the oscillator condenser and is coupled with the coil in the plate circuit of the oscillator tube. The plate of the modulator tube is not connected to a B-battery or plate supply unit in the usual way, but is connected to the oscillator as shown. Through the coupled feedback coils in the grid and plate circuits of the modulator tube, the oscillations from the oscillator are impressed on the grid of the modulator.

The plate circuit of the modulator tube is thus supplied continuously with the high frequency oscillations from the oscillator, the frequency of these oscillations being determined by the setting of the oscillator condenser. These oscillations sent into the modulator tube are modulated by the signal coming from the tuned loop. Thus the grid of the frequency changer tube, which in this case is the modulator, receives two frequencies. One is the oscillator frequency and the other the signal frequency from the loop. These two frequencies combine to form the beat frequency or the intermediate frequency as in any other type of superheterodyne.

The oscillations applied to the plate of the modulator cause the plate to be positive during one-half of each cycle and negative during the other half. The plate resistance of the tube is therefore varied, being practically infinite during half the cycle and of normal value for the tube used during the other half. The signal voltages impressed on the modulator tube grid also affect the flow of current in the plate circuit so that the two effects combine in the beat frequency.

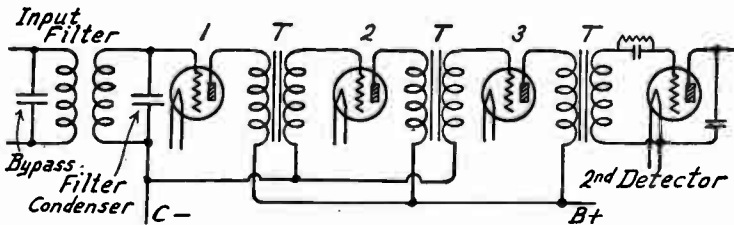

FIG. 11.—Intermediate Amplifier with Input Filter for Superheterodyne Receiver.

Intermediate Amplifier.—The intermediate amplifier as shown in Fig. 4 consists of several stages, each made up of an amplifying tube and a coupling transformer. In actual construction this intermediate amplifier often includes one stage that is rather sharply tuned to the frequency used by the particular receiver in question and of two or more other stages which are not so sharply tuned. The transformer for the sharply tuned stage is called the filter.

The transformers may be of the air-core type or may be built with a small iron core. Some of the transformers may be of the iron-core type and the balance of the air-core type. Iron-core transformers are comparatively broad in tuning while those of air-core construction are inherently sharp tuning. When all of the transformers are of the air-core type the tuned filter transformer is often dispensed with because the needed filtering action is obtained in the series of rather sharply tuned air-core units working together.

The principal connections for one type of intermediate frequency amplifier are shown in Fig. 11. The left hand transformer, which follows the first detector, is of the air-core type with a tuning condenser across the secondary

RECEIVER, SUPERHETERODYNE

windings, thus forming a sharply tuned filter. A bypass condenser is across the primary. When the filter transformer follows the first detector and is the first transformer in the intermediate amplifier, it is called an input filter. When the filter is used at the output end of the intermediate amplifier, just ahead of the second detector as in Fig. 12, it is called an output filter.

The intermediate amplifying tubes in Figs. 11 and 12 are numbered 1, 2 and 3. The iron-core intermediate transformers are marked *T* in both diagrams. The same plate voltage or B-battery voltage is generally applied to all intermediate tubes and their grid returns are generally brought to a common grid bias such as the C-battery connection indicated in Fig. 11.

In Fig. 12 the filter is at the output end of the intermediate amplifier and the first transformer, at the left hand end, has its primary bypassed by a fixed condenser. This condenser bypasses both the signal frequency and the oscillator frequency which exist in the plate circuit of the first detector. This leaves only the intermediate frequency or beat frequency to go through the transformer primary for amplification. The condenser across the primary of the input filter transformer in Fig. 11 serves the same purpose of bypassing the unwanted frequencies. Resistances are sometimes used in place of condensers for this bypassing around the first transformer.

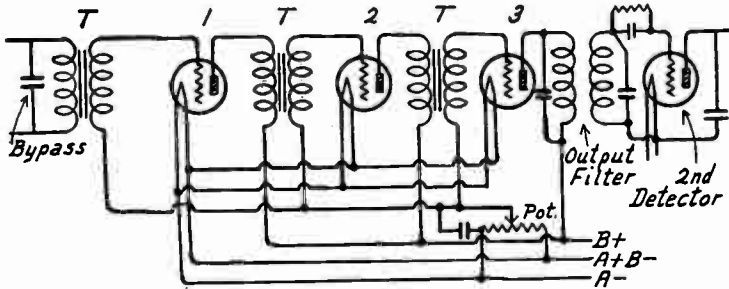

FIG. 12.—Intermediate Amplifier with Output Filter.

Filter transformers are almost always of the air-core type and built with loose coupling between primary and secondary. Because of the difficulty of obtaining fixed condensers with capacity sufficiently uniform and accurate for tuning, the filter transformer is often fitted with a variable condenser as indicated in Fig. 13. In some superheterodynes all of the intermediate transformers have their secondaries tuned with variable condensers.

Because of the broad tuning of iron-core transformers they amplify quite well over a fairly broad band of frequencies and there is little difficulty in obtaining complete sets of these transformers which will work well together. But with an intermediate amplifier using air-core transformers in all stages it is generally necessary to match the several units quite closely if the best results are to be obtained. These transformers should have a fairly sharp peak of resonance at the frequency employed in the intermediate stages of the receiver. That is, with a superheterodyne designed to amplify at thirty kilocycles, all of the intermediate transformers should be tuned more or less sharply to thirty kilocycles. Air-core intermediate transformers may be matched closely according to the methods outlined under *Oscillator, Radio Frequency, Uses of*. For such work the oscillator frequency may be adjusted to the desired intermediate frequency by using coils of great enough inductance and all of the intermediate transformers may then be tested for their resonant peak.

RECEIVER, SUPERHETERODYNE

Choice of Intermediate Frequency.—The intermediate frequency or beat frequency at which a superheterodyne receiver is to operate must, of course, be above the audible range. Audio frequencies extend almost to 15,000 cycles or to fifteen kilocycles, consequently the low limit of intermediate frequency must be at least twenty kilocycles and in actual practice thirty kilocycles is about the lowest practical frequency.

The great amplification which is characteristic of superheterodyne receivers is largely due to this amplification being carried out at low frequencies. The possible amplification with transformer coupling is limited by stability or freedom from uncontrollable oscillation. The lower the frequency the greater will be the stability and consequently the greater the amplification, the power and the sensitivity of the receiver. From this standpoint it is desirable to work at the lowest possible intermediate frequency.

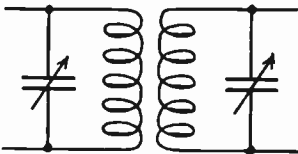

FIG. 13.—Filter Transformer with Both Windings Tuned in Superheterodyne.

To offset the advantages of low intermediate frequencies there are rather serious disadvantages. The lower the intermediate frequency the closer it comes to audible frequencies and the greater will be the amplification of all kinds of low frequency noises such as static and power line types of interference.

Low frequency amplifiers are less selective per stage than high frequency types so that very low frequencies sacrifice selectivity. By using at least three intermediate stages and by using a good filter or using all air-core transformers it is possible to obtain ample selectivity regardless of the intermediate frequency employed.

As will be shown in the following explanation of tuning characteristics of superheterodyne receivers the lower the intermediate frequency the closer together will be the signal frequency and the heterodyne or beat frequency. This may allow interference between nearby powerful stations and it also brings in each station at two points which are quite close together on the oscillator dial.

Regeneration in Superheterodynes.—The superheterodyne is generally designed as a loop operated receiver and regeneration may be obtained according to the methods shown and described under *Loop, Regeneration with*. This loop regeneration takes place in the circuit of the first detector or frequency changer tube and has no effect on the intermediate amplifier.

It is usually possible to obtain regeneration in the intermediate amplifier by bringing the grid returns through a potentiometer connected across the filament lines as in Fig. 12 where the potentiometer controls regeneration. This intermediate amplifier regeneration will be more effective when used with air-core transformers and will be more effective when used with a rather high intermediate frequency where operation is naturally less stable.

Regeneration may be applied to the second detector circuit of a superheterodyne when using an air-core output filter transformer. It is possible to employ many of the methods described under *Regeneration, Methods of Obtaining*.

Operation with Antenna and Ground.—The superheterodyne receiver has sufficient amplification so that a loop should provide ample signal energy for all purposes. Except under the most favorable conditions of location and weather, an antenna will bring in so much noise and static that the final result will be no better and may be worse than with the loop. Furthermore, a superheterodyne con-

RECEIVER, SUPERHETERODYNE

nected to an antenna becomes a very powerful radiator of interference because of the oscillations that are sent into the antenna circuit through the close coupling of the oscillator to the first tuned circuit of the receiver.

Methods of operating any loop receiver on antenna and ground are shown under *Loop, Antenna and Ground Connections to*. Any of these plans may be adopted with a superheterodyne originally designed for work on a loop alone.

Construction of Receiver.—

The arrangement of parts for a typical separate oscillator is shown in Fig. 14. The coupler consists of three windings, the grid winding, the plate winding, and the pickup winding which is usually arranged with variable coupling to the plate and grid coil combination. The oscillator condenser is connected across the plate and grid coils. The blocking condenser should be of .005 to .006 capacity. The grid and plate coils are both wound around the form in the same direction and are then connected as shown.

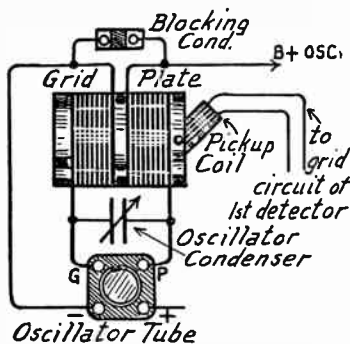

FIG. 14.—Oscillator Coupler for Superheterodyne.

Grid leaks and grid condensers for both detectors are of the usual values. The condensers are of .00025 microfarad capacity and the leaks of from two to five megohms resistance. Bypass condensers used in the intermediate amplifier must be of greater capacity than those used in ordinary radio frequency amplifiers because of the lower frequencies to be passed and because of the greater currents flowing in the superheterodyne circuits. The plate bypass condenser between the plate of the second detector tube and the filament circuit of that tube must be of at least .005 microfarad capacity. This condenser is shown in Figs. 11 and 12. All of the usual plate and grid circuit bypass condensers described under *Condenser, Bypass* may be applied to the superheterodyne.

Shielding is usually advantageous when using rather high frequency intermediate amplifiers. The oscillator tube, the oscillator variable condenser and the oscillator coupler should be enclosed together in one shield. The first detector tube and its condenser may be enclosed in a shield although this is not required if all other parts are shielded. The entire intermediate amplifier may be enclosed in one shield which surrounds the intermediate tubes and the intermediate transformers. Materials and methods for shielding are shown and explained under the heading of *Shielding*.

Any type of audio amplifier may follow the second detector. Various suitable amplifiers are described under *Receiver, Audio Amplifier for*. One stage of audio amplification should be ample for loud speaker work on stations within one or two hundred miles and two stages will give sufficient volume for any distance if the rest of the receiver is working properly. The layout, wiring and specifications for a complete superheterodyne amplifier will be shown.

RECEIVER, SUPERHETERODYNE

Tuning the Superheterodyne.—There are three tuning controls for the superheterodyne. One control is the loop tuning condenser, the second is the oscillator tuning condenser and the third is the orientation or turning of the loop to pick up maximum signal strength from a given station. The turning of the loop is not a critical control. The loop tuning condenser is rather sharp in its action although it does not generally require "hair line" operation. The oscillator condenser is critical and a change of one or two points on an ordinary dial will usually tune out a station completely.

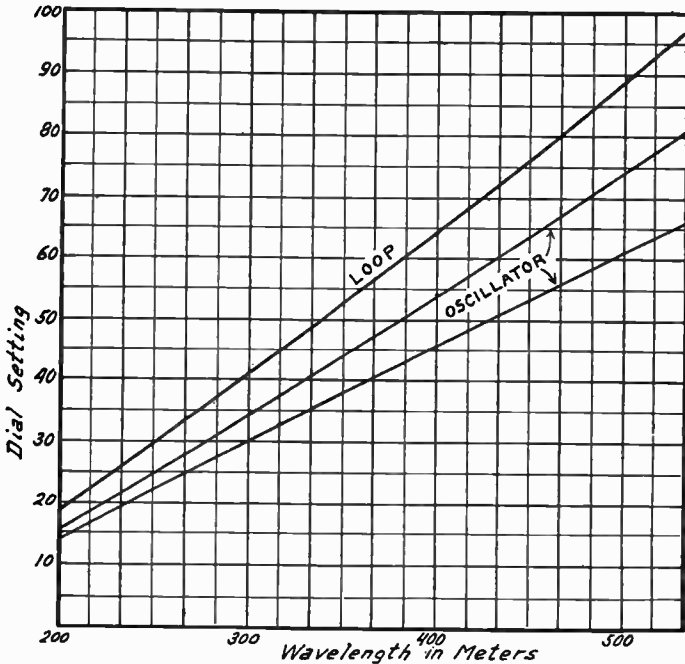

FIG. 15.—Typical Settings for Oscillator and Loop Dials of a Superheterodyne Receiver.

For any given frequency or wavelength to be received there is but one setting of the loop tuning condenser and stations operating at this frequency or wavelength should not come in at any other setting. There are two settings of the oscillator tuning condenser for each frequency or wavelength. This is because the same beat frequency or intermediate frequency will be produced by the difference between the signal frequency and oscillator frequency or by the sum of these two frequencies.

As an example in oscillator tuning, take a signal frequency of 750 kilocycles and assume the receiver to operate with an intermediate frequency of 30 kilocycles. The signal frequency of 750 kilocycles will be applied to the first

RECEIVER, SUPERHETERODYNE

detector or frequency changer by the tuned loop circuit. If the oscillator be tuned to a frequency of 720 kilocycles, this frequency will be subtracted from the signal frequency to produce the intermediate beat frequency of 30 kilocycles and the signal will be received and amplified. If the oscillator be tuned to a frequency of 780 kilocycles, the signal frequency of 750 kilocycles will be subtracted from this oscillator frequency to produce the intermediate beat frequency of 30 kilocycles and again the signal will be received and amplified. Therefore, there will be two points on the oscillator dial at which any one signal frequency will be changed into the same intermediate frequency.

Sometimes a signal will be handled better by using the higher oscillator frequency and again it may be better with the lower oscillator frequency. This is determined by trying both settings. It will sometimes be found that an undesired station interferes with the wanted station on one setting of the oscillator. Using the other oscillator frequency will then get rid of the interfering station.

While the two possible settings of the oscillator provide an advantage under some conditions as just mentioned, they often prove to be a disadvantage when there are many local stations. In the case of ten nearby stations there would be ten dial settings for an ordinary receiver, one for each station. With the superheterodyne there would be twenty possible settings for the oscillator dial. This makes the local stations come in at twenty points on the oscillator dial rather than at only ten points and tuning between these many settings is rather difficult.

Fig. 15 shows the relation between the loop tuning settings and the oscillator tuning settings for a typical superheterodyne using straight line wavelength condensers. With straight line frequency condensers the three lines would be practically straight with the lower scale laid out in frequencies in place of wavelengths. The less the intermediate frequency the closer together will be the two lines for the oscillator settings and the higher the intermediate frequency the greater will be the separation between these settings.

One of the chief objections to the early types of superheterodyne receivers was their lack of selectivity. With only a single tuned circuit preceding the grid of the first detector it was impossible to obtain satisfactory separation between transmitting stations. To overcome this trouble the majority of modern superheterodyne receivers have one or more stages of tuned radio frequency amplification ahead of the first detector.

In still other receivers there are modified or simplified band selector circuits combined with the tuned radio frequency amplification. Even though these tuned circuits between antenna and first detector do little in the way of amplifying the signal, they provide the needed selectivity. Amplification is easily added in the intermediate frequency stages.

These modern receivers are still further characterized by the use of rather high intermediate frequencies, by intermediate frequency transformers which are quite sharply tuned to resonance, and by the use of screen grid tubes. The high plate circuit impedances which it is possible to obtain in the fixed frequency intermediate stages allow very great gains in signal strength with the use of not more than two such stages.

RECEIVER, THREE-CIRCUIT

just before it changes to oscillation. This action keeps on as long as the receiver is in operation.

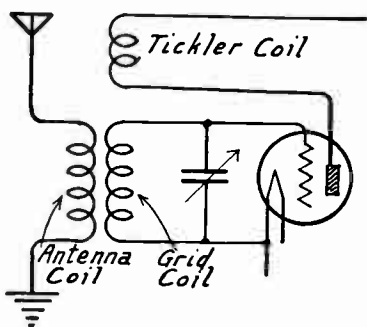

Three-Circuit Receiver.

The super-regenerative receiver is difficult to control, very critical in its adjustments, and because of the peculiar action in the grid circuit it lacks selectivity. Its great advantage is in the extreme amplification possible from a single tube. When audio frequency amplification is added it becomes necessary to place a filter circuit between the super-regenerative tube and the first audio frequency tube to prevent the oscillations from coming through

and being amplified with great volume.

RECEIVER, THREE-CIRCUIT.—A receiver of the regenerative detector type using a tickler coil for feedback is called a three-circuit receiver. The three coils are indicated in the diagram. One coil is in the antenna circuit, another is in the grid circuit and the tickler coil is in the plate circuit.

RECEIVER, TUNED RADIO FREQUENCY.—A tuned radio frequency receiver is a receiver employing one or more stages of amplification in which the inter-tube coupling is secured through inductances and capacities which are tuned to resonance at the frequency of the signal to be received. The tuned circuits of such a receiver using tuned radio frequency transformers are shown in the diagram. The antenna circuit coupler and the two radio frequency transformers are similar in construction. The diagram shows two radio frequency amplifying tubes followed by a detector. Tuning is done with the three variable condensers marked C.

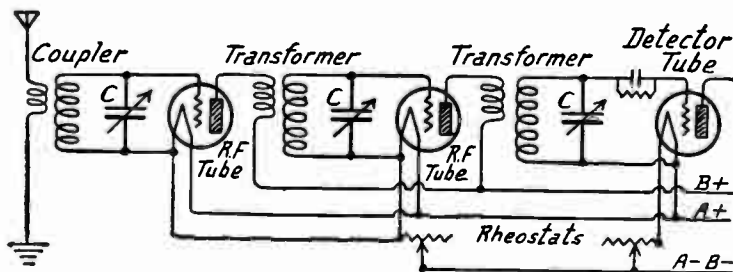

Radio Frequency Circuits of Tuned Radio Frequency Receiver.

Tuned radio frequency amplifiers using either tuned transformers, tuned impedances or tuning variometers are described under *Amplifier, Radio Frequency*. This general principle of amplification includes all receivers which use variable controls for preventing oscillation while allowing regeneration. It also includes

RECEIVER, TWO-CIRCUIT

all of the receivers using balanced circuits for overcoming the feedback through the internal capacity of the amplifying tubes.

Tuned radio frequency in some form or other is the most commonly used method of amplifying radio signals. All band selector circuits are forms of tuned radio frequency. The majority of receivers using screen grid tubes fall into this general classification. Modern types of superheterodyne sets have one or more stages of tuned radio frequency amplification used ahead of the first detector to improve the selectivity and prevent the annoying whistles which are caused by the beating of undesired signals with the intermediate frequency or with some of its harmonics. See also *Amplifier, Radio Frequency* and *Transformer, Tuned Radio Frequency*.

RECEIVER, TWO-CIRCUIT.—A receiver using an antenna coupler in which the antenna winding is physically separate from the grid winding is called a two-circuit receiver. The antenna is inductively coupled to the grid circuit of the first tube in a two-circuit receiver, while in a single-circuit receiver the antenna is conductively coupled to the grid circuit by a direct metallic connection.

RECEPTION, CONTINUOUS WAVE.—The modern system of radio telegraphy makes use of high frequency alternators, arcs or vacuum tube transmitters from which are sent radio waves that do not vary in amplitude and are called continuous waves.

The transmitter circuit is opened and closed by a key so that the continuous wave is broken up into the dots and dashes of the telegraphic code by means of which radio telegraphic messages are communicated.

RECEPTION, DAMPED WAVE.—The old system of radio telegraphy sent out waves which started off at maximum amplitude and gradually died away in amplitude due to damping in the circuit. Damped waves are produced by spark transmitters.

RECTIFICATION, GRID CURRENT.—See *Detector, with Grid Condenser and Leak*.

RECTIFICATION, PLATE CURRENT.—See *Detector, with Grid Bias*.

RECTIFIER, CHEMICAL.—See *Charger, Battery, Electrolytic Type*.

RECTIFIER, COPPER TYPE.—A layer of copper oxide on a piece of metallic copper causes the combination to offer very little resistance to passage of electric current in one direction but to offer comparatively great resistance to flow of current in the reverse direction. Such pieces may therefore be used as one-way electrical valves or rectifiers for alternating current since, when placed in an alternating circuit, they pass alternations of one polarity freely and to a great extent shut off those of opposite polarity.

The pieces of copper are oxidized on one side and are left bright and clean on the other. To carry the current to the oxidized surface a piece of lead or any other inert metal may be used by

RECTIFIER, COPPER TYPES

placing its surface in contact with the oxide. These copper oxide units may be placed in series with one another by alternating them with thin sheets of lead. They may be used in multiple by connecting the unoxidized sides of several pieces together on one side of the circuit and connecting the oxidized sides together on the other side of the line. The greater the voltage to be rectified the greater the number of pieces that must be used in series and the greater the current to be handled the greater the number of pieces in parallel.

The rectification is not perfect; it is nowhere as complete as with a rectifying vacuum tube. When using a copper oxide rectifier as a charger connected to a twenty-volt battery the back currents at various temperatures are as follows: At 86 degrees Fahrenheit, 0.6 ampere; at 104 degrees, 1.0 ampere; at 122 degrees, 1.5 amperes; and at 140 degrees, 1.75 amperes. This indicates the importance of running such rectifiers at moderate temperatures. The temperature increases with the current being carried and a sufficient number of units are connected in parallel to keep the current through each unit at a low value.

The connections of copper oxide units are made in practically the same way that is used for connecting electrolytic cells. The copper oxide type of rectifier is dependable and requires no care or upkeep of any kind when properly designed and built.

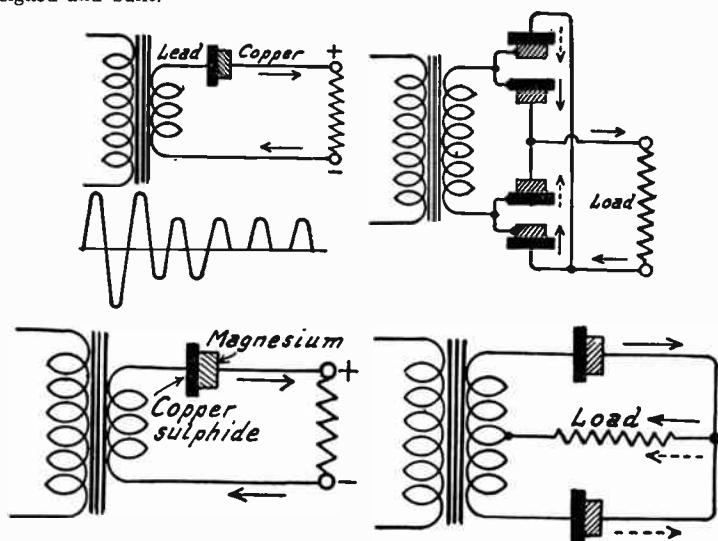

FIG. 1.—Copper Types of Rectifier. FIG. 2.—Full-wave Copper Rectifiers.

These rectifiers are well suited for handling rather heavy currents, their efficiency rising quite rapidly with increase of current until it becomes from fifty to seventy-five per cent. A current of about two amperes per square inch of surface may be passed before overheating becomes dangerous. A rectifying circuit is shown at the top of Fig. 1. The current flows into the couple by way of the lead and comes out of the copper, the copper being the positive terminal for the external circuit.

RECTIFIER, ELECTROLYTIC

Plates or discs of copper sulphate and of magnesium act as a rectifier because of the formation of a film which allows comparatively free flow of current from the sulphide to the magnesium and offers high resistance to flow the other way. Use of these substances in a rectifying circuit is shown at the bottom of Fig. 1. The copper sulphide rectifier may be operated up to about four volts for each contact. About one-half the applied voltage is used in the rectifier, the watts efficiency being nearly fifty per cent.

Copper contact rectifiers are generally arranged to provide full-wave rectification from a transformer as shown in Fig. 2 at the top. Couples are connected so that one piece of each material is attached to each end of the transformer. When the upper end of the transformer secondary becomes positive, current flow is in the direction of the full line arrows. With reversal of polarity in the transformer, making the lower end positive, current flow through the circuit is as shown by the broken line arrows. Full-wave rectification may also be provided with a transformer having a center tapped secondary winding as at the bottom of Fig. 2. With the top of the secondary positive, current flow is shown by full line arrows and with the lower end positive the current path is shown by the broken line arrows.

Rectifiers are made to operate at higher voltages than allowable across a single contact by assembling a number of couples in series. The elements are generally made in the form of washers and assembled on an insulated stud. Pressure is applied either by drawing nuts tightly on the ends of the supporting stud or by using heavy coiled springs. Heat radiating flanges are often assembled between couples.

RECTIFIER, ELECTROLYTIC.—See *Charger, Battery, Electrolytic Type*; also *Power Unit*.

RECTIFIER, FULL-WAVE.—A rectifier which rectifies both alternations or both halves of the alternating current is called a full-wave rectifier. Both the positive impulse and the negative impulse of the alternating current are passed through a full-wave rectifier. The resulting pulsating direct current has as many rises and falls of current as the alternating current has alternations, this being double the number of cycles.

RECTIFIER, GASEOUS.—See *Power Unit*.

RECTIFIER, HALF-WAVE.—A rectifier which rectifies only one of the alternations or one-half of the alternating current is called a half-wave rectifier. Only one impulse of direct current appears in the rectifier's output for each full cycle of the alternating current. The other alternation is not exactly wasted but simply is prevented by the rectifier from passing to the direct current output lines. The frequency of the pulsating current is the same as the alternating frequency.

RECTIFIER, MECHANICAL.—See *Charger, Battery, Vibrating Type*.

RECTIFIER, MERCURY ARC TYPE.—A rectifier for alternating currents which consists of a large vacuum tube containing mercury vapor and two pools of mercury. The tube has four electrodes, two being in the mercury pools and the other two in the walls of the tube. The two electrodes in the walls of the tube are negative and those in the mercury pools are positive when considered as a source of current for a battery being charged. The connections are shown in the diagram.

RECTIFIER, TANTALUM

An arc is maintained between the two electrodes in the mercury pools. This arc keeps some of the mercury in the form of a vapor which will permit the flow of current. Current will flow through the mercury vapor only from the side wall electrodes to the bottom electrode so that the tube acts as a rectifier.

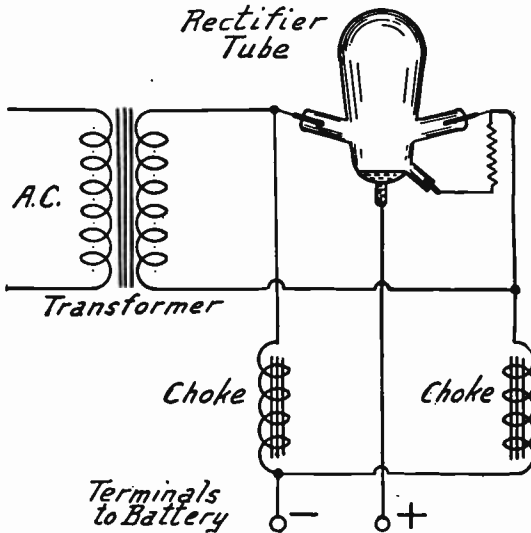

Circuits of Mercury Arc Rectifier.

RECTIFIER, RAYTHEON TYPES.—There are two types of Raytheon rectifiers, one a gaseous or helium filled tube described under *Power Unit* and the other a cartridge of which the metallic shell forms one terminal and a connection to an internal metallic alloy the other. Current flows freely from the outer shell into the center electrode which, in a charger, is connected to the positive terminal of the battery.

RECTIFIER, TANTALUM.—See *Charger, Battery, Electrolytic Type*.

RECTIFIER, THERMIONIC.—See *Tube, Rectifier Types of*.

RECTIFIER, TUBE TYPE.—See *Charger, Battery, Bulb Type; Tube, Rectifier Types of*, also *Power Unit*.

RECTIFIER, VIBRATING.—See *Charger, Battery, Vibrating Type*.

REDMANOL.—See *Phenol Compounds*.

REFLEXING, PRINCIPLES OF.—It is possible to use a single vacuum tube for the amplification of two different frequencies at one time, this being called reflexing. The principle is shown by the diagram in Fig. 1.

The operation of a reflex amplifier is shown in Fig. 2. The two frequencies travel as follows: High frequency or radio frequency

REFLEXING

is introduced from the winding 1 which is coupled with the winding 2 to form a radio frequency transformer. Voltage changes in winding 2 are impressed on the grid of the tube. The grid circuit is completed to the filament through the bypass condenser *A* which carries the high frequency around the high impedance of the iron-core transformer.

The high frequency output from the plate of the tube passes through the winding 3 which is coupled with winding 4 to make a transformer. The high frequency circuit is completed through the bypass condenser *B* from winding 3 to the filament circuit of the tube. Plate voltage from the B-battery is applied through the winding of the right hand air-core radio frequency transformer. The amplified high frequency appears in the winding 4.

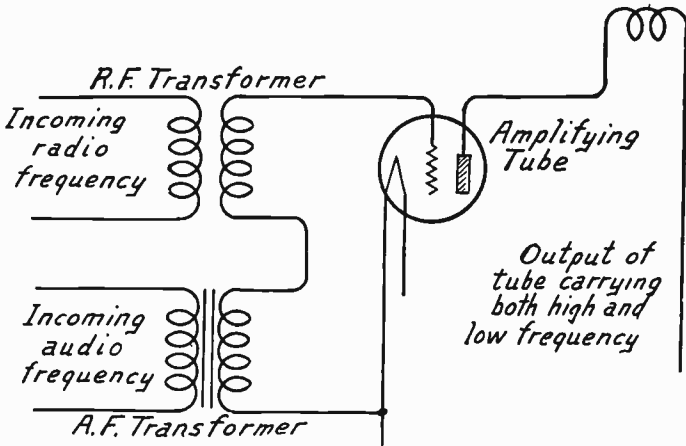

FIG. 1.—Effect of Reflexing on Amplifying Tube.

Still referring to Fig. 2 low frequency or audio frequency is introduced through the left hand audio frequency transformer. The audio frequency voltages pass to the grid of the tube through winding 2, the grid circuit being complete through the winding of the audio frequency iron-core transformer and winding 2 of the air-core radio frequency transformer. Bypass condenser *A* is of small capacity which offers a very high reactance to the low frequency, therefore does not bypass it but forces it through the winding of the audio transformer. Winding 2 of the air-core radio frequency transformer is of comparatively few turns, has no iron core, and is therefore of low reactance to the audio frequency voltages and offers practically no opposition.

The audio frequency output from the plate of the tube passes through winding 3 of the right hand radio frequency transformer. The reactance of this winding is very low to the audio frequency

REFLEXING

and it passes through with practically no opposition until the right hand bypass condenser *B* is reached. This condenser, being of small capacity, offers such great reactance that the audio frequency is forced through the winding of the right hand iron-core audio fre-

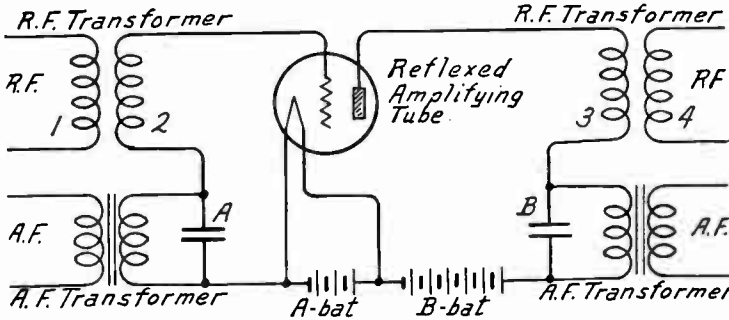

FIG. 2.—Circuits of Reflexed Amplifying Tube.

quency transformer. The audio frequency output then appears in the secondary of this transformer.

Reflex receivers provide two paths for the grid voltages and two paths for the plate currents of all reflexed tubes. One path carries the radio frequency current. This path is of low reactance to the radio frequency and of high reactance to audio frequency. The other part carries audio frequency current

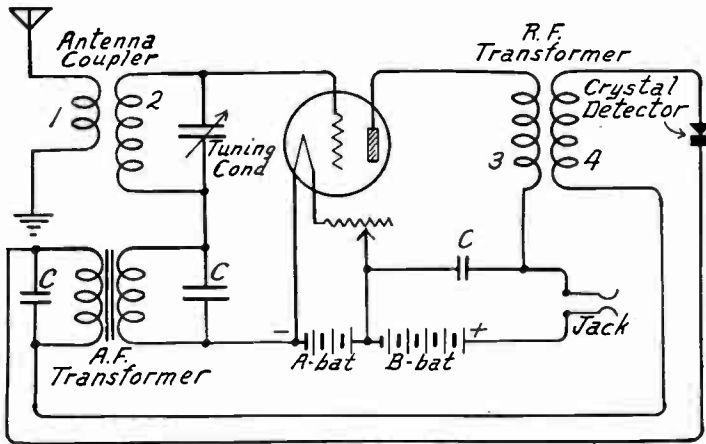

FIG. 3.—Single Tube Reflex Receiver with Crystal Detector.

and is of high reactance to the radio frequency. The two paths meet in the tube and in the batteries. The radio frequency circuit is always carried around the windings of iron-core transformers, speakers, etc. by bypass condensers.

Reflex Receivers.—A complete single-tube reflex receiver with crystal detector is shown in Fig. 3. Windings 1, 2, 3 and 4 of Fig. 3 correspond to similarly numbered windings of Fig. 2. The radio

REFLEXING

frequency output of transformer 3-4 passes through the crystal detector. The rectified output from the detector passes through the primary of the audio transformer. The audio frequency output from the secondary of the audio transformer reaches the grid of the tube through winding 2 and is amplified by the tube. The audio frequency output from the plate of the tube passes through winding 3 and to the jack to which is connected the speaker or headphones. Tuning is accomplished with the variable condenser across winding 2. Winding 1 is in the antenna circuit. The bypass condensers *C* in these receivers are usually of .001 microfarad capacity. The best value for the bypasses may be found by experimenting with condensers of from .00025 to .002 microfarad capacity.

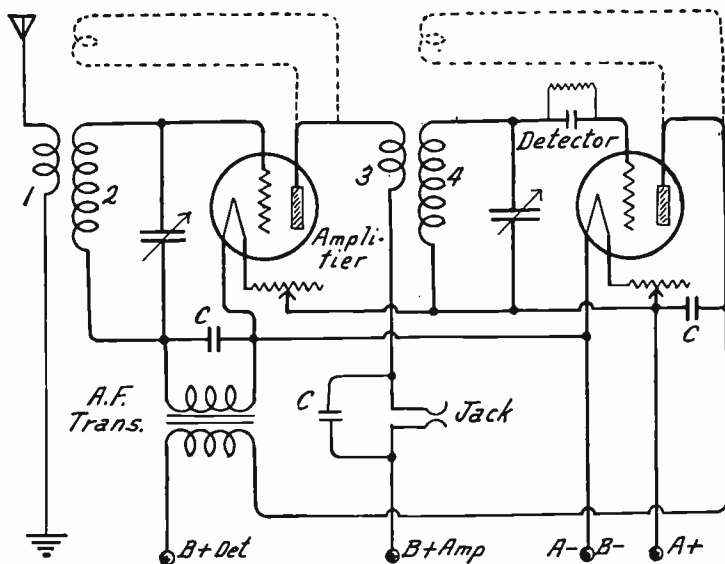

FIG. 4.—Reflex Receiver with Tube Detector.

Fig. 4 shows the circuits for a two-tube reflex receiver. This receiver employs a tube for its detector but is otherwise the same as the arrangement of Fig. 3. In Fig. 3 the radio frequency output from winding 4 is carried through the crystal. In Fig. 4 the output of winding 4 is carried to the grid of the detector tube. The output from the plate of the detector tube is carried to the primary of the audio frequency transformer, the B-battery or plate voltage supply for the detector being connected to the other end of this primary winding.

The output from the secondary of the audio frequency transformer is carried to the grid of the left hand amplifier tube and is amplified at audio frequency. From the plate circuit of this left

REFLEXING

hand tube the amplified audio frequency passes through winding 3 to the jack just as in Fig. 3. Tuning is accomplished by two variable condensers, one across winding 2 and the other across winding 4.

A three-tube reflex receiver is shown in Fig. 5. Tube number 1 is the first radio frequency tube and the second audio frequency tube. Tube number 2 is the second radio frequency tube and the first audio frequency tube. Tube number 3 carries the lightest radio frequency load and the heaviest audio frequency load. In tube number 2 this condition is reversed by carrying the heaviest radio frequency load and the lightest audio frequency load. This division of load is the inverse duplex principle devised by David Grimes. Tube number 3 is the detector and is not reflexed.

In this three-tube receiver tuning is done with the three variable condensers. Bypass condenser *A* may be from .002 to .005 micro-

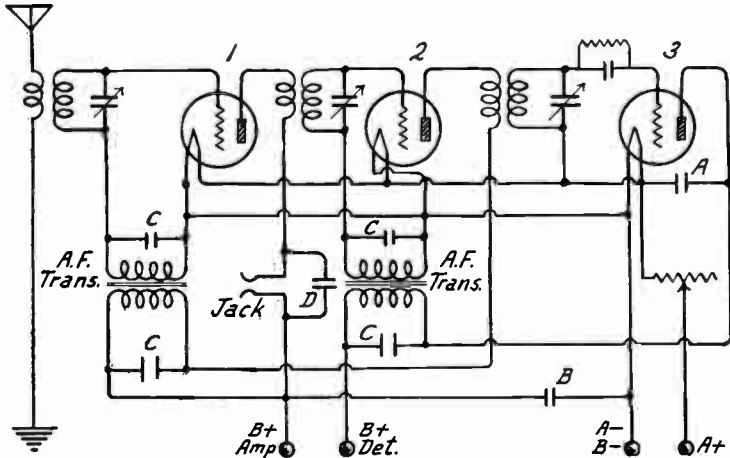

FIG. 5.—Three-Tube Reflex Receiver.

farad capacity, bypass *B* is of one microfarad or even greater capacity, bypasses *C* are of .001 microfarad capacity, and bypass *D* is of .002 microfarad capacity.

Regeneration may be applied to any reflex receiver either in the detector circuit or in the radio frequency tube circuits. Connections of tickler coils for regeneration are shown by broken lines in Fig. 4. While only the tickler coil method is shown, any kind of regeneration control may be applied to these receivers.

Reflex receivers have the advantage of saving in the number of tubes required for a given amount of amplification. For example, the single-tube receiver of Fig. 3 consists of one radio frequency stage, one audio frequency stage and a crystal detector. The receiver of Fig. 4 consists of one audio frequency and one radio frequency stage with a tube detector. The receiver of Fig. 5, while using only three tubes, provides two radio frequency stages and two audio frequency stages. A crystal detector might be substituted for the tube detector in Figs. 4 and 5. Reflex receivers are generally rather un-

REGENERATION, ACTION AND PRINCIPLE OF

stable and are more inclined to oscillate than receivers using separate tubes for radio frequency and audio frequency amplification. Any of the oscillation controls described under *Oscillation* may be applied to these receivers.

REGENERATION, ACTION AND PRINCIPLE OF.—

Regeneration is the action by which a part of the energy from the plate circuit of a tube is fed back into the grid circuit of the same tube. The plate circuit energy is added to the energy already in the grid circuit.

Fig. 1 shows a tube having one inductance coil in the grid circuit and another inductance coil in the plate circuit. The energy in the plate circuit is several times greater than the energy in the grid circuit. The grid circuit is called the input circuit of the tube and the plate circuit is called the output circuit of the tube. The signal coming to the tube is introduced into the grid circuit and the voltage changes in the signal cause corresponding voltage changes on the grid of the tube. These voltage changes on the grid control the flow of current in the plate circuit.

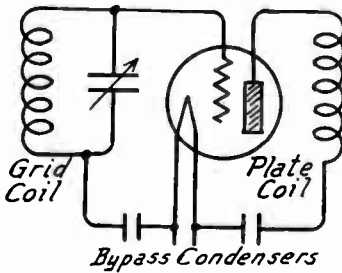

FIG. 1.—Grid and Plate Coils Entering into Regeneration.

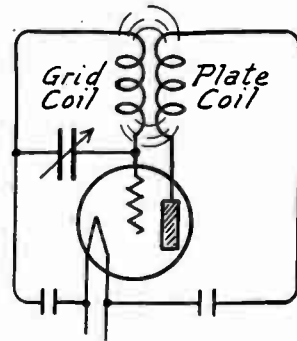

FIG. 2.—Feedback from Plate Circuit to Grid Circuit Causing Regeneration.

The strength of the output from the tube is proportional to the strength of the signal input. If the signal voltage impressed on the grid is made stronger by any means, it will be followed by a greater output in the plate circuit. Signal strength may be increased through many causes outside of the receiver. For example, a stronger signal will be received from a nearby or powerful broadcasting station than from a distant or weak broadcasting station.

By means of regeneration the tube itself is made to increase the input voltage. In Fig. 2 the two coils of Fig. 1 have been rearranged so that they are brought close together. The one magnetic field now includes both coils. They are coupled and energy from the plate circuit is fed back into the grid coil.

If the grid circuit of the tube is tuned to resonance with the frequency of the incoming signal, as is the case in radio frequency

REGENERATION, ACTION AND PRINCIPLE OF

amplifiers and in detectors, the inductive reactance and the capacitive reactance in the grid circuit neutralize each other and leave only the resistance of the conductors in the circuit to oppose flow of current. Were it possible to reduce this resistance to zero nothing would remain to oppose the current flow and when oscillating voltages were once introduced into the grid circuit they would continue to flow indefinitely.

It is evident that the same results may be secured by adding just enough energy to that already in the grid circuit so that this additional energy overcomes the loss due to resistance. As an example, supposing the resistance of the grid circuit caused a power loss of five watts and suppose that just enough of the plate circuit energy were fed into the grid circuit to make up for this five-watt loss. Then the signal voltage originally brought into the grid circuit would set up oscillations which would continue on and on without diminishing.

It is possible to feed energy from the plate circuit back to the grid circuit and reinforce the voltages in the grid circuit because the frequency in the plate circuit is exactly the same as the frequency in the grid circuit.

After enough plate circuit energy has been fed back to just overcome the grid circuit resistance still more may be fed back to increase the grid circuit voltages to almost any desired extent. The power fed back from the plate circuit may be made sufficient to maintain oscillations in the grid circuit without the help of any outside voltage, such as an incoming signal voltage. Under such conditions the tube will maintain oscillations in its circuits as long as the filament batteries and plate batteries hold out. The tube is then oscillating.

As long as the grid circuit absorbs power from the incoming signal we have regeneration with a feedback in use. But just as soon as the feedback energy is great enough to sustain oscillation without outside help we have gone beyond regeneration and have oscillation in the tube. The feedback energy is then able to keep the tube's circuits in continuous oscillation.

It is apparent that regeneration allows an exceedingly weak signal to be built up until it is as effective as a powerful signal. Thus regeneration increases the sensitivity of a receiver many times. Regeneration also increases the selectivity of the receiver as may be seen from Fig. 3. The curve at the left side indicates the response of a receiver to various frequencies when the receiver is tuned to a frequency of 750 kilocycles. When tuned to this frequency the circuits have the least possible reactance at 750 kilocycles. At points below and above this frequency the response of the receiver will not be so powerful because the reactance has not been eliminated by the process of tuning to resonance.

The effect of regeneration is shown at the right in Fig. 3. The frequency of 750 kilocycles is being fed back from plate circuit to grid circuit and the signal at this one frequency is built up to great volume. Since the feedback is occurring only at the tuned frequency other frequencies below and above the resonant points are not increased in strength. Therefore the relative strength of the 750 kilocycle signal with regeneration is several times as great as with-

REGENERATION, CONTROL ADJUSTMENT OF

out regeneration. Any signals attempting to enter the receiver at other frequencies are relatively weaker under the conditions shown at the right in Fig. 3.

The feedback of energy from the plate circuit to the grid circuit may be made through inductive coupling, through capacitive coupling or through resistance coupling. Inductive coupling and capacitive coupling are the types generally used because resistance coupling is not effective at radio frequencies. With the more commonly used methods of obtaining regeneration an inductive coupling between two coils or two parts of one coil is employed. Capacitive coupling through the capacity existing between the plate and the grid inside of the tube is used in a few instances.

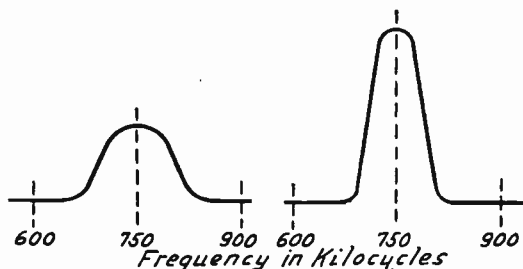

FIG. 3.—Effect of Regeneration on Signal.

There is always a feedback of energy from plate circuit to grid circuit through the capacity between the tube's plate and grid. This capacity feedback is independent of any external means for additional feedback. Since the reactance of any capacity is less at high frequencies than at low frequencies, the capacity feedback at high frequencies will be much greater than at low frequencies because of this change of effective reactance in the tube's internal capacity.

Regeneration and oscillation occur more easily at high frequencies than at low frequencies. Therefore less feedback will always be required to produce regeneration at the high frequencies or low wavelengths. Any control for regeneration provides for increasing the feedback as the frequency is lowered. The lower the frequency or the higher the wavelength the more regeneration will always be needed to produce a given strength of signal in the tube's output.

REGENERATION, CONTROL ADJUSTMENT OF.—
See *Oscillator, Radio Frequency, Uses of*.

REGENERATION, METHODS OF OBTAINING.—It is plain that the amount of feedback must be under the control of the operator. For strong incoming signals little or no feedback may be required while for very weak signals the maximum allowable feedback and the maximum regeneration must be used. There is always a capacitive feedback through the plate to grid capacity of the tube and the amount of regeneration through this tube capacity varies according to the construction of the tube. The added means for feedback must be controlled so that the feedback

REGENERATION, METHODS OF OBTAINING

energy combined with the energy passing through the tube capacity will equal the desired or needed value.

Regeneration is usually applied only to the detector tube and in the following diagrams showing the various methods of obtaining regeneration the plate of the tube is shown connected to the primary winding of an audio frequency transformer as would be the case with the detector plate. If choke coil coupling or resistance coupling is used in the audio amplifier following the detector, a choke or a resistance would be substituted for the audio frequency transformer. The part of the detector circuit in which regeneration is obtained would not be altered by this substitution.

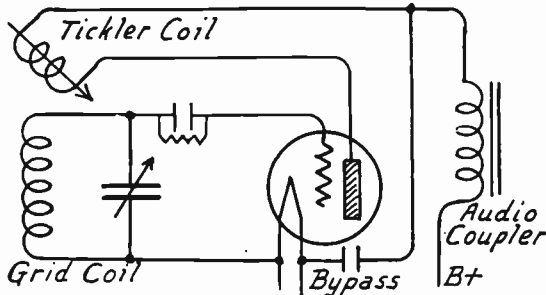

FIG. 1.—Regeneration Obtained with Movable Tickler Coil.

Tickler Coil Control.—Fig. 1 shows regeneration obtained by a tickler coil connected in the plate circuit and coupled to the tuned coil of the grid circuit. The construction of the tickler coil unit is shown in Fig. 2. The tuned winding, which is the secondary of a radio frequency transformer, and the primary winding of this transformer are wound on a stationary form in the usual way. The tickler coil is wound on a form which rotates within the stationary form.

A shaft is attached to the tickler coil form and extends through to a control knob. If the tickler coil is small, consisting of ten turns or less, it must be placed close to the secondary coil. If the tickler is large, containing fifteen to thirty turns, it may be placed farther away from the stationary coil.

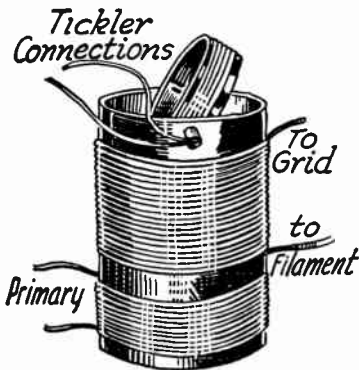

FIG. 2.—Construction of Movable Tickler Coil Used to Obtain Regeneration.

As the tickler is turned to increase its coupling to the stationary coil the effective inductance of the tuned stationary coil is increased. Therefore, the tuning point at which the circuit becomes resonant to a certain frequency will change with changes of tickler adjustment. This is a rather serious disadvantage of this method for

REGENERATION, METHODS OF OBTAINING

obtaining regeneration since a receiver cannot be logged unless a note is made of the tickler coil setting.

The tickler coil adjustment should be such that oscillation may be caused at the lowest frequency or highest wavelength to be received. If oscillation cannot be obtained when the tickler coil is turned to the position of maximum coupling, it will be necessary either to increase the number of turns on the tickler or to move it closer to the stationary coil.

The position of the tickler coil in relation to the fixed coil must be such that increase of coupling between the two will increase the feedback, will increase regeneration and finally cause oscillation. If turning the tickler coil into line with the fixed coil reduces the signal strength by reducing regeneration, the connections to the tickler coil should be reversed or it should be rotated in the opposite direction to increase regeneration.

When the axis of the tickler coil is in line with the axis of the grid coil, there is maximum coupling between the two. If the voltages in the tickler coil and in the grid coil are in phase, the tickler will reinforce the grid coil and there will be maximum regeneration. But if the voltages in the two coils are in opposite phase, the tickler coil will oppose the grid coil and the signal strength will be reduced.

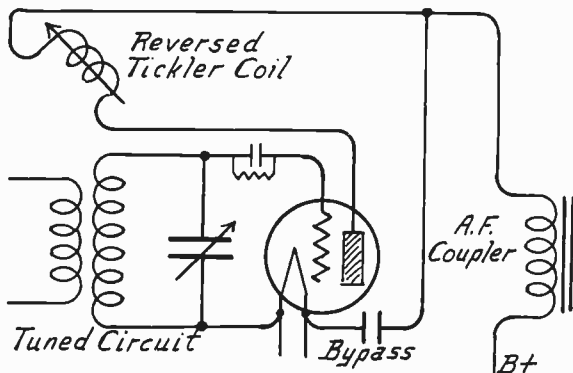

FIG. 3.—Reversed Feedback for Regeneration Control.

Some tickler coils are arranged so that they may be given one-half of a complete revolution, starting with the axes of the two coils in line and ending with them again in line. Other ticklers are arranged for only one-quarter of a revolution, starting with the axes at right angles and ending with them in line.

The greatest range of control will be obtained when the tickler coil is allowed a half revolution. With the tickler coil axis and the grid coil axis in line at one extreme of rotation the voltages will reinforce each other and there will be maximum regeneration. With the tickler turned half way around, so that the two coils are again in line, the voltages will oppose each other, there will be a reversed feedback and minimum signal strength.

If the tickler is allowed only a quarter revolution, it is necessary that the voltages be in phase when the coil axes are in line. Minimum coupling and minimum regeneration will be obtained with the coils at right angles but it will be impossible to make the voltages oppose for a reversed feedback effect.

The feedback from plate circuit to grid circuit is at radio frequency. This radio frequency will not pass through the high impedance of the primary winding in the audio transformer or choke. Therefore, a bypass condenser is

REGENERATION, METHODS OF OBTAINING

connected from the line between tickler and transformer to one of the filament terminals on the tube. This bypass should have at least .001 microfarad capacity.

Fig. 3 shows the method known as reversed feedback. The construction is exactly like that shown in Fig. 2. But now the tickler coil is placed in such a relation to the stationary coil that its energy opposes the energy in the stationary or tuned coil. The constants of the tuned circuit are such that it normally tends to oscillate at the lowest frequency or highest wavelength to be received. This may be accomplished by using a large primary winding on the radio frequency transformer and making the coupling between the primary and secondary of this transformer very close.

When the reversed tickler is in the position for maximum coupling, its feedback effect will be a minimum because it is opposing the voltages in the tuned coil. When the reversed tickler is at right angles to the fixed coil, regeneration will be maximum because then all of the opposing effect of the reversed tickler will have been removed.

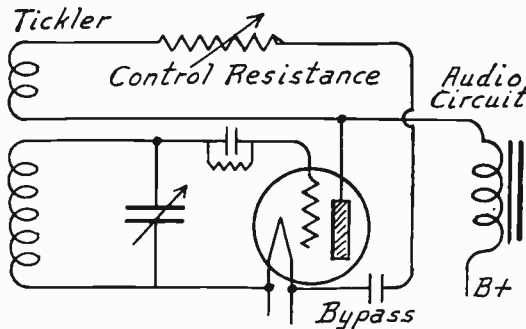

FIG. 4.—Variable Resistance and Fixed Tickler for Regeneration Control.

If a tickler coil used in the manner of Fig. 1 is rotated to the right to increase regeneration, rotating it to the left will cause it to act as a reversed tickler and the system will then correspond to Fig. 3.

Resistance Control.—Fig. 4 shows control of regeneration by a variable resistance unit placed in the tickler circuit. This unit should have a resistance which is variable up to 50,000 ohms. Units providing still higher resistance will be equally satisfactory. The plate of the tube is connected directly to the primary winding of the audio frequency transformer. The resistance unit is in series with the tickler coil and this tickler circuit connects to one of the filament terminals through a bypass condenser having a capacity not less than .001 microfarad.

In the case of Fig. 4 the coupling of the tickler to the tuned coil is not variable. The tickler coil is wound on one end of the form that carries the secondary, this being shown in Fig. 5. The less space between the tickler winding and the tuned winding the fewer tickler turns will be required to obtain satisfactory regeneration.

REGENERATION, METHODS OF OBTAINING

The number of turns and the distance of the tickler winding from the tuned winding should make it possible to obtain oscillation at the lowest frequency or highest wavelength when the control unit is adjusted for lowest resistance. If it is impossible to obtain oscillation when using the least possible resistance, it will be necessary to increase the number of turns on the tickler winding or to move this tickler winding closer to the tuned winding.

With resistance units giving up to 50,000 ohms the tickler coil may usually be placed so that the nearest turns of tickler and tuned winding are separated by three-sixteenths to one-quarter of an inch. From ten to thirty turns will be required on the tickler coil.

Fig. 6 shows the use of a resistance control shunted across the tickler winding. The construction of the tickler and the tuned coil is the same as shown in Fig. 5 and the adjustment of tickler turns and position is the same as for the method of Fig. 4. The resistance of Fig. 6 forms a bypass for the radio frequency energy from the plate circuit. The smaller the amount of resistance used in Fig. 6, the less will be the regeneration obtained. In Fig. 4 the greater the resistance, the less the regeneration. The two methods operate equally well as controls for regeneration.

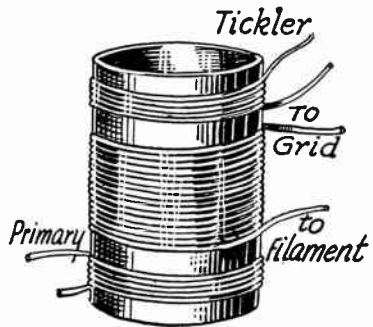

FIG. 5.—Construction of Fixed Tickler Coil for Regeneration.

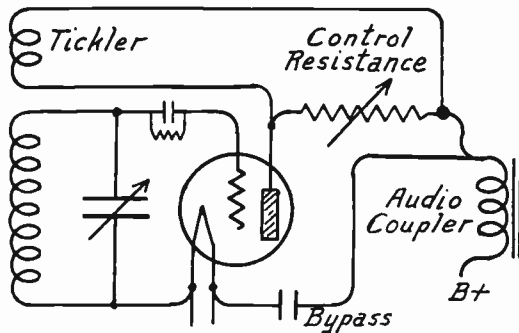

FIG. 6.—Fixed Tickler Control with Shunt Resistance.

Condenser Control.—In Fig. 7 the regeneration is controlled by a variable condenser used as a bypass for the radio frequency energy in the plate circuit. The tickler coil should be mounted so that its coupling with the tuned coil may be varied. The method of Fig. 2 makes a satisfactory mounting, but any other adjustable coil mounting may be used. The variable condenser should have a capacity of .001 microfarad, the old style forty-three plate units being just right. If a smaller variable condenser is used, it will be necessary to increase the number of turns on the tickler coil.

REGENERATION, METHODS OF OBTAINING

The connections are made exactly as shown in Fig. 7. The plate of the tube is connected to the tickler and the other side of the tickler is connected to the stator plates of the control condenser and to the primary of the audio transformer. The rotor of the condenser is connected to either filament terminal of the tube.

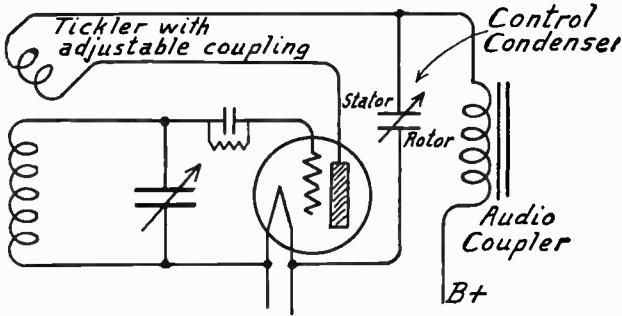

FIG. 7.—Variable Bypass Condenser for Regeneration Control.

When making the preliminary adjustment for the system of Fig. 7, the condenser should be turned to maximum capacity with its plates fully in mesh. Connections to the tickler should then be reversed and tried both ways. The connections are left in the way that produces maximum regeneration or oscillation. With the condenser still at maximum capacity the tickler is coupled closer and closer to the fixed coil until oscillation takes place. Oscillation may then be prevented and regeneration controlled by varying the condenser. The less the condenser capacity, the less will be the regeneration and the greater the condenser capacity, the more regeneration will be obtained. If it is impossible to obtain sufficient regeneration at the lower frequencies or higher wave-

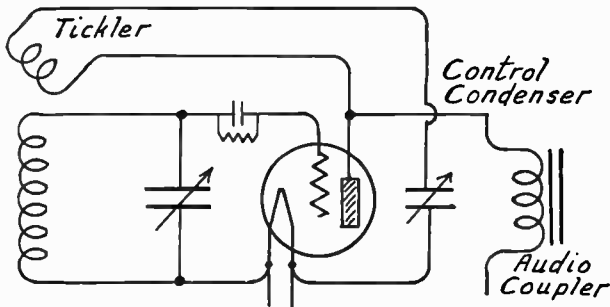

FIG. 8.—Regeneration Control with Condenser in Series with Tickler.

lengths, it will be necessary to increase the coupling or the number of turns on the tickler coil.

The regeneration control of Fig. 8 is very similar to that of Fig. 7 and all of the constructional details given for Fig. 7 apply equally well to Fig. 8. The only difference between the two methods is in the connections between plate, tickler and condenser.

REGENERATION, METHODS OF OBTAINING

Fig. 9 shows still another method of controlling regeneration with a variable coil winding. Here the tickler winding forms part of the tuned coil winding. The tickler winding should have a number of turns equal to about one-fourth the number of turns in the tuned portion of the coil. For broadcast reception this method of Fig. 9 is not as satisfactory as the methods of Figs. 7 or 8.

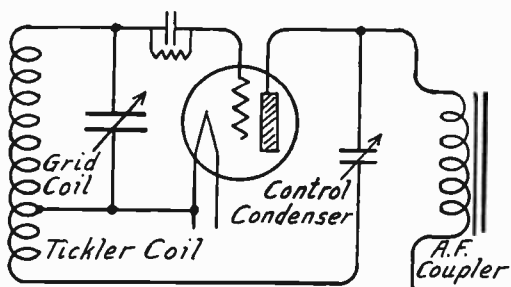

FIG. 9.—Condenser Control of Close Coupled Tickler.

Link Circuit Control.—Fig. 10 shows regeneration obtained through a link circuit coupled at one end to the plate circuit and at the other end of the grid circuit. It is necessary to insert an additional air-core coil between the plate of the tube and the audio

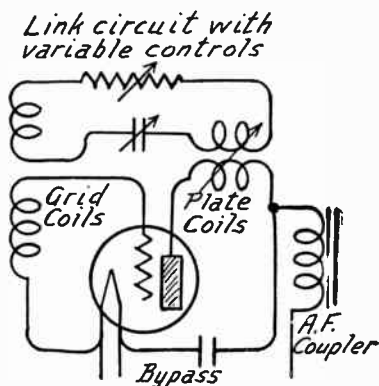

FIG. 10.—Link Circuit Control of Regeneration.

frequency transformer. This coil has two windings, both of the same number of turns, and closely coupled by winding them end to end or one over the other. Twenty turns on each winding will usually be about right. If the coupling between these two windings is to be varied to control regeneration, this unit may be made of a split variometer.

REGENERATION, METHODS OF OBTAINING

The tickler coil proper, which is coupled to the tuned coil of the grid circuit, is fixed in position as shown in Fig. 5. It should consist of ten or more turns. The number of turns on the tickler and its closeness of coupling to the tuned coil are such as to allow oscillation at the lowest frequencies or highest wavelengths to be received.

Three different methods of control are shown in Fig. 10, although only one of them would be employed at any one time. As already mentioned it is possible to control regeneration by varying the coupling between the coil in the plate circuit and the coil in the link circuit. With variable coupling neither the variable resistance nor the variable condenser would be used.

If the variable condenser is placed in the link circuit of Fig. 10, neither the resistance nor the variable coupling would be used. The resistance would likewise be used without either the variable condenser or the variable coupling.

Control of Plate Circuit.—Fig. 11 shows regeneration control by limiting the energy passing into the grid circuit to a value low enough so that the total energy in the grid and plate circuits of the tube, even with the feedback through the tube capacity, is not sufficient to allow oscillation. A variable resistance, which may be

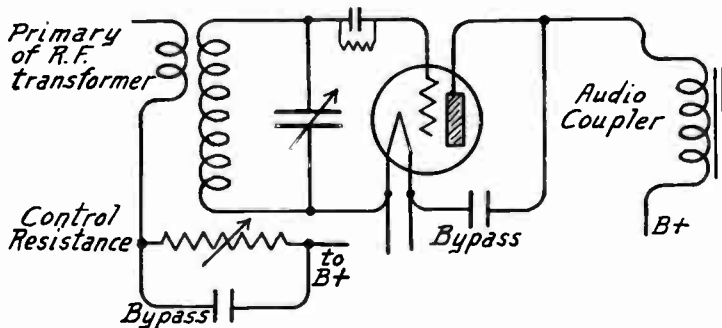

FIG. 11.—Regeneration Control with Plate Circuit Resistance.

adjusted from about 10,000 to 100,000 ohms, is connected between the B-battery or plate voltage supply unit and the primary of the radio frequency transformer. Increasing the resistance lessens the regeneration while lessening the resistance increases the regeneration. Since this method acts to change the direct current voltage applied to the plate circuit of the preceding tube it must not be allowed to interfere with passage of radio frequency currents through its circuit. Therefore, the resistance is bypassed with a one microfarad condenser through which the radio frequency currents pass unhindered.

Fig. 12 shows another method of regeneration control applied to the plate circuit of one or more radio frequency tubes. The primary of the radio frequency transformer is divided into two parts, one part being stationary and the other being rotated. Rotation of the movable part of the primary winding allows it either to assist the stationary part, to oppose the stationary part, or to have any intermediate effect. With the movable part of the primary opposing the stationary part regeneration is cut to a minimum. With the two parts acting together regeneration is maximum.

REGENERATION, METHODS OF OBTAINING

The split primary winding of Fig. 12 has been used for automatic control of regeneration by attaching the movable part of the winding to the shaft of the tuning condenser. More regeneration is always required for low frequencies than for high frequencies, consequently the connection is made so that the two parts of the primary act together for maximum regeneration at low frequencies or high wavelengths.

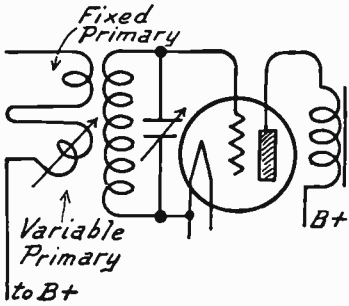

FIG. 12.—Regeneration Control with Variable Split Primary Winding.

of the tube's grid circuit. This resistance may be used as a rheostat. The amount of resistance needed to control regeneration and prevent oscillation depends on the size and construction of the coil and condenser, also on the wiring in the grid circuit. Resistances as low as ten to twenty ohms may be sufficient or it may be necessary to use two or three hundred ohms.

Inefficient Methods.—The control methods shown in Figs. 1 to 12 allow efficient operation of the receiver since they introduce the least possible added resistance and loss into the grid circuits. The methods to be shown immediately following are classed as inefficient since they add considerable resistance directly or indirectly to the grid circuit. This causes a loss of signal strength and broadens the tuning of the receiver.

Fig. 13 shows the use of a variable resistance unit in the oscillatory portion

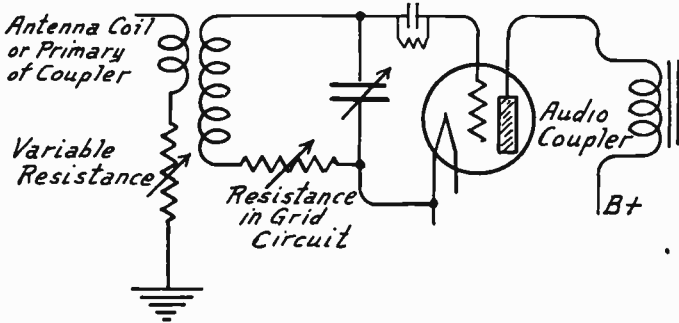

FIG. 13.—Resistances in Primary Circuit and in Grid Circuit.

Fig. 13 also shows the use of a variable resistance between the ground connection and the antenna coil, this method being applied to the first tube of the receiver. This resistance should have a maximum value of 200 to 400 ohms. A potentiometer or any variable resistance reaching this value will be satisfactory. Increasing the amount of the resistance will reduce regeneration while reducing the resistance will increase regeneration and produce oscillation.

Fig. 14 shows the use of a variable grid leak for controlling regeneration. This grid leak should be constructed so that its resistance may be reduced below 100,000 ohms or one-tenth of a megohm. Reducing the resistance of the grid leak lessens regeneration while increasing this resistance will increase regeneration and produce oscillation.

In Fig. 15 a potentiometer is used in the grid return circuit. Turning the

REGENERATION, METHODS OF OBTAINING

potentiometer arm to the side connected to the negative filament terminal places a negative grid bias on the tube, increases regeneration and increases the tendency to oscillate. Turning the potentiometer arm toward the positive side provides a positive grid bias and allows the grid circuit to consume power.

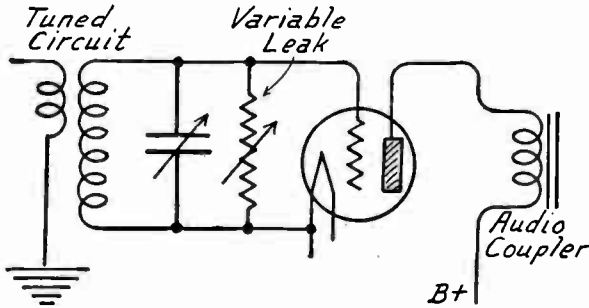

FIG. 14.—Variable Grid Leak Controlling Regeneration.

This reduces regeneration. This use of a potentiometer broadens the tuning and distorts the signal. It also weakens the incoming signal.

Fig. 16 shows the use of an absorption circuit for controlling regeneration. The absorption circuit consists of a coil and a variable condenser. The coil is loosely coupled to the tuned coil in the grid circuit. The absorption coil may be mounted on the grid coil form as in Fig. 5. The coupling of the grid coil to the absorption coil should be close enough so that oscillation may be prevented at the highest frequencies to be received. The absorption coil's

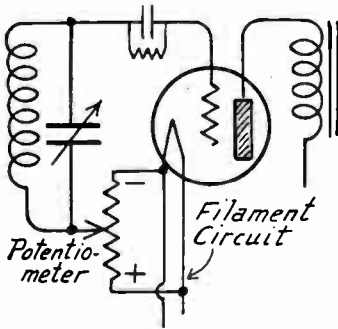

FIG. 15.—Potentiometer in Grid Return to Control Regeneration.

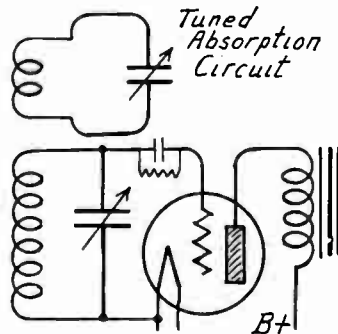

FIG. 16.—Absorption Circuit Control of Regeneration.

inductance and the capacity of its tuning condenser must be of such values that they tune to the highest frequency or lowest wavelength to be received.

As the regeneration control condenser is tuned more and more closely to the frequency being received, the power absorbed from the grid circuit will increase and regeneration will be reduced.

Variometer Controls.—Fig. 17 shows one of the first methods used for regeneration control in broadcast receivers. This is known as the tuned plate method. A variometer is inserted in the plate circuit between the plate terminal of the tube and the audio frequency transformer. As the inductance of the variometer is in-

REGENERATION, METHODS OF OBTAINING

creased, the voltages across it are increased proportionately. The feedback is obtained through the capacity between the plate and the grid in the tube. This capacity is indicated in broken lines.

As the variometer's inductance is increased, the feedback through the tube capacity increases so that additional energy is sent back into the grid circuit. Reducing the variometer's inductance reduces the regeneration.

Fig. 18 shows the use of a plate variometer connected and operated in the same way as the variometer in Fig. 17. The grid circuit also contains a variometer whose inductance is used for tuning the grid circuit to the frequency being received.

Automatic Control of Regeneration.—Inasmuch as it is desirable to increase the amount of regeneration with decrease of the frequency being received, the regeneration control may be attached to the tuning control so that both move together. Tuning is usually done with a variable condenser whose capacity is increased for the reception of higher wavelengths or lower frequencies. If regenera-

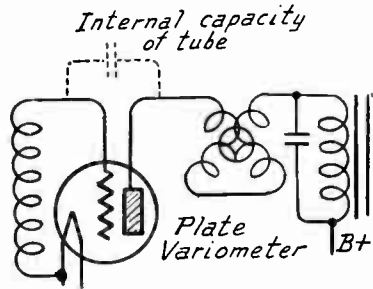

FIG. 17.—Regeneration with Plate Variometer.

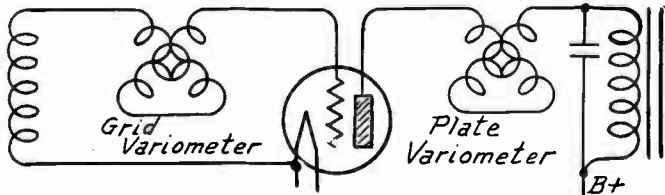

FIG. 18.—Variometers in Both Grid Circuit and Plate Circuit.

tion is controlled with a condenser, this control condenser may be connected to the tuning condenser so that the feedback is increased as the capacity of the tuning condenser is increased. The types of control shown in Figs. 7, 8, 9, 10, 12 and 16 are well adapted to automatic regeneration.

Automatic regeneration is always attended with considerable difficulty because of changes introduced by altering the antenna, by using different tubes, by movement or any coils, or by changes of any nature whatsoever in the receiver.

In Figs. 7, 8, 9, and 10, increasing the capacity of the control condensers increases the regeneration. Were these control condensers to be connected to the tuning condenser the two condensers should increase their capacities together so that regeneration would automatically increase at the higher wavelengths or lower frequencies. The size of the tickler coil and its coupling to the grid coil are matters for experiment. The proper values will differ for each circuit to which automatic regeneration control is being adapted.

REGENERATION, METHODS OF OBTAINING

With the control condenser fully in mesh, at lowest frequency, the tickler coil should be given just enough turns or its coupling should be made just loose enough to bring the circuit to maximum regeneration while preventing oscillation. The tuning condenser and control condenser are then turned to their lowest capacities at which reception is expected. If oscillation occurs at this point, it will be necessary to reduce the tickler coupling, to reduce the number of turns on the tickler coil, or to use a control condenser of lower minimum capacity.

Regeneration with a Loop.—Feedback regeneration may be obtained in any loop receiver by the method shown in Fig. 19. The number of turns on the loop is increased above the number ordinarily used by adding from one-fourth to three-fourths the original number of turns. The connection from the loop and the tuning condenser to the grid of the first tube is not disturbed. A tap is provided at the junction between the old and new parts of the loop winding. From this tap a connection is made to the fila-

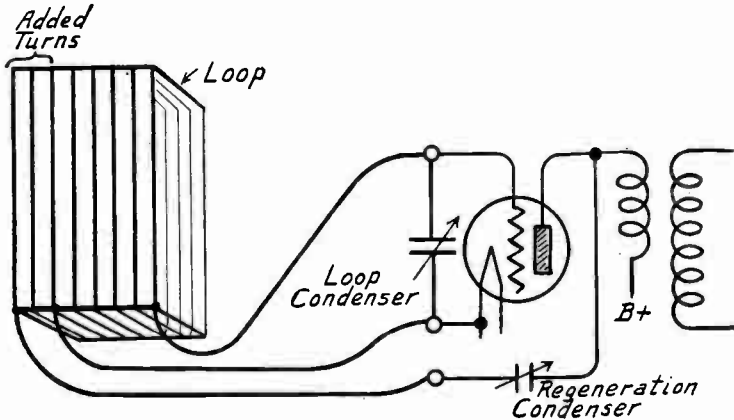

FIG. 19.—Regeneration Applied to a Loop.

ment circuit of the first tube and the loop tuning condenser. From the outer end of the added turns a connection is made through a variable condenser to the plate terminal of the first tube. This condenser may have a capacity between .00025 and .0005 microfarad.

Increasing the capacity of the added regeneration condenser will increase the feedback and the regeneration. Reducing the capacity of this condenser will lessen regeneration. It should be mentioned that this system will cause the loop to radiate sufficiently to bother nearby receivers. This system of regeneration may be added to tuned radio frequency receivers or to superheterodyne receivers. When added to a superheterodyne the connection from the added portion of the loop through the control condenser is made to the plate of the first detector tube. See also *Loop, Regeneration with*.

Producing Regeneration in Balanced Circuits.—Various kinds of receivers are provided with small condensers which balance the feedback through the plate to grid capacity of the tube with an

REGENERATION, METHODS OF OBTAINING

external feedback of equal voltage but of opposite phase. These receivers include those using the Neutrodyne, Roberts, Rice, Sampson and similar circuits. The Neutrodyne, the Roberts, and the Rice are shown respectively in Figs. 20, 21 and 22. In each case the balancing condenser has been replaced with a variable condenser marked "Control."

With this control condenser adjusted to the capacity which exactly balances the internal capacity of the tube the receiver will be balanced and regeneration will be prevented. As soon as the control condenser is adjusted to provide either more or less capacity than the amount required for balancing, regeneration will take place. Increasing the capacity of the control condenser will allow the external feedback to be greater than the internal feedback. Reducing the capacity of the control condenser will allow the external feedback to be less than the internal feed-

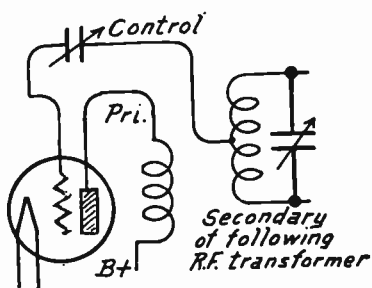

FIG. 20.—Neutrodyne Circuit with Balancing Condenser Used as Regeneration Control.

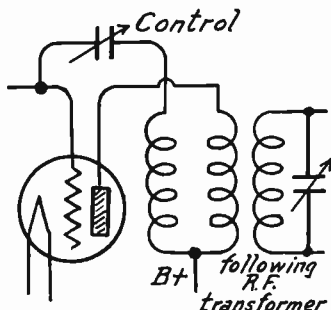

FIG. 21.—Roberts Circuit with Balancing Condenser Used as Regeneration Control.

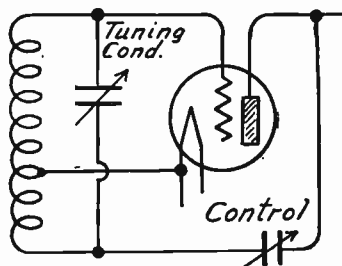

FIG. 22.—Rice Circuit with Regeneration Control.

back. Regeneration will take place in either case. To cause regeneration at the lower frequencies or higher wavelengths it is usually necessary to increase the control condenser capacity to provide a comparatively large external feedback.

It will be unnecessary to provide regeneration in more than one of the radio frequency stages. The best results will be obtained by unbalancing the circuit which immediately precedes the detector, this being the second radio frequency stage.

Multiple Regeneration.—While regeneration is applied only to the detector grid circuit as a general rule, there is no reason why

REGULATION, TRANSFORMER

it cannot also be applied to the grid circuits of any radio frequency tube including the one immediately following the antenna.

Systems have been designed in which variable regeneration control is applied to the detector grid circuit and fixed or semi-fixed regeneration is applied to one or more of the radio frequency stages preceding the detector. One method substitutes for a single radio frequency tube two tubes having their grid circuits in parallel. The plate circuit of one of these tubes is connected through a transformer to the following stage as usual. The plate circuit of the other tube is connected to a tickler coil in the tube's grid circuit and is not connected to the following stage. To be effective in increasing signal strength and selectivity, regeneration must be increased as the received frequency is decreased, consequently no method of fixed regeneration is of much value except at some one frequency among all those to be handled.

One of the simplest and easiest ways of controlling regeneration and preventing oscillation is by the use of a variable rheostat for the tube in which regeneration is desired. Any radio frequency stage in which the tube is fitted with a variable rheostat may be made to regenerate and if this system is used on two or more radio frequency stages we will have multiple regeneration.

REGULATION, TRANSFORMER.—See *Transformer*.

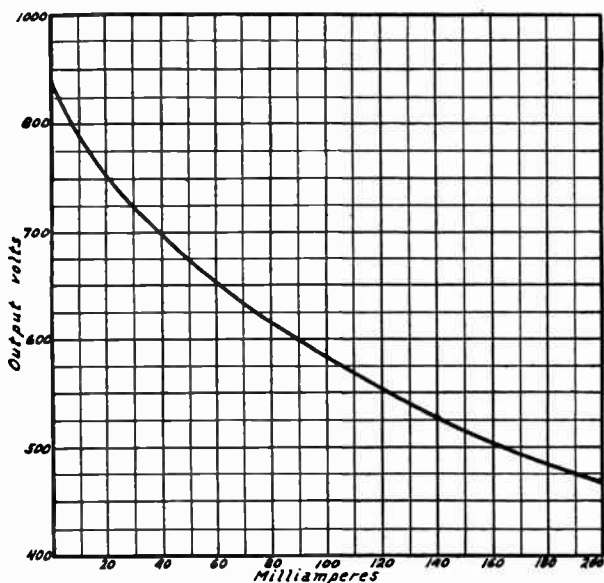

FIG. 1.—Voltage Regulation of Rectifying Tube.

REGULATION, VOLTAGE.—The voltage regulation of any device is the ratio of its voltage without any load to its voltage with

REGULATOR TUBE

a normal load or full load. The regulation may be expressed as a percentage of the drop in voltage to the remaining voltage. Thus, if a rectifier and filter system in a power unit delivers 400 volts at no load and delivers 350 volts with a forty milliamperere load, the percentage is that of 50 (the difference) to 350 (the remaining voltage) or is about 14.3 per cent. Regulation is also expressed as the ratio of the drop in voltage to the no-load voltage.

If the voltage drops but slightly as the load increases, the device is said to have good regulation. If the drop is rapid with increase of load the regulation is said to be poor.

Regulation curves show the relation between voltage and various loads. The curve of Fig. 1 shows the regulation of two half-wave rectifier tubes working as a full wave rectifier into a plate power filter system. By means of such curves it is possible to determine the available voltage at any given load.

Regulation depends on the reactance, resistance and impedance of circuits. These factors in series with the output of a device make the regulation poorer as they are increased. Connected in parallel, they may either improve the regulation or make it poorer.

See also, *Transformer*.

REGULATOR TUBE.—See *Tube, Voltage Regulator Type*.

REINARTZ TUNER.—See *Tuner*.

REJECTOR CIRCUIT.—See *Circuit, Rejector*.

REJUVENATOR, TUBE.—See *Tube, Restoration of*.

RELAY.—A device containing two electrical circuits with means for allowing a small change of voltage or current in one of the circuits to produce a comparatively large change of voltage or current in the other circuit. Ordinary electrical relays are provided with contacts which open or close the circuit carrying the more powerful energy. These contacts are operated by an electromagnet energized from the less powerful circuit.

In the three-element vacuum tube there is a relay action, the small changes of voltage in the grid circuit controlling comparatively large changes of voltage and amperage in the plate circuit of the tube.

RELUCTANCE.—Opposition to the flow of magnetic lines of force is called reluctance. The greater the reluctance of the substance through which the lines of force pass, the fewer lines will flow with a given magnetomotive force. See *Iron and Steel*.

REMOTE CONTROL.—See *Control, Remote*.

REPAIRS.—See *Construction, Receiver*; also *Trouble*.

REPEATER.—A relay of any kind may be called a repeater. A stage of vacuum tube amplification which amplifies the output of a preceding stage is called a repeater.

RE-RADIATION.—The antenna of a radio receiver is supposed to receive energy from passing radio waves but is not supposed to radiate or send out radio frequency energy. Radiation of energy is presumed to take place only from the aerials of transmitting stations. Yet a majority of radio receivers in use are capable of

RE-RADIATION

radiating energy which hampers or completely spoils the reception of other receivers within a wide radius.

Any feedback of energy from receiver circuits which are in an oscillating condition will cause radiation when this feedback reaches the antenna circuit. The antenna is tuned more or less closely to the frequency to which the receiver is tuned and the antenna then radiates this frequency.

If the antenna of a radiating receiver sent forth only the frequency to which the receiver is tuned, things would not be so bad. But it almost invariably sends out at least two frequencies because of the two points of resonance that exist in coils which are quite closely coupled. Not satisfied with radiating two frequencies the receiver will also send out harmonics of the received frequency, these harmonics being at twice the received frequency, three times the received frequency, etc.

A receiver does not radiate sufficiently to cause harm unless one or more of its tubes are oscillating. The oscillating condition is brought about by pushing regeneration or "volume" too far so that regeneration gives way to oscillation. It is fortunate that a receiver other than a superheterodyne operated with any tubes oscillating will not give satisfactory reception to its operator. If the operator is sufficiently experienced to recognize the cause of his own trouble, he will take steps to stop the oscillation provided his receiver has the necessary control over oscillation. About the only type of receiver from which radiation cannot be prevented is the superheterodyne. This is partly because the oscillator tube, which must oscillate to operate the receiver, is coupled almost directly to the antenna.

A superheterodyne operated with a loop antenna does not do a great deal of harm with its re-radiation because the loop is an inefficient radiator and its radiated energy travels for only a few yards in any direction. Regeneration in the loop of a superheterodyne or any other receiver makes this re-radiation reach far enough to bother at least some of the neighbors. A superheterodyne operated with an outdoor antenna makes itself a nuisance to all other receivers within a considerable distance.

Regenerative receivers, especially those of the single-circuit variety, are among the worst offenders in the matter of re-radiation. Any receiver which uses regeneration in the tube immediately following the antenna will re-radiate badly when regeneration is carried so far as to cause oscillation. A stage of radio frequency amplification which is properly balanced and placed between the antenna and the tube using regeneration will quite effectively prevent re-radiation. This is one of the chief advantages of properly built and properly balanced Neutrodyne, Browning-Drake, Roberts and similar balanced receivers. But when these receivers are not properly balanced and kept balanced they are as bad as any others.

The easiest way to locate a distant station on the dials of a regenerative receiver is to turn the regeneration control to a point which causes oscillation, then to rotate the tuning dials until the carrier wave of the desired station causes a heterodyne whistle with the oscillations of the receiver. Regeneration may then be brought about by stopping oscillation and the station will be received satisfactorily. But during the process of locating the whistle, the oscillating receiver is acting as a transmitter and spoiling the reception of neighbors operating their receivers near that frequency.

Whether a certain receiver re-radiates may be determined by a simple test with the help of someone within a short distance who also has a receiver. The two receivers are tuned to the same frequency, tuned to receive the same station at the same time. The

RESIN

regeneration control of the receiver to be tested is then set at its highest point to produce maximum regeneration. The tuning dial or dials are then turned back and forth across this setting a number of times. If the other receiver gives vent to a series of whistles and squeals as the dials are turned on the first one, the receiver being tested is re-radiating and is capable of causing much interference.

Whistles and squeals heard in a receiver may originate either in the same receiver or in others which are re-radiating. If the pitch of the whistle rises and falls while the tuning dials and other controls remain unchanged, the interference is coming from another receiver. But if the whistle remains at exactly the same pitch until the receiver controls are moved and then rises and falls with movement of the controls, it indicates that the receiver being tested is oscillating and is undoubtedly re-radiating.

RESIN.—See *Insulation, Moulded and Laminated.*

RESISTANCE.—Resistance is the opposition to flow of electric current offered by conductors through which the current flows. Resistance affects the flow both of direct currents and of alternating currents. The opposition to the flow of alternating currents caused by inductance and by capacity is called reactance. The combined opposition of the resistance and the reactance to alternating currents is called impedance. See also *Impedance, Reactance and Skin Effect.*

Resistance considered as to its effect on high frequency currents is generally assumed to include not only true resistance, but also all losses of energy. These losses affect the circuit in much the same way that it would be affected by a loss due to resistance. These are often called equivalent resistances.

All resistances, reactances and impedances are measured in ohms. The symbol for resistance is "R," for reactance "X" and for impedance "Z."

RESISTANCE, ANTENNA.—The antenna resistance is assumed to include all causes of energy loss in the antenna circuit. This circuit consists of the antenna, lead-in, ground lead and the ground itself.

The antenna resistance includes the resistance of the wires and conductors used in parts of the antenna circuit. It also includes the loss of energy due to leakage through and over the surface of insulators, the loss due to currents set up in nearby conductors and the losses due to nearby dielectrics such as building walls, trees, poles, etc.

RESISTANCE, CALCULATION OF.—See *Law, Ohm's.*

RESISTANCE, COIL.—See *Coil, Resistance of.*

RESISTANCE, CONDENSER AFFECTED BY.—See *Condenser, Resistance in Series with, Effect of.*

RESISTANCE, COPPER WIRE.—See *Wire, Copper.*

RESISTANCE, DIELECTRIC.—A name for dielectric strength. See *Strength, Dielectric.*

RESISTANCE, DIRECT CURRENT.—See *Resistance, Ohmic.*

RESISTANCE, EFFECTIVE.—The effective resistance of a circuit is equal to the power in watts that is used in the circuit

RESISTANCE, EQUIVALENT

divided by the square of the number of amperes flowing in the circuit. This is a true measure of the losses in a circuit whether they are due to resistance, reactance or actual loss of energy through leakages and similar effects.

RESISTANCE, EQUIVALENT.—The equivalent resistance of any circuit is the resistance which would have to be added to another circuit of the same type but composed of electrically perfect units in order to make the losses in the two circuits the same.

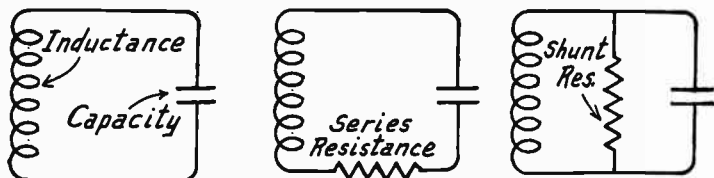

FIG. 1.—Equivalent Series and Shunt Resistances.

Equivalent resistance is usually indicated as being either in series or in parallel with the circuit. In Fig. 1 at the left is shown a circuit including only inductance and capacity and having no resistance. Since it is impossible to obtain such a perfect circuit in practice the resistance of all the parts may be shown as a series resistance or as a shunt resistance, both of these being indicated at the right hand side of Fig. 1. The resistances shown, if considered as equivalent resistances, represent all of the losses in the circuit. These losses are due to actual resistance, to eddy currents, to leakages, and to dielectric losses.

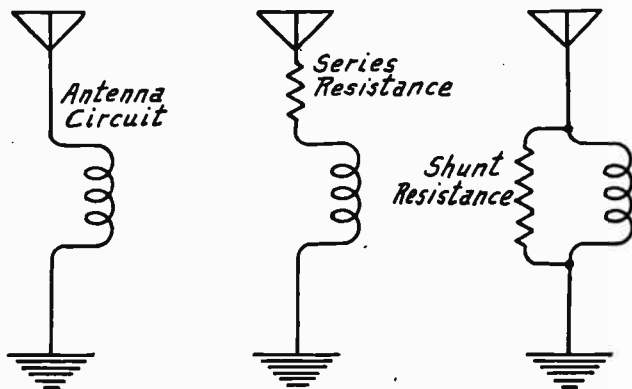

FIG. 2.—Equivalent Resistances in Antenna Circuit.

Fig. 2 represents an antenna circuit. The equivalent resistance of such a circuit may be shown as an actual resistance in series with the antenna or as a parallel resistance across the antenna capacity and the coil inductance. Both representations are shown at the right hand side of Fig. 2. The equivalent series resistance would tend to oppose flow of current. The equivalent parallel resistance would tend to bypass or waste a part of the energy in the antenna circuit.

RESISTANCE, FEEDBACK FROM

A vacuum tube is represented at the left in Fig. 3 while at the right are shown the equivalent resistances for such a tube. The equivalent resistances of the tube are shown as existing between the plate and the filament and

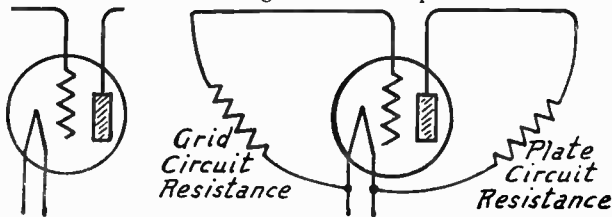

FIG. 3.—Equivalent Resistances of Vacuum Tube Circuits.

between the grid and the filament. The plate-filament resistance is the output resistance while the grid-filament resistance is the input resistance.

See also *Condenser, Losses in.*

RESISTANCE, FEEDBACK FROM.—See *Oscillation.*

RESISTANCE, FIXED.—Any resistance unit in which the amount of resistance is not readily variable is called a fixed resistance. Filament control resistors, grid leaks of the usual type and some power supply resistors are examples of fixed resistances.

RESISTANCE, HIGH FREQUENCY.—The effective resistance to high frequency currents is the total of all resistances and loss effects in the circuit.

HIGH FREQUENCY RESISTANCE OF COPPER WIRE

Ohms per Hundred Feet in Straight Wires

Gauge Number of Wire	Resistance at Direct Current	Resistance at 600 Kilocycles	Resistance at 1500 Kilocycles
12	.159	.94	1.55
14	.253	1.25	1.97
16	.402	1.62	2.51
18	.639	2.10	3.20
20	1.02	2.75	4.01
22	1.61	3.50	5.25
24	2.57	4.50	6.77
26	4.08	6.35	8.78
28	6.49	7.90	11.41
30	10.32	11.35	14.80
32	16.41	17.50	19.92
34	26.09	27.00	28.52
36	41.48	42.20	43.14
38	65.96	66.40	67.00
40	104.90	105.15	105.57

RESISTANCE, INSULATION

The total high frequency resistance depends partly on the actual resistance of the conductor at the frequency being considered, this resistance in turn depending to a great extent on the skin effect. The effective resistance depends also on the resistance in circuits which are coupled, either loosely or closely, to the circuit being considered. The loss due to the production of eddy currents in nearby conductors also enters into the high frequency resistance and this resistance is raised still higher by any loss of energy through the capacities between parts of the circuit or between its parts and those of neighboring circuits. Finally, the high frequency resistance is increased by the losses in condensers and coils used in the circuit. See *Skin Effect*.

High frequency resistance in a tuned circuit reduces the frequency at which the circuit is resonant. The effect is as if capacity or inductance were added to the tuned circuit. Therefore, less of the variable tuning capacity is required to reach a given frequency when the circuit contains high resistance.

RESISTANCE, INSULATION.—The ohmic resistance of an insulating material to voltages tending to break through the material is called the insulation resistance. It is measured in ohms. See also *Strength, Dielectric*. The following table shows volume resistance of dielectric materials as given by the *Bureau of Standards*.

RESISTIVITY OF SOLID DIELECTRIC MATERIALS

Resistivity of a centimeter cube at 22° Cent. or 71.6° Fahr. in billions of ohms (1,000,000,000 or 10⁹)

<p>Bakelite</p> <p style="padding-left: 20px;">No. 1.....200</p> <p style="padding-left: 20px;">No. 150.....4000</p> <p style="padding-left: 20px;">No. 190.....100</p> <p style="padding-left: 20px;">No. L-558.....20,000,000</p> <p style="padding-left: 20px;">micarta.....50</p> <p>Celluloid, white.....20</p> <p>Condensite.....40</p> <p>Fibre, hard.....20</p> <p style="padding-left: 20px;">red.....5</p> <p>Glass, ordinary.....90,000</p> <p style="padding-left: 20px;">plate.....20,000</p> <p>Lavite.....20</p> <p>Marble</p> <p style="padding-left: 20px;">Italian.....100</p> <p style="padding-left: 20px;">Tennessee.....5</p> <p style="padding-left: 20px;">Vermont.....1</p> <p>Mica</p> <p style="padding-left: 20px;">African, spotted black...40,000</p> <p style="padding-left: 20px;">African, brown clear...2,000,000</p> <p style="padding-left: 20px;">colorless.....200,000,000</p> <p style="padding-left: 20px;">India ruby, stained.....50,000</p>	<p style="padding-left: 20px;">India, slight stains....50,000,000</p> <p style="padding-left: 20px;">moulded.....1,000,000</p> <p>Porcelain, unglazed.....300,000</p> <p>Quartz, fused.....5,000,000,000</p> <p>Rosin.....50,000,000</p> <p>Rubber, hard.....1,000,000,000</p> <p>Shellac.....10,000,000</p> <p>Sulphur.....100,000,000</p> <p>Waxes</p> <p style="padding-left: 20px;">beeswax, yellow.....2,000,000</p> <p style="padding-left: 20px;">beeswax, white.....6,000,000</p> <p style="padding-left: 20px;">ceresin (over).....5,000,000,000</p> <p style="padding-left: 20px;">halowax No. 1001.....20,000</p> <p style="padding-left: 20px;">halowax No. 5055B...20,000,000</p> <p style="padding-left: 20px;">paraffin.....50,000,000</p> <p style="padding-left: 20px;">parowax.....10,000,000</p> <p style="padding-left: 20px;">* sealing.....8,000,000</p> <p>Woods, paraffined</p> <p style="padding-left: 20px;">mahogany.....40,000</p> <p style="padding-left: 20px;">maple.....30</p> <p style="padding-left: 20px;">poplar.....500</p> <p style="padding-left: 20px;">walnut.....10</p>
--	---

The surface resistivity of any material is lowered by humidity, by the presence of moisture. For example, the surface resistivity of hard rubber which is 10¹⁸ ohms at a relative humidity of zero drops only to 10¹⁵ at a humidity of 60; but it then drops to 10¹³ at humidity of 80 and to 10⁹ at a humidity of 90.

RESISTANCE, MATERIALS FOR

RESISTANCE, MATERIALS FOR.—Resistance which is necessary for the control of current flow and voltage is generally obtained from wires, rods or bars of metal or carbon. In the following table the resistances of commonly used materials are given in ohms per mil foot. These values show the resistance in ohms of a piece of the material having a cross-sectional area of one mil or one-thousandth of a square inch, and a length of one foot. To find the resistance per foot of the material having any given cross-sectional area it is only necessary to divide the value given in the table by the number of mils of cross-sectional area in the piece being considered.

For example, a number 30 gauge wire has a cross-section of 101 circular mils. If it is desired to find the resistance per foot of number 30 aluminum wire, the resistance given in the table, 17.02, is divided by 101, the result being 0.169 which is the resistance in ohms of one foot of number 30 aluminum wire. The cross-sectional area of wires of various gauges is given under *Wire, Copper*.

RESISTANCES IN OHMS PER MIL FOOT OF METALS AND CARBON

Aluminum	17.02	Manganin	264.70
Antimony	250.87	Mercury	576.23
Bismuth	721.92	Monel Metal	252.67
Brass	42.11	Nichrome	601.57
Cadmium	45.72	Nickel	46.92
Carbon (coke, lampblack)	22,000.00	Palladium	67.17
Copper (annealed)	10.37	Phosphor Bronze	46.90
Copper (hard drawn)	10.65	Platinum	60.15
German Silver (18%)	198.53	Silver	9.56
German Silver (30%)	294.78	Steel (cast)	114.50
Gold	14.68	Steel (soft carbon)	95.50
Graphite	4,300.00	Steel (transformer)	66.17
Iron (pure, annealed)	60.16	Tantalum	93.25
Iron (Cast)	435.00	Tin	69.17
Lead	132.35	Tungsten (drawn)	33.68
Magnesium	276.74	Zinc	34.85

RESISTANCE, MEASUREMENT OF.—See *Bridge, Measurements by*, also *Law, Ohm's*.

RESISTANCE, NEGATIVE.—The effect of feeding energy from the plate circuit of a tube back into the grid circuit of the same tube so that the resistance of the grid circuit is overcome is called negative resistance. The effect is much as though the resistance of the grid circuit were made less than zero. Then, in place of the grid circuit absorbing power, it delivers power to the tube. Oscillation and regeneration will take place with negative resistance. See also *Regeneration, Action and Principle of*.

RESISTANCE, OHMIC.—The opposition to flow of electric current which is due to the material, temperature and size of the conductor is called ohmic resistance. Ohmic resistance affects both direct and alternating currents. It affects the flow of low frequencies and high frequencies. Resistance is measured in ohms. A circuit through which an electrical pressure of one volt will send a current of one ampere has a resistance of one ohm. See *Law, Ohm's*.

RESISTANCE, PARALLEL CIRCUIT

The resistance of a conductor depends on the material of which it is made, on its length, on its size or cross-sectional area, and to some degree on temperature, high temperatures increasing the resistance of metals.

The resistance of a conductor varies directly with its length, that is, a conductor 200 feet long has twice the resistance of another one which is similar except for being 100 feet long. A conductor similar in all other ways, but only fifty feet long, has half the resistance of the 100-foot length.

The resistance of a conductor varies inversely with its cross-sectional area or its size around. That is to say, a conductor two square inches in area has half the resistance of a similar conductor having one square inch area, and one having one-half square inch area would have twice the resistance of the one square inch size.

RESISTANCE, PARALLEL CIRCUIT.—The calculation of resistance in parallel circuits differs from the calculation for series circuits. The total resistance of two conductors in parallel is less than the resistance of either conductor taken alone. A parallel circuit consists of two or more conductors all connected to a common source of voltage and current as in Fig. 1. A parallel circuit is sometimes called a shunt circuit and the conductors are called shunts.

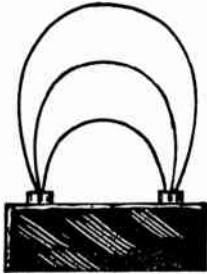

FIG. 1.—Circuits with Resistances in Parallel on Battery.

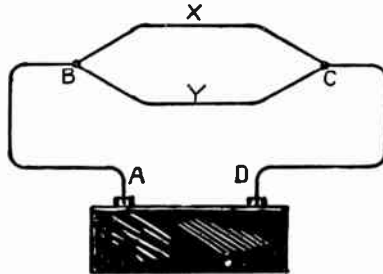

FIG. 2.—Parallel Circuit with Its Resistance as Part of Series Circuit.

For purposes of explanation, the parallel circuit will be treated as if the conductors forming the shunts were each attached to the common source of pressure and current. It will often be found, however, that a parallel circuit will form a part of a series circuit as in Fig. 2. In the illustration the portion of the circuit between A and B would be treated as a series circuit and so would the portion from C to D. In this way it would be possible to determine the amperage flowing through the shunts X and Y from B to C and to find the potential difference between B and C, which would be the voltage acting on the parallel circuit.

If the source of Fig. 2 is considered as having 12 volts pressure, if the lines A-B and C-D have 2 ohms resistance each and if the shunt circuit B-C has 2 ohms, then 2 amperes will flow in each part and 2 amperes will flow from B to C, dividing between X and Y. We know the amperage in B-C and the resistance, each being 2. Then multiplying 2 by 2 gives the potential difference as 4 volts between B and C. This 4 volts pressure acts on X and also on Y.

RESISTANCE, PARALLEL CIRCUIT

It is often desired to find the combined resistance of all the parts forming a parallel circuit, or to find the current flowing in each branch when the resistances of the branches are known.

If all the branches of a parallel circuit have the same resistance, as with the four parts of the circuit *A-B* in Fig. 3, the resistance of the entire circuit is found by dividing the resistance of one branch by the number of branches. Thus, in *A-B* of Fig. 3, dividing 20 (resistance of one branch) by 4 (number of branches) gives the combined resistance as 5 ohms. The resistance of any parallel circuit is always less than the resistance of any of its branches, because providing the current with several paths makes it easier for the electricity to flow than would be the case using only one of the several paths.

If the resistances of the several parts of a parallel circuit differ from one another, their combined resistance is found as follows: All of the resistances are multiplied together and the product forms the upper part or numerator of a fraction which will show the total resistance. Thus in *A-B* of Fig. 4, multiply $2 \times 3 \times 4 = 24$, which will be the numerator. Then multiply each resistance by each one of all the other resistances and add together all the numbers thus found. In *A-B* of Fig. 4, this would be done as follows: (2×3) plus (2×4) plus $(3 \times 4) = 6 + 8 + 12 = 26$, which will be the lower part or denominator of the fraction to be found. It will be seen that in the latter operation each resistance was multiplied by each of the other resistances. The fraction indicating the resistance of the shunt circuit *A-B* will then be $24/26$ or $12/13$ ths of an ohm. The same method can be applied to any number of shunts.

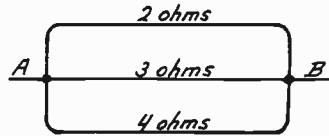
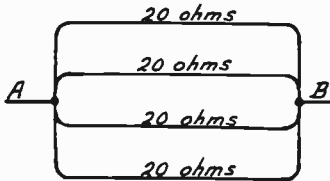

FIG. 3.—Parallel Circuits with Equal Resistances.

FIG. 4.—Parallel Circuits with Unequal Resistances.

If the potential difference or voltage between the ends of any one shunt is known and if the resistance of the shunt is known, the flow through that branch may be found by applying the rule: amperage is equal to voltage divided by resistance. Thus, in *A-B* of Fig. 4, if the potential difference is assumed to be 12 volts, then the flow through the 2-ohm branch will be 12 divided by 2, or 6 amperes; the flow in the 3-ohm branch will be 12 divided by 3, or 4 amperes; and the flow in the 4-ohm branch will be 12 divided by 4, or 3 amperes. The total flow will then be equal to the sum of the flows in the branches, or $6 + 4 + 3 = 13$ amperes.

This conclusion may be proven correct because the total resistance of the circuit *A-B* was previously found to be $12/13$ ths of an ohm and applying the rule, amperage is equal to voltage divided by resistance, dividing 12 (the voltage) by $12/13$ (the resistance) the amperage is found to be 13.

The combined resistance of two resistances in parallel is shown as follows:

$$R = \frac{Ra \times Rb}{Ra + Rb}$$

RESISTANCE, PLATE

when R is the combined resistance and R_a and R_b are the separate resistances.

The combined resistance of any number of resistances in parallel is shown as follows:

$$\frac{1}{R} = \frac{1}{R_a} + \frac{1}{R_b} + \frac{1}{R_c} + \frac{1}{R_d} + , \text{ etc.}$$

when R is the combined resistance and $R_a, R_b, R_c, R_d,$ etc. are the separate resistances. The reciprocal of the total resistance is equal to the sum of the reciprocals of the separate resistances.

RESISTANCE, PLATE.—See *Tube, Output Resistance and Impedance of*; also *Tube, Characteristics of*.

RESISTANCE, SERIES CIRCUIT.—The diagram illustrates a series circuit made up of five different conductors attached between the terminals of a 6-volt battery and with the assumed resistance of each part marked for reference. Current flowing through any one part must flow through all the others.

The resistance of a series circuit is equal to the sum of the resistances of the parts included in the circuit. Therefore, the resistance of the circuit is as follows:

A to B	$\frac{1}{2}$ ohm
B to C	1 ohm
C to D	3 ohms
D to E	1 ohm
E to F	$\frac{1}{2}$ ohm
Total, A to F	
	6 ohms

Knowing the resistance of a series circuit and the voltage acting on the circuit (in this case 6 volts) the amperage can be found by the rule that the amperes are equal to the volts divided by the ohms. Then, dividing 6 (volts) by 6 (ohms) gives the current flow as 1 ampere. The current flow is the same through all parts of a series circuit regardless of the resistance of the part being considered. Thus, the current through the circuit from C to D against 3 ohms resistance is 1 ampere and the current through the circuit from A to B against $\frac{1}{2}$ ohm resistance is likewise 1 ampere.

In the example being considered it is known that there is a pressure of 6 volts between the ends of the circuit A and F , and it is evident that it requires 6 volts to send 1 ampere through this circuit. Yet there will not be 6 volts pressure between C and D , for example, because it is known that it does not require 6 volts to send 1 ampere against 3 ohms resistance. The rule has been given that voltage is equal to the number of amperes times the number of ohms, and, applying this rule between C and D , 1 (ampere) times 3 (ohms) we find that 3 volts pressure is required. This pressure of 3 volts is used between C and D and the potential difference is said to be 3 volts. Similarly the potential difference between any other points may be found; as from B to C , 1 ohm times 1 ampere indicates 1 volt drop from B to C .

RESISTANCE, SHUNT.—See *Resistance, Parallel Circuit*.

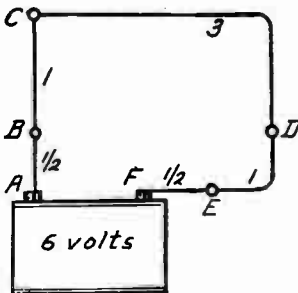

Series Circuit of Five
Conductors.

RESISTANCE, UNITS OF

RESISTANCE, UNITS OF.—The practical unit of resistance is the ohm. One ohm is the resistance of a column of pure mercury having a weight of 14.4521 grams, a uniform cross-section of one square millimeter and a length of 106.3 centimeters at a temperature of 0 Centigrade, 32° Fahrenheit. See also *Ohm*.

A microhm is the one-millionth part of an ohm. A megohm is one million ohms.

RESISTANCE, VARIABLE.—A resistance unit in which the value of the resistance is readily changed is called a variable resistance. Rheostats and potentiometers are forms of variable resistances.

RESISTANCE, WIRE FOR.—See *Resistance, Materials for*.

RESISTANCE COUPLED AMPLIFIER.—See *Amplifier, Audio Frequency, Resistance Coupled*.

RESISTANCE COUPLING.—See *Coupling, Resistance*.

RESISTOR.—A resistor is a device of which the purpose is to provide resistance in an electrical circuit. Adjustable resistors may be varied in value of resistance while in use. Fixed resistors cannot readily be changed while in use. Adjustable resistors are used as rheostats, potentiometers, volume controls, etc. Fixed resistors are used in the voltage dividers of power units, for furnishing grid biases and for grid leaks, for resistance couplings, for control of filament current and similar purposes.

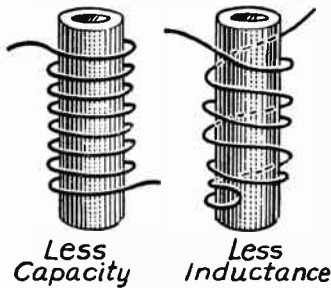

FIG. 1.—Space Winding and Non-inductive Winding of Resistors.

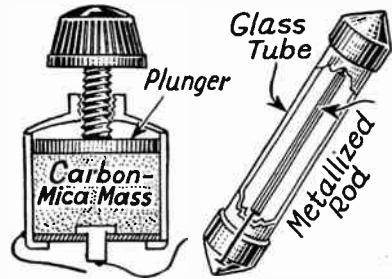

FIG. 2.—Carbon Type and Metallized Type of Resistors.

There are three electrical factors in a radio circuit; resistance, inductance and capacity. A resistor should have the least possible inductance and capacity. Resistors formed of wire windings have a certain amount of capacity distributed between turns, the amount being lessened by spacing the turns as in Fig. 1. An ordinary spiral of wire has more or less inductance because it forms a coil but the inductance may be reduced by winding one half the wire in each direction as shown.

Adjustable resistors are sometimes constructed from a mixed mass of carbon which is a conductor, and flake mica which is an insulator, as the resistance material. The resistance is lessened by compressing this mixture to force

RESISTOR

the carbon particles into closer contact and is raised by releasing the pressure, whereupon the springiness of the mica separates the carbon particles and reduces the area of contact. The construction is shown in Fig. 2. Such a resistor has negligible inductance and but small capacity.

Many fixed resistors are made by depositing carbon or a metal such as tungsten on glass or other insulating material, then subjecting the unit to great heat which unites the elements and makes a permanent job. The conducting deposit may be carried on a thin glass filament placed within a protecting glass tube as in Fig. 2 or it may be deposited on the inner wall of a glass tube. Such units have practically no inductance and are nearly free from capacity.

Vitreous enamelled resistors are used extensively in power units. They are made by space winding the resistance wire on a tube of insulating material, then covering the whole with material which, when subjected to great heat, turns to a glass-like enamel. The supporting tube, the wire and the enamel are selected so that all three have practically the same amount of expansion at given degrees of heat. Mechanical stresses are avoided by the uniform expansion as the unit heats and cools when in use. This type of resistor and those shown in Fig. 2 have the desirable characteristics of being unaffected by moisture.

Most materials change their resistance with change of their temperature. In general, the metals increase their resistance with increase of heat and are said to have a positive temperature coefficient of resistance. Carbon, on the contrary, decreases its resistance as its temperature rises and is said to have a negative temperature coefficient. The relation between the change of temperature and the change of resistance is called the temperature coefficient of the material. The smaller the temperature coefficient or the less the change of resistance, the more satisfactory will be the resistance material.

Special resistance wires have been developed in which the temperature coefficient is very small. While conductors such as copper, aluminum and steel will increase their resistance by about thirty per cent between ordinary room temperature and the temperature of boiling water, special resistor wires show less than the hundredth part of this change. Most of these special wires are alloys of iron and nickel. The actual resistance of any commercial resistor is presumed to be within five to ten per cent above or below its normal rating in ohms.

The chief limitation in the use of any given resistor is its heating. The heat developed is proportional to the product of the resistance in ohms and the square of the current in amperes. This product equals the number of watts of power being dissipated in the resistor and because of this fact resistors which are to handle any appreciable current are generally rated in the number of watts they will safely dissipate as well as in the number of ohms resistance. The heating of a resistor, while due chiefly to the power dissipated, is also increased by its proximity to other hot parts such as tubes and other resistors and to lack of sufficient air circulation. As a matter of safety and to insure long life, resistors are generally operated at about one-half their rating in watts and at something less than three-fourths of their maximum carrying capacity in milliamperes.

The safe current in milliamperes which may be carried by a resistor of given rating in watts is found from the formula:

$$\text{Maximum Milliamperes} = 1000 \times \sqrt{\frac{\text{allowable watts}}{\text{resistance in ohms}}}$$

For example, the allowable current through a 1000-ohm resistor rated at 40 watts is found by dividing 40 by 1000, giving 0.04; extracting the square root of this quantity, which is 0.2; and multiplying by 1000 to give 200 milliamperes as the safe current limit.

RESISTOR, FILAMENT CONTROL

In the selection of a resistor for certain work it is generally known to begin with that there should be a drop of so many volts and a current flow of a given number of milliamperes. Multiplying the voltage by 1000 and dividing the result by the number of milliamperes gives the required number of ohms resistance, thus:

$$\text{Resistance in ohms} = \frac{\text{Volts Drop} \times 1000}{\text{Milliamperes Current}}$$

Knowing the required resistance and the current to be carried, the required wattage is found by squaring the number of amperes and multiplying this result by the number of ohms. If the current is measured in milliamperes, the formula becomes:

$$\text{Required Watts} = \frac{(\text{milliamperes})^2 \times \text{Ohms}}{1,000,000}$$

Resistors of the types described here are used for voltage control, for coupling resistances, for control of filament current, for grid leaks and for all similar work in radio circuits. Resistors are also used to change the characteristics of coupling transformers, to flatten resonance curves in tuned circuits and to control the volume and amplification in all types of receivers.

For the determination of the required resistance in voltage divider resistors see *Power Unit, Plate Voltage Types*. For methods of measuring the number of ohms resistance in power unit resistors see *Trouble, Receiver and Power Unit*.

RESISTOR, FILAMENT CONTROL.—Fixed resistance units are used for the automatic control of filament voltage in radio receiver tubes, these fixed resistors taking the place of rheostats.

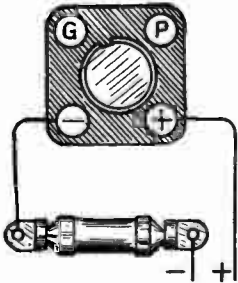

FIG. 1.—Filament Resistor.

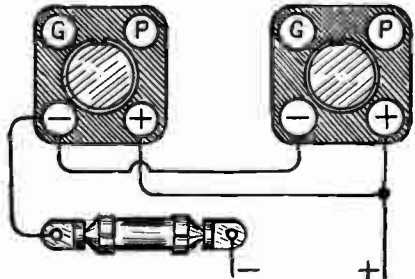

FIG. 2.—Single Filament Resistor for Two Tubes.

These units are made in different current carrying capacities. A unit for handling a one-quarter ampere tube is of course designed to carry one-quarter ampere of current. Its connection in the filament circuit is shown in Fig. 1. These units are also made to carry six hundredths of an ampere, one-eighth ampere, one-half ampere,

RESONANCE

or one ampere. A one-half ampere unit may be used for controlling a single tube requiring one-half ampere of filament current or it may be used to control two one-quarter ampere tubes in parallel as in Fig. 2. The one ampere unit is used for the control of a single tube requiring one ampere of filament current, for the control of two half-ampere tubes in parallel, or for the control of four quarter-ampere tubes in parallel.

The resistance element used in these units is made of iron wire or of iron alloys. Iron has the peculiar property of greatly increasing its resistance at a critical temperature which is just below red heat. This characteristic of iron is illustrated in Fig. 3. With a gradual rise of temperature the resistance of the iron rises slowly but just before the iron becomes red hot the resistance goes up rapidly and limits the flow of current. The size or gauge of the wire is selected so that this increase of resistance will occur when the rated current flow of the resistor has been reached. This action of the wire is independent of the voltage applied, therefore, a resistor of this type tends to maintain a fairly constant flow of current through the tube filament even as the battery becomes discharged.

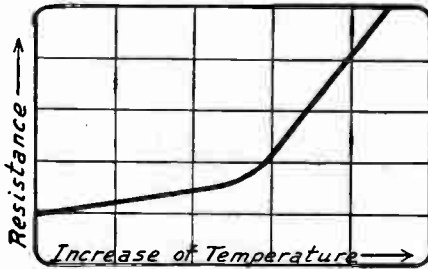

FIG. 3.—Increase of Resistance with Temperature in Iron Used as Filament Resistor.

The various kinds of fixed resistance for controlling filament voltage operate satisfactorily with storage batteries but not with dry cells. With a storage battery the change in current flowing to a quarter-ampere tube between the voltage given by a fully charged battery and the voltage of a discharged battery is only about six thousandths of an ampere. This is because the voltage of a storage battery does not drop to any great extent until it is almost fully discharged.

These fixed resistors are very satisfactory for the control of current through audio frequency and radio frequency amplifying tubes. But because it is often advantageous to change the voltage applied to the detector tube filament in obtaining maximum sensitivity, they are not as well suited as a variable rheostat for use with the detector.

RESONANCE.—Flow of alternating current in a circuit is opposed by three things; the resistance, the inductive reactance and the capacitive reactance. The resistance is due to the resistance of the various conductors in the circuit and to the connections between them. It may be reduced by using conductors of adequate size and of good conductivity, but resistance cannot be completely eliminated from any circuit.

The inductive reactance depends on the inductance in the circuit, the greater the inductance in the coils and other parts the greater

RESONANCE

being the resultant inductive reactance. The capacitive reactance depends on the capacity of the condensers and other parts in the circuit, the greater the capacity the less the capacitive reactance. Further explanations are given under the heading of *Reactance*.

Inductive reactance is often called positive reactance while capacitive reactance is often called negative reactance. This is because they have opposite effects in a circuit, that is, they tend to neutralize each other.

If we have an alternating current circuit containing a certain amount of inductive reactance, we can introduce capacitive reactance into this circuit and by gradually increasing the capacitive reactance can finally reach a point where the two reactances exactly balance each other and leave only the resistance to oppose flow of current through the circuit.

A circuit containing only resistance and inductive reactance offers opposition to the flow of current, this opposition being due to the combined effects of the resistance and the inductive reactance. We may also have a circuit containing only resistance and capacitive reactance in which opposition to flow of current is caused by the

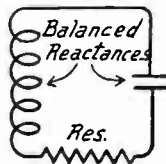
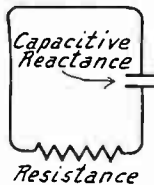
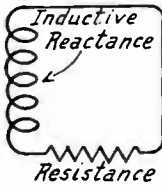

FIG. 1.—Circuits with Inductive and Capacitive Reactances to Produce Resonance.

FIG. 2.—Condition of Series Resonance.

combined effects of the resistance and reactance. These circuits are shown in Fig. 1. But if we have an alternating current circuit containing resistance, inductive reactance and capacitive reactance, the two reactances may be made such that they balance out. This condition is called resonance. See *Radio, Principles of*.

When an alternating current circuit, as in Fig. 2, containing resistance and the two kinds of reactance all in series is at its resonant point the effect of the reactances is removed and we have the greatest possible flow of current through the circuit at this time because only resistance remains. Resonance obtained when the resistance, the inductive reactance and the capacitive reactance are all in series with each other is called series resonance.

When we are speaking of adjusting the capacity and inductance to resonance we are always referring to resonance at a certain frequency. At any given frequency there are certain values of capacity and inductance which cause resonance at this frequency but at no other frequency. If the frequency in the alternating current circuit should change, it would be necessary to make a different adjustment of either inductance or capacity, in order that the resonant condition might again be obtained at the new frequency.

RESONANCE

With a given adjustment of capacity and inductance or a given relation between them their reactance will balance out for one certain frequency and current at this frequency will then flow through the circuit in maximum volume although currents at any other frequency still will be opposed by the reactances. The circuit is then said to be in resonance at that frequency.

In practice, resonance is never so sharply defined at any one frequency that the reactance disappears completely for that frequency, yet remains high for all other frequencies. The reactance is least for the resonant frequency, then gradually increases for frequencies farther and farther away from the point of resonance.

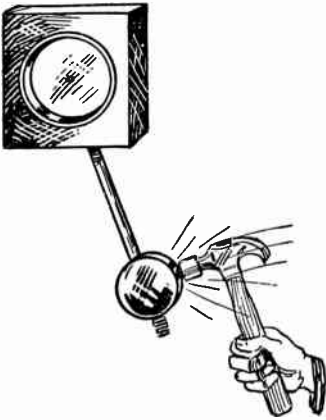

FIG. 3.—Mechanical Resonance Between Pendulum and Hammer.

Then every blow of the hammer adds to the swing of the pendulum until the pull of gravity and the friction on the pendulum prevent further increase just as in the resonant circuit the resistance finally prevents further increase of current.

The frequency of resonance is given by the following formulas when the inductance and the capacity are known:

$$\text{Frequency} = \frac{159,155,000}{\sqrt{\text{microhenries} \times \text{micro-microfarads}}}$$

$$\text{Frequency} = \frac{159,155}{\sqrt{\text{microhenries} \times \text{microfarads}}}$$

$$\text{Frequency} = \frac{5,033}{\sqrt{\text{millihenries} \times \text{microfarads}}}$$

$$\text{Frequency} = \frac{159.16}{\sqrt{\text{henries} \times \text{microfarads}}}$$

These values of frequency are in cycles per second. Dividing the result by 1000 will reduce the frequency to kilocycles.

As the frequency is lowered, either the inductance, the capacity of both must be increased to maintain resonance. If the frequency is increased, then the capacity, the inductance, or both must be decreased to maintain resonance. In other words, the greater the frequency the less must be the capacity and inductance and the lower the frequency the greater must be the capacity and inductance.

We may consider a circuit tuned to resonance as being similar to the pendulum of Fig. 3 which swings naturally at a certain speed or frequency. The applied alternating current, which must be of the same frequency, may be considered as similar to a hammer with which the pendulum is being struck. The hammer must be swung at the same speed or frequency with which the pendulum is moving.

RESONANCE, COUPLING EFFECT ON

The wavelength in meters for resonance is given by the following formulas:

$$\text{Wavelength} = 1.884 \times \sqrt{\text{microhenries} \times \text{micro-microfarads}}$$

$$\text{Wavelength} = 1884 \times \sqrt{\text{microhenries} \times \text{microfarads}}$$

$$\text{Wavelength} = 59,750 \times \sqrt{\text{millihenries} \times \text{microfarads}}$$

$$\text{Wavelength} = 1,884,000 \times \sqrt{\text{henries} \times \text{microfarads}}$$

RESONANCE, COUPLING EFFECT ON.—See *Coupling, Effect on Resonance.*

RESONANCE, INDICATOR FOR.—See *Meter, Frequency.*

RESONANCE, INDUCTANCE-CAPACITY VALUES FOR.—It is the product of the inductance and capacity in a circuit that determines the frequency at which the circuit is resonant. For each frequency there is a certain value of this product which is called the inductance-capacity value or the L-C value for resonance. Knowing this value it is possible to determine the correct inductance for use with any given capacity or the correct capacity for use with any given inductance. The L-C value is divided by the known capacity or the known inductance, the quotient of the division being the required inductance or capacity, thus:

$$\text{Inductance} = \frac{\text{L-C value}}{\text{Capacity}} \qquad \text{Capacity} = \frac{\text{L-C value}}{\text{Inductance}}$$

In the following table are given the inductance-capacity values for resonance at frequencies in the broadcast transmission bands. The inductance is to be measured in microhenries and the capacity in microfarads.

As an example, it might be desired to find the required inductance of a coil to tune to a frequency of 550 kilocycles or 545.1 meters wavelength with a condenser of .0005 microfarad capacity. The L-C value for this frequency is found from the table to be .08428. Substituting in the formula and dividing this value by the capacity (0.0005) gives the result as 168.56 microfarads of inductance or approximately 170 microfarads.

Again, it might be desired to learn the required minimum capacity of the tuning condenser to reach the frequency of 1500 kilocycles or the wavelength of 199.9 meters with the coil of 170 microfarads inductance. The L-C value for this frequency is found to be .01127 in the table. Dividing this by the inductance (170) gives as a result .0000663 (approximate) microfarad of minimum capacity. The required change of capacity is then from about .000066 to .0005 microfarad. Any other coil and condenser combination may be similarly calculated.

RESONANCE, INDUCTANCE-CAPACITY VALUES FOR

Frequency in Kilocycles	Wavelength in Meters	L-C Value	Frequency in Kilocycles	Wavelength in Meters	L-C Value
550	545.1	.08428	1030	291.1	.02389
560	535.4	.08119	1040	288.3	.02343
570	526.0	.07827			
580	516.9	.07551	1050	285.5	.02299
590	508.2	.07288	1060	282.8	.02255
			1070	280.2	.02213
600	499.7	.07040	1080	277.6	.02171
610	491.5	.06808	1090	275.1	.02130
620	483.6	.06593			
630	475.9	.06383	1100	272.6	.02090
640	468.5	.06185	1110	270.1	.02052
			1120	267.7	.02016
650	461.3	.05998	1130	265.3	.01980
660	454.3	.05823	1140	263.0	.01946
670	447.5	.05658			
680	440.9	.05501	1150	260.7	.01914
690	434.5	.05348	1160	258.5	.01882
			1170	256.3	.01852
700	428.3	.05198	1180	254.1	.01821
710	422.3	.05051	1190	252.0	.01789
720	416.4	.04907			
730	410.7	.04767	1200	249.9	.01760
740	405.2	.04630	1210	247.8	.01731
			1220	245.8	.01702
750	399.8	.04495	1230	243.8	.01675
760	394.5	.04380	1240	241.8	.01648
770	389.4	.04268			
780	384.4	.04164	1250	239.9	.01622
790	379.5	.04060	1260	238.0	.01596
			1270	236.1	.01571
800	374.8	.03960	1280	234.2	.01546
810	370.2	.03866	1290	232.4	.01522
820	365.6	.03774			
830	361.2	.03684	1300	230.6	.01499
840	356.9	.03596	1310	228.9	.01476
			1320	227.1	.01452
850	352.7	.03511	1330	225.4	.01432
860	348.6	.03429	1340	223.7	.01411
870	344.6	.03351			
880	340.7	.03275	1350	222.1	.01390
890	336.9	.03201	1360	220.4	.01370
			1370	218.8	.01350
900	333.1	.03129	1380	217.3	.01330
910	329.5	.03059	1390	215.7	.01311
920	325.9	.02991			
930	322.4	.02926	1400	214.2	.01292
940	319.0	.02864	1410	212.6	.01274
			1420	211.1	.01256
950	315.6	.02804	1430	209.7	.01239
960	312.3	.02746	1440	208.2	.01222
970	309.1	.02688			
980	305.9	.02634	1450	206.8	.01205
990	302.8	.02582	1460	205.4	.01189
			1470	204.0	.01173
1000	299.8	.02532	1480	202.6	.01157
1010	296.9	.02483	1490	201.2	.01142
1020	293.9	.02436	1500	199.9	.01127

RESONANCE, PARALLEL

RESONANCE, PARALLEL.—We may have a circuit in which the inductance and capacity are in parallel with each other and are then placed in series with an alternating current circuit as shown in the diagram. It is now possible to adjust the inductance and capacity so that the two together form a resonant circuit. In this resonant circuit, composed of the inductance and capacity with the resistance of their connections, we would then have the conditions which allow the greatest possible flow of oscillating current back and forth between the inductance and the capacity.

With parallel resonance the loop circuit which contains the coil and condenser is itself practically in a condition of series resonance. Under this condition the voltage on the condenser is equal and opposite to the voltage on the coil and there is a flow of current back and forth between condenser and coil. At any instant the current in the coil is opposite to the condenser current. The current in the main circuit is the algebraic sum of these two currents in coil and condenser and with these currents opposite and of practically the

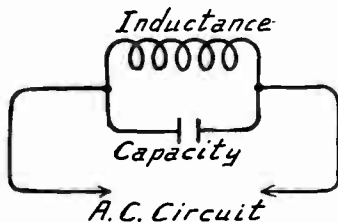

Circuit for Parallel Resonance.

same value they just about balance and the net current in the main circuit approaches zero, being equal only to the difference between the coil current and condenser current.

In adjusting the coil's inductance or the condenser's capacity to obtain parallel resonance we are really adjusting these values to cause the same value of current in both coil and condenser. The nearer the two currents approach equality the less will be the current in the main circuit.

Inductance and capacity thus arranged in parallel with each other and adjusted to resonance are sometimes called anti-resonance when placed in an alternating current circuit because this combination allows the smallest possible flow of current through the alternating circuit whereas series resonance allows the greatest possible flow through the alternating current circuit.

It is possible to change either the capacity or the inductance until they are resonant at the frequency of the alternating current circuit in which these units are connected. A condenser and coil thus tuned to a certain frequency offer an exceedingly high impedance to flow of current at that frequency.

With the capacity and inductance remaining unchanged, the frequency of the outside circuit connected to them may be changed until it reaches the frequency to which the condenser and coil happen to be tuned. We again would have the condition of parallel resonance. The condition of parallel

RESONANCE, SERIES

resonance is always reached when the values of capacity, inductance and frequency are such that the least current will flow through the circuit.

RESONANCE, SERIES.—If a condenser and a coil, that is, a capacity and an inductance are connected in series with each other and placed in series with a circuit carrying alternating current, it is possible to change either the capacity or the inductance until the inductive reactance (alternating current opposition caused by inductance) is just equal to the capacitive reactance (alternating current opposition caused by capacity). When this condition of balance is reached there will be the greatest possible flow of current

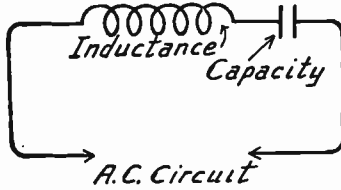

Circuit for Series Resonance.

through the circuit because the inductive reactance and capacitive reactance counteract each other for the frequency existing in the connected circuit. This condition is called series resonance. If the frequency of the circuit is changed, it will be necessary to change either the capacity or inductance to again obtain series resonance.

RESONANT CIRCUIT.—See *Resonance*.

RESONANT FREQUENCY.—See *Frequency, Resonant*.

RESONANT PEAK.—See *Transformer, Audio Frequency*.

RESONANT WAVE COIL.—See *Antenna, Resonance Wave Coil Type*.

RESONATOR.—A name sometimes given to a loud speaker. See *Speaker, Loud*.

RESTORATION OF TUBE.—See *Tube, Restoration of*.

RETENTIVITY.—See *Iron and Steel*.

RETURN, GRID.—The connection of the filament circuit of a vacuum tube to the grid circuit of the tube is called the grid return.

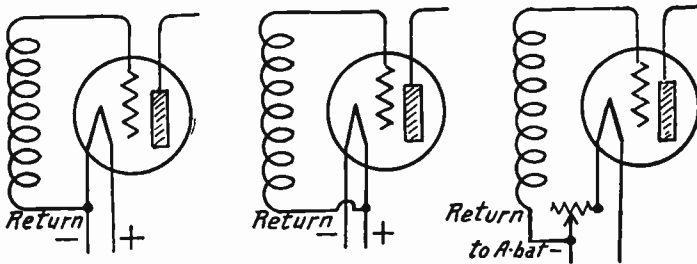

FIG. 1.—Grid Returns to Filament or Battery Lines.

RETURN, GRID

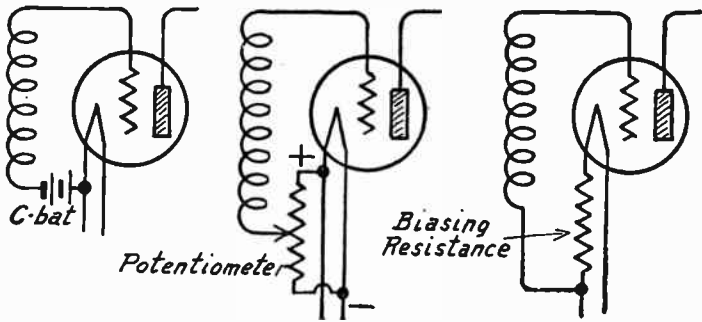

FIG. 2.—Grid Returns to C-Battery and Resistances.

The grid return may be made directly to either the positive or negative filament terminal of the tube, or it may be made through a rheostat or filament resistor as in Fig. 1. The return may be through a C-battery, through a potentiometer or through a biasing resistance as in Fig. 2.

The grid return for one tube may sometimes be made through the filament circuits of other tubes in the receiver or amplifier as shown in Fig. 3. This practice is followed when a power supply is used for filament current with the several tube filaments connected in series. See *Power Unit, Filament Current Types of*. If the plate voltages for a receiver or amplifier are furnished from a power supply unit, the grid return of one or more amplifier tubes may be made through the power unit.

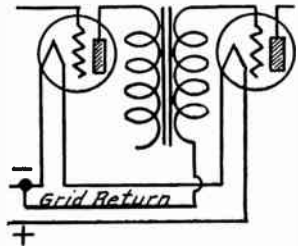

FIG. 3.—Grid Return to Filament of Preceding Tube.

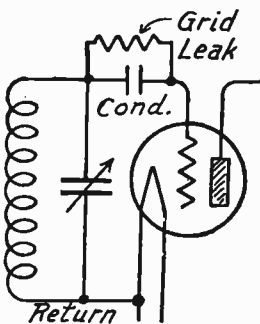

FIG. 4.—Grid Leak in Grid Return Circuit.

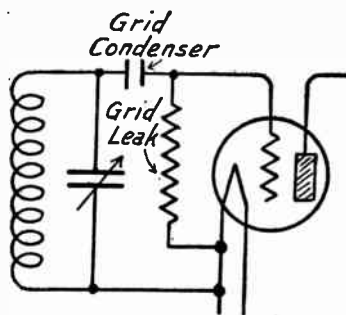

FIG. 5.—Grid Return Through Leak Across Grid Circuit.

The grid leak of a detector tube using grid condenser and leak is in the grid return circuit as shown by Figs. 4 and 5. With resistance coupling or

R. F.

with choke coil coupling the grid return is obtained through the resistance connected between the grid and filament terminals of the tubes, this being shown in Figs. 6 and 7.

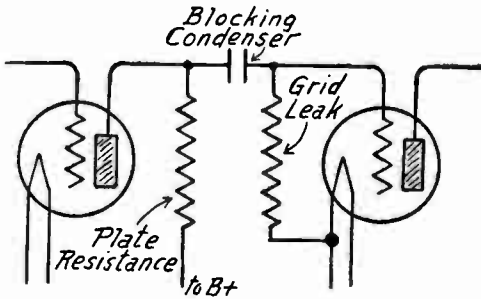

FIG. 6.—Grid Return Through Leak with Resistance Coupling.

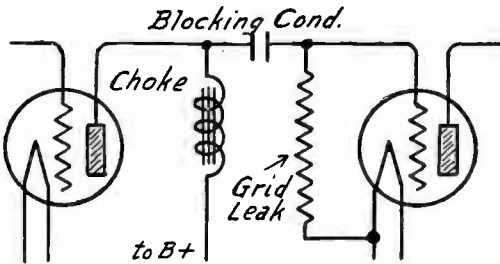

FIG. 7.—Grid Return Through Leak with Choke Coil Coupling.

See also *Bias, Grid; Circuit, Grid; and Control, Single.*

R. F.—An abbreviation for radio frequency. See *Frequency, Radio.*

RHEOSTAT.—A rheostat consists of a resistance whose value may be varied while it is inserted in series with the filament of a vacuum tube or tubes. The purpose of a rheostat is to allow an operator to apply the correct voltage to the tube's filament and to thus allow the correct flow of current through the filament.

There are two important features in rheostat design to be considered from the electrical standpoint. First, the rheostat must have a sufficient resistance to prevent an excessive flow of current through the tube filament. Second, the material of which the resistance is made must be able to carry a sufficiently large current to operate the tube filament at its most efficient temperature.

In a radio receiver we may provide one rheostat for each separate tube or two or more tubes may be operated in parallel from one rheostat. Various rheostat connections are shown in Figs. 1 and 2. In some receivers the filaments of two or more tubes are placed in series with each other. This may be done when dry cell tubes are operated from storage batteries, or when filament power supply units are employed.

RHEOSTAT

It is usual practice to place the rheostat in the negative filament line. This is because the voltage drop through the rheostat is often used as a grid biasing voltage. If a C-battery is used for grid biasing voltage it is immaterial which filament line contains the rheostat. It may be more desirable to place the rheostat in the positive line if the grid return is brought directly to the filament or brought through a C-battery to the filament.

With the grid return brought to the battery side of a rheostat, the voltage drop in the rheostat provides a grid bias and every change in rheostat setting makes a change in the biasing voltage. With the grid return brought directly to the negative filament terminal the voltage drop in the rheostat has no effect on the grid bias. With the rheostat placed in the positive lead to the filament it likewise has no effect on the grid bias. This is always the better practice when using external means for biasing.

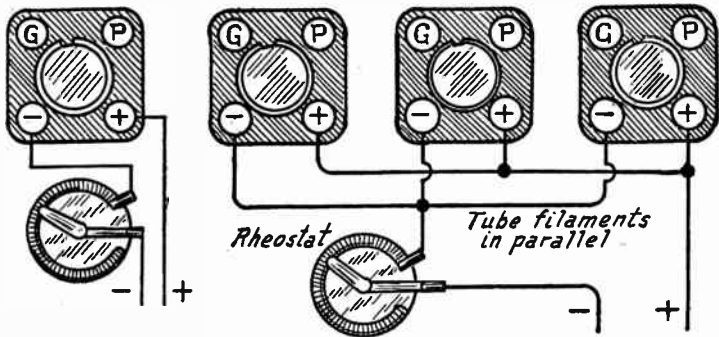

FIG. 1.—Rheostat in Negative Line (Left) and Single Rheostat for Three Tubes in Parallel (Right).

Rheostats are usually made of a resistance element consisting of a flat coil of resistance wire formed into part of a circle so that the rheostat arm or slider may be turned by a knob to make contact at various points along the element. This places more or less of the resistance in the filament circuit. Examination of a rheostat will show that one of its terminals is connected to the slider and that the other terminal is connected to one end of the resistance element. The terminal connected to the slider is usually attached to the line from the battery or other current supply unit. The terminal connected to the resistance element is then attached to the line running to the tube filament. This is indicated in Figs. 1 and 2.

As the rheostat knob is rotated all the way to the left, anticlockwise, it will be found that the slider runs off one end of the resistance element, thus opening the circuit through the rheostat and allowing it to act as a battery switch when no other switch is provided. As the rheostat is turned in a clockwise direction, to the right, the arm will again make contact with the end of the resistance element which is farthest from the terminal connected to the tube filament. All of the resistance is then in circuit. Continued turning of the rheostat arm to the right cuts out more and more of the resistance until the end of the arm finally rests on the end of the resistance that is connected to the tube filament. All of the resistance is then out of the circuit.

RHEOSTAT, FIXED TYPE

A rheostat should be solidly and substantially built. The slider must make a positive contact with the resistance element at every point in its travel and the movement from one turn of the resistance wire to the next turn should be smooth. The shaft which carries the slider and knob must not be loose in its bearing. A good rheostat will not cause any noises in the receiver when its knob is moved up and down or pulled back and forth.

It is essential that the resistance element be able to carry the current that is required for the tubes it controls. When tubes are operated in parallel from a single rheostat the number of amperes required by one tube must be multiplied by the number of tubes in order to find the total number of amperes to be carried by the rheostat. A rheostat having too small current carrying ability will overheat badly, oxidize the contact surfaces, and probably burn out the resistance element.

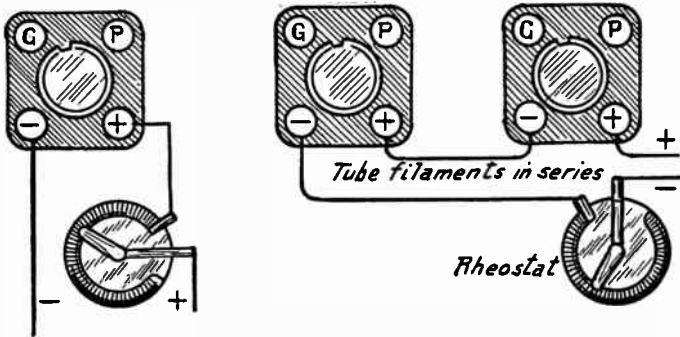

FIG. 2.—Rheostat in Positive Line (Left) and Rheostat for Two Tubes in Series (Right).

Rheostats are made in standard sizes having resistances from one and one-half ohms to fifty ohms and they are designed to carry from one-third ampere to three amperes in the types used for receiving sets. The following table gives the usual proportion between resistance and current carrying capacity:

STANDARD RHEOSTATS

Resistance in Ohms	Capacity in Amperes	Resistance in Ohms	Capacity in Amperes
2	2.5 to 3.0	20	0.6 to 0.75
6	1.0 to 1.5	30	0.5 to 0.6
10	0.75 to 1.0	50	0.3 to 0.4

RHEOSTAT, FIXED TYPE.—See *Resistor, Filament Control*.

RHEOSTAT, GRID BIAS WITH.—See *Bias, Grid*.

RHEOSTAT, SIZES REQUIRED.—In order to find the resistance in ohms that should be provided in a rheostat for any given work we must know the voltage of the battery which supplies the current, the filament voltage at which the tube is rated to operate

RHEOSTAT, SIZES REQUIRED

and the rated number of amperes through the filament at this voltage. These last two values, the filament volts and filament amperes, are given in the instruction sheets or on the boxes of all tubes.

From the number of volts furnished by the battery subtract the number of volts at which the filament should operate, then divide this difference by the number of amperes that should flow through the filament.

For example, a 201A tube should be operated at 5 volts with 0.25 ampere. If such a tube is operated from a 6-volt storage battery, we subtract 5 from 6, leaving 1, then divide 1 by 0.25, giving 4 as the number of ohms resistance in the proper rheostat. Of course any greater rheostat resistance may be used provided it will carry sufficient current.

If more than one tube is operated from a single rheostat, divide the number of ohms obtained from the foregoing calculation by the number of tubes to be handled with the one rheostat. To find the number of amperes that must be carried by a rheostat which controls more than one tube, multiply the amperage for one tube by the number of tubes.

The following table gives the required number of ohms resistance and the size rheostat generally used for various types of tubes operating on from 1.1 to 7.5 volts and from 0.06 to 1.00 ampere. The table takes in batteries from one dry cell delivering 1.5 volts up to 8.0 volts on a large storage battery.

REQUIRED RHEOSTAT SIZES

Tube Filament Volts	Tube Filament Amperes	Battery Type	Battery Volts	For 1 Tube		2 in Parallel		3 in Parallel	
				No. of Ohms	Usual Rheo.	No. of Ohms	Usual Rheo.	No. of Ohms	Usual Rheo.
1.1	.25	Dry Cell	1.5	1.6	6 or 10	0.8	6 or 10	0.53	6 or 10
1.1	.25	Storage	2.0	3.6	6 or 10	1.8	6 or 10	1.2	6 or 10
1.1	.25	Storage	6.0	19.6	20	9.8	10	6.53	10
3.0	.06	Dry Cell	3.0	0.0	6 or 10	0.0	6	0.0	6
3.0	.06	Storage	4.0	16.6	20	8.3	10	5.53	6 or 10
3.0	.06	Dry Cell	4.5	25.0	30	12.5	20	8.33	10
3.0	.06	Storage	6.0	50.0	50	25.0	30	16.66	20
3.0	.125	Storage	4.0	8.0	10	4.0	6 or 10	2.66	6 or 10
3.0	.125	Dry Cell	4.5	12.0	20	6.0	10	4.0	6 or 10
3.0	.125	Storage	6.0	24.0	30	12.0	20	10.0	10 or 20
5.0	.25	Storage	6.0	4.0	6 or 10	2.0	6 or 10	1.33	6
5.0	.50	Storage	6.0	2.0	6 or 10	1.0	6	0.66	2
5.0	1.00	Storage	6.0	1.0	6	0.5	2	—	—
6.0	.25	Storage	6.0	0.0	6	0.0	6	0.0	6
6.0	.50	Storage	6.0	0.0	6	0.0	6	0.0	2
6.0	.50	Storage	8.0	4.0	6 or 10	2.0	2 or 6	1.33	2
6.0	1.00	Storage	6.0	0.0	6	0.0	2	—	—
6.0	1.00	Storage	8.0	2.0	2 or 6	1.0	2	—	—
7.5	.50	Storage	8.0	1.0	6	0.5	2 or 6	0.33	2
7.5	1.00	Storage	8.0	0.5	2	0.25	2	—	—

RHEOSTAT, VERNIER

One dry cell gives 1.5 volts pressure, two dry cells give 3.0 volts, three dry cells give 4.5 volts and four dry cells give 6.0 volts when all the cells are connected in series. A storage battery giving 2.0 volts pressure is a one-cell battery, a storage battery giving 4.0 volts has two cells, one giving 6.0 volts has three cells and one giving 8.0 volts has four cells.

The rheostat sizes given in the column headed "Usual Rheostat" are those which will carry the current required and give the needed voltage regulation.

RHEOSTAT, VERNIER.—Rheostats in which it is possible to obtain a very slow and gradual change of resistance are called vernier rheostats. This type may be used whenever the filament temperature requires accurate setting, such as with certain forms of detector tubes and also when the filament voltage is used for control of regeneration and oscillation.

There are various types of vernier rheostats. Some are made with a single long length of wire laid in a spiral groove so that the tip end of the slider may move around and around in the screw threads. The slider travels from one end of the resistance wire to the other with several complete turns of the control knob.

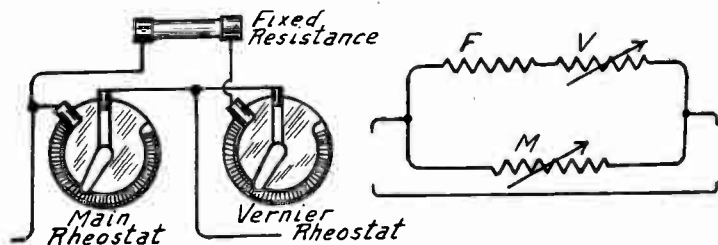

Vernier Action with Two Rheostats and Fixed Resistor.

Other vernier rheostats are provided with an additional short length of resistance wire mounted in a part circle so that an extra slider arm may be moved over it. This added wire is in series with the main resistance element and its resistance is usually equal to that of one or two turns of the main element.

A very fine control of filament voltage and current may be secured by using two ordinary variable rheostats and a fixed resistance in the arrangement shown. The connections of the three units are shown at the left and the circuit is shown at the right. The main rheostat forms one side of a parallel circuit while the fixed resistance and the vernier rheostat connected end to end form the other side of the parallel circuit. The advantage of this scheme may be realized when it is stated that two 10-ohm rheostats and a 25-ohm fixed resistance used as shown will allow the entire range of the vernier rheostat to make a change of only one-quarter ohm in the total resistance. A radio frequency receiver using this control for regeneration is shown under *Receiver, Tuned Radio Frequency*.

In selecting the values of resistance for this combination the following points should be observed: The main rheostat determines the maximum resistance which may be had, therefore this main rheostat should be of the resistance that would normally be used if no vernier method were contemplated. Having selected the proper resistance for the main rheostat it is generally satisfactory to use a vernier rheostat of the same resistance value.

RIBBON ANTENNA

The greater the resistance of the vernier rheostat the coarser will be the vernier action. Using a 10-ohm main rheostat and a 25-ohm fixed resistance; a 20-ohm vernier will allow a total resistance change of 1.04 ohms, a 10-ohm vernier will allow a total change of 0.63 ohm, while a 6-ohm vernier will make a total change of only 0.42 ohm when turned completely around from one side to the other. The finer the control desired the less resistance should be used in the vernier. Of course this reduces the vernier range of adjustment.

The greater the resistance of the fixed resistance unit, the finer will be the vernier action. Using a 10-ohm main rheostat and a 10-ohm vernier; the inclusion of a 10-ohm fixed resistance will allow a total vernier action of 1.66 ohms, the use of a 25-ohm fixed resistance will allow a total vernier action of 0.63 ohm, while the use of a 50-ohm fixed resistance will allow the total travel of the vernier rheostat to change the total circuit resistance by only 0.44 ohm. Therefore, the finer the control desired the larger should be the fixed resistance.

The minimum current carrying ability of this combination is the same as the current carrying ability of the main rheostat, while its maximum ability in current is equal to the combined ability of the main rheostat and the fixed resistance or vernier rheostat.

In practice the main rheostat is set just below the point of maximum resistance required while the vernier rheostat is at the center of its total travel. The vernier will then change the resistance, either increasing it or decreasing it, to provide the needed circuit control.

RIBBON ANTENNA.—See *Antenna, Wire for*.

RICE CIRCUIT.—See *Balancing*.

RIPPLE.—A sound caused by the slight rise and fall of voltage in a direct current or in an alternating current circuit. This sound is audible when alternating current used for power in radio sending or receiving is not properly filtered and rectified.

ROBERTS RECEIVER.—See *Balancing*.

ROTOR.—The moving part of a variable condenser or a variable inductance. The moving or rotating plates of the condenser are called the rotor plates or simply the rotor. The rotating or movable winding of a variometer, variocoupler or other unit having such a winding is called the rotor.

Since the rotor is the part moved by the controls, this part will have a shaft extending to the control dials or knobs which are touched by the operator's hands. To avoid the effect of body capacity the rotor side of any unit is always connected to the grounded, the negative, or the low voltage side of the circuit including the unit. See *Capacity, Body*; also *Condenser, Connections to*.

RUBBER.—In the original state crude rubber is the gum of a tree. The crude gum is washed and thoroughly cleaned after which various fillers are added to give the rubber certain desired characteristics or to adulterate it and lower the cost of the article as finally used. This prepared gum is treated with sulphur and is heated to produce the action called vulcanization. The vulcanized rubber gains elasticity, strength and durability. The rubber generally used for wire insulation contains considerable percentages of adulterants and is often composed largely of old rubber which has been worked over or reclaimed.

RUBBER, HARD

The dielectric constant of pure rubber varies between 2.0 and 3.0, this constant increasing with increase of fillers in the compound. Good grades of insulating rubber have a dielectric strength of 250 to 900 volts per thousandth of an inch thickness.

RUBBER, HARD.—When rubber is vulcanized at high temperature, with great pressure and with the use of comparatively large quantities of sulphur it becomes very hard and strong, being called hard rubber. Hard rubber is generally jet black and takes a high gloss easily. The surface of rubber for use in decorative panels may be colored to represent natural woods or other ornamental designs.

From the standpoint of electrical properties hard rubber is one of the best of all available materials for use in insulators, brackets, supports, bases and panels of radio receivers. Hard rubber has the disadvantage of changing its form under pressure or bending strain. Bolts and other fastenings which pass through hard rubber should be secured with lock washers because in time the rubber will give under the nuts or bolt heads and looseness will result.

Hard rubber may be quite easily formed and bent into any desired shape by immersing it for a minute or two in boiling hot water. The rubber softens sufficiently to bend without cracking or breaking and if held in position until it cools the new shape will be retained. This is a very handy method for making special brackets and supports for receiver parts.

Good grades of hard rubber have a dielectric constant of 2.0 to 3.5. The dielectric strength is high, being from 1000 to over 2000 volts per thousandth of an inch thickness. It has very low dielectric losses when used in and near coils and condensers which are carrying radio frequency currents.

The phase angle difference of hard rubber at radio frequencies is about one-half of one degree. This represents an exceedingly low loss, being about one-sixth that of fibre and one-third to one-eighth that of phenol compounds.

Hard rubber deteriorates slowly with age, but if properly vulcanized in the first place and if then protected from light it is not affected. This material softens to a noticeable extent at 150 degrees Fahrenheit, at the temperature of boiling water it bends easily, at 240 degrees it becomes leathery and may be cut easily with a knife, and at 390 degrees it melts.

When exposed to sunlight hard rubber discolors and deteriorates after a few months. The sulphur in the rubber oxidizes and forms the equivalent of sulphuric acid which may take up ammonia from the air or may attack the fillers used in manufacture. Various sulphates are then formed on the surface of the rubber and its surface resistivity is greatly lowered.

Hard rubber is practically moisture proof. It absorbs only 0.02 per cent of its weight of water when immersed for twenty-four hours. Even when exposed to steam, the rubber is affected only by the heat and not by the moisture. Alcohol attacks this material to a slight degree, ammonia has no effect, benzol softens the rubber and ether dissolves a very small amount of the rubber and any free sulphur from the vulcanizing.

See also *Panel, Materials for.*

RUBBER COVERED WIRE.—See *Wire, Rubber Covered.*

RULES, UNDERWRITERS'.—The following rules are given by the Fire Underwriters in order that radio receiving installations may not void the insurance on buildings and property containing the radio apparatus.

RULES, UNDERWRITERS'

The wires of the antenna and a counterpoise if used must be so placed and supported that there is no chance of their coming in contact with any electric light or power wires even under conditions of accident to the antenna supports.

The lead-in wires must be no smaller than number 14 gauge if of copper and no smaller than number 17 if of bronze or copper-clad steel. All joints in the antenna proper are to be soldered. Where the lead-in travels along the outside of a building it must not come closer than four inches to any electric light or power wires unless it is enclosed in an additional insulating covering besides the regular insulation of the wire. Where the lead-in enters the building it must come through a bushing of porcelain or equivalent insulating material which slants down toward the outside of the opening, or else must be brought in with some special form of device that has been approved for this purpose.

Every lead-in must be provided with an approved lightning arrester placed either just outside the building or inside the building, between the lead-in entrance and the receiver and where a ground connection may be easily made. The arrester must not be exposed to inflammable gases and must not be where it may be reached by any other easily inflammable material. A grounding switch may be connected between the antenna and ground if desired, but the lightning arrester must be used just the same. The Underwriters favor the use of a grounding switch and also of a large switch connected between the lead-in and the receiver. No fuses may be placed in the circuit composed of antenna, lead-in, lightning arrester and ground lead.

The wire from the lightning arrester to ground may be insulated copper, bare copper, bronze, or copper-clad steel. The ground wire must be at least as large as the lead-in wire, that is, number 14 if of copper and number 17 if of bronze or copper-clad steel. The connection from the lightning arrester to the ground must be as short as possible. The ground wire must be protected against accidental breakage. This wire may be run either inside or outside of the building and it may be used as the regular ground connection for the receiver.

The ground connection itself must be made with an approved ground clamp when any form of piping is used for the attachment. Water piping is the favored method of obtaining a ground, although well buried metal rods or plates may be used. In steel buildings the building framework is an acceptable ground.

All wiring outside of the receiver cabinet must be installed in accordance with approved methods of light and power wiring. Wires attached to storage batteries must be rubber covered and fuses of not more than 15-ampere capacity must be placed in the storage battery lines near the battery. None of the wires outside the receiver may come closer than two inches to any light or power wire that is not enclosed in conduit unless the wires for the receiver are themselves enclosed in porcelain tubes or some approved flexible insulator besides the wire insulation.

See also *Arrester, Lightning*.

Power Unit Regulations.—Following are brief excerpts from the National Board of Fire Underwriters' standards for power-operated radio receiving devices:

The case shall enclose all current carrying parts except primary leads, secondary terminals and secondary parts not exceeding 25 volts potential. Design may allow replacement of tubes without opening the case. Metal cases must be protected against corrosion and when non-metallic cases are used all units connected to the supply circuit shall be enclosed in non-combustible material. It must be impossible for small tools or an operator's hands to be inserted through ventilating openings.

The supply circuit cord shall pass into the case through an insulating bushing with smoothly rounded edges and the cord shall be provided with

RULES, UNDERWRITERS'

strain relief. Mountings for current carrying parts shall be phenolic or cold moulded materials or equivalent. Hard fibre may be used for insulating washers and separators but not for the sole support.

Transformer primary windings shall be insulated from the core, case and secondary windings, and all transformer coils shall be protected against moisture. Primary tapping switches, if used, must not prevent the whole device from withstanding all prescribed tests under the most severe conditions possible in actual operation. Paper condensers must be protected against moisture and no condenser shall be injuriously affected by the highest temperature attained in use.

Live parts in circuits involving potentials in excess of 200 volts but not exceeding 500 volts where the power exceeds 20 watts, and live parts in circuits involving potentials in excess of 500 volts shall be wholly inaccessible, or else the act of opening the case which normally makes the part inaccessible shall cut off the voltage by a device which is positive in action and which defeats any attempt to nullify its purpose. No particular protection against accidental contact need be provided for live parts in secondary or output circuits involving potentials not exceeding 200 volts. The maximum open circuit voltage between any two external output terminals shall not exceed 200 volts.

Spacing of not less than one-half inch over the surface or through air shall be maintained between exposed live metal parts of the supply circuit and the case except where permanent separation is assured by the construction. Fuses used in the primary circuit shall be readily accessible. Temperature on the outside of non-combustible cases or on the interior surfaces of combustible cases shall not exceed 194 degrees Fahrenheit.

The insulation and spacings shall withstand the potentials specified below for one minute without breakdown while the device is hot from a full load temperature test. Between current carrying parts of the primary circuit and the transformer core, the enclosing case and the secondary circuits—900 volts. Between primary and secondary windings—twice the highest open circuit voltage plus 1000 volts A. C. Insulation of all current-carrying secondary parts except condensers—three times the highest voltage to which the parts may normally be subjected. Condensers connected to the primary or supply circuit—900 volts A. C. Condensers in secondary circuits—three times the highest normal voltage, D. C. test. Speaker coupling transformers, between primary and secondary windings, and condensers across terminals—four times the maximum plate voltage on the output tube, but in no case less than 800 volts.

The device shall be tested with its secondary output terminals connected to produce maximum primary input and operated until a constant temperature is reached or until burnout occurs. This test shall also be made with any one of the filter or bypass condensers short circuited until constant temperature is reached or burnout occurs. Either this test or else the condenser test in the preceding paragraph may be selected but both need not be applied. During these overload tests there shall be no charring of a combustible case and with a non-combustible case cheesecloth placed in contact with the outside shall not become ignited. There must be no emission of flame or molten metal in these tests.

Secondary terminals shall be properly identified unless the connections cannot be incorrectly made. Markings must show the maker's name and the rating of the primary supply in volts, frequency and amperes or watts.

S

S.—A symbol for surface or area.

SATURATION.—As the number of ampere-turns acting upon a piece of iron is increased, the number of magnetic lines of force in the iron increases very rapidly up to a certain point which is the saturation point of the iron. With still further increase of ampere-turns there will be a further increase of lines of force but this increase of lines will be at a comparatively slow rate and the additional energy to produce the extra ampere-turns is partially wasted.

In a typical piece of transformer iron the first ten ampere-turns produced about 12,000 lines per square centimeter, the next ten ampere-turns wound within the original space of winding produced only about 2300 additional lines, while the third ten ampere-turns added produced an increase of but 1100 lines.

Saturation in the cores of audio frequency transformers produces distortion because the comparatively large currents cannot produce a proportional change in magnetism and a proportional effect on the secondary windings when compared with smaller currents.

SAW, HACK.—See *Tools*.

SCANNING METHODS.—See *Television*.

S. C. C.—An abbreviation for single cotton covered. See *Wire, Cotton Covered*.

S. C. E.—An abbreviation for single cotton enameled wire. See *Wire, Cotton Covered*.

SCREEN GRID OR SCREENED PLATE TUBE.—See *Tube, Screen Grid Type*.

SCREW CONDENSER.—See *Condenser, Variable*.

SCREW DRIVER.—See *Tools*.

SCREWS AND BOLTS, TYPES OF.—Various types of screws and bolts are used in the construction of radio receivers. The most common forms are shown in the illustration. The machine screws shown at the top of the drawing are used for fastening all kinds of small parts. These screws are specified according to the kind of material; iron, brass or nickel; the type of head; the length and the number of threads per inch. The types of heads are shown. The length of the screw is given in inches or fractions of an inch, the measurement for round heads being made from under the head to the extreme end and for flat heads from the top of the head over the entire length of the screw.

In using these screws it is necessary to drill holes which are then threaded, or to drill holes through which the screws pass freely. Tap and clearance sizes are given under *Drilling*.

The diameter of the screw is specified according to a series of numbers starting with number 2 for the smallest size and ending with number 30 for the largest. Sizes 2, 4, 6, 8 and 10 are generally used in receiver construction. The following table shows the diameter of the body of the screw, the number of threads per inch, and the lengths available.

SEASON OF YEAR, EFFECT ON RECEPTION

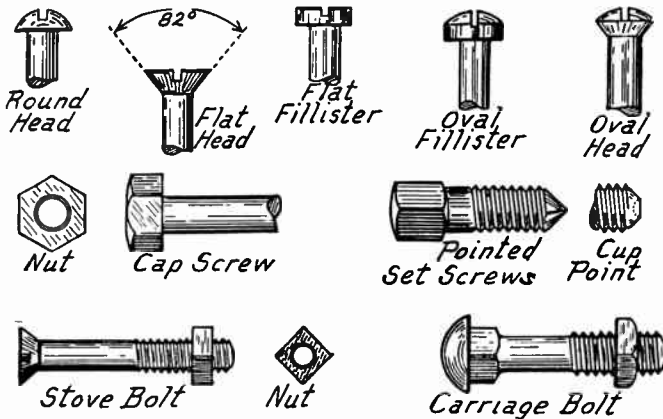

Screws and Bolts Used in Construction Work.

MACHINE SCREW SPECIFICATIONS

Number	Diameter in Inches	Threads per Inch	Lengths in Inches
2	0.0842	48-56-64	1/8 to 7/8
3	.0973	48-56	1/8 to 7/8
4	.1105	32-36-40	1/8 to 2
5	.1236	32-36-40	1/8 to 2-1/4
6	.1368	30-32-36	1/8 to 2-1/4
7	.1500	30-32	1/8 to 3
8	.1631	30-32-36	1/8 to 3
9	.1763	24-30-32	3/16 to 3-1/2
10	.1894	24-30-32	3/16 to 3-1/2
12	.2158	20-24	1/4 to 3-1/2

Numbers 6 and 8, both with 32 threads per inch, are most commonly employed.

See also *Construction, Receiver and Drilling.*

SEASON OF YEAR, EFFECT ON RECEPTION.—See *Range, Receiver.*

SELECTIVITY.—Selectivity is the ability of a receiver to respond to the signals from one transmitting station without being affected by or responding to the signals from other stations of nearly the same frequency as the one being received.

Selectivity depends on the design of the receiver, on its antenna and ground, on the quality of the materials used and on the excellence of workmanship. Broadcasting stations are operated with separations of ten kilocycles throughout the broadcasting band of frequencies. The lowest frequency is 550 kilocycles and the highest is 1500 kilocycles. This provides ninety-six broadcasting channels, each occupying a wave band of ten kilocycles. A receiver having

SELECTIVITY

good selectivity should be able to respond satisfactorily to a station at one frequency while completely excluding stations ten kilocycles away on either side provided these stations are a reasonable distance, say fifty miles or more, from the receiver.

Because of the large number of broadcasting stations in operation, selectivity is one of the prime essentials in a good receiver. The degree of selectivity needed depends on the nearness of broadcasters to the receiver and on the separation between the frequencies of the nearby or local broadcasters. A receiver operated one hundred miles from the nearest station needs but moderate selectivity to be satisfactory. But let that moderately selective receiver be brought into a locality crowded with broadcasting stations, such as found in the large cities, and it will prove a more or less complete failure as far as providing entertainment is concerned because there is little pleasure to be had in listening to two or more stations at the same time from the same loud speaker.

A receiver may be said to have sufficient selectivity for almost all purposes when it will receive a distant station operating on a frequency thirty kilocycles from the frequency of a local station which is a mile or more from the receiver. Many receivers will receive a distant station within twenty kilocycles of a local station also in operation, but this is really exceptional performance. If a set will not receive a distant station closer than fifty or sixty kilocycles to an operating local station, it cannot be said to have reasonable selectivity.

The selectivity of a receiver cannot be judged unless the two stations to be separated are both in actual operation. A local station may be tuned in and a note made of the control or dial settings. The dials may then be moved to the settings for another station, possibly a distant one, which is twenty or thirty kilocycles from the local broadcaster. If this distant station is not operating when the test is made, in all probability the local station will still be heard at the different setting. Yet if the different station were in operation, it might be tuned in to the almost complete exclusion of the local station.

In discussing the question of selectivity it is assumed that the operator of the receiver is sufficiently skilled and experienced to get the best possible performance. If the receiver has several tuning dials, all of them must be turned to the exact point of resonance with the frequency to be received. If one dial is properly tuned and others are slightly detuned, the receiver cannot show its real selectivity and only the operator is to be blamed. It will often be found that a local station is heard on both sides of the settings for a distant station, yet when the distant station is once being received with its settings properly made the local station will no longer be heard. See also *Tuning*.

Shock Excitation.—There is a condition under which a receiver having all the inherent selectivity that might reasonably be desired will fail to exclude a nearby local broadcaster. When a receiver is tuned or adjusted to receive signals at a certain frequency or wavelength, it will receive and amplify broadcast or other signals at this frequency better than at any other frequency. But when all the circuits are tuned to resonance at any frequency, they will oscillate at this frequency when any sufficiently powerful signal strikes the antenna. This powerful signal may be at the frequency to which the circuits are tuned, but it may just as well be at any other frequency. If it is strong enough, then the tuned circuits will be set into oscillation at their resonant frequency.

SELECTIVITY

Everyone who has tuned a receiver located close to a powerful broadcasting station has found that the instant the set is allowed to oscillate at any frequency or wavelength the nearby station will be heard regardless of its frequency.

A tuning fork having a certain pitch will vibrate when this pitch is sounded by a piano or other musical instrument near the tuning fork. Any other piano note may be sounded without causing the tuning fork to respond but if the fork is struck a direct blow with a hammer it will vibrate at its pitch or frequency even though the blow itself had no frequency or pitch.

When a radio circuit is tuned to a certain frequency it is like the tuning fork. It will respond to a radio signal of the same frequency but should any impulse of sufficient strength reach this tuned circuit it will respond at the frequency to which it is tuned regardless of the frequency of the powerful impulse which causes the action. Such a response of a radio frequency circuit is called shock excitation or impact excitation. This explains why the sharpest possible tuning and the most selective possible circuits have no effect whatever in excluding static or other atmospheric interference.

Selectivity in a receiver will not exclude the sounds caused by interference from power lines, from electric machinery, or from disturbances arising in the faulty operation of neighborhood electrical devices. The problem of getting rid of these troubles is treated under *Interference*.

The effect of shock excitation from nearby broadcasters whose signals tend to blanket all other reception may be greatly reduced by the use of proper shielding (see *Shielding*) or by tuning the antenna circuit. See *Antenna, Tuned*.

Causes for Lack of Selectivity.—There are three main classifications of the causes for lack of selectivity in a receiver. First comes the class containing all the faults that produce excessive resistance in the circuits. Reducing this resistance to the lowest possible value will not only greatly increase the selectivity but at the same time will multiply the sensitivity or distance-getting ability and the volume of the receiver. This makes an all around improvement in receiver performance.

The second class of faults includes mistakes in coupling between the various circuits. As a general rule, loosening the coupling between any two of the radio frequency circuits will increase the selectivity. At the same time, too loose a coupling will reduce the sensitivity of the receiver.

The third class includes the faults of poor proportion between inductance and capacity in the tuned circuits and in the antenna circuit. Many non-selective receivers are found to have too little inductance in their circuits. Increasing the ratio of inductance to capacity will improve the selectivity and the sensitivity at one and the same time.

It is often said that the qualities of selectivity and of power or sensitivity are opposed to each other in receiver design. To a limited extent this may be true. If there need be no regard whatever for selectivity, it is possible to build a comparatively simple receiver with great distance-getting ability. But it will also be found that a well designed and well built receiver which is selective will also have ample power or sensitivity for all demands.

SELECTIVITY

Resistance and Losses.—Any point of high resistance or any point at which there is excessive loss of radio frequency energy introduces excessive “damping” into the circuit containing the fault. This damping does two things. It acts as a resistance to flow of current, reducing the power, the sensitivity, and the volume from that circuit and at the same time broadens the resonance peak so that the circuit admits many frequencies each side of the one to which it is tuned. These effects of damping increase with increase of frequency. Therefore, the performance of the receiver will be especially poor at the high frequencies or low wavelengths.

There are literally dozens of places in which to look for radio frequency resistance and losses. Any one of these, or many of them together, may be causing the lack of selectivity. Among the most common errors in receiver layout and wiring are lack of sufficient spacing between coils, condensers and other parts. Trouble also arises from long grid and plate wires running close together and parallel to other wires. In home made receivers poor connections and loose joints are always to be suspected. Loose and corroded terminals and attachments of wires to terminals are very common when the receiver has been in use for some time. Soldered joints may appear good yet really be making almost no electrical contact at all. Even such items as dirty contacts in tube sockets should be looked for.

Losses that occur in the tuning coils are often responsible for lack of selectivity. Anything that is treated under the heading *Coil, Losses in*, may be doing harm and these things should be looked after. The same advice applies to the tuning condensers; any of the things treated under the heading *Condenser, Losses in*, may be broadening the tuning and if possible they should be remedied. Among the most frequent troubles are poor connections between condenser rotors and their terminals.

Under the heading of *Oscillation* are described methods of preventing free oscillation by introducing resistances or losses into the tuned circuits. Every one of these schemes for preventing uncontrollable squealing and whistling will go a long way in destroying selectivity. True selectivity is almost a synonym for efficiency in radio receivers.

Having gone over the receiver itself with the aim of discovering high resistances and losses it is in order to examine the antenna circuit. The antenna may have joints that are not properly soldered but are simply twisted together or the antenna may be supported by broken or leaky insulators or even found to have no insulators at all. Antennas are still found supported with nails and rope. The antenna may run so close to guy wires, power wires, trees or building walls that its collected energy is largely wasted.

Every joint in the lead-in and in the ground connection should be examined for looseness and corrosion, not forgetting the ground clamp or other attachment of the ground wire to whatever ground is used. The ground may be a poor one, this being certain to destroy selectivity. Grounds should not be made to piping that leads through water or gas meters and it is best to avoid grounds to hot water or gas pipes altogether. See *Ground, Receiver*. Many installations are found in which the lead-in and the ground wire run close together for long distances, this serving to bypass much of the energy from the antenna to ground.

Incorrect Coupling.—There is a certain best coupling between the primary and secondary windings of radio frequency trans-

SELECTIVITY

formers. Too close a coupling will actually reduce the power of the receiver and will broaden the tuning to an almost unbelievable extent by producing two different frequencies at which the circuit is resonant. As the coupling is loosened the power will increase and so will the selectivity. At a certain coupling the power will be maximum and the selectivity good. A still looser coupling will increase the selectivity but will reduce the power. See *Coupling, Optimum*.

Loosening the antenna coupling is one of the easiest and most effective ways to increase selectivity. Here again will be found a certain optimum coupling for power. Loosening the coupling beyond this point will reduce the power and still further increase the selectivity. See *Antenna, Coupling of*. Should it be difficult to increase the spacing between the antenna coil and the circuit to which it is coupled, the same effect may be obtained by inserting a fixed condenser of from .0005 to .0001 microfarad capacity between the antenna lead-in and the antenna terminal on the receiver. This will increase selectivity at the sacrifice of power.

Inductance and Capacity Ratio.—Tuned circuits containing coils of comparatively large inductance and condensers of small capacity will prove more selective than small inductances and large capacities. This is because greater voltages are secured across the large inductances and it is possible to use looser couplings while still obtaining the same response to a signal of given strength.

A long and high antenna is naturally opposed to selectivity. Such an antenna has greater resistance than a shorter and lower one and the antenna of great capacity tunes itself much more easily to any powerful signal regardless of the receiver tuning. There is a best size of antenna for any given receiver. Antennas longer than this will greatly reduce selectivity without adding much to the distance range. Shorter antennas will improve the selectivity but will also reduce the sensitivity to distant signals. It is better to use a short and low antenna together with the coupling giving greatest power in the receiver rather than to use a very long antenna and try to obtain selectivity by using extremely loose couplings in the receiver circuits. An indoor antenna is more selective than any outdoor antenna of ordinary size and a loop is many times more selective than either an indoor or outdoor antenna.

The greatest single aid to selectivity is regeneration. Regeneration tremendously magnifies signals of the frequency to which the receiver is tuned, yet adds nothing at all to the strength of other frequencies. A receiver operated in a non-regenerative condition may receive two or three stations at one time, yet will be highly selective when regeneration is added.

RULES FOR SELECTIVITY

The following series of rules may be followed to obtain maximum selectivity in any receiver:

- Allow ample spacing between tuning coils and all other parts.
- Avoid long plate and grid wires.
- Keep grid and plate wires well separated from other parts.
- Keep terminal connections clean and tight.
- Examine and test all soldered joints for looseness and poor contact.

SELECTOR CIRCUIT

Clean all tube contacts.

Avoid all constructions and materials causing losses in coils.

Avoid all constructions and materials causing losses in condensers.

Do not control oscillation or regeneration with methods that introduce losses into the tuned circuits.

Make all antenna connections through soldered joints.

Use perfect and unbroken insulators at both ends of antenna.

Allow good separation between antenna and all other objects.

Solder all joints in lead-in and in ground wire.

Make solid connection of good conductivity to ground.

Use a good ground, preferably a cold water pipe or a deeply buried metal plate surrounded with permanently moist earth.

Use the optimum coupling in radio frequency transformers or use a coupling still looser than this.

Use loose coupling between the antenna and the receiver circuit.

Make tuning circuits with large inductances and small capacities.

Use a short, comparatively low antenna, use an indoor antenna, or use a loop.

Use regeneration properly controlled.

See also *Trouble, Receiver, Location and Remedy of*.

SELECTOR CIRCUIT.—See *Circuit, Band Selector*.

SELECTOR, WAVE.—See *Trap, Wave*.

SELENIUM.—Selenium is an element somewhat similar to sulphur. Selenium has a rather high electrical resistance as long as it is kept in darkness, but when exposed to light of any kind its resistance is reduced to between one-tenth and one two-hundredth of the value in the dark. This makes selenium suitable for use in some forms of photo-electric cells.

SELF-INDUCTANCE.—See *Inductance, Self*.

SELF-OSCILLATION.—See *Oscillation*.

SELF-SHIELDED COIL.—See *Coil, Closed Field Type*.

SENSITIVITY.—Sensitivity is a measure of the ability of a receiver to receive, detect and amplify radio signals.

In a sensitive receiver everything possible has been done to amplify or magnify the received signals without distortion, but more especially everything has been done to conserve every bit of energy all the way through the receiver from the antenna to the loud speaker.

The first aid to sensitivity is a good antenna in a good location. This means the entire antenna circuit, ground and all. A large antenna is more sensitive than a small one but the receiver must be adapted for use with a large antenna. A good ground is absolutely essential if real sensitivity is to be attained.

In the receiver it is possible to increase the distance-getting ability or the sensitivity by using large tuning inductances and by using the coupling between radio frequency circuits that will result in the greatest possible transfer of power from one to another. This is not the closest possible coupling, nor is it the loosest coupling, but is somewhere between. See *Coupling, Optimum*.

The more stages of radio frequency amplification the receiver contains the greater will be its sensitivity provided that these stages

SENSITIVITY

really amplify. Many radio frequency amplifier stages are so poorly designed and constructed that two, or even three of them are barely equal to one good radio stage.

Tubes which are specially adapted to the work they are called upon to do are among the greatest aids to sensitivity. Some tubes make especially good radio frequency amplifiers, giving a good voltage gain from stage to stage. Other tubes are built only for the work of detection and they do this exceedingly well. Some of the newer detector tubes will make it possible to listen to stations on a loud speaker which are audible only in headphones with other detectors.

Power tubes in the last audio frequency stage have the effect of increasing sensitivity because they allow really satisfactory reception of weak and distant stations without forcing the amplification in preceding stages to the point of distortion.

If a receiver is to be made sensitive to weak signals, every point of design, every item of workmanship and every choice between materials must be watched. Every possible loss of energy must be eliminated from tuning coils and condensers. All wiring must be placed with proper regard to the capacity and inductive effects between it and other parts of the receiver. The position of every part, and especially the inductance coils, must be studied so that there will be no excessive energy loss because of undesired couplings. See *Construction, Receiver*.

The final point in obtaining sensitivity is in the receiver's operation. Very few receivers are operated to obtain the maximum possible distance and power. It is only when an operator has learned all the tricks and peculiarities of his receiver that he is able to reach out to the farthest broadcasting station and bring it through with loud speaker volume.

There is a limit to the useful sensitivity of a receiver. There are certain electrical disturbances always in the air. These may be very slight at times, but they are always present to some extent at least. No matter how weak these disturbances or interferences they are more powerful than the signals from broadcasting stations at extreme distances from the receiver. A receiver may be made so sensitive that it will amplify the weakest atmospheric disturbances to loud speaker volume. Any signals from distant stations that are weaker than these disturbances cannot possibly be heard above the interference. Then the useful sensitivity of the receiver has been reached because it has gone down to the "static level."

Distance reception is often made impossible by one bad joint somewhere in the antenna circuit or inside the receiver. The same result will come from a short circuited or wet lightning arrester.

It is often possible to greatly increase the volume on very distant and weak signals by using a high resistance grid leak on the detector circuit. This leak may be from five to ten megohms with good results. Sometimes removing the leak entirely will result in an increase of sensitivity.

It should be mentioned that the ability of a receiver to bring in local and nearby stations without either the antenna or ground connected to their proper terminals does not prove any excellence of the receiver. It only proves that the wiring, the coils, and most of the other connections in the receiver are acting as antennas. This proves that the receiver will be far from selective when in normal operation.

See also *Range, Receiver*.

SERIES CAPACITIES

SERIES CAPACITIES.—See *Condenser, Capacity of.*

SERIES CIRCUIT.—See *Circuit, Series.*

SERIES CONDENSER.—See *Condenser, Antenna.*

SERIES INDUCTANCES.—See *Inductance, Self.*

SERIES-PARALLEL SWITCH.—See *Switch, Series-Parallel.*

SERIES RESISTANCE.—See *Resistance, Series Circuit.*

SERIES RESONANCE.—See *Resonance, Series.*

SET, RADIO.—See *Receiver.*

SETTINGS, RECEIVER.—See *Calibration, of Receiver.*

SHARP TUNING.—See *Tuning*; also *Selectivity.*

SHELL TYPE TRANSFORMER.—See *Transformer.*

SHELLAC.—See *Binders.*

SHIELD GRID OR SHIELDED PLATE TUBE.—See *Tube, Screen Grid Type.*

SHIELDING.—The practice of surrounding parts producing or carrying electrostatic or electromagnetic fields is called shielding. The purpose is to prevent radiation and coupling. Since every conductor carrying alternating current has an electromagnetic field around it, and since every conductor having an electric charge has an electrostatic field around it, these fields will produce electric currents or charges on any other conductors in the neighborhood.

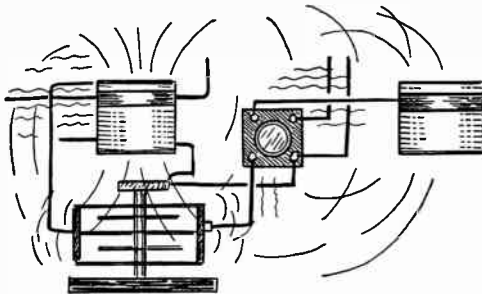

FIG. 1.—Some of the Stray Fields to be Shielded in Radio Frequency Circuits.

The higher the frequency of the alternating currents the more widespread will be the fields surrounding their conductors. In the radio frequency part of a receiver every coil, every condenser and almost every wire will be surrounded by an extensive field because they all carry high frequency currents. The field of every single part is doing its best to produce extra currents in every other part of the receiver. In dozens of places the extra currents are harmful; they may reinforce other currents and produce oscillation or they may oppose other currents and cause decided losses of signal strength. This free-for-all struggle between the fields as barely suggested by Fig. 1 is something to be avoided if possible.

SHIELDING

The lines of force of which both electromagnetic and electrostatic fields are composed will pass through insulators practically as if the insulators were not in existence. In fact, the better the dielectric properties of the insulating material the less success it will have in hindering the passage of field lines of force.

Direct current itself may be confined within conductors by covering these conductors with insulation or by leaving them exposed in air, which is one of the best insulators. But high frequency electric fields behave in a manner the exact opposite of the behavior of the direct current.

An electric field, such as exists around a coil, a condenser, or any conductor carrying high frequency alternating currents, travels freely and almost without hindrance through air or any other good dielectric. The electric field, which moves to great distances through dielectrics, may sooner or later meet a barrier in the form of a material that is a good electrical conductor. The lines of force forming the field enter the conductor but all of them do not pass through it because their energy is used to produce electric currents in the conductor as in Fig. 2. These are eddy currents and they simply dissipate or destroy the energy of the field so that practically no lines go on through the conductor.

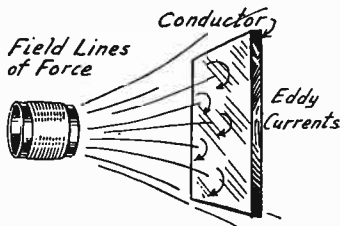

FIG. 2.—Dissipation of Energy in a Conductor Such as a Shield.

Thus it is seen that the effects of electric currents travel freely in conductors and are confined by insulators, while the effects of electric fields travel freely in insulators but are confined by conductors. Conductors used to confine electromagnetic and electrostatic fields are called shields and their proper application in radio receivers is called shielding.

Were it possible to separate the various parts carrying high frequency currents by great distances from one another their respective fields would not come together and would not need to be confined. The lines of force forming any such field become fewer and fewer as the distance from their source increases. Therefore, were the separation between sources great enough the fields would not join.

The field of a good active coil will spread to a distance of a foot or two from the coil before losing the strength required to generate undesired currents in other coils or conductors. The field around a wire carrying a good healthy plate current will be full of activity at a distance of several inches. So when a receiver having a total length of thirty inches contains three or more radio frequency coils, three or more tuning condensers, a collection of iron-core transformers together with miscellaneous tubes and wires the condition of Fig. 1 is multiplied.

Applications of Shielding.—Properly applied shielding accomplishes two objects. It prevents harmful feedback of energy from the parts in one amplifying stage to parts in the preceding amplify-

SHIELDING

ing stage. This reduces the receiver's tendency toward oscillation, makes it more stable. The shielding also prevents pickup of energy radiated from parts of amplifying stages or radiated from the antenna system. This increases the receiver's selectivity because it forces the signals from the antenna to proceed through the successive stages of amplification in an orderly manner and it prevents stray energy from powerful and nearby broadcasting stations from being picked up by the coils and wiring in the receiver. It gives the tuned stages of radio amplification a chance to get in their full filtering effect.



FIG. 3.—Shielding Applied to a Wire.

The action of any kind of a shield is to catch the wandering lines of force, turn their energy into eddy currents in the shield and thus prevent the lines from passing on through the shield. The shield itself is usually grounded so that whatever forces appear in its body will be neutralized or destroyed by carrying them to ground.

Shielding may be applied to individual wires as in Fig. 3. The conductor is first covered with insulation to confine the electric currents. Then the insulation is surrounded with a sleeve or a tube of the shielding metal, generally copper. This confines the lines of force that would otherwise radiate from the conductor.

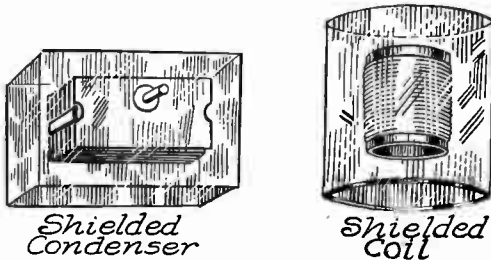

FIG. 4.—Tuning Condenser and Coil Enclosed in Shields.

Shielding may be applied to coils by placing the coil within a completely closed box or can. The field of the coil will travel out as far as the metal of the shield, but there it will be stopped. Neither can other fields get in to influence the coil. Tuning condensers are similarly enclosed in copper or aluminum boxes which form shields and prevent the exit of the condenser's own electrostatic field and prevent the entrance of other fields. This is shown in Fig. 4.

Shielding as in Fig. 5 may be applied to each complete stage of radio frequency amplification in a receiver. A metal box or shield completely encloses the radio frequency transformer, its tuning condenser and the tube to whose grid the transformer and condenser are connected. This leaves only the output plate wire from the tube to pass out through the shield to the following stage.

SHIELDING

In a superheterodyne or similar receiver the oscillator may be enclosed in one shield, the first detector stage in another shield, the intermediate amplifiers in a third shield, and the second detector in a fourth.

Finally the complete receiver may be shielded. The top, the bottom, and all four sides of the receiver cabinet are completely lined with thin metal which acts as a shield for the receiver against all outside influences and interference.

Effect of Shielding.—Unquestionably there are many advantages to be gained by shielding. But these gains cannot be had without some penalties in the form of lost energy. For shielding to be effective the energy of the lines of force which are to be confined must be changed into eddy current losses. That much energy is thrown away. The shielding metal must be a good conductor so that eddy currents may be formed easily. If no eddy currents are formed, there will be no shielding effect. Were the resistance of the shield high enough to lessen the formation of eddy currents, the shield would have to be a partial insulator and it would act like a dielectric in passing some of the lines of force right on through.

If shielding is used it is going to cause a loss of power and to make up for this loss more power must be added. With only two

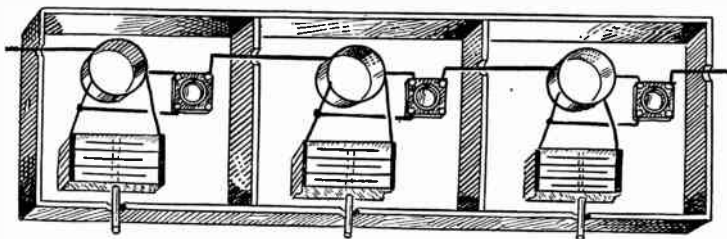

FIG. 5.—Amplifying Stages Enclosed in Individual Shields.

stages of radio frequency amplification the loss may be great enough to more than overcome the savings from prevention of intercoupling, and the net result will be a reduction of the receiver's power. But with three or more stages of radio frequency amplification there is a net gain with shielding when it is properly applied. Three radio stages without shielding must have such low amplification per stage in the prevention of oscillation that they are little better than two stages. With shielding applied, the amplification per stage may be greatly increased without danger of uncontrollable oscillation. There is no real advantage in shielding with only one radio frequency stage except when working at very high frequencies.

The effect of enclosing a tuning condenser in an individual shield whose sides come rather closely around the condenser plates is to greatly increase the apparent or effective resistance of the condenser. The larger the capacity of the condenser the less serious will be the effect of close shielding. Condensers of .0005 microfarad capacity and larger may show an increase of as much as twenty-five per cent in resistance. Smaller condensers show increasing losses. A

SHIELDING

tuning unit of .00025 microfarad capacity may show from thirty to forty per cent increase of loss when shielded. This is not as serious as it sounds because the loss caused by a good condenser in its circuit is seldom more than three or four per cent of the total circuit loss and increasing this small original loss even by as much as one-third would not greatly raise the total circuit resistance.

The effect of a shield around a coil is to increase the effective resistance of the coil and to reduce the coil's apparent inductance. In other words, a larger coil must be used in order to tune to a given frequency. If the shield is insulated from all circuits to which the coil is connected as at the left in Fig. 6, the resistance increase is much less than when the shield connects to one of the coil circuits, such as the A-battery negative circuit or negative filament circuit of the tube in the stage being shielded.

When a coil is enclosed in an individual shield for the coil alone it is necessary to keep the shield well separated from the coil if the loss is to be kept within reasonable limits. A large part of the total loss from coil shielding is due to the capacity effect between the body of the coil and the metal of the shield. The greater the space between the two, the less will be the capacity

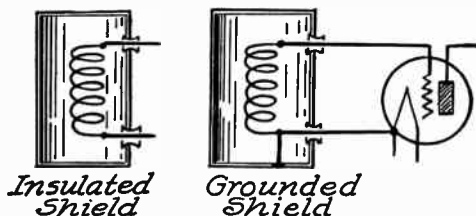

FIG. 6.—Insulated and Grounded Shields.

and the less the loss. Of course, the principal loss is due to eddy currents formed in the shielding metal by the field of the coil. This effect too is lessened by increasing the distance between coil and shield.

If the shield is brought within three-eighths of an inch of even a very small and compact coil, the loss will be very high. Conditions improve quite rapidly as the shield is moved away until the separation reaches an inch. To obtain only reasonable losses the separation between a compact form of coil and its shield must be at least one and one-half inches and two inches will be a still safer minimum separation. Separations greater than two inches offer little additional saving of resistance and, because of the great space required, are hardly worth while.

As may be judged from the foregoing paragraphs the form of the coil has much to do with the success of the shielding and in determining whether there is to be an overall gain or loss.

For a given inductance the multi-layer honeycomb type of coil has the advantage because it is of the smallest possible size and has the smallest field of any form of coil with open ends. It is only surpassed in this respect (extent of field) by the coil forms having closed or partially closed fields. A single layer solenoid coil having the same inductance as a honeycomb generally shows three to four times the loss of the honeycomb when shielded. This may be completely offset because the losses in a single layer solenoid without shielding are much lower than the losses in a honeycomb without shielding. A flat spiderweb coil shows greater losses by about fifty per cent than the single layer solenoid of equal inductance. All things considered, single layer solenoids

SHIELDING

wound on forms having a diameter greater than their length and wound with small sizes of wire, number 26 and smaller, are best suited for shielding. However, a well designed honeycomb is almost as good from the standpoint of overall efficiency.

Partial Shielding.—Shielding by placing sheets of metal between parts is generally ineffective. As a rule it is better to shield completely by fully enclosing the parts than to attempt the use of partial shields.

As indicated in Fig. 7 a partition form of shield allows passage of the lines of force around it. The smaller the shield and the farther it is from the part to be shielded the greater will be the escape of the lines and the less effective the shielding.

If a receiver is built with coils at angles such that there is minimum coupling between them when no shielding is used, it will often be found that the introduction of a shielding partition between two coils will actually cause them to couple where no coupling to speak of exists without the shield. The shield will so displace the field of one or both coils that the new paths of the lines of force will cut through the other coil of a pair.

Materials for Shielding.—Copper, aluminum and brass are the metals best suited for use as shields. Their relative values are in

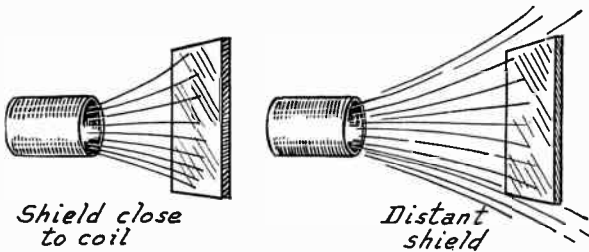

FIG. 7.—Effect of Distance Between Partial Shield and a Coil.

the order named, copper being best. A shield must be of good conducting material so that eddy currents may be formed within its mass. Lead foil and tin foil have resistances too high to allow them to be used in satisfactory and effective shields. Here again it must be remembered that the idea of shielding is to produce a loss, not to prevent one.

Iron or steel must never be used for shielding high frequency currents or circuits. Iron and steel have relatively high resistance when compared with copper and therefore do not so readily absorb the energy from field lines of force. Furthermore, iron and steel introduce magnetic effects and then have fields of their own which may make matters worse than ever.

The lower the frequency the less effective a shield of given size and thickness will become. If audio frequencies were to be shielded the shields would need be much thicker than those effective at radio frequencies. But the radiation of lines of force is less at these low frequencies so that the problem is not made any more difficult in reality. A thin shield is effective at high frequencies because these frequencies, short wavelengths, do not go through any shields as readily as lower frequencies or higher wavelengths. The same thin

SHIELDING

shield is also effective at low frequencies because the radiation is less than the radiation at the higher frequencies. Any thickness of metal from number 6 down to number 30 may be used satisfactorily for shielding. The following table gives the thicknesses and weights of commonly used sizes:

THICKNESS AND WEIGHT OF METAL FOR SHIELDING

Gauge Number	Thickness in Inches	Weight in Pounds per Sq. Ft.		
		<i>Copper</i>	<i>Brass</i>	<i>Aluminum</i>
10	0.102	4.72	4.51	1.43
11	.091	4.20	4.02	1.27
12	.081	3.74	3.58	1.10
13	.072	3.33	3.19	1.01
14	.064	2.97	2.84	.90
15	.057	2.64	2.53	.80
16	.051	2.35	2.25	.71
17	.045	2.10	2.00	.64
18	.040	1.87	1.79	.57
19	.036	1.66	1.59	.50
20	.032	1.48	1.42	.45
21	.028	1.32	1.26	.40
22	.025	1.17	1.12	.35
23	.023	1.05	1.00	.32
24	.020	.93	.89	.28
25	.018	.83	.79	.25
26	.016	.74	.71	.22
27	.014	.66	.63	.20
28	.013	.59	.56	.18
29	.011	.52	.50	.16
30	.010	.46	.44	.14

Construction of Shielding.—It is impossible to build a perfect shield because all metals used for this work have some resistance and therefore cannot absorb all of the radiated lines of force. The fewer openings and the smaller the openings through the shield the more effective it will be. Joints in the shield should be crimped or soldered for their entire length.

Where a cabinet is completely shielded there will be an opening formed at any hinged cover. If this joint is staggered as shown in Fig. 8, or as a refrigerator door is staggered, the shielding at the joint will be practically perfect. Wires passing through a shield should be run through the smallest possible opening which will allow for insulation. To prevent the passage of any lines of force into a shield the wires may enter and leave through bent copper tubes as in Fig. 8.

SHOCK EXCITATION

While these precautions may seem rather elaborate their necessity may be realized from the results of a simple experiment. A radio frequency receiver may be completely shielded and a signal from a nearby powerful station tuned in. Disconnecting antenna and ground will cause the signal to disappear. Opening a crack a sixteenth of an inch wide in the shield will allow the signal to be brought back again without either antenna or ground when the receiver is slightly re-tuned.

The extent of capacity effects between the shield and all coils, condensers, tubes and wiring within the shield is increased the closer any or all of these parts come to any point on the shield. So far as space limitations will allow the shield should be kept at least two inches from all of the shielded parts.

The capacity effect depends also on the difference in voltage of the shield and the parts it encloses. It is customary to ground the shield to the negative side of the tube filament circuit, to the negative A-battery line when a battery is used or to whatever line connects through to the receiver ground. This method causes the greatest voltage difference to exist between the shield and the enclosed parts because the shield is then at zero voltage.

The best results in the prevention of feedbacks will be secured if shields enclosing separate stages of a radio frequency amplifier are allowed to remain insulated from all circuits in the receiver. That

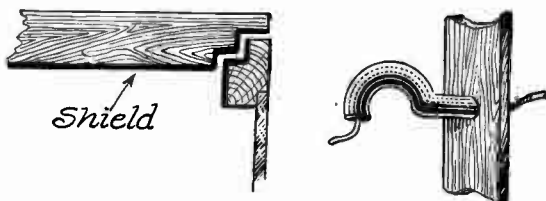

FIG. 8.—Protection of Joints in Shielding.

is, interstage shielding may remain insulated. On the other hand, the best protection against pickup of outside interferences will be had by using a grounded shield. If the receiver is fitted with both interstage shielding and with complete cabinet shielding, the interstage shields may remain insulated and the cabinet shield may be grounded. This will provide almost perfect protection from feedbacks and from energy pickup.

The effect of a rather close shield around a coil will be to more than double the effective resistance of the coil if the shield is not grounded. That is, the resistance will be somewhat more than twice the resistance of the coil unshielded. If the shield be grounded the effective resistance is still further increased and is one-fourth to one-third greater than with the shield ungrounded. This is because of the added capacity effect.

When the shielding is connected to the negative filament line it is customary and advisable to connect all negative filament leads to the shield. In this way much of the negative filament circuit wiring is done away with, the shield taking its place.

SHOCK EXCITATION.—See *Selectivity*.

SHORT CIRCUIT.—See *Circuit, Short*.

SHORT WAVE RECEIVER.—See *Receiver, Short Wave*.

SHUNT

SHUNT.—One of the current paths or one of the branches in a parallel circuit is called a shunt. See *Circuit, Parallel*.

SHUNT FEED AMPLIFIER.—See *Amplifier, Audio Frequency, Transformer Coupled*.

SHUNTING CONDENSER.—See *Condenser, Antenna*.

SIDE BAND.—One-half of a wave band. In broadcasting with wave bands each ten kilocycles wide, the side bands are each five kilocycles wide. See *Band, Wave*.

SIGNAL.—Properly speaking the various messages sent out from a radio telegraph station by using the code are called signals. By common consent anything sent out from a radio station, whether radio-telephone or radio-telegraph, is called a signal. Thus any radio waves that are received from stations of any kind are generally called signals.

SILICON CRYSTAL.—See *Detector, Crystal*.

SILK.—See *Cloth, Insulating*.

SILK COVERED WIRE.—See *Wire, Silk Covered*.

SILVER.—Silver is the best conductor of all the metals. The resistance of silver is 9.56 ohms per mil foot. This is about 92.2 per cent of the resistance of copper; the resistance of copper is about 108.5 per cent that of silver. This advantage of lower resistance is hardly worth while in view of the much greater cost of silver. Like copper, silver oxidizes quite readily when exposed to the air. Coin silver has slightly more resistance than pure silver because coin silver contains only about ninety per cent pure silver, the remainder being copper.

SILVER, NICKEL.—Nickel silver is a resistance alloy containing copper, nickel and zinc; but no silver. The metal is made up of from fifty to sixty per cent copper, with from ten to thirty per cent of each of the other metals. The greater the nickel content the higher the resistance. The alloy is generally specified by mentioning the percentage of nickel in its composition. It may have anywhere from fifteen to thirty times the resistance of copper. This alloy is sometimes called German Silver. See *Resistance, Materials for*.

SINE WAVE.—See *Wave, Sine*.

SINGLE ANTENNA.—See *Antenna, Multiple Receiver Connections to*.

SINGLE CIRCUIT RECEIVER.—See *Receiver, Single Circuit*.

SINGLE CONTROL.—See *Control, Single*.

SINGLE LAYER COIL.—See *Coil, Single Layer Type*.

SKIN EFFECT.—When direct current flows through a wire it is evenly distributed throughout the body of the wire, that is, there is as much current flowing near the center of the wire as near the outside of the wire. With alternating current this is not true.

SKIN EFFECT

Alternating current of high frequency tends to flow principally on the surface of a wire and through the part of the wire nearest the surface. Alternating current tries to avoid flowing through the center of the wire.

The resistance of a wire to direct current is a definite quantity depending on the material, the length, the cross section or diameter, and the temperature of the wire. Resistance to alternating current depends on all of the things which affect direct current but the resistance to alternating current depends also on the frequency. The higher the frequency the greater the resistance because when the alternating current leaves the center of the wire and flows near the surface, the surface portions of the wire are carrying more than their share of the current.

This action of alternating frequency is called "Skin Effect." It increases with increase of frequency. Skin effect acts not only in wires but in all conductors, such as the plates of condensers. At rather high frequencies for a given weight of conductor we would get better conductivity from a tube with thin walls than from a

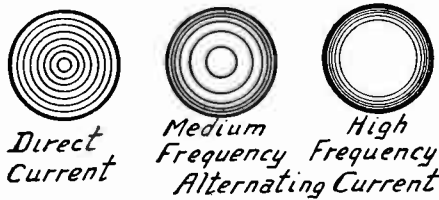

Skin Effect on Current Distribution in Wires.

solid wire because the center of the wire only adds to the weight and cost of the conductor without serving much of any purpose in carrying current. The added resistance due to skin effect is greater in large wires than in small ones because in the large wire less of its total bulk is represented by the skin or surface so the less we use of the whole bulk of the wire to carry current.

At a frequency of 1000 kilocycles (a wavelength of 300 meters) if we represent the skin effect as equal to 1 for number 28 wire, for number 26 it is equal to $1\frac{1}{2}$, for number 24 it is equal to 2.2, for number 22 it is equal to 2.7, for number 20 it is equal to 3.4, for number 18 it is equal to 4.2, and for number 14 it is equal to 6.4.

At higher frequencies the skin effect is even more pronounced while at lower frequencies it is less pronounced. For example, taking a number 20 wire at a frequency of 600 kilocycles (a wavelength of 500 meters) the skin effect may be represented by 2.7. At 800 kilocycles the skin effect would be represented by 3; at 1000 kilocycles by 3.4; at 1200 kilocycles by 3.7; and at 1400 kilocycles by 3.9. This shows that there are disadvantages in the use of too much conductor when handling high frequency currents.

The values which have just been used to represent the relative resistances are the ratios of the high frequency resistance of a wire to the direct current resistance of the same wire. When we say that the resistance is represented

SKIN EFFECT IN COILS

by 2.5 we mean that it is two and a half times as great as the resistance to direct current.

It should be remembered that the direct current resistance of a wire decreases as the wire size is increased so that the total resistance of the wire is affected both by skin effect and ohmic resistance. See *Resistance, High Frequency*.

When wire is formed into a coil the strength of the magnetic field inside the coil is greater than its strength outside the coil. This makes the distribution of current in the wire even less uniform than when the wire is straight and the result is that a given length of wire formed into a coil shows from two to two and one-half times as great a skin effect as the same wire when straight.

The resistance due to skin effect may be reduced by using a conductor composed of a large number of very small wires each thoroughly insulated from all the others and formed into a cable. This cable is known as Litzendraht wire. Each of the small wires is enamel covered. They are then woven in such a manner that each small wire comes to the surface of the cable and remains on the surface for exactly the same proportion of the whole length as every other small wire. There is little advantage in simply using a number of small wires laid parallel. See *Wire, Stranded*.

The great skin effect in a coil is due to the crowding of magnetic lines of force inside of the coil winding. The greatest part of the current flowing through the wire forming a coil winding is on the sides of the wire toward the inside of the coil. A non-inductive coil shows none of this effect. The losses due to skin effect form one of the best reasons for using small size wire in winding radio frequency coils.

SKIN EFFECT, IN COILS.—See *Coil, Losses in*.

SKIN EFFECT, CONDENSERS.—See *Condenser, Losses*.

SKIP DISTANCE.—See *Fading*.

SLIDE-BACK VOLTMETER.—See *Meter, Vacuum Tube*.

SLIDE CONTACT.—See *Coil, Slide Contacts on*.

SLIDE COUPLER.—See *Coupler, Slide*.

SLIDE WIRE BRIDGE.—See *Bridge, Measurements by*.

SOCKET ADAPTER.—See *Adapter, Socket*.

SOCKET ANTENNA.—See *Antenna, Light and Power Circuit for*.

SOCKET POWER.—See *Power Unit*.

SOCKET, TUBE.—The tube socket is a device which supports a vacuum tube from a base or panel and at the same time makes contact between the pins or prongs on the tube base and terminal screws or soldering lugs around the outside of the socket. The body is generally made entirely of moulded insulation, although the sleeve portion that encloses the tube base has sometimes been made of metal. The portion containing the contacts and terminals must be made of insulating material to prevent electrical leakage. The contact with the tube prongs is always made by means of springs which are bent slightly as the tube is put in place, thus insuring a firm contact and often providing a wiping action which

SOCKET, TUBE

automatically cleans the contact surfaces each time the tube is inserted in its socket.

The navy type socket is shown in Fig. 1. This socket has cylindrical walls which fit around the cylindrical base of the tube. There is a notch cut part way down the socket wall at one point and the lower end of this notch turns to one side. On one side of the tube base is a pin which slides down in the notch as the tube is placed in the socket. When the tube is almost all the way down in the socket its prongs strike the socket contact springs. The tube is then turned slightly to the right so that the pin engages in the bent-over part of the notch and holds the tube firmly in place.

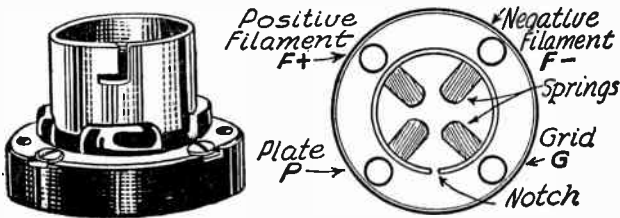

FIG. 1.—Navy Type of Tube Socket.

The apparatus of this standard socket, when looked at from on top, is shown at the right in Fig. 1. There are four springs and four terminals to match the four prongs on the base of the tube. This style of socket will hold all receiving tubes which operate from storage battery current and will also take the type of tube designed to operate on one dry cell, taking 1.1 volts and 0.25 ampere for its filament.

The grid terminal is always at the right of the notch when looking from the top at the notched side of the socket as in Fig. 1. The plate terminal is always at the left of the notch, looking from the same direction. The two filament terminals are on the other side of the socket, the positive filament terminal being on the same side with the plate and the negative filament terminal being on the same side as the grid terminal. Since the pin on the tube base will allow insertion of the tube in only one position, it is impossible to make wrong connections unless the wrong wires are attached to the socket terminals.

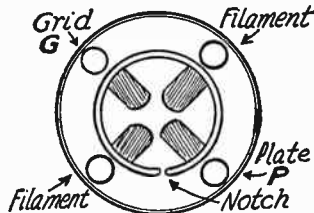

FIG. 2.—Socket for Three-Volt Dry Cell Tubes.

Fig. 2 shows the terminal arrangement of the socket used for the dry cell types of tubes taking 3.0 volts and 0.06 ampere for the filament. The general construction of this socket is similar in all respects to the large one of Fig. 1 but all of the dimensions of this small socket are proportionately smaller to fit the smaller base of the dry cell tube. In the smaller socket the plate terminal is at the right of the notch when facing the notch side of the socket. The grid terminal is on the opposite corner from the plate. The re-

SOCKET, TUBE

maining two terminals are for attachment of the filament wires. No difference is made between positive and negative filament connections to the tube since these small tubes use a single straight length of wire for a filament.

The terminal arrangement of the small socket of Fig. 2 is much better than the arrangement of Fig. 1 because in Fig. 2 the plate and grid leads in the socket and up through the tube base have the maximum possible separation from each other, thus reducing their capacity to each other. Both of the sockets so far described were designed for the older types of "V" tubes on which all four prongs coming out of the base bottom were of the same diameter.

Newer tubes of the "X" series have their two filament prongs much larger than the grid and plate prongs. While these newer tubes will fit into the older types of sockets, a new type of socket has been developed in which the prongs themselves give the entire support for the tube without the necessity of any cylindrical wall. This socket is shown in Fig. 3.

The tube is mounted in the socket by simply pushing the tube prongs down into the corresponding holes in the socket. The tube

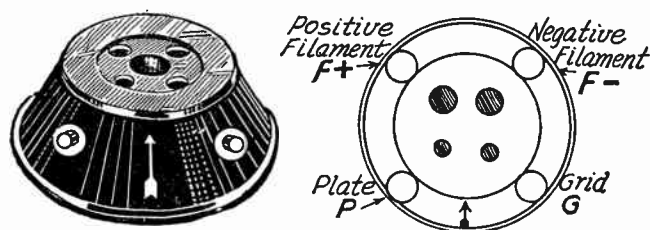

FIG. 3.—Socket for Tubes with Large and Small Prongs.

cannot be inserted in the wrong position because of the difference in size between the prongs on opposite sides. An arrow is generally placed on these sockets, its point indicating the position of the pin on the side of the tube base. This pin is retained in some of the new type tubes so that they may be mounted in the old type sockets of receivers built before the newer styles came into being. It may be seen from Fig. 3 that the terminal arrangement around the edge of the new socket is the same as with the older type of Fig. 1.

A power tube for use with dry cells, taking 3.0 volts and 0.125 ampere for its filament requires a socket different from any of the three types described. This tube, like others of the "X" series, has its two filament prongs of larger diameter than its grid and plate prongs. The terminal arrangement of the socket for this dry cell power tube is shown in Fig. 4. It will be seen that the polarity of the filament terminals has been reversed from the arrangement of Fig. 3. This tube has its prongs of the same size and same spacing as those of the larger storage battery "X" tubes.

Cushion Socket.—The air vibrations from a powerful loud speaker will jar the plate, grid and filament in the average tube to such an extent that the changing distance between the elements causes a variation of plate current. These variations keep time with

SOCKET, TUBE

the vibrations of the elements and cause the tube to give forth a loud howl through its output circuit. Other vibrations and all sorts of jars will have a similar effect.

To prevent the vibrations of the tube elements from taking place at a rate high enough to be audible the tube should be carried on what is known as a cushion socket or spring socket. The tube can

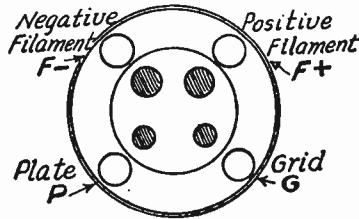

FIG. 4.—Socket for Dry Cell Power Tube.

still vibrate, but the vibrations are now of such low frequency as to make inaudible the changes of plate current even when the tube elements are shaken. Cushion sockets are almost a necessity for the detector tube if the best in tone quality is aimed at. They are

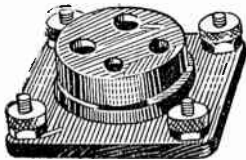

FIG. 5.—Socket for Spring Mounting of Tube.

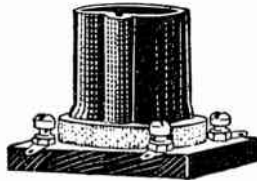

FIG. 6.—Socket Mounted on Sponge Rubber.

also highly desirable for the tubes of all audio frequency stages. They are not so necessary for the radio frequency tubes, although even here they will do good work.

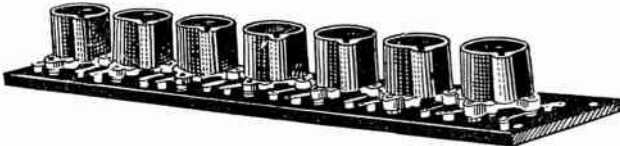

FIG. 7.—Gang Socket for Seven Tubes.

Sockets are sometimes made in two pieces, the part which carries the tube being supported by small flexible springs from the part that is fastened to the base or panel in the receiver. This is shown in Fig. 5. In Fig. 6 is shown a socket mounted upon sponge rubber which gives a very good cushioning effect and serves the same purpose as the spring suspension.

SOCKET WRENCH

Special Sockets.—Dozens of special details of design are worked into the tube sockets made by different manufacturers. Many of these detail refinements add real advantages.

A number of similar sockets may be mounted together on a single base to form a gang socket as in Fig. 7. All of the tubes used in an entire receiver may thus be brought together. This makes for improvement in appearance but its wisdom is doubtful from the electrical standpoint since the plate and grid leads of successive stages are necessarily brought close to each other.

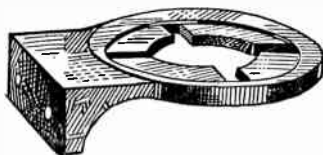

FIG. 8.—Panel Bracket for Tube Socket.

Sub-panels and bases may often be dispensed with in a receiver by mounting the tube sockets on shelf-like extensions such as shown by Fig. 8, these being supported from the vertical panels or other vertical surfaces. Separate brackets may be bought or sockets used which incorporate the bracket feature as part of their construction.

Sockets built as separate units are sometimes dispensed with by mounting the supporting springs or contacts for the tube prongs and the terminal connections directly on the base or sub-panel of the receiver. See also *Construction, Receiver*.

SOCKET WRENCH.—See *Tools*.

SOFT TUBE.—See *Tube, Soft*.

SOLDERING.—In radio receiver work no joint between two conductors may be considered a permanent joint unless the conductors are properly soldered together. Proper soldering does not mean the process of spreading some half-heated solder onto a couple of dirty surfaces.

Material and Tools.—The first essential is a good soldering iron. The best to be had is an electric iron with a good large heating element and a copper tip about three-eighths to one-half inch in diameter extending out to a distance of two or three inches from the heater. This is the best size tip for all around work. Electric soldering irons with small heating elements will usually fail to heat the tip sufficiently to do good work on large conductors which carry heat away from the iron quite rapidly.

If an electric iron cannot be used, a plain soldering copper of the half-pound or three-quarter pound size is about right. This copper should have a rather long tip well tapered. In heating this kind of an iron, keep its tip in the blue part of a gas flame. The yellow part of the flame will deposit so much soot on the iron that soldering will be very difficult.

Wire solder will be much easier to use than bar solder. Plain wire solder may be used but the work will be made easier by selecting good resin-core wire solder. Never use acid-core solder because the joint will surely corrode and cause high resistance.

SOLDERING

Even though resin-core solder is used it will be advisable to have some good non-acid soldering paste handy or to have some pure resin in a small tin container such as the cover of a small can. The advantage of using only resin is that it does not contain any acid to cause corrosion.

The purpose of the resin-core of the solder or of the soldering paste is to clean the oxide from the work and leave the surfaces clean enough so that the hot solder can unite with them. The resin and the pastes are called soldering fluxes.

Aside from the soldering iron, the solder, and the flux it will be necessary to provide a fine cut file, a piece of emery cloth and a piece of plain heavy cotton or wool cloth for cleaning. An old knife will also come in handy.

Tinning the Iron.—The tip of the iron must first be prepared for its work. Coating the tip of the iron with a thin layer of solder is called tinning. First clean the tip for half to three-quarters of an inch back from the end by using the file. Then polish this surface with the emery cloth. Heat the iron as if for soldering and dip the hot tip into the flux or else spread some flux on the tip. Immediately touch the end of the wire solder to the fluxed iron or rub the tip of the iron on a piece of solder. The solder will stick to the copper tip and form a bright coating wherever the tip was thoroughly cleaned. The iron is now ready for work.

If the iron becomes overheated or stays very hot for a long time, the coating will burn off and the tinning process must be gone through with again. When doing considerable soldering, occasionally wipe the tip of the iron with the padded cloth. This will remove any dirt and scale and leave the brightly tinned surface clean again.

Preparing the Joint.—To make really good soldering joints the joint must first be made mechanically strong independently of the solder. That is, the joint between the two parts must be made so that they will hold together indefinitely even were no solder to be applied. Never depend on solder to hold two parts together. The solder has practically no mechanical strength and it is not the purpose of soldering to provide mechanical strength.

If the ends of two wires are to be joined, cross the ends, then twist them one about the other as shown in Fig. 1. Don't simply loop them together and don't lay them along side each other and expect to have a permanent joint. When a wire end is to be joined to another wire running straight on through the joint, wrap the end around the through wire as in Fig. 2. Don't simply butt the end against the through wire and look to the solder to do the mechanical work. When attaching a lug to a wire end, loop the wire through the lug or around the lug when this is possible. Bending the wire end over at a right angle and sticking the projection through the lug will make a solid joint. Don't just lay the wire on top of the lug. The purpose of the solder is to make an electrical joint. The mechanical joint must be made without solder.

Before the parts are fastened together and again after they are fastened, they should be scraped thoroughly clean with the file, a knife blade, or the emery cloth. The grease from a person's hands is enough to prevent making a good soldered joint when conditions are at all difficult.

Heating the Iron.—The iron, whether electric or gas, should be heated just hot enough to blacken a piece of soft pine wood. This does not mean the iron should be hot enough to actually char

SOLDERLESS CONNECTIONS

the wood. An iron at the proper degree of heat will cause solder to flow like water when the tip end of a piece of wire solder is touched to the hot tip. The iron must be hot enough to flow the solder into place, not simply to spread the solder over the outside of the joint.

Soldering the Joint.—Apply a very little soldering paste to the joint. Do not use more paste than can be picked up on the small end of a toothpick. Then touch the solder to the tip of the hot iron and let a drop of solder leave the wire and hang to the surface of the iron's tip. Now touch the tip, with the solder hanging on, to the joint. Hold the tip firmly on top of the joint until the parts to be joined become hot enough from the iron to let the solder run down all through the joint. Even though the solder runs onto the joint the very first thing, keep the iron there until it runs through the joint. There's a big difference.

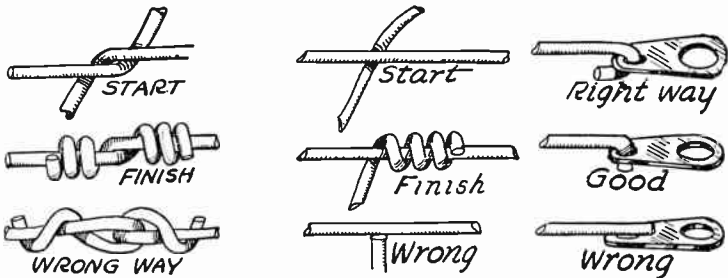

FIG. 1.—Making Joint Between Two Wire Ends in Soldering.

FIG. 2.—Preparing to Solder Wire Ends to Other Wires or Lugs.

Another way is to apply a little flux to the joint, then hold the hot iron underneath the joint until the parts become hot. Then touch the tip end of the wire solder to the top of the joint and let some of the solder run down through the joint until it reaches the iron below. This is a surer way to make a good joint than the first method.

In all this work use the least possible flux and the least possible solder. The flux is an insulator and it must not remain between the surfaces being soldered. As soon as the joint has been soldered and while the solder is still hot, wipe away the excess solder and all the flux with the cloth which has been folded to make a pad. A soldered joint made according to these rules will still be a good joint after the rest of the receiver has fallen apart.

SOLDERLESS CONNECTIONS.—See *Connector*.

SOLENOID.—See *Coil, Solenoid Type*.

SOUND.—Any motion of the air which is distinguishable by the sense of hearing is called a sound. Sound is carried through air and other materials by sound waves which consist of alternating compressions and rarefactions of the material carrying the waves.

The speed with which sound travels through various materials differs greatly. In air sound waves move 1087 feet per second. They move through

SOUND

water nearly five times as fast as through air and through hard, dense materials such as steel and glass the sound waves travel from fifteen to twenty times as fast as through air.

Sound is a form of energy whose strength or intensity may be measured and whose amplitude or force may likewise be measured. The strength of a sound diminishes as the square of the distance from the source of the sound. The strength varies according to the square of the amplitude of the sound waves. The amplitude of the sound waves is a measure of their extent or their swing back and forth, just as the amplitude of a pendulum's swing is measured by the distance it moves each way from a center position.

If the sound waves are regular in occurrence, they are musical or pleasant to the ear. If they are irregular, they are classed as noises. The lowest vibrations which can be heard are those having a frequency between sixteen and twenty per second. The highest audible sounds have frequencies from 10,000 up to 30,000 or more per second. The highest audibility depends on the hearing of the listener.

The frequency of sound waves determines their pitch in the musical scale. In the octave above middle C, starting with middle C the frequencies per second of the notes are as follows:

C	261.0	G	391.5
D	293.6	A	435.0
E	326.2	B	489.4
F	348.0	C	522.0

The foregoing frequencies are those of the international pitch. For convenience in making calculations the philosophical pitch is sometimes used. With this pitch middle C has a frequency of 256.0 in place of 261.0. This frequency, 256.0, is the eighth power of 2, or two multiplied by itself eight times. It therefore allows of easy division and multiplication.

In the philosophical pitch the octave above middle C would have the following frequencies:

C	256	G	384
D	288	A	426.6
E	320	B	480
F	341.3	C	512

A pure tone or simple tone has but a single frequency, at a definite pitch. Few pure tones sound pleasant or musical until they are combined with one or more higher frequencies called overtones. When these overtones have frequencies which are multiples of the fundamental frequency or tone they are called harmonics. Notes produced by most of the musical instruments are composed of fundamentals and of harmonics of the fundamentals. It is the harmonics and overtones produced with the fundamental that distinguish a certain note on one instrument from the same note on another instrument.

The frequencies of the notes in any one octave have the following ratios to one another:

C to D.....	8/9	G to A.....	9/10
D to E.....	9/10	A to B.....	8/9
E to F.....	15/16	B to C.....	15/16
F to G.....	8/9		

SOUND

It is this relation between frequencies of notes which follow each other in the octave that gives the human ear the familiar impression of gradually rising sound. In actual musical instruments the frequencies are slightly different from those of either the international scale or the philosophical scale. These changes make what is called the tempered pitch. The following frequencies of tempered pitch may be compared with those given for the international pitch:

<i>C</i>258.7	<i>G</i>387.5
<i>D</i>290.3	<i>A</i>435.0
<i>E</i>325.9	<i>B</i>488.3
<i>F</i>345.3	<i>C</i>517.3

Sound waves may be reflected back from a surface which they strike just as light waves are reflected from a mirror. Sound is also refracted or bent out of a straight path as it passes through various materials just as the view of an object through a thick layer of glass or through water appears to be bent by refraction. Sound striking an irregular surface is also subject to a scattering or dispersion effect by which the waves are sent in various different directions from the surface. Sound waves of one frequency may be subject to interference from and to combination with waves of other frequencies so that the resultant sound is affected by both frequencies.

The octaves in the philosophical pitch start with the following frequencies: 16, 32, 64, 128, 256, 512, 1024, 2048, 4096. An octave would start with the harmonics of 4096; the octave for the second harmonic starting with a frequency of 8192.

The following table shows the frequencies of the various keys on a piano:

FUNDAMENTAL FREQUENCIES OF PIANO KEYBOARD

White Keys	Black Keys	White Keys	Black Keys	White Keys	Black Keys	White Keys	Black Keys
27	—	97	—	326	—	—	1096
—	28	—	103	345	—	1161	—
30	—	109	—	—	366	—	1230
32	—	—	115	388	—	1304	—
—	34	122	—	—	411	1381	—
36	—	129	—	435	—	—	1463
—	38	—	137	—	461	1550	—
40	—	145	—	488	—	—	1642
43	—	—	154	517	—	1740	—
—	45	162	—	—	548	—	1843
48	—	173	—	581	—	1953	—
—	51	—	183	—	615	2069	—
55	—	194	—	652	—	—	2192
—	58	—	205	691	—	2323	—
61	—	217	—	—	732	—	2461
65	—	—	230	775	—	2607	—
—	69	244	—	—	821	2762	—
73	—	259	—	870	—	—	2926
—	77	—	274	—	922	3100	—
81	—	290	—	977	—	—	3285
86	—	—	308	1035	—	3480	—
—	91	—	—	—	—	—	—

SOUND

The average ranges of frequencies covered by various musical instruments and by singers' voices are shown by the chart.

It is generally more difficult for a radio amplifying and speaker system to reproduce speech clearly than for it to handle instrumental music. Clarity of speech and differentiation between various

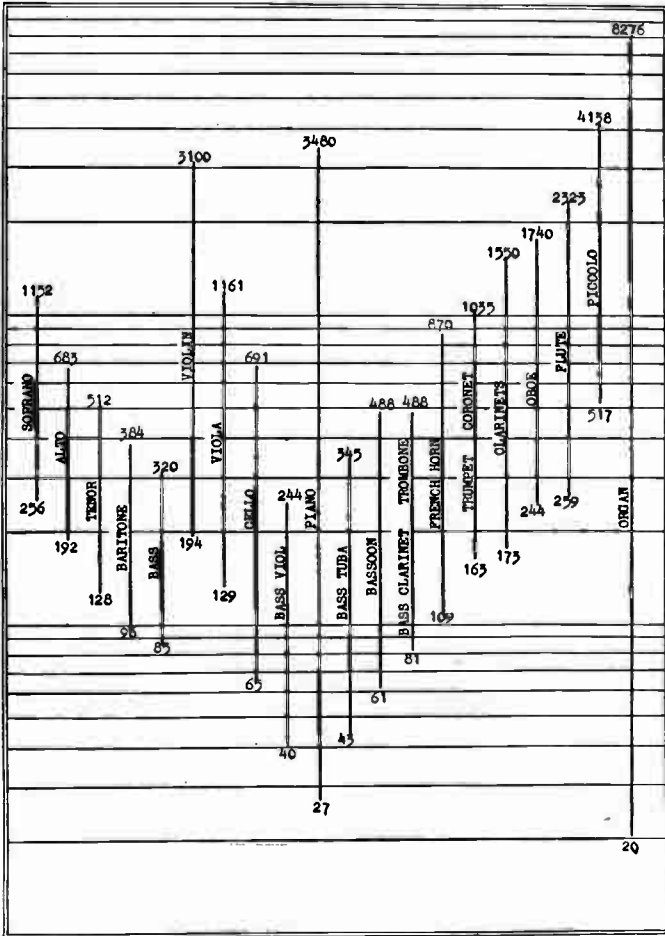

spoken sounds requires good response to the frequencies above seven hundred per second. Should all frequencies below this point be absent, the speech would still be easily understood. Removing the higher frequencies will seriously affect the reproduction of speech and will leave many sounds to be supplied by the imagination.

SPACE CHARGE

Frequencies between 500 and 3000 are most valuable for a speech amplifier.

The average human ear is most sensitive to frequencies between 1500 and 2000 per second. Sensitivity decreases almost uniformly both above and below this range in the musical scale.

See also *Unit, Transmission.*

SPACE CHARGE.—See *Tube, Action of.*

SPACE WINDING.—See *Coil, Space Wound.*

SPACING OF COILS.—See *Coil, Spacing of in Receiver.*

SPAGHETTI.—See *Tubing, Insulating.*

SPARK TELGRAPHY.—See *Radio Telegraphy.*

SPEAKER, LOUD.—The purpose of a loud speaker is to transform variations of electric current into vibrations of the air or sounds. The variations of electric current are the variations of current in the plate circuit of an audio frequency amplifying tube. The first work of the speaker is to allow the current variations to produce mechanical movement in some of the parts of the speaker unit. The moving part is attached to a larger part whose surface

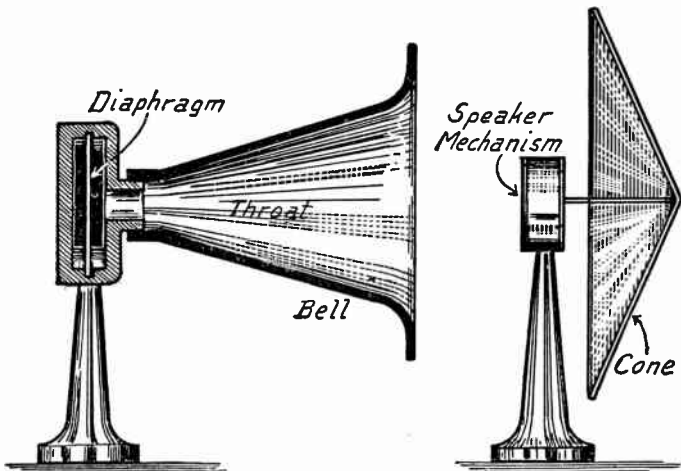

FIG. 1.—Horn Type and Cone Type of Loud Speaker.

area is great enough to set a considerable volume of air into motion. The more air the speaker is able to set into motion the greater will be the volume of sound produced and as a general rule the better will be the tone quality.

Fig. 1 shows the two principal methods of changing the movement of a comparatively small mechanical part into movement of considerable quantities of air. At the left is represented the principle of the familiar horn. A thin metal diaphragm is set into motion,

SPEAKER, LOUD

this diaphragm being at one end or at the foot of the body of air or column of air in the throat and the bell of the horn. The horn greatly augments the rather feeble sounds from the diaphragm.

The longer the horn and the greater the amount of air it contains the greater will be the volume of sound from the speaker provided the diaphragm has sufficient power to move the large air column. Naturally it takes more power at the diaphragm to move a large body of air than to move a smaller body.

At the right hand side of Fig. 1 is shown the cone type of speaker. There is no diaphragm of small size as in the horn type but the moving parts of the speaker mechanism are connected to the center of a conical shaped piece of heavy paper, wood, fibre or other fairly non-resonant material, that is, a material that has no natural resonant period of its own.

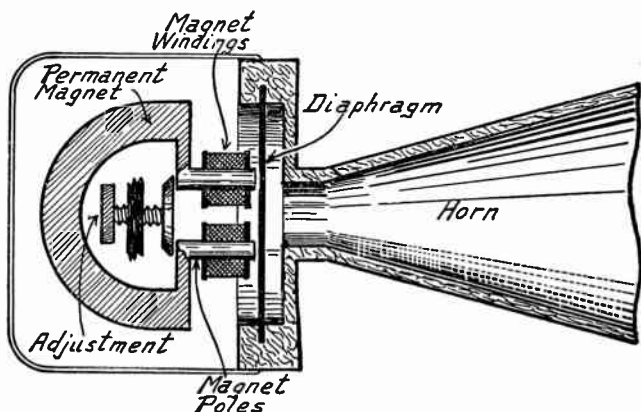

FIG. 2.—Electromagnetic Type of Loud Speaker.

The entire surface of the cone now vibrates at sound frequencies and this large exposed surface sets into corresponding motion all the air in the immediate vicinity of the cone. No horn is required with the cone. This does away with the directional effect of a horn, the effect by which most of the emitted sound is sent in the direction away from the mouth of the horn.

Electromagnetic Speaker.—Several distinctly different types of operating mechanism are used in loud speakers for transforming the changes of current into motion which is transmitted to the diaphragm of a horn or the sounding surface of a cone. The simplest type, using the electromagnetic principle, is shown in Fig. 2. The diaphragm is formed of a very thin piece of iron or else of some non-magnetic material such as aluminum or mica to which is affixed a small piece of iron. The diaphragm is clamped securely all around its edges but is left free at the center. The center of the diaphragm

SPEAKER, LOUD

is a few thousandths of an inch from the pole pieces of a powerful permanent magnet.

Around each pole piece is a small coil made of many turns of very fine wire. This coil is connected to the plate circuit of the amplifying tube so that changes in plate current flow through the coil winding. The two coil windings are connected together so that when the end of one, acting as an electromagnet, is positive the end of the other is negative.

The pole pieces of the permanent magnet attract the diaphragm strongly at all times and maintain it under magnetic tension. The rise and fall of current through the windings adds its effect to that of the permanent magnet so that there is a change of magnetism acting upon the diaphragm to correspond with the changes of current in the tube's plate circuit. This causes the diaphragm to vibrate and give forth sounds.

Speakers of this type generally have an adjustment somewhat similar to the one shown by means of which the distance between the pole pieces and the diaphragm may be adjusted. The speaker will be most sensitive and will respond to the weakest possible signals when the magnet poles are moved very close to the diaphragm. However, when the two parts are too close together loud signals will make the diaphragm rattle against the pole pieces. The adjustment should be made as close as will allow the diaphragm to stay clear of the pole pieces with the strongest signal to be received. The same construction as shown in Fig. 2, but usually without the adjustment, is used for head-phone receivers. See *Phone, Head*.

Balanced Armature Speaker.—The operating principle of one of the most generally used speaker mechanisms is shown in Fig. 3. This is the balanced armature type. It is used in the construction of many cone speakers and also in many of the high grade horn type speakers.

This balanced armature mechanism makes use of a large and powerful permanent magnet having specially formed pole pieces attached to its ends. The pole pieces provide two positive poles on one side and two negative poles on the other side as shown. Between the pole piece yokes is supported a small iron armature pivoted at its center so that it may tilt back and forth one way and the other between the pole piece yokes. Around the pivoted armature is placed a coil connected into the output circuit of the receiver. One end of the armature connects through one or more rods to the center of a cone or the center of a diaphragm.

As current flows in one direction around the coil winding, the upper end of the coil and the upper end of the iron armature become positive, while with reversal of current direction the upper ends become negative. The lower end is, of course, always of a polarity opposite to that of the upper end.

With the upper end of the armature positive and its lower end negative, for an example, the upper positive end will be attracted to the negative pole of the permanent magnet and the lower end will be attracted to the positive pole of the permanent magnet. With the permanent magnet polarities as indicated in Fig. 3 the upper end of the armature will then tilt toward the right and the lower end toward the left, the armature turning slightly around its pivot. Upon reversal of the coil polarities the armature would tend to tilt its upper end toward the left.

Since the plate current from an amplifying tube rises and falls in value, the armature will be in a continual state of motion toward and away from either the positive or the negative permanent magnet pole. The extent of the

SPEAKER, LOUD

motion will depend on the power or amperage in the plate current while the frequency of the motion will depend on the frequency of the changes in plate current.

The motion of the one end of the balanced armature is transmitted through a rod directly to the cone or diaphragm or else, as shown in Fig. 3, is transmitted through some form of lever arrangement to the diaphragm or cone.

It will be realized that the direction of current flow through the coil makes no difference in the operation of the balanced armature type of speaker. When current flows in one direction the armature is moved toward one set of poles, and if the current flows in the opposite direction the armature is moved toward the other set of poles.

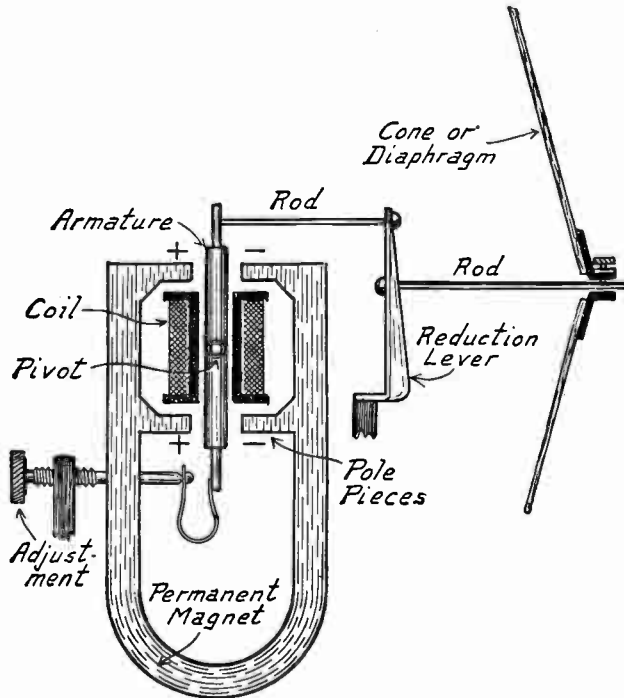

FIG. 3.—Balanced Armature Type of Loud Speaker.

For best results only the changes of plate current corresponding to the sounds being produced should be allowed to flow through this type of speaker, or, for that matter, any other type of speaker. If the direct current from the plate voltage supply unit is allowed to flow through the speaker coil, this direct current will tend continually to keep the armature tilted more one way than the other because there is not, or should not, be any rise and fall of direct current in the plate circuit. The only change should be in the part of the current controlled by the grid of the tube.

SPEAKER, LOUD

To compensate for direct current which may be allowed to flow in the speaker coil an adjustment is sometimes provided for this type of mechanism. One type of adjustment is indicated in Fig. 3. By means of this adjustment the armature is pulled or pushed in a direction opposite to the steady push or pull caused by the direct current in the coil. This adjustment allows the armature to be evenly balanced between the pole pieces under all conditions, thus allowing for the maximum possible range of motion to be caused by the rise and fall of audio frequency currents acting in the coil windings.

Fig. 4 shows a type of speaker mechanism in which the two pole pieces of a permanent magnet are made to operate two cones or two diaphragms at the same time. To the poles of a permanent magnet are attached two iron rings forming the pole pieces. Each ring carries a flexible metal diaphragm to the center of which is affixed a

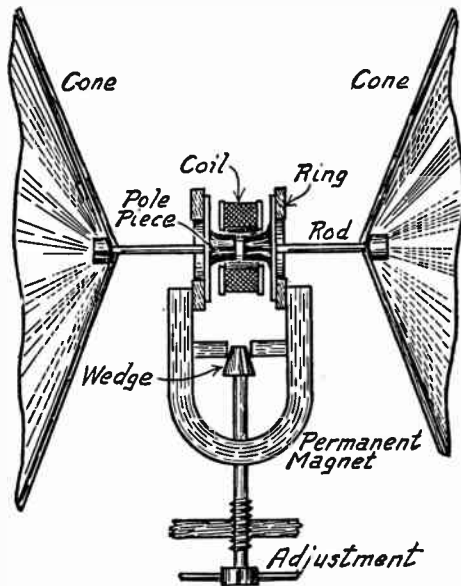

FIG. 4.—Speaker Mechanism Operating Two Cones.

small cylindrical extension on the inside and a rod running to the cone or diaphragm on the outside. The internal cylindrical extensions come within a few thousandths of an inch of each other and since they are magnetically connected with the permanent magnet they are strongly attracted to each other.

The springiness of the permanent magnet tends to push the extension pieces together but they are held a little distance apart by a taper wedge adjustment acting between the arms of the magnet as shown. Around the extension pieces between the diaphragm is a coil connected to the output circuit of the receiver. Changes of current through the coil winding tend to change the total magnetic attraction acting between the extension pieces so that they vibrate with the changes of current in the coil.

SPEAKER, LOUD

The more closely the two internal extensions are allowed to come to each other by withdrawing the wedge shaped adjuster, the more sensitive the speaker becomes. But if the extensions are allowed to come too close, strong signals will cause them to touch and cause a rattle. The greater the power to be handled the farther apart the extensions are kept by the adjustment.

Types of Speakers.—Depending on the results desired and on the allowable cost, various types of speakers are used. The small horn type is lowest in cost and gives least satisfactory reproduction. The better types include cone type speakers operated with one of the mechanisms shown, the exponential horn type, the moving coil or dynamic type and the condenser speaker. The response at various frequencies of the small horn speaker, of a speaker with exponential horn and of a moving coil speaker with its baffle board are shown in Fig. 5.

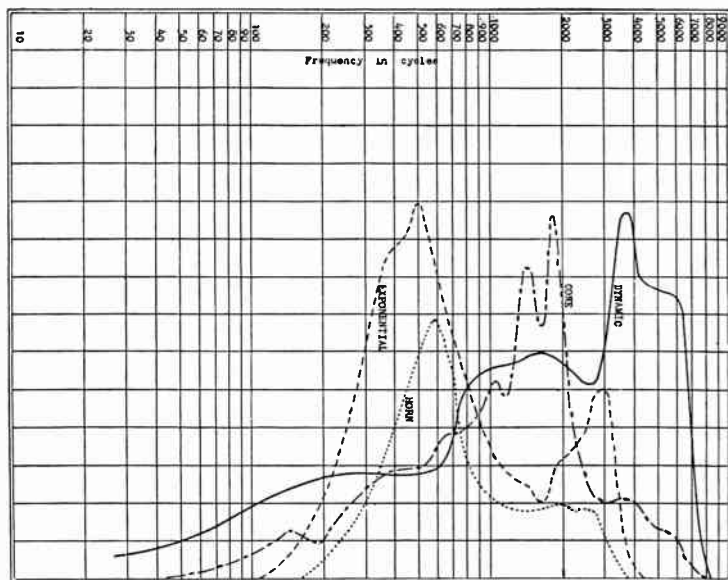

FIG. 5.—Response Curves of Various Types of Speakers.

Exponential Horn Speaker.—The distinguishing feature of this speaker is the shape of the horn portion. An exponential horn doubles its cross sectional area at equal intervals in its length. This type is also called a logarithmic horn. The general shape is shown in Fig. 6. The area is shown to double for equal increases in length. The corresponding sides of squares and diameters of circles are indicated.

A horn of this type places such a load on the actuating unit that the response is good even at low frequencies. Most of the energy represented in the

SPEAKER, LOUD

diaphragm's motion is changed into motion of air in the horn column. The more gradually the horn expands and the longer it is made the lower will be the frequencies which may be handled satisfactorily. A large mouth opening reduces the tendency to resonances at certain frequencies. The material of which the horn is made should be of some non-resonant material such as papier-mache. These horns are preferably formed with the axis a straight line, but because of their great length are often twisted or coiled to occupy less cubic space.

Dynamic Loud Speaker.—A dynamic speaker radiates sound from a small cone or else a diaphragm to which is attached a coil carrying the signal current. Changes in signal current produce a varying field around the coil. This coil is placed within the steady field of a powerful electromagnet and the reaction between the two fields causes movement of the coil and the attached radiating surface, thus producing sound from the speaker. The definition adopted

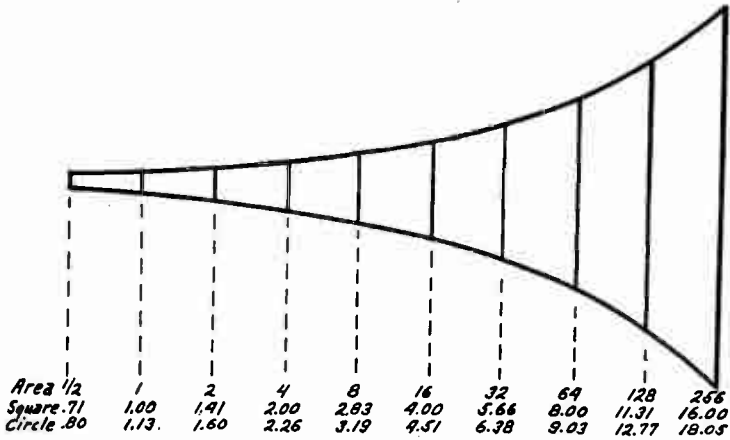

FIG. 6.—Design of Exponential Horn.

by the Radio Manufacturers' Association is: "A dynamic speaker is one in which a portion of the conductor carrying the alternating signal current is a part of the moving system, the force producing the motion being due to the location of this conductor in a magnetic field." Since the distinguishing feature of this speaker is the moving coil attached to the sound radiating surface, it is more exact to call it a "moving coil loud speaker" than a dynamic speaker inasmuch as all speakers are dynamic in that they utilize forces producing motion.

The principal parts of a moving coil or dynamic speaker are shown in Fig. 7. The moving coil consists of a few turns of wire carried by an extension of the cone's apex. The field magnet consists of a central round part carrying the winding and forming one magnet pole, also a cylindrical housing of which the edges form the other pole of the magnet. The poles of the field magnet are often narrowed to produce a highly concentrated field between them. The

SPEAKER, LOUD

field magnet is supplied with direct current or pulsating unidirectional current. The moving coil is connected to the secondary of a step-down transformer, the primary side being connected in the plate circuit of the output tube or tubes in the audio amplifier. The sound radiating cone is held by a flexible connection, often made of soft leather, between its outer edge and a solid supporting ring.

With direct current flowing in the field winding and the varying signal current flowing in the moving coil, the moving coil and the cone move back and forth, left and right in Fig. 7, an amount determined by the signal current and the resulting changes in strength of the moving coil's field. The moving coil and the cone are very light so that they respond proportionately to all shadings in the signal energy. Cones are made of parchment paper, fibre, moulded compositions, magnesium metal and similar materials which provide the required stiffness.

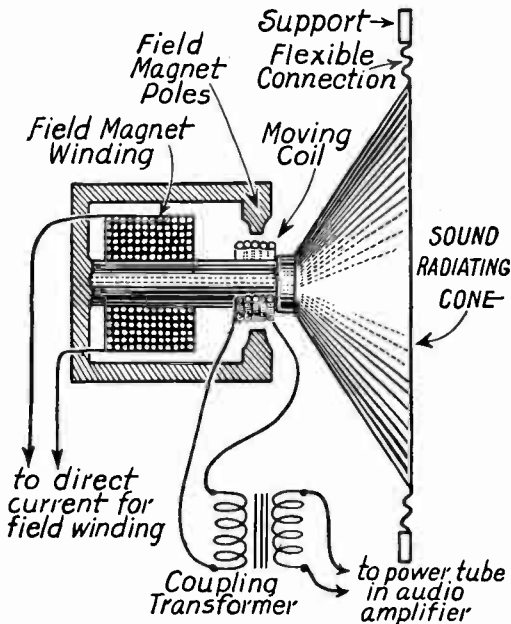

FIG. 7.—Parts of a Moving Coil or Dynamic Speaker.

Speakers of the dynamic type when supplied with pulsating field current use an additional small neutralizing winding connected in series with the moving coil but wound the opposite direction. This coil is placed on the end of the field magnet central pole as shown in Fig. 8. The action of this extra winding balances out the hum current which otherwise would be present in the speaker because of the use of pulsating direct current in the field magnet.

Certain of the higher frequencies, notably those between 3500 and 5000 cycles, may be reduced to advantage. These frequencies are emphasized in many dynamic speakers by natural resonance of the cone and must be suppressed for naturalness. These frequencies are reduced in strength by the low-pass filter shown between the coupling transformer and the moving coil in Fig. 8. The filter consists of a choke coil in series with one side of the line and one or two bypass condensers across the line. The filter supplied with Magnavox

SPEAKER, LOUD

speakers consists of an 800-millihenry iron-cored choke and two condensers of 0.015 microfarad capacity each.

Direct current for the field magnet winding may be secured from various sources. The oldest dynamic speakers, and many of those now produced, use a storage battery of from six to twelve volts delivering from one-half to one and one-half amperes to the field winding.

The field may be energized by rectified and filtered current furnished by the plate power supply unit used with the receiver and amplifier. A typical circuit is shown in Fig. 9. The plate supply circuit is opened between points *A* and *B* and connection made here to the field winding of the speaker. As a general rule, from 100 to 200 volts pressure is applied across the field to produce a field current of from forty to one hundred milliamperes. With a power unit designed to furnish field current, use of the unit without this style of dynamic

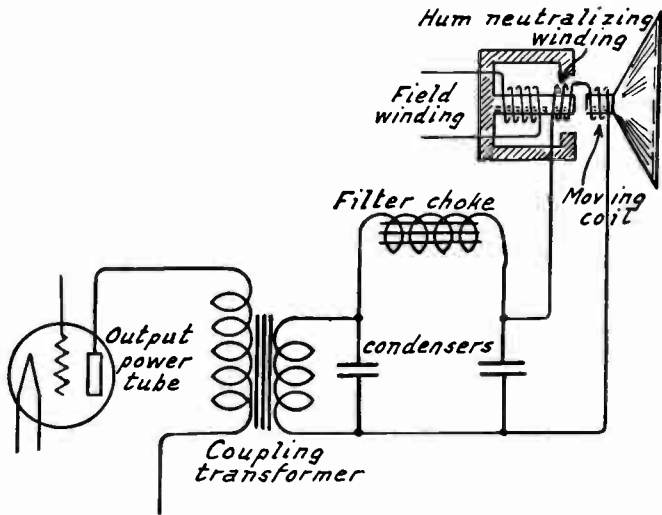

FIG. 8.—Hum Winding and Scratch Filter on Dynamic Speaker.

speaker requires that points *A* and *B* be connected through a fixed resistor which approximates the resistance of the field winding of the speaker. This resistance is usually about 2500 ohms.

A field winding of the type indicated in Fig. 9 makes an excellent choke for use in a power unit filter and is often used for this purpose as shown in Fig. 10. These field magnets have from 25,000 to 30,000 turns of wire on an iron core which gives them a high inductance value.

A third method of field current supply is shown in Fig. 11. A step-down transformer and a full-wave dry type (copper oxide or copper sulphide) rectifier take power from an alternating current supply line and deliver to the speaker field winding a unidirectional pulsating current which is smoothed out by the choke action of the field winding to make what amounts to pure direct current. From six to twelve volts pressure is applied to the field and the current is generally between one and two amperes.

Still another method of furnishing field current for these speakers consists of a high voltage rectifier built as a part of the speaker mechanism and

SPEAKER, LOUD

connected directly to the field winding. Some speakers of this class employ a full-wave rectifying tube of the type capable of delivering up to 125 milliamperes of pulsating unidirectional current. A tube of this kind will furnish as much as twenty watts for the field and since the speaker will operate very well with any power from six watts upward, the result is satisfactory. A step-up transformer is connected between the supply line and the rectifying tube. High voltage, dry type metallic rectifiers are also employed in practically the same manner as the tube rectifier.

The sensitivity and response of a dynamic speaker is improved by increasing the amount of flux in the magnetic gap occupied by the moving coil. Flux densities in excess of 100,000 magnetic lines to the square inch of cross section are commonly employed.

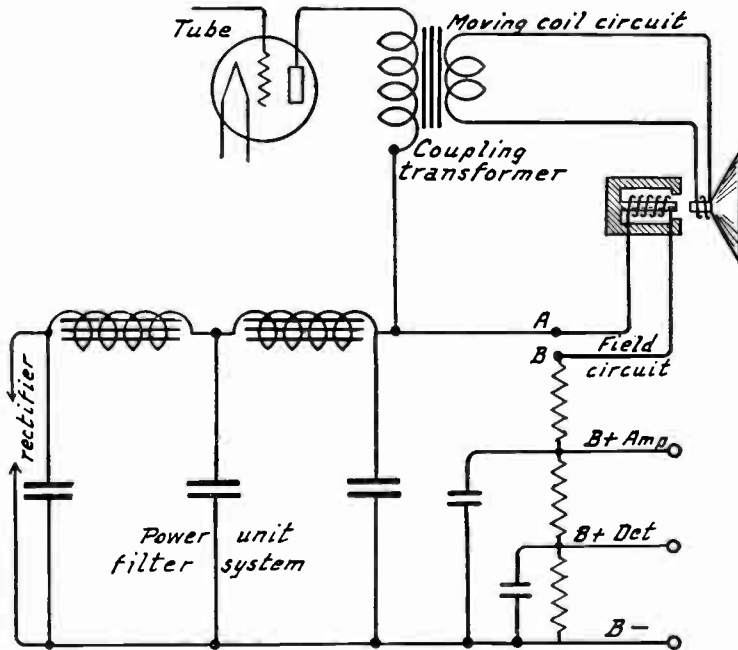

FIG. 9.—Plate Power Unit Connection to Speaker Field.

The nomenclature applied to dynamic speakers is somewhat confusing. The types having built-in rectifiers for field supply so that field energy is secured from a separate supply line and not from the receiver are generally called alternating current speakers or "A. C." speakers. Types with which the field supply comes from the power unit in the receiver are called direct current speakers or "D. C." speakers. Types in which the field is designed to operate from six or twelve volt direct current are called battery type speakers.

The speaker coupling transformer shown in Figs. 7, 8 and 9 should be designed on its primary side to match the output impedance or plate resistance of the power tube, while the transformer's secondary should match the impedance of the speaker moving coil. The im-

SPEAKER, LOUD

pedance of these moving coils is very small so that the transformer has a considerable step-down ratio. The resistance of moving coils generally runs from five to eight ohms, those used in many speakers having only thirty-two turns of wire.

Coupling transformers have turns ratios of about thirty or thirty-five to one for "210" types of power tubes. With tubes having lower plate resistances, such as the "250" types, the step-down ratio is proportionately less. Unless the

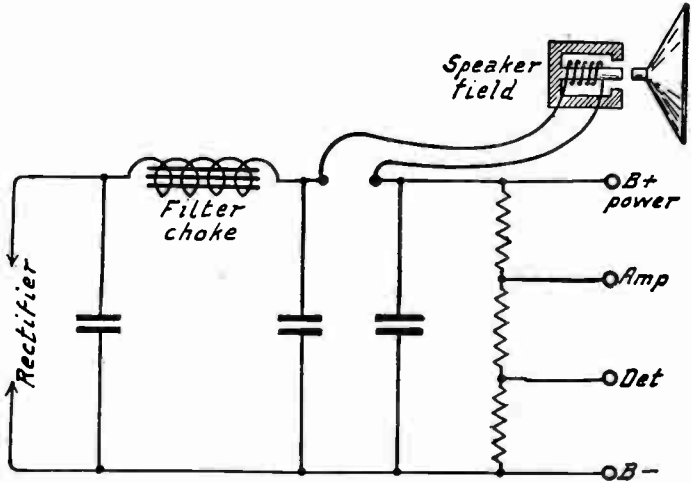

FIG. 10.—Speaker Field Used As a Filter Choke.

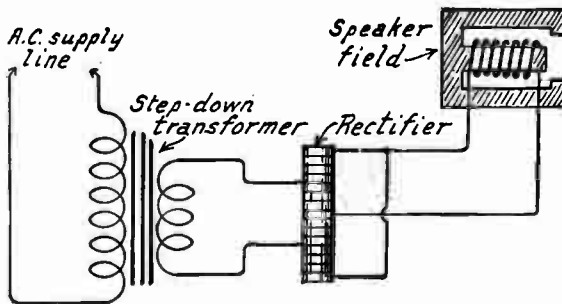

FIG. 11.—Rectifier Field Current Supply.

coupling transformer is a fair impedance match for the tube on one side and the moving coil on the other, the result will be very poor. Output choke and condenser couplings such as shown in Figs. 3 and 4 under *Speaker, Loud, Connections to Receiver* are not satisfactory. The characteristics of the moving coil result in these types being called "low impedance speakers."

SPEAKER, LOUD

Movement of the cone in a dynamic speaker results, for one alternation of signal current, in a compression of the air in front of the cone and a rarefaction of the air back of the cone. The two waves thus set up in the air must be kept apart or they will neutralize each other on the low notes. Separation is accomplished by the use of a baffle composed either of a large flat surface or of the walls of a box or cabinet containing the speaker.

In order to satisfactorily reproduce the lower tones it is necessary that the distance from the center of the speaker cone to the nearest edge of a rectangular or round baffle be at least fifteen to eighteen inches as indicated in Fig. 12. If the speaker is enclosed within a housing the effective baffle may be measured as shown in Fig. 13. Distance *A* plus distance *B* should be at least fifteen to eighteen inches. An alternative method is to measure distances, *C*, *D* and *E*, when their total should equal twenty-four inches or more. These dimensions give excellent reproduction down to one hundred cycles. Larger dimensions give still lower frequency response.

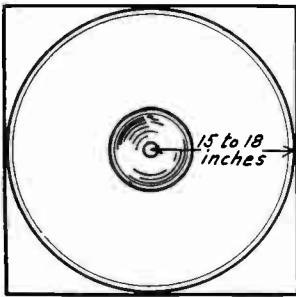

FIG. 12.—Measurements for Flat Speaker Baffle.

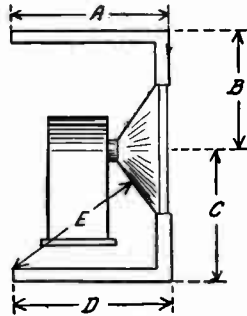

FIG. 13.—Measurements for Box Type Baffle.

Either a flat baffle or a cabinet type should be made heavy and solid since it is desired that they remain free from vibration. This requirement necessitates the use of non-resonant material for baffles and cabinets. There are many special materials designed for use where sound is to be deadened in buildings, these materials making excellent baffles. The clear space within a cabinet should be as small as possible since large chambers produce resonance at certain low frequencies and result in very objectionable "booming" effects. All space between the edge of the cone and the circular opening in the baffle must be closed so that no air movement can take place except around the edges of the baffle. Cabinets should not be tightly closed because this will damp the cone's motion. Large openings should be provided in the back of any cabinet used with a dynamic speaker.

Condenser Loud Speaker.—The condenser speaker or electrostatic speaker consists of two sets of condenser plates, those of one polarity being movable and radiating sound waves when caused to vibrate by the voltage changes in the applied signal.

The principle of construction underlying all condenser speakers is shown in Fig. 14. The fixed plate is rigidly supported. The movable plate or diaphragm is of thin metal or metal foil. The dielectric

SPEAKER, LOUD

between the plates may be air, rubber composition or other material.

The signal voltages are applied to the speaker through a coupling transformer, one terminal of which is directly connected to the diaphragm while the other terminal is connected through a large capacity blocking condenser. This connects the two terminals of the transformer secondary to the two plates of the speaker. Voltage changes in the transformer secondary then cause each of the speaker plates to become alternately positive and negative. While a signal is being applied the two plates are always being affected by voltages of opposite polarity from the two ends of the transformer secondary. The electrostatic charges developed on the plates attract each other and the movable plate is drawn toward the fixed plate. The higher the signal voltage, the greater will be the attraction and the greater the movement.

In Fig. 14 it will be seen that provision is made to apply a steady polarizing voltage to the speaker plates. The positive side of the polarizing voltage is connected to the speaker fixed plate and the negative side to the speaker diaphragm. The blocking condenser

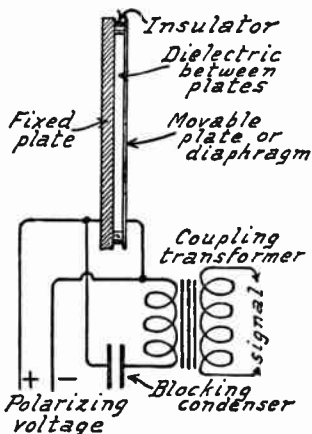

FIG. 14.—Principle of Condenser Speaker.

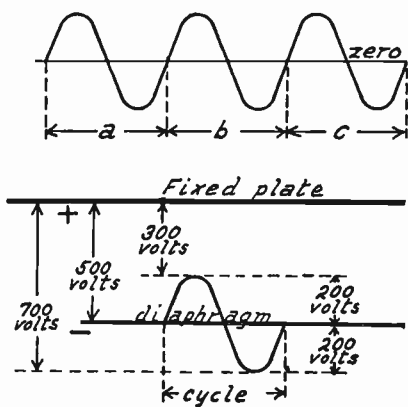

FIG. 15.—Action of Polarizing Voltage.

prevents the polarizing voltage from passing its current through the coupling transformer's winding. The reason for applying this polarizing voltage may be understood from an examination of Fig. 15. The upper drawing illustrates the action of an alternating signal voltage. There are three cycles shown; one at *a*, another at *b* and a third at *c*.

Although there are but three complete cycles shown at the top of Fig. 15, there are six points of maximum voltage, three of positive polarity and three of negative polarity. Each of the voltage peaks will cause movement of the speaker diaphragm toward the fixed plate and in place of the three impulses of the signal there will be six sound impulses from the speaker. The application of a polarizing voltage prevents this frequency doubling as will be shown from the lower drawing in Fig. 15.

SPEAKER, LOUD

Going back to the diagram of Fig. 14, it will be seen that the positive side of the polarizing voltage is connected to the fixed plate of the speaker and that the negative side is connected to the diaphragm. The reverse connections may also be used. In the lower drawing of Fig. 15 is indicated a potential difference of 500 volts between the diaphragm and the fixed plate. Now, when the signal voltage shown by the single cycle drawn out has a strength of 200 volts positive on the diaphragm, the net voltage difference between the plate and diaphragm will be 500 less 200, or 300 volts as shown. When the signal voltage is 200 volts negative this pressure will be added to the negative polarizing voltage and the total difference between plate and diaphragm will be 500 plus 200, or 700 volts as shown. The diaphragm thus is seen to be always negative with respect to the fixed plate instead of being alternately negative and positive as at the top of Fig. 15. With the polarizing voltage applied, one signal polarity in the cycle will draw the diaphragm strongly toward the plate while the opposite signal polarity will allow the diaphragm to recede from the plate. Without the polarizing voltage the diaphragm will be attracted toward the plate twice in each cycle.

The polarizing voltage always must be greater than the signal amplitude so that the steady attraction between diaphragm and plate never disappears because of a signal voltage equalling or exceeding the polarizing voltage. Too

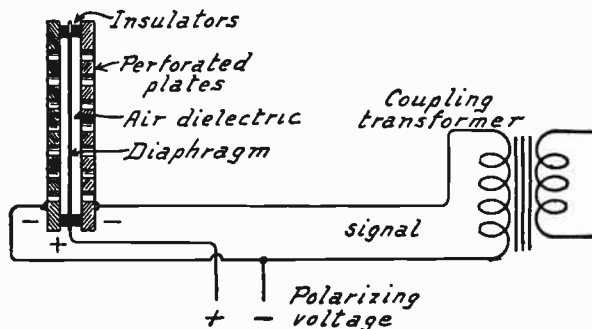

FIG. 16.—Action of Vogt Condenser Speaker.

little polarizing voltage will allow frequency doubling, the introduction of false harmonics and metallic or tinny reproduction.

The required polarizing voltage depends on the signal voltage applied and this, in turn, depends on the amplification and the type of power tube in use. Since signals often reach several hundred volts at their peak, the required potential for polarizing is at least 500 to 750 volts in most cases.

The force with which the diaphragm moves depends not only upon the applied signal voltage but also upon the polarizing voltage, being the result of a product of these two voltages. While a high polarizing voltage is desirable, excessive voltage will draw the diaphragm under such a tension that the speaker output is reduced.

The operating principle of the Vogt or "Oszilloplan" condenser speaker is illustrated in Fig. 16. Two perforated fixed plates are employed and the thin moving plate or diaphragm is placed between them. The dielectric is air and the separation between plates is very small. The fixed plates are perforated with many openings so that movement of the diaphragm may be practically free.

SPEAKER, LOUD

Positive polarizing voltage is shown applied to the diaphragm and negative voltage to the outside plates. There is then equal attraction between the diaphragm and each of the perforated plates so that, with no signal voltage applied, the diaphragm tends to remain balanced midway between the plates.

Application of signal voltage to the outside plates causes one of them to become less negative (or more positive) while the other becomes more negative. This is true because a rise of voltage at one terminal of the coupling transformer secondary is accompanied by a fall of voltage at the other terminal. The changing potential on the outside plates causes the attraction for the diaphragm to increase on one side as it decreases on the other side. This action has been called "push-pull" in some instances. The resulting vibration of the diaphragm produces sound waves which correspond to the signal voltages.

Speakers of this type are generally made with circular plates of one foot or more diameter. The greater the surface area of the plates, the more power they are capable of radiating. The capacity of one commercial model is a little less than 0.001 microfarad.

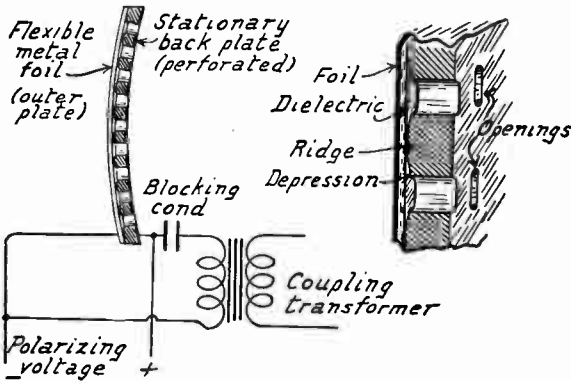

FIG. 17.—Construction of Kyle Condenser Speaker.

Operation of the Kyle or "Kylectron" condenser speaker may be understood from Fig. 17. There are two plates separated by a thin layer of rubber composition as dielectric. The stationary plate is of aluminum, is of rigid construction and is pierced with numerous oblong openings. Signal voltages are applied through a coupling transformer in Fig. 17 but may be applied by other methods shown hereafter.

In the enlarged view at the right hand side of Fig. 17 it may be seen that there is a recess or depression formed around the mouth of each opening. These depressions are of sufficient depth to allow flexing of the dielectric and foil upon application of signal voltages to the speaker. Change of potential difference between the back plate and the metal foil changes the attraction between them, thus causing motion of the foil corresponding to the signal voltages. Sound waves are radiated from the foil surface.

SPEAKER, LOUD

These speakers are made in rectangular sections, each measuring eight by twelve inches. They are set up in groups of four or more units to provide a total sound radiating surface of from two and one-half to four square feet for ordinary home use. The several sections forming one speaker are connected together in parallel, all the back plates on one side of the circuit and all the foil sides on the other side.

The dielectric material is about five thousandths inch thick and each speaker section has a capacity of about 0.004 microfarad. The dielectric strength is about 2000 volts. The flexible diaphragm may be of metal leaf or of a metal coat sprayed onto the dielectric.

Speakers of this type have a rather pronounced directional characteristic, especially at the higher sound frequencies which are radiated at a right angle to the speaker surface. The sections are slightly curved and when mounted so that the entire assembly is built up to have a convex radiating surface the sound may be directed over any desired area in front of the speaker.

While the rather large surface of the speaker acts to some extent as a baffle, satisfactory reproduction requires the use of an additional baffle surface which extends for at least ten inches all around the radiating surface. This baffle may be flat or may be formed by the sides of a box enclosing the speaker. There must be at least six inches clear space back of the speaker to prevent muffling of the sound. The assembly of speaker sections may be supported

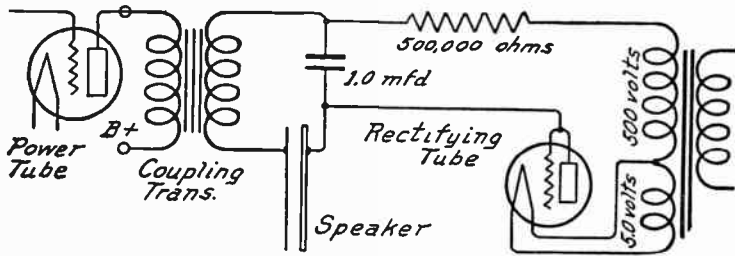

FIG. 18.—Separate Speaker Polarizing Unit.

rigidly around the outside and in this case it is advisable to place solid support between sections to prevent the whole speaker from vibrating at some low frequency. It is also satisfactory to support the edges of the speaker assembly in some sound deadening material, this making the rigid bracing unnecessary.

The response of this speaker at various sound frequencies depends to a great extent on the relation between the impedance of the amplifier's output circuit and the capacity of the speaker units. The speaker capacity may be taken as equal to 0.004 mfd. times the number of sections. The output impedance of the amplifier may be taken as the plate resistance of the power tube or tubes when they are connected directly to the speaker or as the impedance of the secondary winding of a coupling transformer between tubes and speaker. The higher the product of the output impedance (in ohms) and speaker capacity (in microfarads) the less will be the proportion of high to low frequencies. When this product is between 70 and 100 for five or six sections a fairly uniform response is secured. The product may be altered by changing the secondary impedance of the transformer or by inserting a resistance in the tube plate lead.

These speakers are often built with an attached polarizing unit as shown in Fig. 18. The rectifying tube is of an ordinary small amplifying type such as a "201-A". The grid and plate are connected together at the tube socket. Since there is no flow of current from the polarizer after the speaker plates

SPEAKER, LOUD, CONNECTIONS TO RECEIVER

are once charged the load on this tube and on the step-up transformer is very small. A 500,000-ohm resistor prevents damage in case of a short circuit. Signal voltages from the transformer are applied directly to one side and through a condenser to the other side of the speaker.

In the case of power tubes which use a plate voltage high enough to polarize the speaker the connection of Fig. 19 may be used without an added polarizer, the plate voltage being applied to the speaker. Transformer coupling with similar tubes is shown in Fig. 20. The transformer allows adjustment of impedance relation between speaker and tube.

The polarizer of Fig. 18 may be applied to an amplifier as in Fig. 21. Here the filament current and high voltage supply for the rectifier are taken from extra windings on the main power transformer. This diagram shows the connection of push-pull power tubes with a coupling choke.

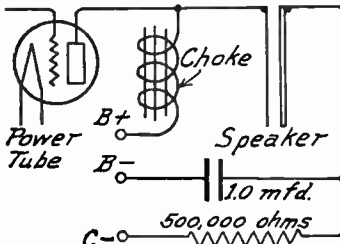

FIG. 19.—Choke Connection to Speaker.

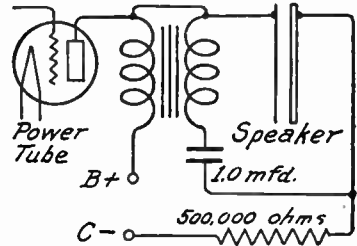

FIG. 20.—Condenser Connection to Speaker.

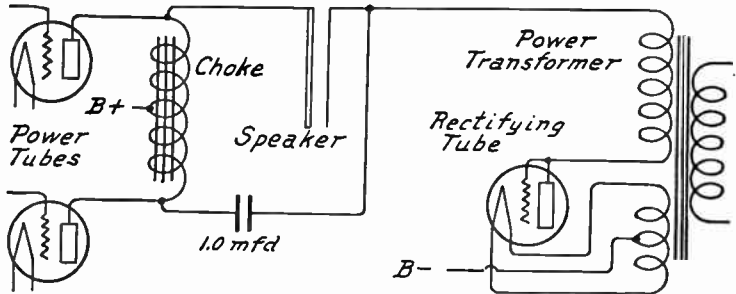

FIG. 21.—Polarizing Unit On Power Transformer.

SPEAKER, LOUD, CONNECTIONS TO RECEIVER.

—The simplest and least desirable method of connecting the loud speaker to the receiver output is shown in Fig. 1. One of the speaker leads is connected to the plate of the last audio amplifying tube and the other speaker lead is connected to the B-battery or plate voltage supply unit. If this method is adopted a bypass condenser of from .002 to .005 microfarad capacity should be connected between the plate terminal of the tube and one of the filament terminals on the tube. This condenser will bypass any stray high frequencies which would not pass easily through the high impedance of the speaker winding.

SPEAKER, LOUD, CONNECTIONS TO RECEIVER

It is customary to connect the plate of the tube to the tip prong or spring of a jack, the plate battery or voltage supply unit then being connected to the mounting shell of the jack. The positive line to the speaker is connected to the outer shell of the plug and the negative or plate line is connected to the plug tip.

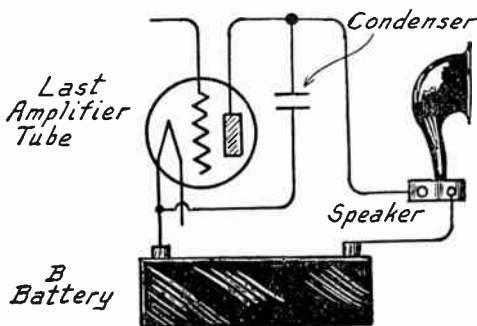

FIG. 1.—*Loud Speaker Connected Directly to Last Tube.*

With many speakers it is important that the connections be made with due regard to polarity. One of the speaker wire leads often is red in color or has a red thread tracer running through the woven insulation. This is the line that should be connected to the positive side of the B-battery or plate supply unit. If the connections are reversed, the direct current for the plate circuit opposes the magnetism of the speaker's permanent magnet when this current flows through the speaker coil winding.

The current flowing in the plate circuit of the audio amplifier tube is shown by Fig. 2. There is a rise and fall of the plate current above and below the average plate current, this rise and fall being at audio frequencies. These

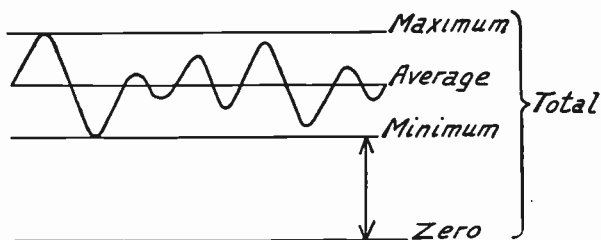

FIG. 2.—*Current of Plate Circuit of Audio Tube Connected to Speaker.*

changes of plate current represent the audio frequency currents which are to be transformed into sound by the speaker.

But there is a certain minimum current, a direct current, which is always flowing in the plate circuit. This direct current adds nothing to the sounds produced by the speaker and when it opposes the magnetism of the speaker this current will do actual harm. Therefore, it is highly desirable to pass only the current changes through the speaker and to keep the direct current component out of the speaker entirely. Several methods of accomplishing this will be shown.

SPEAKER, LOUD, CONNECTIONS TO RECEIVER

The principle of operation for one satisfactory method is shown by Fig. 3. The plate of the output tube is connected to a high impedance choke coil and also to a low impedance condenser. The speaker is then connected between the other side of the condenser

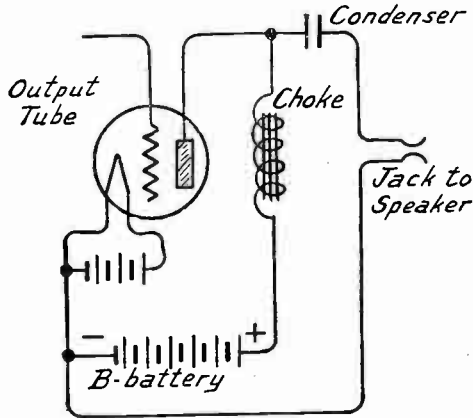

FIG. 3.—Circuits of Condenser and Choke for Speaker Connection.

and the filament circuit of the tube. The other end of the choke is connected to the plate voltage supply.

The direct current component of the plate current cannot pass through the condenser but passes quite easily through the choke coil, being hindered only

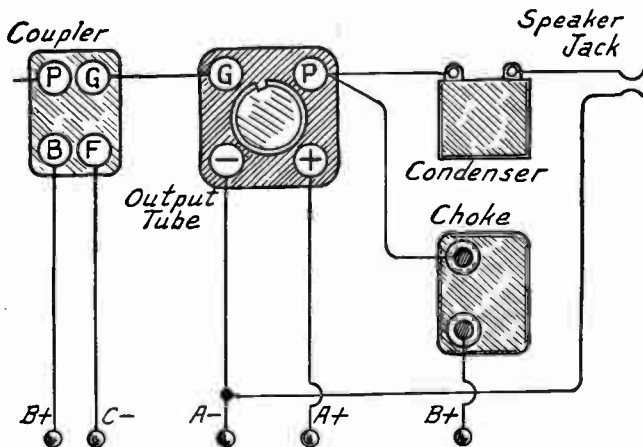

FIG. 4.—Connection of Condenser and Choke for Speaker.

by the direct current resistance of the choke. The audio frequency component passes with ease through the condenser, which is of large capacity, but meets with great opposition in trying to flow through the choke. Thus, the audio

SPEAKER, LOUD, CONNECTIONS TO RECEIVER

frequency changes pass through the condenser to the speaker while the direct current avoids the speaker and passes through the battery or plate supply circuit. The speaker then handles only the changes of current.

Fig. 4 shows the layout of such a choke and condenser combination as applied to the output end of an ordinary audio frequency amplifier. No change is made in the grid circuit of the audio tube, the circuit which contains the preceding audio frequency transformer, amplifying choke or resistance

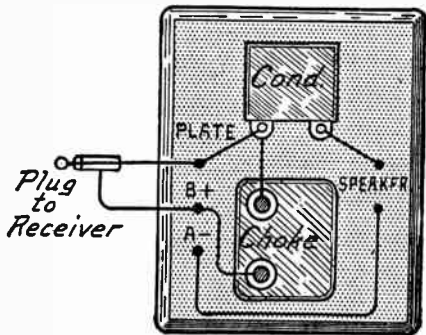

FIG. 5.—Condenser and Choke Unit for Speaker Connection.

coupling. Between the regular output jack or speaker connections and the plate terminal of the last audio tube the choke and condenser are inserted and connected as shown.

The choke must have high impedance at audio frequencies. This choke should have an inductance of 300 henries or more to be satisfactory. The usual amplifying chokes are satisfactory. The condenser should be of two microfarad capacity or larger so that all of the lower tones will be passed

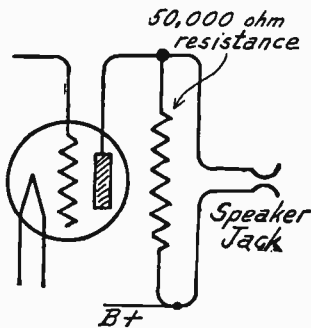

FIG. 6.—Bypassing Resistance for Speaker Connection.

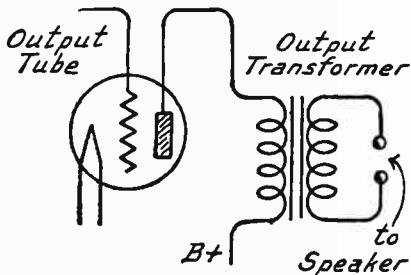

FIG. 7.—Circuits for Output Transformer for Speaker Connection.

through to the speaker. The choke should have a direct current resistance of only a few hundred ohms. The high resistance of transformer windings used as chokes greatly reduces the plate voltage.

The choke and condenser combination may be built up as a separate unit for use with any receiver and any speaker by following the layout of Fig. 5. The connections are the same as those in Fig. 4. The plug, if used, is inserted in the output jack of the receiver. If no plug and jack are used, one of the

SPEAKER, LOUD, REQUIREMENTS FOR

terminals is connected to the plate voltage supply on the positive side and a third is connected to the negative side of the filament current supply.

Fairly good results may be secured in bypassing part of the direct current through a high resistance connected across the loud speaker terminals as shown in Fig. 6. If this resistance is variable it will also act as a volume control for the receiver.

The use of an output transformer is shown in Figs. 7 and 8. One side of the transformer is connected between the plate of the last amplifying tube and the plate voltage supply. The other side of the transformer is connected to the speaker terminals or speaker jack. Since the transformer will pass only changes of current it is only these changes that go through to the speaker while the direct current passes through the transformer between the tube plate and the plate voltage unit.

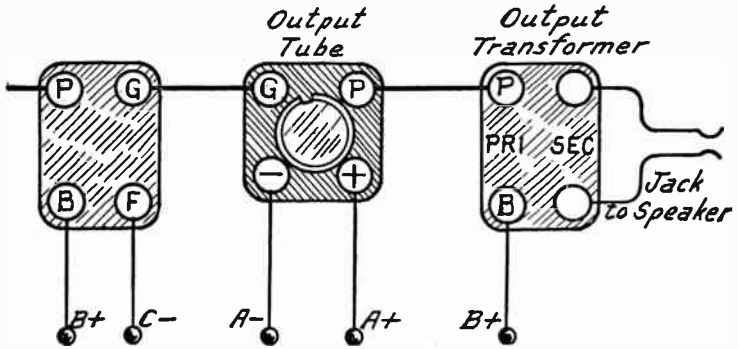

FIG. 8.—Connection of Output Transformer for Speaker.

Special output transformers are made with a one-to-one ratio, giving neither a step-up nor a step-down of voltage. The resistance in the windings of an ordinary amplifying transformer is too high to allow its satisfactory use as an output transformer. By selecting an output transformer whose one winding has an impedance matching the output impedance of the tube and whose other winding matches the impedance of the speaker remarkably good tone reproduction may be secured. See *Impedance, Matching of*.

Under the heading *Jacks and Switches, Uses of*, are shown various methods of cutting off and adding extra speakers and of operating a number of speakers from one receiver.

SPEAKER, LOUD, REQUIREMENTS FOR.—Any loud speaker must be used with due regard to the sound volume it is capable of producing without distortion and overloading. For example, a balanced armature type of speaker will generally handle considerably more power and will deliver greater volume without distortion than may be secured from an electromagnetic type. On the other hand, the electromagnetic type will often be found more sensitive to weak signals than the balanced armature type.

In a moderately large room the cone type speaker will deliver

SPECIFIC INDUCTIVE CAPACITY

more sound volume than the horn speaker except within a space directly in line with the opening from the bell of a horn.

The larger the horn, the longer and the wider at the mouth, the better it will deliver low notes and the less likely it will be to have points at which it is resonant to certain moderately high frequencies. Since a cone has a comparatively large vibrating surface it sets a greater amount of air into motion and inherently amplifies low notes better than they are amplified by a horn of any reasonable size.

Cabinet speakers are either of the horn type or the cone type, the cabinet acting simply as an enclosure for the horn or the cone.

In order for a good speaker to do good work it must be connected to a good audio frequency amplifier. A large cone speaker will rattle badly when connected to an amplifier having only a dry cell tube of the smaller size as an output tube, yet this is no fault of the speaker and is entirely the fault of the amplifier which is totally inadequate to meet the power requirements of the speaker. Storage battery tubes of the small amplifier type when operated with plate voltage below one hundred will be little better. Power tubes should be used to operate large speakers, especially if the speakers are of the cone type. If ordinary amplifier tubes are used for output, a horn speaker will generally be more satisfactory than a cone.

Speakers should be so placed in a room that there are no objectionable echoes produced by the walls of the room. A speaker of good quality placed in front of heavy draperies will sound better than when it is placed in front of a bare wall because the draperies absorb the sound that would be reflected by a wall. The tone quality of a powerful speaker will often be better when heard from an adjoining room than in the room occupied by the speaker.

For methods of testing speakers see *Oscillator, Audio Frequency, Uses of*. See also *Distortion*.

SPECIFIC INDUCTIVE CAPACITY.—Another name for dielectric constant. See *Constant, Dielectric*.

SPERM OIL.—See *Oils, Insulating*.

SPIDERWEB COIL.—See *Coil, Spiderweb Type*.

SPIRAL LOOP.—See *Loop, Spiral Type*.

SPLIT VARIOMETER.—See *Variometer, Split Type*.

SQUEALING.—The noise caused by heterodyne whistles or by free oscillation in a receiver. See *Oscillation*; also *Noise*.

S. S. C.—An abbreviation for single silk covered wire. See *Wire, Silk Covered*.

S. S. E.—An abbreviation for single silk enameled wire. See *Wire, Enameled*.

STABILITY.—Freedom from oscillation in the tuned circuits or other circuits of a receiver is called stability. See *Oscillation*.

STABILIZING.—The prevention of free oscillation in a receiver. See *Oscillation*.

STAGES OF AMPLIFIER.—See *Amplification, Cascade*.

STAND BY.—A phrase meaning to wait for further signals to come later on, keeping the receiver in operation and tuned to the same frequency in the meanwhile.

STATIC.—Static is a form of radio interference caused by electrical disturbances in the atmosphere. These disturbances may be comparatively violent, such as flashes of lightning, or they may be

STATIC

weak such as the gradual discharge between a cloud and the earth. But of whatever kind, they produce radio waves which travel to great distances and which are picked up by the antenna of a receiver just as any other radio wave would be picked up.

A static impulse has no particular frequency, therefore cannot be prevented from entering the receiver by any tuning means. The effect is that of shock excitation so that the receiver responds to static impulses when tuned to resonance at any frequency. See *Selectivity* for an explanation of shock excitation.

These static impulses are several thousand times as powerful as the impulses or waves coming from a distant station. Their average duration is about one five-hundredth part of a second.

Occasional loud crashes and intermittent rattling noises are caused by discharges of lightning, either near at hand or at great distances. When a storm is close enough to allow the lightning to make distinct impressions on the receiver and for the thunder to be heard, the distance of the flash from the receiver may be easily calculated. The speed of the radio waves from the flash is practically instantaneous while the sound of the thunder travels at only 1087 feet per second. By noting the number of seconds and fractions of a second between the sound of the static in the receiver and the sound of the thunder coming through the air, then multiplying 1087 by this number of seconds, the result will be the approximate distance in feet of the flash from the receiver.

Static is generally much worse during warm weather than in cool and it is worse around sunset than at other times of the day. Static that is characteristic of warm weather and changing weather consists of an almost continual series of crashing and grinding sounds, some being quite loud and others relatively weak.

Impending weather changes always cause considerable static. This is true when the weather is changing from warm to cold or when it is changing from cold to warm. When the weather is constant and undergoing no change there is comparatively little static, this being true whether the weather is exceedingly cold, exceedingly warm or anywhere in between.

When an electrical storm is gathering, the receiver will often give forth a continuous hissing sound caused by the steady electrical discharge passing through the antenna circuit to ground. Static may be quite bad during a snow storm as the minute electrical charges on the snow flakes are discharged through the antenna.

There have been many attempts to devise means for eliminating static impulses from the receiver circuits. So far none of them have been wholly successful. Those which have attained moderate success have been very complicated and add greatly to the cost and complication of the receiver.

Reducing the amplification or slightly detuning the receiver will generally lessen the ratio of static strength to signal strength and will give the effect of reducing the static. During periods of heavy static more enjoyment will be had if the loud speaker is placed in a room adjoining that in which the listeners are sitting.

STATIC LEVEL

A high resistance, one of 100,000 ohms or more, connected between the antenna and ground terminals of the receiver will bypass a greater proportion of static than signal because the signal frequency is the frequency at which the receiver circuits are resonant. This scheme gives the effect of reducing the static although it reduces the signal strength at the same time.

The most logical method of reducing the effect of static is increase of power used in broadcasting. If the signal strength can be made considerably greater than the static strength, then the amplification may be reduced while still giving a satisfactory signal.

STATIC LEVEL.—See *Level, Static*.

STATIONS, BROADCASTING.—See *Broadcasting*.

STATOR.—The stationary part of a variable condenser or variable inductance is called the stator of the device. The stator plates of a condenser are those which do not move as the condenser capacity is adjusted. The stationary winding of a coupler or variometer is called the stator winding. The stator of any unit is always connected to the high voltage side of the circuit containing the unit since the stator is not in contact with the control knob or dial touched by the operator's hand and is not directly affected by body capacity. See also *Rotor and Condenser, Connections to*.

STEEL.—See *Iron and Steel*.

STEP-UP AND STEP-DOWN TRANSFORMER.—See *Transformer*.

STOPPING CONDENSER.—See *Condenser, Stopping*.

STORAGE BATTERY.—See *Battery, Storage Type*.

STRAIGHT LINE CONDENSER.—See *Condenser, Straight Line Types*.

STRAIN.—The change of shape, size or form that is caused to take place in a substance by forces that are applied.

STRANDED WIRE.—See *Wire, Stranded*.

STRAY FIELD.—See *Field, Stray and Confined*.

STRAYS.—Another name for atmospheric disturbances or static. See *Static*.

STRENGTH, DIELECTRIC.—The ability of an insulating material or a dielectric to resist the passage of voltage through it is called the material's dielectric strength. It is measured by the number of volts required to break down the material and force a current to pass through. The general expression is in the number of volts required to break through a thickness of one mil or one-thousandth of an inch. The dielectric strength may also be expressed in the number of volts required to break through a thickness of one millimeter.

The conditions under which tests are made affect the results to such a great extent that values given for dielectric strength are always approximate only. The dielectric strength of insulators decreases very rapidly as the frequency increases. At audio frequencies the strength may drop to one-quarter or less of the value with direct currents.

STRENGTH, SIGNAL.—See *Range, Receiver; Sensitivity; also Volume*.

STRESS

STRESS.—The force which is applied to a substance and which tends to produce a strain in it.

SUB-PANEL.—A shelf-like support inside of a receiver's cabinet upon which and from which are supported various units such as tube sockets, resistors, coils, transformers and wiring. The sub-panel is horizontal or approximately so. See *Construction, Receiver*.

SULPHUR.—Ordinary yellow roll sulphur or melted and cooled flowers of sulphur make a rather useful insulator and supporting material for experimental work in radio. Sulphur melts at about 250° Fahrenheit and may then be poured into moulds of any required shape. Metal or other inserts may be placed in the moulds. The moulded sulphur may be machined with fair success and fairly coarse threads can be cut on its surface.

Sulphur has a dielectric constant of 2.5 to 4.0. It has low losses at radio frequencies and has high resistance, both volume and surface leakage being slight.

SUPERHETERODYNE RECEIVER.—See *Receiver, Superheterodyne*.

SUPER-POWER.—Comparatively large power used by a broadcasting station in its aerial. There are no definite limits between which a station's power is designated as super-power. However, super-power is generally accepted as being something in excess of 10,000 watts or ten kilowatts.

SUPER-REGENERATIVE RECEIVER.—See *Receiver, Super-regenerative*.

SURFACE LEAKAGE.—A leakage of current or voltage that takes place over the surface of insulation is called surface leakage as distinct from leakage that takes place through the body of the insulation which is called volume leakage.

SURGES, POWER LINE.—Sudden increases of current and voltage in a power line which give rise to electrical interference in receivers are called power line surges. See *Interference*.

SUSCEPTANCE.—A part of the admittance in a circuit, the remainder being conductance.

SWINGING.—A change in transmitted frequency.

SWITCH.—A device which will open or close a circuit or which will alter the connections between different parts and different circuits is called a switch. There are a number of different principles employed in the construction of switches and there are innumerable manufacturing variations introduced by makers of these units. The principal types are described in the following sections.

SWITCH, ANTENNA.—An antenna switch is a single-pole, double-throw switch connected to the antenna terminal of a receiver, to the antenna itself and to the ground as shown. The switch should be mounted vertically, with the antenna connected to the center, the antenna terminal of the receiver connected to the upper terminal and the ground and ground terminal connected to the lower end of the switch.

SWITCH, ANTI-CAPACITY TYPE

With the switch blade thrown to the upper position, the antenna connects through the switch blade to the receiver. With the switch thrown down, as is done during an electrical storm, the receiver is disconnected from the antenna and both antenna and receiver are grounded.

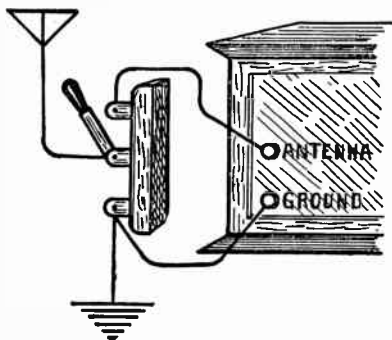

Antenna Grounding Switch.

SWITCH, ANTI-CAPACITY TYPE.—Any form of switch made with its metal poles and terminals well separated and with these metal parts made of small size is called an anti-capacity switch because the separation and the small size tend to reduce the capacity between the metal parts.

SWITCH, BATTERY OR FILAMENT.—The switch which connects the battery or other source of filament current to the filament circuit of a receiver, and which disconnects these parts from each other when the receiver is to be inoperative, is called a battery switch or a filament switch.

SWITCH, CAM TYPE.—A switch in which contacts are brought together or are allowed to separate by the action of a cam is called a cam switch. With the small lever pushed down, the cam turns on its pivot and closes the upper contacts while the lower ones are allowed to open. Cam switches are made with one or several sets of contacts which are operated simultaneously.

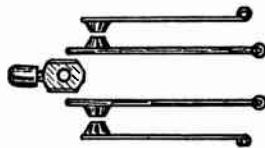

A Cam Type Switch.

SWITCH, DEAD-END.—A switch which connects more or less of an inductance coil into a circuit and which completely disconnects the unused portion of the coil is called a dead-end switch. Such a switch is shown in the diagram.

The coil is divided into several sections, wound together but with both ends of each section connected to the switch rather than to each other. The switch has one contact point attached to one end of the circuit and has a number of contact points, each one of which rests on two of the contacts at once, thus connecting the two together. All of the points move together but are insulated from one another.

SWITCH, DOUBLE-POLE

In the position shown the two sections of the coil toward its left hand end are connected in circuit while all of the remainder is disconnected. Were the switch to be moved one more notch to the right it would cut in one more

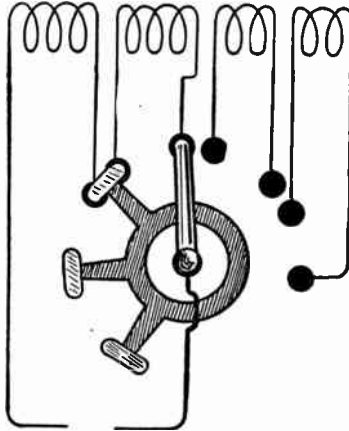

A Dead-End Switch.

coil section and would complete the necessary connections between all the coil sections then in use. Such a switch is advantageous when it is necessary to use a tapped coil winding.

SWITCH, DOUBLE-POLE.—Any switch that opens or closes two lines or both sides of a circuit at the same time is called a double-pole switch. The switch shown is a double-pole switch

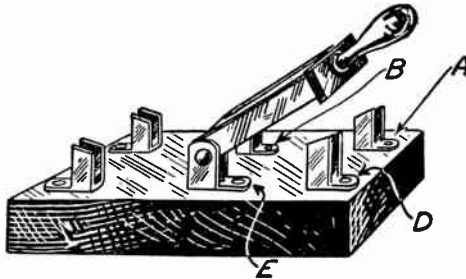

Double-Pole Switch.

since it connects or disconnects *A* with *B* and *D* with *E* with one motion of the switch blades which are mechanically fastened together but electrically insulated from each other. The abbreviation for double-pole is "D-P."

SWITCH, DOUBLE THROW.—A switch that may be thrown to either of two terminals.

SWITCH, FOUR-POLE.—A four-pole switch is a switch to which four lines may be connected as in the drawing. The switch has two positions. In the position shown by full line connections

SWITCH, GROUNDING

A is connected to *B* and *C* is connected to *D*. In the alternative position, shown by the broken lines, *A* would be connected to *C* and *B* would be connected to *D*.

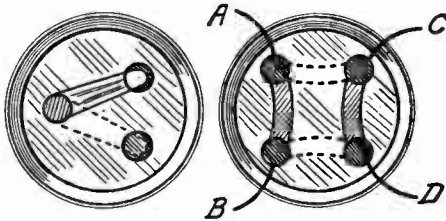

Double Throw Switch and Four-Pole Switch.

SWITCH, GROUNDING.—A switch used to connect an antenna or other circuit to ground is called a grounding switch. A lightning switch is one form of grounding switch.

SWITCH, INDUCTANCE.—An inductance switch is a switch used for cutting more or less of an inductance coil into a circuit. See *Switch, Dead-end*; and *Switch, Tap*.

SWITCH, JACK TYPE.—A switch whose general construction is similar to that of a jack. See *Jacks and Jack Switches*.

SWITCH, KNIFE.—A switch with long thin metal blades somewhat like the blades of a knife is called a knife switch.

SWITCH, LIGHTNING.—A switch used during lightning storms or electrical storms to ground the antenna so that electrical discharges coming through the antenna will be led to ground is called a lightning switch.

SWITCH, LOCKING.—A battery switch or filament switch that incorporates a lock which must be operated with a key to open or close the switch is called a locking switch.

SWITCH, POLE CHANGING.—A switch that connects one two-wire circuit to either of two other two-wire circuits is called

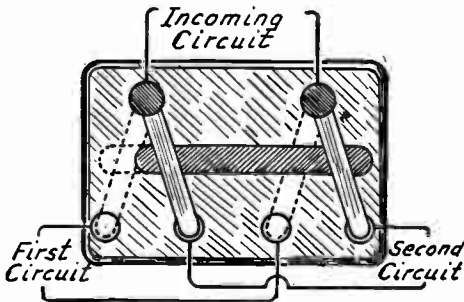

Pole Changing Switch.

a pole changing switch. The connections of one such switch are shown. It is a form of double-pole, double-throw switch.

SWITCH, SERIES-PARALLEL

SWITCH, SERIES-PARALLEL.—A switch that will connect two separate units either in series with a line or in parallel with the same line is called a series-parallel switch. One type is shown in Fig. 1.

The two units, which may be resistances, inductances, capacities or any combination of these, are shown as number 1 and number 2. The line enters the switch at the top and leaves from the bottom.

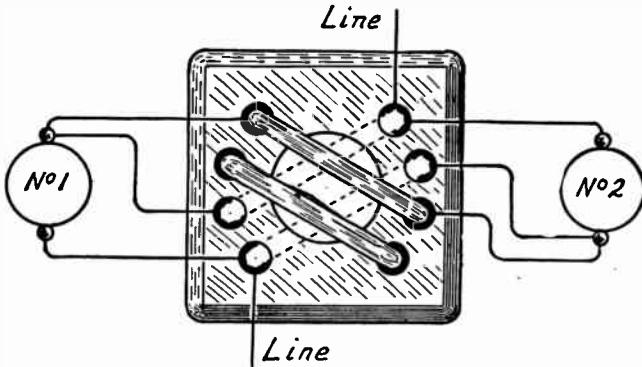

FIG. 1.—Special Form of Series-Parallel Switch.

In the position shown by the full line connections of the switch blades, the two units are in series with each other. The switch blades are fastened together mechanically but electrically insulated and they may be moved to the position shown by broken lines. In this broken line position the two units are in parallel with each other.

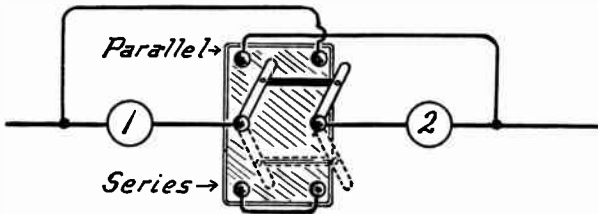

FIG. 2.—Double-Pole, Double Throw Switch with Series-Parallel Connections.

An ordinary double-pole, double-throw switch may be used as a series-parallel switch with the connections made as in Fig. 2. With the switch thrown to the top the units numbered 1 and 2 are in parallel and with the switch thrown to the bottom they are in series. Connections for a jack type switch used for series-parallel work are shown under *Jacks and Switches, Uses of*.

SWITCH, SINGLE-POLE.—A switch which opens or closes but a single line is called a single-pole switch. The abbreviation for this type is "S-P."

SWITCH, SNAP

SWITCH, SNAP.—A snap switch is a switch so constructed that upon moving its control knob or button a spring is first placed under tension while the contacts remain in their original position, either open or closed. When the spring has been given considerable tension the contacts are snapped by the spring into their other position. The object of this construction is to make a quick break of the circuit and thus avoid drawing an arc between the contacts as they separate.

SWITCH, TAP.—Any form of switch that connects more or less of an inductance coil, a resistance or a series of capacities into a circuit is called a tap switch. A tap switch used with a tapped inductance coil is shown. One side of the circuit is connected directly to one end of the coil while the other side of the circuit is connected to the switch arm. As the arm makes contact with successive tap points, a greater or less number of coil turns are included in the circuit. The unused portion of the coil forms an undesirable dead-end.

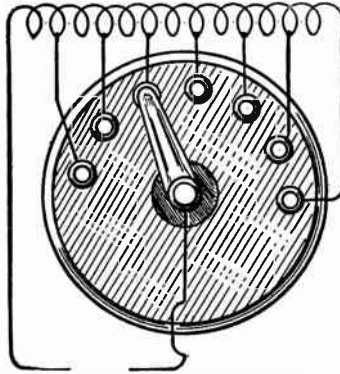

A Tap Switch.

SWITCH, THREE-POLE.—A switch having three sets of contacts so that it may be used to open or close three different lines simultaneously is called a three-pole switch.

SWITCH, THREE-WAY.—A switch that will connect one line to either one of two other lines is called a three-way switch.

SWITCH, TOGGLE.—A switch operated by a small lever or arm which springs the switch contacts into one position or the other is called a toggle switch.

SYMBOLS, RADIO AND ELECTRICAL.—A symbol as used in wiring diagrams is a sign or mark which in itself is simple and easily made, yet which represents a part or device which may be rather complicated in actual construction and which may be subject to wide variations in actual appearance and details of construction. The symbol stands for the idea or represents the principle which it is desired to illustrate.

The use of symbols greatly simplifies all kinds of radio diagrams, making it possible to easily trace the circuits all the way through the different parts. Such tracing would be absolutely impossible with actual pictures of the parts since only their outside terminals would be shown.

The use of symbols also makes the radio worker or constructor completely independent of any particular make or model of apparatus. A diagram or layout drawn with pictures or accurate representations of certain forms of the units can be used only with difficulty and uncertainty when other makes of units have to be substituted for those shown. Under the heading, *Amplifier, Audio Frequency* will be found diagrams with conventional symbols and pictorial representation of the same circuits.

SYMBOLS, RADIO AND ELECTRICAL

On the other hand, a diagram made with symbols for the parts is equally useful and valuable regardless of the particular type of parts selected, just so that they operate according to the principle indicated by the symbol.

In the illustration are shown nine different makes or styles of audio frequency amplifying transformers. They look quite different from one another, have different shapes and have their terminals placed differently. Yet each one employs an iron core, has one primary winding and a separate secondary winding with two terminals for each of the two windings. All nine transformers are shown by the symbol for an iron-core transformer drawn in the

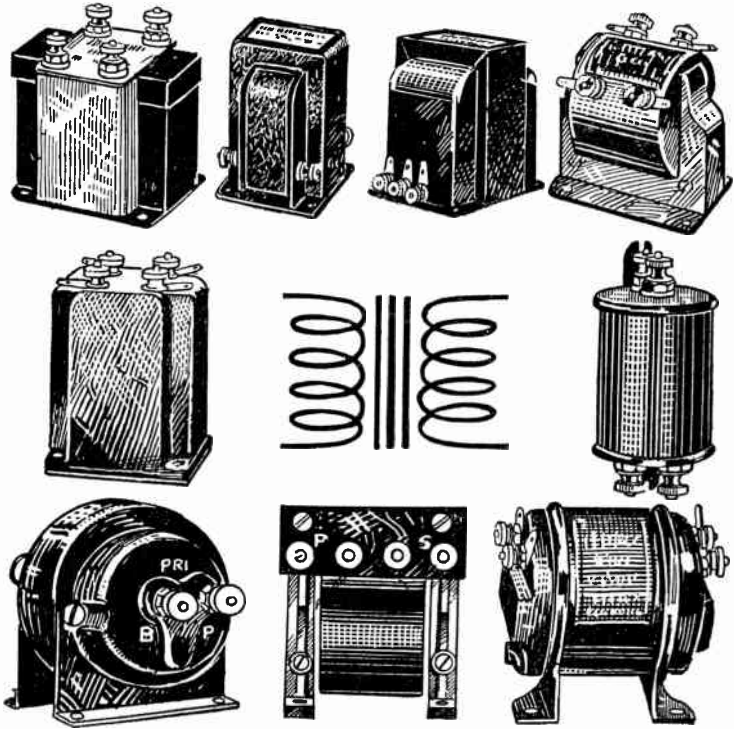

Various Audio Frequency Transformers and Their Common Symbol.

center. With a diagram containing this symbol the constructor knows without question that any one of the nine types shown or any other of the dozens of available iron-core audio frequency transformers may be used in the circuit.

All of the generally used and accepted symbols used in radio receiver work are shown by the drawings and with their use in circuit diagrams radio workers everywhere can gain a quick and comprehensive understanding of the exact workings of any piece of radio apparatus represented by the diagram.

It will be noticed that two or more symbols are given for some of the devices. Any of those shown may be used, the preferred form or the most generally used form being at the left in each case.

SYMBOLS



Ammeter



Antenna, open type

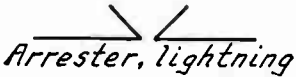

Arrester, lightning



Battery



Buzzer



Cell, battery

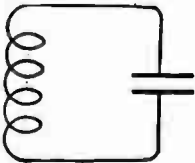

Circuit, oscillatory

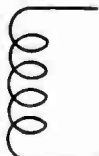

Coil, air core

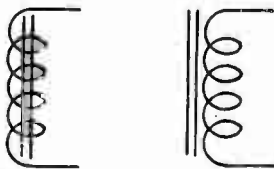

Coil, iron core or choke

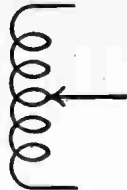

Coil, tapped

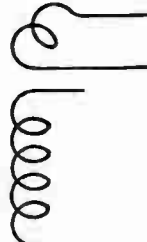

Coil with tickler



Condenser, fixed

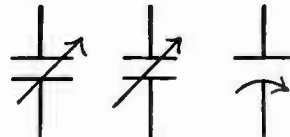

Condenser, variable

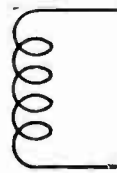

*Coupler, fixed
with primary and
secondary
windings*

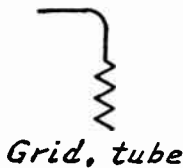
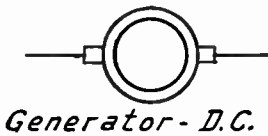
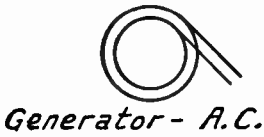
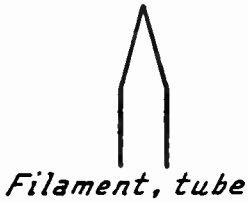
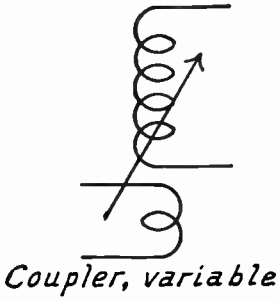

SYMBOLS

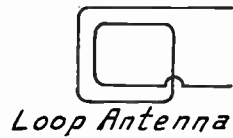
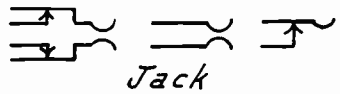
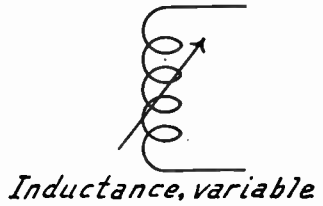
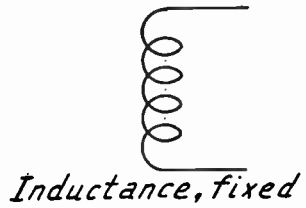
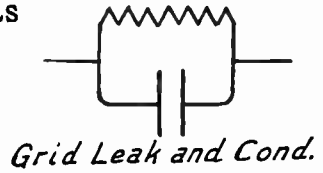

Negative

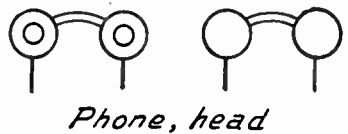

SYMBOLS

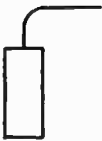

Plate, tube



Positive

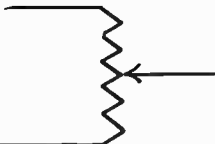

Potentiometer



Resistance, fixed



Resistance, variable



Rheostat



Speaker, loud

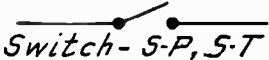

Switch- S-P, S-T



Switch- S-P, D-T

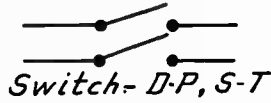

Switch- D-P, S-T



Switch- D-P, D-T

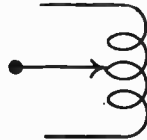

Switch, inductance

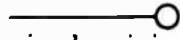

Terminal, wiring

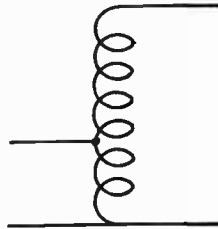

Transformer, auto-

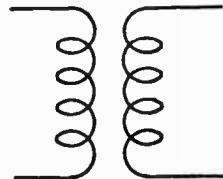

Transformer, air core

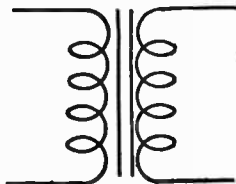

Transformer, iron core

SYMBOLS

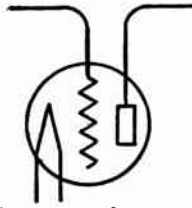

Tube, 3-element



Tube, 2-element

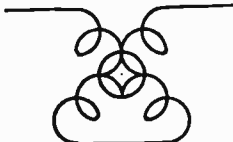

Variometer

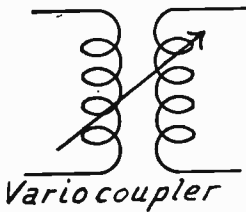

Variocoupler

Wire

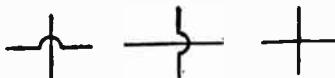

Wires not joined



Wires connected

Greek Alphabet.—The letters of the Greek alphabet are often used as symbols for various electrical values and quantities. The following are the capitals and small letters with their names as they sound.

alpha	Α	α
beta	Β	β
gamma	Γ	γ
delta	Δ	δ
epsilon	Ε	ε
zeta	Ζ	ζ
eta	Η	η
theta	Θ	θ
iota	Ι	ι
kappa	Κ	κ
lambda	Λ	λ
mu	Μ	μ
nu	Ν	ν
xi	Ξ	ξ
omicron	Ο	ο
pi	Π	π
rho	Ρ	ρ
sigma	Σ	σ
tau	Τ	τ
upsilon	Υ	υ
phi	Φ	φ
chi	Χ	χ
psi	Ψ	ψ
omega	Ω	ω

GREEK LETTER SYMBOLS

δ (delta)	logarithmic decrement
ε (epsilon)	base of Naperian logarithms=2.71828
θ (theta)	phase angle, phase displacement
κ (kappa)	constants
λ (lambda)	wavelength
μ (mu)	permeability; amplification factor
μf (mu)	micro as a prefix; = microfarad
ν (nu)	reluctivity
π (pi)	circumference ÷ diameter = 3.14159
ρ (rho)	volume resistivity
τ (tau)	time-phase displacement, time constant
φ (phi)	magnetic flux
ψ (psi)	phase difference, angular velocity
ω (omega)	2 × π × frequency

SYMBOLS

Symbols of Electrical Values.—Many of the letters of the English alphabet are commonly used and accepted as representing certain electrical values. These are used in formulas, equations and other expressions of the relations between the units. The following list shows the meaning of such symbols:

SYMBOLS FOR ELECTRICAL AND OTHER PHYSICAL QUANTITIES

<i>A</i>	area
<i>B</i> <i>b</i>	magnetic induction; susceptance in mhos
<i>C</i>	capacity in farads, microfarads, etc.
<i>c</i>	velocity of light
<i>d</i>	density
<i>E</i>	electromotive force (effective value) in volts
<i>e</i>	electromotive force (instantaneous value) in volts
<i>E_b</i>	voltage of B-battery or plate power supply unit
<i>E_c</i>	grid biasing voltage, C-battery voltage
<i>E_f</i>	filament voltage on tube
<i>E_g</i>	grid bias voltage acting on grid
<i>E_p</i>	plate voltage on tube
<i>F</i>	force
<i>f</i>	frequency
<i>G</i> <i>g</i>	conductance in mhos
<i>H</i>	magnetic field intensity
<i>h</i>	height
<i>I</i>	current (effective value) in amperes, milliamperes, etc.
<i>i</i>	current (instantaneous value)
<i>I_f</i>	filament current in tube
<i>I_g</i>	grid current in grid circuit
<i>I_p</i>	plate current
<i>K</i>	dielectric constant
<i>k</i>	coefficient of coupling
<i>L</i>	self-inductance in henries, microhenries, etc.
<i>l</i>	length
<i>M</i>	mutual inductance
<i>m</i>	mass
<i>n</i>	number; turns, revolutions, etc.
<i>P</i>	power (average value) in watts, etc.
<i>p</i>	power (instantaneous value)
<i>Q</i>	quantity of electricity in ampere-hours, coulombs, etc.
<i>R</i> <i>r</i>	resistance in ohms, etc.
<i>R_g</i>	grid resistance
<i>R_p</i>	plate resistance
<i>S</i>	surface or area
<i>T</i>	period of a complete oscillation
<i>t</i>	time
<i>V</i>	potential difference
<i>v</i>	velocity

SYNCHRONOUS

<i>W</i>	energy in watt-hours or joules; work
<i>X_x</i>	reactance in ohms
<i>X_C</i>	capacitive reactance in ohms
<i>X_L</i>	inductive reactance in ohms
<i>Y_y</i>	admittance in mhos
<i>Z</i>	impedance in ohms
<i>Z_g</i>	grid impedance in ohms
<i>Z_p</i>	plate impedance in ohms

SYNCHRONOUS.—Actions occurring at the same time and in the same way are said to be synchronous actions. Two electric currents having the same frequency and in phase with each other are synchronous currents. Two electric machines, when brought to the same operating conditions, are said to be synchronized.

T

t.—The symbol for time in seconds.

T.—The symbol for period or cycle.

T-ANTENNA.—See *Antenna, Forms of.*

TANTALUM RECTIFIER.—See *Charger, Battery, Electrolytic Type.*

TANDEM CONDENSER.—See *Condenser, Multiple Type.*

TAP, DRILL HOLES FOR.—See *Drilling.*

TAP SWITCH.—See *Switch, Tap.*

TAPPED COIL.—See *Coil, Tapped.*

TAPE, INSULATING.—Several different kinds of insulating tapes are used in electrical work. The most common is friction tape made of a fabric filled with rubber compounds in the better grades and with pitch and tar compounds in cheap grades. This tape makes fair insulation for low voltage conductors.

Tape is also made from varnished cloth cut into strips. This material has high insulating value but the spaces left between layers of the tape prevent the covering from being proof against moisture.

Rubber tape consists of a thin layer of soft rubber gum compound laid on a strip of varnished or oiled cloth. The rubber may be removed and used alone to make a close, weatherproof and moisture-proof insulating covering. A layer of this rubber tape covered with a layer of friction tape, the whole being then varnished, makes an excellent and permanent insulating covering for exposed wires and wire joints such as those in the antenna circuit.

TAPS AND DIES, THREAD CUTTING.—See *Tools*; also *Construction, Receiver.*

TELEGRAPHY, RADIO.—See *Radio Telegraphy.*

TELEPHONY, RADIO.—See *Radio Telephony.*

TELEPHOTOGRAPHY.—Radio or wire transmission of still pictures or photographs. See also *Television.*

TELEVISION.—Transmission and reception of images of moving objects sent through space by radio is called television. The television apparatus consists of a transmitter, often called the televisor, and the receiver. The transmitter radiates a high frequency carrier wave modulated by means of changes in light which have been made to affect electrical circuits. The television receiver separates the modulation from the carrier by detector action exactly similar to that used for reception of radio telephony. In the receiver's electrical circuits the modulation is translated into changes of light intensity which reproduce the image viewed at the transmitter.

At the top in Fig. 1 light reflected from an object passes through a lens to form an image. This image is scanned or is divided into numerous small parts, each having a degree of light or shadow corresponding to its position in the image. One at a time, these small parts of the image are allowed to affect a light-sensitive cell. This cell produces an electric current which is proportional to the intensity of the light falling upon it. The current from this cell

TELEVISION

actuates a radio amplifying tube which, in turn controls the modulation of a radio transmitter. The transmitter differs in no way from those regularly used for broadcasting.

At the lower drawing of Fig. 1 a radio receiver collects the signal and amplifies it. Instead of operating a loud speaker, this television receiver causes a television lamp to glow more or less brightly according to the received signal. The changes in light intensity are distributed over a screen with exceeding rapidity so that the eye sees them as a collection of lights and shadows which reproduce the original image. The eye retains its impression of the lights and shadows until the whole image is produced much as, in motion pictures, the eye assumes a continuous motion although it actually sees a series of separate pictures.

The Image and Its Illumination.—An image is defined as an optical counterpart of an object. An image is a picture formed by refraction of light rays passing through a lens or by reflection of

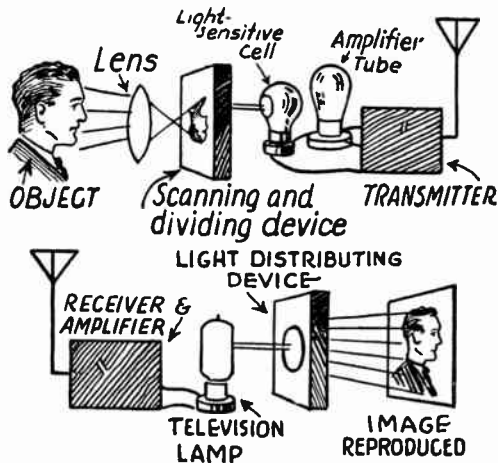

FIG. 1.—Elementary Principles of Television.

light rays from a mirror. The reflected or refracted rays, falling on a surface will produce an image on that surface. The visibility or brilliancy of the image depends on the brightness of the object in the first place. An object which is luminous in itself, such as a lamp, is easily seen as an image. If an object is not luminous it may be seen only by light reflected from it.

There are various methods of lighting the object. The lighting may be direct, may pass through a picture for example, or may pass around the object to form a shadow. A shadow or silhouette is not an image and the transmission of shadows does not constitute television. The lighting is said to be indirect when the sole source of illumination for the image is light reflected from the object. If the whole object is illuminated at one time the method is called flood lighting. If the object is lighted in only one small spot at a time by means of a beam of light traveling over the object the method

TELEVISION

is called spot lighting. Spot lighting allows a more intense light per unit of area than is possible with flood lighting.

Scanning.—The principle underlying all present methods of television is that of division of the image into small parts, each part consisting of an area reflecting or emitting more or less light. Transmission of varying degrees of light, representing the varying amount of light in successive small parts of the image makes television possible. If the small square opening in the upper left hand corner of the picture in Fig. 2 be moved in the direction of the arrow it will be possible to view or to scan the top strip, number 1 and it will appear as strip number 1 shown toward the right. If the square opening be then moved down the width of one strip and again moved across the picture it will scan strip number 2. This operation may be repeated until the whole picture has been divided into strips which will appear successively as numbered at the right hand side of Fig. 2.

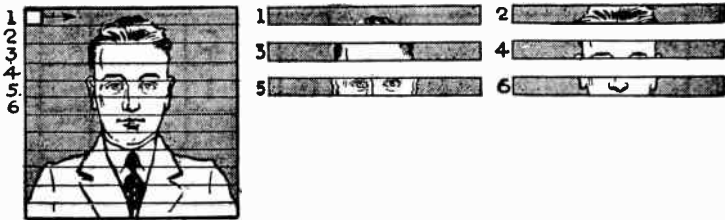

FIG. 2.—Division of Image for Television.

In the actual scanning of a picture the strips are very narrow. Each inch in depth of the picture is divided into twenty to one hundred of these narrow strips, the number depending on the exactness of detail required. Considering any one of these narrow strips it is found to be composed of a succession of parts which vary in the amount of light and shade or in the amount of light reflected by the image in the various parts. The next step in television is that of causing these variations in light to effect corresponding variations in an electric current. The changes in current or voltage modulate a radio transmitter and the changes in light are transmitted just as changes in sound are transmitted for broadcasting.

At the receiver, the changes in voltage or the modulation of the incoming signal is caused to change the amount of light from a lamp. This varying light from the television lamp is thrown onto a screen by sweeping it in the form of a beam across from one side to the other, then lowering it a little distance and again sweeping it across the screen. The strips of Fig. 2, which consist of varying amounts of light, are thus reproduced at the receiving end as varying amounts of light in certain definite positions on a screen, this making up the complete picture.

The human eye retains an impression for something more than one-tenth second. If all of the strips composing a complete picture are thrown onto a screen in less than one-tenth second, the eye will be impressed by the last before the first disappears and will see them as a complete picture. It is customary in television for fifteen images to be completed in each second.

TELEVISION

This means that the travel of the scanning device must be at such a rate that it moves over the whole image and forms all the strips from top to bottom within one-fifteenth second. A succession of complete images at the rate of fifteen per second will give the eye the impression of a continuous picture and if the position of objects changes between one image and those following, the eye will have the impression of motion of the objects. The same principle is utilized in the production of motion pictures.

Scanning of the image may be accomplished in two fundamentally different ways. One way, illustrated by Fig. 2 and shown at the left in Fig. 3, causes a spot of light to travel over the image and to be reflected onto a single light-sensitive cell. The second method, shown at the right in Fig. 3, divides the image into many small sections and provides a separate sensitive cell for each division. The cells then act, one after another, until the whole image has been scanned. In all scanning, the rule is to commence at the upper left hand corner, work toward the right and downward in exactly the same manner that a page of print is read.

Frame, Lines and Pictures.—The actual area scanned is called a frame. The picture in Fig. 2 is a frame. The number of lines into which the frame may be divided is affected by several factors, chiefly by the action of the eye. Although the eye will retain an

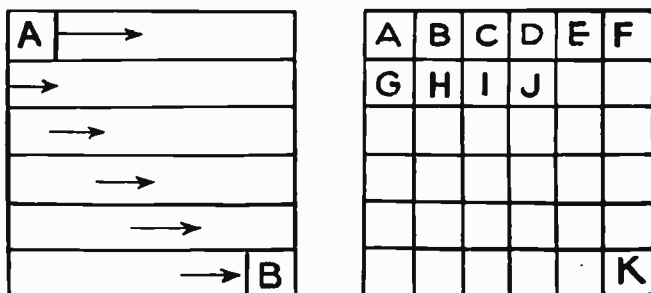

FIG. 3.—Two Types of Scanning.

image for a considerable period of time, the light must act upon the eye for a least $1/500,000$ second or there is no impression registered. The impressions reaching the eye may be considered as the sections or divisions of a frame, such as those marked *A*, *B*, *C*, etc. in Fig. 3. Even with continuous strips as in Fig. 2, the eye must be affected by a series of changes.

Assuming that there are to be fifteen complete pictures per second, each complete picture is allowed but 0.067 second for completion. Since each section of the picture must last at least $1/500,000$ or 0.000002 second, a simple division shows that the maximum number of sections is 33,500. As may be seen in Fig. 3, the whole image or frame is square, so the square root of the whole number of divisions will give the allowable number of lines or strips. The square root of 33,500 is approximately 183, this being the maximum number of lines in the whole frame or image.

The detail which may be shown in a picture depends on the number of lines to the inch. A picture having fifty lines per inch is shown in Fig. 4 and one having eighty lines per inch is shown in Fig. 5. With fifty lines per inch the whole frame could be 183 divided by 50, or 3.66 inches square. If a

TELEVISION

better reproduction is demanded and eighty lines per inch are used the frame could be only 2.29 inches square. The greater the detail and the better the reproduction, the smaller must be the picture. In practice it is not possible to have 183 lines per frame because of limitations in the apparatus. One suggested standard proposes forty-eight lines per frame.

Scanning Discs.—Most television methods used at present utilize mechanical methods for scanning the image and for reproducing it at the receiver. With moving mechanical parts it is difficult to secure the desired speed of action and it is difficult to confine



FIG. 4.—Appearance of Image with Fifty Lines per Inch.



FIG. 5.—Effect of Using Eighty Lines per Inch.

the apparatus within a reasonable space. There are methods, to be described later, which use no moving mechanical parts.

The foundation of the mechanical methods for dividing an image is the Nipkow disc, dating from 1884. There are many variations in disc design, one generally adopted style being shown in Fig. 6. A series of holes is laid out on a spiral. A beam of light passes through hole number 1 and strikes

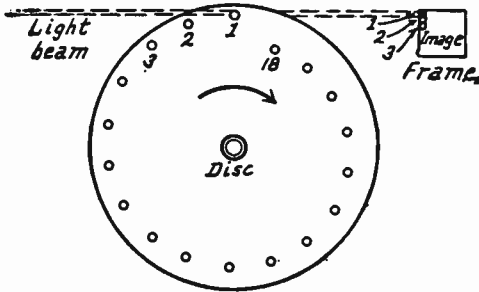

FIG. 6.—Action of Scanning Disc.

the image as indicated. As the disc is revolved in the direction of the arrow near its center, the spot of light passing through hole number 1 will travel across the image from left to right and at the upper edge of the frame. Just as the spot of light from hole 1 passes off the right hand edge of the frame, a similar spot of light coming through hole 2 enters the frame at the left and travels across in a path just below that followed by the first beam. A light spot from hole 3 follows and so on for all the holes in the disc until the spot from hole 18 travels across the lower edge of the frame, to be immediately followed by a spot from hole 1 again. Thus, for each revolution of the disc, the image is completely illuminated once. There will be as many complete

TELEVISION

illuminations and complete pictures or images per second as there are revolutions of the disc in one second. There will be as many lines of light drawn across the frame as there are holes in the disc. Thus for fifteen frames or pictures per second there must be 900 revolutions per minute of the disc.

Television pictures have been transmitted at varying numbers per second. Ten pictures call for 600 R.P.M. of the disc, fifteen pictures call for 900 R.P.M., sixteen pictures require 960 R.P.M., 17.7 pictures require 1062 R.P.M., and twenty-one pictures require 1260 R.P.M. as the disc speed. These are some of the practices followed.

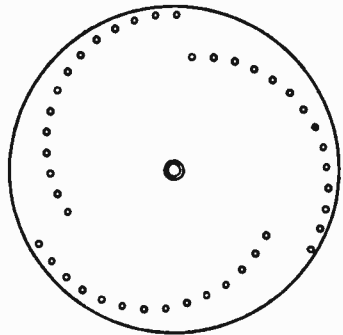
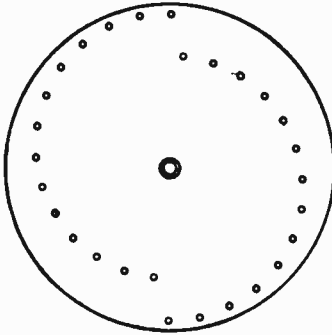

FIG. 7.—Disc with Two Sets of Holes. FIG. 8.—Three Sets of Disc Holes.

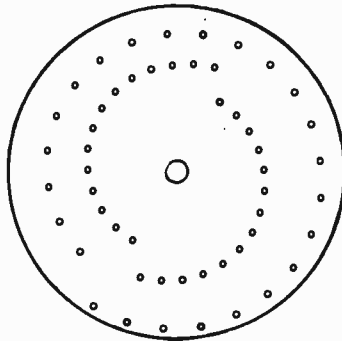

FIG. 9.—Single Disc To Receive Two Different Numbers of Lines.

There is also a variation in the number of lines per frame and the corresponding number of holes per disc. Transmission has been carried out with 24, 36, 45, 48, 50 and 60 hole discs for the corresponding number of lines per frame.

It is possible to arrange the holes in two or more spirals with a consequent reduction of disc speed. In Fig. 7 the disc has two spirals, each one of which completely scans the image. Consequently the disc need travel at but half the speed needed with all the holes for one scanning arranged in a single spiral. In Fig. 8 is a disc with three spirals which need rotate at but one-third the speed of a disc with one spiral. A single disc may operate with

TELEVISION

either of two numbers of lines per frame if built as in Fig. 9 with the holes for one number in a single spiral all the way around the disc and the holes for a smaller number of lines arranged in two spirals, each extending half way around the disc.

The frame, which is the total area scanned, will always be as wide as the distance apart of the two adjacent holes in the spiral since the light beam from one hole must enter the frame as the beam from the preceding hole leaves it. The height of a frame or picture from bottom to top is equal to the pitch of the spiral or the difference between the distances of the first and last holes from the disc center. The frame will be slightly narrower at the bottom than at the top because the holes are slightly closer together at the inner end of the spiral.

In some discs the holes are made circular and in others the holes are square or rectangular. The distribution of light is more even with the rectangular holes and there are fewer dark streaks across the reproduced picture. The diameter of a circular hole or the distance across a rectangular one is equal to the height of the frame divided by the number of lines in the frame, or slightly larger if anything. This dimension allows the light from each hole to come to the edge of the light from the adjacent hole either way, or to overlap slightly.

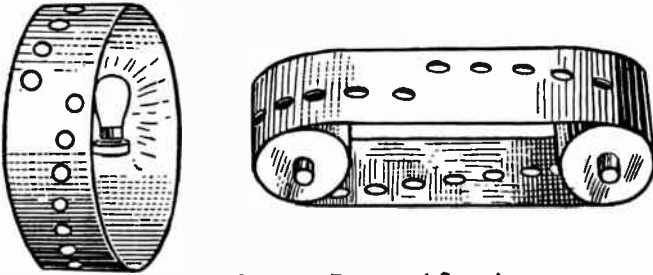

FIG. 10.—Scanning Drum and Scanning Belt.

The longer the light beam is allowed to rest on one portion of the image the greater the illumination and brilliancy appears to the eye, therefore, a low disc speed allows a brighter picture. Since a greater amount of light comes through a large hole than a small one, the fewer the lines and the larger the disc holes the better will be the illumination but the poorer will be the detail because of the reduced number of lines.

In addition to the flat discs which have been illustrated, others are made in the form of a drum with the holes spirally arranged in the circumference and with the source of light at the center. A traveling belt with holes on slanting lines has also been used for scanning the image. Both ideas are shown in Fig. 10.

Television Methods.—One method of using the disc for scanning an object is shown in Fig. 11. The disc is driven by an electric motor and is placed between the object and a powerful source of light. A beam of light is directed by the holes in the disc over the whole surface of the object. At any one instant the only portion of the object being illuminated is the spot which is being struck by the light beam. Light is reflected from any illuminated object, the amount of light being proportional to the color or shading of the object. Therefore, the amount of light being reflected from the ob-

TELEVISION

ject at any one instant depends on the color of the shadow on the spot being illuminated. The reflected light enters a photo-electric cell as shown. The photo-electric cell has the property of translating light into electric voltage and of translating varying light into varying voltages. The small changing voltage from the photo-electric

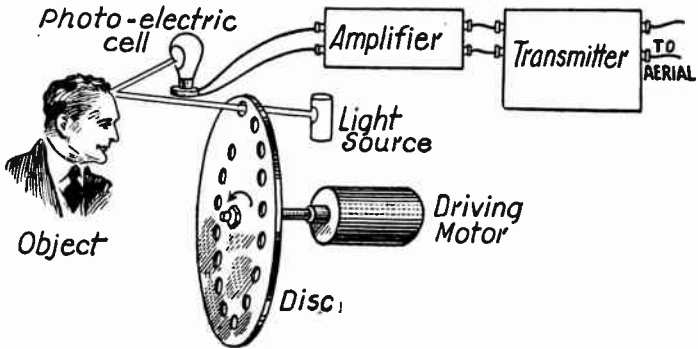

FIG. 11.—Scanning At the Televisor.

tric cell is carried to a low frequency amplifier where it is impressed on the grid circuit of the first tube. The amplifier steps up the voltage so that the changes may be used to modulate the carrier wave of a transmitter. This, briefly, is the operating principle of one of the simplest televisors.

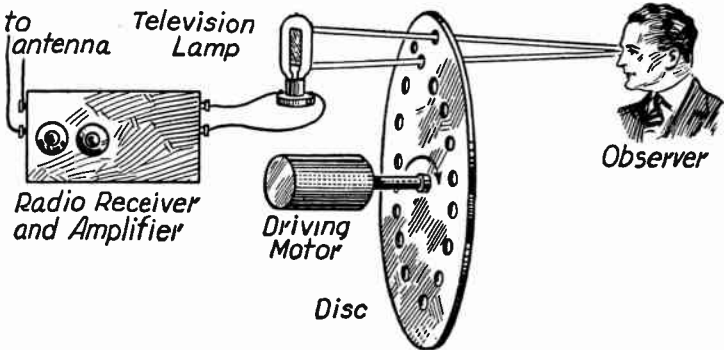

FIG. 12.—Reproduction At the Receiver.

The amplifier is exactly similar to almost any of the devices described under *Amplifier, Audio Frequency*. The resistance coupled type or the transformer coupled type may be used. Modulation of the transmitter is explained under the head of *Modulation*.

A receiver for use with the televisor of Fig. 11 is shown in Fig. 12. The modulated carrier wave is taken into a radio receiver, amplified at radio fre-

TELEVISION

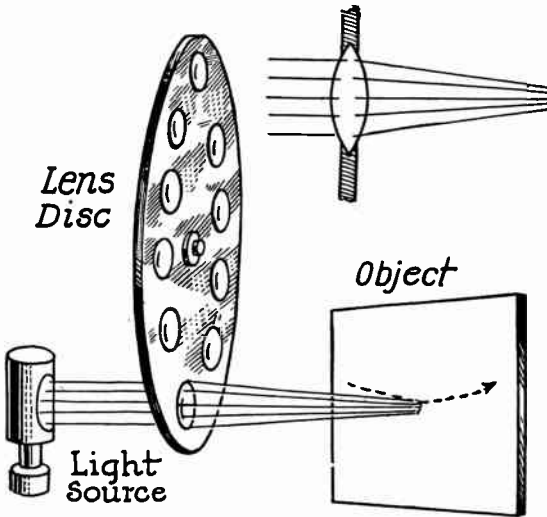

FIG. 13.—Concentration of Light with Lenses in Disc.

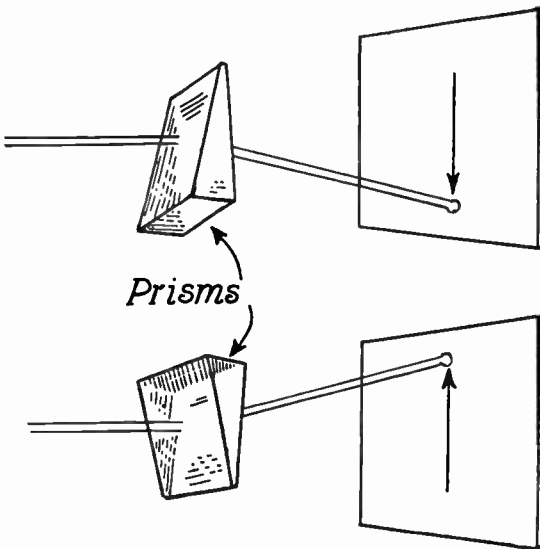

FIG. 14.—Bending of Light Rays with Prism.

TELEVISION

quency, passed through a detector to separate the low frequency modulation, again amplified at the low frequency and the current changes which would, in broadcast reception, operate the loud speaker, now affect a television lamp. This lamp increases and decreases its brilliancy instantly in response to changes in the incoming modulation, growing brighter when more light reaches the photo-electric cell of Fig. 11 and growing dimmer when the light to the photo-electric cell decreases. The luminous portion of the lamp consists of a flat plate.

In front of the television lamp is a disc exactly similar to that used with the transmitter. The observer looks through the holes in this disc at the television lamp. The two discs, transmitting and receiving, are alike, are driven at the same speed and have a hole of given position on one disc at the

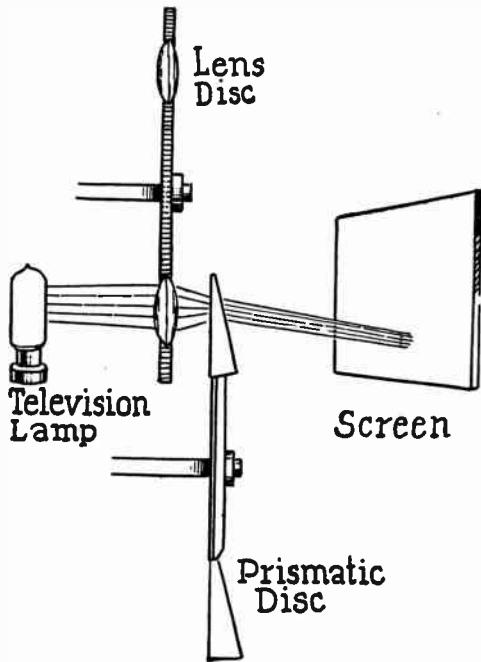

FIG. 15.—The Jenkins Scanning System.

same place each instant as the corresponding hole in the other disc. Therefore, the observer sees a series of light changes which appear to be disposed on the lamp's plate as are the corresponding degrees of illumination on the object being scanned at the transmitter. The rapid changes in light and in position appear to the observer as a picture. As the object moves, the picture at the receiving end of the apparatus appears to move in the same manner.

In place of using holes through the disc, many kinds of apparatus utilize lenses while still others make use of mirrors. The use of lenses in the Jenkins system is illustrated in Figs. 13 to 16. One disc carries a number of lenses around its circumference as in Fig. 13. The lenses are of the convex or condensing type, taking light

TELEVISION

from the source and focusing it into a spot. Rotation of the disc causes the spot to travel across the object to be scanned as shown by the arrow.

To make the light spot move up and down the beam is passed through a prism as in Fig. 14. A prism, or triangular lens, will cause a light beam to bend downward when the narrow side of the prism is upward and will cause the beam to bend upward when the prism is reversed. The Jenkins prismatic disc, shown in Fig. 15, has one continuous glass band around it. On one side of this disc the glass is thin toward the outside and on the opposite side the glass is thick toward the outside. Rotation of this disc causes the light beam to pass through a gradually changing prism which is first of one form, as at the top of Fig. 14, and then of opposite inclination as at the bottom of Fig. 14. The result is that the light beam moves up and down.

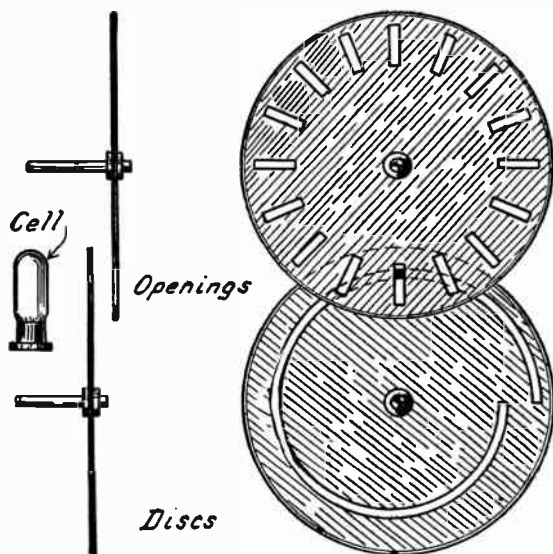

FIG. 16.—The Baird Scanning Discs.

As each lens of the lens disc draws its light beam across the frame one line or strip is scanned. Each time the prismatic disc makes one revolution the light beam moves from top to bottom of the frame and completes one picture. At the transmitting end the light beam travels over the object, the reflection actuating the light-sensitive cell. At the receiver, the varying light from the television lamp is distributed over a screen by the action of the discs to complete the pictures.

The chief points in the Baird system are shown in Figs. 16 and 17. The object is strongly illuminated and the reflected light passes through a structure of parallel tubes which insures that all light rays passing through remain parallel on their way to the scanning or image dividing discs. There are two discs, one having a number of radially arranged slots and the other having a single spiral slot.

TELEVISION

The action of the two Baird discs is shown in Fig. 17. The radially slotted disc rotates rapidly so that light beams coming through it are swept across from side to side. The disc with the spiral slot revolves once for each complete frame or picture, gradually moving the light beams from top to bottom of the frame. The action of the disc with radial slots is similar to the Jenkins lens disc, while the action of the Baird spirally slotted disc is similar to that of the Jenkins prismatic disc. At the transmitting end of the Baird system the light passing through the tubes and the discs affects a photo-electric cell.

Since the Baird system uses flood lighting of the object to be scanned there would be an amount of steady light of such intensity as to be uncomfortable to a living subject. To overcome this trouble illumination is made with invisible infra-red rays rather than with visible light. The infra-red rays affect the photo-electric cell in the same way that visible light would affect it. The object at the transmitting end is, to human eyes, in total darkness. At the receiving end the picture appears illuminated.

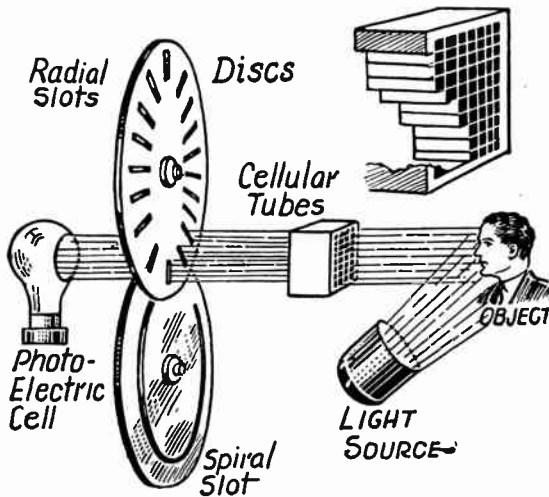

FIG. 17.—Action of the Baird Discs.

A method of moving the light beam with the aid of a mirror is shown in Fig. 18. A beam of light from a source strikes a mirror and is reflected onto the object, if at the transmitter, or onto a screen if at the receiver. The mirror is mounted so that it may be tilted back and forth to throw the beam up and down, also so that it may be twisted from side to side to throw the beam across from left to right. Magnet *A* twists the mirror to move the beam in path *A-A*. Magnet *B* tilts the mirror so that the beam moves from the top of a frame downward along line *B*.

There must be one complete swing of the beam across line *A-A* for each line or strip in the frame while there is a single movement from top to bottom on line *B* only once for each frame. Therefore, magnet *A* is actuated by current at a frequency corresponding to the number of lines per frame while

TELEVISION

magnet *B* is actuated by current of a frequency corresponding to the number of pictures or frames per second.

With the arrangement of Fig. 18 the receiver contains a television lamp from which the varying light is thrown onto the mirror by the lens. At the transmitter, light from a source is thrown onto the mirror and then reflected onto the object to be scanned. As with most other methods, the transmitting

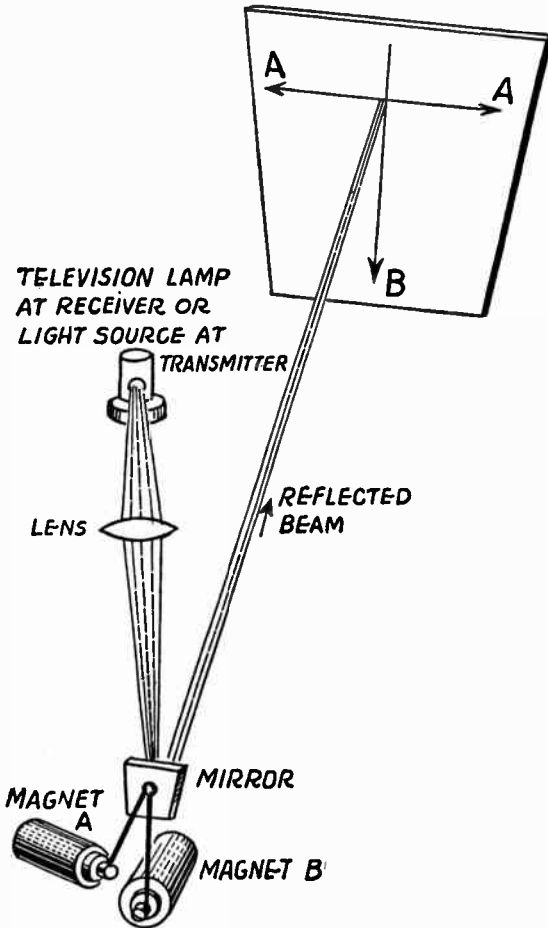

FIG. 18.—Use of Mirror for Scanning.

and receiving ends are alike so far as handling the object, image and scanning are concerned. The actions of similar parts are reversed at the two ends.

The principle of a Bell Laboratory development is shown in Fig. 19. The incoming signal is amplified in the usual way but instead of its operating a television lamp from which the light is distributed

TELEVISION

as a single beam, connection is made through a commutator to a screen composed of tubing filled with neon gas which becomes luminous with passage of electricity through it.

The amplifier output circuit passes to the revolving brush, into the commutator segment on which the brush rests, through a wire attached to this segment and to one of the many small metallic plates attached to the back of the gas-filled tubing. The current enters the tubing at this point and the gas near the metallic plate becomes luminous. The circuit is completed through the body of the tubing back to the amplifier. As the brush moves around the commutator, connection is made successively with all the metal plates on the tubing. If no current is flowing during any particular contact, the gas in front of that plate does not light up. If current is flowing the gas becomes luminous to a degree corresponding to the current intensity. The brush moves over the commutator in step with a similar arrangement at the transmitter

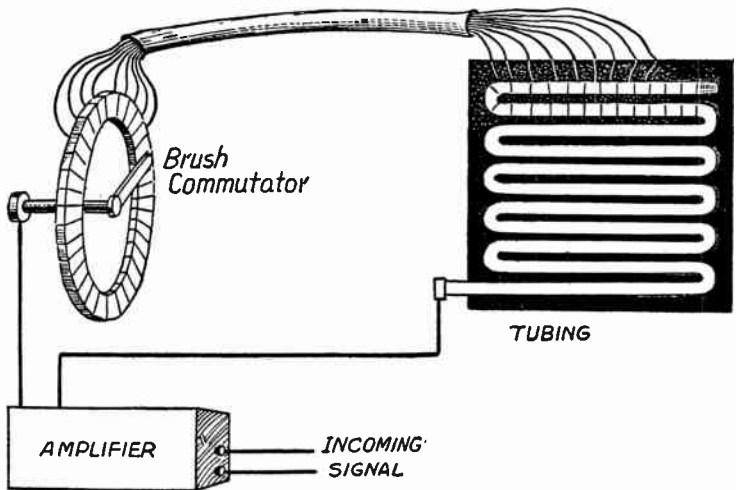

FIG. 19.—Illuminated Screen for Reproduction of Image.

so that current changes from a light sensitive cell at the transmitter are reproduced as light changes in the tubing. Distribution of the light in the tubing reproduces the picture being transmitted.

Light.—Much of the work in television has to do with light, its action and its effects. Ordinary white light is formed by the combination of many wavelengths or frequencies of vibration. The shortest wavelength is about 3.9 ten-thousandths of a millimeter and produces violet light. Then, in the order of increasing wavelengths, the colors of the spectrum are: indigo, blue, green, yellow, orange and finally red with a wavelength of about 7.6 ten-thousandths of a millimeter. These wavelengths fill in the frequencies between about 770 million-million cycles and 400 million-million cycles per second. Frequencies higher than that of the violet end of the spectrum are said to be the ultra-violet rays while those just below the red end

TELEVISION

are called infra-red rays. The eye is sensitive to all the wavelengths from violet to red but is most sensitive in the neighborhood of a wavelength of 5.6 ten-thousandths of a millimeter, this being a yellow-green light. The eye's sensitivity to this wavelength is about two and one half times its sensitivity to white light.

Light waves may be bent in their course or may be subjected to other physical effects. The rays may be reflected, as from the surface of a mirror. These rays may be bent by a prism or refracted by a lens so that they come toward each other or spread apart. Another effect is called dispersion, by which rays of differing frequencies or wavelengths are separated from each other. Dispersion of sunlight is often accomplished by prisms of glass so that the rainbow's colors appear. Two light rays coming together may cause interference and may produce new colors or even darkness. The combination of red light and green light produces yellow light; red and blue will produce purple; while red, green and blue will produce white or gray light. The effects of interference are used in color television when the object is scanned with green, blue and red lights which are separately transmitted and combined at the receiver to make all the natural colors and shades.

Light may be polarized or directed in a definite direction or plane either by reflection or refraction. Many of these actions of light rays are utilized in television.

Practically all materials reflect at least some of the light rays which strike against them. Ordinarily, when the source of light is removed, the object is no longer visible but some materials have the property of phosphorescence by virtue of which they emit light rays for some time after having been struck by such rays. A phosphorescent object will glow in the dark after having been illuminated. Still other materials have the property of fluorescence by which they are enabled to emit light when struck by the cathode rays. Fluorescence is used in observing the shadows cast by the X-rays.

Photo-electric Cells.—The modern photo-electric cell has done more than any other one thing to advance television. In the earliest attempts cells of the metal selenium were used, but with little satisfaction. Selenium has the property of changing its electrical resistance under the action of light but the changes are entirely too slow for the work of scanning.

Certain metals, those of the alkali group, have the property of producing electricity when struck by light waves. These metals include sodium, potassium, lithium, rubidium and cesium. All are soft, light in weight and are of silvery-white color. The photo-electric tube is highly evacuated in some types while in others the air is withdrawn and replaced with certain amounts of hydrogen, argon, neon or helium gas. The interior of the bulb is coated with a deposit of metallic silver over all its surface except a small round window through which the energizing light is to enter. The general form of one type is shown in Fig. 20.

A part of the interior wall of the cell is coated with a finely divided form of one of the alkali metals mentioned or with one of their compounds. This coated portion forms the cathode of the cell and is given a negative charge. Between the window and the cathode is placed a ring, a long wire, a piece of gauze or some other conductor which acts as the anode and which is positively charged. Light coming through the window and striking against the cathode causes emission of negative particles of electricity or electrons. These electrons are attracted to the anode by its positive charge and form the

TELEVISION

electron flow or current from the cell. The amount of electron flow increases with increase in light intensity and should cease when no light enters the cell.

Any current which flows when no light is admitted is called the "dark current" or leakage current. Its existence is a disadvantage since it reduces the total change of voltage or current with a given change of light. Leakage current is reduced by the employment of two guard rings, one inside the cell and the other outside, placed between anode and cathode.

The vacuum cell is less sensitive than the gas filled type, delivering but the hundredth part of a microampere even with fairly strong illumination. In the vacuum cell the current is more nearly in direct proportion to the light and the action is somewhat more dependable than that in the gas cell. Current from the vacuum cell increases slowly and gradually with increase of voltage applied between anode and cathode until practically all the electrons emitted by the cathode are drawn to the anode. This is indicated in Fig. 21. At this

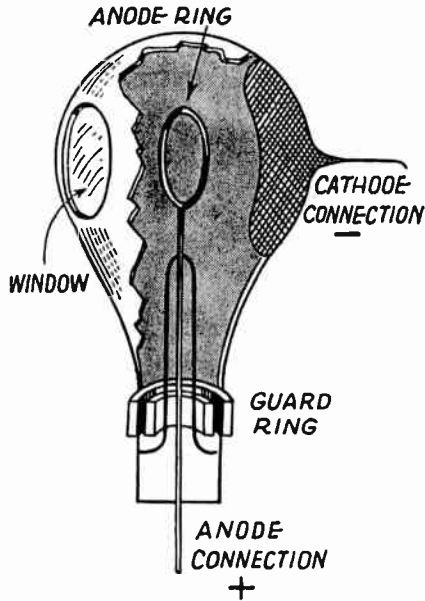

FIG. 20.—A Photo-electric Cell.

point the cell is being operated at the saturation voltage and further increase of voltage has little effect on the current. Thereafter, change of current is caused by changes in light intensity. In general, the sensitivity of this cell increases with increasing frequency of the light, usually being greatest at the violet end and least at the red end of the spectrum. The frequency or color to which the cell is most sensitive depends on the metal used at the cathode.

In the gas filled cell, sensitivity is increased to many times that of the vacuum cell by partial ionization of the gas. In ionization the gas atoms are disrupted by collision, producing additional electrons which separate from their atoms and pass to the anode. In this cell the current increases more and more rapidly with a steady increase of applied voltage as indicated in Fig. 22 until a point is reached at which the gas commences to glow due to the amount of ionization. The cell is always operated below this point of ionization.

TELEVISION

Nearly all systems of television require the use of one or more photo-electric cells at the transmitting end. It has been mentioned that the current and voltage from such a cell are exceedingly small and require considerable amplification before they may be used for modulation of a carrier. A schematic diagram of a commonly used

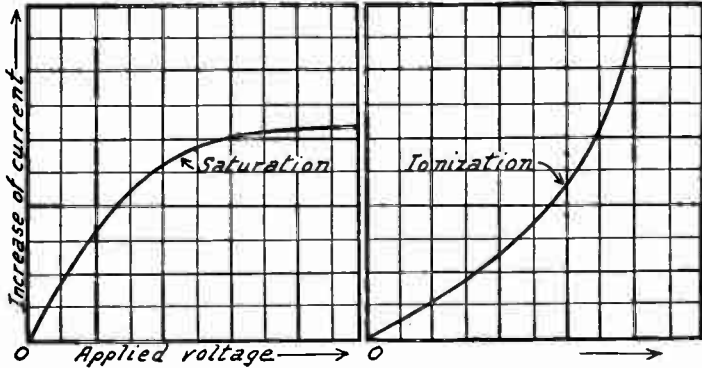

FIG. 21.—Action of Vacuum Cell. FIG. 22.—Action of Gas Filled Cell.

circuit is shown in Fig. 23. The cell circuit is from the positive side of the battery to the anode of the cell, then to the cathode, through the resistor R and back to the negative side of the battery. This connection maintains the anode at a positive potential with reference to the cathode.

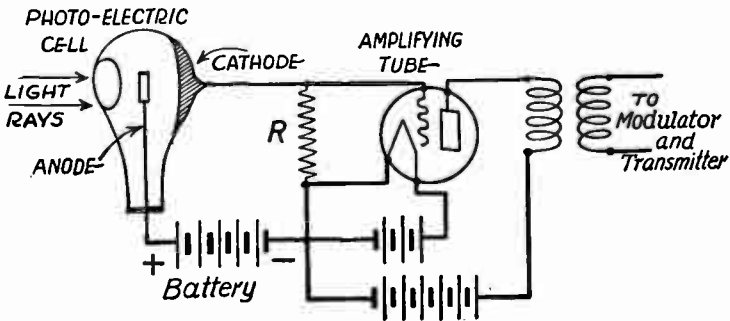

FIG. 23.—Connection of Photo-electric Cell To Amplifier.

Light rays entering the cell cause an emission of electrons from the cathode and they are attracted to the positively charged anode. The electron flow is through the battery and the resistor R back to the cathode. Electron flow or current flow through the resistor causes a voltage drop between its ends, the voltage varying according to the amount of emission in the photo-electric cell as produced by varying amounts of light. Resistor R is also connected between

TELEVISION

the grid and filament of the amplifying tube so that voltages across the resistor are impressed on the grid circuit. In the plate circuit of the tube appear amplified corresponding voltages which are carried through additional stages of amplification to the modulating system of the transmitter.

The electron emission of the photo-electric cell corresponds exactly to the amount of light only for comparatively small total amounts of light in the cell. Too much light results in variations of current that are not exactly proportional to equal changes in light intensity.

Television Lamps.—The source of varying light at the receiver is generally a lamp containing two plates, at least one of which is flat, and in the bulb of which the air has been replaced with neon gas. The device is often called a neon lamp or a glow tube.

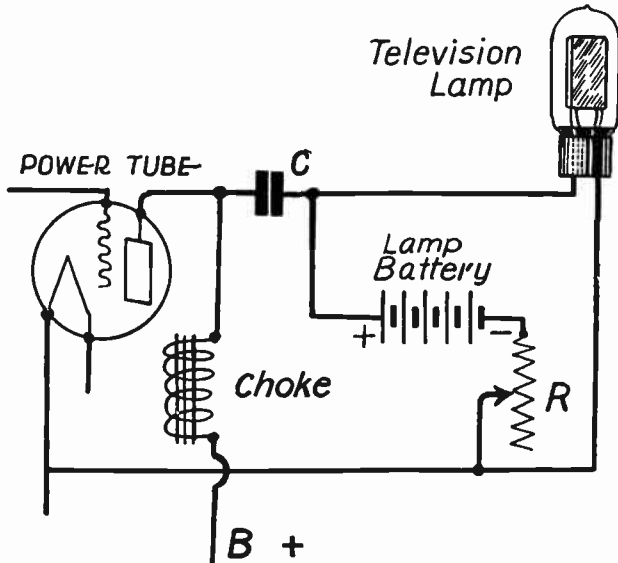

FIG. 24.—Connection of Television Lamp to Receiver.

Current for the plate circuit of the final amplifying tube or the power tube in the receiver passes through the neon lamp and in passing causes one of the plates to glow with a pale pink light. Passing direct current through the lamp causes only one of the plates to glow, while passing alternating current through it causes both plates to glow.

A typical circuit for the lamp as usually connected is shown in Fig. 24. The battery or power unit, of 180 to 250 volts, maintains a steady flow of current through the lamp, this current having a value of between ten and twenty milliamperes which is sufficient to maintain a glow on one of the plates. Steady direct current for the plate of the amplifying tube is furnished through the choke coil. Variations of plate current which, in audio amplification, would operate the loud speaker are here carried through the condenser *C* and

TELEVISION

to the filament circuit of the amplifying tube by passing through the television lamp. The variations of voltage in this part of the amplifying tube's plate circuit are added to or subtracted from the steady current maintained through the glow tube so that the illumination of the plate in the television lamp increases and decreases its intensity according to the signal variations from the power tube.

In series with the battery which supplies lamp current is an adjustable resistor of about 10,000 to 50,000 ohms maximum value. When the lamp is to be placed in operation, this resistor is set at maximum value and the resistance then reduced until the lamp barely glows. The resistance is finally adjusted so that there is a soft glow over the entire surface of one of the plates. The lamp itself has a negative temperature coefficient of resistance, that is, the internal resistance of the lamp decreases as its temperature increases. The voltage required to start the lamp in operation is somewhat higher than that required for steady illumination.

The most satisfactory operation is secured with moderate current through the neon lamp. A current greater than normal will make the lamp glow more brightly and will increase the illumination, but there is no improvement in contrast between minimum and maximum brightness. It is the contrast which brings out the details of a picture and produces the effect of black and pink. Excessive voltage and current will materially shorten the useful life of the tube.

Receiver Design.—The television receiver consists of a radio frequency tuner and amplifier, a detector and a low frequency amplifier. Practically any kind of radio frequency amplifier described under *Amplifier, Radio Frequency* may be used. The low frequency amplifier which follows the detector should differ in one important particular from commonly employed audio frequency amplifiers. That particular is in the band of frequencies which should be uniformly amplified. A forty-eight line frame with fifteen pictures per second requires a frequency range of 17,280 cycles. Since this number of lines and frames per second is the practical minimum for satisfactory reproduction it is seen that the low frequency amplifier must handle a range of from about 30 to nearly 20,000 cycles per second, whereas a first class audio amplifier for broadcast reception need not go much above 8,000 cycles.

With ordinary apparatus the requirement of frequency amplification is most easily met by using three or more resistance coupled stages of the type described under *Amplifier, Audio Frequency, Resistance Coupled Type*. All of the values of plate resistors, grid leaks and coupling condensers may be those specified for broadcast amplifiers. Choke or impedance coil coupling and transformer coupling may be used when the impedances or transformers have been especially developed for this work. Transformer coupling gives greater amplification per stage than is possible with resistance or impedance coupling.

Transmission Frequency Bands.—One of the difficulties encountered in adapting television transmission to the existing broadcasting arrangements is found in the comparatively wide band of low or "audio" frequencies required to produce a picture of good detail. In broadcast work the band for a single carrier frequency is 10,000 cycles wide, extending 5,000 cycles above and 5,000 cycles below the carrier frequency. See *Band, Wave*.

In television the number of points scanned in an image is equal to the

TELEVISION

square of the number of lines per frame. Each strip across the frame in Fig. 3 must be considered as divided into square sections as indicated at *A, B, C*, etc. in that illustration. The number of sections scanned per second must be equal to the total number in one frame times the number of frames per second. The transmitted or the modulating frequency per second is, of course, equal to the number of sections transmitted per second, divided by a constant which depends on the quality or excellence of detail required. Reduced to a formula, this rule becomes:

$$\frac{\text{Required Frequency}}{\text{Frequency}} = \frac{(\text{lines per frame})^2 \times \text{frames per second}}{\text{constant}}$$

The constant is usually chosen to lie between 1.5 and 2.5. The resulting reduced frequency is allowable because a certain amount of detail is replaced by the eye of the observer. As an example, suppose it is desired to know the required frequency band for transmission of 48 lines per frame and 15 frames per second. The lines per frame (48) squared equals 2304 which, multiplied by 15 (frames per second) equals 34,560. This number divided by a constant of 2.0 becomes 17,280, the required frequency.

A side band of 5,000 cycles, as used in broadcasting, would allow only about twenty-six lines for the whole frame. With a picture having fifty lines per inch twenty-six lines would allow an area of only about one-half inch square. The better the quality of the picture the greater the frequency band required for transmission. Bands of 20,000 cycles are considered necessary for fairly satisfactory results.

Synchronism.—It will be realized that successful television requires the lights and shadows produced at the receiver to be in exact step with the lights and shadows affecting the photo-electric cell or other light-sensitive device at the transmitter. If the scanning disc method is employed it is essential that the disc at the receiver rotate at exactly the same speed as the disc at the transmitter so that the part of the object being viewed at the transmitter is cast by the receiver onto the correct relative position of the screen or other device which makes the picture visible.

In addition to causing the two scanning devices to operate at the same speed it is also necessary that they scan and reproduce a certain spot on the object and the reproduction at exactly the same instant of time. Two actions which go on at the same speed and in which similar parts occupy similar positions at the same time are said to be synchronous and the condition under which these requirements are satisfied is called synchronism.

Synchronism of actions at the receiver with those at the transmitter is one of the major problems in television. In experimental work the two discs have often been mounted at opposite ends of the same shaft which provides perfect synchronization. When the two parts of television apparatus are separated by a matter of miles the solution of the problem is not so simple.

One method utilizes an alternating current generator at the transmitter, sends a signal from this generator to the receiver where a synchronous electric motor controlled by the signal in turn controls the speed of the driving motor. The generator sends a signal of fairly high frequency, 500 cycles being commonly used, and transmits this synchronizing signal on the same carrier wave that transmits the television signals. At the receiving end the synchronizing signal is filtered out from the television signal and is sent to the controlling motor.

It has been proposed that synchronization be accomplished by providing a synchronous motor at the transmitter and another at the receiver, both

TELEVISION

operating from commercial lighting and power currents at one frequency. This method appears possible since most localities are furnished with such current at a frequency of sixty cycles. In practice it is found that commercial frequencies are not uniform enough to allow their use, a variation of two or three per cent being found between various cities and towns. Such a variation makes synchronization impossible without special compensating devices.

Another plan contemplates the establishment of special synchronizing radio stations which will radiate continuously a signal of suitable frequency which may be used both at transmitters and receivers to control driving motors.

Standards of speed have been proposed for use both at transmitters and receivers. Accurately calibrated tuning forks have been suggested. Quartz crystal control has also been used, the action of this method being explained under *Crystal, Frequency Control By*. Methods such as the latter two are subject to variations with changes of temperature and humidity at the two ends of the television system. All of the plans so far mentioned may be classed as automatic synchronization which, of course, would be superior to manually controlled systems.

Manual control of speed and position is used in many experimental outfits since it is economical, reliable and fairly satisfactory in results. In Fig. 25 is shown one such method. In series with

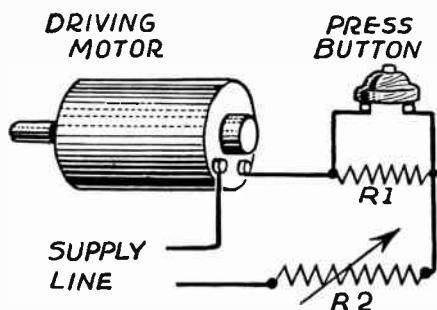

FIG. 25.—Press Button Synchronizing.

the driving motor is a fixed resistor $R1$ and an adjustable resistor $R2$. Across the resistor $R1$ is a button switch which will short circuit this resistor when pressed. The adjustable resistor is set at such value that with the button released the driving motor runs slightly below its synchronous speed and with the button pressed to short out the fixed resistor the motor runs slightly too fast. The operator then alternately presses and releases the button to maintain the motor at its correct speed as indicated by the clearness of the picture.

A second manual method is shown in Fig. 26. Here a fixed resistor and a rheostat are connected in series with the driving motor. The value of the fixed resistor is such that with the rheostat resistance cut out the motor runs slightly too fast and with all the rheostat resistance in use the motor runs too slowly. The rheostat position is then adjusted to maintain synchronization.

It was mentioned that synchronization implies not only a matching of speeds but also a matching of positions. After the receiving devices are in

TELEVISION

operation it may be found that the speed is correct but that the position is wrong. One method of adjustment for position is shown in Fig. 27. The driving motor is supported in a cradle or in large bearings so that it may be rotated bodily. A worm gear is attached to the motor and is operated by a screw to bring the motor and the driven mechanism into correct position to place the picture within the frame. Various other means are adopted for adjusting the speed and position of driving motors to obtain synchronization.

Disc Operating Troubles.—When using scanning discs of the general types shown in Figs. 6 to 9 and using neon lamps at the receiver certain troubles are commonly encountered in the preliminary adjustment of the apparatus. As the television receiver is being tuned in to a station the television signal may be identified by placing a loud speaker in the position occupied by the television lamp and disconnecting the lamp battery. The similarity of connections for speaker and lamp may be seen in Fig. 24. The signal will produce a rather high pitched note which rises and falls quite rapidly. If reception on the loud speaker is noisy, the result in a television

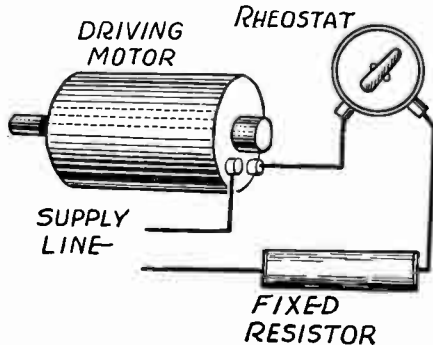

FIG. 26.—Rheostat for Synchronizing.

reproduction will be streaked and spotted, although a given noise level will prove less damaging to television reception than to broadcast reception. Static, interference, fading and similar troubles with broadcast reception will also prove troublesome in television.

In order to reduce the effects of vibration to a minimum the disc and its driving motor should be supported independently from the receiver and amplifier. The neon lamp must be supported with the disc so that any movement affects both alike. Streaks are also caused by defective parts in the receiver and by anything which would cause audible hum in parts operated with alternating current and feeding a loud speaker.

Until synchronization is effected the frame will show streaks of light and shadow without any picture. A picture in which right hand parts appear on the left side and vice versa indicates that the scanning is from right to left instead of from left to right. The remedy is to turn the disc around on its shaft and to also reverse the direction of rotation of the disc. If the picture is upside down, the disc is reversed and should be removed from its shaft and replaced with the other side outward. Should the picture have shadows

TELEVISION

where high lights should appear and vice versa the connections for the neon lamp should be reversed.

A neon lamp which has been subjected to excessive voltage and current will glow with a pale violet instead of a pink color. Abuse of this kind will also cause the plate to appear spotted and the overheating may even buckle the plates. Operating a damaged tube with normal current for ten to twenty hours will often restore uniformity of illumination on the plate but may not restore the original color.

Cathode Rays.—Television mechanisms so far described make use of mechanical parts which are moved for the control of light beams. Such parts have considerable weight, therefore have cor-

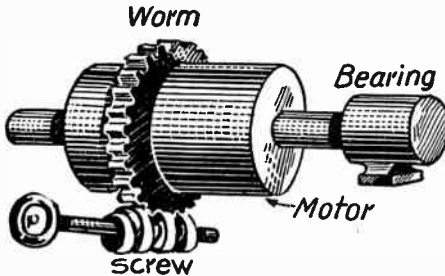

FIG. 27.—Adjustment of Motor To Frame the Picture.

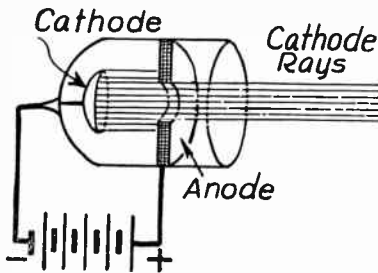

FIG. 28.—Principle of Cathode Ray Tube.

responding inertia and momentum which inevitably limit the speed of the actions in which they are involved. To avoid such effects use is made of the cathode rays in certain types of apparatus.

When a positively charged electrode and a negatively charged electrode are placed in a tube having a very high degree of vacuum it is found that rays or streams of negatively charged electrons are emitted from the negatively charged electrode, or cathode. These rays travel normally in perfectly straight lines at right angles to the surface of the cathode. The electrons weigh almost nothing at all. Hydrogen is the lightest gas we use, so light that it is used to lift balloons, yet an electron weighs but one sixteen hundredth

TELEVISION

part of the weight of a hydrogen atom. The speed of these electron or cathode rays is very great, from twenty thousand to sixty thousand miles per second.

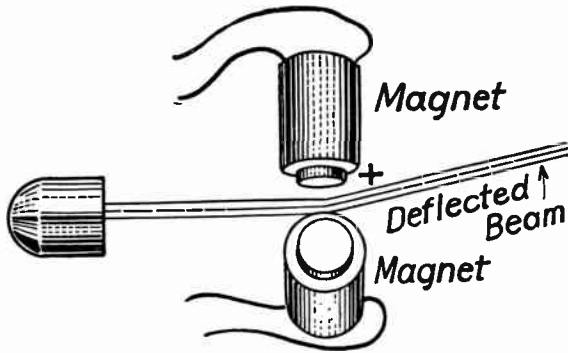

FIG. 29.—Magnetic Bending of Cathode Ray.

When the cathode rays strike a material which is fluorescent the spot struck becomes luminous. Striking the glass wall of the vacuum tube these rays produce a yellow-green fluorescence on the glass. A solid object placed between the cathode and a fluorescent screen will cause the cathode rays to cast a sharp shadow on the screen.

Cathode rays as used in television are produced in a tube having the cathode back of an anode through which is a circular opening as in Fig. 28. A pencil

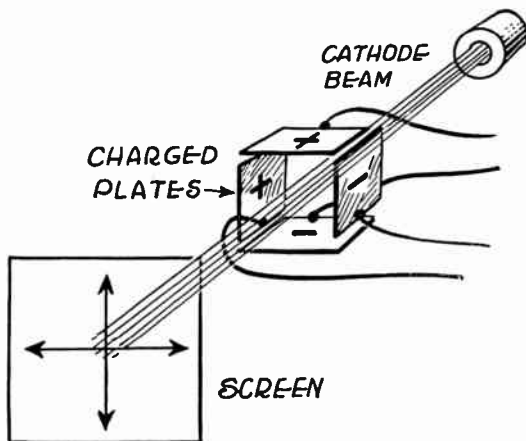

FIG. 30.—Electrostatic Control of Cathode Ray.

or beam of the rays emitted by the cathode passes through the opening in the anode.

It was mentioned that normally the cathode rays travel in perfectly straight lines away from the cathode's surface. They may, however, be bent or de-

TELEVISION

flected by passing them through a magnetic field as in Fig. 29. The rays act like any negatively charged body, being attracted by a positive pole and repelled by a negative pole. Using two magnets with their axes at right angles makes it possible to deflect the cathode beam up or down by means of one magnet and at the same time to deflect it from side to side with the other magnet. The cathode beam may be deflected by passing it through an electrostatic field just as well as by passing it through a magnetic field. See *Field, Electrostatic*, also *Field, Magnetic and Electromagnetic*.

The ability to bend or deflect the cathode beam without the use of any moving physical parts, combined with the fact that the beam has practically no weight and no inertia makes it almost ideally suited to the purposes of television.

Scanning with Cathode Rays.—The use of two electromagnets at right angles as in Fig. 29 or of two sets of electrostatically charged plates as in Fig. 30 will allow the cathode beam to be moved rapidly from side to side of a screen and at the same time

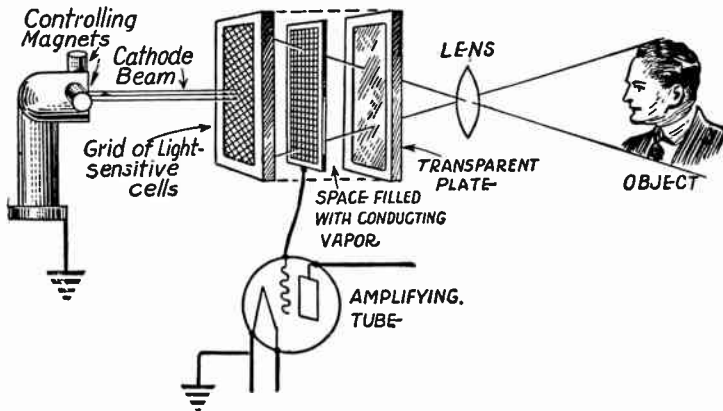

FIG. 31.—Principle of Swinton-Clarkson Televisor.

to be moved downward until the entire screen has been covered to completely scan an image. Voltages which alternate in polarity will cause either the magnets or the electrostatic plates to alternately reverse their polarity, thus causing the beam to bend first one way and then the other.

The magnet or charged plates which cause travel of the beam back and forth, from left to right, will be operated at a comparatively high frequency while the element causing travel downward has a lower frequency. Thus, if there are to be fifteen frames or pictures per second, the frequency operating the magnet or set of plates controlling motion downward from top to bottom will be fifteen per second. If there are to be forty-eight lines per screen the sidewise travel must take place forty-eight times for each frame and the frequency will be 48 times 15, or 720 per second. So far as the rays and the elements controlling their travel are concerned there is no practical limit to the number of lines which may be traced or to the number of frames which may be completed within one second.

TELEVISION

Cathode Ray Televisor.—The cathode rays may be utilized in various ways for scanning the image to be transmitted. One method, used in the Swinton-Clarkson apparatus, is as follows: As shown in Fig. 31, an image of the illuminated object is focused through a lens onto a grid-like structure composed of many light-sensitive cells. The space immediately adjacent to the grid is filled with sodium vapor or some other fluid which becomes an electrical conductor when acted upon by light. The fluid is retained by tight walls and a transparent plate. Suspended in the conducting vapor is a metallic conducting screen. The grid of an amplifying vacuum tube is connected to the conducting screen. On the other side of the light-sensitive cells plays the scanning beam of cathode rays.

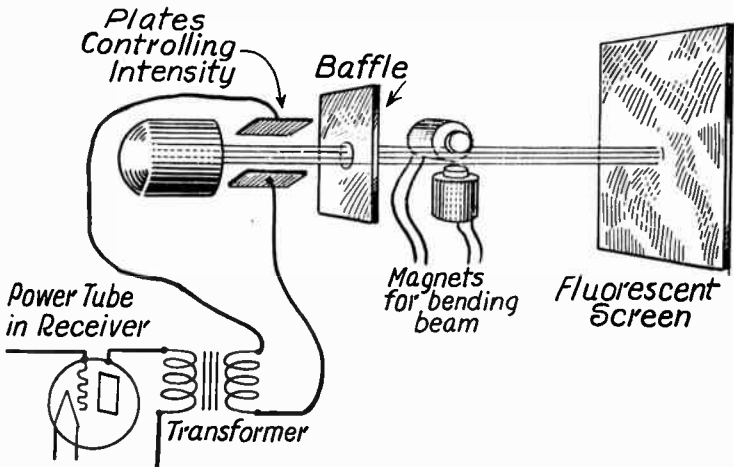

FIG. 32.—Reproduction of Image with Cathode Ray.

The light-sensitive cells consist of small pieces of some alkali metal like potassium or rubidium which emits electrons when acted upon by light. The action is like that taking place in the photo-electric cell. Of these cells, those which are illuminated by the image cast upon them will emit electrons in proportion to the amount of light striking them. Only those cells which are illuminated are active and at any one instant the moving cathode beam is striking only one cell or one group out of all the cells. If this cell or group is dark no action takes place, but if it is energized by light in the image the cathode ray causes an emission of electrons which pass through the conducting vapor and strike the conducting screen. The electrons produce a negative charge on the screen and, since the screen is connected to the tube's grid, the grid voltage varies in proportion to the light in one part of the image, the part which is being scanned at the moment by the cathode ray.

The action of one simple form of cathode ray receiver is illustrated in Fig. 32. The received variations of voltage are amplified and fed through a transformer in the plate circuit of the power tube. The output of this transformer controls the intensity of the cathode beam before it passes through an opening in a baffle. The cathode beam passing through the baffle's opening

TEMPERATURE, SCALES OF

is caused to travel over a fluorescent screen by two magnets or charged plates placed at right angles to each other. As explained in the description of the transmitter, these magnets cause the beam to completely scan the screen once for each picture. The degree of fluorescence or intensity of illumination is determined by the voltage from the receiver so that various parts of the screen become luminous in proportion to the illumination of corresponding parts of the image at the transmitter, thus producing a television picture. In both the transmitter and the receiver using cathode rays there is complete elimination of moving mechanical parts.

It is apparent from the foregoing discussion that there are major problems to be overcome in making television really practical and popular. The chief objections to present systems include smallness and lack of definition in the image and such electrical and mechanical difficulties as those encountered in synchronization.

Work is constantly going forward in many laboratories and steady progress is being made toward solution of the difficulties, either by refinements of present processes or by development of wholly new methods of accomplishing the desired object. Television is one of the fertile fields for experimentation.

TEMPERATURE, SCALES OF.—In scientific and technical work temperatures are measured according to the Centigrade scale.

The values of degrees Centigrade in degrees Fahrenheit are as follows for one to ten degrees Centigrade, these values being for interpolation in the next table:

<i>Centigrade...</i>	1	2	3	4	5	6	7	8	9	
<i>Fahrenheit...</i>	1.8	3.6	5.4	7.2	9.0	10.8	12.6	14.4	16.2	18.0

DEGREES CENTIGRADE TO DEGREES FAHRENHEIT

Cent.	Fahr.	Cent.	Fahr.	Cent.	Fahr.	Cent.	Fahr.
-40	-40	45	113	160	320	330	626
-35	-31	50	122	170	338	340	644
-30	-22	55	131	180	356	350	662
-25	-13	60	140	190	374	360	680
-20	-4	65	149	200	392	370	698
-15	+ 5	70	158	210	410	380	716
-10	+14	75	167	220	428	390	734
- 5	+23	80	176	230	446	400	752
0	+32	85	185	240	464	410	770
+ 5	+41	90	194	250	482	420	788
10	50	95	203	260	500	430	806
15	59	100	212	270	518	440	824
20	68	110	230	280	536	450	842
25	77	120	248	290	554	460	860
30	86	130	266	300	572	470	878
35	95	140	284	310	590	480	896
40	104	150	302	320	608	500	932

TERMINALS, WIRING

The two following formulas may be used to convert readings in one temperature scale into readings in the other scale:

$$\text{Degrees Centigrade} = \frac{5}{9} (\text{degrees Fahrenheit} - 32)$$

$$\text{Degrees Fahrenheit} = \frac{9}{5} \times \text{degrees Centigrade} + 32$$

TERMINALS, WIRING.—See *Post, Binding*.

TESTER, RECEIVER.—See *Trouble, Receiver and Power Unit*.

TESTER, TUBE.—See *Tube, Testing of*.

TESTING.—See *Trouble*; also *Tube* and names of other units.

THEATRE AMPLIFIER.—See *Amplifier, Audio Frequency, Power Type*.

THERMIONIC RECTIFIER.—See *Tube, Rectifier Types of*.

THERMIONIC TUBE.—A vacuum tube. See *Tube*.

THERMOCOUPLE METER.—See *Meter, Ampere and Volt*.

THERMO-ELECTRICITY.—Electricity produced by the direct action of heat is called thermo-electricity.

When two different metals are placed in contact and electric current is sent through the joint, heat is produced at the junction between the metals. The reverse of this action will also take place.

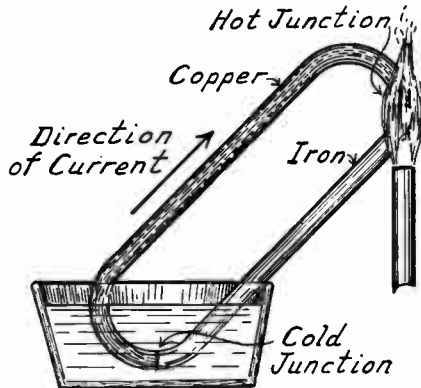

FIG. 1.—Principle of the Thermocouple.

If the joint between the two metals is heated, a voltage will be set up and current will flow in a circuit of which the metals and their junction form a part.

The amount of voltage produced depends on the heat applied and on the metals used, different metals giving different voltages. Practical combinations are made from antimony and bismuth, from German silver and copper sulphide, from copper and constantan and from iron and constantan. The voltage from any one junction is so small as to be measured in microvolts or millivolts.

THERMO-ELECTRICITY

One such junction is called a thermo-couple and a collection of thermo-couples is called a thermopile. In the thermopile, alternate junctions are heated and cooled, this giving rise to a continuous difference of potential through the circuit. The energy required to maintain the heating and cooling is changed into electrical energy.

When any two of the metals in the following list are joined to form a thermo-couple and the joint heated, current will flow from the metal higher in the list to the one lower:

Bismuth
Platinum
Copper
Lead
Silver
Antimony

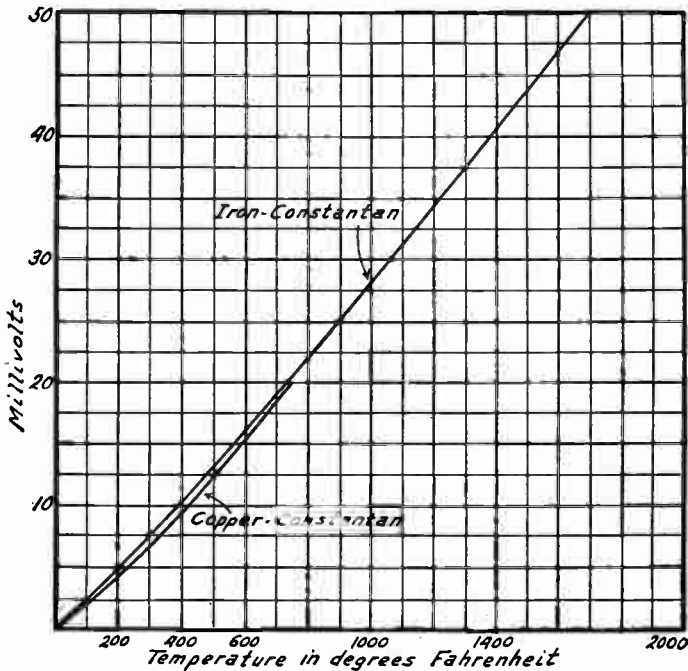

FIG. 2.—Voltage Developed by Thermocouples.

The joint may be made in any convenient way which will hold the metals in place while heated. It may be bolted, clamped or even soldered. The greatest voltage will be developed between metals farthest apart in the list. For instance, the greatest voltage will be between bismuth and antimony while comparatively little voltage would be developed between bismuth and platinum or between copper and lead.

Various alloys are commonly used for one or both metals of a couple. Whether using an elementary metal or an alloy, the purity and physical condition of the parts are of importance in securing uniform results.

Thermoelectric voltages and currents are often found to be generated at the junctions of metals where no such effect is desired. A generally used re-

THERMOMETER SCALES

sistance wire made by alloying copper and nickel develops a large thermo-electric voltage against brass or copper when the joint becomes heated as it might in a resistance element.

The principle of the thermocouple is illustrated in Fig. 1. The circuit is composed of copper and iron in this particular case. One of the junctions between the two metals is kept heated with a flame while the other junction is cooled. As long as the heat is applied there will be a flow of current from the copper into the iron at the hot junction and from the iron into the copper at the cold junction.

The greater the difference in temperature between the two junctions the greater will be the voltage developed. For greatest efficiency one of the junctions is artificially cooled while the other is heated. In practical applications it is generally sufficient to cool the one junction simply by allowing air to circulate around it.

An idea of the electric force generated in thermocouples may be had from Fig. 2. This shows the electromotive force in millivolts (thousandths of volts) generated in one circuit consisting of copper and constantan and of another with iron and constantan. One of the junctions is heated to the degree shown along the bottom of the graph while the other one is kept at the temperature of melting ice. It will be seen that the generated voltages are very small. With a temperature of 1000 degrees the iron-constantan couple produces less than thirty millivolts. Other combinations will produce greater voltages, a couple formed of antimony and bismuth being one of the strongest.

THERMOMETER SCALES.—See *Temperature, Scales of*.
THERMOPILE.—See *Thermo-electricity*.

THORIATED FILAMENT.—See *Tube, Filament Materials* for.

THREADED HOLES, DRILLS FOR.—See *Drilling*.

THREE-CIRCUIT RECEIVER.—See *Receiver, Three-Circuit*.

THREE-ELEMENT TUBE.—See *Tube, Three-Element Type*.

THROTTLE CONTROL OF OSCILLATION.—See *Receiver, Single Control*.

TICKLER.—See *Coil, Tickler*.

TIGHT COUPLING.—See *Coupling, Close*.

tone, quality of.—The ability of a receiver to evenly and faithfully amplify and reproduce in sounds the music, voice or other material received by the antenna system is the tone quality of the receiver.

Good tone quality assumes that there is no distortion either in the radio frequency amplifier, the detector or the audio frequency amplifier. See *Distortion*. It also assumes that all frequencies, from lowest to highest, are amplified to the same extent without exaggeration of some frequencies and suppression of others.

To secure good tone quality the radio frequency amplifier or the tuner must not tune so sharply as to cut off part of the side bands. The detector should not be allowed to come too close to oscillation

TOOLS

when using regeneration. The audio frequency amplifier tubes must be capable of handling the power without distortion and the audio frequency coupling devices; transformer, chokes or resistances; must have sufficient iron and copper to operate without overloading either their magnetic or electric circuits.

Finally, the loud speaker must be able to handle the power delivered to it, must not have pronounced resonant points of its own, and must be suited to the audio amplifier which feeds it.

Good quality can be secured only when no part of the receiver is overloaded or forced beyond its normal ability. This requires that the signal from the antenna be of moderately high power and it generally precludes the possibility of getting good tone quality from stations at great distances from the receiver.

TOOLS.—The more tools and the better their quality, the more easily and quickly can radio work be done and the more workmanlike will be the results. It hardly pays to buy a four dollar panel and ruin it with ten cent tools. Tools may be divided into three general classes; those used for laying out the work, those used for cutting and drilling, and those used for mounting and fastening. Of course there are some other tools that are difficult to classify but these three general classes make a convenient division for purposes of description.

Tools for Laying Out.—The tools that will be found of real help in laying out the work, in preparing the panels, the subpanels, the brackets, etc., are as follows:

Dividers with legs four to six inches long and with both points sharp. It will be better to use instruments provided with a screw adjustment than those depending only on friction.

Prick punch for making the preliminary dent in which the point of the center punch is placed later on. The prick punch should be kept well pointed.

Center punch for making depression deep enough for a drill point to enter and start the hole without danger of running to one side or the other.

Scriber about six inches long with one point straight and the other bent over.

Adjustable square whose blade may be set at any required angle and clamped in position as shown in Fig. 1. This square is set at right angles while laying off square lines with the scriber. It may be set at any angle when transferring the angle for slanting panels to brackets and other parts.

Adjustable template as shown in Fig. 1. This device consists of a clamping knurled nut having a quarter-inch hole and provided with a bushing for handling three-sixteenth inch shafts. The three adjustable arms each carry a hard steel center punch tip. The hole in the nut is slipped over the shaft of any instrument (condenser, tickler, coupler, etc.), the center points placed exactly in the screw or bolt holes for mounting and the nut tightened. The template may then be removed from the instrument and laid on the panel or other part with the center of the large hole over the center that has been marked for the instrument shaft. A light blow with a small hammer on top of each center point will then mark off the places for drilling with great accuracy.

Tools for Cutting and Drilling.—The following will be found convenient and many of them are really indispensable in preparing the parts for the mounting of instruments such as condensers, transformers, rheostats, etc:

Round shank twist drills of the following diameters in fractions of an inch:

TOOLS

1/16, 1/8, 5/64, 3/16, 13/64, 1/4, 17/64, 5/16, 21/64, 3/8, 25/64, 7/16, 1/2, and 33/64. The sizes in sixty-fourths are for drilling a hole originally of the next smaller size slightly larger to make an easy fit.

Round shank numbered twist drills of the following sizes are needed for drilling holes to be tapped or threaded and for drilling holes allowing clearance for the standard sizes of screws and bolts: Numbers 1, 3, 9, 11, 13, 15, 18, 19, 20, 22, 23, 24, 27, 28, 29, 30, 31, 33, 36, 37, 41, 42, 44, 48. If, as should be the case, all mountings are made with screws of number 4, 5, 6, 8 and 10 size and with 1/8, 3/16 and 1/4 inch diameter bolts; the sizes of numbered drills may be reduced to the following: Number 9, 11, 12, 18, 20, 23, 27, 28, 30, 31, 33, and 41.

Geared hand drill having three-jaw chuck taking up to 1/4-inch diameter drills.

Ratchet brace taking up to one-half inch or larger drills.

Countersink such as shown in Fig. 2. This is used in the hand drill or brace for tapering holes which are to receive flat head screws.

Files as follows: One six-inch single-cut mill file; one ten-inch double cut mill file; one ten-inch double-cut bastard file; one eight-inch single-cut

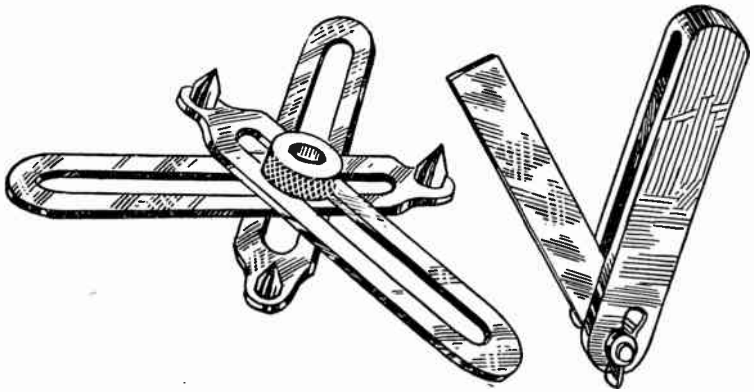

FIG. 1.—Adjustable Template and Adjustable Square.

half-round file; one eight-inch single-cut three-square or three cornered file; one four-inch rat-tail file; and one eight-inch rat-tail file.

Adjustable hack saw frame taking blades up to twelve inches long.

Hack saw blades one-half inch wide and ten inches long. Some blades should have 22 teeth per inch for cutting steel and iron; others should have 28 teeth per inch for cutting brass, copper and panel materials; while a few may have 32 teeth per inch for cutting tubing.

Electricians' knife for general handy work.

Square reamer for enlarging drilled holes which are found to be slightly too small or slightly out of line with the position counted on.

Electrician's scissors as shown in Fig. 2. These are strongly made with heavy, thick blades. They will cut fibre, thin sheet metal, small wires, cardboard templates, etc.

Panel hole cutter as shown in Fig. 2. When placed in a brace this tool will cut clean holes through panel material. It is made in sizes which cut holes having three-quarter inch, one inch, or one and one-half inch inside diameter.

Taps for cutting threads on the inside of holes, and dies for threading the outside of rods of the following sizes. The first part of each number indicates

TOOLS

the gauge number of the rod or the diameter, while the second part indicates the number of threads per inch. Taps are made with three styles of entering ends; taper, for starting the threads in difficult material; plug, for carrying the threads nearly to the bottom of a hole; and bottoming, for following one of the other types and carrying the threads clear to the bottom of a hole. These sizes are regularly used in radio work: 4-36, 6-32, 8-32, 10-32, 10-24, 3/16-24, 1/4-20. See *Screws and Bolts, Types of*.

Tap wrench for holding the taps while working.

Die stock for holding the dies while working.

Tools for Mounting and Fastening.—After the work has been laid out and the brackets, panels, etc., prepared for mounting the various parts of the receiver, a new class of tools will be needed for fastening things in place.

Ball peen hammer of one-half to three-quarter pound weight. The face is used for regular work and the ball shaped peen is used for riveting.

Soldering iron, electric or gas heated. See *Soldering*.

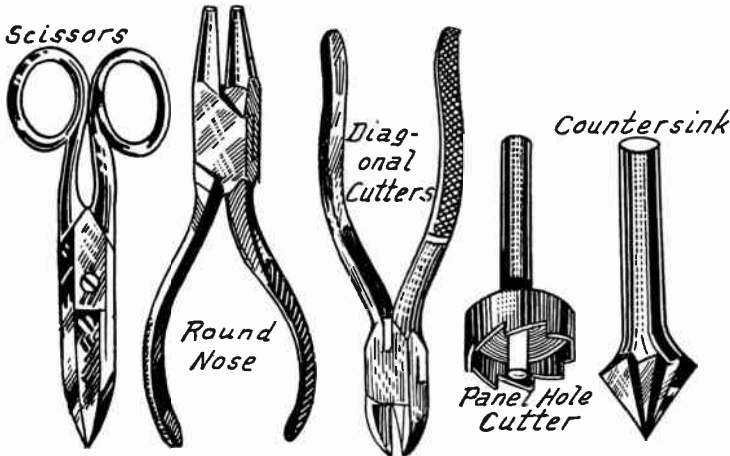

FIG. 2.—Pliers and Cutting Tools.

Pliers of the following types. Pliers having a total length over all of five to six inches will be found most convenient for all around use. There is no place where a little additional investment in first cost will produce more lasting results in satisfaction than in the purchase of pliers.

One pair of substantial flat-nose pliers which may be of the side-cutter type for cutting fairly large wires. One pair of double round nose pliers as shown in Fig. 2. These are for forming terminal loops at the ends of wires. One pair of diagonal cutting pliers as shown in Fig. 2. One pair of round long-nose pliers. One pair of flat long-nose pliers. It is also convenient, but not necessary, to have end cutting pliers of heavy construction for cutting off the extra length of machine screws.

Socket wrenches with handles as shown in Fig. 3. These are made in two types, one type fitting hexagon nuts and the other fitting round knurled nuts. Both types come in different sizes to fit the different sizes of nuts.

Screw driver with four-inch blade and tip five-sixteenth inch wide for heavy work.

Screw driver with six or seven-inch blade and tip three-sixteenth or one-quarter inch wide for reaching inaccessible places.

TOROIDAL COIL

Swivel base bench vise with jaws three inches wide.

Miscellaneous Tools.—There are endless varieties of special tools on the market, all of them claimed to allow the radio worker to accomplish better results in less time. Many of these special tools live up to all the claims made for them, but it is impossible to begin to describe each one here.

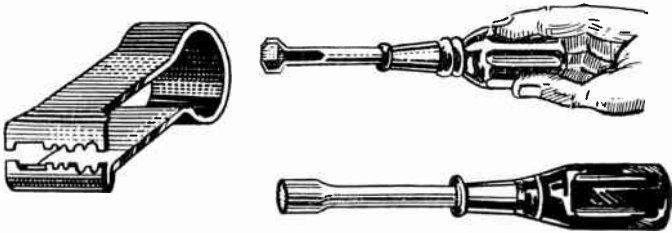

FIG. 3.—Wire Skinner and Socket Wrenches.

It will be found a real convenience to secure a wire skinner somewhat like the one shown in Fig. 3. This tool has openings of different sizes which fit wires of different gauges. With the jaws clamped down on the wire a pull will completely and cleanly strip the insulation. The type shown has additional knife edges for cleaning wire ends ready for the solder.

It may be desirable to have a wire gauge which is a piece of steel with slots or tapering grooves along which are marked the gauge number of wires which just slide into the slots or which just fill the groove at the point marked.

TOROIDAL COIL.—See *Coil, Closed Field, Toroid*.

TRAIN, WAVE.—A series of radio waves is called a wave train. If the waves start with maximum amplitude and then diminish in amplitude, it is called a damped wave train. If the amplitude does not diminish, it is called an undamped wave train or the waves are called continuous waves.

TRANSFORMER.—A transformer is a device for transferring energy from one alternating current circuit into another alternating current circuit by means of induction. As shown in Fig. 1 the trans-

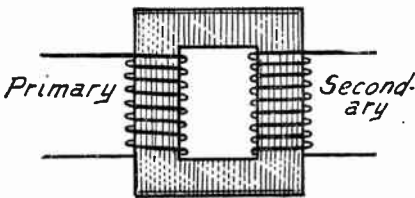

FIG. 1.—Core Type of Transformer.

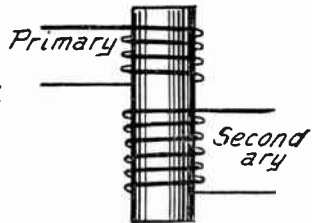

FIG. 2.—Open Core Type or Coil Type Transformer.

former consists of two windings placed on a common magnetic core.

The winding by means of which energy or power is supplied to the transformer is called the primary winding and the winding from

TRANSFORMER

which power or energy is taken from the transformer is called the secondary winding.

Current flowing around the turns of the primary winding causes a flow of magnetic lines of force in the core, which is of silicon steel or other suitable steels. This sets up a magnetic field about the core and the movement of this magnetic field causes a voltage to appear in the secondary winding by electromagnetic induction. See *Induction, Electromagnetic*.

In order for an electromagnetic field to induce a voltage in a conductor, such as the transformer's secondary winding, it is necessary that the field move with reference to the conductor or that the conductor move with reference to the field. It is evident that the secondary winding cannot be moved with reference to the field of the core, therefore the field must be kept moving by rising and falling in magnetic strength in order that voltage may be induced in the secondary.

While a direct current through the primary would cause the core to become magnetized and thus produce a magnetic field, this field would be stationary because the direct current would be steady. But an alternating current is constantly changing in value, first rising, then falling and reversing its direc-

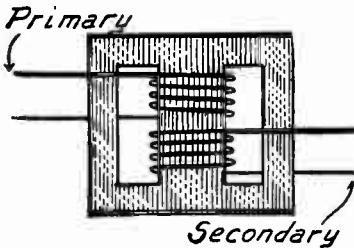

FIG. 3.—Shell Type Transformer.

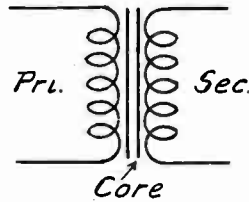

FIG. 4.—Symbol for Iron Core Transformer.

tion to once more rise. This fulfils the requirement of a moving field and voltage is induced in the secondary winding, but is induced only with an alternating or changing current in the primary.

It is not necessary that the current reverse its direction as does an alternating current, only that its value change to induce a secondary voltage. Such a change is caused by a pulsating direct current, one which is continually rising and falling in value although continuing to flow in the same direction.

If the secondary winding forms part of a closed circuit, the induced voltage will cause a current to flow in that circuit. The rise and fall of voltage and current in the secondary circuit will be at the same frequency as the rise and fall in the primary.

Transformers used in power circuits and in audio frequency circuits of radio receivers have cores as indicated in Fig. 1 for the core type, as in Fig. 2 for the open core type, and as in Fig. 3 for the shell type. The symbol for the steel core or iron-core transformer as shown in Fig. 4 is made up of two inductances with several lines between them, this indicating the two windings and their common core.

TRANSFORMER

For very high frequencies, such as radio frequencies, the change in magnetism of the core would be altogether too slow to get any real action. Transformers for radio frequency work are built with a very small iron core, or without any core except the air inside the coils as shown by Fig. 5. The magnetic field of one winding passes through the other windings and energy is transferred. Symbols for air-core transformers are shown in Fig. 6.

Transformer Ratios.—The sole purpose of a transformer is to get energy from one circuit into another and, if desired, to change the voltage and current of the secondary circuit to something different from these values in the primary. A transformer cannot produce power in itself and it should not consume any more power than absolutely necessary.

Electrical power is measured in watts and the number of watts in a direct current circuit is equal to the number of volts multiplied by the number of amperes in that circuit. A power of 100 watts may be secured from 2 amperes at 50 volts, from 10 amperes at 10 volts, from 50 amperes at 2 volts, or from any other combination of amperes and volts whose product is 100. The same general principles hold true for alternating current circuits.

In a transformer having no loss of energy within itself, 100 watts put through the primary winding would give up all its power and this power would reappear as 100 watts in the secondary. Of course such a perfect



FIG. 5.—Air Core Radio Frequency Transformer.

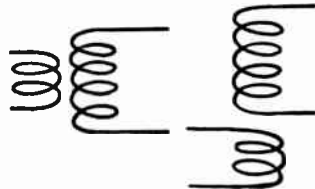

FIG. 6.—Symbols for Air Core Transformer.

transformer is not commercially or even experimentally possible. But for purposes of explaining the relations between voltages and amperages this condition of perfection will be assumed.

The change between the voltage and amperage in the primary circuit and the voltage and amperage in the secondary circuit depends on the turn ratio of the windings, that is, on the ratio of the number of turns in the secondary winding to the number of turns in the primary winding.

The ratio of secondary turns to primary turns is the same as the ratio of secondary volts to primary volts. That is to say, if we have ten times as many turns in the secondary winding as in the primary, we will have ten times as many volts in the secondary as in the primary. If we have one-half the number of turns in the secondary as in the primary, then the secondary voltage will be half of the primary voltage.

Since the power must be the same in both windings, an increase of secondary voltage means a decrease in secondary amperage while a decrease of secondary voltage will mean an increase of secondary amperage.

TRANSFORMER

Starting again with 100 watts of power and assuming the primary circuit to carry this 100 watts as 20 volts and 5 amperes, let us see what will appear in the secondary with different turn ratios. The transformer of Fig. 7 has twice as many turns on its secondary as on its primary. Since the turn ratio is 2/1 and the primary voltage is 20 the secondary voltage at the ratio of 2/1 will be 40. The secondary power must be the same as the primary power, therefore, the number of amperes in the secondary will be 100 (watts) divided by 40 (volts) or 2½ amperes.

In the transformer of Fig. 8 there are 6 primary turns and 3 secondary turns so that the ratio of primary to secondary is ½. Since the primary voltage is still 20 and the ratio is ½ the secondary voltage must be 10. The number of watts in the secondary will be the same as in the primary, 100. Therefore, the secondary current will be 10 amperes, since 100 divided by 10 equals 10.

The transformer of Fig. 7 increases the voltage and is called a step-up transformer. The transformer of Fig. 8 reduces the voltage and is called a step-down transformer.

The relation between turns and voltage may be expressed by the following proportion:

$$\frac{\text{primary turns}}{\text{secondary turns}} = \frac{\text{primary volts}}{\text{secondary volts}}$$

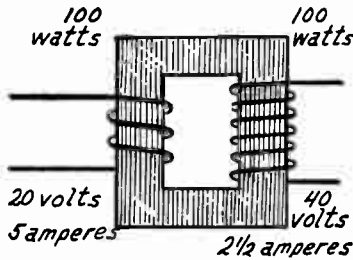

FIG. 7.—A Step-Up Transformer.

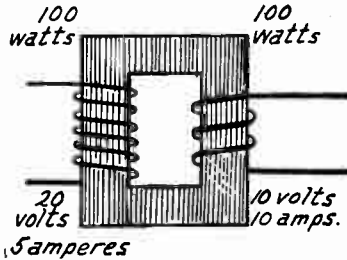

FIG. 8.—A Step-Down Transformer.

Inasmuch as the power in watts in the secondary is the same as the power in watts of the primary, the ratio between the currents in the two circuits will be in inverse proportion to the ratio of the number of turns in the two circuits. The proportion is as follows for current:

$$\frac{\text{primary turns}}{\text{secondary turns}} = \frac{\text{secondary amperes}}{\text{primary amperes}}$$

It will be noticed that the first parts of the two foregoing proportions are the same. Therefore, the second parts must be equal to each other and we can get a new proportion showing the relations between voltages and currents in the two circuits. This proportion is as follows:

$$\frac{\text{primary volts}}{\text{secondary volts}} = \frac{\text{secondary amperes}}{\text{primary amperes}}$$

These relations would be exactly true only for an ideal transformer with no losses. Even though they are not exactly true in practice they serve as a convenient basis upon which different transformers may be compared.

Transformer Losses.—There are a number of causes for loss of power in transformers. Power is consumed by the eddy currents

TRANSFORMER

set up in the metal of the core, also because of the hysteresis of the core iron. There is a copper loss represented by the power that is used in heating the windings of the transformers. Heat is also produced in the iron by the eddy currents and the hysteresis, this heat representing an iron loss.

In the theoretical transformers shown by the core type and the shell type of Figs. 1 and 3 all of the magnetic lines of force are shown as passing through the iron core. Consequently, all of the magnetic lines that pass through one winding pass also through the other. This condition is not realized in practice because some of the lines escape and do not flow through their proper path. This leakage of lines of force or "leakage flux" causes a loss of the energy in the lines of force which do not pass through all the turns of both windings, that pass through only part of each winding or through only one of the windings. The larger the core, the fewer turns in the coils and the closer together the coils are placed the less will be the leakage. The coils are often wound one over the other for this reason. In the construction of high grade transformers all of these losses are reduced as much as is commercially possible.

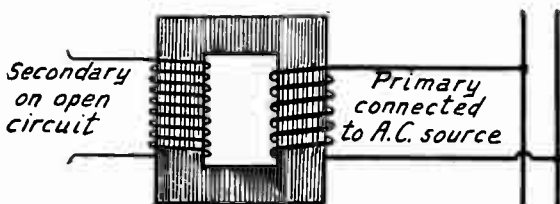

FIG. 9.—Transformer at No Load.

The copper loss due to resistance in the windings is reduced by using wire of large cross-section and by adequate allowance for radiation of the heat. The iron loss due to eddy currents in the core and to hysteresis is reduced by using iron having a low hysteresis, an iron which is easily demagnetized. These losses are also reduced by using iron of high permeability, iron which is easily magnetized. The leakage reactance or loss is reduced by using a large core and comparatively small windings. See *Current, Eddy; Hysteresis; and Permeability*.

Transformer Regulation.—If, as in Fig. 9, a transformer is connected to a supply line and allowed to remain with its secondary open-circuited the following action will take place. Current will flow from the supply line through the primary winding and will cause magnetic flux or lines of force in the core. This flux, which is rising and falling, will produce a voltage in the secondary. But it also reacts upon the primary and produces another and a new voltage in the primary. This new voltage in the primary is in addition to the voltage coming from the supply line. Its polarity is

TRANSFORMER, AUDIO FREQUENCY

opposite to that of the supply line voltage and it therefore tends to stop the flow of current.

This additional voltage increases in value until it stops all current from the supply line except just enough to produce a flux sufficient to maintain the opposing voltage. Therefore, a transformer connected to a supply line and having its secondary open-circuited will draw an exceedingly small current from the supply line. This exciting current is usually so small as to be negligible.

The condition illustrated in Fig. 9 is called the no-load condition. When the secondary of the transformer is connected to some form of current consuming or power consuming device, it is said to be loaded. When the transformer is putting forth the maximum power the condition is called full-load.

The change in the secondary voltage between no-load and full-load when expressed as a fraction is called the transformer regulation or the voltage regulation. As an example, if the voltage at the no-load were 100 and the voltage at full-load 90, we would have a drop of voltage of 10. The fraction representing the transformer regulation is written by placing the voltage drop over the remaining voltage. In the case just mentioned this fraction would be $10/90$ or $1/9$ or 11.1%. The regulation of this transformer would then be about eleven per cent.

Anything over ten per cent is generally considered as being poor regulation. In certain forms of power transformers poor regulation is undesirable. But in some other types of transformers poor regulation is an advantage. For instance, should the secondary become short-circuited a very heavy instantaneous load would be put upon it. The heavy current which would flow would tend to burn out the secondary winding. But if the transformer has poor regulation it will drop its secondary voltage to a low value, thus reducing the flow of current and preventing the burn-out.

Regulation depends upon the losses in the transformer, especially upon the copper loss and the leakage. A transformer with a high copper loss, due to the use of small wire, and with high magnetic leakage, will have poor regulation.

TRANSFORMER, AUDIO FREQUENCY.—The purpose of an audio frequency transformer used as a coupling device between two amplifying tubes is to receive the current changes from the preceding tube and to deliver to the following tube the greatest possible variations of voltage. The connections are shown in Fig. 1. An audio frequency transformer is often called an amplifying transformer because it is expected to amplify uniformly all of the frequencies which come to it.

Primary Winding.—If the primary of a transformer is small, has few turns and low impedance, the lower frequencies which should be amplified pass through this low impedance without having any great effect on the secondary. The low impedance does not allow the current changes to magnetize the core or to transfer their energy to the secondary, therefore the low frequencies are practically bypassed through the low impedance primary and are not amplified.

Theoretically the impedance of the primary winding should be about equal to the output impedance or plate resistance of the tube in its circuit. It is found that the primary impedance has to be about two and one-half times as great as the tube output resistance in order to fully amplify the lowest notes.

TRANSFORMER, AUDIO FREQUENCY

The primary impedance should be measured only under operating conditions, that is, with the secondary winding connected to a tube such as it will be called upon to operate when in actual service. The impedance of the primary may be increased by increasing the number of primary turns or by increasing the cross-section of the core.

Transformer Core.—To obtain the desired high impedance in the transformer primary it is generally better to use a core of large cross-section rather than to greatly increase the number of primary turns. If a small core is used it means that many primary turns are required and in order to obtain a step-up voltage ratio in the transformer the number of secondary turns will be still larger. When a great many secondary turns are used the distributed capacity of the secondary winding is increased and the higher frequencies are bypassed through this capacity and are not properly amplified.

In general the larger the core of a transformer the more uniformly it will amplify both low and high frequencies. Transformers having very small cores amplify well over a rather narrow range of frequencies.

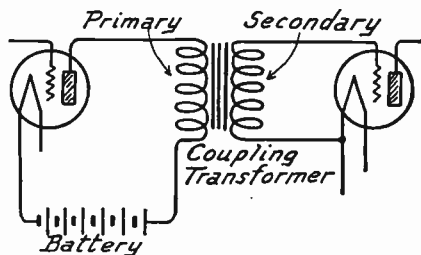

FIG. 1.—Connection of Audio Frequency Transformer Between Tubes.

High permeability is very desirable regardless of the size of the core. High permeability is found in silicon steel and aluminum steel which are used for transformer cores. If it were commercially possible to use perfectly pure iron such as electrolytic iron, or to use pure iron which has been remelted in a vacuum, the permeability might be increased to between three and four times its usual value. At the same time the coercive force would be reduced to about one-half its usual value. The cost of such iron prohibits its use.

In an amplifying transformer there are two currents flowing, one is the alternating current at audio frequencies, the other is the direct current from the B-batteries or power supply. The direct current is larger than the alternating current. If the transformer has a small core these two currents together may be great enough to saturate the iron of the core. This saturation causes the production of harmonics or frequencies which never existed in the signal as it was broadcast from the transmitting station. These harmonics are caused by changes in the flux density in the core when it is saturated and when it is not saturated. The effect is somewhat like the operation of a tube on the curved parts of its curve rather than on the straight part. See also *Iron and Steel*.

Distributed Capacity.—Distributed capacity between the turns of a transformer winding acts as a bypass for the high frequencies, thus reducing amplification. A large number of turns in a transformer winding gives a large distributed capacity which bypasses

TRANSFORMER, AUDIO FREQUENCY

and loses the higher frequencies. Thus a transformer of many turns which amplifies well at low frequencies is often poor at high frequencies. If the number of turns is reduced to reduce the distributed capacity the inductance is then lowered to such a point that it does not amplify low frequencies properly, therefore, it is a problem of obtaining the best balance between high frequency and low frequency amplification.

The distributed capacity in a secondary winding of many turns may be reduced by increasing the thickness of insulation on the wire. This increases the space between adjacent turns and reduces the capacity.

Resonant Peaks.—The combination of inductance and distributed capacity in the winding of a transformer forms a circuit which is resonant at a certain frequency, generally a rather high audio frequency. If a curve is drawn which represents the amplification of a transformer at different frequencies this curve will be found to have a more or less pronounced peak at one point. This

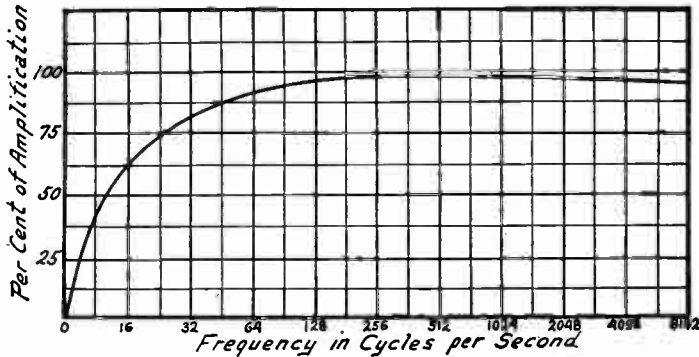

FIG. 2.—Amplification Curve for a Good Audio Transformer.

indicates the frequency at which resonance occurs. The impedance of the secondary is greatly reduced at this frequency, larger currents flow and the amplification is increased. See *Distortion*.

Placing a fixed condenser in parallel with transformer windings does not change the form of the amplification curve but moves the entire curve, also its resonant peak, to a lower frequency.

Amplification of Transformer.—Uniformity of amplification in a transformer is one of the greatest virtues this part of a radio receiver may have. Amplification is the ratio of the voltage delivered by the secondary circuit to the voltage delivered to the primary circuit at various frequencies.

The lowest audible frequencies are of the order of twenty per second. The highest frequencies of pure tones are around five thousand per second. The harmonics and overtones reach frequencies higher than ten thousand per second. An audio frequency transformer is expected to give perfectly even amplification to all of these frequencies. In practice it cannot be done but some

TRANSFORMER, AUDIO FREQUENCY

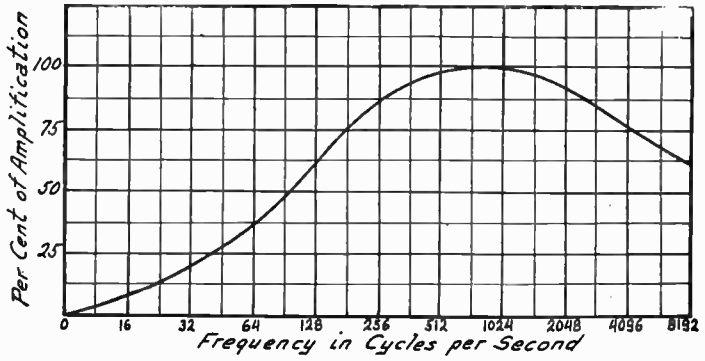

FIG. 3.—Amplification Curve of a Poor Audio Transformer.

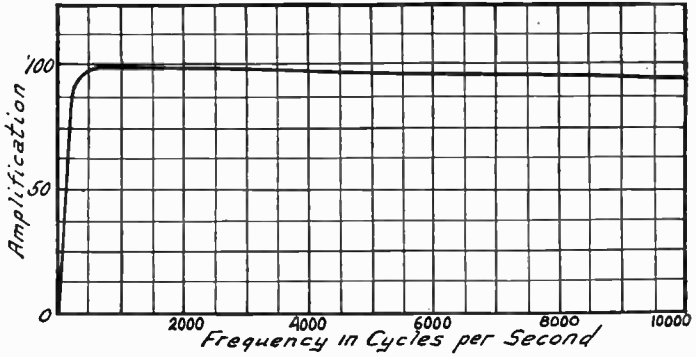

FIG. 4.—Curve for Good Audio Transformer Drawn on Arithmetical Scale.

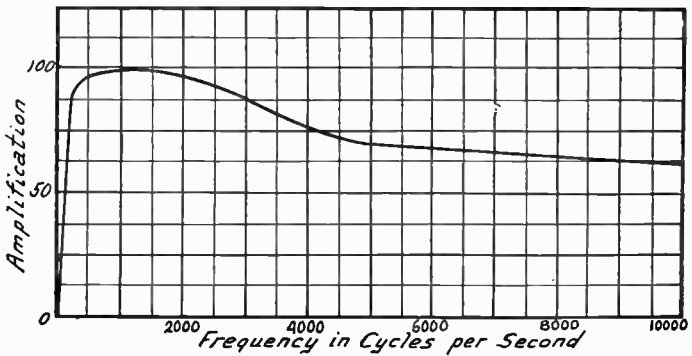

FIG. 5.—Curve for Poor Audio Transformer Drawn on Arithmetical Scale.

TRANSFORMER, AUDIO FREQUENCY

of the high grade transformers come remarkably close to the ideal. An amplification curve for one of the best audio frequency units is shown in Fig. 2. The amplification curve for a poor transformer is shown in Fig. 3. It will be seen that uneven amplification will cause notes of certain frequencies to sound almost twice as loud as notes of low frequency and to sound much louder than notes of higher frequencies.

An amplification curve for a transformer drawn with the vertical lines of the curve marked off evenly according to hundreds or thousands does not give a correct idea of the transformer's uniformity or lack of uniformity in amplifying different frequencies.

If the first key is struck in the various octaves of a piano, starting at the lowest notes and working toward the high notes, the same note in the second octave sounds twice as high pitched as that note in the first octave. It is actually true that the frequency is doubled for each succeeding octave. The lowest note on the piano vibrates at a frequency of 27 times per second. The frequencies of successive octaves in one kind of musical scale start with the

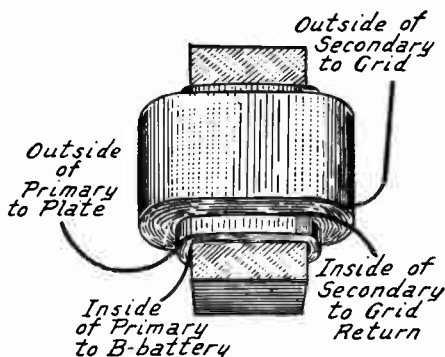

FIG. 6.—Windings and Connections of Audio Frequency Transformer.

following number of cycles per second; 32, 64, 128, 256 (middle C), 512, 1024 and 2048, etc. It is this type of scale that should be used in drawing curves of amplification. The amplification curves for a good transformer and for a poor one are shown in Figs. 2 and 3. They are drawn to this scale of frequencies. In Figs. 4 and 5, the same transformers are shown drawn to a scale which increases by hundreds—400, 800, 1200, 1600 and 2000. It will be seen that the second method makes the poor transformer appear almost as good as the better one.

It has already been explained that proper amplification of the low frequencies is secured by increasing the number of primary turns, by increasing the size of the core, and by using core iron of high permeability. The high frequencies are properly amplified in transformers having small distributed capacity.

Transformer Construction.—In the construction of transformers the secondary winding is on the outside and the primary winding is between the core and the secondary. Terminal connections of these windings are made as shown in Fig. 6. The out-

TRANSFORMER, AUDIO FREQUENCY

side of the secondary winding is connected to the grid of the following tube. The inside of the secondary winding is connected to the grid return, a C-battery or the filament circuit. The outside of the primary is connected to the plate of the preceding tube. The inside of the primary is connected to the B-battery or other voltage supply unit.

The cores in practically all iron-core transformers are made up of a large number of thin sheets of transformer iron or steel. These thin sheets are called laminations and the core is called a laminated core. The purpose of the laminations is to reduce the eddy currents. These eddy currents can flow only in the single laminations and cannot grow large by flowing through the entire mass of iron in the core. The laminations are electrically insulated from one another by the coating of scale upon their surfaces or by insulating varnish.

The arrows in Fig. 7 show the path taken by the magnetic lines of force and it is seen that the laminations are continuous so far as the magnetic path

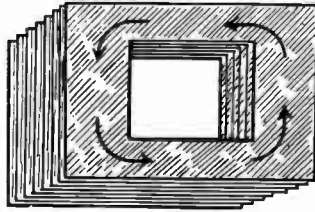

FIG. 7.—Laminated Core Construction for Audio Frequency Transformer.

is concerned. There is little reduction in the permeability of the core but the eddy current loss is reduced because any given eddy current is confined to the one thin lamination in which it arises.

Some audio frequency transformers are completely enclosed within a sheet iron housing. This housing forms a shield for the transformer and may be grounded. In the shell type of transformer the iron of the core forms a partial shield. The secondary winding is outside of the primary winding as in Fig. 6 and if the secondary carries no current there will be so little field around the transformer that shielding is almost uncalled for. There will be no secondary current as long as the grid bias remains sufficiently negative.

Turn Ratio and Voltage Ratio.—It is desirable to obtain a step-up of voltage in a transformer provided this step-up may be had without sacrificing other desirable qualities, principal among which is uniform amplification at all frequencies.

In the explanation of the effect of turn ratio under the heading of *Transformer* ideal conditions were assumed. It is unfortunate that in practice the actual voltage ratio is not the same as the turn ratio but is considerably less. A transformer having a turn ratio of three to one will not deliver three times the voltage from its secondary circuit that is applied to its primary.

The voltage ratio is affected by the frequency being handled. The step-up of voltage is lower at low frequencies than at high fre-

TRANSFORMER, AUTO-

quencies. It is especially low when the windings are both of small impedance.

A transformer having a high turn ratio generally has a primary of small size and small impedance because the high ratio calls for a large secondary which takes up most of the winding space. When using such a transformer, with a small primary winding and a very large secondary winding, it is sometimes found that there is no step-up whatever or that there is an actual loss in voltage as well as in current.

The actual voltage ratio of a transformer is equal to the square root of the ratio of secondary impedance to primary impedance. Since impedance depends on frequency, on reactance and on resistance, it is apparent that the voltage ratio of a transformer may be something quite different from its turn ratio.

It has been shown that a large primary is desirable to amplify low frequencies while a small secondary is desirable to reduce distributed capacity and amplify high frequencies. A large primary and small secondary would prevent building the transformer with a step-up turn ratio to increase the voltage. The one factor which may be changed to improve both low frequency and high frequency amplification is the core. A large core built of iron having high permeability makes a better transformer from every standpoint.

The amplification of high ratio transformers is good at the middle frequencies but is generally very poor at low frequencies and quite poor at the higher frequencies. In Fig. 3 is shown the amplification curve for high ratio transformer (6 to 1) and in Fig. 2 for a low ratio (2 to 1) transformer. It will be seen that the high ratio instrument gives its best amplification between 500 and 2,000 cycles but gives much less amplification either below or above these frequencies. A high ratio transformer will deliver a great deal of volume but generally gives poor quality. This applies to ordinary transformers of low cost. Of course if a transformer is built large enough, which means costly enough, a transformer of moderately high ratio may be made to give practically uniform amplification at all frequencies.

Comparative tests of audio transformers are described under *Oscillator, Audio Frequency, Uses of*. See also *Distortion and Impedance, Matching of*.

TRANSFORMER, AUTO.—The auto-transformer has its primary and secondary windings conductively connected to each

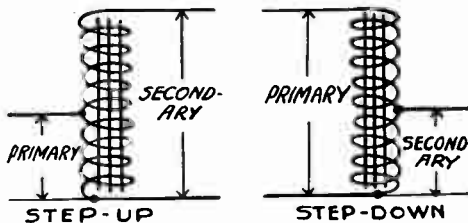

FIG. 1.—Principle of the Auto-Transformer.

other as shown in Fig. 1. In the step-up auto-transformer the entire length of winding is included in the secondary and only a part of it is in the primary circuit. In the step-down auto-transformer the entire length of winding is in the primary and only a part in the secondary circuit.

TRANSFORMER, AUTO-

The voltage ratio of an auto-transformer is the ratio of the number of secondary turns to the number of primary turns just as in any other type of transformer. This is shown in Fig. 2. The transformation or transfer of energy from primary to secondary is somewhat greater in an iron-core auto-transformer than in an ordinary iron-core transformer having two separate windings. This is because a part of the energy is transformed while part flows through

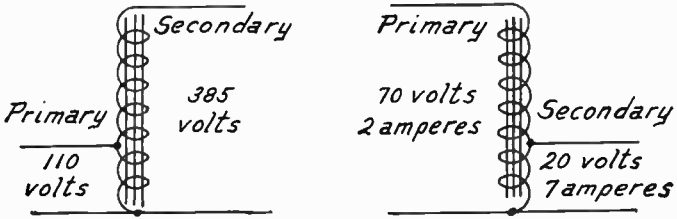

FIG. 2.—Voltage Ratios of Auto-Transformers.

the windings conductively. One form of auto-transformer is found in the type of impedance coupled amplifier which uses a tapped winding to obtain a step-up ratio of voltage.

Iron-core auto-transformers are used for power work such as battery charging transformers, also for audio frequency amplifier couplings in some forms of impedance or modified choke coupling. Air-core auto-transformers are fre-

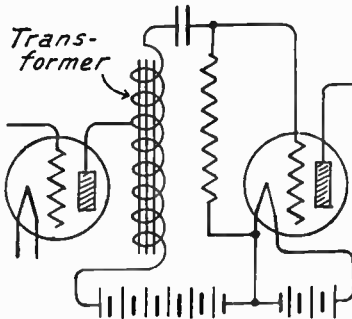

FIG. 3.—Auto-Transformer Interstage Coupling.

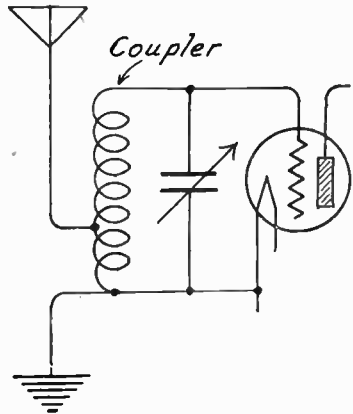

FIG. 4.—Auto-Transformer Antenna Coupling.

quently used as couplings for the antenna circuit and first tuned circuit in a radio receiver and are sometimes used as interstage couplings between radio frequency amplifying tubes. The general principle of auto-transformer interstage coupling is shown in Fig. 3 and the use of the auto-transformer as an antenna coupler is shown in Fig. 4.

TRANSFORMER COUPLED AMPLIFIER

TRANSFORMER COUPLED AMPLIFIER.—See *Amplifier, Audio Frequency, Transformer Coupled*; also *Amplifier, Radio Frequency, Tuned Transformer Coupled*.

TRANSFORMER COUPLING.—See *Coupling, Transformer*.

TRANSFORMER, MICROPHONE.—The transformer through which a microphone is coupled to the circuits of a radio transmitter. See *Modulation*.

TRANSFORMER, OSCILLATION.—A transformer used for coupling the output of an oscillating vacuum tube to another circuit or for coupling the output circuit to the input circuit so that the necessary feedback of energy may be provided for maintaining oscillation. See *Oscillator*.

TRANSFORMER, OUTPUT.—In radio receiving circuits, the transformer which couples the plate circuit of a vacuum tube to the loud speaker circuit. See *Speaker, Loud, Connections to Receiver and Impedance, Matching of*.

TRANSFORMER, PEAKED.—An audio frequency transformer having a resonant peak at a certain frequency which is to be received, thus allowing great amplification of this frequency. The peaked transformer is used in the reception of radio telegraph signals transmitted by continuous waves, the peak generally being between 900 and 1,200 cycles. Any audio frequency transformer may be peaked by the use of a fixed condenser across its secondary winding. See *Resonant Peaks* under the heading of *Transformer, Audio Frequency*.

TRANSFORMER, PHASE RELATIONS IN.—See *Phase Relations in Transformer*.

TRANSFORMER, POWER.—A transformer used for handling considerable power as distinguished from audio frequency and radio frequency transformers which handle extremely small powers as measured in watts. Small sizes of power transformers are used in battery chargers and power supply devices. Power transformers are of the iron-core type.

TRANSFORMER, PUSH-PULL.—A special form of audio frequency transformer provided with a center tap either in the secondary or in the primary winding. See *Amplifier, Audio Frequency, Push-Pull Type*.

TRANSFORMER, TUNED RADIO FREQUENCY.—A tuned radio frequency transformer is an air-core transformer designed for the transfer of energy between circuits operating at very high frequencies, at radio frequencies. This type of transformer consists of two or more air-core coils, as in Fig. 1. The factors entering into its design, its action, its construction and its losses of power are those of the coils of which the transformer is constructed. All such details are covered under the heading of *Coil* which should be referred to for further information.

TRANSFORMER, TUNED RADIO FREQUENCY

Amplification of Tuned Transformer.—The voltage amplification of an air-core radio frequency transformer depends only in part on the turn ratio. The leakage of lines of force between primary and secondary of a radio frequency transformer is so great and the coupling is necessarily so small that little or no voltage gain is actually realized when using the usual constructions.

With a tuned transformer the required inductance, or number of turns, in the secondary depends on the frequencies to be handled and on the maximum capacity of the tuning condenser used with the transformer. The number of turns in the secondary winding may therefore be regarded as a fixed quantity. Any increase in the number of primary turns will increase the transfer of power and with usual design will increase the voltage in the secondary up to the point at which the primary inductance is equal to the secondary inductance. In other words, the greatest gain is obtained in an air-core radio frequency transformer when the primary and secondary are alike in inductance.

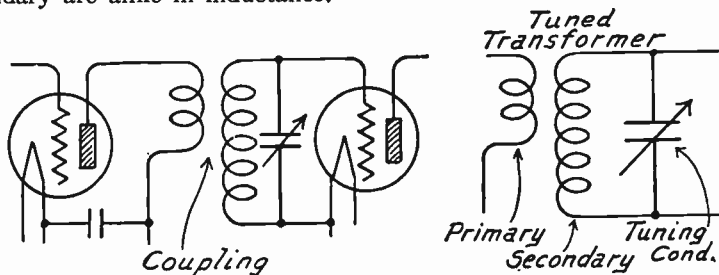

FIG. 1.—Tuned Radio Frequency Transformer Used as Coupler.

We may start with an air-core transformer having a turn ratio such that its secondary voltage is equal to its primary voltage. Then, leaving the secondary unchanged and increasing the number of primary turns, at first it will be found that doubling the original number of primary turns will nearly double the amplification and tripling the number will nearly triple the amplification. This gain of voltage amplification with multiplication of the number of primary turns does not continue indefinitely but grows gradually less until, when the primary inductance is greater than the secondary inductance, there is a loss of voltage because of the step-down effect.

It would seem possible to get extremely high voltage amplification and high transfer of power by increasing the primary turns until we had a transformer with a turn ratio of one to one. But the practical limit in gain is reached when it becomes impossible to control oscillation due to the feedback through the plate-grid capacity of the tube. With two or more stages of radio frequency amplification this limit is reached with an overall voltage amplification of about three to one in each stage.

The voltage amplification in air-core radio frequency transformers depends to a great extent on the degree of coupling between primary and secondary windings. Were the coupling in such a transformer gradually changed from very close coupling to very loose, and were the voltage amplification to be measured as the coupling changes, the conditions would be found as follows:

TRANSFORMER, TUNED RADIO FREQUENCY

The voltage amplification would be fairly high with the closest possible coupling, but the tuning would be broad. As the coupling was loosened, the voltage amplification would increase and would become maximum with only a moderately close coupling between the windings. Still looser coupling would decrease the voltage amplification until it would finally become minimum with very loose coupling. This is indicated in Fig. 2. See also *Coupling, Optimum*.

Maximum possible voltage gain in a radio frequency transformer is secured by using the largest primary that will allow control of oscillation and by experimenting to find the coupling that gives the greatest power gain or voltage gain in the amplifying stage of which the transformer is a part.

Effects of Tuning Condensers.—In a tuned radio frequency transformer the secondary is usually much larger than the primary, the turn ratio being somewhere in the neighborhood of three to one down to eight to one. Since the two windings are rather closely coupled, tuning the secondary circuit to a certain frequency has

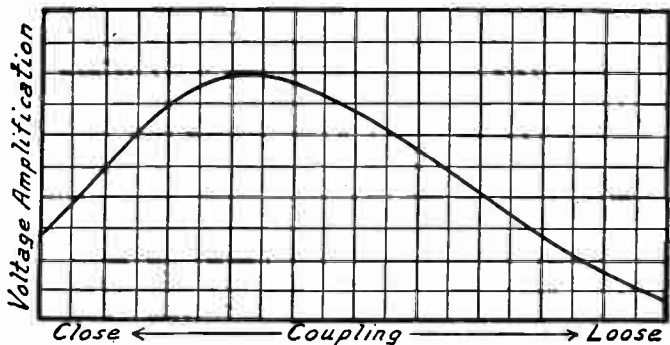

FIG. 2.—Effect of Coupling in Tuned Radio Frequency Transformers.

the effect of tuning the primary circuit to the same frequency because the two windings have a fairly high mutual inductance.

Therefore, it is not necessary to tune the primary circuit with a separate condenser, although this is sometimes done as in Fig. 3. With the primary separately tuned to the frequency being received and with the secondary also tuned with its own condenser to the same frequency, it is possible to get a very great transfer of power from primary circuit into secondary circuit. The impedance is reduced to a minimum in both circuits and the received frequency causes maximum current to flow in both. With this scheme, feedback of energy is very difficult to control since the primary winding in the output circuit of a tube is tuned to the same frequency as the input or grid circuit not only of the following tube, but also of the same tube. The feedback through the capacity between plate and grid is large enough to cause oscillation unless there is great damping or a large load of some kind on the tube's grid circuit.

TRANSFORMER, TUNED RADIO FREQUENCY

As a general rule the tuning condenser in the secondary circuit of a radio frequency transformer should have the smallest capacity that will allow tuning over the entire range of broadcasting frequencies or other frequency band to be handled. This allows the largest possible inductance in the secondary winding, the largest possible coil as indicated in Fig. 4. The greater the coil's inductance the greater will be the voltage changes across its ends when

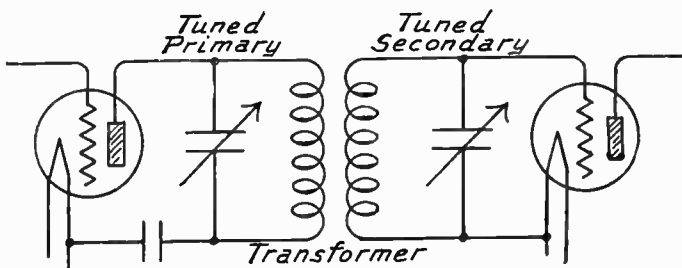

FIG. 3.—Radio Frequency Transformer with Tuned Primary and Tuned Secondary.

power is applied to it. These greater changes in voltage are applied to the grid of the following tube, resulting in considerably greater overall amplification than is secured with a small coil and a large condenser in the tuned circuit of the transformer.

The limit of coil size or inductance in a tuned radio frequency transformer is reached when the secondary circuit has a natural frequency within the band

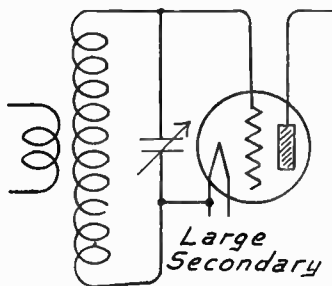

FIG. 4.—Large Secondary Giving Increased Power or Voltage.

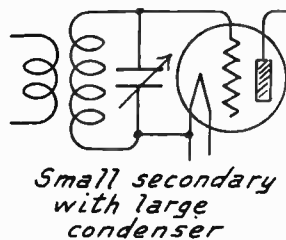

FIG. 5.—Small Secondary Reducing Voltage and Increasing Stability.

of frequencies to be handled by the receiver. If the coil has large inductance it may be found that the combination of the coil's distributed capacity and the tuning condenser's minimum capacity will form a circuit which is resonant to some high frequency. That is, the inductance of the coil together with the capacities of coil and condenser will tune naturally to some high frequency or low wavelength.

If the frequency is within the broadcasting band, for a broadcast receiver, it will be impossible to tune to any higher frequency or any lower wavelength because the minimum of capacity is not low enough. Then the coil con-

TRANSFORMER, UNTUNED RADIO FREQUENCY

struction must be changed to reduce its distributed capacity, the condenser must be changed for one having a lower minimum capacity, or a smaller coil and larger condenser must be used as in Fig. 5.

A condenser placed across the secondary winding of a transformer not only acts as a capacity across this winding but also has an effect on the primary winding that is much the same as though a condenser were connected across the primary. This effect of the capacity across the secondary reacts on the primary inversely as the square of the turn ratio. This is strictly true only with the closest possible coupling, a condition which never exists in radio frequency transformers. But with actual couplings the effect still exists to a considerable degree.

As an example of this effect on the primary assume a transformer with ten primary turns and fifty secondary turns, a turn ratio of 10/50. The square of this ratio is 100/2500, or 1/25. Then, with a condenser of .0005 microfarad capacity across the secondary, there would be the effect of 1/25th this capacity, or .00002 microfarad, across the primary winding.

Matching of Transformers.—When a radio frequency amplifier includes two or more radio frequency transformers these transformers should be like one another in every respect.

While it is not necessary to wind the primary turns in the same direction as the secondary turns, clockwise or anti-clockwise, the primary windings in all transformers should be wound the same way and the secondaries in all the transformers should likewise be wound the same way.

See also *Coupling, Coefficient of; Coupling, Optimum; Coupling, Effect on Resonance; and Oscillation.*

TRANSFORMER, UNTUNED RADIO FREQUENCY.

—In the earlier days of broadcasting all stations transmitted on a 360-meter wavelength. Later on they all transmitted either on 360 meters or on 450 meters. The total range of broadcast reception then covered only about 167 kilocycles, whereas it covers 950 kilocycles with stations using wavelengths from 200 meters to 545 meters. With only two frequencies in use, selectivity was a consideration of minor importance and the thing most desired was power or distance-getting ability.

Untuned iron-core transformers were then used for coupling between radio frequency amplifying tubes. No tuning controls were required for these transformers and they would give fairly uniform amplification either at 360 meters or at 450 meters wavelength. But with hundreds of stations operating in nearly one hundred different channels or wavelengths the broad tuning iron-core or untuned radio frequency transformer has practically disappeared except for the intermediate amplifying stages of the superheterodyne where this type is built to give great amplification at only one frequency, the intermediate frequency.

The drawing shows the construction of an untuned iron-core transformer. The core consists of laminations only a little more than three-thousandths of an inch thick, number 44 gauge. These form a rectangular core of three-eighths inch square cross section with two large air gaps measuring about 0.05 inch each. The primary winding is on one side of the core and the secondary on the other. Both windings are of number 40 enamelled copper wire, the primary having about 160 turns and the secondary having about 220 turns. Such a transformer amplifies with fair uniformity over the entire broadcasting range, but of course has no inherent selectivity whatever. It may be used

TRANSMISSION

to give the added power of an extra radio frequency stage when other tuned stages give all the required selectivity.

The tuning of the iron-core radio frequency transformer is broadened by the great eddy current losses that occur in the iron at high frequencies, the higher the frequency the greater being the loss. When the core is made of laminations they must be insulated from one another by the natural scale or by varnish. The edges must be smooth since roughness might allow short circuits between adjacent pieces of the iron. To avoid the troubles of iron laminations these transformers are sometimes made with cores of prepared iron dust.

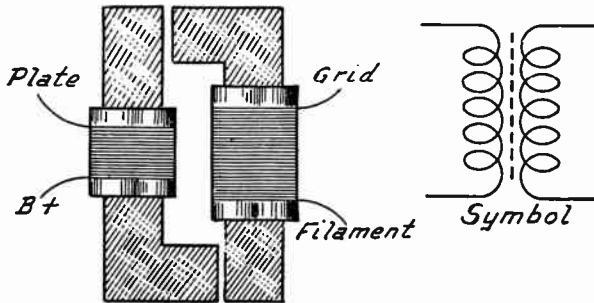

An Iron-Core Untuned Radio Frequency Transformer.

The principal losses in iron-core radio frequency transformers come from the action in the iron, the losses that may occur in the wire of the winding are of minor importance. Because of this it is advisable to use wire of very small size which makes a small coil and allows the use of a small iron core.

TRANSMISSION.—See *Radiation; Broadcasting; and Radio Principles of.*

TRANSMISSION, BEAM.—Transmission or radiation of radio waves in only one direction from the transmitter rather than in all directions is called beam transmission. The principle of reflection is used, the reflector being composed of a large number of vertical wires placed around the transmitter so that this reflector is in the form of a parabola with the transmitter at its focus. Waves from the transmitter striking the reflector are thrown back and directed into one straight beam just as light from a lamp may be thrown into a straight beam rather than being spread equally in all directions. The waves from a beam transmitter form an angle only about fifteen to twenty degrees wide.

TRANSMISSION UNIT.—See *Unit, Transmission.*

TRANSMITTER.—All of the electrical equipment by means of which radio waves are produced, modulated and radiated is called a transmitter. See *Broadcasting; Modulation; and Radiation.*

TRAP, WAVE.—A wave trap is a device which is designed to reduce or eliminate signals from other broadcasting stations than the one it is desired to hear.

There are two principal types of wave trap, one being called the absorption type and the other the impedance type. The absorption

TRAP, WAVE, ABSORPTION TYPE

trap attempts to absorb and thus destroy the interference while the impedance type tries to prevent the interference from entering the receiver circuits.

Still other devices are sometimes called wave traps, although not properly so classed. These other devices are built as outside attachments for receivers. They do not attempt to absorb and dissipate the interference, nor do they depend only on preventing the interference from entering the receiver. They add to the inherent selectivity and power of the receiver by adding a stage of tuned radio frequency amplification between the receiver and its antenna. These are variously called intensifiers, filters, boosters and other descriptive names.

These devices may be constructed by placing one complete stage of tuned radio frequency amplification in a separate cabinet or box so that it may be properly inserted between the antenna-ground circuit and the receiver already in use. Several designs are shown and described under the heading *Trap, Wave, Radio Frequency Type*.

TRAP, WAVE, ABSORPTION TYPE.—The principle of the absorption type of wave trap is shown in Fig. 1 and the layout in Fig. 2. The condenser and large winding on the coil may be of any combination of sizes which will tune over the broadcasting band of frequencies. See *Coil, Tuning, Sizes Required for*. The small coil which is connected into the antenna circuit need have only four

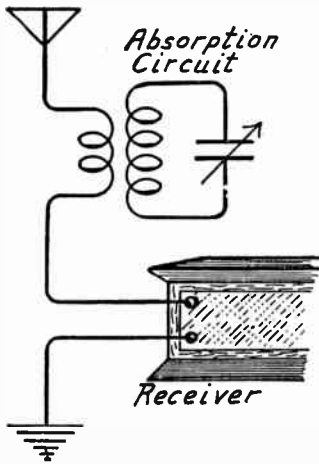

FIG. 1.—Circuit of Absorption Wave Trap.

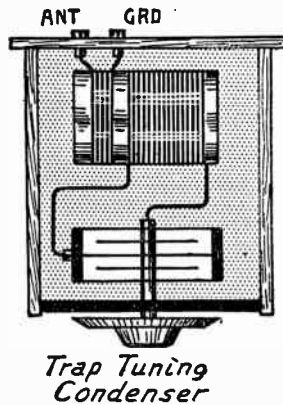

FIG. 2.—Layout of Absorption Wave Trap Unit.

or five turns. The closer the coupling between the coils, the closer they are to each other, the more effective the trap will be in preventing interference but the more it will affect the tuning of the receiver controls. The smaller the condenser and the larger the coil connected to it the more effective the trap will be in absorbing the undesired signal.

When in operation the trap is connected between antenna and receiver as shown in Fig. 1. The trap dial is placed at zero and

TRAP, WAVE, IMPEDANCE TYPE

the offending signal tuned in with greatest possible volume on the receiver controls. Without again touching the receiver controls, the dial of the trap condenser is turned to the point where the unwanted signal is weakest. The trap is allowed to remain at this setting as long as that particular frequency or wavelength is to be eliminated and the receiver is then tuned to other stations in the usual way.

The tuned circuit in the wave trap is now adjusted to resonance with the signal to be eliminated and the greatest current will flow in the trap circuit at this signal frequency. Since this current is caused to flow by energy taken out of the antenna circuit, energy at the tuned frequency will be absorbed in the trap and will not reach the receiver.

Because of the coupling between the trap circuit and the antenna circuit which goes into the receiver, the receiver tuning will be quite decidedly affected and a log of settings made without the trap will no longer be correct when working near the frequency to which the trap is tuned. The dial settings on the receiver may be as much as ten points lower when working right up near the trap frequency. This deviation will become less as the receiver controls are moved from the trap frequency until, at points quite distant on the receiver dial, the setting will be affected but little. This change in settings of the receiver will affect only the first dial, the dial nearest the antenna circuit.

TRAP, WAVE, IMPEDANCE TYPE.—The operating principle of the impedance type of wave trap is shown in Fig. 1.

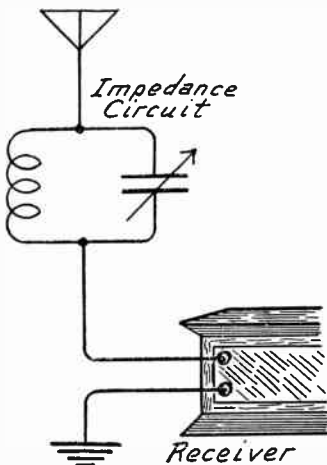

FIG. 1.—Circuit of Impedance Wave Trap.

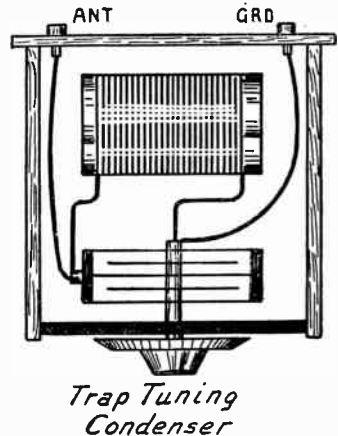

FIG. 2.—Layout of Impedance Wave Trap Unit.

The layout for such a device is shown in Fig. 2. With a poorly constructed antenna system, with a poor ground, or with a very long antenna the impedance type of trap will generally be found

TRAP, WAVE, RADIO FREQUENCY TYPE

more satisfactory than the absorption type. However, the impedance type upsets the dial settings of the receiver more than does the absorption type.

The coil and condenser are selected to tune over the broadcasting band of frequencies according to the information given under *Coil, Tuning, Sizes Required for*. With the impedance trap it is more satisfactory to use a large condenser and a coil of small inductance. The impedance trap is more positive in its action and makes a more nearly complete elimination of interference than the absorption type but it also tends to obliterate the receiver's response to all neighboring frequencies.

This type of trap is operated in exactly the same way that the absorption trap is operated and it has much the same effect on the settings of the receiver controls.

No type of trap built on either the absorption principle or the impedance principle will allow tuning out a powerful and nearby local broadcaster so that distant stations of nearly the same frequency can be brought in. These wave traps are of assistance when a receiver will not tune out one local station so that other local stations may be received. They both absorb so much power that signals from distant stations operating near the frequency at which the trap is set are completely destroyed.

TRAP, WAVE, RADIO FREQUENCY TYPE.—The radio frequency type of wave trap adds one stage of tuned radio frequency amplification to the receiver. This adds to the sensitivity and distance range of the receiver, greatly increases the selectivity of the combination, and reduces or prevents re-radiation from the receiver all at the same time. The only disadvantage of this type of trap is its first cost and the fact that it adds the operation of one more control.

The radio frequency trap should be balanced or neutralized so that free oscillations cannot be set up in its circuits at any frequency within the range of wavelengths to which it will be tuned. Any oscillation control incorporated within the receiver can have no effect in preventing oscillation within the added wave trap. It is the balancing and prevention of oscillation in the trap circuits that keeps the receiver from re-radiating.

When using absorption or impedance types of wave trap the trap is set once for all to the frequency to be excluded and the receiver is then tuned as usual without regard for the trap. But with the radio frequency trap it is necessary to tune the trap itself to each signal frequency to be received in addition to tuning the receiver as usual. Thus the trap adds one tuning control. The use of a trap of this type will change the settings on the first tuning control of the receiver but the receiver and trap together may be logged for the new settings.

Fig. 1 shows the circuits for a radio frequency stage employing the Rice method of balancing. This unit may be placed between the antenna and the receiver to gain all the advantages of an added radio stage. The layout for the trap of Fig. 1 is shown in Fig. 2.

The coupler tuned coil and condenser may be of any sizes which tune together over the broadcasting band, these sizes being given under *Coil, Tuning, Sizes Required for*. The coil in the antenna circuit should consist of about

TRAP, WAVE, RADIO FREQUENCY TYPE

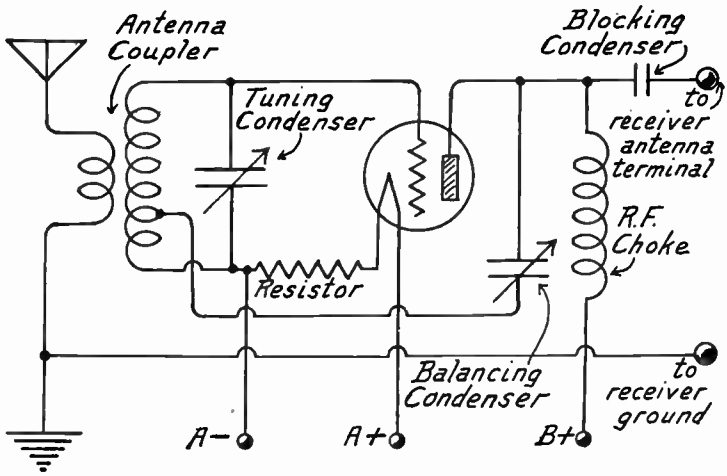

FIG. 1.—Circuit of Added Radio Stage with Balanced Control of Oscillation.

fifteen to twenty turns closely coupled to the tuned coil. The tube is indicated with its fixed filament resistor. The balancing condenser is connected between the tube plate and a tap on the tuned coil which is about one third of the way from the filament end toward the grid end of the winding. The

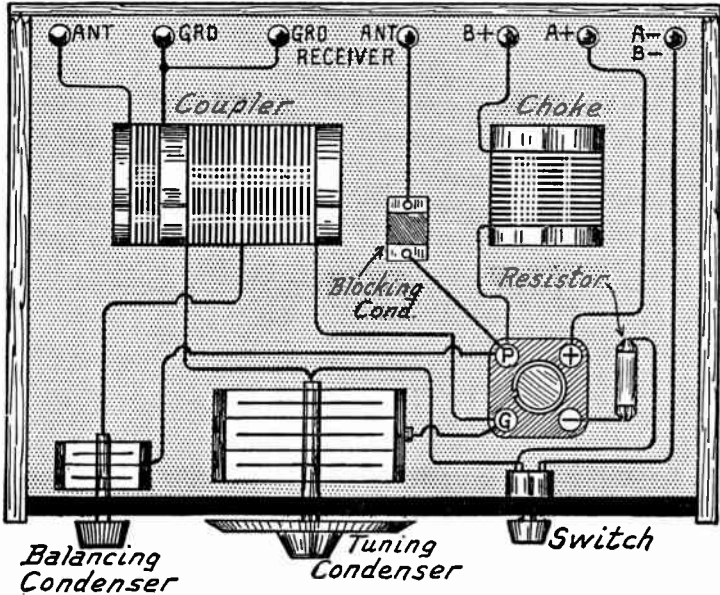

FIG. 2.—Layout of Added Radio Stage with Balancing Condenser.

TRAP, WAVE, RADIO FREQUENCY TYPE

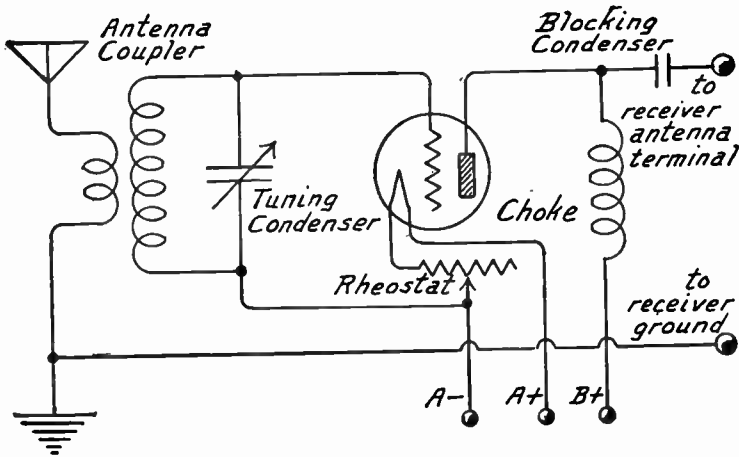

FIG. 3.—Circuit of Added Radio Stage Without Balancing.

output of the tube is carried to the antenna terminal of the receiver through the blocking condenser which should be of .002 to .005 microfarad capacity. Plate voltage is supplied to the tube through the radio frequency choke which may be any of the marketed types of radio choke coil or a 750-turn honeycomb

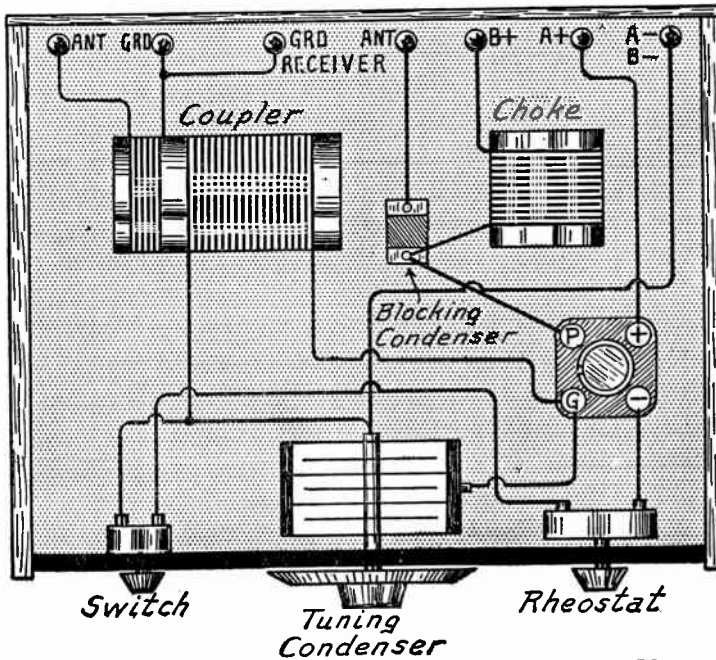

FIG. 4.—Layout of Added Radio Stage Without Balancing Means.

TRAP, WAVE, RADIO FREQUENCY TYPE

coil. The tuned coil and the choke coil should be in non-inductive relation to each other, should be placed to have zero coupling.

It is not necessary to place the balancing condenser on the panel as shown in Fig. 2 since this condenser is balanced only once for each tube used and as long as the same tube is kept in use the balancing condenser need not be adjusted again.

Figs. 3 and 4 show the circuit diagram and the layout of a tuned radio frequency stage which does not employ any method of balancing the tube feedback but depends on adjustment of the filament rheostat to prevent oscillation. This method is simple to build, easy to operate, and very sensitive. But it allows the receiver to re-radiate and in fact may make re-radiation worse than before.

The antenna coupler, the tuning condenser, the tube, the choke and the blocking condenser are the same as corresponding units for Figs. 1 and 2.

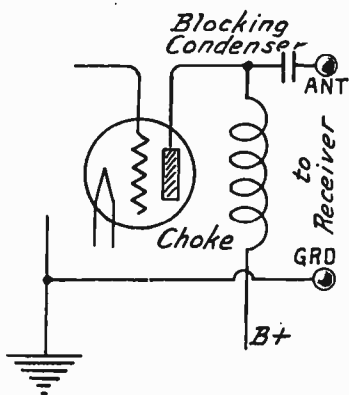

FIG. 5.—Output Choke and Blocking Condenser for Added Radio Stage.

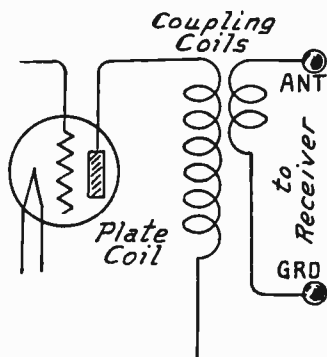

FIG. 6.—Output Coupling Coils for Added Radio Stage.

The tuned coil is not tapped. The tube filament control is now a variable rheostat of 25-ohms resistance.

In designing any tuned radio frequency trap it is assumed that it may be connected to any type of receiver. Therefore, the high plate voltage for the tube in the trap must not be allowed to pass into the receiver. Hence the blocking condenser. Were this condenser omitted the plate voltage would, in many types of receivers, be fed into the filament circuit of the receiver and would promptly burn out the filaments of all the tubes.

Any type of tuned radio frequency amplifying stage may be used provided the plate current for the tube is kept out of the receiver. The plate circuit of any tube thus used may be handled as shown in Fig. 5 to accomplish this object. The diagram shows the blocking condenser and choke coil scheme used in Figs. 1 to 4.

The diagram in Fig. 6 uses an air-core coil of fifty or more turns connected between the tube plate and the B-battery or plate voltage supply unit. Closely coupled to this coil is another winding consisting of three or four

TRICKLE CHARGER

turns of wire connected between the terminals leading to antenna and ground posts on the receiver. This small winding makes a link circuit between the trap stage and the receiver circuits. Since this latter method does not connect the receiver to ground, as do the methods of Figs. 1 to 4, the receiver may be less stable and it will be more difficult to prevent oscillation than with the method shown at the left in Fig. 5.

TRICKLE CHARGER.—See *Charger, Battery, Trickle Type*.

TRIODE.—Another name for the three-element vacuum tube. See *Tube*.

TRIPLE CIRCUIT JACK.—See *Jacks and Jack Switches, Types of*.

TROUBLE, BATTERY WEAKNESS AND RESISTANCE.—When dry cell batteries or storage batteries become nearly discharged they not only reduce the voltage and current to their circuits in the receiver, but they greatly increase their own resistance and give rise to noisy and irregular operation which might be rather difficult to trace to a cause were the batteries not tested.

The condition of dry batteries is tested to best advantage with a voltmeter which reads to a voltage at least as high as the normal voltage of the battery to be investigated. Dry cells used as filament batteries should be tested for voltage while connected to the receiver and while the receiver switch is turned on. Under these conditions such batteries should deliver at least 1.25 volts for each cell. Two cells in series should deliver at least 2.5 volts. Lower voltages indicate practically complete discharge and the battery should be replaced.

Dry batteries used as plate batteries or B-batteries should be replaced with new ones when the voltages are as follows: a 22½ volt battery showing 17 volts; a 45 volt battery showing 34 volts; and a 90 volt battery showing 65 volts. Dry batteries used for grid bias or C-batteries should be replaced when they show as low as 1.4 volts per cell because of the noises they cause in the receiver.

Storage batteries or wet batteries used for filament supply A-batteries, or as plate supply B-batteries, should be tested with a hydrometer, testing the specific gravity of the electrolyte liquid in each separate cell. When this gravity shows as low as 1.200 the battery is ready for recharging and when the gravity drops to 1.150 or below the battery is completely discharged and should no longer be used until fully charged.

For complete information on battery testing, care and charging see *Battery, Dry Cell Type*; and *Battery, Storage Type*. Charging methods are described under the heading of *Charger, Battery*.

TROUBLE, BURNOUTS.—Most of the conductors used in making radio receiver connections and most of the wiring in units of the tuner and radio frequency amplifier are so large that they will seldom if ever be burned out by any amount of current that can reach them. Burnouts are generally found in the tube filaments and in the windings of audio frequency transformers and chokes.

Burned out tube filaments are generally caused by short circuiting

TROUBLE, CIRCUIT, OPEN

the B-battery voltage through the filament circuits of the receiver either by wrong connections made when a receiver is placed in operation or by experimenting with a screwdriver or other metallic object among the receiver wiring. Filaments are hardly ever burned out by excessive filament battery voltage, although their life may be greatly shortened by too high voltage. The full voltage of a filament battery of normal size is not enough to burn out the filaments in five-volt tubes.

Most of the power supply units for plate voltage will not furnish sufficient current to burn out a tube filament. Most of these units will not deliver more than one hundred milliamperes of current under any conditions. To operate the filament of a quarter-ampere tube requires two hundred and fifty milliamperes while for a half-ampere tube it requires five hundred milliamperes for normal operation. Of course, much more than normal current must flow to cause a burnout and this the ordinary plate supply unit is unable to give. The filament of even the smallest dry cell tube requires sixty milliamperes for normal operation.

The surest way to save the tube filaments when a receiver has been worked upon and is ready for reconnection to batteries is to leave the B-battery entirely disconnected at first. Then connect the negative side of the A-battery to the B-battery negative terminal of the receiver. Next turn on the receiver switch and leave it on. To make the test touch the positive line from the A-battery to the B-battery terminals of the receiver one after the other, taking in both detector and amplifier B-battery terminals. With each temporary connection look at the tubes. No filaments should light. If any light it indicates that the B-battery connected in the regular way would burn out the filaments, consequently the wiring and connections should be examined for wrong connections and short circuits.

Among the more common causes for burned out audio frequency transformer windings are the following: A short circuited detector plate bypass condenser; this being the small fixed condenser often connected between the plate terminal and one of the filament terminals of the detector tube. A tube with a short circuit between the plate and grid will burn out the secondary winding of the transformer preceding the tube.

TROUBLE, CIRCUIT, OPEN, LOCATION OF.—An open circuit is a conducting path which is not complete from the source of current to the current consuming device and back again to the source. No current will flow in any part of a circuit that is open. Opens may occur in any of the circuits of a radio receiver. These circuits are described and shown under the following headings: *Antenna, Circuit of; Circuit, Filament; Circuit, Grid; and Circuit, Plate.*

Open circuits are located by bridging around the open point with some device which will indicate voltage or a flow of current. In radio work circuit testing of all kinds is easily done with a pair of headphones or with a voltmeter to which are attached rather long flexible wires ending in test points.

The principle of testing for open circuit is shown in Fig. 1. The battery is connected to the circuit *A-B-C-D*. The circuit is assumed to be complete

TROUBLE, CIRCUIT, OPEN

from the left hand terminal of the battery to point *A*, on through to point *B* and on to point *C*. But the resistor between *C* and *D* is assumed to be open circuited. Consequently no current will flow from the battery into any part of the circuit.

If a voltmeter is connected temporarily between points *A* and *B* no voltage will be indicated because there is no current flow and no voltage drop between these points. But when the voltmeter is connected across the resistor *C-D*, battery voltage will be indicated by the voltmeter because the circuit is complete from the battery around to point *C* and also from point *D* back to the battery.

The voltmeter is bridged across each part or section of the suspected circuit and when it indicates battery voltage the open circuited connection or units exists between the points to which the voltmeter is then connected. The voltmeter's range should be at least as great as the maximum voltage of any battery or power supply unit in the circuit.

Headphones may be used in place of the voltmeter and the test may be made exactly as shown in Fig. 1. When the headphone cord tips are touched to the circuit at points such as *A* and *B* there will be no sound. But when

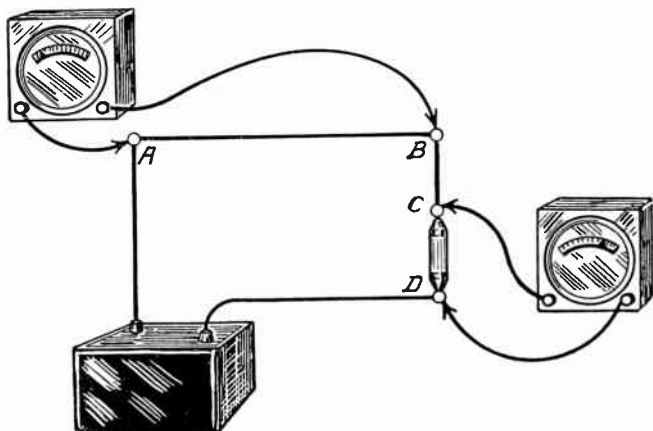

FIG. 1.—Principle of Testing for Open Circuits.

the phone tips are touched to points such as *C* and *D* between which exists an open circuit there will be a sharp click as the phone connection is made and another click as the connection is broken. But while the connection of the phones is complete there is little or no sound.

Because the phones give no sound while they are completing a circuit around an open place they are not as satisfactory for testing as the voltmeter because the voltmeter gives a continuous reading or indication as long as it remains connected to the circuit.

In Fig. 2 is shown a filament circuit from A-battery to tube and back to battery. This circuit includes the battery, the filament switch, the filament rheostat, the tube itself and the wiring between these units.

One side of the voltmeter is connected to one side of the battery and allowed to remain there during the test. Starting from the battery the other side of the voltmeter is temporarily connected to each point in the circuit as shown by the broken lines.

TROUBLE, CIRCUIT, SHORT

As long as complete parts of the circuit are being thus bridged there will be no reading of the meter. But when the meter does show voltage it indicates that the open point is between the place then being touched and the last one touched at which there was no reading.

Thus, in Fig. 2, the meter might be connected to both sides of the switch, then to both sides of the rheostat; and with the connection made to the side of the rheostat farthest from the battery a voltage reading might be secured. This shows an open circuit between the point then being touched and the last one touched. These two points are the two terminals of the rheostat, consequently the rheostat is open circuited, possibly burned out.

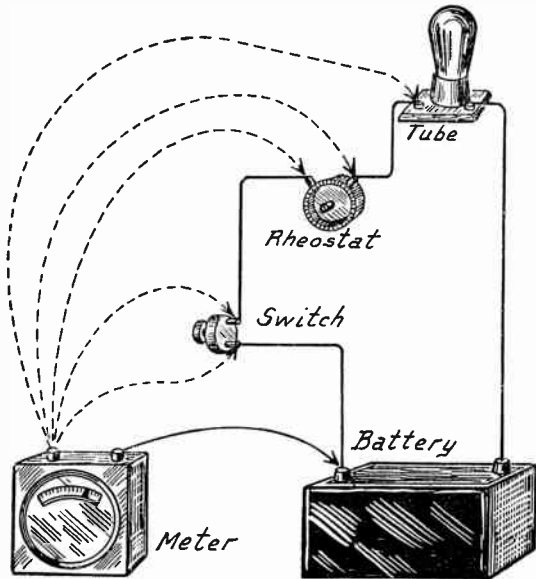

FIG. 2.—Testing Filament Circuit for Opens.

No voltage may be found at one end of a wire while at the other end of this wire the meter may give an indication, thus showing that the open circuit exists in the wire or its connections. The same principle may be applied to the location of open circuits in any part of the receiver.

TROUBLE, CIRCUIT, SHORT, LOCATION OF.—A short circuit is formed by a connection between two conductors carrying different voltages, this connection allowing current from a source, such as a battery, to pass back to the source without having gone through the parts which are to be operated by the current under normal conditions.

TROUBLE, CIRCUIT, SHORT

If the filament circuit of Fig. 1 has the two wires touching at *A*, this point forms a short circuit because battery current flows through this short and back to the battery rather than flowing through the tube's filament. A short circuit generally draws a current heavier than normal from the source although in the case of plate circuits and grid circuits this may not be the case.

The most certain way of locating a short circuit is by connecting the voltmeter in series with the battery at one of the battery ter-

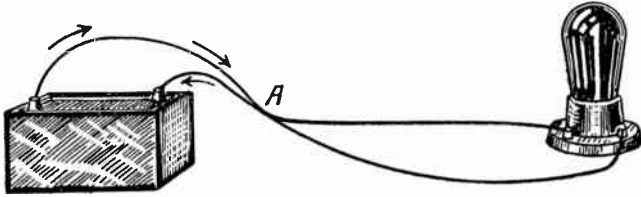

FIG. 1.—Short Circuit in Filament Lines.

minals as in Fig. 2 and then proceeding as follows: The short circuit will cause the meter to read full battery voltage while at the same time the damaging effects of the short are stopped by the meter's high resistance.

The circuit leading away from the meter is now to be opened, one point at a time, until the opening of some one point does not stop the indication of voltage on the meter. As an example, supposing the short to be at the point indicated in Fig. 2. Opening the circuit at the switch will cause the meter indication to drop to zero. The next point is the rheostat and opening

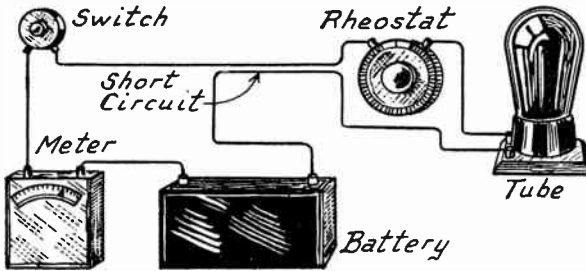

FIG. 2.—Testing for Short Circuit with Voltmeter.

the circuit at the rheostat will not cause the meter indication to drop to zero because the circuit is still complete through the short somewhere between the rheostat, now opened, and the battery.

Therefore, as each point is opened observe the meter. If it drops to zero, continue along the circuit, opening the various points. When opening some one point does not cause the meter to drop to zero it indicates that the short circuit lies between this point and the last one opened. Every portion of any circuit may thus be tested, even though it may sometimes be necessary to disconnect wire ends from their terminal connections. The same principle may be applied to the location of short circuits in any circuit of a receiver.

TROUBLE, RECEIVER

TROUBLE, RECEIVER AND POWER UNIT.—Receiver trouble may be located by noting the audible performance or lack of performance, this being the system first described in the following pages. A more exact method utilizes definite tests on circuits and tubes as described further along in this section. Systematic tests for power units and A. C. operated parts are also outlined. Audible symptoms are classified as follows:

1. *No signals or weak signals.*
2. *Rise and fall of volume, regular or irregular.*
3. *Lack of selectivity or broad tuning.*
4. *Poor reproduction of speech or music, distortion.*
5. *Unusual noises, not present with normal operation.*

When called upon to diagnose a case of receiver trouble it will be possible to place the symptoms in one or more of the foregoing classes. Having done this, each class of troubles may be further subdivided. With the trouble placed as causing some one of the five principal classes of symptoms, the following list of sub-divisions may be referred to, using only the list called for by the symptom first recognized.

1. *No signals or weak signals.*
 - a. No sound of any kind when switch is turned on.
 - b. Receiver sounds alive with switch on but no signals can be received.
 - c. Signals are weak with insufficient volume.
 - d. Signals from nearby stations weaker with radio frequency amplification in use than with radio frequency tubes turned out.
2. *Rise and fall of volume, regular or irregular.*
 - a. Irregular and intermittent fading of signals from distant stations.
 - b. Volume slowly rising and falling on all stations.
 - c. Volume changes only when dials or controls are touched.
3. *Lack of selectivity or broad tuning.*
 - a. Interference from unwanted broadcast signals.
 - b. Sounds from electrical interferences (see also Class 5).
4. *Poor reproduction of speech or music, distortion.*
 - a. High notes weak or low notes weak with others of normal volume.
 - b. High notes too loud.
 - c. Signals sound harsh.
 - d. Music and voice muffled, blurred, mushy or ragged.
5. *Unusual noises, not present with normal operation.*
 - a. Squealing and whistling, either steady or intermittent.
 - b. Loud and steady howling.
 - c. Rasping and scratching noises.
 - d. Static or atmospheric noises.

TROUBLE, RECEIVER

- e. Regular ticking or popping noises.
- f. Regular clicking, crackling, roaring or buzzing noise.
- g. Regular humming, vibrating, or whirring noise.
- h. Telegraphic dots and dashes.

Each of the foregoing sub-classifications may now be identified according to a number and letter. For example, a receiver in which signals are weak with insufficient volume will be classed as having symptom "1-c."

The probable cause for each of the foregoing twenty-one sub-classifications are considered in the following paragraphs which bear their corresponding numbers and letters.

1-a. No Sound of Any Kind When Switch Is Turned On.—Under this condition we mean that there is no sound from the speaker or phones to indicate that the receiver is alive in any way. When a switch of a receiver in normal operation is closed there is heard a soft rushing sound. When the switch is turned off there is a click that indicates the opening of the filament circuit by the switch. No click occurs when the switch is closed. If neither click nor rushing sound is heard, then the receiver is completely dead.

First look at the tubes to see whether they are lighted. If any tube is unlighted while others are lighted with normal brilliancy try another tube in this socket. If this testing tube does not light, trace the filament circuit from that socket according to instructions under *Trouble, Circuit, Open*. If the testing tube lights, the regular tube is burned out and must be replaced.

If no tubes are lighted or if all tubes burn very dimly, remove one terminal connection from the filament transformer or battery. A heavy flash at this terminal indicates a short circuit which should be located according to instructions under *Trouble, Circuit, Short*. If there is no flash or only a weak spark, test or replace the filament transformer or with a battery test it according to directions under *Trouble, Battery Weakness and Resistance*.

If all tube filaments are lighted with normal brilliancy and still there is no sound whatever in speaker or phones it indicates that the plate circuit of the last audio amplifier tube is open circuited or short circuited. It may be that the entire plate or B-battery circuit of the entire receiver is open, since this would include the circuit for the last tube. But even though all other tubes and stages are in perfect working order an open circuit or any cause of no plate voltage to the last tube will prevent any sound whatever from being heard. The B-battery should be tested for voltage or the power supply unit should be tested.

If the B-battery or power unit are found to give normal voltage, leave the receiver switch turned on and disconnect the lines attached to the B-battery terminals of the receiver one after the other. As each line is disconnected there should be a small, bright spark. If this spark occurs as each plate circuit or B-battery connection is broken, either at the receiver or at the battery or power unit, it indicates that the plate circuit of the last tube is short circuited. The presence of the spark indicates that the circuit is complete so that plate current may flow, but it may not be going through the proper paths. At this point a different speaker or phones should be tried since the regular ones may be defective.

If disconnecting any one line fails to cause a spark it indicates an open circuit in that line or the parts attached to it. If none of the connections give a spark when opened it indicates an open circuit between the B-battery or power unit and the main plate circuit leads in the receiver, possibly in the negative B-battery line.

TROUBLE, RECEIVER

If the foregoing spark tests indicate an open circuit, examine the lines and connections between the plate of the last tube and the speaker or phones. Look especially at the connections of any jacks or terminals. Following this examination make a regular test for open circuit as directed under *Trouble, Circuit, Open*.

If the spark tests indicate a short circuit, first test the jack and the plug used for the speaker if connection is made in this manner. Test any bypass condensers in the output circuit of the last tube. If an output choke and condenser are used, test the choke which may have low impedance due to a short. If an output transformer is used test the transformer windings for shorts between the two primary terminals, then between the two secondary terminals. Also test the cord between receiver and speaker or phones. Not having located the short it will be necessary to proceed according to instructions under *Trouble, Circuit, Short*.

When no sounds whatever are heard the attention should be directed to the A-battery or filament supply, to the B-battery or plate supply, to the last amplifying tube and to the plate circuit of this last tube which includes the speaker or phones.

1-b. Receiver Sounds Alive with Switch On But No Signals Are Received.—Under this condition there is heard the rushing sound that indicates a live receiver and when the switch is turned off there is a distinct click. Still, no signals are received even from nearby broadcasters.

The first things to be examined are the ground and the antenna with their associated connections and parts. The easiest way to test the ground is to run an additional wire from the ground terminal of the receiver to the nearest cold water pipe. This wire may be a piece of flexible lamp cord or anything else in the wire line. Make a good solid connection to a clean place on the water pipe. Should signals then be received it indicates that the regular ground wire and ground clamp should be repaired.

The easiest way to test for antenna troubles is to disconnect the regular antenna lead-in wire from the receiver and connect another wire to the antenna terminal of the receiver. This other wire should be about thirty or more feet long and may be laid along the floor of several rooms or thrown across pieces of furniture. Any way, just so that no bare spot of this substitute antenna comes in contact with metal objects. If there is a broadcaster operating within ten or twenty miles of the receiver, this temporary antenna will allow the reception of signals. Should signals be received it indicates open circuits, broken wires, poorly made joints or shorts in the regular antenna system. Shorts may be found where the antenna wire touches metal guy wires, gutter pipes or other metallic objects. Also examine the lightning arrester and test it for short circuits.

Many cases are found where either the antenna, the ground or both have simply become disconnected from their terminals at the receiver. Always look for the simple things first. If the simple tests show no trouble and a substitute ground or antenna allowed reception, it may finally be necessary to examine and test every part of the antenna and ground circuits for opens.

The click heard when the receiver switch is turned off and the rushing sound heard when this switch is on indicate that the plate circuit of the last tube is alive and functioning, also that the speaker and its connections are in working order. Having also examined antenna and ground, they may be eliminated from consideration. It remains to look between the antenna and the last tube for the trouble.

Starting with the output tube or last audio amplifying tube, each

TROUBLE, RECEIVER

tube should be removed from its socket and replaced; all of this with the receiver switch turned on.

Removing and replacing the last audio tube will cause a loud clicking or crashing noise in the speaker or phones. This indicates that this tube and its plate circuit are in operating condition.

Now remove and replace the tube preceding the last audio tube. If this gives a noise practically as loud as the removal of the last tube, this preceding audio tube and its plate circuit may be considered in operative condition. But if the click is very faint it indicates that the tube now removed is burned out, is otherwise defective or that this tube's plate circuit is defective.

Repeat the foregoing procedure with each audio amplifying tube should there be more than two of them. The same indications and conclusions apply.

Next remove and replace the detector. With the detector removed the receiver may set up a loud howl. This does not indicate trouble but rather indicates proper operation of some types of detector stages. If the removal of the detector tube causes a loud click or crashing sound it indicates that the detector tube and its plate circuit are in operative condition. A very faint click indicates trouble in this tube or its plate circuit.

Next remove and replace the last radio frequency amplifying tube, the one preceding the detector. If this is the only radio amplifying tube in the receiver or if it is one immediately preceding the detector when two or more radio stages are used, its removal and replacement will make a decided click, though not as loud as the audio amplifiers or the detector. This decided click indicates that the tube removed, also its plate circuit, are in operative condition. No click whatever or one that is barely perceptible indicates trouble in this tube or in its plate circuit.

In many receivers the radio frequency amplifying tube next to the antenna may be removed and replaced and hardly cause a sound in the speaker or phones, yet this tube may be in perfect condition. This first radio tube must be tested by replacing it with another tube known to be good.

Should any of these tests made by removing and replacing tubes indicate a faulty tube or a defective plate circuit, the suspected tube should be replaced with one known to be good. If normal operation results, the tube should be permanently replaced with a new one. If using a good tube does not improve matters the plate circuit of that tube should be checked over from the tube terminal to the B-battery or power unit, looking for open circuits or short circuits.

If all tubes and plate circuits appear to be in good condition from the preceding tests it will be necessary to test the grid circuits.

There is no simple and uniform test that may be applied externally to the grids of audio frequency, radio frequency and detector tubes to determine their condition because the indications depend to such a great extent on the peculiarities of different receivers.

Touching the grid terminal of the detector tube with a lead pencil held in the hand will cause a roaring or rushing or vibrating sound if the detector grid circuit is alive and working. Touching the finger tip to the grid terminal of amplifier tubes will cause a click in the speaker or phones when the grid circuit is working normally, but a click almost as loud will be heard even though the grid circuit is completely open. If no sound whatever can be produced by touching the grid terminal of any one tube it may be assumed that the tube is completely inoperative or that its grid circuit is completely short circuited.

TROUBLE, RECEIVER

Tests of the grid circuit should be started by placing a tube known to be good in each socket, one after another. Should this fail to show up one of the original tubes as defective it will be necessary to test the grid circuit, from tube socket grid terminal through the coupler, through the C-battery or other grid bias, and to the negative filament line of that tube. Tests for open circuits may be made as directed under *Trouble, Circuit, Open*, while tests for shorts may be made according to instructions under *Trouble, Circuit, Short*.

Grid circuits of audio amplifying tubes include the coupling transformer, impedance or resistance, also the C-battery or other biasing voltage and the connections between these parts and to the tube.

Grid circuits of radio frequency amplifying tubes include the antenna coil for the first tube and the secondary winding of a radio frequency transformer with following tubes. These circuits also include the tuning condenser.

The detector grid circuit includes the secondary of the preceding transformer or coupler, the tuning condenser, the grid condenser and the grid leak.

Any of the units of these grid circuits may be open circuited or short circuited or their connections may have opens or shorts.

1-c. Signals Are Weak with Insufficient Volume.—First test the condition of the A-battery or filament supply and of the B-battery or plate supply unit. See *Trouble, Battery Weakness and Resistance*.

With the receiver in operation, temporarily replace each tube with one known to be good and if volume is normal with any testing tube, use a new tube in that position. It is possible that several of the tubes or even all of them may have become very weak due to age or abuse such as abnormal filament voltages. They may be replaced with new ones or they may often be restored according to instructions under *Tube, Restoration of*.

See that the audio amplifier terminals on the receiver are connected to proper voltage taps on batteries or power supply units, also see that the detector plate is receiving proper voltage, usually about twenty to forty-five volts.

Check the A-battery or filament supply connections for polarity. Connecting the positive battery line to the negative terminal on the receiver and the negative battery line to the positive terminal puts a positive bias on all the grids and reduces volume almost to the vanishing point.

The ground lead should be examined for breakage or looseness at any joints and the ground clamp should be tightened if possible. The ground should be made to a cold water pipe or to a metal plate or pipe buried in the earth.

Examine the antenna and its joints for looseness and for the antenna wire touching some metal object. Antenna insulators may be broken. The antenna may be rubbing on the edge of a roof. A lightning arrester may be partially short circuited with dirt or moisture.

A low resistance grid leak will greatly reduce volume. A leak of about two megohms resistance is a good average value for all conditions.

See also *Sensitivity and Range, Receiver*.

1-d. Signals from Nearby Stations Weaker with Radio Frequency Amplification in Use Than with Radio Frequency Tubes Turned Out.—This trouble is usually caused by incorrect plate voltage or B-battery voltage on the radio frequency tubes. A very high plate voltage on the first radio frequency amplifying tube may almost overcome the effect of the extremely minute grid voltages from the antenna so that the plate current is practically steady. The plate voltage on the first tube may sometimes be reduced to as low as ten or twelve volts with advantage.

TROUBLE, RECEIVER

It may also be found that too little plate voltage is being used for radio frequency amplifying tubes following the first one, especially if more than two radio tubes are used. Signals weaker with the radio tubes in use than without them generally indicate trouble in the plate circuits of these radio tubes.

2-a. Irregular and Intermittent Fading of Signals from Distant Stations.—This is simply the fading to which every listener to distant stations becomes accustomed. See *Fading*.

2-b. Volume Slowly Rising and Falling on All Stations.—This indicates that the A-battery or the B-battery is nearly run down. It indicates that storage types of batteries are badly in need of recharging or that dry cell B-batteries have reached the end of their useful life. If power supply units are used this trouble indicates faults in the operation of these units.

2-c. Volume Changes Only When Dials or Controls Are Touched.—The volume may either rise or fall. The receiver may start to oscillate or may cease to oscillate. This is caused by the effect known as body capacity. See *Capacity, Body*.

3-a. Interference from Unwanted Broadcast Signals.—This indicates a lack of selectivity in the receiver. Remedies for this condition will be found under the heading of *Selectivity*.

3-b. Sounds from Electrical Interference.—These abnormal sounds include all those that may be picked up by the antenna, by the wiring for power supply units, by battery wiring and by the parts of the receiver. The causes for such sounds and the methods for their reduction or elimination are discussed under *Interference*. See also following paragraphs 5-a to 5-h.

4-a. High Notes Weak or Low Notes Weak with Others of Normal Volume.—This trouble may arise from faults in the transformers, chokes or resistances used for coupling between the detector and first audio frequency tube and between the following audio frequency tubes. It may also be caused by faults in the loud speaker.

With transformer coupling this trouble may be due to the transformers having small cores and small primary windings when small transformers of high turn ratio are used. It may also be caused by improper use of condensers and resistances connected across the terminals of the transformers or the tubes, especially when these things are connected across the transformer secondary.

With resistance coupling uneven amplification is usually due to improper selection of plate resistances or blocking condensers. With the choke coil coupling it is usually due to chokes that are too small, having small windings and small cores, or it may be due to improper blocking condensers.

See *Distortion; Speaker, Loud; and Amplifier, Audio Frequency*.

4-b. High Notes Too Loud.—This is another case of distortion. It is often found with high ratio audio transformers. It is caused by coupling condensers of too small capacity in choke coil coupled and in resistance coupled amplifiers. See *Distortion; also Amplifier, Audio Frequency*.

TROUBLE, RECEIVER

4-c. Signals Sound Harsh.—This fault may be due to weak B-batteries or to too low voltage from plate power supply units. It may also be due to excessively sharp tuning in radio frequency stages or to too much regeneration in the detector stage. A grid leak of too high resistance will cause harshness on local reception.

See *Distortion*.

4-d. Music and Voice Muffled, Blurred, Mushy or Ragged.—This trouble is often due to weak and run down plate batteries. It is more often due to wrong proportioning between plate voltage and grid biasing voltage. The plate voltage must be high enough to produce the desired volume without distortion and the biasing voltage or C-battery voltage must be sufficient to prevent the grid from becoming positive even with the strongest signal.

See *Bias, Grid*; also *Distortion*.

5-a. Squealing and Whistling, Either Steady or Intermittent.—If the whistling rises and falls when no change is being made in the receiver controls it is caused by nearby radiating receivers. See *Reradiation*. If the whistling changes only as the receiver controls are moved it is caused by oscillation within the receiver. See *Oscillation*. Too high resistance in the grid leak is often the cause of squealing. Various feedbacks of radio frequency and of audio frequency energy cause steady whistling sounds. See also *Noise*.

5-b. Loud and Steady Howling.—This is generally caused by a feedback between high voltage plate leads and grid leads or by microphonic feedback from loud speakers to detector tube or audio amplifier tubes.

The speaker should not be operated close to the antenna end of the receiver, nor should the leads from the last audio tube to the speaker run along the length of the receiver.

If the howling can be stopped by placing the tips of the fingers on the detector tube or on one of the amplifying tubes, the trouble comes from vibrations set up by the speaker shaking the internal parts of the affected tube so that its plate current is changed in tune with the vibrations. Mounting the offending tube on a cushion base or cushion socket will usually stop the howling. If this does not cure the trouble, the tube must be replaced with one that has its elements more rigidly built and better supported. See also *Noise*.

5-c. Rasping and Scratching Noises.—The causes and remedies for this condition are treated under the heading of *Noise* and of *Interference*, both of which should be referred to. If the rasping and scratching are accompanied by weakness of signal, lack of volume, it may indicate run down B-batteries or failure in the power supply unit. See *Trouble, Battery Weakness and Resistance*.

5-d. Static or Atmospheric Noises.—The causes of static disturbances and the available means for reducing their effect on reception are treated under the heading of *Static*.

TROUBLE, RECEIVER

5-e. Regular Ticking or Popping Noises.—This trouble is generally due to faults in the grid leak of any tube. With a leak of too high resistance the starting and stopping of oscillation causes the ticking noise. Too much regeneration in an effort to secure extreme sensitivity will also cause such noises. See also *Detector, with Grid Condenser and Leak*.

5-f. Regular Clicking, Crackling, Roaring or Buzzing Noises.—These noises are practically always caused by interference from nearby electrical devices and machines using electric motors in their operation. For the methods of reduction or elimination see *Interference*.

5-g. Regular Humming, Vibrating, or Whirring Noises.—These noises usually come from power lines running near the antenna or ground or from insufficient filtering in power supply units. See *Interference*.

5-h. Telegraphic Dots and Dashes.—The rapid dot and dash signals of the telegraphic code generally come through with a semi-musical note which will often rise and fall in pitch during the transmission. If the receiver is reasonably selective for broadcast reception there is nothing that can be done to get rid of this telegraphic interference except to wait for it to stop. Radio telegraphy is carried on under rather strict supervision from government authorities and should it cause interference it may be assumed that the message being transmitted is of greater importance than the slight interruption of a broadcast program.

Testing Operation of Each Stage.—All broadcast receivers include one or more stages of radio frequency amplification, a detector and one or more stages of audio frequency amplification. By simple tests it is possible to determine which of the stages contains a defect which makes the receiver inoperative or which makes its operation unsatisfactory.

The circuits of a typical stage of radio frequency amplification are shown in Fig. 1. If this is the first stage, the antenna and ground will be connected substantially as shown by the broken lines, otherwise the primary of the first transformer is connected in the plate circuit of the preceding tube just as the primary of the second transformer is connected in the diagram.

Now, if the first radio frequency amplifying tube be removed from its socket and the antenna connected to the plate terminal or the plate prong hole in this socket, the first stage will be effectively cut out and the second stage of the receiver will operate as an antenna stage. From the diagram it will be seen that an antenna connection made to the plate of the tube will cause the primary of the second transformer to become a part of the antenna circuit. The ground connection need not be changed since, from the *B* end of the primary winding there is always a connection through the plate power unit to the *B*-minus side of the circuit and from this point a connection is made to ground.

With this temporary antenna connection the receiver may be operated in the usual manner. Even with all parts following the temporary antenna connec-

TROUBLE, RECEIVER

tion in good working order, the signal volume will be somewhat less than normal because of using one less stage of amplification. However, satisfactory operation at the reduced volume indicates that all parts beyond this first stage are in working order and that the fault lies between the primary winding of the second radio frequency transformer and the antenna and ground connections marked *A* and *G*. The parts to be suspected include the primary and secondary windings of the first transformer, also their terminal connections;

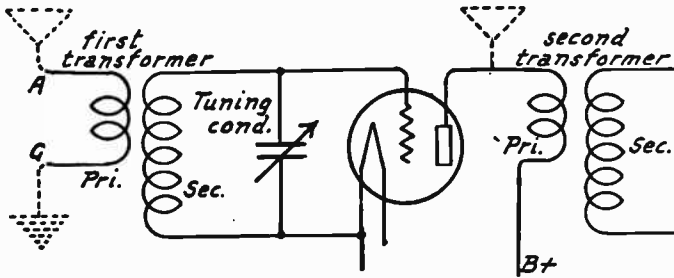

FIG. 1.—Antenna Connections for Testing Radio Stages.

the tuning condenser and its connections; the tube and its socket with their connections; also the primary of the second transformer only in its connection to the plate voltage supply.

In any of these tests, but one tube at a time should be removed from its socket. Tubes for the sockets of which the tests have been completed should be replaced before the following tube is removed so that there will not be an excessive filament voltage applied to the tubes remaining in place. Filament transformers and filament resistors handling more than one tube are designed to carry a certain current at their rated voltage and when the current is reduced by removal of tubes the voltage will rise.

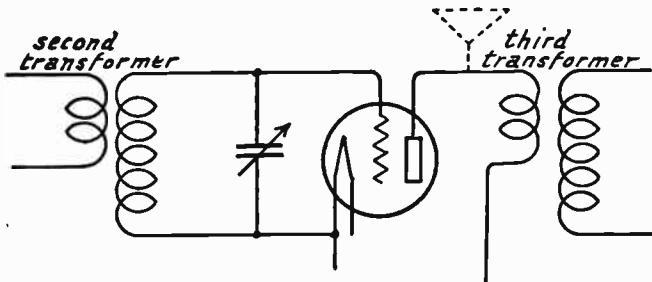

FIG. 2.—Testing the Second Stage.

If operation is still completely unsatisfactory the second radio frequency tube is removed. The temporary antenna connection is then made to the plate connection of the second tube as in Fig. 2. This will test the parts of the second stage, including everything from the second transformer, through the tuning condenser and tube to the primary of the third transformer. Should there be a third radio frequency tube a similar test may be made at its socket and so on for all the tubes up to, but not including, the detector.

TROUBLE, RECEIVER

Having tested all the radio frequency amplifying stages it is next in order to make tests on the audio frequency amplifying stages, working from the loud speaker connections back toward the detector tube. The first test is shown in Fig. 3. The two speaker leads are disconnected from the receiver or amplifier. One of the leads from a separate speaker of the high impedance type (not a dynamic) is touched to the plate connection of the power tube socket and the other is touched to the high voltage connection of the plate power supply unit as shown. Should the speaker then operate it indicates that the fault lies between the plate of the power tube and the speaker connections and that the power tube and all of the amplifier back of the tube are in good order. In this test the power tube is allowed to remain in its socket. Care must be exercised in making the temporary connections to the speaker since high voltages are present. It is best to make temporary connections with the amplifier turned off and to turn it on after the hands are removed. The

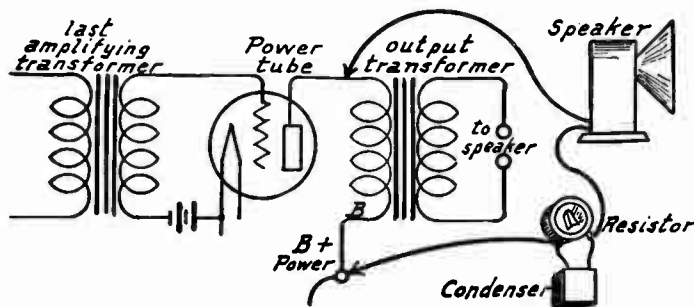

FIG. 3.—First Test on Audio Amplifier with Transformer Speaker Coupling.

moving coil of a dynamic speaker will not respond if connected directly to the plate of a tube, consequently it is necessary to test with a magnetic speaker or with a moving coil type fitted with a self-contained coupling transformer.

Examination of the diagram in Fig. 3 will show that the speaker is connected in parallel with the primary winding of an output transformer or speaker coupling transformer. This will reduce the volume from the speaker but will still allow its operation. Should the primary circuit of the output transformer be open, all of the plate current for the power tube would flow through the speaker windings and if this tube is one of the larger types the amount of current may easily cause damage. To prevent such danger it is advisable to place an adjustable high resistance and a bypass condenser in parallel with each other and in series between the speaker and the amplifier as shown in Fig. 3. The resistor should have a maximum resistance of 10,000 ohms and should be able to carry the full current of the power tube used. See *Resistor*. The condenser should have a capacity of one microfarad or more. In commencing the test, the full amount of resistance should be in circuit, and it may then be reduced until the speaker will make some sound as the tube plate connection is made and broken. If the speaker connection

TROUBLE, RECEIVER

is made through a choke and condenser as shown in Fig. 4, the test is made in essentially the same way.

Having tested the speaker coupling, the next step is to test the final audio frequency amplifying stage as indicated in Fig. 5. With all tubes in place and turned on, one of the speaker leads is touched to the plate connection of the audio amplifying tube which precedes the power tube and the other speaker lead is touched to the connection for the amplifier plate voltage supply.

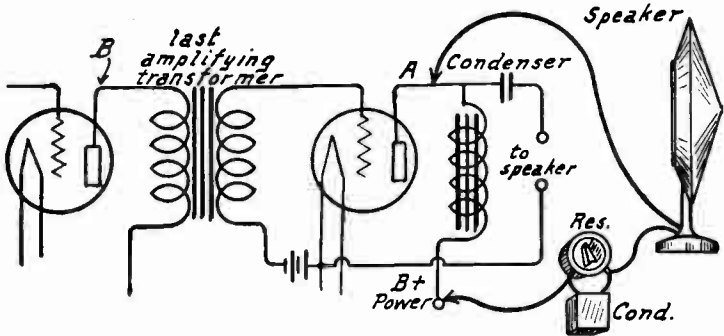

FIG. 4.—First Test of Audio Amplifier with Choke Speaker Coupling.

The speaker is then connected directly between the plate of this amplifying tube and the plate current supply with the primary winding of the last coupling transformer in parallel with the speaker. The speaker should operate provided the audio frequency tube and all parts preceding it are in working order. Operation of the speaker in this test indicates that the trouble lies between the audio amplifying tube and the speaker coupling devices, the parts including those shown between A and B in Fig. 4; the last coupling transformer, the power tube and their connections.

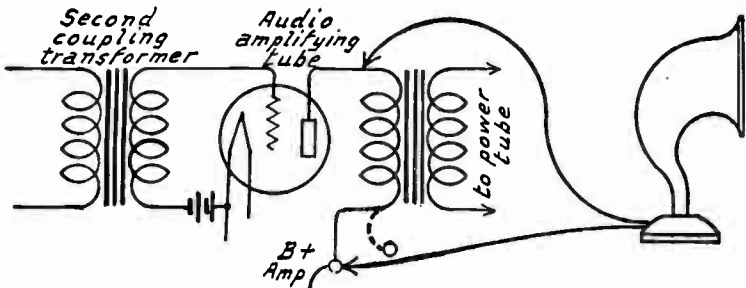

FIG. 5.—Second Test on Audio Amplifier.

In the test described, the primary winding of the last coupling transformer is in parallel with the speaker. A more satisfactory test may be made by removing this primary winding from the circuit so that only the speaker is in the tube's plate circuit. The removal is accomplished by first disconnecting from the power unit the wire running from it to the connection for the audio amplifier plate voltage. This connection is generally marked "B + Amp," "B + 90" or something similar. One line from the speaker is then touched to

TROUBLE, RECEIVER

the power supply terminal while the receiver connection is removed as indicated by the broken line in Fig. 5.

The next test is similar to that of Fig. 5, except that connection is made to the plate connection of the detector tube and to the plate voltage connection for the detector tube. The volume available in this test will be too small for operation of a loud speaker, therefore it will be necessary to make the connections from a pair of headphones. Satisfactory reproduction of sound from the headphones indicates that the detector tube and all parts between it and the antenna are working and that the trouble lies in the following coupling transformer, the following audio tube or their connections.

Testing Circuits While in Operation:—In most modern receivers it is quite difficult to reach directly the coupling transformers and wiring connections in order to make tests. In all receivers the easiest parts to reach are the tubes and fortunately almost all circuits come more or less directly to the tube socket connections which are easily reached for test work.

The general scheme of connections for any type of amplifying stage is shown between the broken lines in Fig. 6. The input is

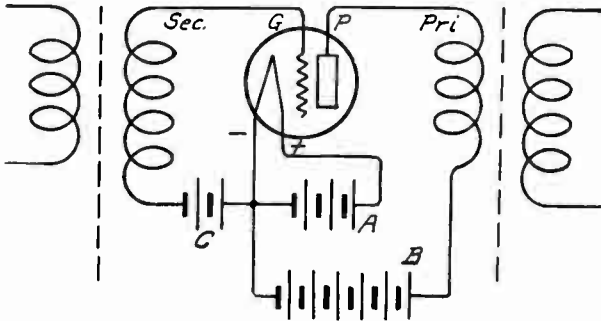

FIG. 6.—Circuits of Amplifying Stage.

from the secondary of a transformer and the output is to the primary of a transformer. The filament supply, either a transformer, a rectifying unit or a battery, is indicated at *A*. The plate supply, either a power unit or a battery, is indicated at *B*. The biasing voltage is indicated at *C*. The four terminals of an ordinary tube are indicated by *G* for the grid, by *P* for the plate and by *+* and *-* for the two filament connections. The tube fits into a socket having corresponding terminals.

Test connections are made as shown in Fig. 7, extra connections being brought out from the socket in the receiver to an extra socket in which is placed the tube found in the receiver socket. Connection to the receiver socket is made by means of the base taken from a broken or burned out tube. The base is prepared by first breaking away as much of the glass as possible, then immersing the base in boiling water to soften the cement so that, with remaining particles of glass, it may be scraped away by using a knife blade. Inside the base will be seen wire leads running down into the prongs. The prongs are hollow, the wires being soldered in place. To remove these wire leads, catch the base in a vise, pull with pliers on the wire and

TROUBLE, RECEIVER

while pulling touch the outer end of the corresponding prong with a hot soldering iron, whereupon the wire will come out. The iron should be very hot so that the work is completed before the entire prong becomes heated. Heating the whole prong will loosen it in the base which is made of phenol material. Should a prong become loosened it may be tightened by holding its exposed portion in a vise while spreading the inner end with a blunt punch tapped with a hammer.

New leads of stranded rubber covered wire are now to be inserted. The opening through a prong is large enough to take only five or six strands of the new wire, so the remainder should be trimmed away and the strands to be used twisted together. With the base held in a vise the bared end of the new lead is started into the prong from inside the base. The hot soldering iron is then touched to the end of the prong to soften the remaining solder while the new lead is pushed through. The extra length of wire now exposed outside the prong's tip is clipped off and a drop of solder applied. The job is finished by dressing off any excess solder with a fine file. In this manner a new wire is soldered into each prong, being left long enough to reach the

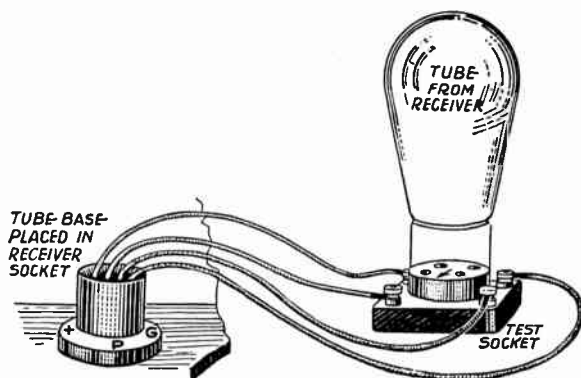

FIG. 7.—Tester Connection To Receiver.

test socket placed two feet or more away. The interior of the base is filled with sealing wax to support the wires and give a finished appearance.

Testers of varying degrees of completeness may be constructed around the test socket. If the available outlay allows, it is convenient to permanently attach meters suitable for testing plate current, plate voltage, filament current, filament voltage and grid bias. If meters cannot be spared for this work alone it is satisfactory to provide the necessary terminals to which meters may be attached when the tester is to be used. Suitable connections for the former plan are shown in Fig 8, all the meters being permanently connected with the test socket.

To operate the tester, a tube is removed from the receiver and the base with its attached wires is inserted in the socket left vacant. The tube is then put into the test socket and the receiver placed in operation as usual. The filament ammeter will show the amount of current flowing to the filament, the filament voltmeter will show the voltage across the filament and the plate milliammeter will show the number of milliamperes in the plate circuit.

TROUBLE, RECEIVER

Closing the plate switch will show on the plate voltmeter the voltage actually applied between the plate and the B-minus line. Closing the grid switch will show on the grid voltmeter the negative biasing voltage acting on the grid. Closing either of these switches will prevent the amplification of signals, this being the reason for providing disconnecting switches for the two meters.

The filament meters will be of D.C. types if a direct current filament tube is to be tested and will be of A.C. types if the filament or heater supply is alternating current. The filament ammeter for D.C. tubes must measure from one-eighth ampere to one and one-quarter amperes; for A.C. tubes it must measure from one-third ampere to two and one-half amperes. The filament voltmeter for D.C. tubes must measure up to six volts and for A.C. tubes should measure up to fifteen volts. The plate milliammeter is always of the D.C. type and should measure up to 100 milliamperes. The plate voltmeter is required to measure all voltages from the twenty or more applied to detector

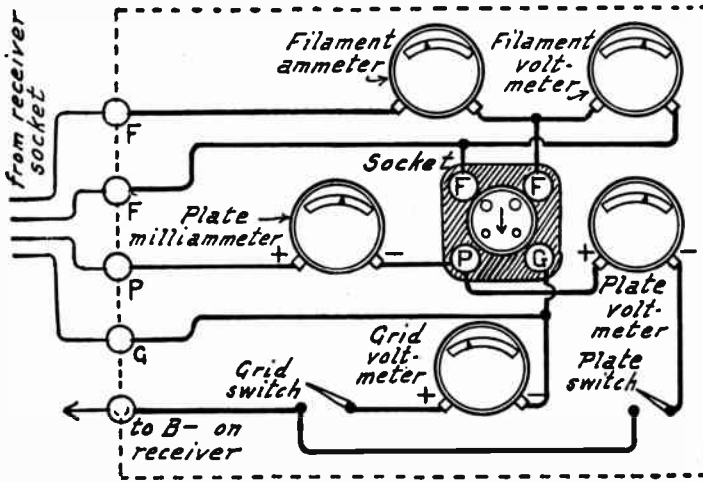

FIG. 8.—Receiver Tester with Attached Meters.

tubes up to more than four hundred volts applied to large power tubes. A double range meter, something like 0-100 volts and 0-500 volts is most satisfactory. The plate voltmeter must be of the high resistance type, 800 to 1000 ohms resistance per volt. The grid voltmeter, also of the high resistance type, will be required to measure biasing voltages as high as eighty to ninety when handling large power tubes, yet must accurately measure biases as low as one or two volts. This makes it advisable to use a double range meter in this position, something with ranges of 0.10 and 0.100 being satisfactory.

The connections of test sockets for use with separate meters are shown in Fig. 9. Both a four-prong A.C. or D.C. filament socket and a five-prong A.C. heater type socket are shown since either or both types may be required in testing a single receiver. The five meters are connected as required between the terminals indicated with due regard to correct polarities, positive and negative. The meters should be of the same types specified for the tester of Fig. 8. If a filament ammeter is not used, the terminals to which it would be attached are connected together, otherwise the tube would not light. The plate milliammeter terminals must be connected together when this meter is not used or there will be no plate supply for the tube. The voltmeters may or may not be used, their use or omission having no effect on the operation of the tube except that

TROUBLE, RECEIVER

signals will not be amplified while the plate voltmeter or the grid voltmeter are connected to the sockets.

A tester which will locate most troubles may be made without all of the meters shown. The plate milliammeter and plate voltmeter are most necessary, the filament voltmeter comes next, then the grid voltmeter and finally the filament ammeter in the order of their usefulness.

The type of tester here described allows all important voltages and current to be measured while the receiver is operating under normal conditions. From the tables given under *Tube, Characteristics of* may be learned the correct combinations of filament voltage, filament current, grid bias, plate voltage and plate current for any generally used tube. A radical departure from any of the values in a given combination indicates trouble, the value actually found giving a direct check on the troubles which are probably present.

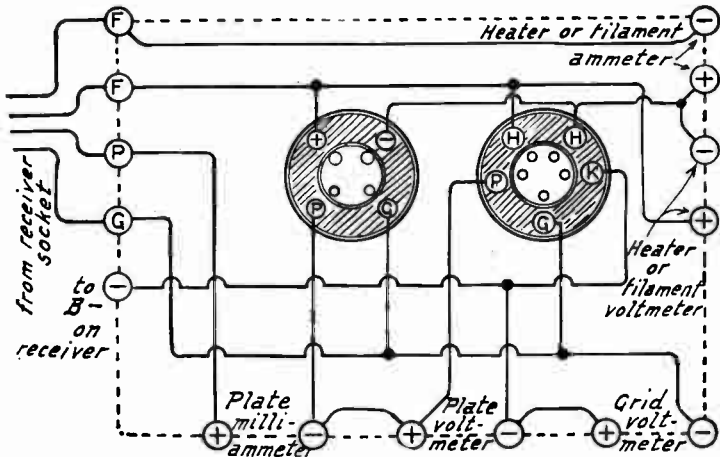

FIG. 9.—Test Board with Sockets.

In the following table are listed most of the probable causes of various incorrect meter readings:

Plate Voltage and Plate Current Both Too Low or Zero:

- Open circuit, ground or short circuit in plate wiring of receiver.
- Poor connections or loose joints in plate wiring of receiver.
- Poor contact on plate prong in socket.
- Short across bypass condenser between end of plate winding and B-minus line.
- When testing detector tube, shorted plate bypass condenser.
- Short circuit between coil in plate circuit and coil in following grid circuit or between windings of transformer in plate circuit.
- With resistance coupling, plate resistor burned out, disconnected or of too high value.
- With resistance or impedance coupling, plate circuit coupling condenser short circuited.
- Old and worn out B-battery.
- Shorts or grounds in high voltage lines of power unit.

TROUBLE, RECEIVER

Open circuit in power unit wiring.
Incorrect connections to power unit terminals.
Wrong adjustment of power unit voltage divider resistors.
Open circuited resistor in power unit voltage divider.
Shorted bypass condenser on power unit voltage divider.
Short circuited voltage regulator tube in power unit.
A.C. supply line voltage too low.
Short circuited or leaky condenser in power unit filter or voltage divider.
Disconnected or open circuited first filter condenser in power unit.
Open circuited filter choke in power unit.
Defective rectifier in power unit.
Burned out or disconnected transformer in power unit.

Plate Voltage and Plate Current Both Too High:

Wrong connections to power unit.
A.C. supply line voltage too high.
Open circuited or short circuited resistor in power unit voltage divider.
Short circuited filter choke in power unit.
Defective voltage regulator tube in power unit.
With resistance coupling, short circuited plate resistor.

Plate Voltage Too Low and Plate Current Too High:

Tube oscillating.
With resistance or impedance coupling or when testing detector with grid leak, disconnected or open circuited grid leak.

Plate Voltage Too Low and Grid Bias Polarity Reversed:

Windings of preceding transformer short circuited on each other.
Grid and plate short circuited in tube.

Plate Voltage Too Low and Filament Voltage High:

Plate and filament short circuited in tube.

Plate Voltage Fluctuates:

Loose connections in plate circuit wiring of receiver.
Defective volume control resistor or condenser.
Defective resistor in power unit voltage divider.
Defective rectifier in power unit.

Plate Current Too High:

Open circuit in grid wiring of receiver.
Grid bias voltage too little.
Poor contact on grid prong in tube socket.
Reversed connections to A-power unit or A-battery.
Reversed connections to biasing resistor or to C-battery.
Bypass condenser for biasing resistor or C-battery short circuited.
With resistance or impedance coupling, grid circuit coupling condenser short circuited.

Plate Current Too Low:

Grid bias voltage too great.
Tube old or damaged by abuse.

Grid Bias Voltage Too Little or Zero:

Poor connection, open circuit or ground in grid circuit wiring of receiver.
Voltage of C-battery or biasing resistor value too low.
Short circuited bypass condenser across biasing resistor or C-battery.
Poor contact on grid prong in tube socket.
Grid in tube short circuited on filament or cathode.
If test is on detector or radio frequency amplifying tube, low bias may not indicate trouble.

TROUBLE, RECEIVER

Grid Bias Voltage Too Great:

Resistance of biasing resistor too high or C-battery voltage too high.

Grid Bias Reversed in Polarity:

Connections reversed to biasing resistor or to C-battery.

Windings of transformer in grid circuit short circuited on each other.

Grid and plate in tube shorted together.

With resistance or impedance coupling, shorted coupling condenser in grid circuit.

Filament Voltage and Filament Current Both Too Low or Zero:

Short circuit, open circuit or poor connection in filament or heater wiring.

Poor socket connection for filament or heater prongs.

A-battery discharged, defective or has corroded terminals.

Defective operation of A-power supply unit.

Broken or dirty filament or heater circuit switch.

Broken or burned out filament rheostat or resistor.

A.C. supply line voltage too low.

Wiring for filaments or heaters too small or laid out so one tube is farther from transformer than others.

Filament Voltage and Filament Current Both Too High:

A.C. supply line voltage too high.

Burned out or disconnected tube in socket other than one on test.

A-battery used too soon after being on charge with trickle charger.

Filament Voltage Too High and Filament Current Zero:

Filament or heater burned out or broken in tube or poor connections in wiring or at socket prongs.

Filament Voltage Reversed in Polarity:

Reversed connections to A-power unit or to A-battery.

Filament Voltage Fluctuates:

Defective A-power unit or discharged A-battery.

Loose connections in filament or heater wiring circuit.

Reference to Fig. 6 will show that tests may be made with this outfit on the filament, plate and grid circuits of the tube being checked. In Fig. 10 is illustrated a test for the grid circuit. The circuit tester consists here of a voltmeter and 22 1/2 volt B-battery in series. With the test points touched to the ends of a complete circuit the dry cell is connected to the voltmeter and the meter indicates voltage. If the circuit is open, no voltage is indicated. If the circuit is of high resistance the meter will indicate less than the full battery voltage.

For a receiver with power unit plate supply the plate circuit is tested with the receiver and plate supply turned off and with the tester points connected between the plate terminal *P* and the negative terminal or B-minus terminal. In this test the meter will show less than full battery voltage because of the voltage divider resistors in the power unit. If B-battery plate supply is used the plate circuit is tested by connecting between the plate terminal *P* and the minus terminal a voltmeter capable of measuring the full voltage of the B-battery. No testing battery such as that in Fig. 10 is used for this test. With the receiver turned on an unbroken circuit will allow the voltmeter to show full or partial battery voltage depending on the resistance of the coupling devices. An open circuit shows no voltage.

TROUBLE, RECEIVER

The filament circuit is tested by connecting between the two filament terminals a voltmeter capable of measuring the full normal filament voltage and turning on the filament supply, either power unit or A-battery. A complete circuit will allow the test meter to show something more than normal filament voltage while an open circuit will allow no voltage to be shown.

Hum In A. C. Operated Parts.—The most generally experienced trouble in receivers and power units operated with alternating current is the hum present in greater or less degree. With the tuning controls of a receiver placed at a point midway between two stations, so that no outside signal is received, there is always an audible hum from the loud speaker. With such a normal hum it will not be noticeable when either music or speech is being received. Should the hum be sufficient to make it noticeable when signals are being received with any volume, measures should be taken to reduce the effect.

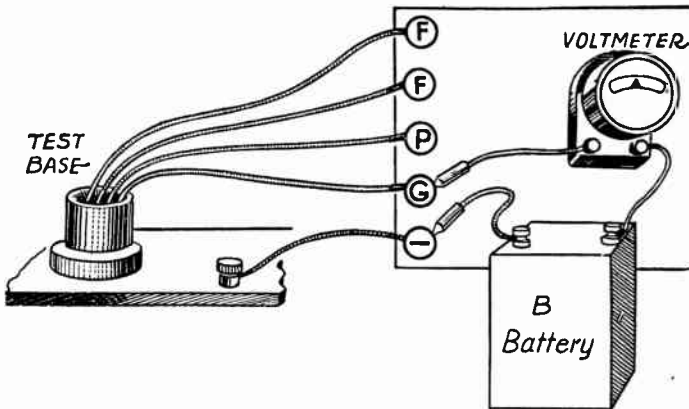

FIG. 10.—Circuit Tests on Receiver.

Hum from the radio frequency stages and the detector is due to incorrectly placed wiring with A.C. and D.C. lines too close together or else to operation of the amplifying tubes in an oscillating condition.

In combined power units and amplifiers the location of the parts with reference to each other is important. Audio frequency transformers or coupling chokes should be kept as far as possible from all power transformers, filament transformers and rectifier tubes. Filter chokes should be kept well separated from power transformers. When such a power amplifier is being constructed, it is advisable to alter the positions of coupling transformers and chokes with reference to each other and to the power transformers until the positions for least inductive coupling are found. Considering any two transformers or chokes the position of least coupling is that in which the center lines or axes of the two windings are at right angles to each other. The position of the first audio frequency coupling transformer or choke is the most critical and that of the last transformer is generally least critical. To still further reduce the effect of inductive coupling between units, the cases of all transformers, all chokes and all condensers should be connected to the B-minus line and to ground.

TROUBLE, RECEIVER

Maintenance of correct filament voltages, plate voltages and grid biasing voltages is important in the reduction of hum. Grid bias voltages which are much greater or less than normal for the applied plate voltage will cause hum. Bypass condensers of one microfarad capacity should be connected across each grid biasing resistor. In case of any doubt, all grid bias voltages should be measured and the bypass condensers should be tested, usually by the substitution of another one or by trying a condenser of greater capacity. It is important that the filament voltage on the detector tube be that which is normal for the tube in use. The plate voltage applied to the detector tube should be high enough to cause a plate current of at least one milliampere through this tube. Increasing the detector plate voltage may reduce the amount of hum.

Hum often is reduced by installing bypass condensers of one microfarad or greater capacity in the plate circuits as shown under the heading, *Condenser, Bypass*.

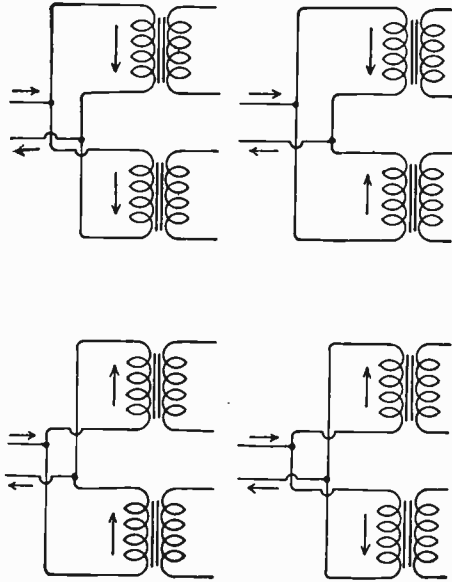

FIG. 11.—Connections of Transformers to Supply Line.

In all parts of the power unit and the amplifier the two wires carrying alternating current for any circuit should be twisted together. All these A.C. lines should be kept well separated from wires carrying plate circuits and grid circuits.

If two or more separate transformers are used for plate power supply and for filament supply a considerable reduction in hum often may be made by trying different connections of the primary sides of these transformers to the supply line. With two primaries to be connected to a single power line there are four possible connections as shown in Fig. 11. For a given alternation in the supply line it will be seen from the arrows that four relationships are secured between current direction through the two primaries.

In severe cases of hum the trouble may be reduced in some cases by bridging the supply line with two one microfarad 500-volt condensers in series

TROUBLE, RECEIVER

and connecting the B-minus or ground line of the amplifier and power unit between these condensers as in Fig. 12.

Filter condensers which are open circuited, have high resistance leaks or which are too small in capacity will cause hum. They may be checked by disconnecting them, one at a time, and noting the increase of hum as each is disconnected. If any one condenser allows little or no increase when taken out of the filter circuit it may be tested for the troubles mentioned.

The center taps of filament supply transformers are not always electrically centered and this defect may result in considerable hum when such transformers are used with A. C. filament type tubes. The correctness of centering may be tested by disconnecting the wire from the tap terminal and connecting it to the slider of a potentiometer connected across the outer terminals of the winding as in Fig. 13. The potentiometer may have from thirty to fifty ohms resistance and must be capable of carrying a number of amperes equal to the voltage across the outside terminals divided by the resistance in ohms. The slider of the potentiometer is then moved to the position of least hum. The center tap wire may now be changed back and forth between the potentiometer and the transformer terminal and if there is a considerable improvement with the potentiometer it may be permanently connected.

With incorrectly designed filter systems or with power units which are overloaded the filter chokes may be carrying so much direct current that their

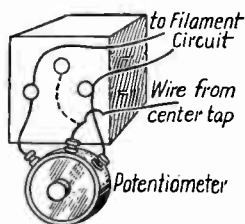
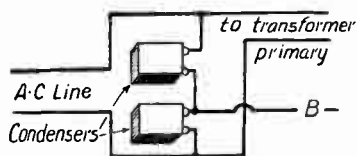

FIG. 12.—Filtering the Supply Line. FIG. 13.—Checking Center Tap.

inductance is materially lowered. This reduces the choking effect and allows hum to develop. If the direct current in milliamperes can be measured and compared with a rating for the choke a check may be made upon conditions of operation. It is possible that a filter choke may be short circuited. A rough test may be made by temporarily connecting the two terminals of the choke to a 500-ohm resistance whereupon there should be a decided increase of hum if the choke is in good condition. Little or no change in amount of hum may indicate a damaged choke.

Old rectifier tubes or tubes which have been badly overloaded at times are likely to cause hum. The most satisfactory test is to substitute a new or good tube and note any improvement in operation.

Tests on Power Unit Transformers and Chokes.—Power transformer and choke windings may be open circuited, shorted on each other, shorted across their own ends or grounded to the transformer case. Loose laminations or cores completely loose within the case will also cause trouble.

Transformer or choke coil windings are tested as shown in Fig. 14, using a dry cell and voltmeter or any other convenient form of circuit tester. The tester is first checked by touching the two points together whereupon the meter will read full battery voltage. The points are then touched to the two terminals of the winding to be tested and the meter reading noted. Zero

TROUBLE, RECEIVER

reading indicates an open circuited or burned out winding. The normal reading for filament transformers in good order will be practically full battery voltage because of the low resistance of such windings. If there is a center tap, the test should also be made between this tap and each of the outside terminals. The normal reading for filter chokes in good order will be much below full battery voltage; using a single dry cell the reading is usually in the neighborhood of one volt instead of one and one-half volts. If the reading on a choke is zero an open circuit is indicated while if the reading is full battery voltage the choke is short circuited.

The test for short circuit of a filament transformer winding is made as in Fig. 15. One wire from a single dry cell is connected to one terminal of the winding to be tested. The second lead is lightly brushed across the terminal to which the first one is attached and a rather faint spark will be observed. This second lead should then be brushed quickly across the other terminal of the winding and if this winding is not shorted and is in good working order there will be a much heavier spark due to the inductive action of the winding.

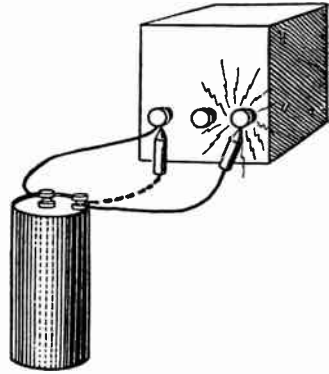
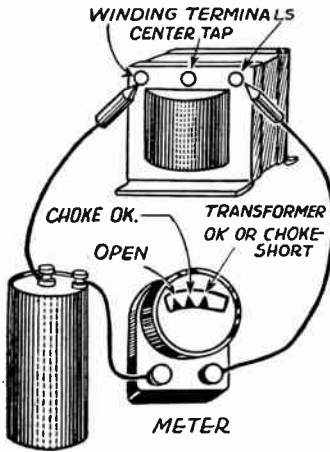

FIG. 14.—Test for Open Circuit or Short in Transformer or Choke.

FIG. 15.—Test for Short Circuited Transformer Winding.

If the spark is no larger than when the two battery leads were touched it indicates a short circuited winding.

A transformer is tested for short circuit between primary and secondary windings by touching one point of a circuit tester to a terminal of the primary winding and the other test point to a terminal of the secondary winding. There should be no indication of a connection, no voltage on a meter, unless the unit is an auto-transformer. An auto-transformer is seldom if ever used for this work.

Transformers and chokes are tested for grounds of the windings on their cases by touching one test point of a circuit tester to the case or housing and the other test point to a terminal of each winding. There should be no indication of connection because any connection would be a ground. In some types of filament transformers the center tap is grounded intentionally.

Condenser Tests.—Filter or bypass condensers are tested as shown in Fig. 16. A B-battery or power unit of the highest available voltage up to 180 volts is used for charging the condenser on

TROUBLE, RECEIVER

test. One battery or power unit terminal is connected to the common terminal of the condenser block being checked or to either of the terminals of a single condenser. The line from the remaining condenser terminal is first touched to the other terminal of the battery or power unit, is then removed and touched to the common terminal of the condenser as shown by the broken line in the illustration. If the condenser takes and holds a charge there will be a small bright spark just as this second contact is made. If the condenser is short circuited or open circuited there will be no spark. The size of the spark depends on the condenser capacity and the voltage applied, twenty-two and one-half volts being about the smallest pressure which will give a satisfactory check.

A condenser is tested for grounds to its case by touching one point of a circuit tester to one terminal of the condenser and touching the other test point to the case as in Fig. 17. Any voltage reading indicates a ground, zero reading indicating proper insulation. The test for shorts between condenser

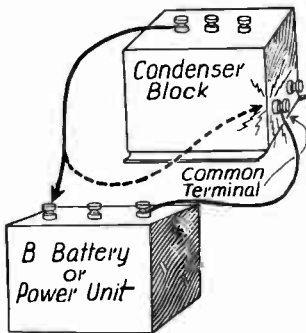

Fig. 16.—Test for Capacity, Short or Open Circuit on Condenser.

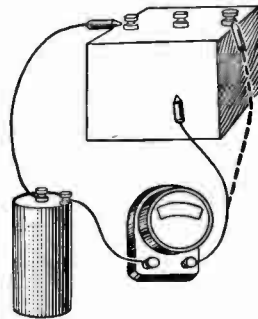

Fig. 17.—Test for Ground and Short Between Condenser Sections.

sections is made with one circuit tester point on the terminal of one condenser section while the second test point is touched to one of the terminals of other sections as shown in Fig. 17 by the broken line. There should be no circuit.

Resistor Tests.—The resistance in ohms of a voltage divider resistor may be measured approximately as shown in Fig. 18. The instruments required include a B-battery, a voltmeter having a maximum scale reading at least equal to the battery's voltage and a milliammeter reading up to ten mils or more. The voltmeter need not be of the high resistance type, a B-battery testing meter being satisfactory.

The battery, the voltmeter, the ammeter and the resistor are connected as shown. Connection *A* is left off the resistor to start with and a note is made of the current shown by the milliammeter. This is the current required to operate the voltmeter. The connection is then made to the resistor at *B* and readings noted on both the milliammeter and the voltmeter. The re-

TROUBLE, RECEIVER

sistance is calculated by multiplying the number of volts by 1000, then dividing this result by the difference between the second and first milliamperere readings. For example, suppose with the *B* connection in place that the voltmeter read 15, that the milliammeter read 10 mils without the resistor and 13 mils with the resistor connected. Multiplying 15 (volts) by 1000 gives 15000. Subtracting 10 mils from 13 mils gives 3 and dividing 15000 by 3 gives 5000 ohms as the value of the resistor. Many voltmeters require so much current to operate them that the correction is necessary if any accuracy in results is to be obtained. Expressed as a formula the calculation is:

$$\text{Resistance in Ohms} = \frac{\text{Volts} \times 1000}{\text{mils with resistor} - \text{mils without resistor}}$$

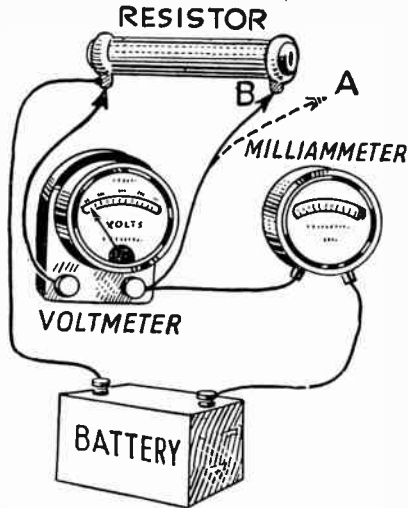

FIG. 18.—Measuring the Resistance of a Resistor.

A resistor that shows only a fraction of its rated value is partially short circuited or is not correctly rated. If the milliammeter reading is exactly the same whether the resistor is disconnected as at *A* or connected as at *B*, the resistor is open circuited.

An old and worn out rectifier tube will result in low voltage. The most practical check is substitution of a rectifier known to be good. Rectifier tubes will burn out when old and are often burned out before that time by accidental shorts and grounds in filter chokes, condensers or voltage dividers which impose an excessive load. An overloaded rectifier tube indicates the fact by a blue haze within the tube or by the plate becoming red hot. Before condemning the rectifier tube the socket contacts on its prongs should be cleaned and all wiring leading to this socket should be checked carefully.

T. U.

Subjects which relate directly to the work of trouble location and remedy are treated under the following headings:

Distortion

Fading

Interference

Level, Static

Motorboating

Noise

Oscillation

Range, Receiver

Re-radiation

Selectivity

Sensitivity

Static

Tube, Restoration of

Tube, Testing of

The following subjects deal with equipment used in trouble location and remedy:

Bridge, Measurements by

Meters, Frequency

Meters, Vacuum Tube

Oscillator, Audio Frequency

Oscillator, Radio Frequency

T. U.—An abbreviation for transmission unit. See *Unit, Transmission*.

TUBE, ACTION OF.—Without the vacuum tube, broadcast reception of today would be impossible. Until the advent of tubes as parts of radio receivers distance range was limited to about twenty-five miles and loud speakers were unknown, all speech and music being heard with headphones.

The style of tube most generally used is shown in Fig. 1. Looking from the outside the tube appears as a glass bulb, usually with a mirror-like silvery coating on the inside of the glass. The bulb is supported on a base made of moulded insulating material in all of the newer tubes. Bases for old tubes were sometimes made from a metal shell around the outside of insulating material. From underneath the base protrude four prongs through which connection is made to the internal parts of the tube.

Were the glass bulb to be removed, the parts remaining would appear as at the center of Fig. 1. The most noticeable part is a smooth shining piece of metal which encloses a collection of wires. Were one side of this metal to be removed the tube would appear as at the right in Fig. 1.

The metal shell, of which one half has been removed, is called the plate. Just inside of the plate is a flat spiral of very fine wire. This is called the grid. Inside of the grid is a V-shaped wire supported from its point at the top and at its two ends at the bottom.

TUBE, ACTION OF

This is the filament. These parts are shown separately in Fig. 2.

In Fig. 2 are shown the connections made from filament, the grid, and plate to the prongs on the tube base as they appear when

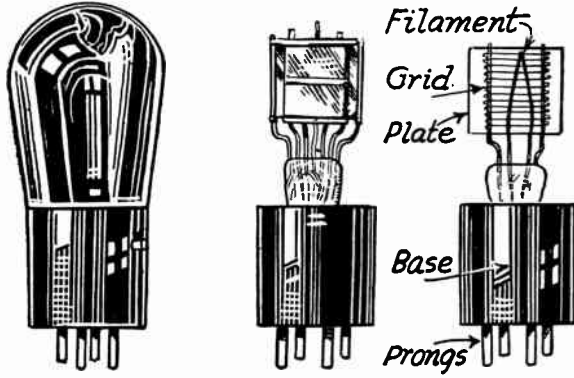

FIG. 1.—A Vacuum Tube and Its Principal Parts.

looking at the bottom. On one side of the base of some tubes is a small pin which acts as a guide when inserting the tube in a socket. This pin is indicated in Fig. 2.

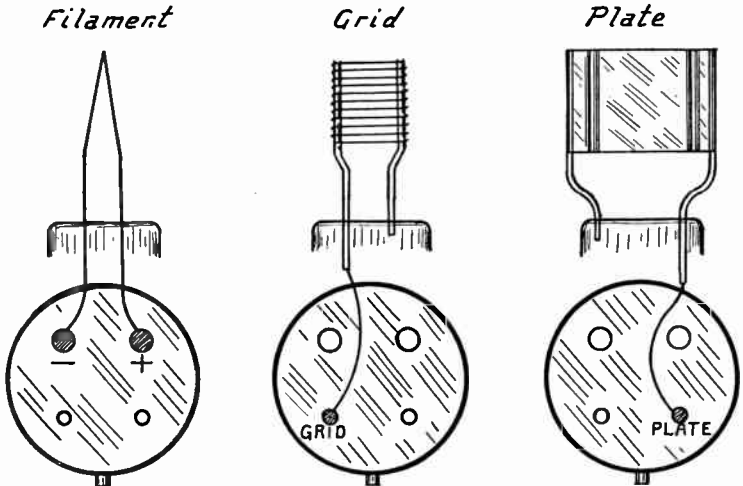

FIG. 2.—Connections Between Tube Elements and Base Prongs Looking at Bottom of Tube.

The two ends of the filament connect to two of the four prongs on the base. In the newer tubes which have two of the prongs larger than the other two, the two larger prongs are those connect-

TUBE, ACTION OF

ing with the filament. As shown at the center of Fig. 2 one of the grid supports connects to one of the prongs. The other grid support serves no other purpose except to carry one side of the grid. As shown at the right hand side of Fig. 2 one of the plate supports is connected to the remaining prong on the base. All of these wires and supports are carried in a piece of glass which is pressed tightly around them.

Were the tube to be cut through on a horizontal plane the section would appear as in Fig. 3. Here it is plainly seen that the filament is surrounded by the grid and that the grid is surrounded by the plate. With these parts assembled inside of the glass bulb almost all of the air is exhausted from the bulb and it is then sealed to form what is usually called a vacuum tube.

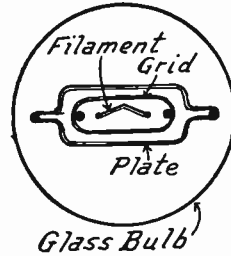

The tube shown in Figs. 1, 2 and 3 is of a type whose filament is operated with current drawn from a storage battery or power supply unit. Some tubes are designed to operate with dry cells as a source of filament current. The construction of the most generally used type of dry cell tube is shown in Fig. 4. In this dry cell tube the filament is a straight piece of wire supported top and bottom. The grid is a cylindrical spiral of fine wire surrounding the filament. The plate is in the form of a metallic cylinder surrounding the grid. The outside appearance of this tube is shown at the right in Fig. 4.

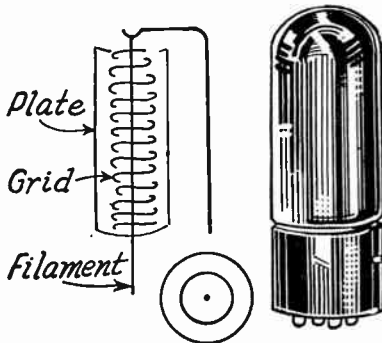

FIG. 4.—Construction of Dry Cell Tube.

In making radio diagrams it is not only inconvenient to draw the tube as shown in Figs. 1 and 4 but it would also fail to fully indicate the electrical action of the tube. Therefore, the symbol shown at the left in Fig. 5 is generally used to indicate a tube containing filament, grid and plate. It will be noticed that the symbol of Fig. 5

TUBE, ACTION OF

places the grid between the filament and the plate just as it is actually placed in the tube itself.

At the right hand side of Fig. 5 is shown the arrangement of terminals on a socket for such tubes as shown in Figs. 1, 2 and 3. By comparing the socket at the right hand side with the symbol at the left hand side of Fig. 5, it will be seen that the positions of the terminals around the socket are exactly the same as the positions of the terminals around the symbol.

Uses of Tubes.—Tubes are used in four distinctly different ways in radio work. The tube may be used as an amplifier. When used in this way it allows a small voltage to control a comparatively strong flow of current from a battery or a power supply unit. The tube is said to amplify because it uses a very small or weak signal to produce a large and powerful signal so that the signal effect is multiplied or amplified. See *Radio, Principles of*.

The tube may also be used as a detector. The purpose of a detector is to take the radio impulses in the form in which they come from the antenna and change them into a form which may be

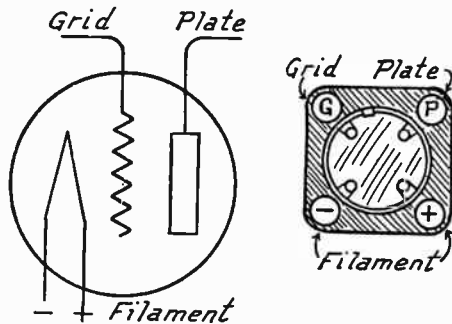

FIG. 5.—Symbol for Tube and Terminals on Socket.

used to produce audible sounds in headphones or a loud speaker. See also *Detector, with Grid Condenser and Leak* and *Detector, with Grid Bias*.

The same type of tube which may be used as an amplifier or as a detector may also be used as a modulator. A modulating tube is used in transmitting stations or broadcasting stations. It does the exact opposite of the detector. It takes voltages which represent the sounds of speech or music and combines them with other voltages so that the combination may be sent out from the transmitting aerial.

Finally this very useful form of tube may be used as an oscillator. A tube used as an oscillator when combined with other necessary parts will produce and maintain indefinitely alternating voltages and currents of almost any desired frequency.

Action of Filament and Plate.—A tube might be constructed with only a filament and a plate in a vacuum as indicated at the left in Fig. 6. A battery is shown connected to the filament so that

TUBE, ACTION OF

closing of the switch will allow battery current to flow through the filament and heat it. Were the plate connected to the battery and filament as shown a very remarkable action would commence as soon as the filament became red hot. There would be a flow of current through the circuit formed by the battery, the filament and the switch. But there would also be another current flow from the plate right through the vacuum to the filament. This flow of plate current would follow the path shown by the arrows in the tubes of Fig. 6.

The plate of the tube in Fig. 6 is connected to the positive side of the battery while the filament is connected to both positive and negative sides of the battery. The plate is therefore at a higher voltage than the greater part of the filament. It is found that electric current will flow from a body of higher potential through a vacuum to a body of lower potential when the low potential body is heated above a certain point. If this statement holds true it is only natural to suppose that increasing the difference of voltage between the two bodies will cause more current to flow.

The voltage applied to the plate may be increased as shown at the right in Fig. 6. Here an additional battery is used. The filament battery remains as before but the plate battery is connected between the tube's plate and filament. As indicated the flow of plate current is greatly increased by the additional voltage from the plate battery.

Electron Flow.—In the plate circuit of a vacuum tube such as shown in Fig. 6 we not only have the flow of electric current indicated by the arrows but we also have a flow of electrons in the same circuit but in a direction opposite to that in which the current flows. Electrons are charges of negative electricity. In one sense they might be considered as electricity itself. They are no form of matter, they are not atoms, and they are not molecules of any substance. The theory of electrons and electron flow is explained under the heading of *Electrons*, to which reference should be made for a more complete understanding of actions taking place in the tube.

As indicated in Fig. 7 the hot filament emits electrons from its surface. These electrons are emitted from the filament surface very much as steam is emitted from the surface of hot water. The electrons are negative and the plate is positive. Positive and negative charges attract each other, consequently the electrons are drawn away from the filament, through the vacuum and to the plate by the positive charge of the plate. The electron flow is from filament to plate, just opposite to the direction of current flow.

The greater the positive voltage of the plate or the greater the positive charge on the plate, the more rapidly will the electrons be drawn away from the filament and onto the plate. The positive charge on the plate may be made high enough by increasing the voltage of the plate battery to draw all of the electrons emitted by the filament over to the plate. Further increases of plate voltage can then cause no further increase of electron flow.

Space Charge.—If we consider the number of electrons which leave the filament of a tube and travel through the space between it and the anode or plate it is easy to see that there will always be a certain number of electrons in the space between filament and plate. To a certain extent the space is filled with negative charges of electricity or electrons. It is well known that like charges repel each other, therefore, when still more negative electrons attempt to

TUBE, ACTION OF

leave the filament they are repelled by those electrons already in the space and these additional electrons are driven back toward the filament. They may even be driven back into the filament.

The negative electrons already occupying the space between filament and plate make up what is called the space charge. It is the negative charge which is in the space between filament and plate. In order to increase the electron flow from filament to plate we may decrease the space charge. The space charge may be decreased by

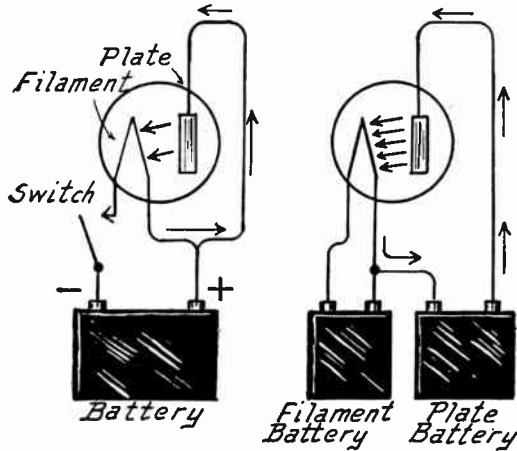

FIG. 6.—Increase of Plate Current with Plate Voltage in Tube.

increasing the positive voltage of the plate so that more of the electrons are drawn toward it, thus reducing the number of those in the space charge.

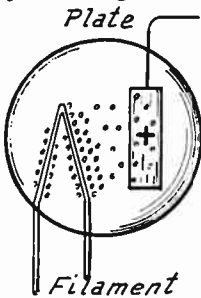

FIG. 7. — Electrons Emitted from Filament Attracted to Plate of Tube.

It has just been stated that unlike charges, positive and negative, attract each other. It is also true that like charges, such as two negative charges, repel each other. Therefore, every electron in the space charge is repelled by all the other electrons. An electron near the filament is pushed back toward the filament by the repulsion of the space charge. But an electron that has gotten near the plate is pulled toward the plate by the positive charge of the plate.

Action of Grid.—It will now be shown how the grid decreases or increases the electron flow and the current flow by either assisting the space charge or by opposing the space charge.

TUBE, ACTION OF

As shown in all the preceding diagrams the grid is placed between the filament and the plate. The grid is right in the midst of the space charge. The grid itself may be made positive as shown in Fig. 8 or may be made negative as shown in Fig. 9. When the grid is made positive it draws more electrons from the filament. The positive grid tends to partially neutralize or destroy the effect of the space charge, which is always negative. The path of the electrons from filament to plate is thus made easier by the positive grid and, as shown in Fig. 9, a large number of electrons pass through the grid and reach the plate.

It has been mentioned that the negative space charge tends to push the electrons back to the filament and keep them from reaching the plate. Of course the plate voltage may be raised to increase the positive charge upon the plate, thus pulling the electrons more forcibly toward the plate, but this positive charge must always overcome the effect of the negative space charge.

If the grid is made negative as shown in Fig. 9 the negative charge upon the grid assists the negative space charge so that the electrons meet more resistance than ever in attempting to pass from the filament through the grid to

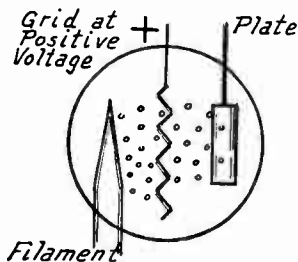

FIG. 8.—Effect of Positive Grid Voltage on Electron Flow.

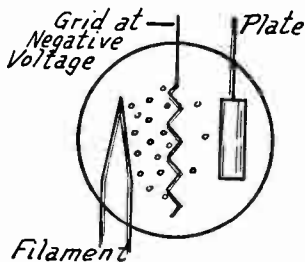

FIG. 9.—Effect of Negative Grid Voltage on Electron Flow.

the plate. This negative charge upon the grid therefore decreases the flow of electrons.

This effect of the grid in either increasing or decreasing electron flow and plate current is of exceedingly great importance in radio work. It is this effect that allows us to control quite heavy currents from the plate battery shown in Fig. 6 by impressing very small changes of voltage upon the grid, that is, by making the grid first positive and then negative or by raising and lowering its voltage.

Current in Grid Circuit.—If the grid is made positive as in Fig. 8 it is easy to see that the positive charge on the grid will attract electrons to the grid itself just as a positive charge upon the plate attracts electrons to the plate. A flow of electrons always means a flow of current, consequently with a positive grid there will be a flow of current, and electrons, in any circuit connected to the grid.

Flow of current in the grid circuit is generally undesirable. The thing desired from the grid is a control of current flow in the plate circuit and nothing more. Whatever current flows in the grid circuit, due to the grid being positive, must be subtracted from the

TUBE, ACTION OF

flow of current in the plate circuit because both currents must start with the electrons emitted from the filament. Whatever electrons go to the grid cannot go to the plate.

Flow of current in the grid circuit may be prevented by keeping the grid at a negative voltage all the time. Making the grid more or less negative will allow it to have just the same effect in opposing or assisting the space charge

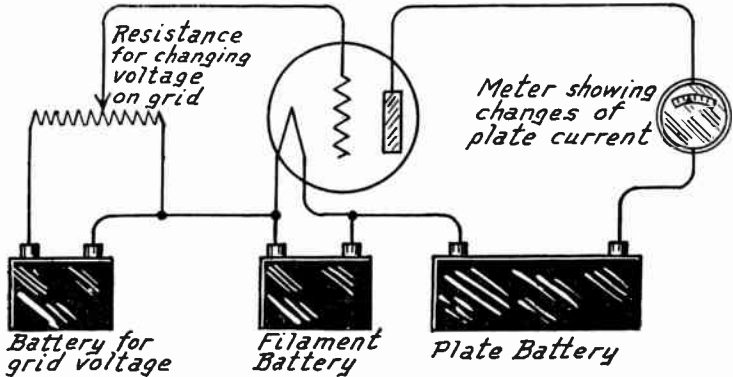

FIG. 10.—Meter in Plate Circuit of Tube to Show Effect on Plate Current of Changes in Grid Voltage.

as though the grid were alternately made negative and positive. Any change of voltage on the grid has its corresponding effect on the space charge. So, changing the negativeness of the grid is just as good for purposes of control as though its polarity were completely reversed. A negative grid has full control over flow of current in the plate circuit but allows no flow of current in the grid circuit.

Current in Plate Circuit.—A tube may be connected as shown in Fig. 10 with a meter which will indicate current flowing in the plate circuit. In order to change the voltage on the grid, the grid is shown connected to a battery through a resistance. Moving the

Steady Plate Current ↘

Zero Current Line ↘

FIG. 11.—Steady Plate Current with Steady Grid Voltage in Tube.

slider of this resistance toward the left will make the grid more negative while moving it to the right will make the grid more positive. The effects on the plate current of changing the grid voltage are shown in Figs. 11 to 14.

In Fig. 11 is represented the steady flow of plate current which takes place when no change of grid voltage is being made. The amount of plate current flowing depends upon the voltage applied to the plate and the electron emission from the filament.

TUBE, ACTION OF

If the grid voltage is suddenly increased, made more positive or less negative, the effect on the plate current would be as shown in Fig. 12. Each time the grid voltage increases there would be a corresponding increase of plate current.

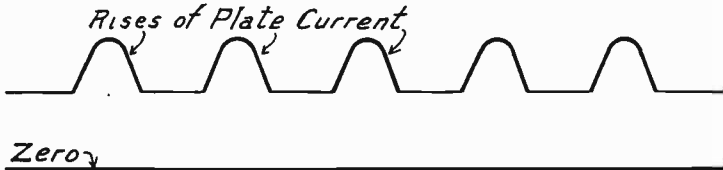

FIG. 12.—Rises of Plate Current Due to Increases of Grid Voltage in Tube.

Now if the grid voltage be decreased, made less positive or more negative, the effect would be to drop the plate current as shown in Fig. 13. Were the grid voltage permanently decreased, the plate current would be permanently decreased and were the grid voltage permanently raised the plate current would likewise be raised. Per-

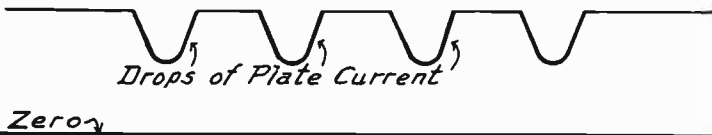

FIG. 13.—Drops of Plate Current Due to Decreases of Grid Voltage in Tube.

manent changes of grid voltage produce permanent changes in the steady plate current while rise and fall of grid voltage will produce corresponding rises and falls of plate current. The change in plate current is always in almost direct ratio to the change in grid voltage.

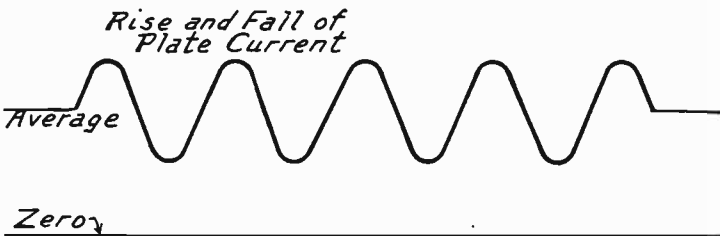

FIG. 14.—Rise and Fall of Plate Current with Rise and Fall of Grid Voltage.

If an alternating voltage is impressed upon the grid the result will be a fluctuating current in the plate circuit just as indicated by Fig. 14. It will be noticed that the plate current never drops to zero even when the grid voltage is at its minimum. There is always a certain amount of steady current or direct current flowing in the plate circuit. The changes of plate current are simply added to and subtracted from the steady or direct plate current.

TUBE, AGING OF

Much has been said about grid voltages and plate voltages. Voltage is a relative term meaning that the electrical potential is either higher or lower than the potential of some other point. In speaking of grid voltages and plate voltages they are always given with reference to the voltage of the negative end of the tube's filament.

TUBE, AGING OF.—See *Tube, Manufacture of*.

TUBE, ALTERNATING CURRENT TYPE.—Any vacuum tube used for amplification or detection and obtaining the heat required for electron emission by means of alternating current introduced into the tube itself may be classed as an alternating current tube. There are two distinct classes of such tubes. One class passes the alternating current through a filament which is also the cathode or emitter of electrons. The other class of tube passes the alternating current through a separate heating element which does not emit electrons but which heats a separate cathode acting as the emitter. The first class is called an alternating current filament or A. C. filament tube and the second is called a heater tube.

A. C. Filament Tube.—This tube has the same operating characteristics as corresponding types of direct current tubes so far as plate and grid circuits are concerned. The tube is similar in appearance and in general construction to direct current tubes designed for similar purposes. The sole difference is in the filament.

The chief problem in designing the A. C. filament tubes is to reduce the tendency for carrying the alternating current hum into the plate and grid circuits. There are several reasons for this hum. First, there is the rise and fall of temperature as the alternating current rises from zero to maximum and then falls again. This changes the rate of emission of the filament at twice the frequency of the heating current. Second, there is the effect of the high voltage end of the filament on the low voltage end as first one end is at a positive voltage and then at a negative voltage with respect to the other. Here electron flow changes with the relative voltages of different parts of the filament. Third, there is a certain electromagnetic radiation from the filament due to rise and fall of current through the filament just as there is radiation from any conductor in which the current is changing.

The rise and fall of temperature is minimized by making the filament of such proportions and of such material that its heat changes slowly. It heats slowly and, because of a low rate of heat dissipation, cools slowly. This calls for a filament of large cross section and a material furnishing a plentiful electron emission at low temperatures. Many of these filaments are of the oxide coated type for the latter reason. The effect of voltage difference in the filament is minimized by keeping the ends well separated or by using a long, straight filament and by operating it at voltages low enough so that the difference between maximum and zero voltage is not great. In still other designs the radiation problem is handled by using a comparatively high voltage with a correspondingly low current.

The A. C. filament type of tube uses a standard socket, the tube itself having the same four prongs as direct current types. The filament, plate and grid prongs and their socket terminals are in the same relative positions on the A. C. filament tube parts as on the direct current tubes.

This type of tube gives excellent results as an amplifier at any

TUBE, ALTERNATING CURRENT TYPE

frequency. It is used in radio frequency, intermediate frequency and audio frequency positions. It is not generally suited for use as a detector because of the difficulty of eliminating the hum tendency in that position.

Heater Type Tubes.—Because of the separation of the heating function from that of electron emission the heater types of alternating current tubes show greater variation in design than the A. C. filament types. The type of heater tube which has been in use for the longest time has the heater terminals on an insulating cap at the top as in Fig 1. The heating element is a wire doubled back on

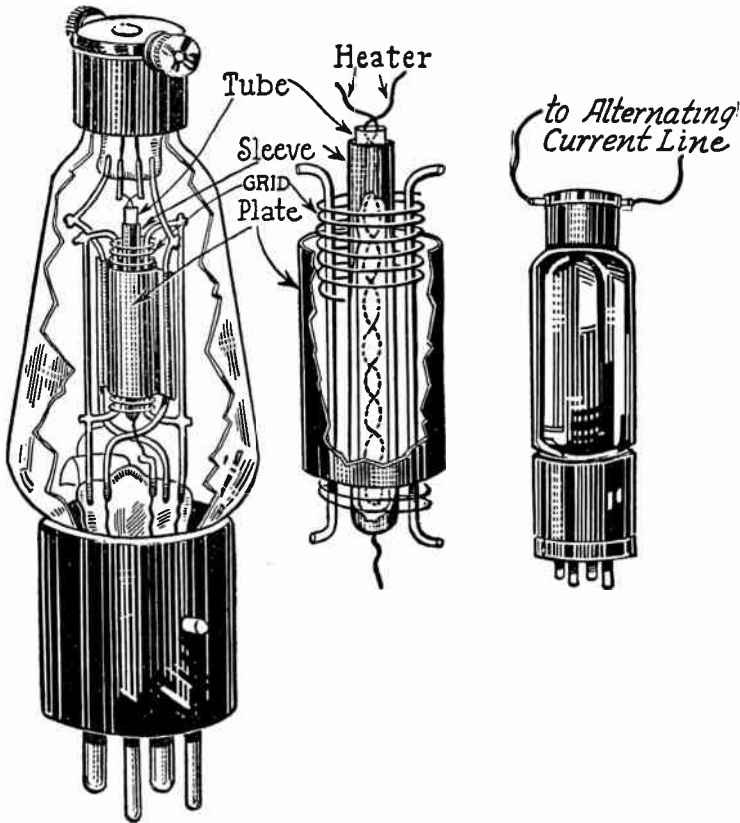

Fig. 1.—The Construction and Appearance of a Heater Type Alternating Current Tube.

itself to reduce inductance. This wire is enclosed in an insulating sleeve and there is an oxide coated sheath fitting tightly around the outside of the insulating sleeve. The oxide sheath is the cathode or electron emitter and is heated indirectly from the heater wire.

TUBE, ALTERNATING CURRENT TYPE

The cathode is connected to one prong on the tube's base, this prong occupying the position of the negative filament terminal in a direct current tube.

The heater type of tube with its separate cathode may be represented as in Fig. 2 which shows a typical grid circuit and plate circuit connected to the tube's elements.

There are four prongs on the base so that this tube utilizes a standard type of socket. The socket connections, looking down from the top, are shown in Fig. 3. The cathode or emitter is connected as already mentioned. The prong occupying the position of a positive filament prong on a direct current type has no connection with any of the internal elements in the tube. The cathode is surrounded by a spiral grid of usual form and around the outside of the grid is a cylindrical plate of the same type used in many direct current tubes. The plate and grid prongs on the tube's base are in the same positions as corresponding prongs on the standard direct current type.

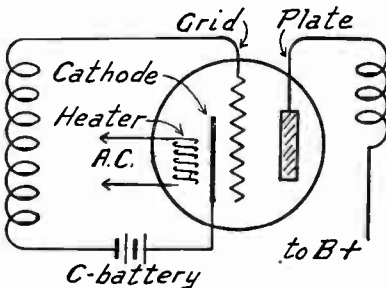

Fig. 2.—Circuits of Heater Type of Tube.

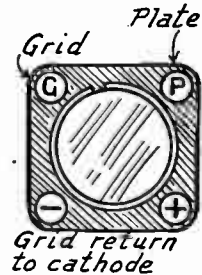

Fig. 3.—Socket Connections for Heater Tube.

Another type of heater tube has five prongs on its base, two for the heater unit, one for the cathode, one for the plate and one for the grid. This tube uses a socket arranged as in Fig. 4. The heater, its insulating sleeve and the oxide coated sheath or cathode are of similar construction to corresponding parts in the tube already described except that the heater connections are made at the bottom. Around the cathode is the usual form of spiral grid. The plate in one such tube is made of a fine mesh wire screen in place of the solid sheet metal generally employed.

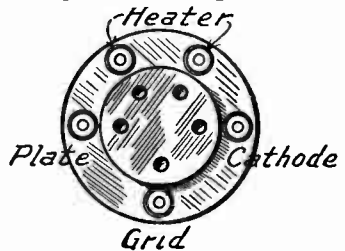

Fig. 4.—Socket Connections for Five-prong Tube.

Still another heater type tube employs a carbon heater filament surrounded by the usual emitter or cathode but with the two connected together at the top. Since these parts are electrically connected the insulating sleeve is omitted from between them and for

TUBE, ALTERNATING CURRENT TYPE

the remainder of their extent they are separated only by a small spacing. This tube may be represented by the symbol in Fig. 5. It uses a standard socket and the connections to the terminals are as shown in Fig. 6.

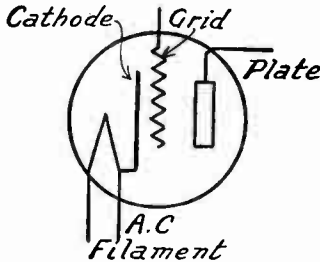

Fig. 5.—Cathode With Attached Heater.

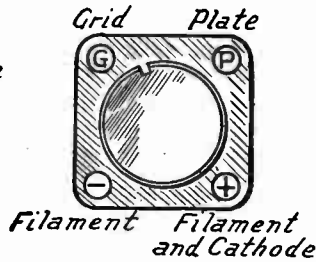

Fig. 6.—Socket Connections for Cathode Attached To Heater

The heater types of tubes may be used in any position with equally good results. That is, they may be used as radio frequency amplifiers, as detectors or as audio frequency amplifiers. In receivers using the A. C. filament tubes as radio frequency and audio frequency amplifiers the heater type of tube is generally used as a detector.

D. C. Tubes On Alternating Current.—Practically all of the power tubes originally designed for operation on direct current may be operated equally well as A. C. filament tubes. Most power units have a five-volt, a six-volt or a seven and one-half volt circuit taken from a separate secondary winding on the transformer, this circuit feeding the filament of the output or power tube. The same circuit arrangements and same precautions are used in handling such tubes as with the regular A. C. filament types.

The power tubes with oxide coated filaments are especially well suited for use with alternating current. This type of filament allows plentiful electron emission at a dull red heat, this low degree of heating being one of the essentials for successful alternating current operation.

Operating Voltages.—The plate voltages, plate currents, and grid biasing voltages for alternating current tubes are practically the same as for corresponding direct current tubes but the voltage and current for the filament or for the heater vary within wide limits for different makes of tubes and for different types of the same make.

Heater or filament voltages include: 1.0, 1.5, 2.5, 3.0, 5.0, 5.5 and 15.0. The current in the filament or heater circuits includes such values as 0.35, 1.0, 1.5, 1.75, 2.0 and 2.5 amperes. This practice makes it necessary to employ different transformers for different tubes and oftentimes to employ a transformer with two or three separate secondary windings for a single receiver.

Heaters or filaments for alternating current tubes are connected

TUBE, ALTERNATING CURRENT TYPE

in parallel on a single circuit of appropriate voltage for any number of tubes.

It is always advisable to operate filaments or heater elements at the lowest voltage and current which will give satisfactory amplification and good quality. The same rule applies to plate voltages. These precautions will materially lengthen the life of such tubes. The supply line circuit should always be opened by turning off the switch controlling the transformer before any alternating current tube is removed from its socket. This is done because the great change in current with one tube out of place causes a dangerous increase of voltage on those remaining in their sockets if the power remains turned on.

Because of the slow heating and cooling of the emitting elements in these tubes it requires from one-quarter minute to one and one-half minutes after the switch is turned on before the receiver will operate normally. The heater types take longer than the A. C. filament types to reach their operating temperature.

Grid and Plate Returns.—When using direct current tubes the grid return or C+ and plate return or B— are connected to the negative side of the filament circuit or in some cases to the positive

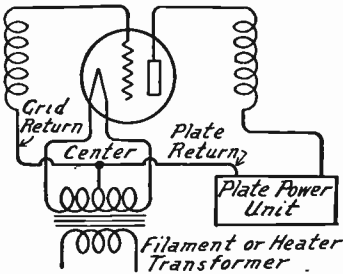

Fig. 7.—Returns To Center Tapped Transformer.

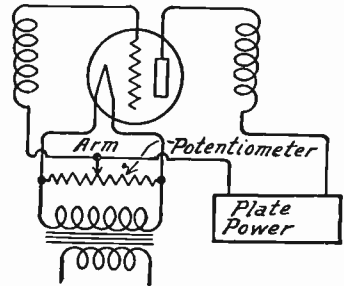

Fig. 8.—Returns To Slider of Potentiometer.

side. Either side of a direct current filament circuit is at a steady voltage so that such a return is satisfactory. With alternating current tubes it is not possible to follow this practice because both sides of the filament or heater circuit are at a continually rising and falling voltage. The change of voltage on the grid return would cause a continually changing grid bias while for the plate return it would cause a continually varying plate voltage. Either method would cause a loud hum because of these changing factors in operation.

With alternating current tubes the grid and plate returns must be made to a point of steady voltage or of zero voltage. The general principle is shown in Fig. 7. The electrical center of the transformer secondary remains at zero voltage as the potential at the two ends rises and falls. Consequently the returns of grid and plate circuits are brought more or less directly to this center point.

If the transformer secondary has no center tap or if the tap is not at the exact electrical center the method of Fig. 8 is resorted to. A low resistance potentiometer is connected across the ends of the transformer secondary and

TUBE, ALTERNATING CURRENT TYPE

the return ends of the grid and plate circuits are brought to the sliding arm of the potentiometer. As the voltage at the two ends of the transformer secondary and the two ends of the potentiometer rises and falls there will always be a point somewhere along the potentiometer where the voltage remains zero or practically zero. The potentiometer arm is moved until, by trial, this zero point is found and there the hum will be eliminated or reduced to its lowest value.

The methods shown in Figs. 7 and 8 would provide the equivalent of a zero bias. This is not always satisfactory since many tubes must be given a negative grid bias and others require a positive bias, depending on the use to which they are put. Any required negative bias is secured by using voltage drops in the plate current circuit according to the principle shown in Fig. 9.

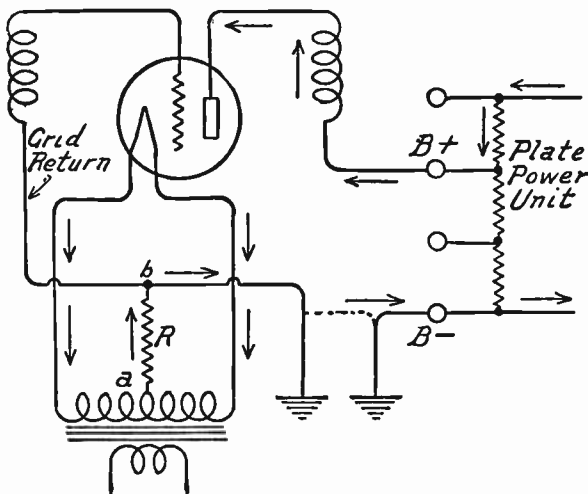

Fig. 9.—Plate Circuit of Tube When Biasing Resistor Is At Transformer Tap.

In Fig. 9 the plate circuit for one tube is shown as starting at the B+ terminal of the plate power unit. This point is at the highest voltage in the circuit and the path of the plate current is shown by the small arrows as passing through the tube's plate winding, then the tube itself to the filament, the two filament lines to the ends of the transformer secondary winding and then to the electrical center tap of the winding. Since the current has been overcoming resistance in each of the parts through which it has passed the voltage has been constantly dropping. The drop of voltage continues as the plate current flows from the center tap of the transformer through the resistance R from point a to point b . Therefore, the potential of point b must be lower than that of point a . The filament is connected through the transformer winding to point a while the grid return is made to point b which is at a lower voltage than any part of the filament. This grid circuit has thus been given a negative biasing voltage depending on the resistance of R and the drop of voltage taking place through it.

Still considering Fig. 9, the plate current continues back to the B- terminal of the power unit, sometimes going through ground on the way. It may

TUBE, ALTERNATING CURRENT TYPE

be seen that, although the grid return is connected to the B— terminal which is generally thought of as at zero voltage, the grid really has a negative bias with reference to the filament of its tube. The method of Fig. 9 may be applied to the potentiometer return of Fig. 8 by connecting point *a* on resistance *R* in Fig. 9 to the sliding arm of the potentiometer which serves as the electrical center of that part of the filament circuit outside the tube.

The filament or heater supply transformer might have several secondary windings to furnish different voltages to different tubes as in Fig. 10. The 1½-volt winding is provided with a potentiometer to the arm of which is connected a biasing resistance *R*. The 2½-volt winding has a center tap which is connected a biasing resistance *R*. The 5-volt winding has a center tap but no biasing resistance, consequently any tube connected here will have a

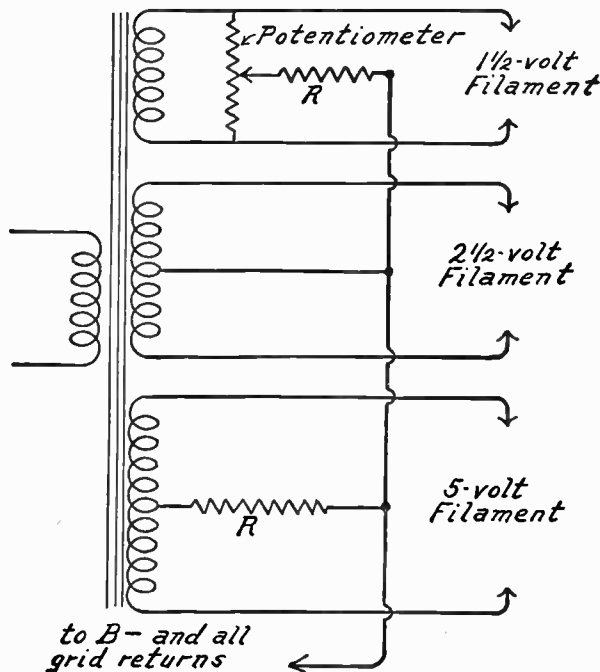

Fig. 10—Transformer With Various Voltages
and Types of Center Returns.

zero grid bias. The 5-volt winding has a center tap and a biasing resistance *R*. All biasing resistances or transformer centers are then connected to the B— line which is usually ground as well. This line, or ground, will then connect to all grid returns. Then, although all grid returns are connected to B— or ground, all have different biasing voltages applied to them by their respective resistances.

It is also possible to obtain any desired negative grid bias by additional resistances in the plate power unit. The system is described under the sub-heading *Grid Bias from Plate Voltage Units* in the section on *Power Unit, Plate Voltage Types*. The two methods are the same in results.

TUBE, ALTERNATING CURRENT TYPE

That an exactly equivalent result in grid biasing is obtained with power units having C— taps may be seen by examination of Fig. 11. Here again the path of the plate current is shown by the small arrows. It starts from the B+ terminal of the power unit, flows through the plate winding, then through the tube from the plate to the filament, through the filament lines and the two legs of the transformer secondary to the center tap. With no center tap the current would flow through the two legs of a potentiometer to the slider. The slider or the center tap will be grounded or else connected directly to the B— terminal of the power unit as shown and the plate current will continue in this way to the power supply.

The voltage has been continuously dropping and now, as the plate current passes through the power unit resistor R between the B— and C— terminals, there is a further drop which causes the B— terminal to be at higher voltage than the C— terminal. The grid return is brought to the point of lower voltage or to the C— terminal which is at lower potential than the filament as represented by the center of the transformer secondary. It is simply a case of placing the biasing resistor at the transformer in Fig. 9 and at the

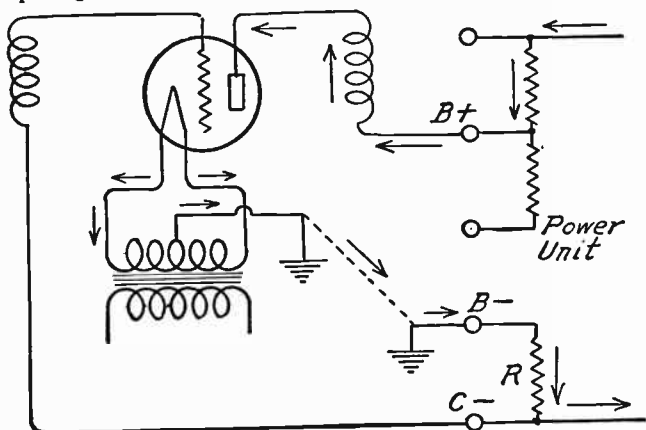

Fig. 11.—Plate Circuit of Tube When Biasing Resistor Is in Plate Power Unit

plate power unit in Fig. 11. The voltage drop through this resistor, wherever placed, provides the desired negative grid bias.

In operating alternating current tubes in radio frequency stages they almost always require at least one or two volts negative grid bias whereas with direct current tubes a zero bias is common in radio frequency tubes. In audio frequency stages the alternating current tubes will always require negative grid biases to correspond with the plate voltages employed. Detector tubes of the heater type may require a zero bias, a negative bias or a positive bias. A positive bias is obtained by connecting the center tap or potentiometer arm of the detector heater winding to one of the positive terminals on the plate power supply unit. Biases of from twenty to forty volts positive are often used. The best bias for the detector is determined by trying negative, zero and positive, using the one giving best detection and tone quality with freedom from hum.

TUBE, ALTERNATING CURRENT TYPE

The potentiometer used across a transformer secondary in obtaining the electrical center should have low resistance and should pass from 1/10 to 1/4 ampere. This calls for resistances of from six to thirty ohms, depending on the secondary voltage. The type of potentiometer used for regeneration control and having two hundred or more ohms resistance cannot be used here. Many types of rheostats can be made over into satisfactory potentiometers if there are terminal connections available at both ends of the rheostat winding. The rheostat arm then acts as the potentiometer slider with the two ends of the winding connected to the secondary winding of the transformer.

It will generally be necessary to use transformers especially built for this work, such types as toy transformers seldom giving good results. There should be a metal electrostatic shield between the primary and secondary windings in the transformer. Some tapped transformers are not tapped at the electrical center and it may be better to use a potentiometer across the ends, disregarding the tap entirely.

Differences between individual tubes sometimes make a single center connection on the transformer unsuitable for all stages and will leave a hum due to unbalance in some tubes while others are quiet. It may then be

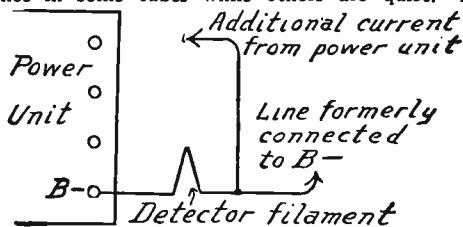

Fig. 12.—Detector Filament Current From Plate Power Supply.

necessary to use individual potentiometers connected across the filament terminals of each tube with that tube's grid return made to the arm of its own potentiometer.

It may be mentioned here that it is absolutely necessary to place a bypassing condenser of liberal capacity across the ends of all biasing resistances used as in Figs. 9, 10 and 11. These bypasses should be of one microfarad capacity.

Detectors with A. C. Tubes.—Two types of tube are available for use as detectors. One is the heater type of alternating current tube operated from an alternating current supply. The other is the 3-volt, 60-milliamperere type of direct current tube operated from a combination of plate current passed through other tubes and additional current taken from the plate power unit and added to that used in the tubes. This is the familiar "190" type of tubes used in dry-cell receivers.

The heater type of alternating current tube may be used with a grid condenser and grid leak for grid current rectification or may be used with a negative grid bias without the condenser or leak for plate current rectification. The grid condenser and leak give greater sensitivity while the bias method gives somewhat better tone quality in some cases. Under ordinary

TUBE, ALTERNATING CURRENT TYPE

conditions the biasing method of detection will require a negative bias on the detector grid return of from one to three volts, about forty-five volts on the plate circuit and a grid leak of between two and five megohms. Higher plate voltage and a lower resistance grid leak will give excellent quality but less volume.

The principle used in operating the sixty milliamper tube as a detector is shown in Fig. 12. The line ordinarily connected to the B— terminal of the plate power unit carries all of the plate current passing through all tubes in the receiver. This line is passed through the detector filament. Since it requires fifty to sixty milliamperes to operate this filament and since most receivers use only twenty to forty milliamperes plate current it will be necessary to take additional current from the plate power unit, add it to the plate current and pass the total current through the detector filament.

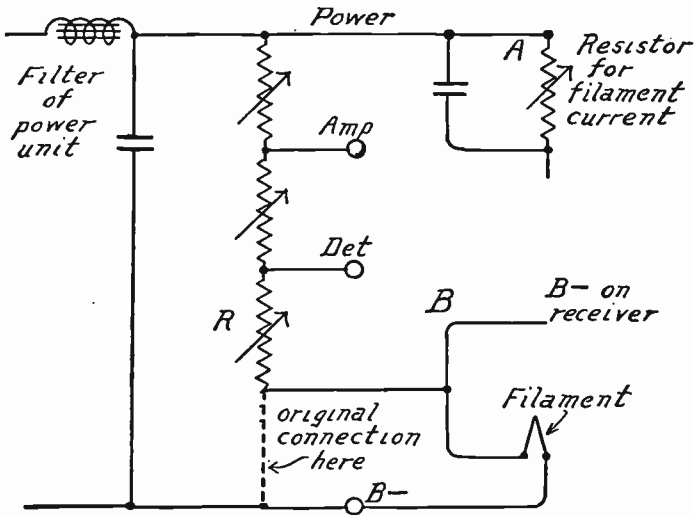

Fig. 13.—Detector Filament Current from High Voltage Terminal at A and from Low Voltage End of Circuit at B.

To use this plan calls for a transformer, a rectifier and a filter system in the power unit which will be able to deliver sixty milliamperes at the required maximum plate voltage for the receiver without overloading. Not all power units will do this. If the method is attempted with a power unit not especially designed for such work it will be advisable to watch carefully for overheating in the transformer, the rectifier and the chokes for the first hour or so of operation.

The additional current for the filament should be taken from a point between the output end of the last filter choke and the connection of this point to the first resistor in the voltage control system for plate current supply. With some designs of power unit the output from the last choke comes directly to the high voltage or power tube terminal of the unit. The extra current can then be taken from this terminal through an added resist-

TUBE, ALTERNATING CURRENT TYPE

ance as at *A* in Fig. 13. In other designs it will be necessary to make the extra connection inside the unit to avoid passing this current through any of the regular plate voltage control resistors. The reason for not using the regular resistors is that they will seldom carry the extra current and lower the voltage without overheating.

If the resistors in the power unit are able to carry additional current the method at *B* in Fig. 13 may be used. Here the detector control resistor *R* and the B— terminal of the power unit after the resistor *R* has been disconnected from that terminal in the power unit. This allows all of the extra current to flow through all the resistors and will make the plate voltages from the power unit much more stable than before. The B— line from the receiver is connected to the detector filament at the point shown.

In a power unit arranged as in Fig. 14, with the plate voltage resistors in series with the plate circuits, the extra filament current for the detector may be taken from the detector terminal of the power unit. This is the terminal originally carrying the least plate current and will best stand the extra load.

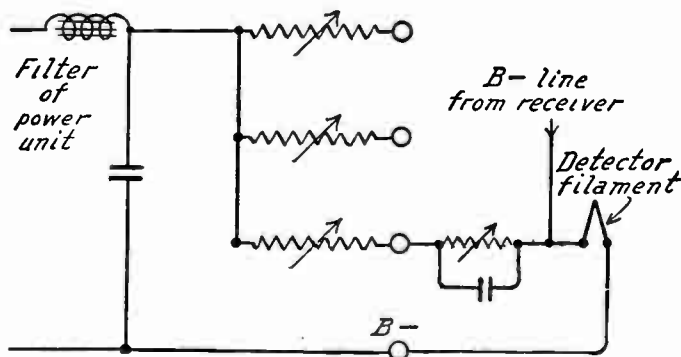

Fig. 14.—Detector Filament Current from Detector Terminal of Plate Power Unit.

With any of these connections the regular plate current connections to the receiver remain as before on their respective positive terminals.

A milliammeter should be connected in series with the detector filament or a voltmeter should be connected across the filament terminals of this tube. Best operation will be had between 54 and 60 milliamperes, which corresponds to between $2\frac{1}{2}$ and 3 volts. Incorrect filament current will cause humming, motorboating or howling. The detector tube should never be removed and then replaced in its socket with the plate power unit turned on because the discharge of the filter condensers will burn out or damage the tube's filament.

Hum In Alternating Current Receivers.—The tendency to hum is the only pronounced fault that may be found in an alternating current receiver that may not also be found with a similar type using direct current tubes. The hum may be due to trouble in the heating circuits, in the plate power supply unit or in the combination of the two. Trouble in the plate power unit is a separate subject; generally being due to defective rectifiers, shorted transformers or choke windings, defective filter condensers and grounded transformer windings.

TUBE, ALTERNATING CURRENT TYPE

If potentiometers are used to obtain a center point for grid return on the filament or heater transformers these potentiometers should carefully be adjusted to the point of least hum. The heater type of detector is not especially critical as to an exact center return although there is always a best point. The greatest source of hum is in the detector, next comes the audio amplifying system and least sensitive to this trouble is the radio frequency amplifier.

The power unit and the filament supply transformer should be kept as far as possible from the detector and audio amplifier. In extreme cases it may be advisable to enclose the detector tube in a grounded metal shield. It is essential for best results to ground the case of the power supply unit and to ground the cases of all audio amplifying transformers or chokes. The phase relation between different parts of the power unit may be changed by reversing one of the plugs connecting a transformer to its light circuit line and this may be tried.

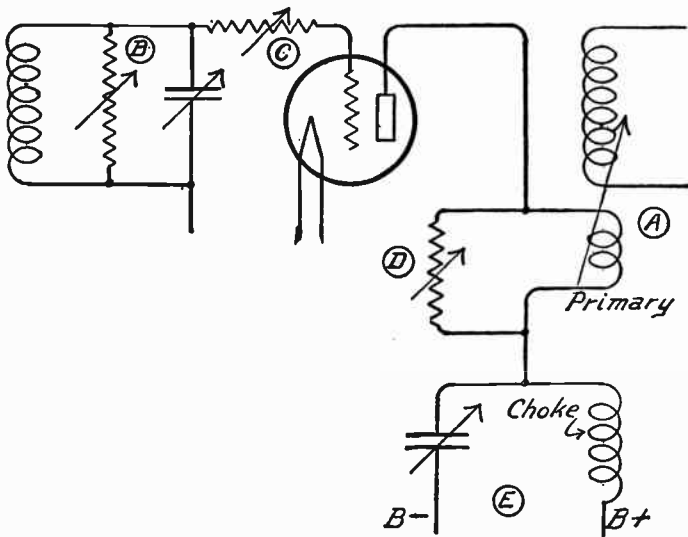

Fig. 15.—Various Controls of Radio Frequency Stage. A: Adjustable Primary. B: Tuned Circuit Resistor. C: Resistor in Grid Lead. D: Resistor Across Primary. E: Choke and Condenser for Throttle Control.

With A. C. filament tubes the amount of hum depends somewhat on the relation between plate current and filament temperature. There is a best filament voltage for each value of plate current, the two going up and down together. Trial of different filament voltages with a fixed plate voltage and current will determine the optimum point. For this reason variation of plate voltage and current is not always satisfactory as a volume or regeneration control.

With heater types of tubes the hum will be quite noticeable until the heater elements reach their normal operating temperatures. Hum will generally be rather bad whenever any of the radio frequency circuits are oscillating due to pushing the volume control too high.

Motorboating will be caused by a defective detector tube, incorrect detector filament current, excessive detector plate voltage, too high resistance in the detector grid leak or by any of the causes given under *Motorboating*.

TUBE, ALTERNATING CURRENT TYPE

Volume and Regeneration Controls.—Almost any system of control for volume and regeneration suitable for use with direct current tubes will operate equally well with alternating current types. Several methods are shown in Fig. 15.

Variable coupling of the primary winding at *A* in one of the radio frequency transformers is satisfactory except that it changes the tuning point when this variation is controlled independently of the tuning control. A variable resistance of 200,000 to 500,000 ohms connected across the secondary of one radio frequency transformer at *B* will provide control. Variable resistance at *C* in a radio frequency grid circuit will allow control but will reduce selectivity. A variable resistance of one or two thousand ohms connected across the primary winding of one radio frequency transformer at *D* makes a good method of control since it does not greatly affect the amount of plate direct current in the tube connected to that winding. The throttle control of *E*, also shown with one of the receivers under *Receiver, Single Control*, is very effective but requires a control condenser of large capacity, usually in the neighborhood of 2,000 micro-microfarads. It may be handled with a 1,000 micro-microfarad variable condenser by connecting an additional fixed condenser of the same capacity in parallel, with a switch to allow handling low frequencies or high wavelengths.

Wiring for Alternating Current.—Because of the low voltage and heavy current required by most alternating current tubes there is a serious drop of voltage unless the conductors are of ample size. There is four times the voltage drop in a given length of number 18 wire as in the same length of number 12 when carrying the same current. Number 14 is a safe gauge size for all circuits carrying not more than four tubes. With wire too small and tubes in parallel along a single line the tube nearest the transformer will get the highest voltage and the one farthest away will get the lowest voltage. If a rheostat controls the voltage one tube will be overheated in the attempt to make the last one function at all.

All wiring carrying alternating current should be of twisted pair. If the desired gauge size cannot be secured the same result is obtained by taking two separate wires and twisting them together. This reduces the radiation of electromagnetic fields. The alternating current lines should be bunched or cabled and kept away from all other wires, especially plate and grid wires. The alternating current wires are sometimes carried in a metal sheath which is grounded but this should not be necessary.

All joints in these lines must be well soldered. Large lugs should be used and a firm contact of large surface area should be made at the terminals on tube sockets, transformers, rheostats and all other parts through which the circuit passes. In order to maintain the same voltage at all tubes on one circuit it is worth while to make the total length of wiring the same between each tube and its transformer as between any other tube and the same transformer. This is shown in Fig. 16 where the distance along the wires from the transformer is the same to all four tubes, this resulting in reasonably even voltage drops. To get exactly the same drop it would be necessary to allow for the changed values of current in the several sections of wiring.

If the power transformer is inside the receiver cabinet there should be a five-ampere enclosed fuse in each side of the light circuit supply line just inside the cabinet. If the transformer is housed in another compartment the fuses should be just inside that compartment.

TUBE, ALTERNATING CURRENT TYPE

To allow operation of filaments and heaters at lowest satisfactory voltages it is customary to have rheostats in the several lines between transformer and sockets. These rheostats, with most tubes, must carry heavy currents but need have little resistance in ohms. Such rheostats as used for direct current tubes are entirely unsatisfactory because of overheating and burning out. The value required for any rheostat may be found as follows: From the number of volts furnished by the transformer subtract the number of volts desired as a minimum at the tubes. Divide this difference by the number of amperes which will flow through the rheostat, this being equal to the number of tubes handled times the current in amperes taken by one of them.

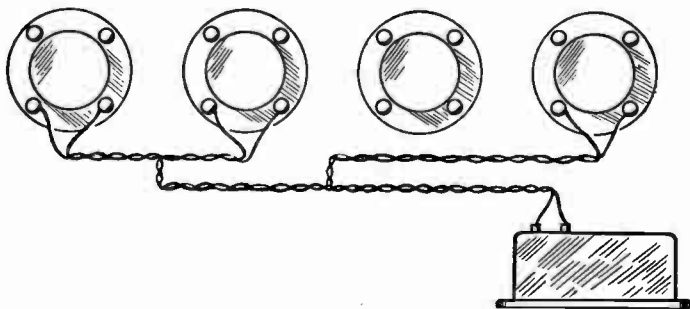

Fig. 16.—Method of A. C. Wiring To Provide Equal Voltages.

As an example, assume three tubes normally requiring $1\frac{1}{2}$ volts at one ampere, operated from a transformer giving 2.0 volts. It may be desired to reduce the filament voltage to 1.1 as a minimum. Subtracting this from 2.0 gives 0.9 as the difference, which is divided by three, the total number of amperes for three tubes. The result is 0.3 ohms, the resistance required in the rheostat. The rheostat resistance element must be capable of carrying the total current without overheating.

A rheostat may be inserted in either line from the secondary of an untapped transformer on which a potentiometer is used for the center turn. Placing a rheostat in only one side of a center tapped secondary circuit will unbalance the transformer and this method should not be used. Two similar rheostats may be used, one in each line from a center tapped secondary, with both adjusted for the same resistance or adjusted until there is the least possible hum.

Changing from Direct To Alternating Current Tubes.—Existing receivers designed to use direct current tubes may be changed over to use alternating current types with an amount of work depending on the original design and on the type of alternating current tubes used for replacement. Heater tubes requiring different sockets make the greatest amount of labor. Tubes using standard sockets with the alternating current connections made at the tube tops are not difficult to handle and tubes with A. C. filaments or any type using only four prongs for all the elements are easily changed.

TUBE, ALTERNATING CURRENT TYPE

The greatest likelihood of trouble comes from the introduction of alternating current into circuits which run close to or are connected to plate circuits and other lines carrying direct current for plate and grid circuits. Except with tubes taking alternating current at their tops the best results will be secured by installing complete new filament wiring. The old filament wiring need not be removed but must be disconnected from the socket terminals. The old wiring is seldom of large enough gauge size and the rheostats and filament resistors will be entirely too small.

Plate and grid circuits need not be altered. Controls for volume and regeneration will sometimes be satisfactory for the new tubes without alteration but on other cases these controls will be found ineffective, chiefly because of the changed plate current and voltage with the alternating current tubes. Care must be used to disconnect all grounds from both sides of the filament or heater circuits. All amplifier grid returns may be connected to the B— or ground line and grid biases secured as shown in a preceding portion of this section or, if grid returns are made to the plate power unit, they may remain as originally placed. The detector grid return may often require a positive bias secured from the plate power unit or from a C-battery with its positive terminal connected to the grid return and its negative terminal to ground or B—, just the reverse of usual practice.

An exact set of rules for changing all types of direct current receivers to use alternating current tubes cannot be given but in general the following method will be found satisfactory:

Both positive and negative filament terminals of all sockets should be disconnected from the old filament wiring. This filament wiring should not be otherwise disturbed. The A— terminal should be connected to the ground terminal if not already connected thus. During the first trial of the rewired receiver the A— and A+ terminals should be connected together since some grid returns may be made to the A+ line.

The volume or regeneration control should be examined. The types shown in Fig. 15 are satisfactory. Control by means of a potentiometer across the old A+ and A— lines cannot be used, neither can control by means of varying the filament voltage be used. Regeneration controlled by a movable tickler coil or by variable resistances or condensers across a tickler coil will usually be satisfactory although the tickler coupling may have to be closer than for direct current tubes. Balanced or neutralized circuits will have to be adjusted with the new tubes in use according to the methods explained under *Balancing*. The control already in use, if of any acceptable type, should be tried as soon as the receiver is ready for use and necessary adjustments should be made to allow control of regeneration and prevention of oscillation at highest frequencies with variable methods or to prevent oscillation at all frequencies with balanced circuits. This subject is fully discussed under the headings of *Regeneration, Methods of Obtaining and of Oscillation*.

New filament or heater wiring should now be installed according to the suggestions and precautions mentioned in preceding paragraphs of this section.

It is not difficult to secure necessary negative grid and heater biases by means of resistors in the center tap leads of transformers or potentiometers with all the old C-battery negative terminals connected to A— and ground. This system allows all grid returns to be made to the old filament lines in the receiver with these lines connected to ground and to B—. The details are explained in preceding paragraphs under *Grid and Plate Returns*.

The value of the biasing resistors used will depend on the plate current flowing through them for the tubes handled from the transformer winding and on the voltage drop desired for biasing. The voltage drop will be equal

TUBE, ALTERNATING CURRENT TYPE

to the current in amperes (not in milliamperes) multiplied by the resistance in ohms. The plate current may be measured with a direct current milliammeter, capable of measuring up to at least fifty milliamperes, connected in series with the resistor. This current may also be found from plate current characteristics of the tubes used if such characteristics are available. The current will depend on the plate voltage applied and on the amount of negative grid bias, increasing with increased plate voltage and decreasing with more negative bias just as with direct current tubes. If the current to any center tap can be determined the desired drop in voltage or the bias may be divided by the current in amperes to find the required resistance in ohms. Introduction of the calculated resistance will lessen the current so that the assumed voltage will not be realized and a smaller resistor will be required than called for by this method of calculation.

Although more expensive than using fixed resistors it is much easier and just as satisfactory to use variable resistance for biasing voltages when rebuilding a receiver. The resistance needed will vary from a few hundred ohms up to two or three thousand ohms in most cases, never exceeding five thousand ohms for tubes in general use. A resistor variable between these limits may be used for all circuits. With the resistor in place and the receiver in operation the desired bias may be secured by direct measurement. A direct current voltmeter having a high resistance in itself is connected across the ends of the resistor, the negative of the meter being connected to the end of the resistor farthest from the transformer. Nothing but a real high resistance type of meter suitable for measuring B-power supply voltages should be used. This meter will then read directly the biasing voltage secured as the resistor is varied and when the correct voltage is indicated the resistor is allowed to remain as adjusted.

If there is no objection to using C-batteries the original connections may be used just as found on the receiver. This, of course, does not make the finished job of the all-electric type but is easier than any other method. If the plate power supply unit has enough different C— taps, connection from the receiver C— terminals may be made to this unit. Since comparatively few of the plate power units in common use have such taps it will be necessary to use biasing resistors or C-batteries in most cases.

With the alternating current wiring installed and the biasing arrangements cared for, the tubes are inserted in their sockets and lighted from the transformer, the plate power unit is placed in operation and the receiver is ready for a trial. Adjustments will have to be made for the filament or heater voltages; for the plate voltages to detector, amplifier and power tubes and for the required grid biases and heater biases if any heater type tubes are used. These adjustments having been made, the volume or regeneration control should be tried for effectiveness at both ends of the tuning scale. It often is necessary to change this control to a type more suitable than that originally used.

In securing ample volume and sensitivity it may be necessary to increase the number of turns in the plate windings of the radio frequency transformers. In a few cases it may be impossible to control

TUBE, AMPLIFICATION OF

oscillation and the number of turns on these windings may have to be decreased. Such alterations are rarely required.

The remodeled receiver should operate with all the sensitivity and selectivity formerly obtained and the tone quality should be fully as good to the average ear as with direct current tubes. When tuned to resonance between station settings there is quite apt to be a faint alternating current hum but this is seldom objectionable when a station is being heard with reasonable volume.

The wiring and general arrangement of circuits of the receivers shown under *Receiver, Alternating Current Type* may be referred to as guides in planning the change from direct to alternating current tubes.

It is possible to change a direct current receiver into one using alternating current filament tubes by the use of socket adapters which are made for this especial purpose. With the tube removed from the socket, the adapter is inserted and the new alternating current tube is then placed in the adapter. The old direct current filament connections are no longer completed through to the new tube but in their place are used connections from an additional line carrying alternating current.

The alternating current line is made of twisted pair to reduce inductive effect and is attached to all the adapters used in the receiver for tubes taking the same voltage. If more than one alternating current voltage is required, due to the use of two or more types of A. C. tubes, one or more additional lines are run.

The other end of the alternating current line is connected to a filament supply transformer which delivers a voltage suitable for the tubes employed. This transformer may be provided with a center tap or may be used with a potentiometer to allow center return for the grid and plate circuits.

TUBE, AMPLIFICATION OF.—The number which indicates the ability of a tube in amplifying is called the tube's amplification factor, amplification constant, or coefficient of amplification; all of these terms having the same meaning. The amplification factor is often spoken of as the Mu of the tube because the Greek letter Mu (μ) is used as a symbol for the factor. The amplification factor not only indicates the maximum amplification of voltage that may be obtained from a tube, but it also indicates in great measure the tube's ability in power amplification.

If we wish to change the amount of current flowing in the plate circuit of a tube it may be done in either of two ways. First, we may increase or decrease the plate voltage or the B-battery voltage. Second, we may increase or decrease the voltage applied to the grid. Either of these will cause a change in the plate current which is usually measured in milliamperes.

A change of five volts in plate voltage or B-battery voltage will cause only a slight change in plate current. A change of five volts

TUBE, AMPLIFICATION OF

applied to the grid of the tube will cause a very great change in plate current. Say, as in Fig. 1, that the five-volt change in grid voltage causes a change of ten milliamperes in plate current. Were we to increase the plate voltage sufficiently to bring about this same ten milliamperage change in plate current we might find that it required a forty-volt increase of plate voltage to obtain the same plate current change obtained by only a five-volt change of grid voltage. Thus it would require eight times the change of plate voltage as of grid voltage to obtain the same result in plate current change. The amplification factor of this tube would then be eight.

To find the amplification factor of a tube we divide the number of volts change of B-battery current required to produce a certain increase in plate current by the number of volts change on the grid to produce the same increase of plate current. The quotient is the amplification factor of the tube. Another way of stating this is to say that the amplification factor is the

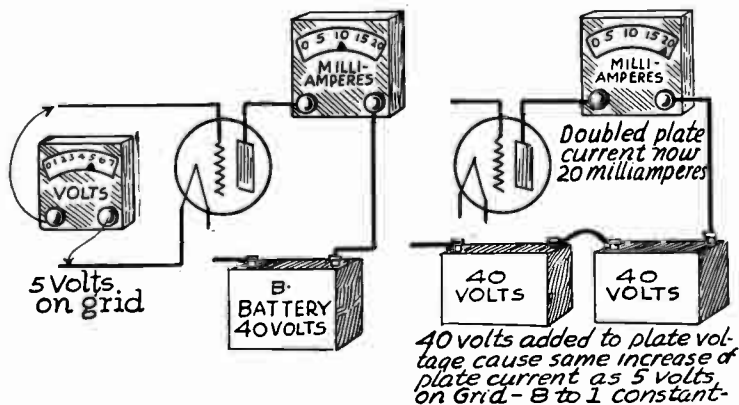

FIG. 1.—The Voltage Amplification of a Vacuum Tube.

number of times the effect of a certain grid voltage is greater than the effect of the same plate voltage on the plate current from the tube. See *Tube, Testing of*.

The general subject of amplification in radio receivers is discussed under the heading of *Amplification*. The explanations given under *Amplification, Voltage and Power* should be referred to in considering the amplification of tubes.

Voltage Amplification.—The actual voltage amplification or increase of voltage realized depends not only on the amplification factor of the tube, but also on the resistance, the inductance and the capacity in the plate circuit of the tube. The resistance in the plate circuit includes the resistance of any coils between the tube plate and the battery, the resistance of the battery itself and the resistance of the connections. Of these the resistance of the coil or of an amplifying resistor is the only thing of great importance from the standpoint of amplification. The resistance in the plate circuit also includes the internal resistance of the tube between its plate and filament. See *Tube, Output Resistance and Impedance of*.

TUBE, AMPLIFICATION OF

The value of the voltage amplification for various values of amplification factor, plate resistance and external circuit impedance is shown by the following formula:

$$\text{Voltage Amplification} = \frac{\text{Amplification Factor} \times \text{External Impedance}}{\text{Plate Resistance} + \text{External Impedance}}$$

From this formula it is evident that the voltage amplification is increased by increasing the amplification factor and by increasing the external impedance. It is decreased by increasing the plate resistance.

The tube may work into a pure resistance as at the left in Fig. 2 or it may work into a reactance as at the right. A pure reactance cannot be obtained in practice because with the reactance of any coil must be combined the resistance of the coil so that the combination forms an impedance.

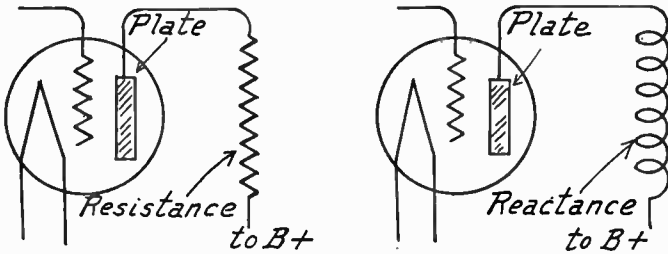

FIG. 2.—Tubes Working into Resistance and Into Reactance for Amplification.

The voltage amplification is higher when working into a reactance than when working into a resistance only. The value of the tube's amplification factor is the maximum possible voltage amplification that might be obtained. In practice it is possible to gain from fifty to ninety-five per cent of the total amplification factor as voltage amplification. The following table shows the percentages obtained with various amounts of external impedance when the impedance is composed of pure resistance and when it is composed of pure reactance:

PERCENTAGE OF TOTAL AMPLIFICATION FACTOR OBTAINABLE

Number of Times External Impedance is Greater Than Plate Resistance	Per Cent of Mu When Working into a Pure Reactance	Per Cent of Mu When Working into a Pure Resistance
6 times plate resistance	99%	84%
4 times plate resistance	97%	80%
3 times plate resistance	95%	75%
2 times plate resistance	88%	67%
Equal to plate resistance	72%	50%

This shows the necessity of having a high impedance in the plate circuit if a real gain is to be obtained. It also shows that the number of ohms in a pure resistance must be several times as great as the number of ohms in a reactance to obtain a given amplification. When using transformers as inter-tube couplings the maximum voltage will be applied to a following tube from the secondary of the transformer when the external impedance in the plate

TUBE, AMPLIFICATION OF

circuit of the first tube at least equals the internal impedance of the first tube.

The voltage amplification from a tube decreases as the frequency increases, this effect being partly due to the internal capacities in the tube. The drop of amplification with a typical tube giving an amplification of about seven and one-quarter at 500 kilocycles is down to an amplification of about four and one-half at 1500 kilocycles. This is shown in Fig. 3.

Amplifying tubes in common use have amplification factors varying between three and ten, the exact value depending on the type of tube and on the internal construction of the tube. A factor of eight is a fair average value for making rough calculations.

High Mu Tubes.—Tubes having a very high amplification factor are called high mu tubes. It is difficult to make a high mu tube that will not also have a high plate resistance. Consideration of the preceding formula for voltage amplification will show that the gain

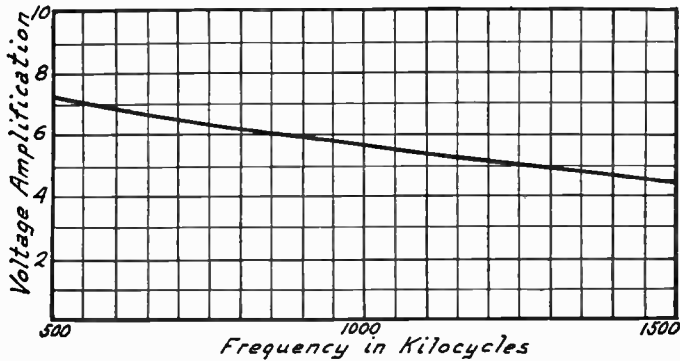

FIG. 3.—Decrease of Amplification with Increase of Frequency.

from increased amplification factor may be offset by a corresponding increase of plate resistance.

High mu tubes have amplification factors of from fifteen to forty as compared with an average of about eight for ordinary amplifiers. These high mu tubes are used as audio amplifiers and sometimes as detectors. They are not satisfactory as radio frequency amplifiers but they will greatly increase the amplification of a resistance coupled audio amplifier and will often prove very satisfactory with choke coupling.

In experimental work the use of tubes having an amplification factor of twenty in place of the usual amplifying tubes increased the voltage amplification of a three-stage resistance coupled amplifier to four times its former value. Using the same high mu tubes in a three-stage choke coil coupled amplifier increased its overall voltage amplification in about the same ratio, four to one. The use of high mu tubes will allow a three-stage resistance coupled or choke coupled amplifier to exceed the voltage amplification of a two-stage transformer coupled amplifier. Otherwise the overall amplification of the two-stage transformer coupled amplifier is greater than the overall amplification of the three-stage resistance or choke amplifier.

TUBE, AMPLIFICATION OF

Power Amplification.—The power output of a tube is measured in watts whereas the voltage output is, of course, measured only in volts. The voltage might be very high but if the current or amperage were extremely small the power output of the tube in watts (volts times amperes) would still be small.

The current change (or alternating current) in the plate circuit will be equal to the amplified voltage divided by the total resistance and impedance in the plate circuit, thus:

$$A. C. \text{ in Plate Circuit} = \frac{\text{Amplification Factor} \times \text{Grid Voltage}}{\text{Plate Resistance} + \text{External Impedance}}$$

The plate voltage is really taken into consideration in this formula because the plate resistance is affected by the plate voltage, being lowered by higher plate voltages.

The voltage acting across the primary of a transformer in the plate circuit depends on the impedance of the primary winding and on the current forced to flow through it. Since the preceding formula gives the current forced to flow in the plate circuit, multiplying the expression for this current by the impedance of the external circuit will give the following for the value of impressed voltage:

$$\frac{\text{Voltage Across}}{\text{External Impedance}} = \frac{\text{External Impedance} \times \text{Amplification Factor} \times \text{Grid Voltage}}{\text{Plate Resistance} + \text{External Impedance}}$$

The power in watts expended in the external circuit is the useful power put forth by the tube. The power in the external circuit is a product of the voltage and the amperage. It is represented by the following formula:

$$\text{Power Output in Watts} = \frac{\text{External Impedance} \times (\text{Amplification Factor} \times \text{Grid Voltage})^2}{2 \times (\text{Plate Resistance} + \text{External Impedance})^2}$$

The grid voltage is the maximum voltage change applied to the grid of the tube. This voltage will be something less than the grid biasing voltage or C-battery voltage as long as there is no distortion caused by making the grid positive at the voltage peaks.

If the number of ohms in the external impedance is just equal to the number of ohms plate resistance in the tube, a somewhat simpler formula will give the value of the power output in watts. Since these two values are seldom balanced in practice, the following formula is not as dependable as the preceding one:

$$\text{Watts Output} = \frac{(\text{Amplification Factor} \times \text{Grid Voltage})^2}{8 \times \text{External Impedance}}$$

In all amplifying tubes except the last one in the audio amplifier the object desired is an amplification or increase of signal voltage.

TUBE, AMPLIFICATION OF

The voltages act upon the grids of following tubes to control the plate currents. But in the last audio amplifying tube, the tube that operates the loud speaker, it is power that is desired since power is required for proper working of the speaker. The formulas for power output are therefore of interest principally in considering the action of the last audio amplifier.

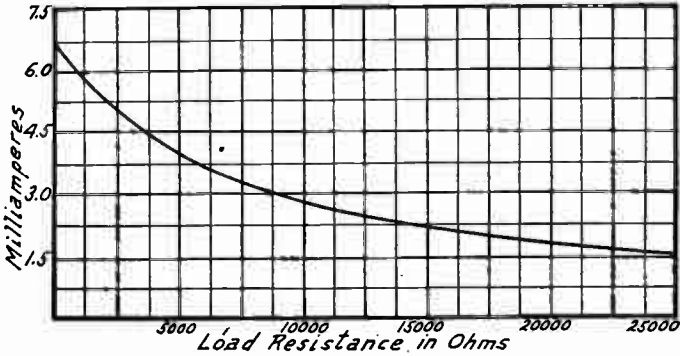

FIG. 4.—Drop of Output Current from Tube with Increase of Load When Maintaining Constant Voltage at Plate Supply Unit.

The effect of the external resistance or impedance on the power output of a tube may be seen in Figs. 4 and 5 which show the change in plate current caused by changes in the external load. Fig. 4 shows the drop of output current caused by increase of load when the voltage of the B-battery or power

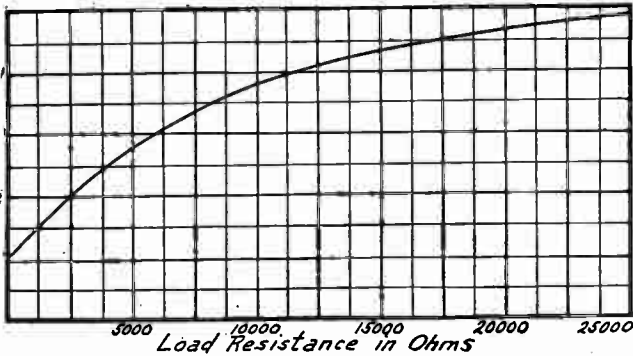

FIG. 5.—Increase of Power from Tube with Increase of Load When Maintaining Constant Voltage at the Plate Itself.

unit remains unchanged. Under this condition the actual voltage applied to the plate of the tube is lowered by the increase of load resistance. In Fig. 5 is shown the effect of maintaining a steady voltage on the plate while the load is increased. This requires a continual increase of B-battery or power unit voltage to make up for the continual increase of voltage drop through the increasing load. With a steady voltage on the plate, as in Fig. 5, the power output actually increases with increasing load. This increase of load resistance while maintaining a constant voltage increases the power output as

TUBE, AMPLIFICATION FACTOR

previously shown in the table of percentages of the total amplification factor obtainable.

TUBE, AMPLIFICATION FACTOR, CONSTANT, or COEFFICIENT.—See *Tube, Amplification of*.

TUBE, AMPLIFYING TYPES OF.—There are four classes of amplifying tube: radio frequency amplifiers, all-purpose voltage amplifiers, power amplifiers and high mu amplifiers.

Radio Frequency Tubes.—For amplifying radio frequencies we are chiefly interested in low internal capacity between the grid and the plate. It is difficult to control the tendency to oscillate that is caused by feedback of energy from plate circuit to grid circuit through this internal capacity and the less of this capacity in a tube the more suitable it is for radio frequency amplification.

A good radio frequency amplifier will usually have a plate of comparatively small size. Its grid will be placed at some distance from the plate and near the filament. The grid will have fewer wires, wires not so closely spaced, as tubes with greater amplification and the grid wire will be of very small gauge size.

Voltage Amplifiers.—Tubes generally used in the past for all kinds of amplifying work include all those of the 201-A type and similar styles. These tubes are generally applied to audio frequency stages having transformer coupling.

A tube used as a voltage amplifier in audio frequency stages between the detector and the last tube should have the largest possible factor of amplification without too great increase of plate resistance. The amplification factor determines the maximum possible voltage amplification of the tube and in the intermediate audio frequency stages it is a gain in voltage that is wanted.

The amplification factor and voltage amplifying ability of a tube are increased by carrying the grid rather close to the plate, by using very small gauge wire for the grid and by making the grid of many turns or rather by having the turns close together.

Power Amplifiers.—Power tubes are used in the last audio stage and deliver power to the loud speaker. These tubes have but moderately high amplification factors, generally between 3 and 8, but have low plate resistances and are designed for operation at high plate voltages.

Power amplifiers are effective only when operated with plate voltages in excess of 135 since the higher voltages are required for the large plate currents which deliver the greater power in watts, thus giving these tubes their real advantage. Correspondingly high negative grid biasing voltages are used in handling the high input voltage from preceding stages. See *Amplification, Voltage and Power*.

There are four principal classes of power tubes in more or less common use. The oldest type is that represented by the "210" tube which has a maximum undistorted power output of about 1700 milliwatts with 425 volts on its plate. The amplification factor is 7.5, much higher than any other power tube.

The tube which has been most popular in the past is the "171" type with a maximum undistorted output of about 700 milliwatts, a plate voltage of 180 and an amplification factor of 3.0. These tubes are generally used in push-pull circuits.

TUBE, AUDIO FREQUENCY TYPES

The newest tube and the most popular at present is the "245" type which has a maximum output of about 1600 milliwatts with a plate voltage of 250 and an amplification factor of 3.5. This tube practically replaces the "171" type.

The largest receiving power tube is the "250" type with a maximum output of about 4600 milliwatts, a plate voltage of 425 and an amplification factor of 3.8. Many receivers have used this tube either singly or in push-pull connection.

High Mu Tubes.—These tubes are especially adapted for resistance coupled and impedance or choke coupled audio stages in which they give greater voltage amplification than other tubes.

High mu tubes have high amplification factors, from 20 to 40, but have also very high plate resistances, these running from 30,000 to 150,000 ohms in average tubes of this class. These tubes should be operated with moderately high plate voltages and with negative grid biasing voltages much smaller than in any other type of tube. They are strictly voltage amplifiers and cannot be used as output tubes. See also *Amplifier, Resistance Coupled* and *Amplifier, Impedance Coupled*.

The greater the amplification factor of a tube the greater will be the capacity between grid and filament or grid and ground. The effective grid-ground capacity is equal to the capacity between grid and filament plus a capacity found from multiplying the grid-plate capacity by one plus the actual voltage amplification. In the "240" type of high mu tube the average grid-filament capacity is 3.5 microfarads, the average plate-grid capacity is 8.5 microfarads and the average plate-filament capacity is 1.5 microfarads. The actual voltage amplification may generally be taken as equal to one-half the amplification factor.

Screen Grid Tubes.—These tubes are of the voltage amplifying type, having amplification factors of two hundred and more. The actual amplification depends on the impedance or resistance in the plate circuit and in radio frequency work will be about fifteen to fifty while in audio frequency amplifiers it will be from thirty to forty under average conditions. See *Tube, Screen Grid Type*.

TUBE, AUDIO FREQUENCY TYPES.—See *Tube, Amplifying Types of*.

TUBE, BALLAST TYPE.—A special current regulating tube used in power supply units which automatically regulates the current to a constant value in some of the circuits.

TUBE, BASES OF.—Sockets for the various tube bases here described are shown and explained under the heading of *Socket, Tube*. The following descriptions deal with the base, which is a part of the tube itself.

Standard dimensions of the regular quarter-ampere tube are shown in Fig. 1. The base is made from moulded insulation with the base prongs set in during the moulding operation. The dimensions given are for the type of tube using two prongs of large diameter and two of smaller diameter, the two large ones being the filament connections and the smaller ones being the grid and plate connections. The height and outside diameter of the glass bulb above the base are variable but the dimensions of Fig. 1 are the average values.

TUBE, BASES OF

The sizes of the prongs on older tubes were different from those shown in Fig. 1. All four prongs in the older tubes were one-eighth inch diameter and all four were only five-sixteenths inch long below the shoulder. The height of the old tube from the bottom of the base to the top of the glass bulb was the same as the height of the present type.

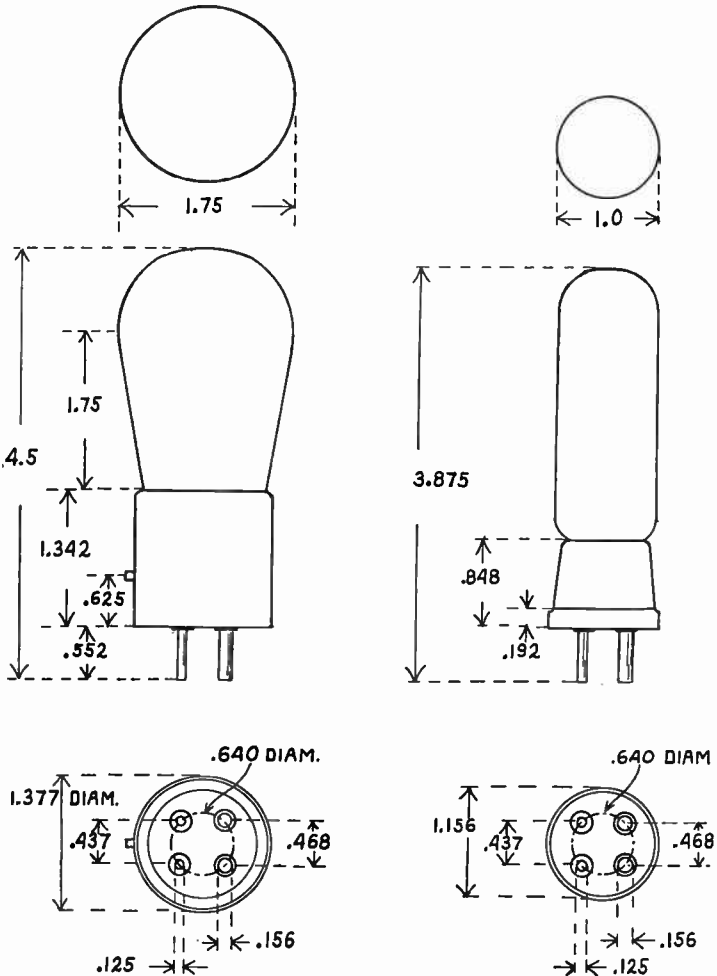

FIG. 1.—Dimensions in Inches of Standard Quarter-Ampere Amplifying Tubes.

FIG. 2.—Dimensions in Inches of Dry Cell Power Amplifying Tube.

In Fig. 2 are shown the dimensions of the dry-cell power tube taking one-eighth ampere filament current. This base has no side guide pin, being de-

TUBE, BATTERY TYPE

signed solely for use with the flat type of socket. The sizes of the prongs are the same as the sizes of the prongs on the quarter-ampere tube of Fig. 1 and they are spaced the same as on the larger tube.

Dimensions for the small three-volt dry cell tube taking 0.06 ampere filament current are shown in Fig. 3. This tube is one inch outside diameter. The base prongs are one-eighth inch diameter and extend one-eighth inch below the shoulder.

TUBE, BATTERY TYPE.—See *Tube, Filament Current Supply for.*

TUBE, BLOCKING OF.—A steady negative charge of such high voltage on the grid of a tube that flow of plate current or changes in plate current are prevented from taking place causes the tube to block or to cease passing signals.

The greater the negative voltage on the grid of a tube, the less will be the current in the plate circuit. In amplifier tubes coupled with transformers the negative charge passes off through the grid return circuit. With resistance coupled amplifiers, choke coupled amplifiers and with detector tubes, the coupling condenser or grid condenser prevents escape of the negative charge and it is necessary to provide grid leaks to allow the grid voltage to return to normal ready for the following signal.

If the grid leak resistance is too great the negative charge will continue to increase until it finally blocks the tube. The same thing will happen even with a leak of usual resistance should the signal voltage be much greater than usual. Blocking is prevented by reducing the signal voltage or by decreasing the amount of resistance in the grid leak. See also *Detector, with Grid Condenser and Leak.*

TUBE, CAPACITIES, INTERNAL.—Any two conductors separated by a dielectric have capacity to each other and form the two plates of a condenser. The grid, plate and filament of a tube are conductors and the vacuum between them is an excellent dielectric. Therefore we have a number of capacities inside of the tube which are called internal capacities. The principal ones are shown in Fig. 1, being indicated by the small condensers connected to the tube elements with broken lines.

There is the grid-plate capacity marked *G-P*, there is the grid-filament capacity marked *G-F* and there is the plate-filament capacity marked *P-F*. In addition to these capacities within the bulb of the tube there are additional capacities between the lead-in wires

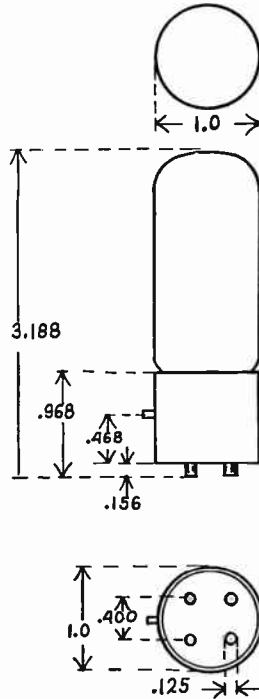

FIG. 3.—Dimensions in Inches of Small Dry Cell Amplifying Tube.

TUBE, CAPACITIES, INTERNAL

and the connections which are indicated at the bottom of the drawing in Fig. 1. For example, the grid-plate capacity is made up not only of the capacity between the grid and the plate but also by the capacity between the grid and plate prongs and the capacity between the wires running from the prongs up into the tube.

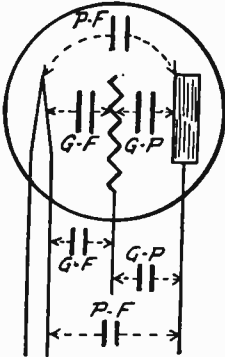

FIG. 1.—Internal Capacities of a Tube.

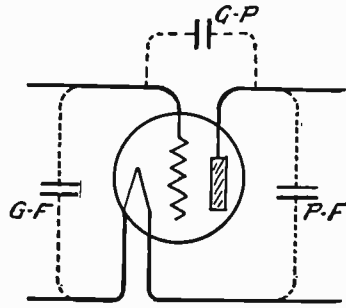

FIG. 2.—Internal Capacities Represented by External Symbols.

All of these capacities serve as paths through which the high frequency currents may pass and form circuits other than those in which they are originally intended to flow. The most troublesome internal capacity or tube capacity is that between the grid and plate members because this allows a direct feedback of energy from the output or plate circuit of the tube to the input or grid circuit. This

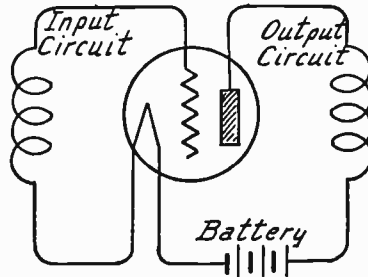

FIG. 3.—Tube Connected to Input and Output Circuits.

feedback gives rise to undesired regenerative effects and to oscillation that is quite difficult to control.

The tube capacities shown in Fig. 1 as small condensers drawn within the tube are often indicated by drawing external condensers as in Fig. 2. Here again are shown the three capacities, grid to plate, grid to filament and plate to filament.

TUBE, CAPACITIES, INTERNAL

Fig. 3 shows the tube connected to an output circuit consisting of a coil and a B-battery and shows the input circuit connected to a coil. The output or plate circuit then consists of the plate, the coil, the B-battery and the line back to the filament. The input or grid circuit consists of the grid, the coil and the line to the filament. Considering the grid as one plate of a condenser and the plate as the other plate, the circuit of Fig. 3 may be represented as in Fig. 4.

Adding the other internal capacities to the circuit of Fig. 4 we would have the circuit of Fig. 5. Now it is seen that the grid to filament capacity is in parallel with the coil or with any other parts in the grid circuit or input

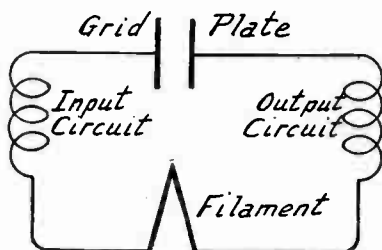

FIG. 4.—Tube Elements Represented as Capacity.

circuit. Also the plate to filament capacity is in parallel with the coil and any other parts in the plate circuit or output circuit. Therefore, the grid to filament capacity $G-F$ is an effective bypass for energy in the grid circuit and the plate to filament capacity $P-F$ is an effective bypass for energy in the plate circuit. The current flow through these bypassing capacities will depend on the frequency and difference of voltage applied, the greater the frequency and the greater the voltage difference the greater being the flow of current.

By actual measurement these internal tube capacities are not very large, but in operation their combined effects have an important

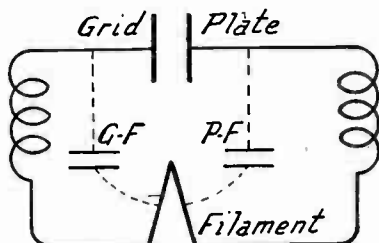

FIG. 5.—Internal Capacities in Parallel with External Circuits.

bearing on the tube's operation. In a typical amplifying tube the grid to filament capacity runs from 5.0 to 7.0 micro-microfarads, the plate to filament capacity runs from 5.0 to 6.5 micro-microfarads and the grid to plate capacity runs between 3.0 and 6.0 micro-microfarads. If the filament is ungrounded the grid to plate capacity is increased to between 7.0 and 11.0 micro-microfarads.

The effective capacity with the tube in use depends on the external resistance in the plate circuit and on the amplification factor,

TUBE, CHARACTERISTICS OF

increasing as both of these values are increased. This is in addition to the actual capacity effect between the tube elements.

The large effective value of the grid to plate capacity may be realized when it is recalled that this capacity is equal to nearly half the minimum capacities of many variable tuning condensers used in the grid circuit of the tube. The grid to filament capacity is a considerable fraction of the minimum capacity of the tuning condenser for a radio frequency stage and the grid to filament capacity is in parallel with the tuning condenser.

TUBE, CHARACTERISTICS OF.—By the characteristics of a tube we mean those qualities or properties which govern its action under various conditions of operation in radio circuits. The characteristics of a tube tell exactly how it will act under any given circumstances.

The following tables show the principal operating characteristics of generally used detectors, amplifiers and power tubes.

The type numbers are those generally assigned, although various makes of tubes may have other numbers. The characteristics of all tubes of a given type are approximately the same.

The filament voltage is the normal voltage for operation as measured across the filament terminals of the tube. The filament amperage is the normal or average current through the filament or heater when the rated voltage is applied.

Grid biases are values of negative voltages acting upon the grid of the tube. They represent the difference in voltage between the grid and the negative end of a D. C. filament or the cathode of a heater tube or the B-minus line with A. C. filament tubes when no signal is being received. The grid bias voltage is equal to the maximum peak voltage of a signal which may be handled without distortion.

The plate voltage is measured between the plate of the tube and the negative end of a D. C. filament, the cathode in a heater tube, or the B-minus line with A. C. filament tubes unless otherwise mentioned. It is less than the power supply B-voltage by the amount of voltage drop through the load in the plate circuit. With the plate current flowing through the primary winding of a transformer or through a choke there is but little D. C. drop and the two voltages are nearly the same. With resistance coupling there is a considerable drop in the plate resistor and a corresponding difference between the voltage at the tube and the power supply.

The plate current is that flowing between the plate and the filament or cathode in the tube when all specified voltages are applied and when the load resistance is approximately equal to the tube's plate resistance.

Measurement of the plate resistance is explained under *Tube, Output Resistance and Impedance of*. All of the characteristics are determined with a load resistance equal at least to the tube plate resistance and not greater than twice the tube plate resistance. Variations in the plate circuit load will affect the apparent characteristics.

The significance of the amplification factor is explained under *Tube, Amplification of*. With most tubes there is a slight change in amplification with change in operating conditions but for ordinary work the factor may be assumed as fixed.

Determination of the mutual conductance is explained under *Tube, Mutual Conductance of*.

The output power in milliwatts is the maximum power delivered when all conditions in the tables are satisfied, when the peak signal voltage applied to the grid is just equal to the biasing voltage, when the load resistance or impedance is equal to the tube's plate resistance, when no current flows in the grid circuit and when there is a minimum of distortion present. See also *Tube, Amplification of*.

TUBE, CHARACTERISTICS OF

AMPLIFIERS AND DETECTORS—D. C. FILAMENT TYPES

Type Number	Used for	Filament		Grid Bias Volts	Plate			Amplific'n Factor	Mutual Cond'e micmho	Power Milli-watts
		Volts	Amps		Volts	Mils	Res'e-ohms			
11,12	Amp	1.1	0.25	1.5	45	1.2	18,000	6.5	340	0.5
	"	—	—	3.0	67	1.8	17,000	—	360	3.0
	"	—	—	4.5	90	2.5	16,000	—	430	7.0
199,299	Det	—	—	0	22	0.7	28,000	—	240	—
	Amp	3.0	0.06	1.5	45	1.0	19,500	6.2	320	0.5
DL-3 231-D	"	—	—	3.0	67	1.7	16,500	—	380	3.0
	"	—	—	4.5	90	2.4	15,000	—	415	7.0
	Det	—	—	0	22	0.5	30,000	—	210	—
201-A 301-A -01-A	"	—	—	0	45	1.3	17,000	—	365	—
	Amp	5.0	0.25	1.5	45	0.9	18,500	8.0	430	1.0
	"	—	—	3.0	67	1.4	14,000	—	570	5.0
201-A 301-A -01-A	"	—	—	4.5	90	1.9	11,500	—	720	14.0
	"	—	—	6.0	112	2.7	10,000	—	800	28.0
	"	—	—	9.0	135	2.5	10,500	—	760	55.0
	"	—	—	13.5	180	3.0	10,800	—	740	135.0
	Det	—	—	0	45	1.6	15,000	—	530	—
240,340	Amp	5.0	0.25	1.5	90	0.23	135,000	30.0	220	2.0
	"	—	—	3.0	135	0.20	139,000	—	215	7.0
	"	—	—	4.5	180	0.20	142,000	—	210	16.0
	Det	—	—	0	90	0.70	72,500	—	400	—
200-A, 300-A, 230,330	"	—	—	6.0	220	0.18	145,000	—	205	28.0
	Det	—	—	0	90	0.70	72,500	—	400	—
	Det	5.0	0.25	0.5	45	1.2	30,000	20.0	670	—
	Amp	2.0	0.06	3.0	67	1.3	15,000	8.7	580	5.3
	"	—	—	4.5	90	2.0	12,500	8.8	700	13.3
200-A, 300-A, 230,330	"	—	—	6.0	112	2.7	11,000	8.8	780	25.5
	Det	—	—	0.0	45	1.6	13,500	8.8	640	—

Type Number	Filament		Grid Bias Volts	Plate Volts	Screen Volts	Plate-Screen mils	Plate Resist'e ohms	Amplific'n Factor	Mutual Cond'e micmho
	Volts	Amps							
232,332	2.0	0.06	3.0	90	45.0	0.40	2,500,000	680	275
	—	—	3.0	105	52.5	0.75	1,700,000	650	400
	—	—	3.0	120	60.0	1.25	1,300,000	575	500
	—	—	3.0	135	67.5	2.10	800,000	440	550
	—	—	3.0	150	75.0	2.90	550,000	320	590
222,322	3.3	0.13	0.0	90	45.0	1.85	400,000	160	390
	—	—	1.5	90	45.0	1.40	500,000	175	340
	—	—	1.5	135	45.0	1.5	800,000	290	355
	—	—	3.0	135	45.0	0.95	1,000,000	300	285
	—	—	4.5	135	45.0	0.60	1,350,000	315	220

TUBE, CHARACTERISTICS OF

POWER TUBES—D. C. AND A. C. FILAMENT TYPES

Type Number	Filament		Grid Bias Volts	Plate			Ampli- fic'n Factor	Mutual Cond'e micmho	Power Milli- watts
	Volts	Amps		Volts	Mils	Res'e- ohms			
120,220	3.3	0.132	16.5	90	3.2	7,700	3.3	428	—
	—	—	22.5	135	6.7	6,600	—	500	105
	—	—	35.0	180	8.0	6,200	—	530	265
112A, 312A DL-7	5.0	0.25	4.5	90	5.2	5,300	8.0	1500	29
	—	—	9.0	135	7.2	5,000	—	1600	137
	—	—	10.5	157	9.3	4,700	—	1700	180
	—	—	13.5	180	9.0	4,700	—	1700	308
	—	—	0	45	3.5	7,000	—	1150	—
171A, 371A DL-14	5.0	0.25	16.5	90	11.0	2,500	3.0	1200	105
	—	—	22.5	112	12.5	2,350	—	1275	240
	—	—	27.0	135	16.0	2,200	—	1360	320
	—	—	33.0	157	18.0	2,150	—	1400	570
	—	—	40.5	180	20.0	2,000	—	1500	710
210, 310 DL-9	7.5	1.25	9.0	135	5.0	8,000	7.5	940	64
	—	—	12.0	180	7.0	7,000	—	1100	145
	—	—	18.0	250	11.5	5,600	—	1330	340
	—	—	22.5	300	13.0	5,400	—	1460	660
	—	—	27.0	350	16.0	5,100	—	1500	1000
	—	—	35.0	400	16.0	5,000	—	1550	1700
	—	—	35.0	425	18.5	5,000	—	1550	1700
145,245,345	2.5	1.5	15.0	90	14.0	2,000	3.5	1550	160
	—	—	21.0	120	19.0	1,985	—	1700	300
	—	—	27.0	150	23.0	1,965	—	1770	480
	—	—	34.0	180	26.0	1,950	—	1800	750
	—	—	41.0	210	29.0	1,920	—	1825	1060
	—	—	51.0	250	32.0	1,900	—	1850	1600
	—	—	61.0	290	34.0	1,900	—	1850	2250
	—	—	—	—	—	—	—	—	—
250, 350	7.5	1.25	45.0	250	28.0	2,100	3.8	1800	900
	—	—	54.0	300	35.0	2,000	—	1900	1500
	—	—	63.0	350	45.0	1,900	—	2000	2350
	—	—	70.5	400	55.0	1,800	—	2100	3250
	—	—	85.0	450	55.0	1,800	—	2100	4650
205-D	4.5	1.6	20.0	350	35.0	3,500	7.0	2000	700
205B, VT2	7.0	1.35	20.0	350	35.0	3,500	7.0	2000	700
202	7.5	2.35	—	350	50.0	—	—	—	—
231, 331	2.0	0.13	13.5	90	5.3	4,750	3.5	800	55
	—	—	16.5	105	6.5	4,500	3.6	850	90
	—	—	19.5	120	7.2	4,200	3.6	860	132
	—	—	22.5	135	8.0	4,000	3.6	875	185
	—	—	25.5	150	9.3	3,600	3.6	890	250

TUBE, CHARACTERISTICS OF

AMPLIFIERS AND DETECTORS—A. C. TYPES

Type Number	Used for	Filament or Heater		Grid Bias Volts	Plate			Amplific'n Factor	Mutual Cond'e micmho	Power Milli-watts
		Volts	Amps		Volts	Mils	Res'e-ohms			
226, 326	Amp	1.5	1.05	3.0	45	1.8	11,110	8.2	740	7
	"	—	—	4.5	67	2.8	9,450	—	860	18
	"	—	—	6.0	90	3.7	8,800	—	935	34
	"	—	—	7.5	90	2.4	11,110	—	740	42
	"	—	—	9.0	105	2.7	10,900	—	750	64
	"	—	—	10.5	120	3.0	9,830	—	835	94
	"	—	—	12.0	135	3.2	9,500	—	865	127
	"	—	—	13.5	150	3.6	9,350	—	875	161
	"	—	—	15.0	165	4.0	8,700	—	940	216
	"	—	—	16.5	180	4.4	8,550	—	955	262
227, 327	Det	2.5	1.75	0	22	1.8	10,000	8.2	820	—
	"	—	—	0	45	4.5	7,150	—	1140	—
	Amp	—	—	1.5	60	4.6	7,700	—	1065	3
	"	—	—	3.0	75	4.8	7,700	—	1065	10
	"	—	—	4.5	90	5.1	7,700	—	1065	22
	"	—	—	6.0	105	5.4	7,700	—	1065	39
	"	—	—	7.5	120	5.8	7,700	—	1065	61
	"	—	—	9.0	135	6.2	7,700	—	1065	88
	"	—	—	10.5	150	6.6	7,500	—	1090	123
	"	—	—	12.0	165	7.0	7,250	—	1130	165
	"	—	—	13.5	180	7.4	7,150	—	1145	211
	"	—	—	3.0	60	3.1	9,100	—	900	—
	"	—	—	6.0	90	3.6	9,100	—	900	—
	"	—	—	9.0	120	4.4	9,100	—	900	—
"	—	—	12.0	150	5.2	8,700	—	940	—	
"	—	—	15.0	180	6.0	8,000	—	1025	—	
401	Det	3.0	1.0	0	22	0.8	18,800	8.0	425	—
	Amp	—	—	1.5	45	3.2	9,400	—	850	2
	"	—	—	3.0	67	4.3	9,000	—	885	8
	"	—	—	4.5	90	5.4	9,000	—	885	18
	"	—	—	6.0	105	5.8	9,000	—	885	32
	"	—	—	7.5	122	6.2	9,000	—	885	50
	"	—	—	9.0	135	6.6	9,000	—	885	72
	"	—	—	10.5	150	7.1	9,000	—	885	98
	"	—	—	12.0	165	7.6	9,000	—	885	128
	"	—	—	13.5	180	8.1	8,900	—	900	164
"	—	—	15.0	200	9.2	8,700	—	920	207	
124, 224, 324 (Sc Grid)	Amp	2.5	1.75	1.5	180	3.9	400,000	420	1050	—
	"	—	—	*1.5	180	1.4	850,000	620	750	—
	"	—	—	*1.5	135	1.4	—	—	—	—
	"	—	—	2.0	180	3.6	460,000	440	1000	—
	"	—	—	*2.0	135	1.2	—	—	—	—
	"	—	—	3.0	180	2.7	600,000	500	900	—
	"	—	—	*3.0	135	0.6	—	—	—	—
	"	—	—	4.5	180	1.5	800,000	610	760	—
	"	—	—	*4.5	135	0.2	—	—	—	—
	"	—	—	6.0	180	0.8	1,350,000	780	570	—

* Indicates 45 volts on screen grid—all others 75 volts on screen.

TUBE, CHARACTERISTICS OF

All of the data in the foregoing tables may be reduced to the form of graphs in which would be shown the effect of gradual change of any one factor on the various characteristics. In the tables the values of grid bias and plate voltage are those generally adopted in practice for various commercial receivers.

Most of the characteristics given in the tables are those applying when the tubes are used as amplifiers. The conditions of operation when a tube is used as a detector may vary widely from those outlined. Grid rectification detectors with grid leak and condenser generally operate with a very small grid bias or with a zero bias. Plate rectification detectors of the power type often use grid biases much higher for given plate voltages than when worked as amplifiers.

In working a tube it is possible to vary a number of things; among them being the voltage applied to the filament, the biasing voltage applied to the grid, and the voltage applied to the plate.

By changing any one of these three things we are able to make corresponding changes in the plate current, in the plate resistance, in the amplification factor and in the mutual conductance of the tube.

The relation between the value that is changed and the thing changed is called a characteristic of the tube. For instance, the effect of plate voltage changes in changing the effective plate resistance is called the plate-voltage, plate-resistance characteristic, the effect of changes in grid voltage on the current in the plate circuit is called the grid-voltage, plate-current characteristic and so on. A study of these characteristics will show the behavior of a tube when used under conditions existing in radio frequency or audio frequency amplification or as a detector.

The characteristics of tubes are shown by curves in which the position of points along the curve indicates how much effect any one factor has on the tube's operation. The making of curves and their meaning is explained under *Graph*.

In dealing with tube characteristics we must continually use such terms as grid voltage, plate current, plate resistance, etc. These terms are often abbreviated as follows:

Voltage	E	Grid Current	I_g
B-battery voltage	E_b	Plate Current	I_p
C-battery voltage	E_c	Resistance	R
Filament voltage	E_f	Grid circuit resistance	R_g
Grid bias voltage	E_g	Internal plate resistance	R_p
Plate voltage	E_p	Impedance	Z
Current	I	Plate impedance	Z_p
Filament Current	I_f		

The following list shows the principal tube characteristics which are shown in typical forms under the various headings in this section:

TUBE, CHARACTERISTICS OF

VACUUM TUBE CHARACTERISTICS

<i>Value in Which Change Is Made</i>	<i>Value Which Is Changed</i>	<i>Name of Characteristic or Curve</i>
Filament Voltage	Filament Current	<i>E_f-I_f</i>
Filament Voltage	Filament Emission and Plate Current	<i>E_f-I_p</i>
Grid Voltage	Plate Current	<i>E_g-I_p</i>
Grid Voltage	Input Resistance	<i>E_g-R_g</i>
Grid Voltage	Plate Resistance	<i>E_g-R_p</i>
Grid Voltage	Grid Current	<i>E_g-I_g</i>
Plate Voltage	Free Grid Voltage	<i>E_p-E_g</i>
Plate Voltage	Plate Current	<i>E_p-I_p</i>
Plate Voltage	Plate Resistance	<i>E_p-R_p</i>
Plate Voltage	Amplification Factor	—
Plate Voltage	Mutual Conductance	—

Filament-Voltage, Filament-Current.—The greater the voltage applied to the filament of a tube the greater will be the flow of current through the filament. This effect is shown in Fig. 1 for two different tubes. The curve at the left is for a quarter-ampere am-

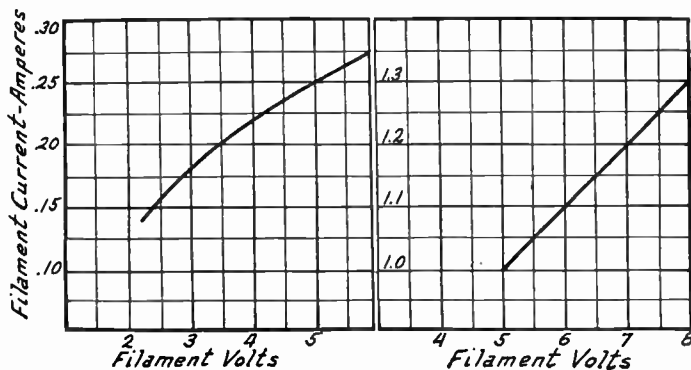

FIG. 1.—Effect of Filament Voltage on Filament Current.

plifying tube using a normal five volts on its filament. The curve at the right is for a power tube normally taking 1.1 ampere as filament current with six volts across the filament terminals.

The amount of current flowing through the tube's filament determines the degree of filament heating and the emission of electrons which form the plate current. These curves show the decided effect of the filament voltage on the heating current.

Filament Voltage Effect on Emission and Plate Current.—The total electron emission from a filament is greater than the electron flow from filament to plate because many of the electrons

TUBE, CHARACTERISTICS OF

emitted by the filament are drawn back or forced back into the filament again, never forming a part of the plate current.

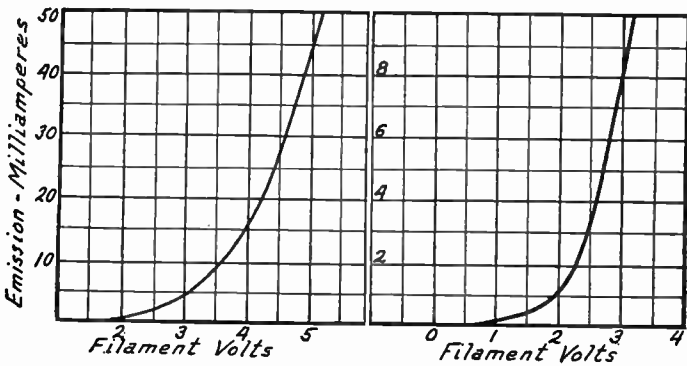

FIG. 2.—Effect of Filament Voltage on Electron Emission from Filament.

Since the electron emission from the filament would form a current if attracted to the plate, this emission may be measured in the same units used for current measurement, in this case milliamperes.

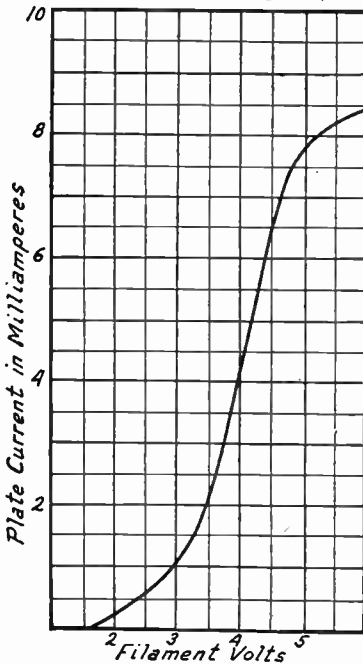

FIG. 3.—Limiting Emission.

The curves in Fig. 2 show the emission measured in milliamperes from the filament of a quarter-ampere five-volt tube at the left and from the filament of a small three-volt dry cell tube at the right.

These curves in Fig. 2 show the total emission which is limited only by the space charge effect, by the degree of heating in the filament and by the kind of material used for filament wire. These curves do not take into account the limiting effect of plate voltages or of grid voltages.

If the filament voltage is increased beyond the normal operating point as shown in Fig. 3 a point will be reached at which there is no further increase of plate current in spite of the increasing emission. The sharp bend toward the right near the top of the curve in Fig. 3 shows this effect. This prevention of plate current increase may be caused by the action of the negative space charge which just equals and balances the effect of positive plate voltage.

If the plate voltage is gradually increased there will be a corresponding increase of plate current. If, at the same time, the filament voltage is kept

TUBE, CHARACTERISTICS OF

down so that the emission is limited it is possible to get the effect shown in Fig. 4. Here the filament temperature is assumed to be limited to a point that allows a total emission of about nine milliamperes. As the plate voltage is increased from 70 toward 120 in Fig. 4, the plate current increases until it reaches a point just below nine milliamperes. Further increases of plate voltage then have very slight effect in causing further increases of plate current. This current limit, which is determined by the emission from the filament, is called the saturation current for the tube. It is reached when all of the electrons emitted by the filament are being drawn over to the plate against the negative space charge.

Grid-Voltage, Plate-Current Curves.—Of all the characteristics the one showing the relation between changes of grid voltage and corresponding plate current is the most generally used. Typical

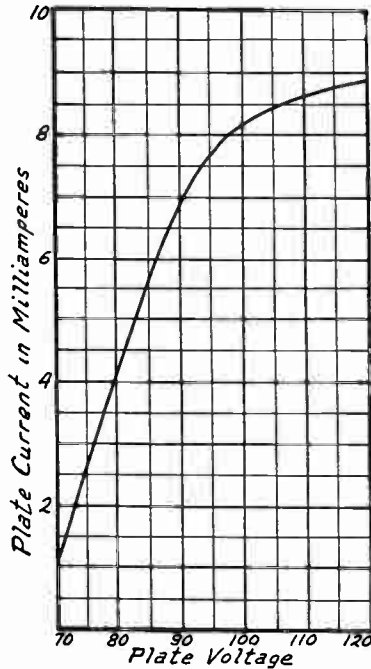

FIG. 4.—Limiting Plate Current by Lack of Emission.

curves for this relation are shown in Fig. 5. The highest curve is made with a plate voltage of 200, the middle curve with a plate voltage of 150 and the lower one with 100 volts on the plate. The general form of all three curves is the same, but the greater the plate voltage the higher the curve is pushed and the more plate current flows for any given grid voltage.

The vertical center line represents zero grid voltage with positive voltages at the right and negative voltages to the left of this zero center. Curves such as these are made by applying a fixed voltage

TUBE, CHARACTERISTICS OF

to the plate circuit, then changing the grid voltage or grid biasing voltage while noting the resulting plate current for each grid voltage. The points thus secured are plotted on the graph and a smooth curve drawn through them. The curves of Fig. 5 are thus made without the tube actually working in a radio circuit and they are called static characteristics.

Under actual operating conditions there is always an impedance or a resistance in the plate circuit and in place of the steady voltage applied to the grid there is a changing or alternating voltage representing the signal.

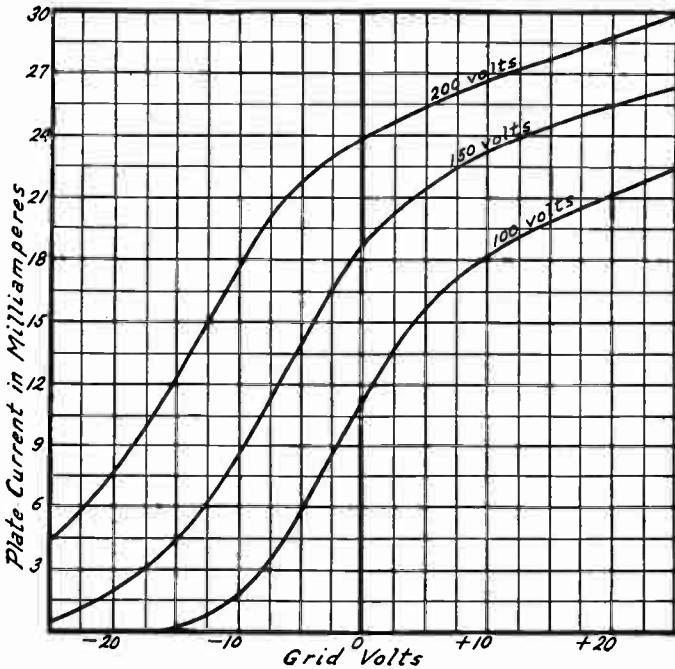

FIG. 5.—Effect of Grid Voltage on Plate Current.

Whenever a load of any kind is placed in the plate circuit or output circuit of the tube the plate current is reduced which will, of course, change the slope of the static curves in Fig. 5. As the load in the plate circuit is increased the curve will drop lower and lower and will at the same time become much straighter than the static curve. By the time the external resistance or impedance is equal to the plate resistance of the tube the curve becomes almost straight. This effect is shown in Fig. 6.

Fig. 6 shows one of the static characteristics taken from Fig. 5 and shows how this curve is altered when the tube works into a load. When the average negative grid voltage is 7.5 the new curve, called a dynamic characteristic, will

TUBE, CHARACTERISTICS OF

cross the static curve at the line corresponding to 7.5 volts negative on the grid. Were the average negative grid voltage 15.0 the two curves would cross at the point representing 15.0 volts negative grid bias.

An examination of the dynamic characteristic curves of Fig. 6 will show they have much longer straight portions than the static curves of Fig. 5. Increase of external load thus tends to straighten the operating curve and to allow better reproduction with less distortion than would be assumed by looking only at the static characteristics of a tube.

The static curve in Fig. 6 is the one marked "150 volts" in Fig. 5, this being the curve developed when 150 volts are applied to the plate circuit. Looking again at Fig. 5 it will be seen that the straight portion of this 150-volt curve extends only from the zero line over to about 12 volts negative on the grid. The total range of grid voltage variation without distortion would be only twelve volts according to the static curve. This would allow for only six volts positive and six volts negative, thus limiting the signal strength to six volts were distortion to be avoided. That such a limit is not actually imposed may be seen from an examination of the dynamic curves in Fig. 6.

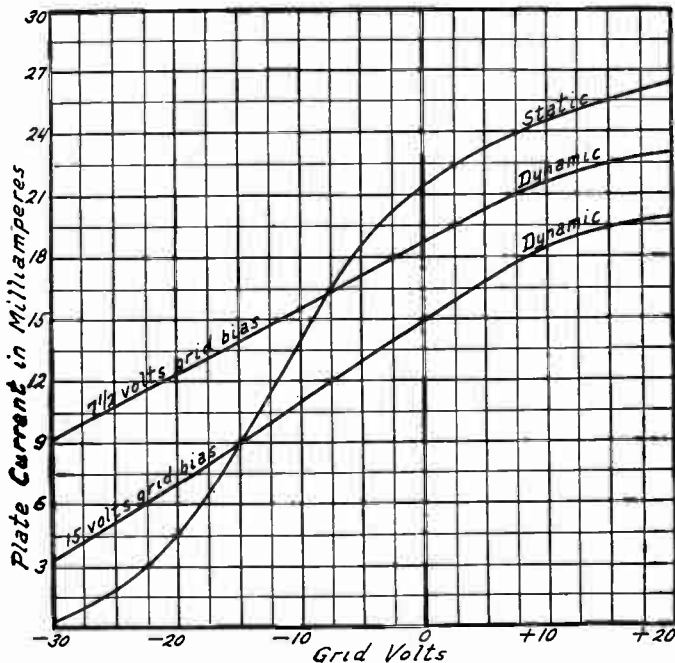

FIG. 6.—Grid-Voltage, Plate Current Curves Compared for Static and for Dynamic or Working Conditions.

Either of the dynamic curves in Fig. 6 shows the straight portion as extending from the zero grid voltage line to the extreme left hand side of the graph. The total swing of grid voltage might here be as great as thirty volts, allowing fifteen volts positive rise and fifteen volts negative drop. Under dynamic or working conditions it is then possible to handle a signal of more than twice the voltage allowed from the appearance of the static curve with little change in average plate current.

TUBE, CHARACTERISTICS OF

Grid Voltage Effect on Plate Resistance.—Since the flow of current in the plate circuit is affected by changes in the grid voltage, the grid voltage has an apparent effect on the plate circuit resistance. This effect is shown in Fig. 7.

With a strong negative grid voltage the apparent plate resistance is high. As the grid becomes less negative there is a gradual decrease of apparent plate resistance. Increasing the voltage applied to the grid thus shows the same effect in the curve as would an increase of grid voltage applied directly to the plate of the tube.

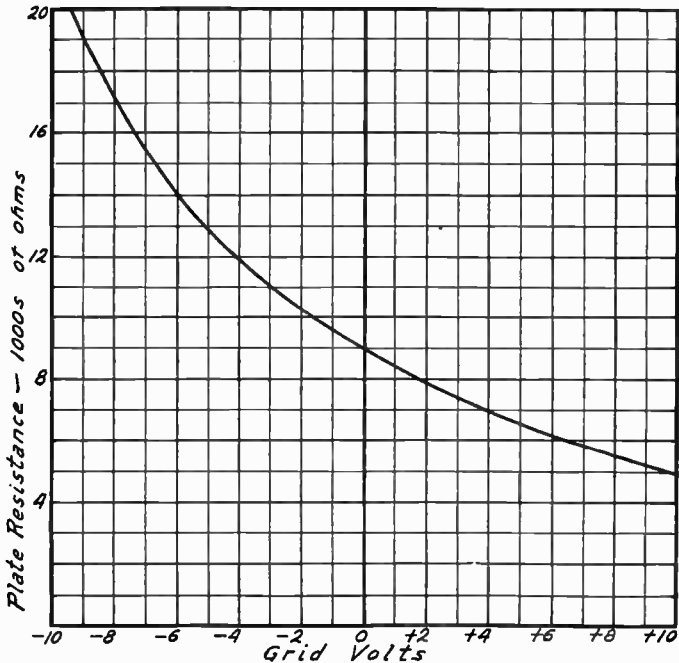

FIG. 7.—Relation Between Grid Voltage and Plate Resistance.

Free Grid Voltage.—If the grid of a tube is insulated from its circuit with a blocking condenser or grid condenser while the plate and filament connections remain as usual and if no grid leak is employed, the grid voltage will not be zero but will usually be somewhat less than zero. This is called the free grid voltage. This free grid voltage is affected to a considerable extent by the voltage applied to the plate as shown by the curve in Fig. 8.

The free grid voltages shown in Fig. 8 are averages for a number of tubes. There is often a considerable variation of this voltage even in tubes supposedly alike. With rather high plate voltages the free grid voltage may become slightly positive but as a general rule it is about as shown by the curve.

TUBE, CHARACTERISTICS OF

A tube operated with a free grid will give very uncertain results because changes of plate current will react on the grid and because blocking will take place due to the trapping of excess negative charges on the grid.

Grid Voltage Effect on Input Resistance.—The more strongly negative is the voltage applied to the grid of a tube the greater will be the resistance to flow of current through the grid circuit. It is generally assumed that with a negative grid voltage there will be no flow of grid current whatever, that there is an infinite resistance in the grid circuit.

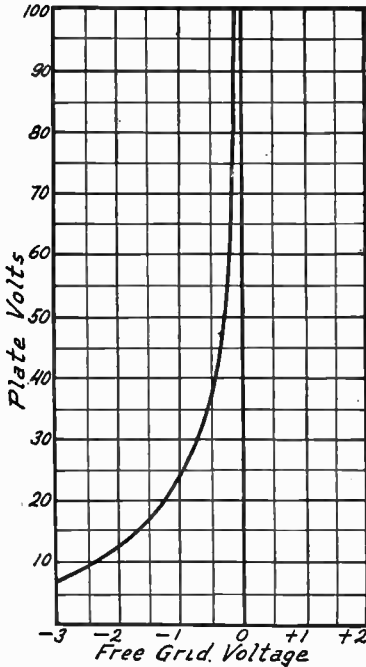

FIG. 8.—Effect of Plate Voltage on Free Grid Voltage.

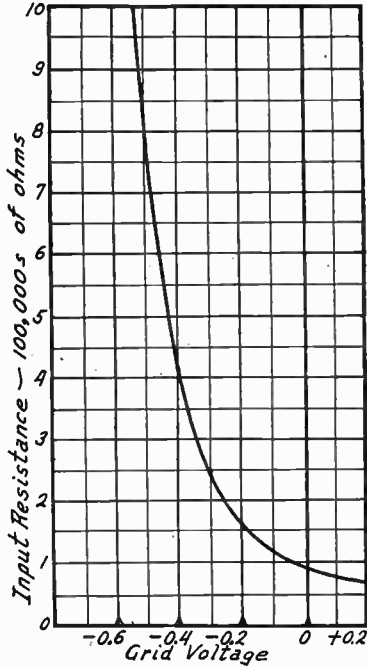

FIG. 9.—Effect of Grid Voltage on Resistance of Input Circuit.

The resistance of the input circuit of a typical tube is represented by the curve in Fig. 9. With the grid at positive voltage there is comparatively little resistance in the grid circuit to flow of current through it. But as soon as the grid voltage drops to zero and becomes slightly negative there is a very rapid increase of input resistance. As shown by Fig. 9 this input resistance increases from about 90,000 ohms at zero grid voltage to about 800,000 ohms with the grid only one-half volt negative.

Grid Voltage Effect on Grid Current.—With tubes usually employed as amplifiers there is so little flow of current in the grid circuit when the grid voltage is kept negative that it is impossible to detect any grid current with ordinary measuring devices. But as soon as the grid voltage becomes positive there is a very appreciable

TUBE, CHARACTERISTICS OF

flow of current in the grid circuit. The effect of grid voltage on grid current is shown in Fig. 10.

Fig. 10 gives the grid voltage-grid current characteristics for three amplifier tubes, all of the five-volt, quarter-ampere filament type. With all of them the flow of grid current increases quite rapidly with increase of positive grid voltage. In some tubes the grid current may be much greater than the one milliampere maximum shown in Fig. 10.

A drop in grid current may occur when using very high plate voltages. This is brought about by an emission of electrons from the grid itself which increases the negative space charge around the grid and opposes the flow of electrons from the filament to the grid, this being the flow which forms the grid current.

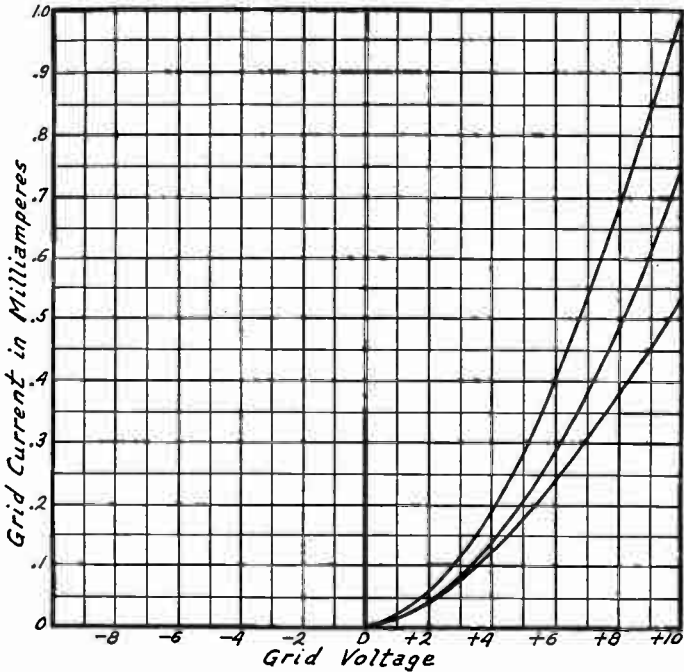

FIG. 10.—Grid Voltage Effect on Grid Current.

Plate Voltage Effect on Plate Current.—If the grid voltage remains steady and if the filament heating is unchanged the flow of current in the plate circuit of a tube is determined by the voltage applied to the plate. The plate current increases with increase of plate voltage until the increase is finally halted by reaching the saturation current for that particular filament temperature or until the point is reached at which the combined effects of the space charge and the grid voltage prevent further rise of plate current.

The relation between plate voltage and plate current in a typical amplifying tube is shown in Fig. 11. All curves of this character-

TUBE, CHARACTERISTICS OF

istic have the general contour of the one in Fig. 11. The actual position of such a curve depends on the average grid voltage or steady grid voltage being applied to the tube. In Fig. 12 are shown three plate-voltage, plate-current curves for different grid voltages. The more negative the grid the lower will be the plate-voltage, plate-current curve.

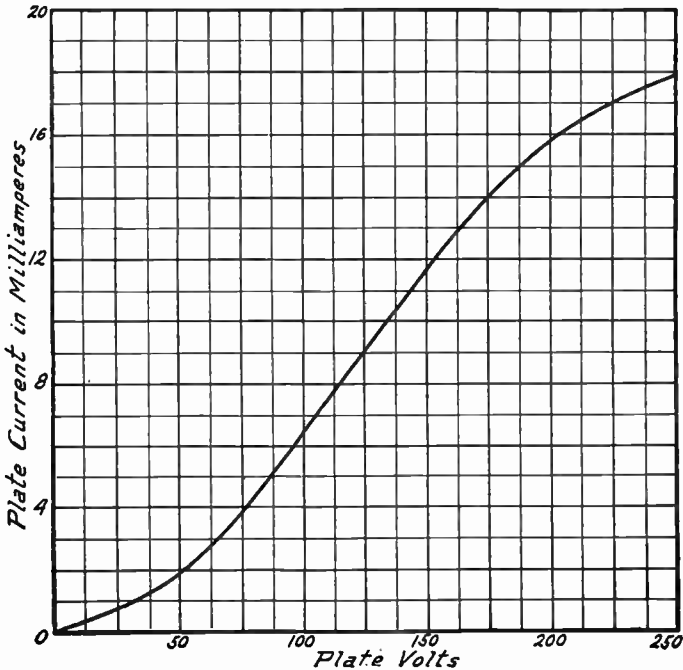

FIG. 11.—Effect of Plate Voltage on Plate Current.

Comparison of the curve in Fig. 11 with the one in Fig. 5 will show the marked similarity between the two. The three curves of Fig. 5 show that an increase of plate voltage from 100 volts up to 150 volts and then to 200 volts will give corresponding increases of plate current in milliampères. On the zero voltage line in the curve of Fig. 5 the successive currents are seen to be 11.2, 18.6 and 23.9 milliampères, the increase from 100 volts to 150 volts being greater than the increase from 150 volts to 200 volts. Then taking the curve in Fig. 11 the plate currents for 100, 150 and 200 volts are seen to be respectively 6.5, 11.7 and 15.8. Here again the increase of current brought about by a change from 100 volts to 150 volts is greater than the increase brought about by changing from 150 to 200 volts. Curves from similar tubes will always show such corresponding features.

TUBE, CHARACTERISTICS OF

From a characteristic curve such as shown in Fig. 12 it is possible to determine the steady or average plate current that will flow for any given plate voltage and grid voltage. Fluctuations from this average value will then be caused by changes in grid voltage as signals are received.

By using these plate-voltage, plate-current curves together with the grid-voltage, plate-current curves such as shown in Figs. 5 and 6 it is possible to predict the performance of a tube as an amplifier. The two classes of curves just mentioned are the most generally useful of the tube characteristics.

Plate Voltage Effect on Plate Resistance.—Increasing the voltage applied to the plate of a tube will lower the tube's internal resistance or its plate resistance because the greater positive charge

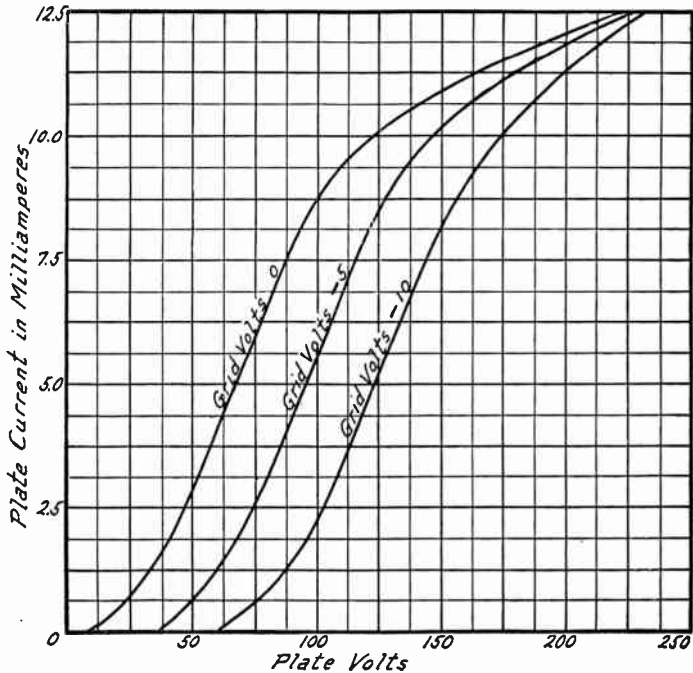

FIG. 12.—Plate-Voltage, Plate-Current Curves for Various Grid Voltages.

on the plate is able to overcome the space charge effect better than a smaller positive charge. The effect of plate voltage on plate resistance is shown in Fig. 13.

This reduction of plate resistance with increase of plate voltage may be seen from the table of tube operating characteristics given under *Tube, Amplifying Types of*. In that table the full effects of plate voltage changes are not shown because for each increase of plate voltage the grid voltage is made more negative. In the curves of Fig. 13 the grid voltage and all other values except the plate voltage remain unchanged. From these curves it may be seen that the plate resistance with only twenty to twenty-five volts on the plates

TUBE, CHARACTERISTICS OF

of detector tubes is very high compared with the resistance in amplifiers. In Fig. 13 the two curves are from tubes of the same type and kind and they show the variations that may be found.

All curves showing the relation between plate voltage and plate resistance have the same general form. Fig. 14 shows such a curve for a power tube in which the resistance is much lower than in the voltage amplifier tubes of Fig. 13. Still, the general outlines of the curves for both types of tubes remain the same.

The plate-voltage, plate-resistance curve of Fig. 15 is that for a power tube with which the grid biasing voltage is changed to the proper value for each

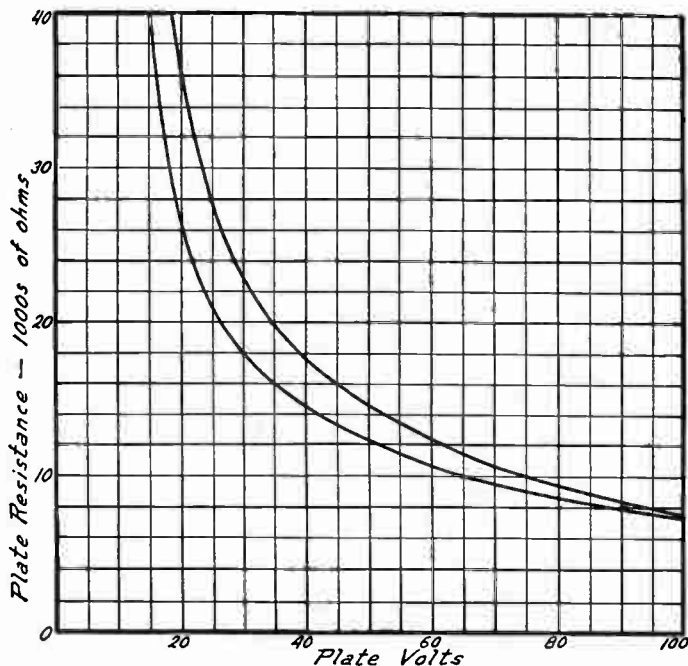

FIG. 13.—Effect of Plate Voltage on Plate Resistance in Amplifier Tubes.

applied plate voltage. Even here the typical bend of all such curves remains almost unchanged.

Amplification Factor.—There is a change of amplification factor in any tube with change of plate voltage. The curves showing the relation between these two values for two different tubes are shown in Fig. 16. The lower curve is for one of the smaller semi-power tubes and the upper one is for a quarter-ampere, five-volt voltage amplifier. These curves do not always follow the gradual and uniform changes found with other characteristics but may rise through one part of the voltage increase, then remain uniform and finally rise again or fall slightly toward the higher voltage limits.

TUBE, CHARACTERISTICS OF

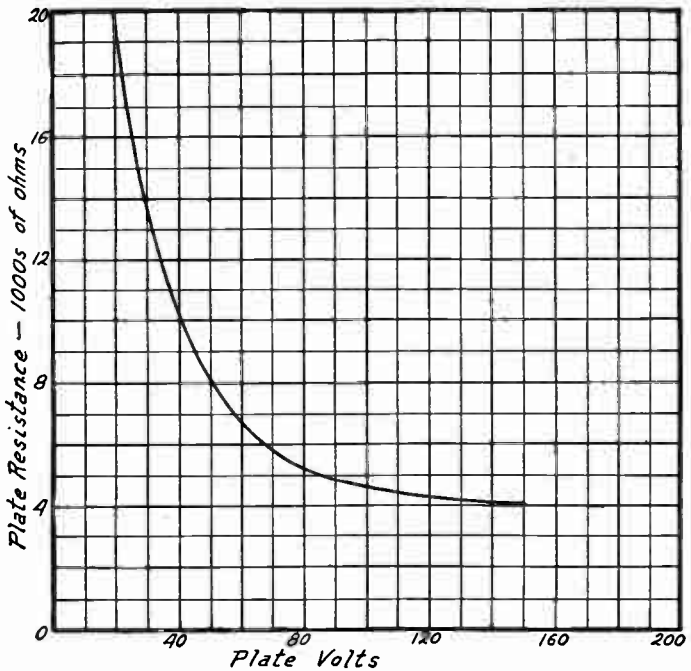

FIG. 14.—Plate Voltage Effect on Plate Resistance in a Power Tube.

Mutual Conductance.—Since the plate voltage affects both the plate resistance and the amplification factor it must affect the mutual conductance of the tube inasmuch as the mutual conductance is a combination of the other two factors.

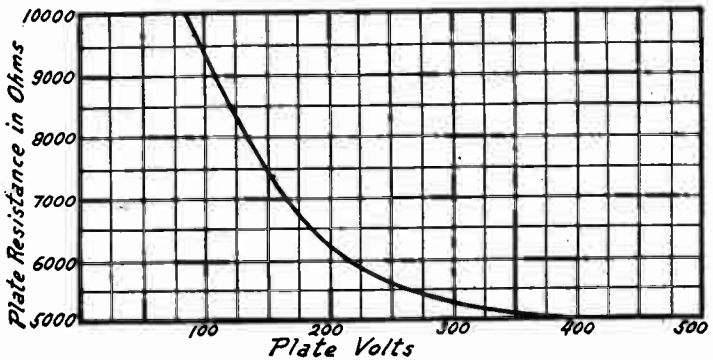

FIG. 15.—Plate-Voltage, Plate-Resistance Curve with Changing Grid Bias.

TUBE, CHARACTERISTICS OF

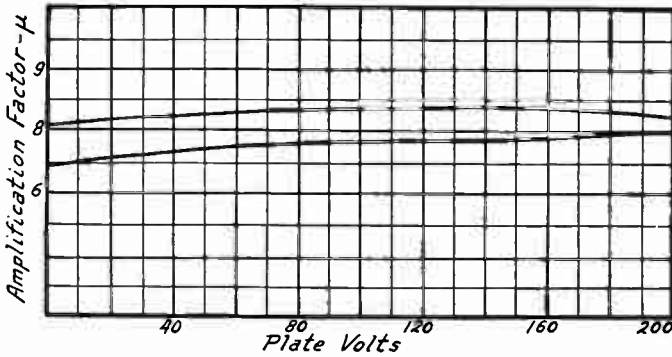

FIG. 16.—Effect of Plate Voltage on Amplification Factor.

The change in mutual conductance with changing plate voltage is shown by the curve of Fig. 17. This curve represents the mutual conductance for the tube whose plate resistance is shown in Fig. 14 and whose amplification factor is shown by the lower curve in Fig. 16. The mutual conductance for any tube rises rapidly at first with increases of plate voltage, then less rapidly until at the highest allowable voltages there is only a slight increase of mutual conductance.

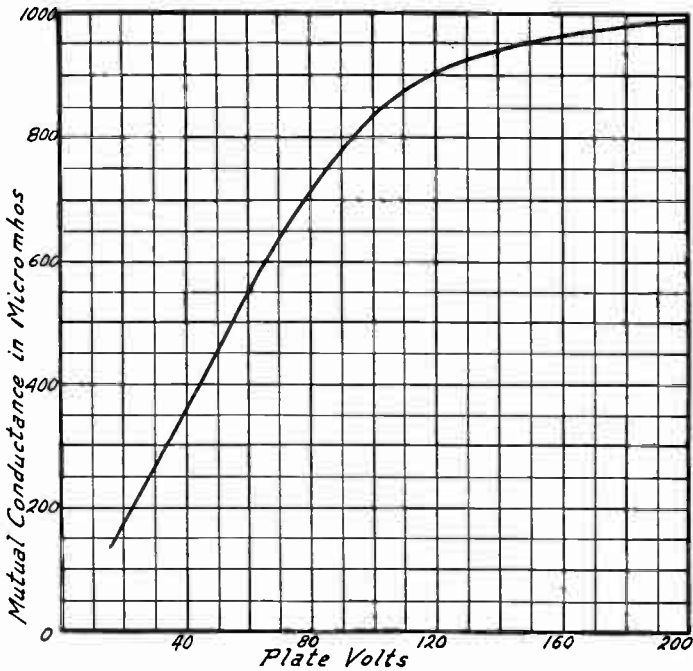

FIG. 17.—Effect of Plate Voltage on Mutual Conductance.

TUBE, CONSTRUCTION OF

TUBE, CONSTRUCTION OF.—See *Tube, Design of*; and *Tube, Manufacture of*.

TUBE, COUPLING FOR ANTENNA.—See *Receiver, Single Control*.

TUBE, DESIGN OF.—The design elements considered here are those affecting the amplification factor, the plate resistance and the grid-plate capacity of the tube since these are the things chiefly controlling the tube's action in amplifiers. As a general rule we desire to increase the amplification factor, to reduce the plate resistance and to reduce the grid-plate capacity. As is so often the case, in obtaining one of these desirable things we lose another.

In an attempt to make a tube which is altogether good as an amplifier, various changes may be made in the grid, in the plate and in the filament construction.

Using a larger filament, one having greater surface area, has the desirable effect of lessening the plate resistance because of the increased emission from the larger filament surface.

A large plate will likewise reduce the plate resistance but at the same time it increases the grid-plate capacity and allows greater feedback through the tube, especially in radio frequency amplifiers. Generally speaking, the larger the plate the greater will be its distance from the central filament because the radius of the plate from the filament as a center must increase with increase of plate size. If the plate size is increased by making the plate longer rather than by increasing its radius or diameter the results will be better because then the plate is kept close to the filament, reducing the plate resistance, and at the same time the plate area is increased, again reducing the plate resistance. If the desired reduction of plate resistance can be secured with a plate of only moderate size placed close to the filament an advantage will be gained in reduction of grid-plate capacity.

The spacing of the grid wire, the number of wires per inch, and the diameter or gauge size of the grid wire are all of importance in their effect on the amplification constant and on the grid-plate capacity.

The greater the number of grid wires per inch, the higher will be the amplification constant of the tube. But the increase in number of grid wires will increase the grid-plate capacity so once more something is lost. The diameter of the grid wire may be reduced with good effect on both the amplification factor and the grid-plate capacity. The smaller the wire used for the grid the greater will be the amplification factor and the less will be the grid-plate capacity.

Within the distance between filament and plate is placed the grid. The grid may be midway between the filament and plate, it may be closer to the filament, or closer to the plate. With the grid to filament distance made less there will be a decrease in plate resistance, which is to be desired, but there will also be a loss in amplification, which is not desired. Moving the grid closer to the plate

TUBE, DESIGN OF

will have just the opposite effect, an increase of amplification and an increase of plate resistance. Which of these results is chosen depends on the use to which the tube will be put. See *Tube, Amplifying Types of*.

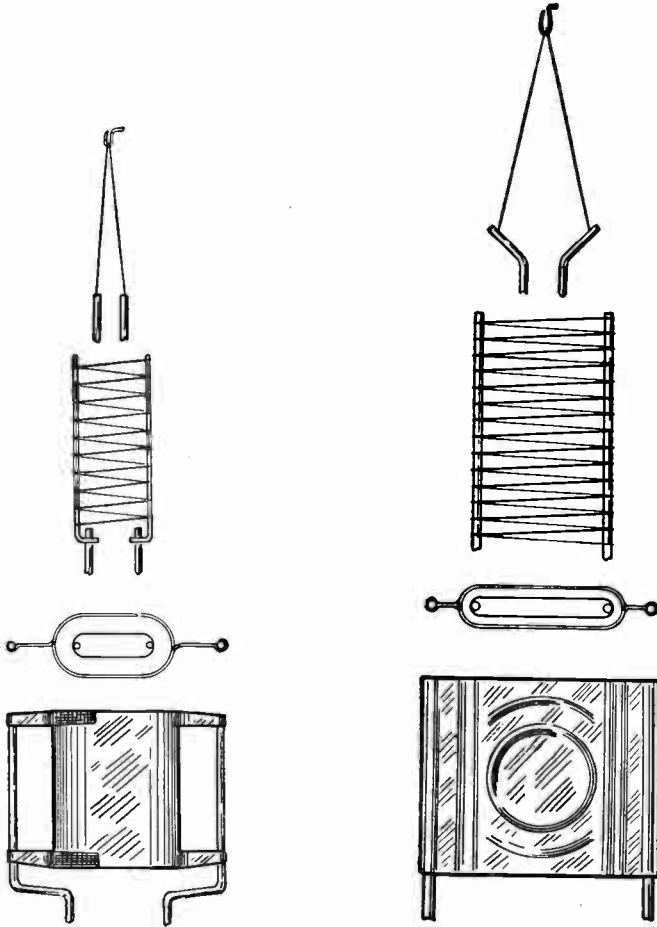

FIG. 1.—Design of an Early Type of Amplifier Tube.

FIG. 2.—Design of Standard Type of Voltage Amplifier Tube.

The construction and relative sizes of several tubes are shown in the accompanying illustrations, all of which are drawn to the same scale so that the sizes and proportions of the elements may be compared. The filament is shown at the top in each case. The grid is shown directly below the filament and the plate is shown at the bottom. Between the grid and plate is shown a top view indicating the positions of these two elements with reference to each other.

TUBE, DESIGN OF

One of the first amplifiers, the "201" type, is shown in Fig. 1. This tube has a tungsten filament requiring one ampere of current. A recent type of quarter-ampere amplifier tube is shown in Fig. 2. This tube has a thoriated filament. The close mesh of the grid wires may be seen here.

One of the first of the large power tubes, a Western Electric type, is shown in Fig. 3. Here the plate and the top view are at the left with the filament and grid placed at the right. This tube uses an oxide coated filament and requires one ampere of current. The construction of one of the semi-power tubes taking one-half ampere filament current is shown in Fig. 4. This tube has the widely spaced grid wires characteristic of its class. A later type of

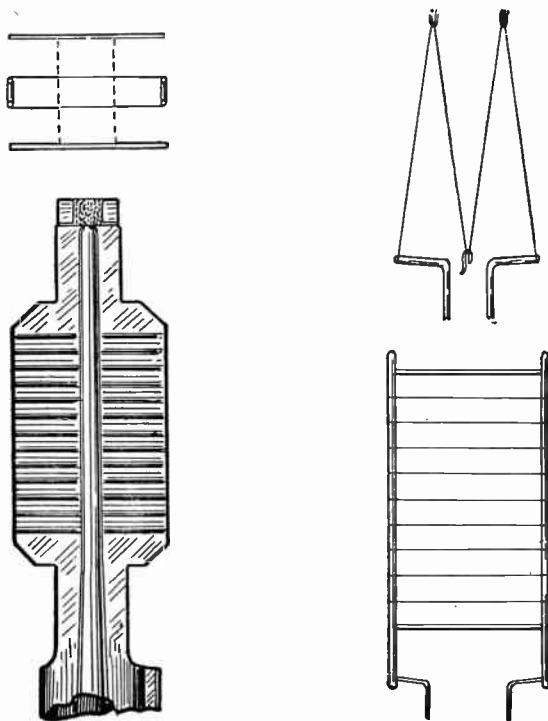

FIG. 3.—Design of an Early Type of Power Tube.

half-ampere power tube is shown in Fig. 5. It will be seen that the two halves of the filament are in parallel.

In Figs. 1, 2, 3 and 4 the grid wires have been drawn twice as far apart as in the tube itself so that the construction might be made clear. The grid wires of Fig. 5 are drawn as actually spaced.

Filament wire is generally .0015 diameter and the filaments are from 1.15 to 4.0 inches in total length. Plates run from 1.3 to 1.8 square inches inside area. Grid wires are of number 34, 35 and 36 gauge, from .0063 to .005 inch diameter. Amplifiers and detectors using one-quarter ampere of filament current have from twenty to

TUBE, DESIGN OF

twenty-eight turns of grid wire per inch. Power tubes have from eight to eighteen turns per inch in their grids. From ten to thirty turns are used to make a complete grid.

The tube filaments are made from tungsten and platinum wire,

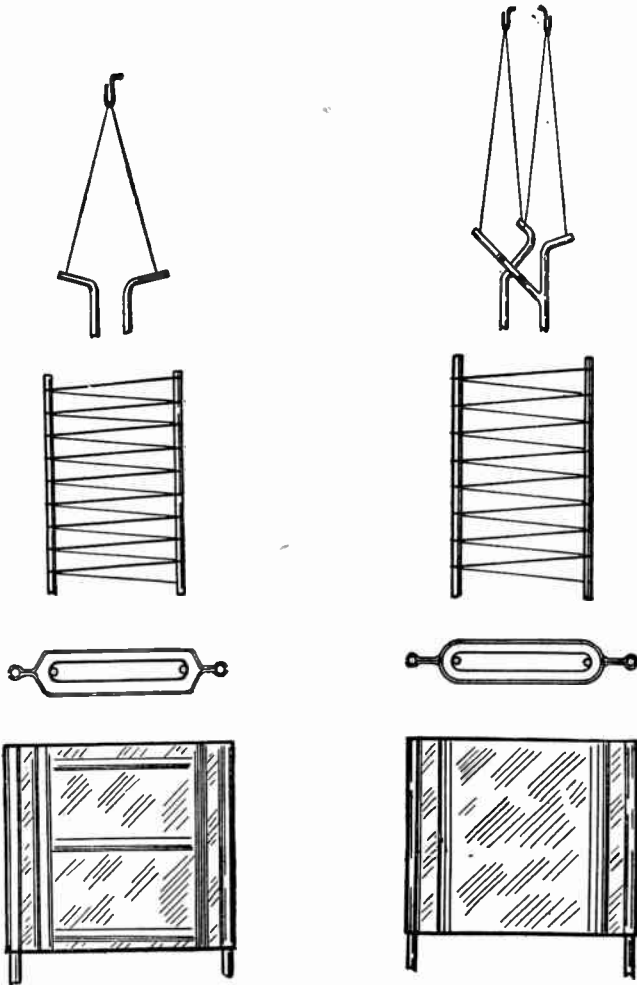

FIG. 4.—Design of a Semi-Power Tube.

FIG. 5.—Design of a Half-Ampere Power Tube.

generally specially alloyed and treated as described under *Tube, Filament Materials for*. Nickel enters largely into the construction of both the plate and the grid in many tubes, tungsten and molybdenum also being used for these parts.

TUBE, DETECTOR TYPES OF

TUBE, DETECTOR TYPES OF.—The operating principle of a vacuum tube used as a detector is explained under *Detector, with Grid Condenser and Leak*; also under *Detector, with Grid Bias*. Three kinds of tubes are used as detectors. First, the ordinary voltage amplifying tube, which is a hard tube, may be used as a detector. Second, the old style soft tube using one ampere of filament current may be used. Third, the newer gas content tube containing an alkali vapor acts as a very efficient detector. The characteristics of each type are given in the following paragraphs:

Gas Content Detector Tube.—The 200-A and 300-A types of detector tubes contain an alkali vapor within the bulb. The vapor starts to form as soon as the filament is lighted and the formation continues for the first minute or two of operation. At the end of

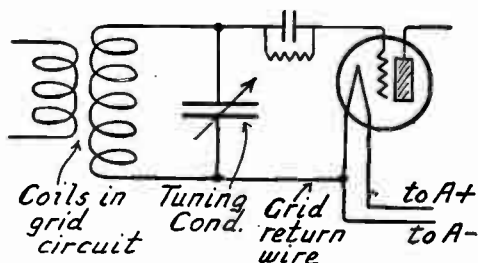

FIG. 1.—Negative Grid Return for Gas Content and Soft Detector Tubes.

about three minutes the vapor formation is complete and the tube operates normally. During the formation of the vapor the tube produces a soft hissing sound from the receiver.

These tubes require 5.0 volts across the filament and draw one-quarter ampere filament current. The grid condenser should be of .00025 microfarad capacity and the leak may be from two to three megohms resistance. Forty-five volts should be used on the plate circuit of this tube.

With these gas content tubes the grid return should be negative as in Fig. 1, whereas with the hard tube used as a detector the grid return should be positive. If the gas content tube is simply substituted for a hard tube detector having a positive return without changing the grid return to negative, much of the extreme sensitivity of the new tube on weak signals will be lost.

With 45 plate volts and negative grid return these tubes have plate impedances between 24,000 and 38,000 ohms, amplification factors of 20 to 35 and take about 1.0 milliamperes plate current.

Hard Tubes as Detectors.—The same type of hard tubes used regularly as amplifiers may be used as a very satisfactory detector. In fact, this is the type of tube most generally used for detection. It will operate either with a grid condenser and leak for grid current rectification or without them for plate current rectification.

Operated as a detector the hard tube should have from twenty to forty-five volts on the plate, values around forty to forty-five volts

TUBE, DISTORTION IN

being most commonly employed when using a grid condenser and grid leak. The best average value of grid condenser is .00025 microfarad capacity. Grid leaks of from one to five or more megohms resistance are used, the higher resistances giving greater sensitivity on very weak signals and the lower resistances giving better tone quality and greater stability against oscillation. A variable grid leak is of value with a hard tube for detector.

The grid return for a hard tube detector should be to the positive filament terminal of the tube as in Fig. 2. A negative grid return reduces the sensitivity of the hard tube detector on very weak signals. This is just opposite to grid return practice with soft tubes or with gas content tubes of any type when used as detectors. All dry cell tubes are hard tubes and when using them for detectors the foregoing instructions should be followed.

Soft Tube Detector.—Soft tubes containing a small quantity of gas are used in some cases for detector work. In the earlier days of radio, all detector tubes were of the soft type because they made much more sensitive detectors than the hard tubes then available and radio frequency amplification was not used. The soft or gassy detector tube of the older type uses one ampere of filament current

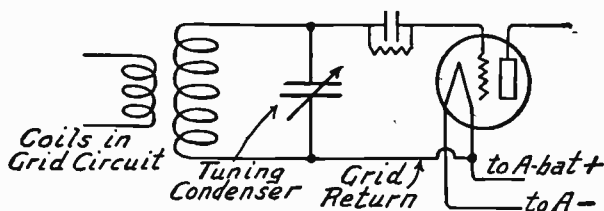

FIG. 2.—Positive Grid Return for Hard Tube as Detector.

and its sensitivity comes to an early end, especially if the operator persists in burning the filament at full brilliancy. The soft detector is adjusted to its most sensitive point of operation by gradually increasing the filament temperature. Increasing filament temperature finally causes a soft hissing sound to be heard and at the exact point where this hiss becomes just audible is the best point for detection.

When using one of the soft tubes as a detector a negative grid bias of about one and one-half volts is usually best. From sixteen to twenty-five volts should be used on the plate, the best value being determined by trial. The grid return with a soft tube is always negative. The grid leak is of lower resistance than when using a hard tube, the best value for the soft tube being in the neighborhood of one-half megohm. A soft tube, which is made especially for detector work, cannot be used as an amplifier.

TUBE, DISTORTION IN.—See *Distortion*.

TUBE, DOUBLE-GRID.—See *Tube, Screen Grid Type*.

TUBE, DRY CELL TYPE.—See *Tube, Filament Current Supply for*.

TUBE, FILAMENT ACTION IN.—See *Tube, action of*.

TUBE, FILAMENT CHARACTERISTICS OF.—See *Tube, Characteristics of*.

TUBE, FILAMENT CURRENT SUPPLY FOR

TUBE, FILAMENT CURRENT SUPPLY FOR.—The supply of current for heating the filaments in vacuum tubes may be secured from dry cell batteries, from storage batteries, from alternating current power and light lines or from filament current supply units operated from alternating current lines by rectifying and filtering the current before it passes to the tube.

This gives rise to a classification of tubes into dry cell types and storage battery types. Any tube which will operate from either of the forms of alternating current supply will also operate from a storage battery which delivers the required voltage.

The smallest dry cell tubes are those whose filaments operate at three volts and draw a current of 0.06 ampere. The operating characteristics of these tubes and of all other types are shown under *Tube, Amplifying Types of*.

Dry cell tubes are built to operate with 1.1 volts on the filament and draw one-quarter ampere filament current. For information on dry cells and their connections for these small tubes see *Battery, Dry Cell Type*.

A power tube for operation from dry cells requires three volts across its filament and draws a current of one-eighth ampere. Because of its low plate resistance this tube gives considerable power in watts and is used in the last stage of audio amplifiers.

There are several types of tubes designed for operation from storage batteries. The smallest of these are the voltage amplifiers requiring five volts across their filaments and drawing one-quarter ampere current. Power tubes and semi-power tubes are built for five volts on the filament with which they draw one-half ampere and also for six volts on the filament with which the same one-half ampere is drawn. Both of these types are represented in the table under *Tube, Amplifying Types of*.

Tubes drawing more than one-half ampere for their filaments are rather difficult to operate satisfactorily from storage batteries because the large current drain discharges the battery quickly. Tubes taking one ampere or one and one-quarter amperes for their filaments are usually operated directly from the power and light lines as described under *Power Unit, Filament Current Types of*. Since the larger power tubes require more than six volts on the filament for their operation with high plate voltages it would be necessary to use a four-cell storage battery in place of the more common three-cell, six-volt battery.

For information on storage batteries see *Battery, Storage Type*.

TUBE, FILAMENT EMISSION OF.—The filament of a tube is enclosed in a vacuum and when a metal body in a vacuum is heated above a certain point it throws off electrons which are negative charges of electricity. These negative charges of electricity are attracted to the plate because the plate is positively charged. However, all the electrons emitted are not necessarily attracted so strongly that they reach the plate, the reasons for this being explained under *Tube, Action of*. All of the electrons that do not reach the plate immediately go back to the filament because the subtraction of their negative charge from the filament leaves the fila-

TUBE, FILAMENT MATERIALS FOR

ment more positive so that it is in a condition to attract the electrons.

The electrons are evaporated from the hot surface of the filament in much the same way that steam is evaporated from the hot surface of water. But with electron emission no metal leaves the filament and it never grows smaller because of electron emission. The only thing that leaves the filament is a greater number of unit negative charges of electricity.

The amount of electron emission that is available for forming the electron flow in the plate circuit depends on the quantity of electrons leaving the filament and on the speed or velocity with which they are emitted. The emission is increased by a greater degree of vacuum in the tube, by greater heat of the filament wire, by increase of filament area and by the use of filament materials which readily allow the emission of electrons from their surfaces.

If the filament conditions are such that more electrons are emitted than are attracted to the plate the number that actually reach the plate is determined by the plate voltage and by the action of the grid in affecting the space charge. The electrons that reach the plate form the plate current of the tube. See also *Tube, Characteristics of*. For methods of measuring emission see *Tube, Restoration of*.

TUBE, FILAMENT MATERIALS FOR.—The filament wire for vacuum tubes is an item upon which depends a great deal in the operation of the tube and upon which consequently depends in large measure the satisfaction given by the tube. Filament wire requires the greatest care in its preparation so that the finished material meets the exacting requirements of performance and of uniformity. The manufacture of this material is a highly technical process and it is impossible to give more than a general view of the characteristics of the generally used materials here.

Filaments are made from three classes of wire. One is a pure tungsten wire, another is a tungsten wire treated with thorium and the third is a platinum-iridium wire coated with certain oxides.

Tungsten filaments are seldom employed in present day tubes because of the greater power they require in the filament circuit when compared with the other types. Tungsten filaments must be operated at brilliant white heat in order to give the necessary emission and plate current. This material was used in many of the older amplifier tubes and in the soft detector tubes requiring one ampere of filament current.

For the same amount of power in watts used in the filament circuit, when the tungsten filament has an emission represented by 42 the thorium filament's emission will be represented by 57 and the emission on the oxide coated filament by 100.

The oxide coated filament is built up from a central core of platinum-iridium alloy by applying successive coatings of a material made from oxides of barium, calcium and strontium and baking the filament following each application. These oxide coatings give off very great quantities of electrons when heated to only an orange or dull red color. They must never be heated above this point or the usefulness of the filament will be permanently destroyed. This type of filament is sometimes called a Wehnelt filament.

Thorium filaments or thoriated filaments are made by alloying thorium with tungsten. Thorium is a rare metal which itself is

TUBE, FORMS OF

capable of emitting radioactive rays of extremely high frequency. Thorium oxide is used in the coatings of incandescent gas mantles. The thorium which is mixed through the tungsten in filament manufacture gradually works out to the surface where it forms a layer of thorium atoms. With a given filament temperature the electron emission from such a layer is thousands of times greater than the emission from tungsten at the same temperature.

When the thoriated filament is first heated the atoms of thorium work out to the surface and form a layer. The thorium evaporates from the hot surface during the operation of the tube, but it is continually replaced by more of the atoms coming from the interior of the filament wire.

When the filament is operated at its rated voltage and not at higher voltages the thorium comes out to the surface just fast enough to replace the evaporation or loss. If the filament is operated at lower temperatures there may be a deficiency of thorium and the emission of electrons from the filament is limited. Almost as much energy is used in heating the filament, but the efficiency is low because of a lack of thorium.

When operating the filament at high temperatures, with excessive voltage, the layer of thorium atoms is evaporated from the filament surface much faster than a fresh supply is brought to the surface. When the filament is first overheated there is a great increase of electron emission and of plate current. But the thorium layer rapidly disappears and the emission drops so low that the tube fails almost completely. The activity of the filament may sometimes be restored as described under *Tube, Restoration of*. In addition to the loss of thorium from the overheated filament the high temperature causes a change in the structure of the tungsten. The filament becomes crystallized and very brittle so that a jar or shock that would not harm a tube in good condition will break the crystallized wire very quickly.



FIG. 1.—Standard Quarter-Ampere Amplifier Tube.



FIG. 2.—Small Half-Ampere Power Tube.

TUBE, FORMS OF.—In general the form or external appearance of a tube has little to do with its performance other than indicating roughly the power output, the greater the power, the larger the dimensions of the tube. Exact dimensions of several types of tubes are shown under *Tube, Bases for*. The appearance of a number of amplifying tubes, from the smallest to the largest in size, is shown in the illustrations.

TUBE, FORMS OF

The standard style of quarter-ampere amplifying tube is shown in Fig. 1, this being the familiar "201-A" which is generally employed with storage battery or power supply for filament current as a radio frequency amplifier, detector or audio frequency voltage amplifier. Depending on the plate voltage applied, this tube will deliver a power output up to 0.055 watt.

A half-ampere power tube is shown in Fig. 2. This type is designed for plate voltages up to 180 with corresponding negative grid biases up to 40.5 volts. Depending on the plate voltage used, this type will deliver power output as great as 0.803 watt, the characteristics being shown in full in the table under *Tube, Amplifying Types of*. It is the largest tube for operation with storage battery supply of filament current under usual circuit conditions, requiring but five volts for the filament circuit in order to obtain normal emission and plate currents up to twenty milliamperes.



FIG. 3.—Amplifier Tube
with Cylindrical Bulb.



FIG. 4.—Large Type of Power
Amplifier Tube.

Fig. 3 shows an amplifier having the same general characteristics as the tube in Fig. 1 for voltage amplification. This style is also made as a semi-power tube using six-volt filament supply and delivering as high as eight milliamperes plate current.

The power tube of Fig. 4 draws better than one ampere filament current, uses plate voltages in excess of 400 and allows plate currents as high as twenty-two milliamperes at the high voltage. This results in a maximum power output of 1.822 watts which is due to the greater filament current and plate voltage. When a tube of

TUBE, FORMS OF

this type is used with but six volts on the filament in place of the normal seven and one-half volts, and with but ninety to one hundred thirty-five volts on the plate, the power output is but little more than from a voltage amplifying tube and is only a fraction of the power delivered from the tube of Fig. 2 when it is furnished with one hundred thirty-five volts in the plate circuit. Unless power tubes of the larger sizes can be used with the filament and plate voltages required for their normal operation, better results will be had from smaller types of tube.



FIG. 5.—Quarter-Ampere Tube
Using 1.1 Volts on Filament.



FIG. 6.—Three-Volt Tube
with Large Base.

A tube taking the same filament current, one-quarter ampere, as taken by the storage battery tubes, but taking this current at a pressure of only 1.1 volts is shown in Fig. 5. The power output of this tube is very small, being only 0.007 watt with ninety volts applied to the plate and with slightly less than three milliamperes of plate current. The tube shown in Fig. 6 operates with three volts in its filament circuit. This type fits into the large standard base so that dry cells may be used for filament supply without employing socket adapters to accommodate the base.

The generally used three-volt amplifier tube for operation with dry cells for filament supply is illustrated in Fig. 7. This tube may have either the short base prongs shown or may be fitted with the long prongs. The short prongs are used on the "V" types and the long ones on the "X" types. The characteristics of the tube in Fig. 6 are the same as those of the tube in Fig. 7.

These three-volt dry cell tubes are used either as voltage amplifiers or as detectors. As an amplifier with ninety volts applied to the plate circuit they deliver slightly less than 0.007 watt of power output with a plate current of 2.5 milliamperes.

The tube shown in Fig. 8 is a real power tube in spite of the fact that it operates with dry cells for filament supply, drawing one-eighth ampere filament current at three volts pressure. With 135 volts on the plate and with a negative grid bias of 22.5 volts, this

TUBE, FOUR-ELEMENT TYPE

dry cell power tube will deliver 0.104 watt into the output circuit. This is about double the power obtainable from the voltage amplifier tube of Fig. 1. With the 22.5 volt grid bias this tube handles 2.8 milliamperes of plate current with 90 volts on the plate, 4.6 milliamperes with 112 plate volts and 6.5 milliamperes with 135



FIG. 7.—Three-Volt Dry Cell Amplifier Tube.

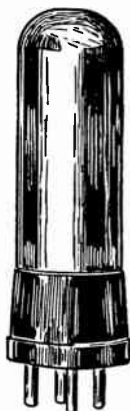
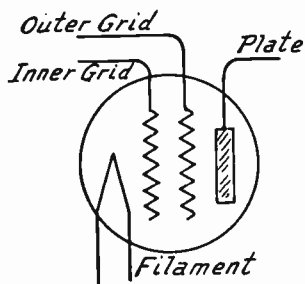

FIG. 8.—Dry Cell Power Tube.

volts on the plate circuit. This tube is used only in the output position, following three-volt voltage amplifiers such as shown in Fig. 7. It is then well able to handle the power required by loud speakers of the larger cone types.

TUBE, FOUR-ELEMENT TYPE.—A tube in which there are the usual filament and plate but two separate grids in place of the usual grid is called a four-element tube. The four-element tube



Four-Element Tube with Two Grids.

is adaptable to many special methods of handling radio circuits but it is not in general use.

This type of tube is shown in the diagram. The extra grid may be employed in various ways. The grid nearer the filament may be given a positive voltage or positive charge so that it neutralizes

TUBE, FREE GRID VOLTAGE IN

the space charge, allowing greater emission of electrons from the filament so that they may be more easily attracted to the plate. The grid nearer the plate is then used for control of plate current in the ordinary manner. See *Tube, Screen Grid Type*.

With this tube the grid nearer the filament may be used as the regular control for plate current while the one nearer the plate is used as an additional plate through which is supplied current used for regeneration by coupling this second grid (auxiliary plate) back to the input circuit of the tube.

The four-element tube has been used as a modulator tube with one grid operated by the variations in audio frequency or low frequency current while the other grid is operated by the changes in radio frequency or high frequency currents.

TUBE, FREE GRID VOLTAGE IN.—See *Tube, Characteristics of*; also *Leak, Grid*.

TUBE, GAS CONTENT TYPE.—See *Tube, Detector Type*.

TUBE, GRID ACTION OF.—See *Tube, Action of*; also *Tube, Characteristics of*.

TUBE, GRID BIAS IN.—See *Bias, Grid*.

TUBE, GRID CHARACTERISTICS OF.—See *Tube, Characteristics of*.

TUBE, GRID CURRENT IN.—See *Tube, Action of*; also *Tube, Characteristics of*.

TUBE, GRID-PLATE CAPACITY OF.—See *Tube, Capacities, Internal*.

TUBE, GRID RESISTANCE OF.—See *Tube, Characteristics of*; also *Tube, Input Resistance and Impedance of*.

TUBE, GRID VOLTAGE EFFECT IN.—See *Tube, Action of*; also *Tube, Characteristics of*.

TUBE, HARD.—A hard tube is one in which there is a very high degree of vacuum, in which remains only the least trace of air and other gases. Hard tubes are reliable and uniform in their characteristics, making excellent amplifiers. The output from a hard tube is formed only by the electron flow and not by a flow of current such as may take place through ionized gas in a tube not so completely evacuated.

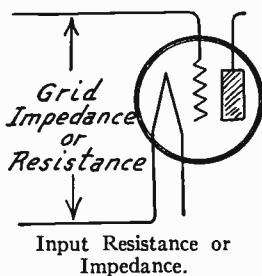

TUBE, HIGH MU TYPE.—See *Tube, Amplifying Types of*; also *Tube, Amplification of*.

TUBE, INPUT RESISTANCE AND IMPEDANCE OF.—The input resistance of a tube is the resistance of the path between its grid and filament. The resistance is practically infinite to flow of direct current as long as the grid voltage remains negative. With the grid voltage positive the input resistance is variable and current may flow in the grid circuit. See *Tube, Characteristics of*.

Due to the capacity between grid and filament in the tube the impedance of the input circuit or grid circuit of the tube is not infinite. The impedance of

TUBE, INTERNAL CAPACITIES OF

the grid to filament capacity is in parallel with the tuned grid circuit of radio frequency amplifying tubes. This impedance may have a quite serious effect at high frequencies in broadening the tuning of the grid circuit since it acts as an equivalent shunt impedance across any coil and condenser in this circuit. See also *Tube, Capacities, Internal*.

TUBE, INTERNAL CAPACITIES OF.—See *Tube, Capacities, Internal*.

TUBE, IONIZATION IN.—If plate voltages considerably above normal values are applied to some tubes it becomes possible to see a blue glow or haze inside the tube in addition to the usual light from the filament. This means that ionization is taking place inside the tube and that slight amounts of gas have been made partial conductors for electric current.

The breaking down of a gas by ionization means the separation of negative electrons from positive ions. In this condition it is possible for electric currents to flow through the gas independently of the true electron emission effect between the hot filament and the charged plate. There is then a conducting medium in place of a practically perfect insulator inside the tube.

With the first appearance of ionization a tube's sensitivity may be greatly increased. The soft detector tube using one ampere filament current contains enough gas so that ionization takes place quite easily. As the filament temperature of such a tube is gradually increased a point will finally be reached at which the tube's sensitivity increases many times over. With this particular tube partial ionization is depended upon for proper action; therefore this action takes place within the normal range of filament voltage and is not accompanied by any excessive amount of the blue glow.

Ionization in amplifier tubes or in hard tubes used as detectors is harmful. It will usually stop the action of the tube for the time being and if allowed to continue will probably ruin the tube permanently. In a tube having an imperfect vacuum, ionization may be started by using too high filament temperatures. With a normally high vacuum ionization is seldom caused by excessive filament temperature but is caused by using very high plate voltages, plate voltages much higher than the tube is designed to use.

High plate voltages cause heating of the metal in the plate above its normal operating point. The hot plate may emit some gases from itself, and atoms of these gases are broken up in ionization.

See also *Electrons*.

TUBE, LIFE OF.—An amplifying tube or detector tube properly used should give good service for at least 1500 to 2000 hours of operation. With a receiver used an average of three hours a day this would mean a normal tube life of about two years. On the other hand a tube may be used with filament temperature well above normal at all times and give less than one hundred hours of satisfactory service.

The life of the filament is the life of the tube since no changes take place in the grid or plate elements. The metal of the filament gradually wastes away from continued heating and the filament wire becomes thinner and thinner. This lessens the area of filament surface and there is a smaller electron emission unless the temperature is increased to make up the difference.

The smaller filament has a higher resistance and if the current through the filament is to remain constant it is necessary to increase the applied voltage.

TUBE, MANUFACTURE OF

Carrying the same amount of current through the smaller filament causes the filament temperature to be higher than before and this causes still more rapid volatilization of the filament metal. Thus the process of wasting away has a cumulative effect if the emission is kept up to normal and the tube deteriorates quite rapidly toward the end of its normal life.

The larger the filament, the longer and thicker it is made in the beginning, the greater will be its length of life. If care is taken to operate filaments at the lowest voltage and temperature that will give satisfactory reception good tubes may be operated for two years with excellent results. But if the filament temperature is carried high in an effort to get extreme volume and sensitivity the tube life will be only a fraction of what it should be. See also *Tube, Filament Materials for*.

TUBE, MANUFACTURE OF.—The various types of filaments used in vacuum tubes are described under *Tube, Filament Materials for*. The filament, the plate and the grid are assembled together and supported with wires passing down through that part of the glass called the press as shown under *Tube, Action of*. The press is made at the top of a short piece of glass tubing whose lower end is sealed onto the lower end of the bulb, both parts being supported from the base.

The wires passing through the press are made from a copper coated alloy of nickel and iron which expands and contracts when heated at the same rate as the glass so that it is possible to make a joint that will not tend to open with temperature changes. This joint remains vacuum tight. In addition to the two filament leads and the leads for the plate and grid which connect with the bottom prongs, there are several anchor wires acting solely as supports for the plate, grid and filament. These anchor wires pass down into the press but are not carried through to the base.

Anchor wires pass up on both sides of the plate, and the grid is wound around two or more anchor wires in the larger tubes. The filament is supported by its two ends at the bottom and from a small loop at the top, this loop being carried by the upper end of the center anchor wire. In many of the newer types of tubes still greater rigidity of construction is obtained by carrying the anchor wires above the plate and grid and fastening them to a short insulating rod at the top. This rod links all the supports together and makes the filament, plate and grid structure very strong and well able to resist the effects of vibration which produce microphonic effects in other tubes.

All of the joints between the anchor wires and the plate, grid and filament are welded. Each turn of the grid is welded to its supporting wires to maintain the grid wires in their proper relative positions. The complete assembly so far described is placed within the glass bulb after which the edges of the stem and the bulb are joined. The tube is then ready to be pumped out or exhausted.

When most of the air and gases from within the bulb have been drawn out by the vacuum pumps the tube is heated while still on the vacuum so that all moisture is evaporated and drawn out. Gases still remain in the metal of the filament, plate and grid. These must be gotten rid of before the tube is used for otherwise

TUBE, MU OF

they would escape into the vacuum and make the tube soft later on, thus changing its operating characteristics.

The filament is heated to a very high temperature by passing a current through it. This drives the gases out of the filament and they are drawn off by the vacuum pumps. But there is only one terminal connection each for the plate and for the grid, therefore current cannot be passed through these elements. They are heated by placing the tube within the field of a coil carrying high frequency currents and the eddy currents generated in the metal of the plate and grid heat these two parts to just below their melting points. This drives out the gases which are drawn out by the pumps. All gas and moisture in the glass of the bulb and stem are driven out by the oven heating.

With all the precautions described there are still traces of gas within the bulb, and the last step is to get rid of these traces. In a small extension tube attached to the bulb during its evacuation is a small bit of the metal magnesium. This magnesium is now heated with a high frequency coil until it vaporizes with a flash. The vaporized magnesium enters the bulb and combines with the last traces of any gases present so that the inside of the bulb finally contains a very complete vacuum. The flashing of the magnesium causes this metal to be deposited all around the inside surface of the bulb and gives the characteristic mirror-like appearance.

The bulb is now sealed, is then assembled in the base, and the filament, plate and grid leads are soldered into the base prongs so that the tube is ready for use.

TUBE, MU OF.—The Greek letter “mu” is a symbol for amplification factor. See *Tube, Amplification of*.

TUBE, MULTIPLE ELEMENT.—Vacuum tubes are made with three complete sets of filaments, plates and grids enclosed within the one bulb. One type is illustrated in Fig. 1. The base fits into a standard socket and has the four regular prongs on its bottom. Around the upper part of the base is a flange carrying four additional terminals, two of these connecting to the two extra grids and the other two connecting to the two extra plates. The three complete sets of elements may be seen side by side in the bulb.

The internal connections of such a tube are shown in Fig. 2, which shows the four prongs inside the inner circle and the four added terminals around the outside. The elements are shown as

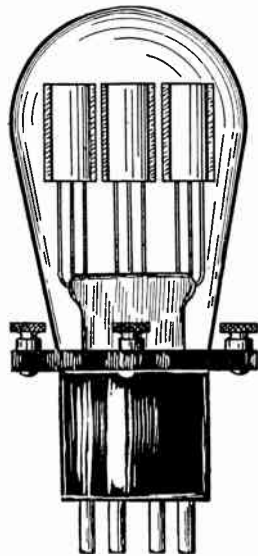

FIG. 1.—Multiple Element Tube.

TUBE, MUTUAL CONDUCTANCE OF

they are connected to the prongs and extra terminals. The three filaments are in series with one another.

This type of tube may be used in any circuit or any part of a circuit which would require three ordinary tubes. Any combination of radio frequency, detector and audio frequency stages may be

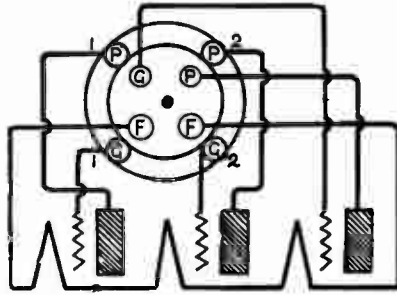

FIG. 2.—Internal Connections of Multiple Element Tube.

used such as two radio frequency amplification stages and a detector, a detector and two audio frequency stages and so on. The same voltage may be applied to all three plates or they may all use different voltages as desired. Wiring connections are made to this tube just as though it were three entirely separate units.

TUBE, MUTUAL CONDUCTANCE OF.—In a tube used as an amplifier it is desirable to have a high amplification factor and a low plate resistance. The high amplification factor allows a large voltage gain while the low plate resistance allows a large power output. These two measures of a tube's action may be combined into a third which is called mutual conductance. Since mutual conductance takes into account both the amplification factor and the plate resistance of the tube, it forms an excellent guide to the all-around ability of a tube as an amplifier.

The mutual conductance of a tube may be found by dividing the amplification factor by the plate resistance in ohms thus:

$$\text{Mutual Conductance} = \frac{\text{Amplification Factor}}{\text{Plate Resistance}}$$

From this formula it may be seen that the mutual conductance is increased by an increase of amplification factor but is decreased by an increase of plate resistance. It is always desired to have the mutual conductance as large as possible. Consequently a tube having a large factor of amplification, but also having a high plate resistance will show no gain in mutual conductance since the one offsets the other.

The foregoing formula for mutual conductance gives the result in mhos. The mutual conductance is usually expressed in micromhos or in millionths of a mho. Taking a tube with an amplification factor of 6.4 and with a plate resistance of 8000 ohms, the mutual conductance as given by the equation would be .0008 mho, 8/10000 of a mho, or 800 micromhos. Receiving tubes may have mutual conductances, measured in micromhos, of from 500 to 2000.

TUBE, MUTUAL CONDUCTANCE OF

The mutual conductance of a tube indicates the control over the plate current that is given by changes of grid voltage. It indicates the curvature and the slope of the grid voltage-plate current curve of the tube. The steeper the slope of this curve the greater is the effect of grid voltage change on plate current and the greater is the mutual conductance.

The mutual conductance may be found also from the grid voltage-plate current curve. Part of such a curve is shown. This is the part of the curve used when the grid is kept at zero voltage, it is the part of the curve to the left of the zero line. Ordinarily only a straight part of a curve is used in measuring

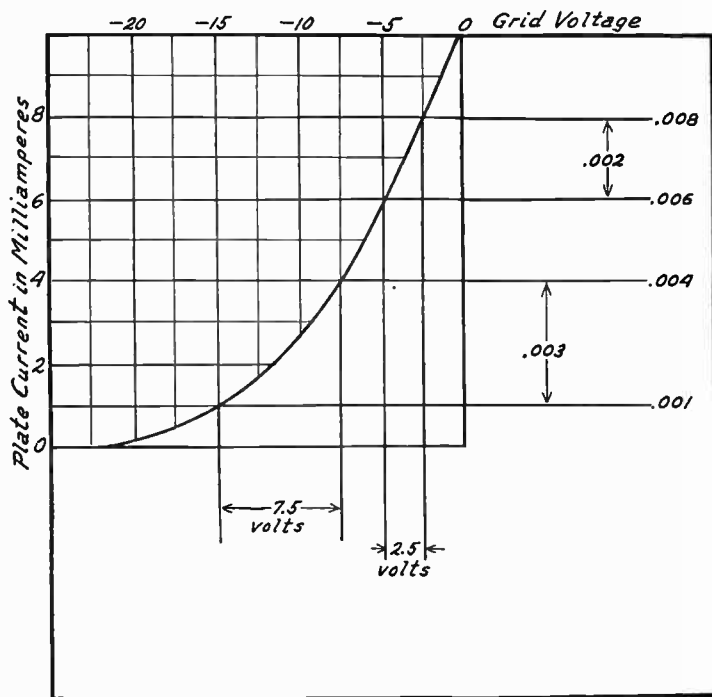

Measurement of Mutual Conductance from Grid-Voltage, Plate-Current Curve.

mutual conductance but to show the difference made by the degree of slope measurements will be made at two points on this curve having a bend.

An examination of the curve will show that a change of grid voltage from -7.5 to -15.0 , which is a 7.5 volt change, will decrease the plate current from four milliamperes to one milliampere, a change of three milliamperes or $.003$ ampere.

Dividing the change in plate current in amperes by the required change in grid voltage will give the mutual conductance of the tube. The formula is:

$$\text{Mutual Conductance} = \frac{\text{Change in Plate Current}}{\text{Change in Grid Voltage}}$$

TUBE, OPERATION OF

Placing the above values taken from the curve in this formula, we divide .003 ampere by 7.5 and obtain .0004 mho or 400 micromhos as the mutual conductance.

That the steepness of the curve is indicated by the mutual conductance may be proven by taking readings from the curve at points higher up and on a steeper part than the first ones considered. A change of 2.5 volts on the grid, from -2.5 volts to -5.0 volts, causes a plate current decrease from eight milliamperes to six milliamperes, a change of .002 ampere. Dividing this plate current change, .002, by the grid voltage change, 2.5, gives the mutual conductance as .0008 mhos or 800 micromhos compared with only 400 micromhos where the curve is less steep. See also *Tube, Testing of*.

TUBE, OPERATION OF.—See *Tube, Action of*; also *Tube, Characteristics of*.

TUBE, OSCILLATION IN.—See *Oscillation*; also *Regeneration, Action and Principles of*.

TUBE, OSCILLATOR TYPE.—Any amplifier tube may be used as an oscillator, there being no special construction required when the tube is used as a generator of oscillating currents. For uses of tubes as oscillation generators see *Oscillator* and also *Receiver, Superheterodyne*.

TUBE, OUTPUT RESISTANCE AND IMPEDANCE OF.—The opposition to flow of current between the plate and filament in the tube is the plate resistance or plate impedance. This opposition is caused chiefly by the space charge effect which opposes the electron flow as explained under *Tube, Action of*.

The higher the voltage applied to the plate of a tube the greater will be the positive charge placed upon the plate. This increased positive charge overcomes to a greater extent the space charge effect so that it becomes easier for the electron flow to pass between plate and filament. Thus, increasing the plate voltage reduces the plate resistance or the internal resistance of the tube.

Plate Resistance.—The direct current resistance of the plate circuit in the tube is found by dividing the plate voltage by the plate current. The alternating current plate resistance is found from the following formula:

$$\text{Plate Resistance} = \frac{\text{Plate Volts} + (\text{Amplification Factor} \times \text{Grid Volts})}{2 \times \text{Plate Current}}$$

The numerator in the second term of the foregoing formula is the effective plate voltage which is found by adding to the voltage which is applied to the plate itself the grid voltage multiplied by the amplification factor. Since the plate resistance is generally figured with the grid at zero voltage the formula for plate resistance then becomes:

$$\text{Plate Resistance} = \frac{\text{Plate Volts}}{2 \times \text{Plate Current}}$$

TUBE, OUTPUT RESISTANCE AND IMPEDANCE

Plate Impedance.—A curve showing the relation between plate current and plate voltage will show the effect that a certain change in plate voltage will have in increasing or decreasing the plate current, other things remaining the same. A curve is shown.

The plate impedance indicates the curvature and degree of slope in the plate-current, plate-voltage curve. The plate impedance is found by selecting a certain change of plate voltage on the curve and noting the corresponding change in plate current. The following formula is then used:

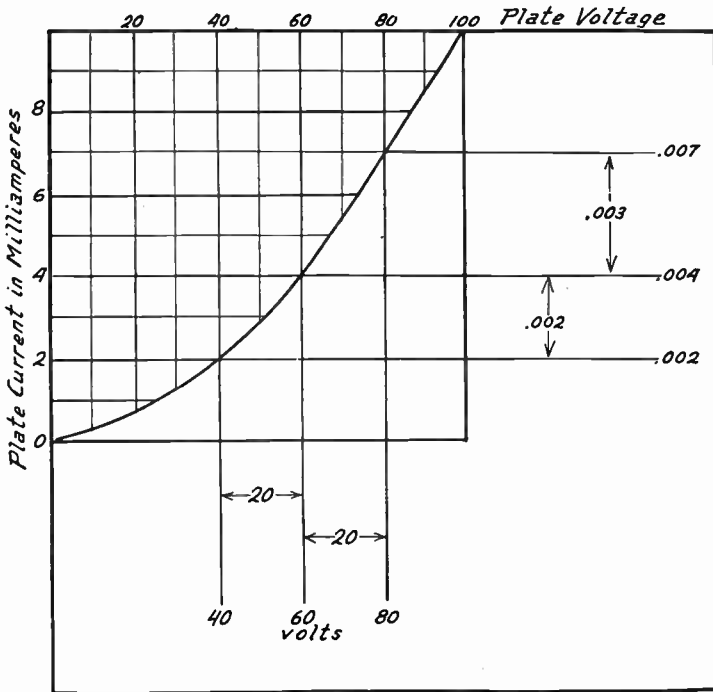

Measurement of Output Impedance from Plate-Voltage, Plate-Current Curve.

$$\text{Plate Impedance} = \frac{\text{Change in Plate Voltage}}{\text{Change in Plate Current}}$$

Looking at the curve it will be seen that changing the plate voltage from 40 to 60 increases the plate current from two to four milliamperes or from .002 to .004 ampere. Dividing the change in voltage, 20 volts, by the change in amperage, .002 ampere, gives the plate impedance at this point on the curve as 10,000 ohms.

Again looking at the curve and changing the plate voltage from 60 to 80 it is found to increase the plate current from four to seven milliamperes

TUBE, PARALLEL OPERATION OF

or from .004 to .007 ampere. Here we again have a voltage change of 20 but have a current change of .003 ampere. Again dividing the voltage change by the current change, the result is 6,666 ohms plate impedance. Thus it is seen that the plate impedance becomes less with increase of plate voltage. See *Tube, Testing of*.

The impedance under given conditions of plate voltage and plate current is greater than the resistance measured under the same conditions.

See also *Impedance, Matching of*.

TUBE, PARALLEL OPERATION OF.—Any two amplifying tubes may be operated in parallel and their combined output of plate current will be almost twice as great as the plate current output from either of the tubes alone. The connections are shown in the diagram. The two grids are connected together, the two plates are likewise connected together, and these combined grid terminal connections and plate terminal connections are treated the same as similar terminals for a single tube.

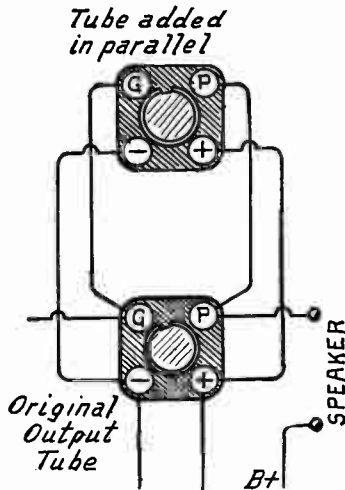

Parallel Operation of Tubes.

Two tubes used in this way must be of identical type and preferably of the same make. With two tubes in parallel a given input voltage on the grids will produce double the power of one tube in the plate circuit. The voltage gain is high with parallel operation. The combined plate impedance or resistance of the two tubes is equal to one half that of one similar tube. The amplification of two tubes in parallel is not as great as from two tubes in a push-pull amplifier properly operated. However, the parallel arrangement requires no special transformers and good results may be expected from equipment of ordinary quality whereas push-pull parts must be of the very best and the circuits must be properly laid out.

TUBE, PEANUT TYPE.—A very small size of vacuum tube which was developed during war time but was never sold to the public. The peanut tube was designed for use in portable receivers of small size.

TUBE, PHASE RELATIONS IN

TUBE, PHASE RELATIONS IN.—See *Phase, Relations in Tube*.

TUBE, PLATE ACTION OF.—See *Tube, Action of*.

TUBE, PLATE CAPACITY OF.—See *Tube, Capacities, Internal of*.

TUBE, PLATE CHARACTERISTICS OF.—See *Tube, Characteristics of*.

TUBE, PLATE CURRENT IN.—See *Tube, Action of*; also *Tube, Characteristics of*.

TUBE, PLATE RESISTANCE OF.—See *Tube, Output Resistance and Impedance of*; also *Tube, Characteristics of*.

TUBE, PLATE VOLTAGES FOR.—The voltage applied to the plate of a tube must be of a value suitable for the kind of tube and for the use to which this tube is put. For example, soft detector tubes operate well with plate voltages from 12 to 22, hard detectors operate well with from 22 to 45 volts on their plates, radio

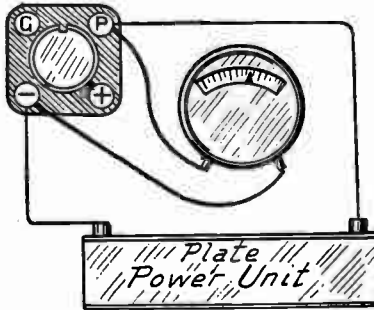

Measuring Applied Plate Voltage.

frequency amplifying tubes should have from 16 to 90 plate volts, audio frequency voltage amplifying tubes usually use from 67 to 135 plate volts and audio frequency power tubes use from 120 to 500 volts on their plates.

Any amplifying tube using more than 65 volts on its plate should have a proper negative grid bias to prevent distortion. The amount of grid bias depends on the plate voltage being used and on the type of tube. One tube having 135 volts for its plate may require only nine volts negative grid bias while another tube with the same plate voltage may require three times as much grid bias for proper operation. No general rules can be laid down for plate voltages and corresponding grid voltages. These values are specified by the manufacturers of the tubes and are always given on the instruction sheets accompanying the tube when bought. The table under *Tube, Amplifying Types of*, gives the values of plate and grid voltages for most of the generally used types of amplifiers. See also *Bias, Grid*.

TUBE, POWER AMPLIFICATION OF

In speaking of plate voltages it is really the voltage at the source of plate current supply that is usually meant. It is this supply voltage that is given in the table under *Tube, Amplifying Types of*. The voltage actually applied to the tube's plate is not always as high as this voltage of the source. This is especially true in resistance coupled amplifiers where there is a great drop of voltage through the coupling resistance or plate circuit resistance.

The applied plate voltage is measured between the plate terminal and the negative filament terminal of the tube. This is the voltage of the source less the drop through the coupling device.

The effective plate voltage is the voltage that actually determines the operation of the plate when in action. The effective plate voltage is the same as the applied voltage only if the grid is at zero voltage. When there is a voltage applied to the grid the effective plate voltage is found as follows:

$$\text{Effective Plate Voltage} = \text{Applied Plate Voltage} + \left(\text{Amplification Factor} \times \text{Grid Voltage} \right)$$

TUBE, POWER AMPLIFICATION OF.—See *Tube, Amplification of*.

TUBE, POWER OUTPUT OF.—See *Tube, Amplification of*.

TUBE, POWER TYPES OF.—See *Tube, Amplifying Types of*.

TUBE, PROTECTIVE TYPE.—A special protective tube is made for preventing excess voltage in the circuits of receivers operated from power supply units. The base of this tube is of the bayonet lock type and has three terminals. The two ends of its filament are connected to two contact points in the bottom of the base while the center of the filament is connected to the metal shell of the base. With only twenty milliamperes flowing through this tube the voltage drop across the whole filament is five volts and the drop across each half of the filament is two and one-half volts. Should the current increase there is a great increase of resistance in the filament until, with a current of ninety milliamperes, the drop across the whole filament is ninety volts and across each half is forty-five volts. This tends to retard the excess flow of current. See also *Fuses and Protective Devices*.

TUBE, RADIO FREQUENCY TYPE.—See *Tube, Amplifying Types of*.

TUBE, RECTIFIER TYPES OF.—A rectifier tube is a tube used for changing an alternating current into a pulsating direct current. Gaseous rectifiers, described under *Power Unit*, making use of ionization in a gas between the electrodes are used in plate and filament supply units. Thermionic rectifiers to be described here use the electron flow between a hot cathode or filament and a cold anode or plate, the effect being that of conductivity in one direction only.

If a rectifier tube having the property of conducting in one direction only is connected in an alternating current circuit as in Fig. 1 it will conduct practically no current at all during one half cycle or one alternation but will conduct almost the full current on the

TUBE, RECTIFIER TYPES OF

other half cycle. Thus the one polarity is shut off while the other polarity is passed through the tube into any following circuit.

The filament of a rectifier tube may be heated from a battery as shown in Fig. 1 or it may be heated from part of the alternating current from the supply line. An ordinary three-element amplifier

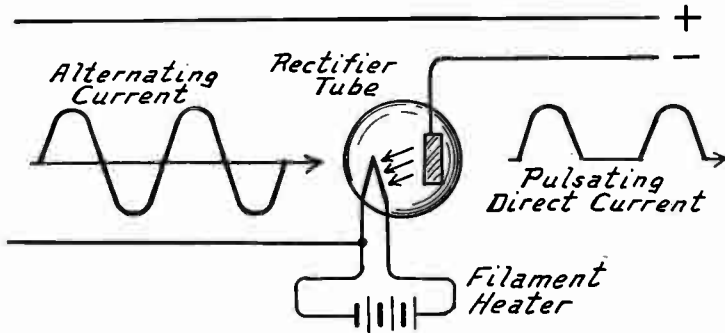

FIG. 1.—Action of Half-Wave Rectifying Tube.

tube may be used as a rectifier if its plate and grid terminals are joined to make the plate terminal of the rectifier.

The rectifier will operate most efficiently when the filament temperature is high enough so that the voltage being applied to the plate will cause all the electrons from the filament to pass to the plate. Under this condition there will be the maximum possible flow of rectified current from the energy used in heating the filament.

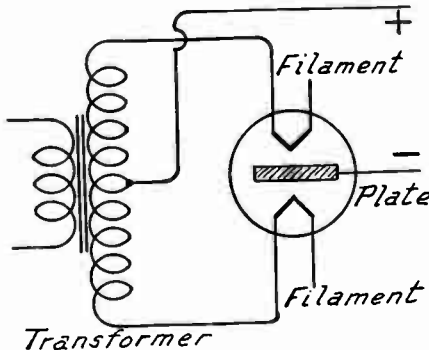

FIG. 2.—Connections of Full-Wave Rectifying Tube.

The tube so far described and the one shown in Fig. 1 is called a half-wave rectifier because it rectifies or passes only half of the alternating current wave and prevents passage of the other half. Full-wave rectifier tubes are made to handle both halves of the wave so that there is a more steady flow of pulsating current.

TUBE, RECTIFIER TYPES OF

PERFORMANCE OF FILAMENT TYPE RECTIFIERS

Type	Filament		To Condenser Input Filter			To Choke Input Filter			
	Volts	Amps	A. C. Input Volts per Plate	D. C. Output		A. C. Input Volts per Plate	D. C. Output		
				Mils	Volts		Mils	Volts	
280, 380 Full wave	5.0	2.0	220	25	270	270	25	235	
	—	—		50	235		—	50	220
	—	—		75	210		—	75	205
	—	—		100	190		—	100	190
	—	—		125	175		—	125	180
	—	—	260	25	325	320	25	282	
	—	—		50	290		—	50	265
	—	—		75	260		—	75	250
	—	—		100	240		—	100	240
	—	—		125	225		—	125	230
	—	—	300	25	370	370	25	330	
	—	—		50	340		—	50	310
	—	—		75	315		—	75	295
	—	—		100	295		—	100	285
—	—	125		280	—		125	272	
281, 381 Half wave	7.5	1.25	550	25	660	NOTE—Choke input filters are described under <i>Power Unit</i> and shown by Fig. 12 in that section. Condenser input filters are shown by Fig. 9 under <i>Power Unit</i> .			
	—	—		40	590				
	—	—		55	540				
	—	—		70	485				
	—	—		85	430				
	—	—	650	25	775				
	—	—		40	720				
	—	—		55	660				
	—	—		70	600				
	—	—		85	535				
	—	—	700	25	835				
	—	—		40	780				
	—	—		55	720				
	—	—		70	665				
—	—	85		610					
281, 381 Full wave— two tubes	7.5	1.25	550	25	710	720	25	640	
	—	—		50	650		—	50	570
	—	—		75	600		—	75	545
	—	—		100	550		—	100	530
	—	—		125	510		—	125	510
	—	—	150	475	—	150	490		
	—	—	650	25	840	850	25	750	
	—	—		50	780		—	50	695
	—	—		75	725		—	75	668
	—	—		100	680		—	100	650
	—	—		125	640		—	125	635
	—	—	150	600	—	150	620		

TUBE, RECTIFIER TYPES OF

One type of full-wave rectifying tube has two filaments and a single plate as shown in Fig. 2. The filaments are connected to opposite ends of a transformer so that one or the other is always positive while the remaining one is negative. There is thus a steady flow of current from the plate to either one filament or the other.

In a vacuum tube a space charge or electrostatic field is produced around the heated filament by the electrons just as such a space charge is produced in an amplifying tube. This space charge opposes further emission of electrons from the filament and with such a tube it is possible to obtain the required output current with high voltages applied to the plate.

Argon Gas Rectifiers.—Rectifier tubes for handling large currents, such as in battery charging, have an inert gas, argon, in the bulb. The collisions between electrons and gas molecules produce positive ions which neutralize the negative space charge. A comparatively low voltage applied to the plate will then cause a large current to flow.

When the circuits of such a rectifier are closed, electrons are emitted from the hot filament. These electrons ionize the argon gas and an arc or conduction path is immediately formed between the filament and the plate. The ionization is visible as a blue glow and may be maintained by voltages of from one to eight volts direct current. Once the arc starts it may be maintained without supplying current to heat the filament, but when this is done the arc will become concentrated at one part of the filament so that this part is overheated to a damaging extent.

Tests of 2-ampere and 5-ampere tubes at the Bureau of Standards were found to give the following performance.

PERFORMANCE OF RECTIFIER TUBES

Charging Amperes	Primary Amperes	Charging Watts	Primary Watts	Power Factor	Efficiency	Battery Voltage
3.24	1.85	6.8	87	40%	7.8%	2.1
2.59	1.59	16.6	83	45%	20.0%	6.4
1.59	1.07	22.9	71	57%	32.2%	14.4
.21	.50	6.5	43	74%	15.3%	30.8
6.00	3.5	12.9	155	38%	8.3%	2.15
4.45	2.7	28.5	137	44%	20.8%	6.40
1.92	1.4	27.8	88	55%	31.6%	14.50
.02	.5	.54	40	70%	1.4%	26.90

Since current flows from the plate to the filament of these tubes, current in the external circuit must leave the rectifier tube by way of the filament and return to the tube by way of the plate. Considering the rectifier as a source of current the filament is then the positive terminal of the source and the plate is its negative terminal.

For practical uses of rectifier tubes see *Charger, Battery, Bulb Type*, also *Power Unit*.

Two-element tubes have sometimes been used as detectors in radio receiver circuits. The function of a detector is to change the received alternating voltages

TUBE, REGULATOR TYPE

into direct voltages which will operate loud speakers or headphones. The use of a two element tube as a detector is shown in Fig. 3. This application is practically the same as that for a crystal detector.

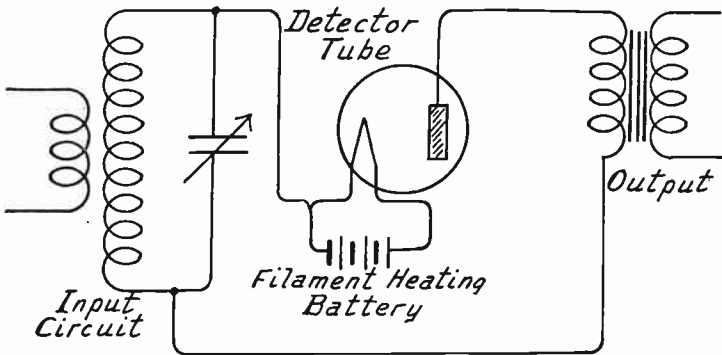

FIG. 3.—Two Element Rectifier Used as Detector.

TUBE, REGULATOR TYPE.—See *Tube, Voltage Regulator Type*.

TUBE, RESTORATION OF.—Overheating the filaments of tubes whose filament wire is of the thoriated type will cause the rapid evaporation of the layer of thorium from the filament surface. The emission of the tube will then be only a fraction of its proper value and very little plate current can be had.

There is additional thorium distributed through the metal of the filament and it is often possible to form a new surface layer from this reserve supply so that the tube will operate almost as well as when new. Fresh thorium may be brought to the surface by heating the filament, but during the heating it is necessary that the plate voltage be cut off from the tube.

The overheating may have been caused by excessive filament voltage or by a momentary and accidental application of plate voltage or B-battery voltage to the tube filaments. If the high voltage lasts for only an instant it is quite possible that the filaments will not be burned out, yet it may be found that the tube is almost dead so far as amplifying signals are concerned. Under such conditions tube restoration is practicable. Restoration is also of value after tubes have been in normal operation over long periods of time. But if the thorium content of the filament has been nearly used up in normal operation the improvement made by the restoration process will be only temporary.

Restoration by filament heating can be applied only to those tubes whose filaments contain thorium. It cannot be applied to tubes having plain tungsten filaments, nor to tubes having oxide coated filaments. Plain tungsten filaments are those which light with great brilliancy in normal operation. Plain tungsten filaments are found in the older tubes which use one-ampere filament current, such as those in the 200 and 201 series. Oxide coated filaments are those which operate at very low temperatures, at a dull red or dull orange

TUBE, RESTORATION OF

heat. These include such tubes as the 11 and 12 types, the 112 semi-power tube and the 216-A power tube.

Thoriated filaments are found in most of the voltage amplifying and power amplifying tubes such as 201-A, 301-A, 171, 371, 210, 310, 199, 299, 120 and 220 types. Thoriated filaments are also found in the 200-A and 300-A detector tubes. Any of these types may be subjected to the process of restoration, usually with very good results.

Restoration in the Receiver.—If the overheating has not been very severe nor long continued it is often possible to restore the affected tubes to normal operation without removing them from the receiver.

The B-battery or plate voltage supply should be entirely disconnected. The tubes are left in their sockets and the A-battery or filament supply voltage is applied with full force. The proper voltage for three-volt dry cell tubes is four volts and for five-volt storage battery tubes it is seven volts. This voltage should be applied for one hour. At the end of this time the filament voltage is reduced to normal operating point and the B-battery or plate supply is reconnected.

It would be impossible to apply seven volts to the filaments of tubes when the receiver is operated from a six-volt storage battery and it would be impossible to apply four volts to dry cell tubes unless the receiver has more than two dry cells in series for the filament supply. Under these conditions the work may be done by turning the rheostats all the way on or by short circuiting filament control resistors. The heating may then be continued for two hours or more.

Restoration with High Voltages.—When the process of restoration is applied outside of the receiver it consists of two separate steps. The first step, called flashing, applies a high voltage to the filament for a few seconds; the second step, which is called ageing, applies a lower voltage for a greater length of time. The flashing brings the thorium out from the filament wire and the ageing forms it on the filament surface.

When a tube is being restored no connections are made to the grid or to the plate. It is necessary to have available either alternating or direct current of variable voltage. The source of current is connected to the filament terminals with an accurate voltmeter across the terminals. A rheostat is required so that the voltage applied to the filaments may be adjusted to the correct value. The connections for a tube restorer using an alternating current toy transformer are shown in Fig. 1.

The transformer should have several voltage taps since it is necessary to have voltages from four to twenty in handling the different kinds of tubes. Two rheostats may be connected as shown for finer control of voltage than given by the transformer taps. These rheostats should be of ten to twenty ohms resistance each. The voltmeter should read from zero to twenty volts and must be of the alternating current type for use with a transformer. Two or more sockets may be attached to the lines so that tubes with different bases may be handled. It is not necessary to provide switches for using the different sockets because removal of a tube from any socket opens all its connections. If a storage battery is used in place of the transformer the voltmeter must be of the direct current type. The meter must be connected across the filaments and not between the rheostats and the battery or transformer.

TUBE, RESTORATION OF

This process may be applied to detector tubes, to amplifier tubes and to rectifier tubes of any types having thoriated filaments. The following table gives the voltages to be applied in both flashing and ageing and also gives the length of time each voltage should be used.

VOLTAGE AND TIME FOR RESTORATION OF TUBES

Type of Tube	Normal Filament Operation		Flashing Time		Ageing Time	
	<i>Volts</i>	<i>Amperes</i>	<i>Volts</i>	<i>Seconds</i>	<i>Volts</i>	<i>Minutes</i>
199, 299, DV-3, etc.	3.0	.06	12	10 to 20	4	15 to 60
120, 220, etc.	3.0	.125	12	10 to 20	4	15 to 60
201-A, 301-A, DV-2, DV-5	5.0	.25	18	20 to 30	7	10 to 60
171, 371, etc.	5.0	.50	18	10 to 20	7	10 to 60
210, 310, etc.	7.5	1.25	—	—	10	2 to 15
200-A, 300-A (detector)	5.0	.25	18	10 to 20	—	10 to 60
213, 313, etc. (rectifier)	5.0	2.0	—	—	7	10 to 60
216-B, 316-B (rectifier)	7.5	1.25	—	—	10	10 to 60

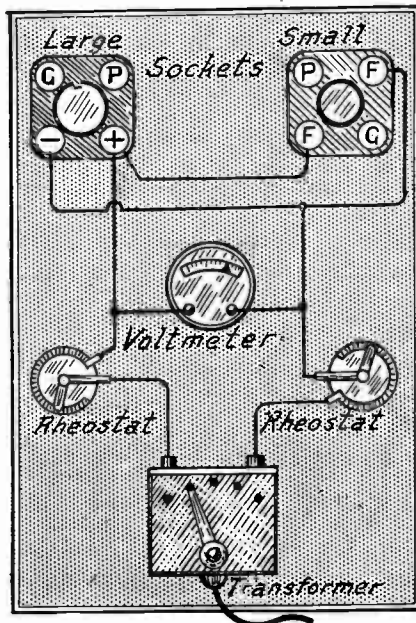

FIG. 1.—Tube Restorer with Transformer.

This process will restore tubes which still have considerable useful life remaining in their filaments. If the tubes are old and really worn out and if their filaments have grown thin with age and long

TUBE, RESTORATION OF

use the flashing will often burn them out completely. This indicates little more than the fact that the tube had lived its useful life and was in line for replacement.

Faster work may be done by increasing the voltage for ageing and reducing the time. This will give a temporary improvement but the betterment will be short-lived and there is much greater danger of completely burning out whatever thorium remained in the filament wire.

Testing Emission.—Before a tube is put through the restoration process its filament emission should be tested and this test should again be made after the process is completed so that the condition of the filament may be known with some degree of certainty.

The emission test is made with apparatus shown in Fig. 2. The tube is inserted in a socket whose filament terminals are connected through a rheostat to a battery. A direct current voltmeter reading

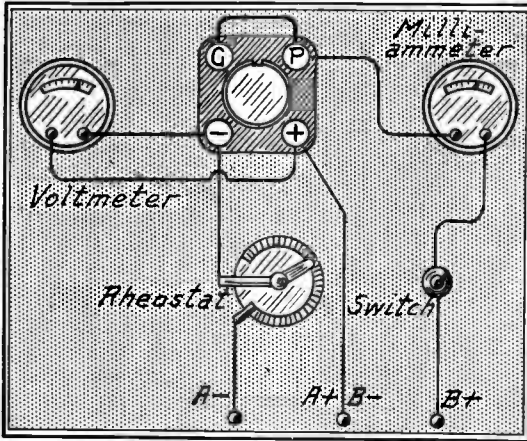

FIG. 2.—Filament Emission Tester Used in Tube Restoration.

slightly higher than the normal filament voltages is connected across the socket filament terminals. The plate and grid terminals are joined together and connected to one side of a milliammeter reading slightly higher than the maximum plate current output of any tube to be handled. The other side of the milliammeter is connected through a switch to the B-battery terminal.

A storage battery giving normal filament voltage for the tube being handled is connected to the terminals on the tester and a B-battery giving voltages specified in the following table is connected to its proper terminals. No other voltages than those named should be employed in the emission test.

The milliammeter switch is left open, the tube is placed in the socket and the filament voltage adjusted to the specified value. The switch is then closed just long enough to get a reading on the milliammeter and is immediately opened again. When the switch is closed there will be a change in the filament current but this may be disregarded. If the emission as shown by the milliam-

TUBE, SCREEN GRID TYPE

meter is equal to or above the amounts specified in the following table the tube is in good condition and does not require restoration. After the restoration process has been applied this emission test should be used to check the success of the work. If the emission does not come up to standard after restoration, the ageing voltage for restoration should be again applied and continued for an hour or more.

Care should be used not to continue the emission test any longer than absolutely necessary to obtain a reading on the milliammeter. Keeping the switch closed will cause the emission to drop and this indicates that the tube is suffering harm. Before applying the emission test it will be advisable to test the tube for short circuits between the elements; filament, grid and plate. A short will burn out the filament instantly.

The following table shows the correct voltages to be applied in the emission test and shows the minimum current which should be shown on the milliammeter if the tube is in good condition:

FILAMENT EMISSION OF TUBES

Type of Tube	Voltage Across Filament	B-battery Voltage on Grid and Plate	Minimum Satisfactory Emission—Milliamperes
199, 299, DV-3, etc.	3.3	50	6
120, 220, etc.	3.3	50	15
201-A, 301-A, DV-2, DV-5	5.0	50	25
171, 371, etc.	5.0	50	50
210, 310, etc.	6.0	100	100
200-A, 300-A (detector)	5.0	50	12
213, 313, etc. (rectifier)	4.0	100	50*
216-B, 316-B, etc.	6.0	125	100

* per anode.

TUBE, SCREEN GRID, A. C. HEATER TYPE.—The screen grid tube is a vacuum tube of the amplifying type in which are the usual three elements; plate, grid and cathode, and in addition to these a fourth element in the form of a screen almost completely enclosing the plate.

The cathode and its heater are exactly like similar parts in the ordinary A. C. heater tube having three elements. Around the outside of this cylindrical cathode is a spirally wound control grid. The plate is a metal cylinder almost completely enclosed by a wire mesh screen. This mesh, called the "screen grid," is interposed between the control grid and the plate and also extends over the outside of the plate.

The screen is connected to a source of positive voltage, the amount of voltage thus applied to the screen having a very considerable effect on flow of plate current. The connection of the screen to a voltage source allows high frequency feed-back, which might pass from plate to control grid, to be grounded through the power supply. This feature reduces the effective grid-plate capacity to a maximum of only 0.01 micro-microfarad.

The construction of the two grids and the plate is shown by

TUBE, SCREEN GRID TYPE

illustrations under *Tube, Screen Grid, D. C. Filament Type*. The inner grid has all the functions of the grid in a three-element tube. All usual operating characteristics and the voltages for heater, plate and grids are given in tables under *Tube, Characteristics of*.

This tube fits a five-prong socket exactly like that used with the standard A. C. heater three-element tubes and illustrated in Fig. 4 under *Tube, Alternating Current Type*. The socket terminal used for the grid of the three-element tube here connects to the screen grid. The control grid connection is made to a metal cap on top of the bulb on the screen grid tube. The socket connections for plate, cathode and heater are the same for both types of tube.

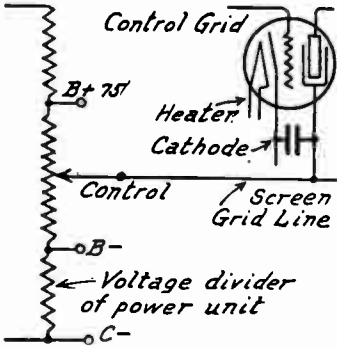

FIG. 1.—Screen Volts Control.

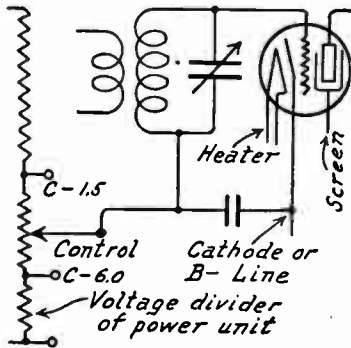

FIG. 2. Grid Bias Control

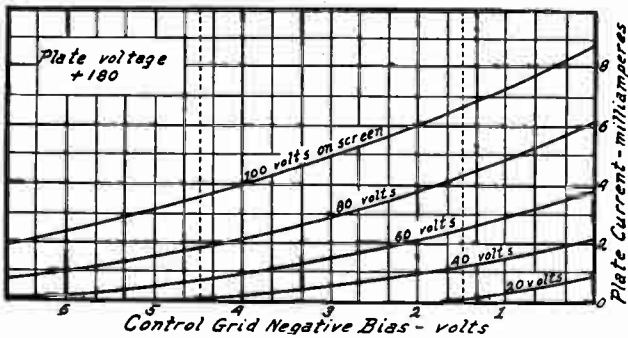

FIG. 3.—Effect of Grid Voltage on Plate Current.

The heater screen grid tube requires the same care in shielding the external circuits and in circuit isolation as explained for the filament type in the following section. Because of the heater feature it is necessary to provide adequate ventilation and air circulation in the shields.

Interstage coupling may be by means of tuned plate impedance as explained in the description of radio frequency coupling methods under *Tube, Screen Grid, D. C. Filament Type*. Coupling may also be secured through tuned radio frequency transformers having the primary and secondary windings closely coupled and having as many primary turns as can be used without causing oscillation.

TUBE, SCREEN GRID TYPE

Two of the most satisfactory methods for volume control commonly applied to radio frequency amplifiers using this type of tube are shown in Figs. 1 and 2. The method of Fig. 1 varies the positive voltage applied to the screen from zero to a maximum of 75 volts, the volume growing steadily greater as the screen grid voltage is raised. The method of Fig. 2 varies the control grid negative bias from a minimum of 1.5 volts to a maximum of about 6.0 volts, the volume growing steadily less as the bias voltage is increased. Either type of control is accomplished by potentiometer voltage variation.

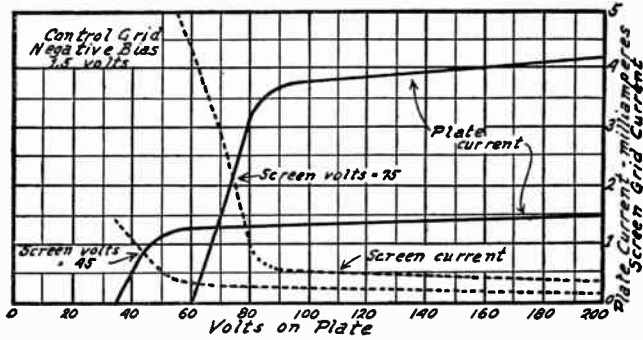

FIG. 4.—Effect of Plate Voltage on Plate and Screen Currents.

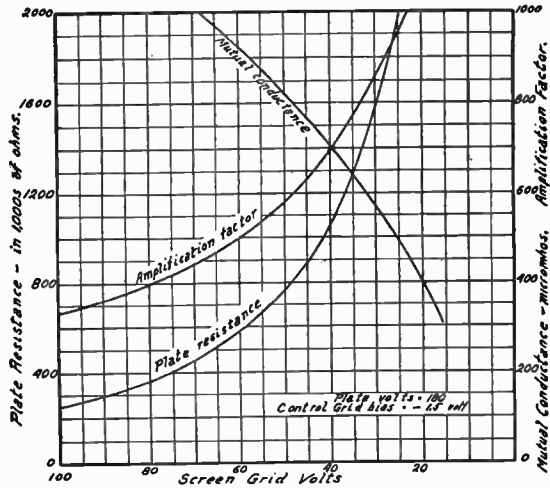

FIG. 5.—Effect of Screen Grid Voltage on Characteristics.

The effect of a changing grid bias on the plate current while maintaining a constant plate potential of 180 volts is shown in Fig. 3 for various values of screen grid voltage. The effect of a changing plate voltage on the flow of plate current and on the flow of current in the screen grid circuit is shown in Fig. 4 for voltages of 45 and of 75 on the screen grid. The negative control grid bias is 1.5 volts in both cases of Fig. 4. It will be seen that increase of plate voltage above the value where the curves bend has but

TUBE, SCREEN GRID TYPE

little effect in further increasing the plate current. For example, with 75 volts on the screen, almost the whole change of plate current occurs below a plate voltage of 100.

The effect of a changing screen voltage on the plate resistance, on the amplification and on the mutual conductance of the tube is shown in Fig. 5 for a plate voltage of 180 and a negative bias on the control grid of 1.5 volts. The effect of a changing control grid bias on the same three characteristics is shown in Fig. 6 for a plate voltage of 180 and a screen voltage of 75. The data for all graphs is adapted from publications of the *E. T. Cunningham Company*.

Screen Grid Power Detector.—The screen grid tube may be used as a grid bias or plate rectification detector by applying suitable screen and control grid biasing voltages. The voltages employed depend on the strength of the applied signal and on the

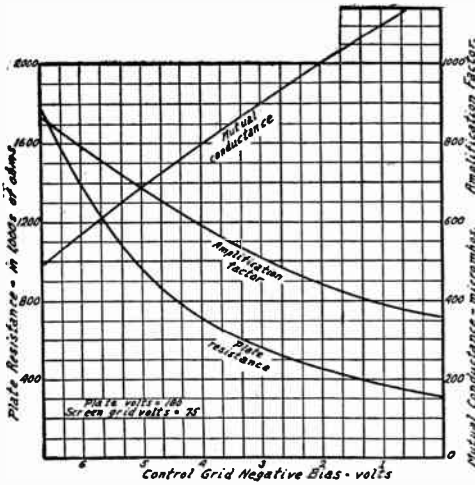

FIG. 6.—Effect of Grid Voltage on Characteristics.

amount of audio frequency amplification used between the detector and the power tube. For small applied radio frequency signals and one stage of audio frequency between detector and power tube it is satisfactory to use 35 volts on the screen with a control grid bias of 3.5 volts or to use 45 volts on the screen and a bias of 4.5 volts negative. For stronger input signals, power detection with no intermediate audio stage between detector and power tube it is satisfactory to use 75 volts on the screen and a control grid bias of 7.5 volts negative. A plate potential of 180 volts is applied for all these cases.

A complete receiving circuit for screen grid tubes is shown in Fig. 7. This arrangement consists of one radio frequency amplifying tube with a tuned grid circuit and a tuned transformer coupling

TUBE, SCREEN GRID TYPE

into the screen grid detector. The detector is coupled to the power tube through a choke and resistor impedance.

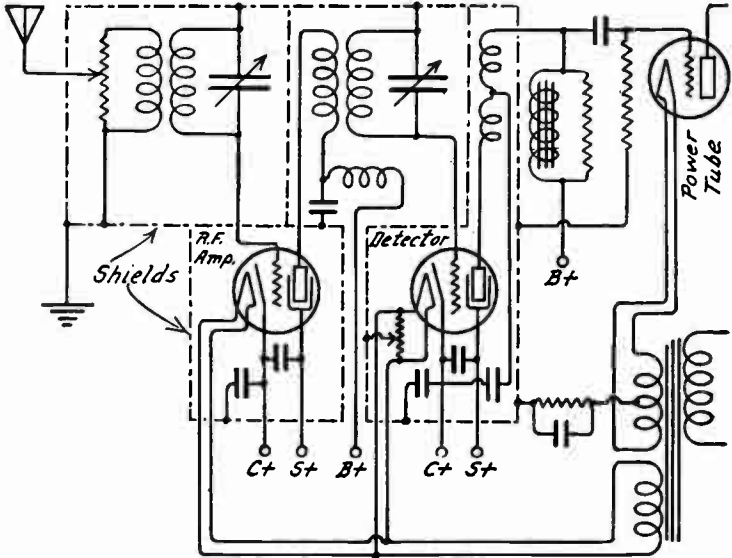

FIG. 7.—Screen Grid Amplification and Detection.

TUBE, SCREEN GRID, D. C. FILAMENT TYPE.—

Screen grid tubes for direct current filament supply are similar in general operating characteristics to the A. C. heater type previously described. Instead of the heater and separate cathode used in the A. C. tube, the heated filament here acts as the cathode. This is the chief constructional difference between the types.

The internal construction of one such tube is shown in Fig. 1. The filament here consists of a single strand placed vertically and supported at top and bottom. Around the filament is a coiled wire grid called the inner grid. In appearance this inner grid is similar to the corresponding part in a three-element tube. The plate is cylindrical, of rather large diameter, and surrounds the inner grid and filament. The outer grid, which is the fourth or added element, consists of two close-wound coils of wire. One coil is placed inside the plate, between the plate and the inner grid. The other coil is around the outside of the plate. The two coils of this outer grid are joined together at the top by a flat disc of metal. The plate is thus screened, both inside and outside, by the outer grid.

The base of this tube has four prongs or pins exactly like those on a three-element tube. The two larger prongs connect to the

TUBE, SCREEN GRID TYPE

filament. The smaller prong occupying the same position as the plate prong in the older types of "A" tubes connects to the plate in this new tube. The remaining terminal on the base, which occupies the same position as the grid terminal in the older tubes, connects to the screen or outer grid. The inner grid, which surrounds the filament, is connected to a metal cap on top of the glass bulb of

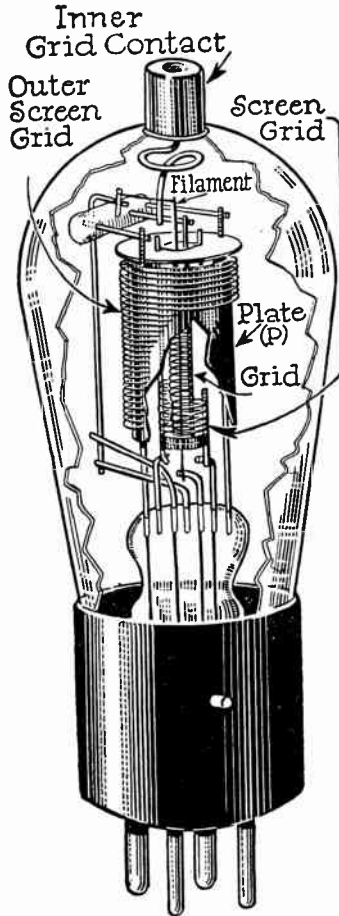

Fig. 1.—Internal Construction of a Screen Grid Tube.

this tube. This cap serves as a terminal for the inner grid connection.

This tube is suited for use in two distinctly different ways, one of which is a screen grid unit, having great voltage amplification and very small internal grid to plate capacity. It is sometimes used

TUBE, SCREEN GRID TYPE

as a space charge grid tube having very low internal resistance, high amplification factor and consequent high mutual conductance. Either the screen grid or the space charge method may be employed in amplification.

This tube may also be used in various other ways, some of which are mentioned under the heading *Tube, Four Element Type*. The screen grid and the space charge methods are of greatest importance in broadcast reception and will be explained here.

Space Charge Grid.—The amplification of an ordinary three-electrode vacuum tube is limited by the space charge. This space charge consists of a quantity of negative electrons or particles of negative electricity which remain close to the hot filament and oppose passage of other electrons from filament to plate. The whole subject of space charge action is explained under *Tube, Action of*.

In a four-element tube using the space charge method as at the left in Fig. 2 the outer grid is used as a control grid, functioning in the same way that the single grid functions in the three-element tube. The inner grid, close to the filament, is then given a strong positive voltage which will almost completely neutralize and do away with the space charge which would otherwise exist around the filament.

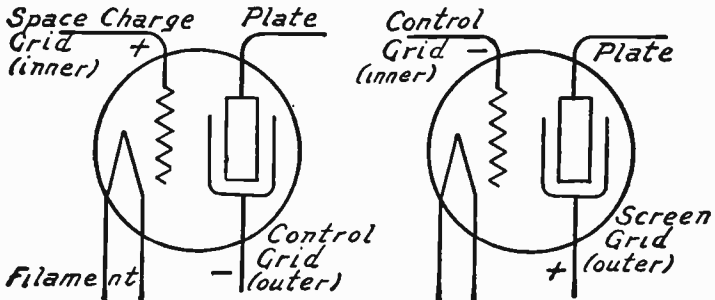

Fig. 2.—Tube Used With Space Charge Grid At Left and With Screen Grid At Right.

The negative electrons which would form a space charge are attracted to the positively charged inner grid, are thus carried out of the way and returned to the filament circuit. This leaves a comparatively free path for the electron stream attracted by the plate. The electrons on their way to the plate must pass through the outer grid which surrounds the plate and which is used as the control grid. This electron stream passing to the plate is therefore controlled by changes of signal voltage on the control grid and the tube operates as an amplifier or detector in the usual way. Reduction of the negative space charge by the inner grid allows a flow of electrons to the plate which is far in excess of anything possible in the three-element tube.

Screen Grid.—The word “screen” as here used means the same as the word shield. When used in this manner the tube may be called a shielded plate tube since one of the chief purposes of the outer grid is to provide a shield around the plate. The words “screen grid” mean that the extra grid acts as a screen around the plate. The grid does the screening or shielding, while the plate is

TUBE, SCREEN GRID TYPE

the part screened or shielded. Hence the two names for the one idea.

Used as a screen grid amplifying tube as at the right in Fig. 2, the inner grid, connected to the top metal cap, is the control grid and functions in the same manner as the grid in a three-element tube. The outer grid, which surrounds the plate and is attached to one of the base prongs, is used as a screen or shield and takes no part in the action ordinarily associated with a grid in the older types of tube. The action of this tube will be more easily understood by calling the inner grid simply the grid and by calling the outer grid a screen, thus naming the four elements as follows: filament, plate, grid and screen.

One of the most troublesome features of a three-element tube used as a radio frequency amplifier is the internal capacity between the grid and plate, this being explained under *Tube, Capacities, Internal*. This internal capacity limits the amplifying ability of the tube because beyond a certain point the feedback from plate circuit to grid circuit through the tube produces oscillation in the circuits. It is the purpose of the various methods described under *Balancing* to compensate for this internal feedback and thus to allow greater amplification without danger of oscillation.

The screen between the plate and grid in the four-element tube greatly reduces the internal capacity effect, tends to prevent the troublesome feedback and allows a degree of amplification more nearly dependant on the amplification factor of the tube and the characteristics of the external circuits without the added effect of an internal feedback. When used in this manner the effective voltage amplification of the four-element tube is from two to five times as great as the effective amplification of the three-element tube when used in a radio frequency amplifier. Whereas the amplification factor of the three-element tube is usually about eight for the types employed in radio frequency circuits, the maximum amplification factor of the four-element tube is in the neighborhood of two hundred. It is not possible to build external coupling apparatus which will allow the full ability of the four-element tube to be realized in practice. This limitation is due to the fact that voltage amplification depends not only on the amplification factor and plate resistance of the tube but also on the impedance of the external circuit as explained under *Tube, Amplification of*.

The shielding effect of the screen prevents feedback from plate to grid in the same way that ordinary external shielding will prevent feedback or coupling between coils, condensers and other circuit elements generally shielded in modern receivers. The screen is connected to a battery or power unit and through this part to the negative or ground side of the circuits, thus interposing a grounded shield between plate and grid in the tube.

In addition to the shielding function the screen grid with its positive voltage has other important effects in the tube's action. The positive charge of the screen reduces the space charge in the tube, although not to such an extent as when the inner grid is used for space charge reduction. The positive charge on the screen assists in attracting toward the plate electrons emitted from the filament or assists the plate to a certain extent. Change in the voltage applied to the screen affects the plate current if the plate voltage remains fixed, increase of screen voltage increasing the plate current and vice versa. Therefore, it may be said that the screen

TUBE, SCREEN GRID TYPE

voltage controls the plate resistance of a tube within certain limits.

The virtual elimination of the plate to grid capacity within the tube and the reduction of internal feedback makes it less necessary to balance or neutralize the radio frequency circuits. With proper shielding, correct construction and operation there is greatly reduced danger of oscillation. One of the real advantages resulting from this condition is that a receiver with one or more stages of screen grid radio frequency amplification will not re-radiate and will not affect nearby receivers unless excessive regeneration or oscillation is introduced into the detector circuit.

Operating Voltages.—The filament is rated to operate at 3.3 volts and with this voltage applied it will draw 0.132 ampere of current. Satisfactory operation will be obtained at any filament voltage between 2.7 and 3.3.

The plate voltage may be anywhere between 90 and 135 for operation as a screen grid radio frequency amplifying tube. Some types of control make it necessary to use less than 90 volts. As a space charge grid amplifier the plate voltage may be anywhere between 135 and 180 volts when used with a coupling resistance of 100,000 to 250,000 ohms in the plate circuit. Plate voltage at the tube terminals will be considerably lower, usually ranging between 60 and 100 volts.

When the tube is used as a screen grid amplifier the outer grid is the screen and the inner one is the control grid. Usual practice gives the outer or screen grid (connected to the base prong) a positive voltage of 45 with respect to the negative end of the filament. This voltage is not critical and any value between 30 and 50 will be satisfactory unless this voltage is used as a regeneration control. The inner grid connected to the top cap on the bulb is now the control grid and is given a negative bias of from one to two volts.

With the tube used with a space charge grid, usually as an audio amplifier or detector, the inner grid, connected to the top metal cap, controls or lessens the space charge and is given a positive voltage between 20 and 25 under normal conditions. The outer grid, connected to the base prong, is now the control grid and is given a negative bias between zero and two volts, depending on the type of circuit being employed.

Grid Biasing.—If this tube is operated from three dry cells for filament current the connections at the left in Fig. 3 are used and the negative grid bias is secured by connecting the grid leak or grid return to the negative terminal of a $1\frac{1}{2}$ -volt C-battery of which the positive end is connected to the negative filament terminal of the tube.

If the tube is operated from a six-volt source, such as a storage battery, the connections are made as at the right in Fig. 3. Two resistors or two rheostats are connected between the negative side of the source and one of the filament terminals of the tube. The voltage drop across resistor *A* is applied to the tube as a negative bias by connecting the grid return or grid leak to a point between the resistors. Resistor *B* furnishes the addi-

TUBE, SCREEN GRID TYPE

tional voltage drop to allow only a normal filament voltage to be applied to the tube.

In many cases the receiver will use also five-volt tubes and the screen grid tube may then be supplied with filament current from any five-volt line with the same connections shown at the right in Fig. 3. With a five-volt source resistor *A* should have ten ohms resistance, the same as before but resistor *B* should have only five ohms to allow normal filament voltage at the tube.

It is possible to operate two screen grid tubes from a six-volt source by connecting their filament in series, thus applying three volts to each one. It is then necessary to use a separate C-battery with each tube in order to provide the grid bias. This makes the resistor system of Fig. 3 more desirable since there are no batteries to be cared for.

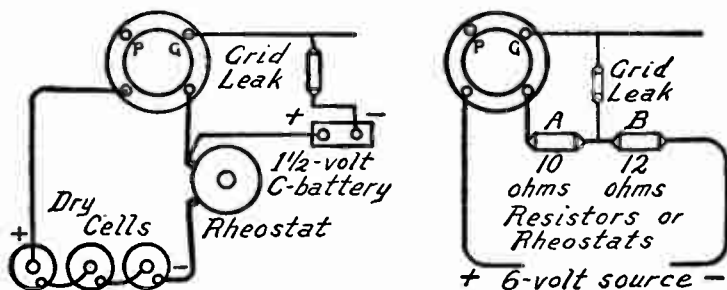

Fig. 3.—Dry Cell Filament Supply At Left and Storage Battery Supply At Right.

Radio Frequency Coupling Methods.—In order to obtain maximum possible amplification from these four-element tubes with their high plate resistance it is necessary to provide the greatest possible impedance in the plate circuit because this output impedance is a factor in the overall amplification. Good results from this standpoint are secured with some form of tuned impedance coupling such as described under *Amplifier, Radio Frequency, Tuned Impedance Coupled*. The objection to this coupling, its liability to oscillation, is lessened by the reduction of effective feed-back capacity in the screen grid tube.

The tuned impedance may consist of a variable tuning condenser and fixed coil or else it may consist of a variable inductance or variometer with or without a fixed condenser.

The characteristics of impedance coupling are such that condensers of average construction must have at least .0005 mfd. maximum capacity in order to cover the broadcast band in tuning. A condenser as small as .00025 mfd. capacity will fail to reach much above a frequency of 1,000 or 1,100 kilocycles corresponding to wavelengths of 300 or 275 meters when used with a coil of such proportions that the combination will reach the other end of the broadcast band at 550 kilocycles.

The coils used in the impedance couplers will usually require somewhat less than the number of turns specified for various form diameters and wire gauges given in the tables under *Coil, Tuning, Sizes Required for*.

Variable inductance tuning with the variometer coupling shown in Fig. 4 will give a tuning range more satisfactory than any except the larger capaci-

TUBE, SCREEN GRID TYPE

ties of condensers used with fixed inductance coils. A variometer of the type made for tuning will cover the entire broadcast band from 550 kilocycles to 1,500 kilocycles when used with a fixed condenser of very small capacity across its terminals. This fixed capacity across the variometer will generally be of the order of .00005 mfd. capacity although this depends entirely on the maximum inductance of the variometer itself. Small condensers of the balancing type will usually be suitable in this position.

The variometer will generally give greater amplification and greater range of tuning on the dials than the variable condenser, but will be somewhat less selective than a variable condenser and coil. A choice may be made between the advantages and disadvantages of the two methods.

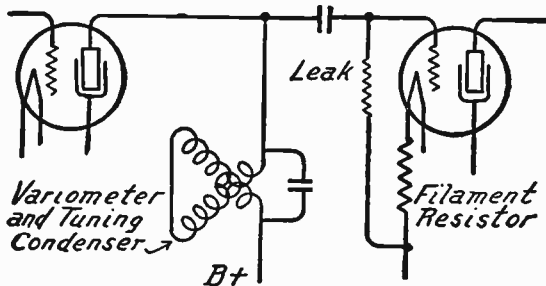

Fig. 4.—Variometer Tuned Plate Circuit.

The coupling condensers between the plate lead of one tube and the control grid of the following tube should be of .00025 mfd. capacity throughout the receiver. The best value for the coupling condenser next the detector control grid is the value mentioned and in order to have all stages tune at approximately the same settings for any one frequency, all other coupling condensers should be of the same value.

Increasing the capacity of the coupling condenser allows the plate and grid circuits to have greater effect on each other, tuning at a lower setting with less capacity or inductance for a given frequency. A larger coupling condenser will give slightly greater volume but will somewhat reduce the selectivity because of the closer coupling. The larger coupling condenser is not warranted, all things considered.

The grid leak should have at least two megohms resistance and a still higher resistance will increase the amplification because it helps to raise the impedance of the tube's output circuit. Less resistance in the grid leak makes the circuit more stable and allows greater use of a regenerative control without liability of oscillation. The smaller resistance reduces the amplification of the tubes.

With tuned impedance coupling the tuning inductance is in the high voltage plate circuit. With the tuning condenser connected directly across the ends of the inductance the condenser rotor, from which a shaft often extends through to the tuning dial, is at this high voltage. This condition is undesirable and may be avoided by using the method shown in Fig. 5.

TUBE, SCREEN GRID TYPE

The inductance is connected to the plate voltage supply as usual and is also connected to the shield through a bypass condenser which should have a capacity of .006 mfd. or more. The stator of the tuning condenser is connected to the plate end of the tuning inductance and the rotor is connected directly to the shield. This latter connection is generally made simply by mounting the condenser on the shield. The tuned oscillatory circuit formed by the inductance and tuning condenser is completed through the shield and the bypass condenser. No high voltage direct current can pass to the rotor of the tuning condenser because of the interposed bypass condenser. The bypass condenser and the tuning condenser are in series in the tuned circuit and the capacity of the circuit will be somewhat less than the capacity of the tuning condenser alone. The greater the capacity of the bypass condenser the less will be the reduction of total capacity in the circuit.

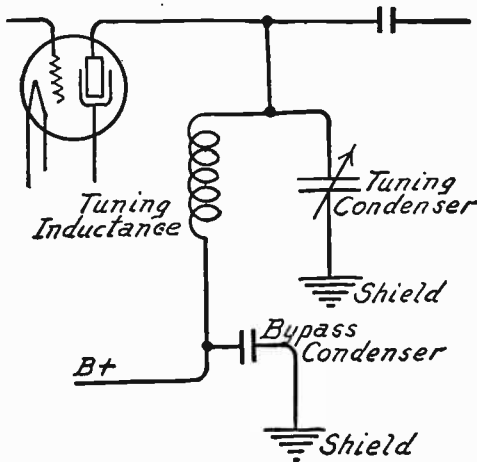

FIG. 5—Connections Allowing Grounded Condenser Rotor.

Unless this plan or an equivalent one is used the rotor of the tuning condenser must be insulated from the shield on which it is mounted. With variometers of usual construction the tuning shaft is electrically connected to the windings and cannot be insulated. With such a variometer its mounting to the shield must be made through insulating material. This may be accomplished by attaching a piece of panel material to the variometer mountings and then attaching this insulation to the shield, taking care that no screws passing into the variometer parts can touch any part of the shield.

The circuit of Fig. 6 differs somewhat from the usual arrangement for tuned impedance and makes a satisfactory method of interstage coupling for use with screen grid tubes. The plates of the two amplifier tubes shown receive their positive potentials through the choke coils in the line running to the plate supply. The tuned circuit, here consisting of a coil and condenser, is coupled to the plate through the coupling condensers *C*. The tuned circuit then connects on one side directly to the grid of the following tube and on the other side to the filament circuit of that tube for a grid return. The high voltage direct current of the plate supply is pre-

TUBE, SCREEN GRID TYPE

vented from entering the tuned circuit by the coupling condensers and both coil and condenser of the tuning element are connected to ground or to the shield.

The drawing of Fig. 6 shows the two screen grid radio frequency amplifier tubes and the detector tube which is an ordinary amplifying type of one of the special detectors on the market, not of the screen grid type. The lower ends of the tuning elements are connected to the shield and the filament circuit on its negative side connects to the shield through the resistors *F* in which the voltage drop provides the necessary negative grid bias. Resistor *R* is the usual grid leak. The chief purpose of the chokes is to force the radio frequency voltages through the coupling condensers *C*. To prevent undesired coupling from and between these chokes they are carefully and completely shielded. These chokes should have but little distributed capacity to ground. Honeycomb coils of 750 or more turns are satisfactory in this position.

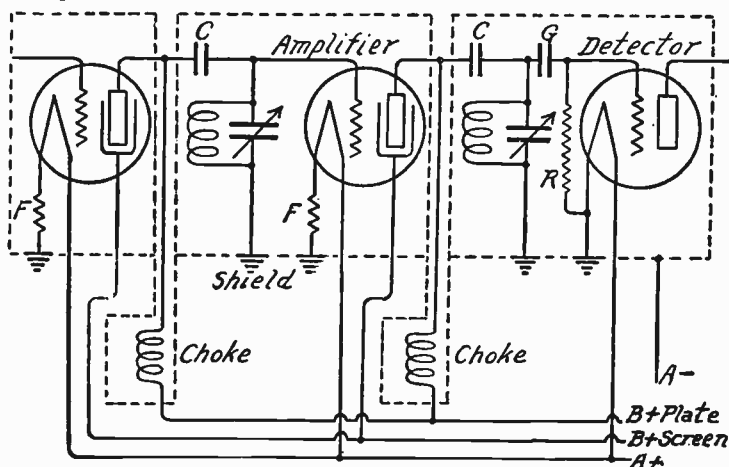
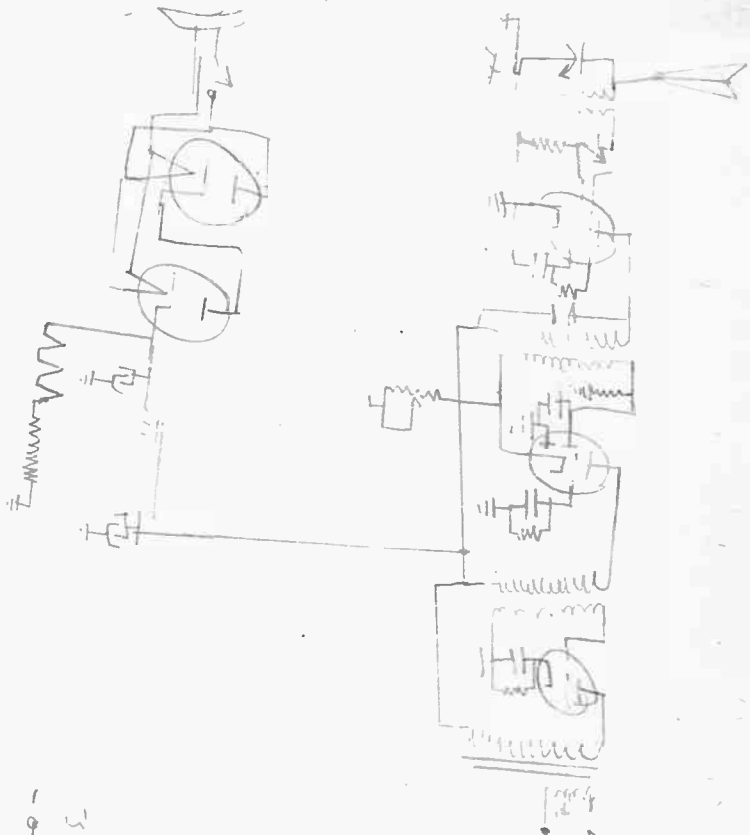

Fig. 6.—Connections for Tuned Grid Circuit.

With this arrangement the tuned circuit is freed from all direct current and is of low resistance but high impedance because of the direct connections made at both high and low potential ends. A complete radio frequency amplifier using this plan with variometer tuning is shown under *Receiver, Screen Grid Type*.

Selectivity.—The great amplification of radio frequency stages using screen grid tubes makes the selectivity seem poor. Nearby stations come in with such volume that they are usually heard quite plainly some little distance off their resonant settings on the tuning dials. This effect is compensated for to some extent by the correspondingly great volume of distant stations which makes the background noises of less consequence than under ordinary conditions.

Tube noises and noises from poor circuit connections may be bothersome. Static is not as noticeable as with tubes having less



TUBE, SCREEN GRID TYPE

radio frequency amplification because the signal is brought up to a greater extent than the outside interference.

Once built, the tuned plate or grid circuits of the radio frequency tubes allow no control or variation of selectivity. Since the coupling is made quite close for maximum transfer of power from stage to stage, the selectivity of this part of the receiver is poor. Good tuning condensers and tuning coils or good variometers designed and built with every regard for high efficiency and low radio frequency losses make these stages as selective as possible. Such methods of construction are described under *Coil, Design of*.

Selectivity may be gained at the detector end of the radio amplifier by using regeneration. It may also be gained at the antenna coupling end in several ways. Complete and careful shielding of tuning elements and connections in grid and plate circuits will greatly reduce the trouble from nearby stations interfering with distant reception. Complete isolation of the circuits by means of choke coils will also assist materially in this respect.

Antenna Circuit.—The greatest gain in selectivity may be made in the antenna circuit when any fixed type of coupling is used between other stages. This selectivity will be gained at the expense of volume, but since there is ample volume because of the high amplification this is not such a disadvantage as it appears.

It is possible to use extremely loose coupling between the antenna circuit and the first tuned circuit which feeds the grid of the first radio frequency tube. Adjustable coupling at this point is advisable, although the adjustment need not be brought out to the control panel of the receiver. The device shown under *Coupler, Variable* is satisfactory and may be set at the position giving the most satisfactory combination of selectivity and sensitivity for the receiver's location. If the antenna coupler is of the fixed type it may have three to five turns of antenna winding spaced between a half inch and one and one half inches from the filament end of the grid coil or tuned coil. The final position of this antenna winding will again depend on local conditions and the nearness of broadcasting stations.

A receiver with two stages of radio frequency amplification using screen grid tubes will give good results up to moderate distances without an antenna. The ground connection may then be made to the antenna post. No connection, other than to the filament supply, is made to the regular ground post of the receiver.

Under most conditions a tuned antenna circuit is of advantage. The method using a variometer shown under the heading *Antenna, Tuned* is one of the most satisfactory. The small coil through which coupling is made to the first tuned stage need have but one or two turns. This method adds still further to the sensitivity or power of the receiver and with careful tuning of the variometer will not appreciably reduce the selectivity. Under the heading *Antenna, Coupling of* is shown a separate coupling coil which does not add an additional control and which will give very good results in increasing the selectivity.

Shielding of External Circuits.—The importance of thorough shielding can hardly be overemphasized. Partial shielding, such as

TUBE, SCREEN GRID TYPE

provided by partitions between stages is not effective. The shields enclosing the tuning elements of each stage must be enclosed in a tight box of copper, aluminum or brass, this box to have tightly joined corners and well fitting bottom and top.

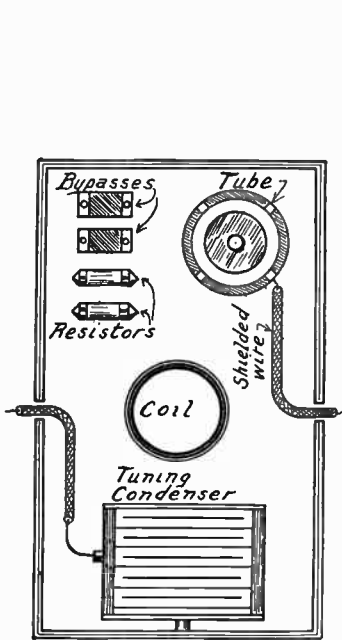

Fig. 7.—Parts Enclosed Within the Shield.

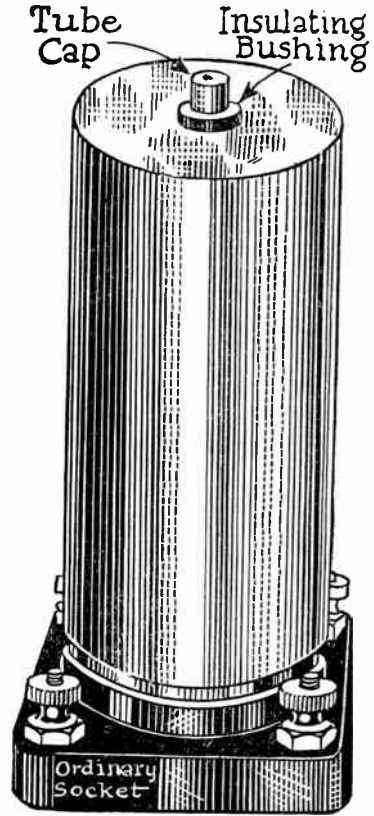

Fig. 8.—A Tube Shield.

Plate and grid wires passing out of these shields must be carried in metal sheaths which are metallicly connected to the shielding box. The holes through which these wires leave the box should be no larger than necessary to pass the wire's sheath. The sheaths on wires coming from outside units must extend at least to the metal box and on the outside should preferably be carried as close to their terminal connections on coils, condensers or variometers as possible with due regard to freedom from short circuiting at the ends. The wire sheaths should be carried as closely as possible to the grid and plate terminals on the tube socket.

The parts enclosed within one shielding box will include the tuning condenser and coil or else the tuning variometer and its condenser, whichever may be used. The following tube, to which a control grid connection is made, may also be enclosed with the same box. The plate lead from this

TUBE, SCREEN GRID TYPE

tube will then run directly out of the shield and into the following stage shield as in Fig. 7.

The box shields may be metallicly connected to ground or else connected only to the filament supply, battery or power unit, depending on the circuit employed for antenna and ground.

When this tube is used as a radio frequency amplifier screen grid tube and is mounted outside the shield which encloses the tuning elements, the tube itself must be enclosed with an individual shield as in Fig. 8. This shield may fit closely or loosely around the body of the bulb. It must come down at least to the base of the tube and should preferably enclose most of the socket as well. An opening must be left in the top of this tube shield for the cap connected to the inner grid. There should be not more than one-sixteenth inch clearance between the edges of this hole and the sides of the metal cap on the tube and the opening must, of course, be bushed with insulating material to prevent shorting the inner grid on the tube shield.

With the tube enclosed in a separate shield, this tube cover should be metallicly connected either to one of the shielding boxes, to one of the filament terminals on the tube socket, or to a circuit which is grounded. Without some such connection the liability of oscillation is increased.

If the tube is enclosed within the same shield containing the tuning unit it is not necessary to provide the tube itself with a separate and individual shield. However, the control grid lead and the plate lead should then be well separated. The control grid lead may well be carried in shielded wire with the shield grounded. The plate lead should always be carried in a shielded wire and should pass as directly as possible out of the large enclosing shield for the stage being considered, thus avoiding chances for coupling between these two leads.

It is of the greatest importance to completely shield the plate and grid circuits of a tube from each other. The plate circuit extends from the plate terminal of the tube to a coupling condenser or to the tuning or coupling combination in the plate or grid circuit and may include those units. The grid circuit extends from the control grid terminal at the top of the tube back to the coupling condenser and to the grid leak if used.

Regeneration and Volume Controls.—It is always desirable to use some kind of volume control. To prevent blocking of the detector tube this control is preferably in the radio frequency stages or in the detector stage. Some form of regeneration control will not only do this but will, at the same time, make the whole receiver more selective. One of the most satisfactory methods of obtaining regeneration control is that shown in Fig. 9 where a variometer is placed in the radio frequency plate bypass of the detector. From the plate of the detector come audio frequency current changes which are passed through the radio frequency choke coil to the audio amplifying stages but which are repelled by the plate bypass condenser. From the detector come also radio frequency currents which are ordinarily bypassed to the filament circuit through the plate bypass condenser. In the control shown, this plate bypass condenser does not attach directly to the filament circuit but leads first through the variometer of which the other

TUBE, SCREEN GRID TYPE

side is connected to the filament circuit. This provides the detector with a tuned plate circuit and gives excellent control. Since the direct plate current and low frequency audio currents do not pass through the variometer it has very little effect on the tuning in the stage preceding the detector and the receiver may be logged with little regard to variometer position.

Under the heading of *Regeneration, Methods of Obtaining* will be found a number of plans which may be utilized with screen grid radio frequency amplifiers. The methods employing a fixed tickler winding controlled either with an adjustable resistance or an adjustable condenser are most satisfactory, the tickler coil being placed close to or on the same form with the inductance in the stage preceding the detector tube. The fact that screen grid amplification reduces the natural oscillation tendencies found in other tubes makes it advisable to use some method which adds regeneration to a stable circuit rather than methods which are designed to reduce or prevent the oscillation which naturally occurs in other types of amplification. It is not necessary to shield a variometer or other device in the plate circuit of the detector tube. Tickler coils coupled to the inductance preceding the detector will, of course, be shielded.

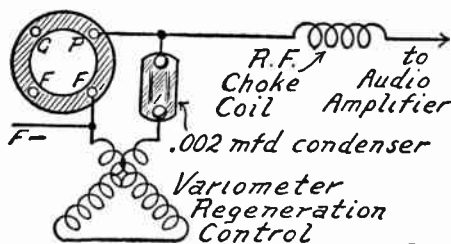

Fig. 9.—Regeneration With Variometer in Detector Plate Circuit.

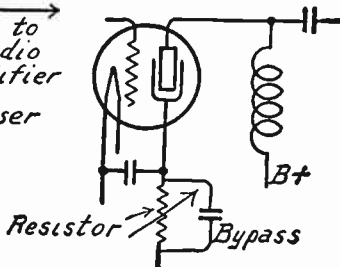

Fig. 10.—Control of Screen Grid Voltage.

Almost regardless of the care used in shielding and in isolation of circuits there will be a certain feedback provided the amplification becomes great enough and this feedback may be used to produce regeneration and oscillation. Variation of the positive voltage on the screen grid may be used as a regeneration control because of these facts. As in Fig. 10 a variable resistance of 200,000 ohms maximum value is placed in the lead from the screen grids to the voltage source. This apparently high resistance is required because of the very small current in this circuit, there being but little drop of voltage per ohm with the small current. Lessening this resistance increases the voltage on the screen grid and raises the amplification, finally producing oscillation if carried far enough.

This arrangement makes a fairly effective control of regeneration and volume. The better the general construction and the more complete the shielding and isolation of circuits the less effective is such control of screen voltage. It does not give as smooth a control as does the regenerative system described, having a tendency to allow oscillation which requires a considerable change of resistance to stop, after which another corresponding

TUBE, SCREEN GRID TYPE

change of resistance is required to again obtain maximum regeneration without oscillation.

Plate voltage variation forms still another method for controlling volume and regeneration. A variable resistor of 50,000 to 100,000 ohms maximum value is connected between the power supply for the radio frequency plate voltage and the receiver connections leading to the couplers in the plate circuits. The connection is shown in Fig. 11. Good results will be obtained with only ninety volts applied to this plate circuit since variations of plate voltage in this region cause greater changes of plate current than equal variations at higher voltages. The variable resistor should be bypassed with a one microfarad condenser as shown.

Increasing the plate resistance will lower the voltage and reduce volume while lessening the resistance will raise the voltage, increase volume and bring about regeneration. This makes a simple and satisfactory control for both nearby and distant stations.

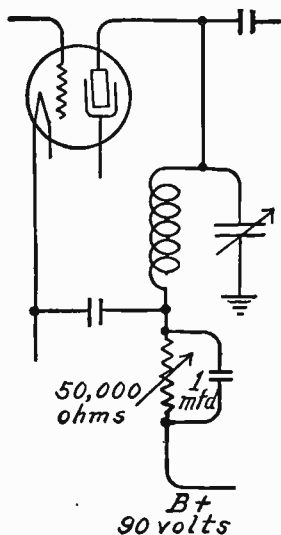

Fig. 11.—Control of Plate Voltage.

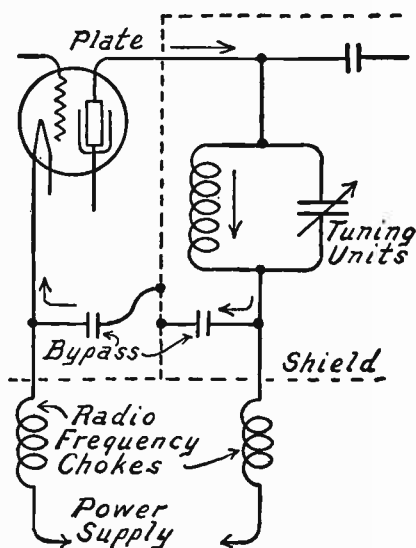

Fig. 12.—Choked and Bypassed Plate Circuit.

Variation of filament voltage and current forms another simple, yet satisfactory control of volume and regeneration. This plan is used in one of the amplifiers shown under *Receiver, Screen Grid Type*. The values of the fixed resistors used for grid bias at the tubes and of the fixed resistor in series with the variable rheostat are chosen to make it impossible to apply excessive filament voltage regardless of the position of the rheostat.

Moving the rheostat to its position of least resistance gives maximum amplification and regeneration. Movement of the rheostat to such a point that the filament voltage is reduced to 2.0 will make the strongest incoming signal just audible with two audio stages following two radio frequency stages.

TUBE, SCREEN GRID TYPE

Circuit Isolation.—Trouble may be encountered from feedbacks through the battery or power unit wiring leads and through a common battery or common power unit employed for several amplifying stages. Such trouble can be avoided with separate power sources for each stage, but in anything except experimental work such practice is out of the question. It may be found highly desirable to isolate the radio frequency circuits in the different stages by judicious use of radio frequency chokes and bypass condensers.

A plate circuit in which the radio frequency paths are isolated is shown in Fig. 12. From the plate terminal of the tube the path follows the arrows to and through the tuning coil and condenser, then through the bypass condenser to the shield, through the shield to the second bypass condenser, and through this condenser to the tube filament. The two radio frequency chokes prevent the radio frequency current from passing into the lines running to the power supply.

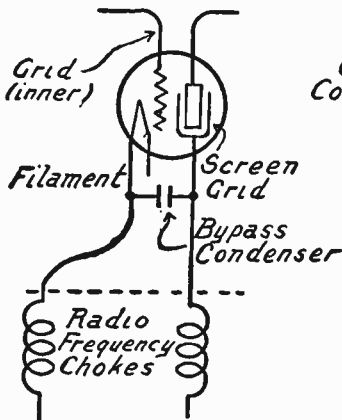

Fig. 13.—Choked and Bypassed Screen Grid Circuit.

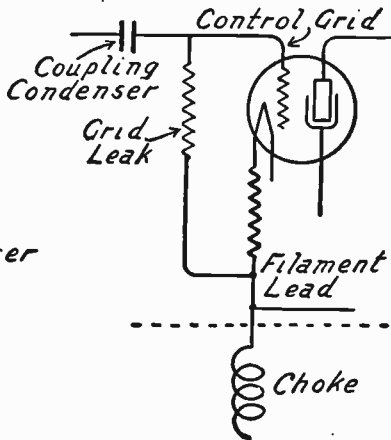

Fig. 14.—Control Grid Circuit.

In Fig. 13 is shown an isolated screen grid circuit. Radio frequency currents pass from the screen grid through the bypass condenser to the filament line but are unable to reach the outside circuits because of the chokes.

No special treatment of the control grid and the grid return circuits is required since they do not extend far beyond the tube and the filament circuit close to the tube terminals, this being indicated in Fig. 14.

Isolation of the filament circuit in and near the tube may be handled with iron-core choke coils as shown in Fig. 15. The wire on these chokes should be number 22 or larger with enamel, cotton or silk insulation. The core may be of one-quarter inch or greater diameter iron or mild steel rod. Using the iron core allows the choke to be effective with not more than two hundred turns of wire, while with an air core and such large wire the required number of turns would make the coil of ungainly size. The bypass condensers for the plate return and for the screen grid circuit must be connected to the filament lead on the tube side of these chokes since their impedance is so high that the radio frequency currents could not pass back to the filament were the returns made outside the choke.

TUBE, SCREEN GRID TYPE

All of the chokes and bypass condensers from Figs. 12, 13, 14 and 15 are combined in the one diagram of Fig. 16. Chokes 1 and 2 are of the iron core type for the filament circuit. Chokes 3 and 4 may be air core radio frequency types of usual design. They handle the screen grid and the plate circuits. Bypass condenser 5 connects the negative filament circuit to the

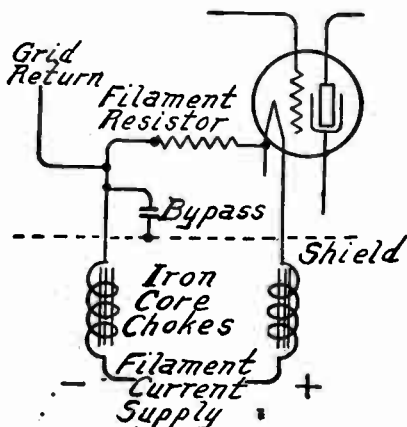

Fig. 15.—Choked and Bypassed
Filament Leads.

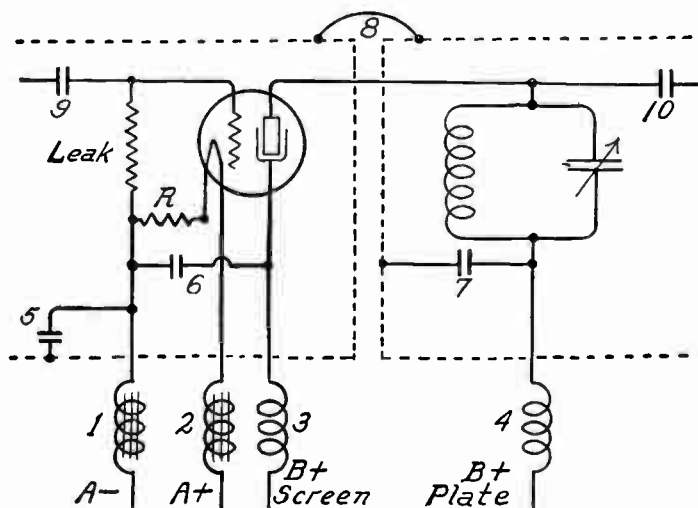

Fig. 16.—Grid Circuit In One Shield and Tuned Plate Circuit
In Following Shield.

shield. This condenser may well be of 1/10 mfd. capacity. Bypass condenser 6 completes the circuit for the screen grid back to the filament circuit. If more convenient this bypass may be connected to the shield. Bypass condenser 7 completes the plate return circuit back to the shield. This circuit then passes through the connection 8 from shield to shield,

TUBE, SCREEN GRID TYPE

through bypass 5 and to the filament circuit of the tube. Condensers 9 and 10 are coupling condensers between the plate and grid circuits of adjacent tubes. Resistor *R* is for biasing the grid return which is made through the leak.

Fig. 16 shows the tube and its grid circuit in one shield with the plate tuning units in the following shield, this being the customary arrangement with a tuned plate. In the shield containing the tube would be also a tuning coil and condenser for the preceding stage and in the shield containing the coil and condenser of Fig. 16 would be also the tube for the following stage. In Fig. 17 are shown all of the parts generally enclosed within one shield, which may be

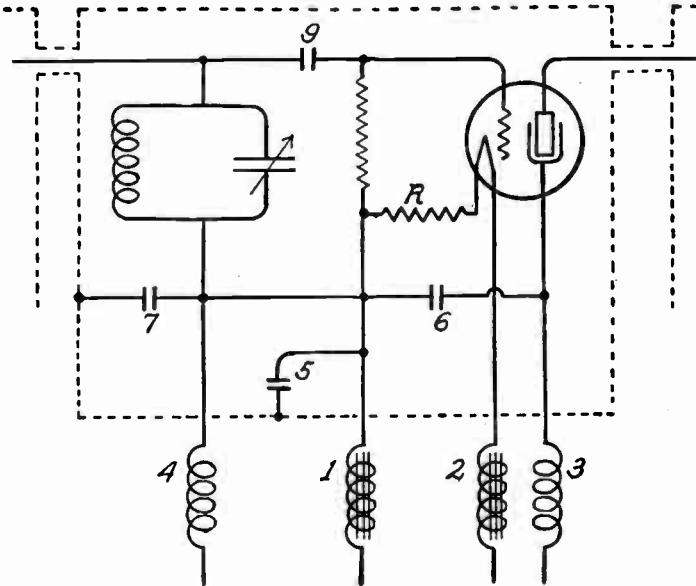

Fig. 17.—Plate and Grid Circuits Enclosed Within One Shield.

considered either as the one at the left or the one at the right hand side of Fig. 16. All of the bypasses and chokes are similarly numbered in Figs. 16 and 17. It is not necessary to connect the positive side of the filament to the shield through a condenser since all returns are brought to the negative side.

Such complete isolation of circuits as shown in these diagrams is not always resorted to. All of the chokes are sometimes omitted, although the plate choke 4 is desirable. If the filament chokes are omitted, the negative filament line between the filament grid biasing resistor and the lead to the current supply is grounded to the shield direct, the positive line being, of course, insulated from the shield. Bypass condensers 6 and 7, for the screen grid and plate respectively, should always be used regardless of other arrangements. Bypass condenser 5 is omitted when the negative line is grounded to the shield.

There will be some drop of voltage in the chokes for the filament leads

TUBE, SCREEN GRID TYPE

and this must be considered when making measurements for grid bias voltages.

After installing chokes and bypass condensers for the plate circuit, it is best to tune in a distant station and then try short circuiting across the terminals of the choke coil. If this allows a noticeable increase in volume or an improvement in tone quality it indicates that the bypass condenser for this circuit is too small and should be replaced with one of greater capacity.

Single Control.—Radio frequency amplifiers using screen grid tubes lend themselves well to single control of all stages following the antenna stage. More than two radio frequency amplifying stages are seldom used, consequently the first or antenna tuning device will be operated from one control and the two remaining tuning devices, one in the second radio frequency stage and the other in the detector stage, will be handled from the other control.

The slight broadness of tuning is an advantage when using single control. In tuning a two-stage screen grid amplifier with three variable condensers, movement of any one condenser, except that nearest the detector, by as much as one whole point on a dial with one hundred divisions will not greatly diminish the volume on a distant station. The tube capacity is so low that changing tubes will not noticeably alter the effectiveness of a single control on two stages.

With variometer coupling, using variometers of identical construction in all stages, it will be possible to make the several controls or stages tune close enough to the same settings so that single control may be employed for all stages after the antenna stage and including the detector stage. While tuned to a distant station near the center of the tuning range small variable condensers across the several variometers may be adjusted so that all tuning dials will have the same settings or so that, with one control for several variometers, the station is brought in with maximum volume. This indicates that all stages are in resonance to the received frequency and with all settings alike at this one frequency the settings will remain together for other frequencies provided the construction is identical in all parts of all stages.

All of the precautions and rules given under the heading *Control, Single* must be observed when adjusting this system of tuning. Otherwise it will be impossible to obtain resonance at the same settings on all tuning condensers or variometers at all points within the broadcast band. The initial setting should preferably be made on the lowest frequency to be received, this being 550 kilocycles or approximately 546 meters wavelength. Careful synchronization of all stages at this low frequency will almost always allow uniform tuning at all other points on the dial, assuming that all parts of all stages are alike and that all wiring is arranged in a similar fashion in all stages.

A slight adjustment of the settings for any one stage may be secured by variation of capacity in the coupling condenser between the plate circuit and the grid circuit. Increasing the capacity of this condenser will lessen the inductance or capacity required for tuning to a given frequency and will lower the dial reading while lessening the coupling condenser's capacity will increase the inductance required for tuning and will raise the dial reading.

Space Charge Grid Detector.—The four-element tube may be used as an efficient detector employing the space charge grid method

TUBE, SCREEN GRID TYPE

already described. The connections to the tube socket terminals, filament, grid and plate, are made in exactly the same manner as to any detector tube. The grid return is brought to the negative filament terminal of the socket. The usual plate bypass condenser of .001 or .002 mfd. capacity is connected between the plate terminal and the negative filament terminal of the socket. The metal cap on top of the tube, which is connected to the inner or space charge grid, is connected to a source of from twenty to twenty-five volts positive potential, this voltage serving to dissipate the space charge and allow increased amplification. This use of the tube as a detector is not particularly advantageous inasmuch as it is not especially designed for such work. The connections are shown in Fig. 18.

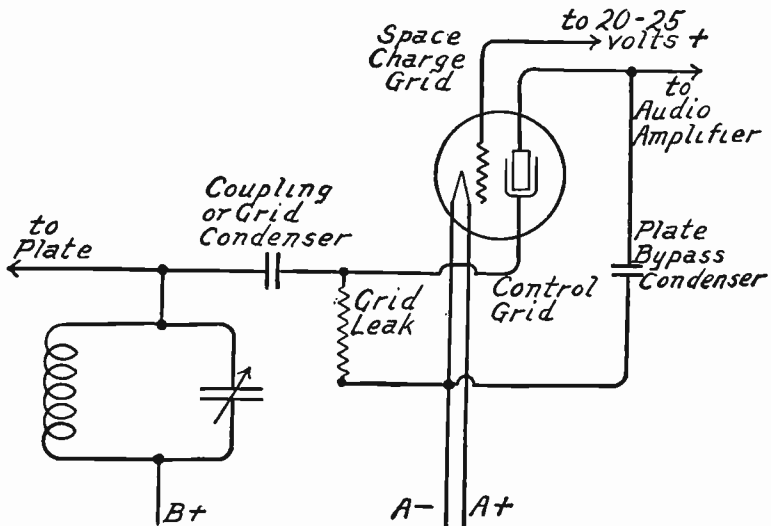

Fig. 18.—Circuit for Space Charge Grid Tube Used As a Detector.

Screen Grid Audio Frequency Amplifier.—Used as a screen grid tube the four-element unit makes a highly efficient audio frequency amplifier, providing an effective voltage amplification greatly in excess of that obtainable even with high mu tubes of the three-element type. The connections for such an amplifier are shown in Fig. 19. The coupling units following this amplifying tube may be of the resistance type, impedance type or a combination of these. The tube lends itself exceptionally well to resistance coupling and also to impedance coupling when chokes of large inductance are used. This is because the amplification of the tube increases with increase of resistance or impedance in its plate circuit.

This tube is used in the stage or stages between the detector and the output stage. It does not make a desirable output tube because of its ex-

TUBE, SCREEN GRID TYPE

ceedingly high plate resistance. For the output stage or last stage in the audio amplifier one of the regular power tubes designed for such work should be used.

Space Charge Grid Audio Frequency Amplifier.—The four-element tube may be used as an audio frequency amplifier of the space charge grid type by placing it in any circuit arranged for the ordinary three-element tube, adding a positive voltage connection to the inner grid terminal at the tube's top and making the necessary changes in filament voltage and current.

The outer grid is then used as a control grid and this grid is already connected to the same socket prong that attaches to the grid in a three-element tube.

The space charge grid tube may be used to replace the audio frequency voltage amplifying tube or tubes in any receiver with comparatively slight changes because the connections to the tube socket remain as before. The

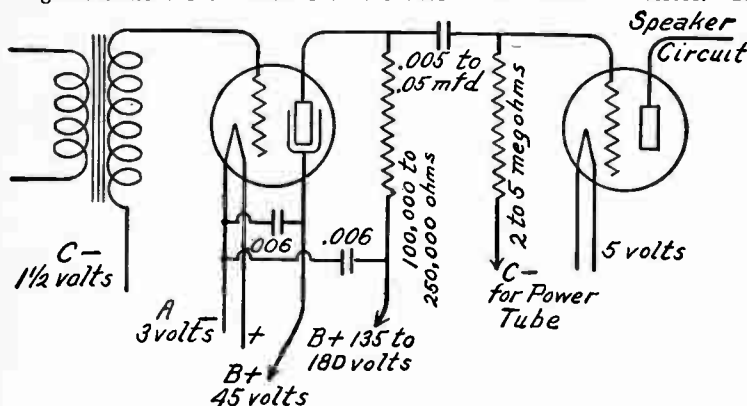

Fig. 19—Circuit for Screen Grid Audio Frequency Amplifier.

only added connection is that made to the space charge or inner grid through the metal cap at the tube's top.

When inserted in a resistance coupled amplifier the resistor in the plate circuit should be changed to one of from 100,000 to 250,000 ohms, one-tenth to one-quarter megohm. If the receiver was formerly fitted with high mu tubes, the plate resistors will generally be found of suitable values. No changes are made in the plate or grid circuits when using transformer or impedance coupling. The grid leak for impedance coupling may often be increased in number of ohms with good results.

It must be remembered that this four-element tube requires only 3.0 to 3.3 volts across its filament. If the audio frequency tubes replaced were provided with separate resistors or rheostats, those units used for former five-volt tubes must be changed to new values. Methods of obtaining suitable filament voltages are described in preceding paragraphs of this section under the heading, *Operating Voltages*. A thirty-ohm rheostat is the smallest variable resistance that may be used on a six-volt circuit. The space charge voltage applied at the top cap is not at all critical and may be changed within quite wide limits without great effect on operation.

Complete Receivers.—Wiring and layout for complete radio

TUBE, SELECTION OF

frequency amplifiers using the four-element tube are shown under the heading *Receiver, Screen Grid Type*. Used as a space charge device this type of tube may also be used in any of the amplifiers shown under *Receiver, Audio Amplifier for* by making the necessary changes in filament control resistance and by attaching the additional positive voltage line to the top terminal of the tube.

The possibility of changing from three-element tubes to screen grid tubes in a receiver depends on the design and construction originally used. Such a change in the radio frequency amplifying stages is not practical unless each stage is completely enclosed by a box type of shield. The change may then be made by bringing the grid connection to the top of the new tube and by connecting the "grid" terminal on the socket to a point of positive voltage. With these things done the tube will operate but will not amplify to a much greater degree than a three-element tube unless provision is made to introduce into the plate circuit much greater impedance than formerly used.

Change to the screen tube in an audio frequency amplifying stage may be made with greater advantage than in the radio frequency part of the receiver because shielding is not required. The same changes must be made in the grid connections as mentioned for the radio frequency stages. Transformer coupling will not provide enough impedance to secure great amplification from the new tube but if the interstage coupling in the audio amplifier is handled with resistances or with impedances (choke coils) the amplification should be far greater than secured from the three-element tube which is replaced with the new type.

TUBE, SELECTION OF.—See *Tube, Amplifying Types of*.

TUBE, SERIES CONNECTION OF.—The filaments of two or more tubes may be operated in series with one another from

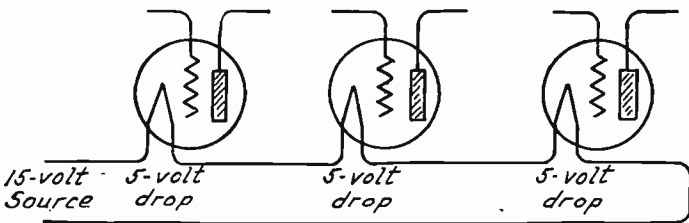

Series Connection of Filaments.

a source of filament current whose voltage is equal to the combined voltage drops through all the filaments in normal operation. Such a connection is shown in the diagram. See also *Power Unit, Filament Current Types of*.

TUBE, SOCKETS FOR.—See *Socket, Tube*.

TUBE, SOFT

TUBE, SOFT.—A soft tube is a vacuum tube in which a small amount of gas was allowed to remain when the bulb was evacuated. This remaining gas is useful in the operation of this type of tube which is employed as a detector. These soft detector tubes are very sensitive and are able to receive weak signals from great distances. See *Tube, Detector Types of*.

The older types of soft detector tubes make use of ionization of the gas in securing a large flow of plate current. See *Tube, Ionization in*. These tubes require very exact adjustment of plate voltage and filament temperature in order that they may do good work. Later types of gas content detectors are even more sensitive than the old soft tube but are not at all critical either as to filament voltage or plate voltage.

TUBE, SPACE CHARGE IN.—See *Tube, Action of*.

TUBE, STORAGE BATTERY TYPE.—See *Tube, Filament Current Supply for*.

TUBE, TESTING OF.—The various operating characteristics of a tube are measured with suitable meters for indicating the current and voltage in the filament circuit, plate circuit and grid circuit.

Filament voltage is measured with a voltmeter connected directly across the filament terminals of the tube with no other parts, such as rheostats, between the meter and the tube socket. Filament current is measured with an ammeter in series with either the positive or the negative line leading to the filament terminals on the tube socket. These measurements are shown in Fig. 1. The voltmeter must have a range great enough to more than cover the highest voltage applied to the filament and the ammeter must have a range greater than the highest filament amperage.

Grid voltage is measured with a voltmeter connected between the grid terminal of the tube socket and the negative filament terminal of the socket. This meter must have a range greater than the maximum grid voltage and if both positive and negative grid voltages are to be measured the meter may conveniently be of the zero center type so that its connections will not have to be reversed as the polarity of grid bias is reversed. The grid voltage meter should be left connected to the socket terminals at all times when the tube is assumed to be operating at the indicated grid voltages. It is not sufficient to test the grid voltage, then remove the meter, because there is a certain drop of voltage through the meter and when this drop is removed from the grid circuit by taking the meter away, the actual voltage on the grid is higher than that previously indicated by the meter. This connection is shown in Fig. 2.

Grid current measurement is also shown in Fig. 2. This measurement is made with a milliammeter connected in series with the grid lead. The meter should have a maximum range of about two milliamperes since this is the greatest grid current usually found within the operating range of tubes, even with a positive grid voltage as high as ten volts.

Voltage actually applied to the plate of the tube is measured by connecting a voltmeter between the plate terminal of the socket and

TUBE, TESTING OF

the negative filament terminal of the socket. This is shown in Fig. 3. The drop of voltage through the meter will have a considerable effect on the voltage actually applied, therefore the plate voltmeter should be left connected as long as tests are being made since the applied voltage will be higher with the meter removed than with it connected to the socket terminals. If a meter of very high resist-

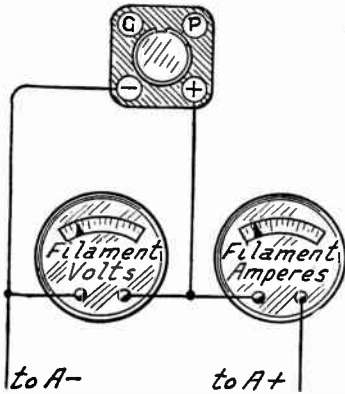

FIG. 1.—Testing Filament Voltage and Amperage.

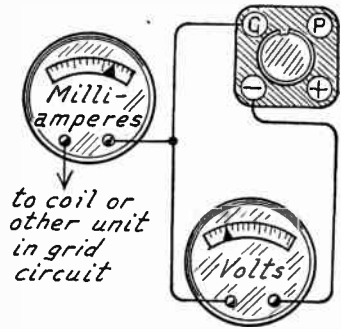

FIG. 2.—Testing Grid Voltage and Grid Current.

ance is used this precaution is not so important. If the voltmeter is applied across the terminals of the B-battery or plate voltage source it does not measure the voltage actually applied to the plate but measures the voltage at the source which is higher than the applied voltage by the amount of voltage drop through any resistance in the plate circuit. The range of this voltmeter must be greater than any voltage to be applied.

The plate current is measured by a milliammeter connected in series with the plate lead as shown in Fig. 3. This meter must have an operating range slightly greater than the maximum plate current to be measured.

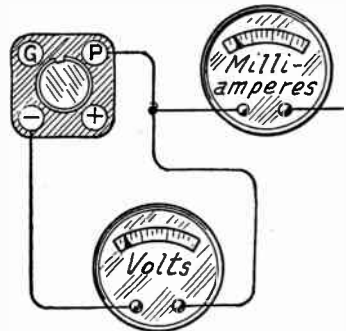

FIG. 3.—Testing Plate Voltage and Plate Current.

Plate Resistance Measurement.—The plate resistance of the tube is calculated from the formulas given under *Tube, Output Resistance and Impedance of*. It is necessary to first measure the plate voltage and the plate current, these being the only factors

TUBE, TESTING OF

required when the grid is kept at zero voltage. If the grid voltage is above or below zero it is also necessary to know the amplification factor of the tube and the grid voltage in order to calculate the plate resistance.

Amplification Factor Measurement.—The amplification factor depends on the relative changes in plate current and grid voltage as explained under the heading of *Tube, Amplification of*. It is calculated as follows:

Set the grid voltage at some negative value, noting the voltage and calling it $Eg-1$. Set the plate voltage at some convenient value, note this voltage and call it $Ep-1$. Read the plate current that results from the foregoing settings of grid voltage and plate voltage, calling this plate current $Ip-1$.

Now increase the plate voltage to a higher value, calling this new voltage $Ep-2$. This will increase the plate current. Increase the negative grid voltage until the plate current is brought back to the former value, $Ip-1$. Call this new grid voltage $Eg-2$.

Now subtract the smaller grid voltage, $Eg-1$, from the greater grid voltage $Eg-2$ and call the difference between the grid voltages $Eg-3$.

Then subtract the smaller plate voltage, $Ep-1$, from the greater plate voltage $Ep-2$, and call the difference between the plate voltages $Ep-3$.

Finally divide the plate voltage difference, $Ep-3$, by the grid voltage difference $Eg-3$. The quotient of the division is the amplification factor of the tube at the voltages being used. The amplification factor thus represents the relative effect of grid voltage changes and plate voltage changes in their control of the plate current.

Mutual Conductance Measurement.—If both the amplification factor and the plate resistance of a tube are known or have been calculated from measurements, the mutual conductance is found by simply dividing the amplification factor by the plate resistance. This is explained under *Tube, Mutual Conductance of*.

The mutual conductance may be easily calculated from readings of grid voltage and plate current as follows:

Set the grid voltage at some convenient negative value, calling this voltage $Eg-1$. Read the plate current which flows with this grid voltage and with any convenient plate voltage applied to the tube. Call the plate current $Ip-1$.

Now make the grid voltage more strongly negative and call this new grid voltage $Eg-2$. Read the plate current now flowing with this new grid voltage and call the new plate current $Ip-2$. The plate voltage should not be changed during the test.

Then subtract the smaller plate current $Ip-2$ from the larger plate current $Ip-1$, calling the difference $Ip-3$. Subtract the smaller value of negative grid voltage, $Eg-1$, from the larger grid voltage $Eg-2$ and call the difference $Eg-3$.

Divide the change in plate current, $Ip-3$ (in amperes, not in milliamperes), by the change in grid voltage, $Eg-3$, and the result of the division will be the mutual conductance in mhos. This is changed to micromhos by multiplying by 1,000,000.

Tube Tester.—The principal operating characteristics of a tube may be learned from measurements taken from a plate voltmeter, a plate milliammeter, and a grid voltmeter. A filament voltmeter is a convenience but not a necessity. With the instruments just mentioned it is possible to obtain readings of plate current, plate voltage and grid voltage or grid bias. From these measurements may be calculated the tube's plate resistance, amplification factor and mutual conductance by the methods just described.

TUBE, TESTING OF

The layout for a tube tester incorporating the three necessary meters is shown in Fig. 4. The grid voltmeter should be of the zero center type, should have a range as great as the maximum C-battery or biasing voltage to be used, and should be of the highest

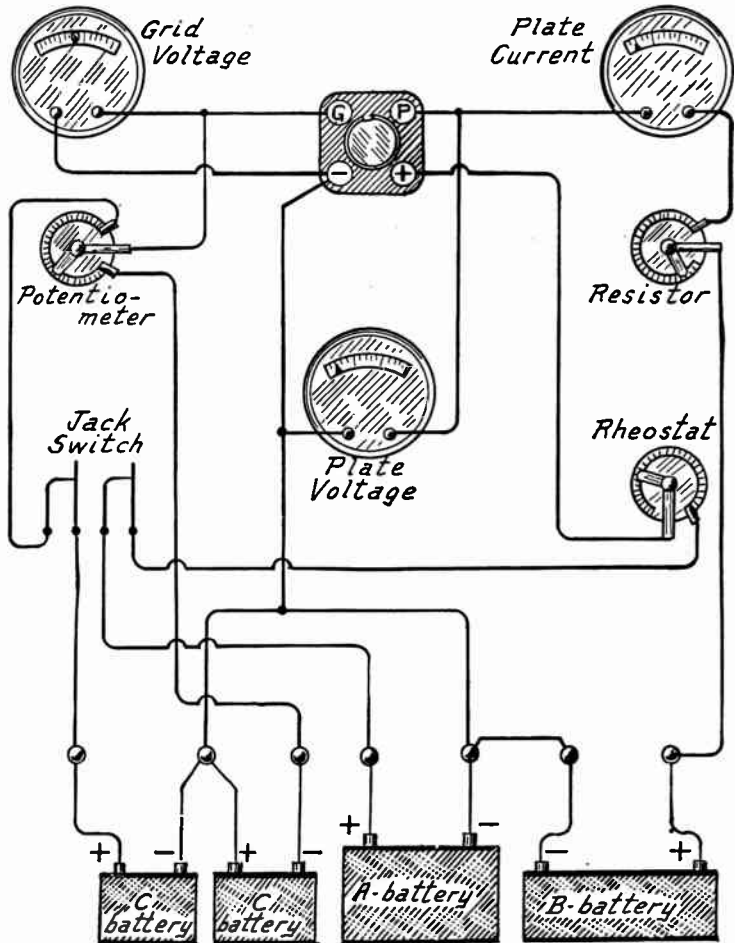

FIG. 4.—Tube Tester with Three Meters.

possible resistance. The plate current meter is a milliammeter having a range great enough to take care of the plate current from any tube to be tested. The plate voltmeter must read as high as the highest plate voltage to be applied.

The potentiometer may have about 400 ohms resistance. The C-batteries are connected so that turning the potentiometer one direction from its central

TUBE, TESTING OF

point applies a positive grid bias while turning it the other direction applies a negative grid bias. The switch should be of the double-pole, single-throw type so that both the A-battery circuit and the C-battery circuit are opened. Otherwise the C-batteries will discharge through the potentiometer. A jack type switch is satisfactory here.

The resistor in the plate circuit should be of the variable type giving up to 100,000 ohms resistance so that the plate voltage may be changed without changing the B-battery connections. This resistor may also serve as a load in the plate circuit. The rheostat should have a resistance suited to the tubes to be handled.

Any value of grid voltage, positive or negative, may be applied within the limits set by the C-batteries. Any plate voltage within the limits of the B-battery voltage may be applied by using the resistor. Tubes may be tested with this device for all of their important characteristics.

In Fig. 5 is shown the layout for a tester more complete than the one in Fig. 4. This arrangement incorporates all of the meters used in the tester of Fig. 4 and in addition has a grid current milliammeter, a filament voltmeter and a filament ammeter. The operations of the potentiometer, the resistor and the double-pole switch are the same as for the tester first described. Additional switches may be placed in either type of tester so that any of the voltmeters may be open circuited by opening their switch or so that any of the ammeters may be short circuited by closing their switch.

The tester of Fig. 5 will make tests of filament emission not possible with the first one described. It will also test the effect of filament voltages on filament currents. It will make tests of grid current with positive grid voltages. Otherwise this more elaborate outfit will not do any more work than the simpler type.

Under the heading of *Tube, Characteristics of*, are shown and described the numerous curves which may be plotted by the use of such testers as illustrated in Figs. 4 and 5. The work is done by selecting any combination of voltages, currents and resistances in the plate circuit, grid circuit or filament circuit. The effect of a change in one value on the other of any pair may then be observed by watching the meters while changes are made.

For example, to plot a curve showing the effect of changes in the plate voltage on flow of plate current, the grid bias would be set at some convenient point within the operating range of the tube to start with. The initial plate voltage would then be read from the plate voltmeter and a note made. The corresponding plate current would then be read from the plate milliammeter and at the intersection of the lines for the observed plate voltage and plate current a point would be marked on the graph. See *Graph*.

The plate voltage would then be changed to another value, either higher or lower, the new value of plate current would be observed and a second point laid off on the graph. The process would be continued thus until a sufficient number of points were laid out so that a smooth curve might be traced through them.

In the development of a curve showing the relation between grid voltage and plate current the plate voltage would be set at some usual operating point. The potentiometer would be moved to give

TUBE, TESTING OF

a reading on the grid voltmeter, the corresponding plate current would be read from the plate milliammeter and a point laid in on

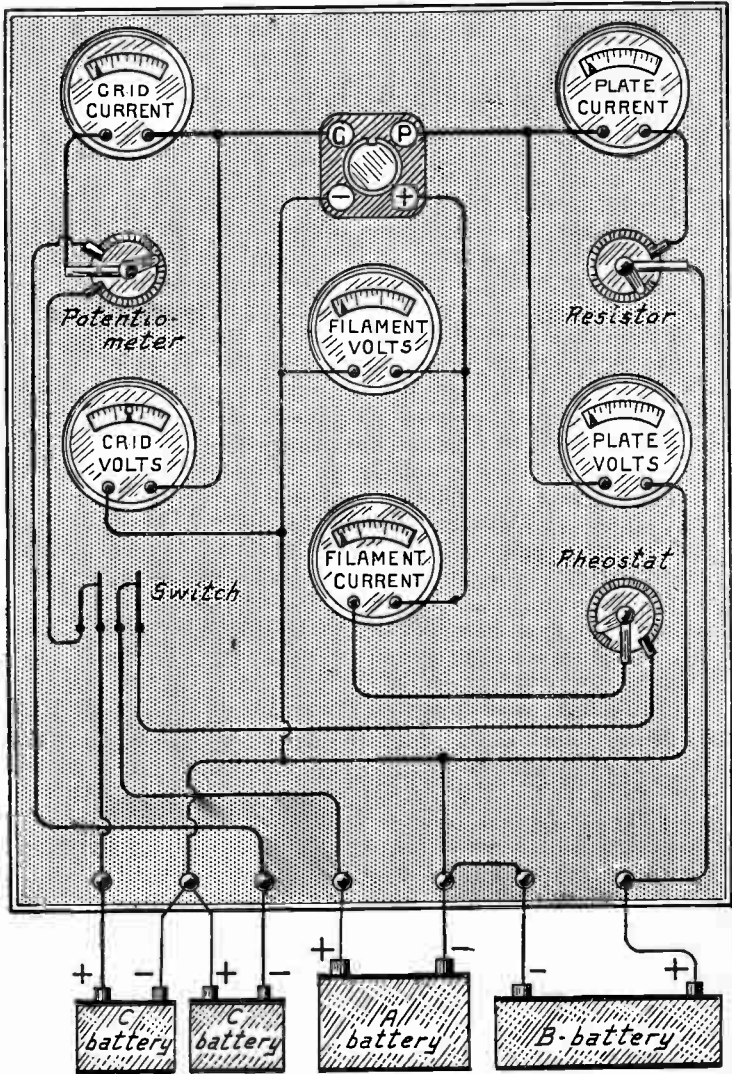

FIG. 5.—Tube Tester with Meters for All Readings.

the graph to correspond with the intersection of the lines for the observed grid voltage and plate current. Any other curve may be similarly laid out with the tester.

TUBE, THERMIONIC

TUBE, THERMIONIC.—A vacuum tube. See *Tube, Action of.*

TUBE, THREE-ELEMENT TYPE.—The vacuum tube containing a filament, a plate and a grid, is called a three-element tube.

TUBE, TWO-ELEMENT TYPE.—See *Tube, Rectifier Types of.*

TUBE, VOLTAGE AMPLIFICATION OF.—See *Tube, Amplification of.*

TUBE, VOLTAGE REGULATOR TYPE.—This is a special type of tube which maintains a steady potential of ninety volts at one terminal of a power unit regardless of ordinary variations in plate current drawn by the connected receiver.

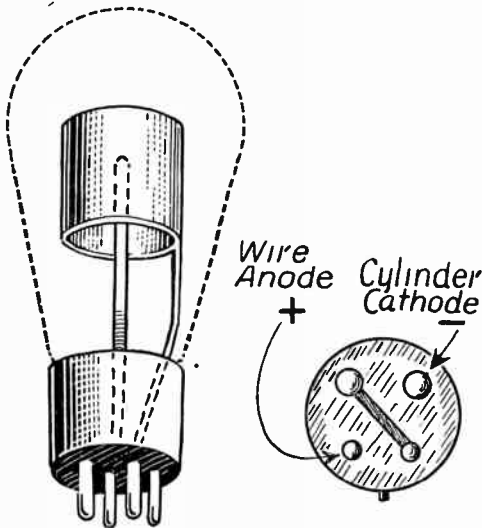

FIG. 1.—Voltage Regulator Tube.

The bulb is filled with gas at low pressure. In the type generally used there are two elements, one a metal cylinder and the other a heavy wire extending up into the cylinder. The wire is the anode and is connected to the 90-volt positive tap of the voltage divider in a plate power unit. The cylinder is the cathode and is connected to the B-minus line. The tube uses a base like those on amplifier tubes with the anode or wire connected to the prong which would carry the grid of an amplifier, while the cathode or cylinder is connected to the prong diametrically opposite as shown in Fig. 1. The remaining two prongs are connected together in the base, this connection serving to break the circuit of a rectifier tube when the

TUBE, VOLTAGE REGULATOR TYPE

voltage regulating tube is withdrawn from its socket. This is a safety measure since the voltage at the nominal 90-volt tap would rise to 125 volts or more without the regulator.

In Fig. 2 is shown the use of the base connection for completing

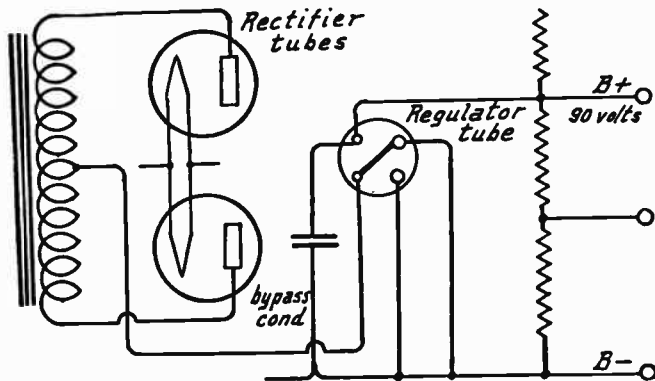

FIG. 2.—Base Connection of Regulator Tube in Full-wave Rectifier.

the connection from the negative center tap of the power transformer to the B-minus line with two tubes operating as a full-wave rectifier. A similar circuit would be used with a single full-wave rectifying tube. In Fig. 3 is shown the use of the base connection

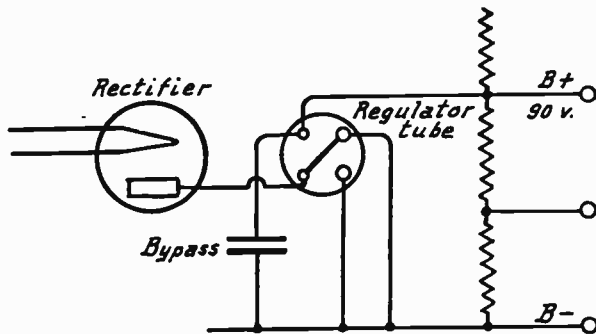

FIG. 3.—Base Connection of Regulator Tube in Half-wave Rectifier.

for completing the circuit from the tube plate to the B-minus line with a half-wave rectifier tube. A bypass condenser of four microfarads capacity is connected across this tube.

When the power unit is turned on, the voltage between the 90-volt tap and B-minus rises momentarily to about 125 volts. This

TUBE, VOLTAGE REGULATOR TYPE

pressure acting across the anode and cathode in the regulator ionizes the gas and there is a flow of current from anode to cathode, the flow being accompanied by a blue glow which is strongest around the cylinder. Because of this action the device is often called a glow tube. The potential across the regulator immediately drops to ninety volts and the current rises to about twenty-five milliamperes. If the current drawn from the 90-volt tap by the receiver should increase, the current through the regulator decreases in proportion and should the current drawn from this tap decrease, the current through the regulator increases proportionately. The voltage across the tube and between the tap and B-minus remains at ninety. With no current being drawn from the ninety-volt tap the regulator tube current may rise to forty or forty-five milliamperes. If there is an excessive amount of current drawn by the receiver the regulator tube current drops too low to maintain the action and there is no regulation.

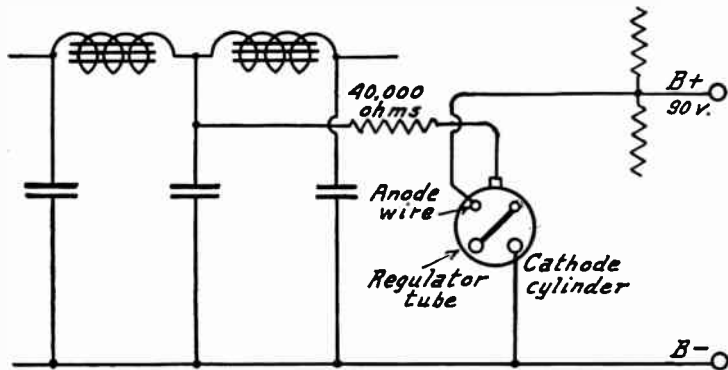

FIG. 4.—Connections to Regulator Tube with Ionizer.

The current through the regulator tube should never exceed fifty milliamperes. The resistance in ohms between the ninety volt tap and the output from the filter is made great enough so that the regulator current does not exceed this value with the receiver in operation.

The regulator tube improves the voltage regulation of the power unit, also reduces the tendency to hum and prevents much of the "motorboating" found with power supply units.

While in operation most of the glow should appear around the cylinder. If the glow concentrates around the wire, the connections to the tube are reversed. While these tubes are supposed to work at a ninety-volt drop, they sometimes are found to operate anywhere between eighty and one hundred volts. A defective voltage regulator tube may oscillate or fluctuate and produce noisy reception.

TUBING, INSULATING

Another type of voltage regulator tube employs an additional element which maintains ionization of the gas at all times with the power unit turned on and regardless of the amount of current drawn by the receiver. The ionizing current enters the tube through the pin on the side of the base, being taken through a 40,000-ohm resistor from a point between the two filter chokes. The ionizing current is about three milliamperes. Circuit connections are shown in Fig. 4.

TUBING, INSULATING.—The wiring in radio receivers is often made with bare or tinned copper bus bar wire over which is placed small tubing where there is any danger of a short circuit. Tubing used for this work is usually called “spaghetti.”

Spaghetti tubing is made from varnished cloth. It is an excellent insulator and resists moisture and age very well but is quickly attacked by battery acid. This tubing may be had in various colors by means of which different circuits are easily distinguished from one another.

Small diameter flexible rubber tubing is often used in place of the spaghetti or fabric tubing. The rubber makes a very good insulator and it resists battery acid or fumes as well as being unaffected by moisture. The rubber tubing tends to harden with age and will then crack when bent.

TUNED ANTENNA.—See *Antenna, Tuned.*

TUNED AUDIO FREQUENCY AMPLIFIER.—See *Amplifier, Audio Frequency, Impedance, Double Type* also *Amplifier, Audio Frequency, Transformer Coupled.*

TUNED RADIO FREQUENCY TRANSFORMER.—See *Transformer, Tuned Radio Frequency.*

TUNER.—The part of a radio receiver which immediately follows the antenna is often called the tuner. The tuner includes the

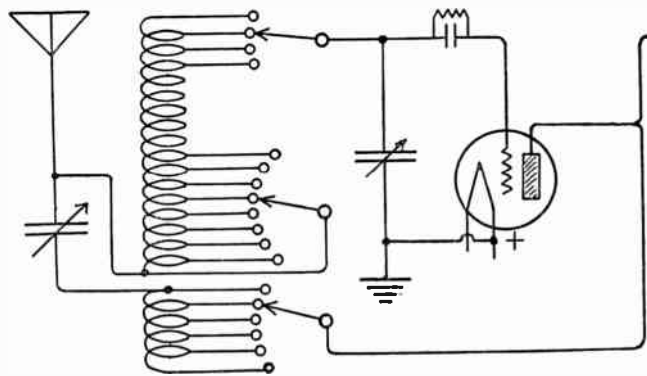

FIG. 1.—Tuner of the Reinartz Type.

TUNGSTEN

antenna coupling devices together with any variable condenser, variometers, variocouplers or other parts used for tuning the antenna circuit or the circuit coupled to the antenna. The tuner may also vary the coupling between the antenna circuit and the radio frequency stages or the detector if no radio frequency amplification is used.

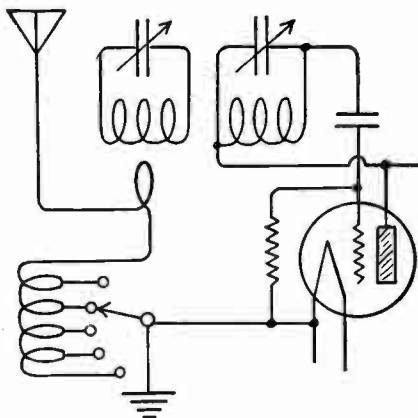

FIG. 2.—Tuner of the Cockaday Type.

In modern radio receivers we generally find two or more tuned stages of radio frequency amplification which are coupled directly to the antenna circuit. Consequently the word "tuner" has lost its former significance as it applied to receivers in which the first tube was the detector and in which very elaborate networks of tuned circuits were used between antenna and detector.

TUNGSTEN.—Tungsten is a metal used in the manufacture of filaments for vacuum tubes and in making contact points for switches and other parts where sparking may occur. After the tungsten is made ductile by rolling, swaging and hammering it becomes very tough and also very strong. See *Tube, Filament Materials* for.

TUNGSTEN FILAMENT.—See *Tube, Filament Materials* for.

TUNING.—The process of making the oscillatory circuits of a radio receiver resonant to the frequency of the signal to be received is called tuning. With all of the circuits tuned to resonance their resistance to voltages and currents of the tuned frequency is a minimum and these signals produce responses many times more powerful than can be produced by signals of any other frequency. See *Radio, Principles of*.

No exact rules can be given by means of which any and all receivers may be tuned because of the many differences in construction and in the arrangement of tuning controls. Many modern receivers have but one principal control for tuning while a very great number have but two controls. The one control or two controls handle the

TUNING

operation of all the tuned stages at once. Single-tube and two-tube receivers of earlier days would often have a dozen or more tuning controls.

The following rules are typical of those which should be followed in tuning a receiver for the first time. They cover a receiver with two tuning dials and with one "volume control" which is really a regeneration control. If the receiver to be handled has three tuning dials the process is very similar, the two right hand dials usually tuning almost exactly together, while the left hand dial is kept somewhat below the average setting by the capacity and inductance of the antenna system. Right hand and left hand as here used refer to a receiver whose antenna circuit is at the left hand end and whose audio output or loud speaker end is at the right.

1. Close the battery switch, turn it to the "on" position.
2. Place the loud speaker plug in jack. A click should be heard in the speaker as the plug is pushed in.
3. Adjust detector rheostat until a faint rushing sound is heard, then turn the detector rheostat back very slowly until this rushing just stops.
4. Turn the audio rheostats about half way to two-thirds of the way toward full on.
5. Turn both of the tuning dials to 40 on their scales.
6. Turn the two tuning dials one or two points at a time, keeping them approximately together in scale readings until a station is heard.
7. If no station is heard, set one tuning dial one or two points higher or lower than the other and, keeping them this far apart on their scales, turn them together up or down until a station is heard.
8. As soon as any music or speech is heard, stop turning both dials together. Turn one or the other very slowly up and then down. Leave it at the point where the music or speech is loudest. Leave this dial as adjusted and repeat the same procedure with the other one so that both are set at the exact position where the reception is loudest.
9. If, as the dials are turned toward the loudest position there is a whistling note or if the reception suddenly ceases with a click in the speaker, turn the volume control to lower the volume. Turn the volume down until the music or speech reappears. Keep turning the tuning dials toward the loudest point while lowering the volume control as far as necessary to prevent whistling noises.
10. If the music or speech has been made as loud as possible by turning the two tuning dials and no whistling or oscillation appears, the volume may be increased.
11. When the dials are exactly placed and the volume control adjusted for satisfactory volume, write the call letters of the station on a log sheet and place opposite them the settings on the scales of the two tuning dials. Thereafter that station may always be received by setting the dials at the points logged. A very slight readjustment of the dial settings may sometimes be needed for maximum volume. See *Calibration*.

Tuning Dials.—There are assumed to be two large dials with scales numbered from "0" to "100." These may be turned by grasping the large knobs at their centers, but better tuning may be done by working entirely with the small "vernier" knobs if such are provided. These vernier knobs rotate the dials comparatively slowly so that there is practically no danger of passing by a station without hearing it. The scale readings on the dials are proportionate to the frequencies to be received. That is, the higher the frequency in kilocycles of the station it is desired to receive, the lower the dial readings will be. If a station broadcasting on a frequency of 800 kilocycles is received with the dials at 45, another station broadcasting at

TUNING, AUTOMATIC

750 kilocycles will be received with the dials at a higher number on their scale, say at 50 or higher. With the receiver there may be a log sheet that has been filled out with the correct dial settings for several stations which will show about what to figure on in placing the two dials.

Vernier Knobs for Tuning Dials.—It is best to form the habit of always turning the dials by taking hold of the small vernier knobs. When the dial settings are near the desired points, or when tuning in a station for the first time, these vernier knobs should be turned as slowly as possible. The dials should be moved so slowly that the travel of the scale past the indicator lines is barely perceptible. One of the most common mistakes is in turning the dials too fast—or in turning them fast at all.

Volume Control.—It will be found that increasing the volume control up to a certain point will cause the signal volume or loudness to increase. After a very sudden increase in volume at a critical point the music or speech will suddenly become badly distorted, will disappear entirely, or will be replaced with a whistling sound if the volume control is still further increased. Lowering the volume will let the music or speech come back once more. The greatest volume will always be received with the volume control just below this critical point and nothing can be gained by turning the control higher.

Keep the volume control in step with the dial settings in tuning a station for the first time or in hunting for the settings of distant stations.

Audio Rheostats.—The tube voltage is increased as these rheostats are turned clockwise, to the right, and it is decreased as they are turned anti-clockwise, to the left. Turning the rheostats all the way to "0" on their scales shuts off the tubes controlled by that rheostat. Audio rheostats should be turned to the lowest point that gives satisfactory reception.

Battery Switch.—Operation of the receiving set is started and stopped with the battery switch. With this switch turned off the battery current is shut off from the receiver and no reception can take place, neither will any battery current be used. To use the receiver, the first thing to do is to turn on the battery switch, which lights the filaments of the tubes and places the set in condition for use.

With a certain station properly tuned in and being received, the battery switch may be turned off, thus stopping reception. If no controls are moved and the battery switch is turned on some time later, the same station will be received without change of any controls providing it is broadcasting.

TUNING, AUTOMATIC.—Tuning a receiver by pressing a button for the frequency desired instead of by adjusting a condenser or an inductance is called automatic tuning. Two methods are in common use, one operating by means of cams to bring tuning condensers into proper position, the other operating by means of addi-

TUNING, COILS FOR

tional tuning condensers which are substituted for the regular tuning condensers when operation is automatic.

TUNING, COILS FOR.—See *Coil, Tuning, Sizes Required for.*

TUNING, CONDENSER FOR.—See *Condenser, Tuning.*

TUNING, DIALS FOR.—See *Dial, Tuning.*

TUNING FORK OSCILLATOR.—See *Oscillator, Audio Frequency.*

TURN RATIO, TRANSFORMER.—See *Transformer.*

TURNS PER INCH OF WIRE.—See *Wire, Turns per Inch.*

TURPENTINE.—See *Oils, Insulating.*

TWO-BUTTON MICROPHONE.—See *Microphone.*

TWO-CIRCUIT RECEIVER.—See *Receiver, Two-Circuit.*

TWO-ELEMENT TUBE.—See *Tube, Rectifier Types of.*

U

ULTRA AUDION RECEIVER.—See *Receiver, Single Circuit*.

UMBRELLA ANTENNA.—See *Antenna, Forms of*.

UNDAMPED WAVE.—See *Wave, Undamped*.

UNDERGROUND ANTENNA.—See *Antenna, Underground*.

UNDERWRITERS' RULES.—See *Rules, Underwriters'*.

UNIT, POWER SUPPLY.—See *Power Unit*.

UNIT, TRANSMISSION.—The transmission unit is a measure of the gain or loss in either power, voltage or current of an electrical system, the measure being based on the ratio of the power, voltage or current at one point to the power, voltage or current at another point in the system.

The ratio of gain in power is equal to the greater power (in watts) divided by the lesser power (in watts). The ratio of loss in power would be equal to the lesser number of watts divided by the greater number. Similarly, ratios of gain or loss in voltage or current are found by dividing one voltage or current by the other. If the input power to an amplifier is 10 milliwatts and the output is 100 milliwatts, the gain ratio is equal to 100 divided by 10, or is 10. If the power at the beginning of a circuit is represented by 30 watts and the power at the end of the circuit is represented by 15 watts, the loss ratio is equal to 15 divided by 30 or $\frac{1}{2}$. Voltages or current are similarly treated in determining the ratio.

CURRENT RATIOS AND CORRESPONDING NUMBERS OF TRANSMISSION UNITS

Current Ratio	Transmission Units	Current Ratio	Transmission Units	Current Ratio	Transmission Units
0.001	loss 60.00	0.5	loss 6.02	20	gain 26.02
0.005	loss 46.02	1.0	0.00	50	gain 33.98
0.01	loss 40.00	1.5	gain 3.52	100	gain 40.00
0.05	loss 26.02	2.0	gain 6.02	500	gain 53.98
1.0	loss 20.00	5.0	gain 13.98	1000	gain 60.00
0.2	loss 13.98	10.0	gain 20.00	10000	gain 80.00

To change the power ratio into the equivalent number of transmission units the ratio is multiplied by ten times the common logarithm of the ratio. For example, if the input power is 10 and the output power is 100, the ratio is 10. The common logarithm of 10 is 1 and 1 multiplied by 10 equals 10, therefore there is a gain of ten transmission units. If the input power to a circuit is 30 watts and the output power is 15 watts, the ratio is $\frac{1}{2}$. The common logarithm of $\frac{1}{2}$ is 0.301 which, multiplied by 10 becomes 3.01, the number of transmission units loss in the circuit.

To change voltage ratios or current ratios into transmission units the ratio is multiplied by twenty times the common logarithm of the ratio. If an

UNIT, TRANSMISSION

amplifier increases the signal voltage to eight times its original value the ratio of gain is 8. The common logarithm of 8 is 0.9031 which, multiplied by 20 becomes 18.062, the voltage gain in transmission units.

The National Electrical Manufacturers Association has adopted the following definition as a standard: "A unit of power ratio used for expressing transmission loss or transmission gain (amplification). Two amounts of power differ by one transmission unit when they are in the ratio of $10^{0.1}$. Two amounts of power differ by N transmission units when they are in the ratio of $10^{(0.1)N}$. The number of transmission units is ten times the common logarithm of the power ratio to be expressed."

The accompanying tables show the power ratios of gain or of loss which correspond to certain fractions or numbers of transmission units.

POWER RATIOS AND TRANSMISSION UNITS

Ratio of Gain	Number of T. U.	Ratio of Gain	Number of T. U.	Ratio of Gain	Number of T. U.
1.0	0.000	4.12	6.232	12.0	10.792
1.1	0.414	4.3	6.335	13.0	11.139
1.2	0.792	4.4	6.435	14.0	11.461
1.26	1.000	4.5	6.532	15.0	11.761
1.3	1.139	4.6	6.628	16.0	12.041
1.4	1.461	4.7	6.721	17.0	12.304
1.5	1.761	4.8	6.812	18.0	12.553
1.59	2.000	4.9	6.902	19.0	12.788
1.6	2.041	5.0	6.990	20.0	13.010
1.7	2.304	5.01	7.000	25.0	13.979
1.8	2.553	5.2	7.160	30.0	14.771
1.9	2.788	5.4	7.324	35.0	15.441
1.99	3.000	5.6	7.482	40.0	16.021
2.0	3.010	5.8	7.634	45.0	16.532
2.1	3.222	6.0	7.782	50.0	16.990
2.2	3.424	6.2	7.924	55.0	17.404
2.3	3.617	6.31	8.000	60.0	17.782
2.4	3.802	6.4	8.062	65.0	18.129
2.5	3.979	6.6	8.195	70.0	18.451
2.51	4.000	6.8	8.325	75.0	18.751
2.6	4.150	7.0	8.451	80.0	19.031
2.7	4.314	7.2	8.573	85.0	19.294
2.8	4.472	7.4	8.692	90.0	19.542
2.9	4.624	7.6	8.808	95.0	19.777
3.0	4.771	7.8	8.921	100.0	20.000
3.1	4.914	7.94	9.000	200.0	23.010
3.16	5.000	8.0	9.031	400.0	26.021
3.2	5.051	8.2	9.138	600.0	27.782
3.3	5.185	8.4	9.243	800.0	29.031
3.4	5.315	8.6	9.345	1000.0	30.000
3.5	5.441	8.8	9.445	2000.0	33.010
3.6	5.563	9.0	9.542	4000.0	36.021
3.7	5.682	9.2	9.638	6000.0	37.782
3.8	5.798	9.4	9.731	8000.0	39.031
3.9	5.911	9.6	9.823	10000	40.000
3.98	6.000	9.8	9.912	20000	43.010
4.0	6.021	10.0	10.000	100000	50.000
4.1	6.128	11.0	10.414	1000000	60.000

UNTUNED RADIO FREQUENCY AMPLIFIER

Ratio of Loss	Number of T. U.	Ratio of Loss	Number of T. U.	Ratio of Loss	Number of T. U.
0.95	0.223	.34	4.685	.158	8.000
.90	0.458	.32	4.949	.150	8.239
.85	0.706	.316	5.000	.145	8.386
.80	0.969	.30	5.229	.140	8.539
.79	1.000	.29	5.376	.135	8.697
.75	1.249	.28	5.528	.130	8.861
.70	1.549	.27	5.686	.126	9.000
.65	1.871	.26	5.850	.125	9.031
.63	2.000	.251	6.000	.120	9.208
.60	2.218	.25	6.021	.115	9.393
.55	2.596	.24	6.198	.110	9.586
.50	3.000	.23	6.383	.105	9.788
.48	3.188	.22	6.576	.100	10.000
.46	3.372	.21	6.778	.01	20.000
.44	3.565	.20	6.990	.001	30.000
.42	3.768	.19	7.212	.001	40.000
.40	3.978	.18	7.447	.00001	50.000
.38	4.202	.17	7.696	.000001	60.000
.36	4.437	.16	7.959		

UNTUNED RADIO FREQUENCY AMPLIFIER.—See *Amplifier, Radio Frequency, Untuned Transformer Coupled.*

UNTUNED RADIO FREQUENCY TRANSFORMER.
—See *Transformer, Untuned Radio Frequency.*

V

v.—The symbol for velocity.

V.—The symbol for potential difference in volts.

VACUUM TUBE.—See *Tube*.

VACUUM TUBE VOLTMETER.—See *Meter, Vacuum Tube*.

VALUE, AVERAGE AND EFFECTIVE.—The effective value of an alternating current is equal to a direct current which would produce the same heating effect as the alternating current in a circuit. The average value of a rising and falling current or voltage is the difference, if any, between the values of one polarity and those of opposite polarity. In an alternating cycle the value of the positive alternation is equal to the value of the negative alternation; therefore the two balance each other and the average value is zero. The average value of a pulsating current may be anywhere between zero and the maximum value of the pulsations.

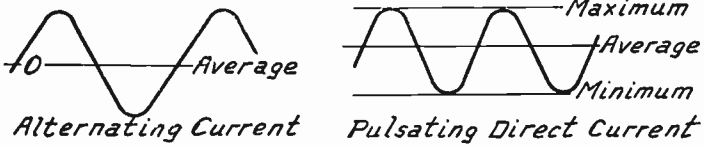

Average Values of Alternating and Pulsating Currents.

A direct current voltmeter or ammeter indicates average values. When such meters are inserted in alternating current circuits their pointers stand at zero since the tendency is to deflect them just as much one way as the other. Alternating current voltmeters and ammeters indicate effective values and will move their pointers in the same direction regardless of the direction of the current flowing through them. The position of the pointer is proportional to the average of the squares of all the values of current during the cycle. See *Wave, Sine*.

The effective value of an alternating current is equal to the maximum value multiplied by 0.707. The maximum value is equal to the effective value multiplied by 1.4144. This relation holds true for sine wave currents.

VALVE.—This is another name for a vacuum tube. See *Tube*.

VARIABLE CONDENSER.—See *Condenser, Variable*.

VARIABLE COUPLER.—See *Coupler, Variable*.

VARIABLE GRID LEAK.—See *Leak, Grid*.

VARIABLE RHEOSTAT.—See *Rheostat*.

VARIOCOUPLER.—See *Coupler, Variocoupler Type*.

VARIOMETER, ACTION OF.—A variometer is a continuously variable inductance. It is a device by means of which inductance may be increased or decreased in much the same way that capacity is changed by a variable tuning condenser. Variometers

VARIOMETER, ACTION OF

are used in tuned circuits with which change of resonant frequency is made by changing the inductance while using a fixed capacity rather than by the more common method of changing the capacity while using a fixed inductance or coil.

A variometer is made up of two coils of approximately equal inductance. One coil is wound on the outside of its form and the

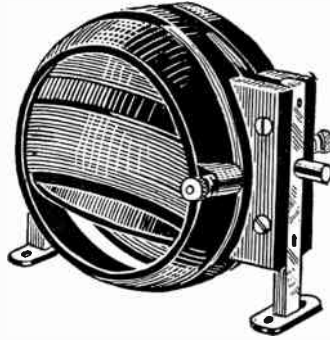

FIG. 1.—Variometer with Spherical Windings.

other coil is carried on the inside of its form. The two are placed together as in Fig. 1 or Fig. 2 so that the coil on the outside of its form may be rotated within the other one.

The two inductances may be made to assist each other or to oppose each other. With the two coils working together the inductance of the whole variometer is at its maximum. With the two coils op-

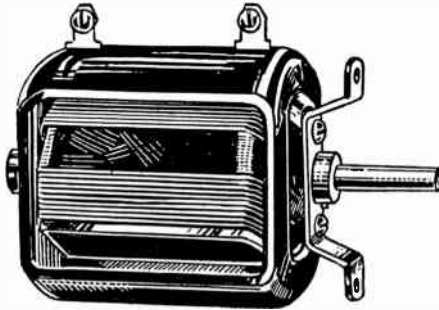

FIG. 2.—Variometer with Rectangular Windings.

posing each other the total inductance is at its minimum. Variometers used for receiving work generally have a minimum inductance of 50 to 75 microhenries and a maximum inductance of from 500 to 700 microhenries.

The principle of the variometer may be understood from Figs. 3 and 4. In Fig. 3 the winding of the two coils passes around both in the same direction. Therefore, their self-inductances and their mutual inductance are added.

VARIOMETER, ACTION OF

If one is slipped inside the other as below, the combined inductances will be more than double that of either coil alone.

In Fig. 4 one of the coils has been turned upside down while the other one remains in its original position. Their fields and inductive strengths now oppose each other. If one coil be now slipped inside the other the two fields will oppose each other and the inductance of one coil will destroy that of the other so that the combination has little remaining inductive effect.

In actual practice the one winding, called the stator, is supported securely in position by the mounting device. The other winding, called the rotor, is carried by a shaft so that it may be rotated inside the stationary winding. By turning the rotor through one half a revolution the combined inductance is changed gradually and

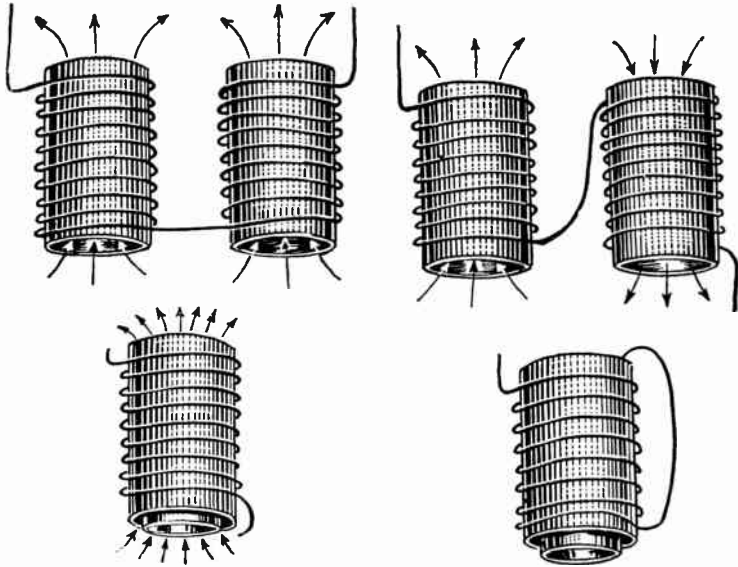

FIG. 3.—Coils Working Together to Add Their Inductances as in a Variometer. FIG. 4.—Coils Opposing Each Other to Destroy Inductance as in a Variometer.

smoothly from its maximum value to its minimum. If rotation is continued the inductance will again increase until it reaches a maximum value again as the coils come into their former relation or position with reference to each other.

Variometers are wound with wire between number 20 and number 26 gauge sizes. Double silk covered wire is suitable because of its small thickness of insulation and because it is well protected from mechanical injury. The wire is laid into the forms and is held in place by clamping and by small amounts of binder. Some types of variometers are built with basket weave windings, then requiring but little solid dielectric in their construction. The losses in variometers are the same as found in coils.

VARIOMETER, COUPLING WITH

The change of inductance as a variometer is turned from minimum to maximum is shown by the curve in Fig. 5. The change is gradual at first, then quite rapid as the coils are passing the position

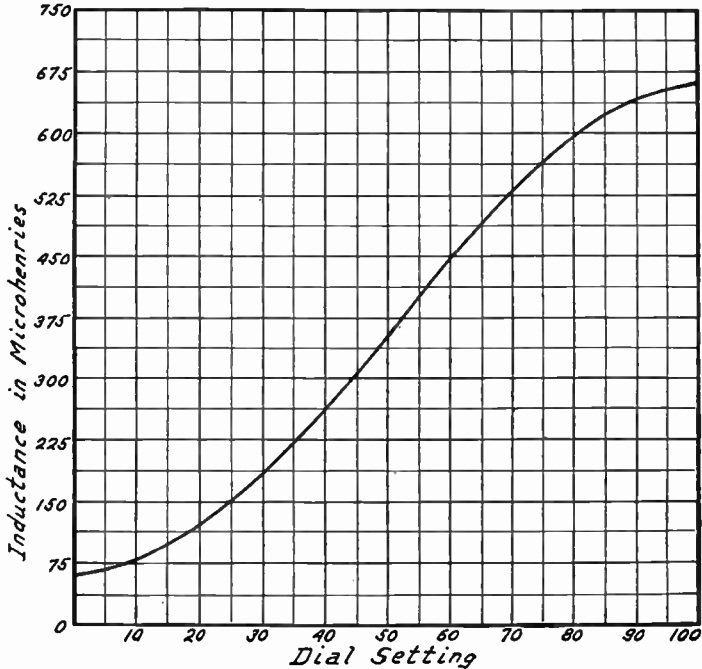

FIG. 5.—Change of Inductance with Rotation of Variometer Rotor.

of right angles or ninety degrees to each other. As the coil axes again come to the parallel position the inductance change is less rapid.

VARIOMETER, COUPLING WITH.—A variometer may be used as a tuned impedance coupling between radio frequency amplifying tubes or as a form of tuned transformer coupling with a variable secondary. Tuned impedance coupling with a variometer is shown in Fig. 1. The plate of one tube is connected to the grid of the following tube through a coupling condenser. The second tube is provided with a grid leak to prevent blocking. The variometer is connected between the plate of the first tube and the B-battery or plate voltage supply unit. See also *Amplifier, Radio Frequency, Tuned Impedance Coupled*.

Fig. 2 shows the use of a variometer as the secondary of a tuned radio frequency transformer. The terminals of the variometer are bridged with a fixed condenser, thus forming a combination of vari-

VARIOMETER, COUPLING WITH

able inductance and fixed capacity that is equivalent in action to the more familiar fixed inductance and variable tuning condenser. The primary of the transformer is formed by three to twenty turns of wire around the variometer or supported along side the stationary winding of the variometer. These primary turns are connected between the plate of the preceding tube and the B-battery or voltage supply unit in the usual way. The arrangement of the primary winding, the variometer and the fixed condenser is shown by Fig. 3.

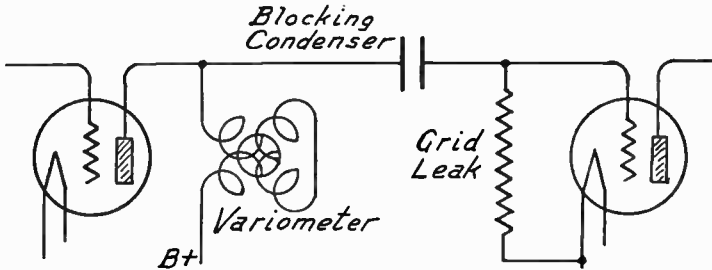

FIG. 1.—Tuned Impedance Coupling with Variometer.

The required capacity of the fixed condenser across the variometer windings will depend upon the maximum inductance of the variometer. The ratio between maximum and minimum inductance in well built variometers is ten to one or better, this being a range sufficient to cover the broadcasting band of frequencies when used with a fixed condenser for tuning. The following table gives the approximate minimum and maximum inductances required in the variometer when tuned with fixed condensers of various capacities. The variometer should have a range somewhat greater than the required minimum to maximum.

CONDENSERS FOR TUNING VARIOMETERS

Capacity of Fixed Condenser in Microfarads	Microhenries of Inductance Required in Variometer	
	Minimum	Maximum
.001	12	86
.00075	15	114
.0006	19	142
.0005	23	171
.0004	28	213
.00035	32	244
.0003	38	284
.00025	45	341
.0002	57	426
.00015	75	568
.000125	90	682
.0001	113	852
.000075	150	1133
.00005	225	1704

VARIOMETER, COUPLING WITH

The increase of inductance in a variometer as the frequency decreases or as the wavelength increases is more favorable to uniform amplification of all frequencies than is the increase of capacity for

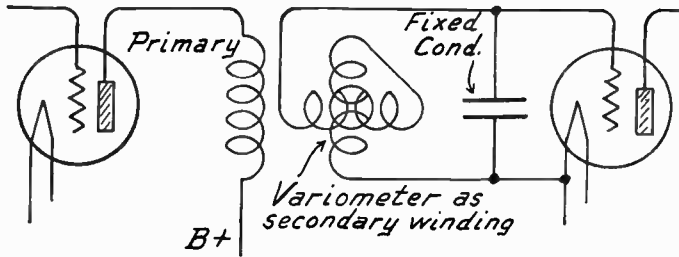

FIG. 2.—Variometer Used as Secondary of Tuned Transformer for Coupling.

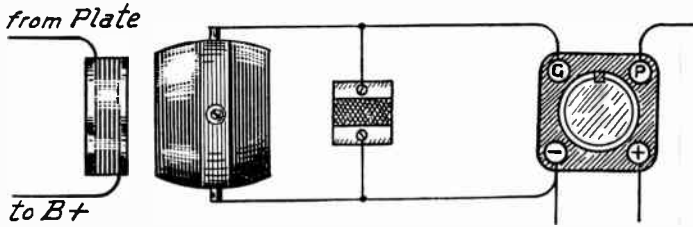

FIG. 3.—Layout of Variometer Used in Tuned Transformer for Coupling.

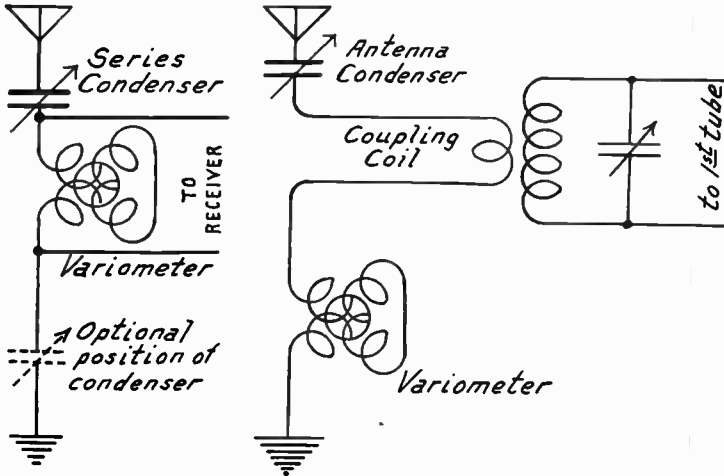

FIG. 4.—Variometer and Series Condenser for Antenna.

FIG. 5.—Variometer Tuned Antenna with Loose Coupling.

VARIOMETER, REGENERATION WITH

when using a variable condenser and fixed coil. This arrangement of a variometer for tuning makes use of the maximum inductance and the minimum capacity for all frequencies.

The antenna circuit may be tuned with a variometer in series with an antenna series condenser as in Fig. 4. The two leads running toward the right may lead to an amplifying tube or a detector. In Fig. 5 is shown a method of tuning the antenna with a variometer while still obtaining loose coupling, something that cannot be done with the arrangement at the left.

Between the variable antenna condenser and the variometer is connected a coil consisting of only a few turns of wire. This coupling coil forms the primary of a coupler or radio frequency transformer in which the coupling may be made as loose as desired. See also *Antenna, Tuned*.

VARIOMETER, REGENERATION WITH.—A variometer may be used in the plate circuit of a detector tube to obtain regeneration. The method is described under *Regeneration, Methods of Obtaining*.

VARIOMETER, SPLIT TYPE.—The two windings of a variometer may be separated from each other at the center connection and the two coils may then be used as the primary and secondary of a coupler. The connections are shown in Fig. 1. This makes

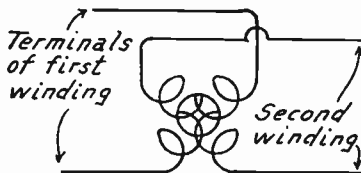

FIG. 1.—Split Variometer Circuit.

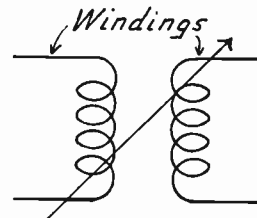

FIG. 2.—Equivalent Circuit.

a variable coupling unit which is the equivalent of the arrangement of two separate coils or windings indicated in Fig. 2.

VARIOMETER, TUNING WITH.—See *Variometer, Coupling with*.

VARNISH.—See *Binders*.

VARNISHED CLOTH.—See *Cloth, Insulating*.

VERNIER CONDENSER.—See *Condenser, Verniers for*.

VERNIER DIAL.—See *Dial, Tuning, Vernier*.

VERNIER RHEOSTAT.—See *Rheostat, Vernier*.

VIBRATING CHARGER.—See *Charger, Battery, Vibrating Type*.

WISE.—See *Tools*.

VOLT.—The unit of electromotive force or electrical pressure. One volt is the pressure required to send a current of one ampere through a circuit whose resistance is one ohm. See *Electromotive Force*; also *Potential*.

VOLTAGE, AMPLIFICATION OF.—See *Tube, Amplification of*; also *Amplification, Voltage and Power*.

VOLTAGE, CALCULATION OF.—See *Law, Ohm's*.

VOLTAGE, CHANGER FOR

VOLTAGE, CHANGER FOR.—See *Power Unit*.

VOLTAGE, DIVIDER OF.—See *Potentiometer*.

VOLTAGE, DROP OF.—See *Law, Ohm's*; also *Potential, Difference of*.

VOLTAGE, FREE GRID.—See *Tube, Characteristics of*.

VOLTAGE, GRID.—See *Tube, Characteristics of*.

VOLTAGE, PLATE.—See *Tube, Characteristics of*.

VOLTAGE REGULATION.—See *Regulation, Voltage*, also *Power Unit, Voltage Regulator for*.

VOLTMETER.—See *Meters, Ampere and Volt*.

VOLTMETER, VACUUM TUBE.—See *Meter, Vacuum Tube*.

VOLUME.—Volume is a measure of the intensity or loudness of the sounds produced in a loud speaker by a radio receiver. Volume is the final result of all amplification in the receiver circuits. While volume is the product of amplification and original signal strength, it is not a measure of amplification only. See *Amplification*.

VOLUME, CONTROL OF.—The volume from a receiver may be reduced by two principal methods; first by reducing the strength of signal voltage to the detector, and second by reducing the amplification in the audio frequency amplifier. The first method is to be preferred as will be shown.

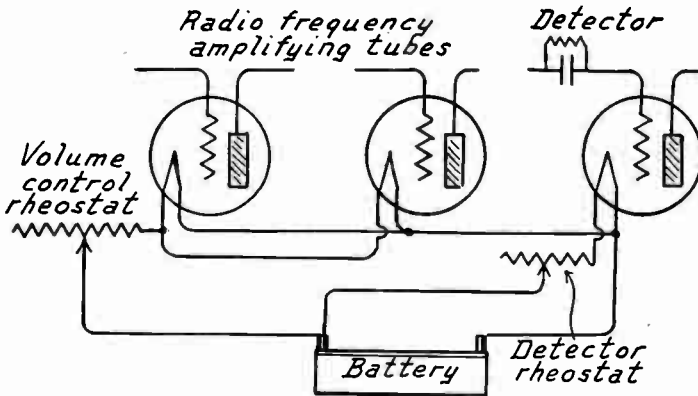

FIG. 1.—Volume Control with Radio Frequency Rheostat.

It is practically impossible to overload radio frequency amplifier tubes to the point where distortion occurs in the radio frequency amplifier. But it is comparatively easy to overload the detector tube by applying too great signal voltage from the radio amplifier and it is very easy to overload the audio frequency amplifier tubes with a strong signal from the detector.

VOLUME, CONTROL OF

If the radio amplifier is allowed to operate with full amplification on strong incoming signals from the antenna, the amplified voltage will overload the detector and will cause blocking and distortion in the detector output. No amount of volume control applied to the audio amplifier will correct distortion in the detector tube output. Therefore it is better to control the output of the radio frequency amplifier or control the input to the detector, which is the same thing, than to control only the audio frequency amplification.

Controlling Signal Voltage to Detector.—One of the easiest and simplest methods of controlling the input to the detector is to reduce the filament voltage of the radio frequency amplifier tubes by means of a variable rheostat or a vernier rheostat controlling one or all the radio frequency tubes as in Fig. 1. Reducing the filament temperature of these tubes reduces the emission from the filaments, increases the plate circuit resistance within the tube and reduces the amplification very decidedly. On very strong signals one or more of the radio tubes may be turned off completely, the internal capacity of the tubes passing sufficient signal energy to operate the detector for ample volume.

Another satisfactory method of reducing the input to the detector is by reducing the plate voltage for the radio frequency tubes. This may be done with a variable high resistance connected between the

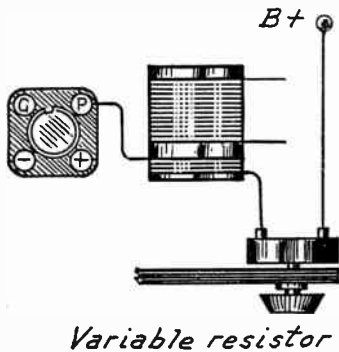

Fig. 2.—Volume Control with Resistor in Plate Circuit.

Adding resistance to the grid circuits of radio frequency tubes by any of the means described under *Oscillation* will serve to reduce and control the volume. This will also broaden the tuning and make the receiver much less selective.

Reducing the coupling of radio frequency coupling transformers will reduce the volume and one of these transformers may be built with a variable or rotating primary winding. If the radio frequency transformer coupling is changed for volume control it will alter the tuning settings and will usually upset the balance and allow regeneration and oscillation to take place.

Any method which reduces the amplification of the radio frequency stages and which reduces the voltage input to the detector will reduce the sensitiveness of the receiver and will greatly improve the ratio of signal to static.

B-battery or power supply unit terminal for the plate circuit of the radio frequency amplifier and the plate voltage terminal of the coupling device. This method is described under *Oscillation*. It is shown in Fig. 2. A resistance unit having a maximum value of 100,000 to 200,000 ohms is satisfactory for this work.

If two or more stages of radio frequency amplification are used one of them may be cut out to reduce volume on nearby stations and may then be put into use for more distant reception. Methods of accomplishing this are shown under *Jacks and Switches, Uses of*.

VOLUME, CONTROL OF

When a radio frequency amplifier is worked at the greatest possible amplification or worked with the detector close to oscillation, static noises are brought through with considerable volume. The static volume is lessened by reducing the sensitivity.

Controlling Audio Frequency Amplification.—Reducing the filament voltage of the audio frequency amplifying tubes is not a satisfactory way of controlling volume. Reduction of filament voltage increases the internal resistance of the tube and thus prevents full amplification of the lower notes. At the same time the lowered filament voltage may reduce the emission to such an extent that the peaks of the signal voltages are cut off.

It is equally unsatisfactory to reduce the plate voltage applied to the audio frequency tubes because this increases the plate resistance of the tube and prevents even amplification of all the frequencies or musical notes. Changing plate voltage on audio tubes also upsets

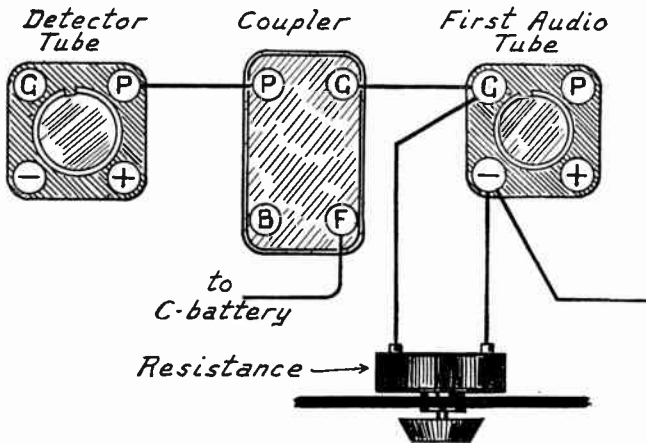

FIG. 3.—Variable Resistance for Control of Audio Frequency Volume.

the balance between grid bias or C-battery voltage and plate voltage which must be maintained to avoid distortion.

If two or more audio frequency stages are used in the receiver, one of them may be cut out to reduce the volume on powerful signals. Several methods of doing this are shown under *Jacks and Switches, Uses of*.

One of the most satisfactory methods of controlling volume in the audio amplifier is by using a variable resistance across the grid circuit of the first audio tube or by using several resistances which may be cut into this grid circuit. This does nothing except reduce the amplification by reducing the grid voltage. It will improve the tone quality in many receivers.

The use of a single variable resistance for this work is shown in Fig. 3. This resistance unit should have a maximum value of about 500,000 ohms. The coupler may be an audio frequency transformer, an audio frequency choke.

VOLUME, CONTROL OF

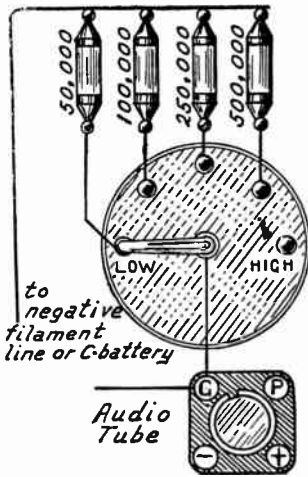

FIG. 4.—Resistor Units for Volume Control.

The resistance in ohms of the resistors should be in steps about as shown in Fig. 4. With the least resistance in circuit the volume will be least. As the greater resistances are cut in by the switch the volume will increase in steps. The last switch point is left open for maximum possible volume since

or a resistance coupler. The resistance unit may be connected across the tube terminals as shown or it may be connected from the grid terminal of the coupling unit to the filament terminal of this unit from which the connection is made to the C-battery or biasing voltage. This method of control should be applied to the first audio tube if it is used on only one stage. If applied to the second audio tube and not to the first, the first tube may still be overloaded and cause distortion which cannot be corrected by any control applied only to the second tube.

The use of a number of fixed high resistances with a volume control switch is shown in Fig. 4. The switch in Fig. 4 has five positions but any desired number may be used. The switch with its resistance units is connected between the grid terminal of the first audio frequency tube and the negative filament terminal, the connection being the same in effect as that of the resistance in Fig. 3.

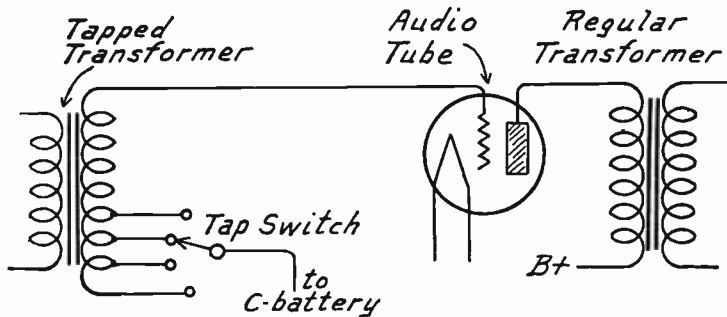

FIG. 5.—Volume Control with Tapped Secondary in Transformer.

with the switch arm on the open point there is no resistance shunted across the tube and there is no reduction of signal voltage. By using a switch with a double arm and two sets of contact points the method of Fig. 4 may be applied to two audio frequency tubes at the same time. The resistances applied to the second tube should be somewhat higher than those used for the first tube alone, say on the order of 100,000; 200,000; 500,000 and 1,000,000 ohms. The resistance values may be changed until a satisfactory range of volume is secured for all purposes. The higher the resistance the greater the volume and the lower the resistance the lower the volume on any step of the control.

VOLUME, INCREASE OF

Control of volume has been secured by using a special audio frequency transformer with a tapped secondary winding as shown in Fig. 5. The taps from the transformer winding are brought out to a switch within reach of the operator. This method has the advantage of using the highest turn ratio for maximum volume and of using a lower effective ratio for stronger signals where the best quality is desired.

Automatic Volume Control.—Several systems have been devised in which the signal strength automatically controls the loud speaker volume. In addition to the automatic control a manual control is provided, this manual control being set for the desired volume which is thereafter maintained quite closely regardless of such factors as fading, geographical distance of stations, etc.

One system makes use of a two-element detector tube with which the direct current component in the plate circuit is used to vary the grid bias of the radio frequency amplifying tubes. The audio frequency changes in the detector output are filtered out from the direct current. Increase of signal strength tends to increase the rectified direct current which acts upon the grid circuits of the radio frequency tubes. Increasing their bias reduces their plate current and their amplification in proportion to the bias.

VOLUME, INCREASE OF.—Volume may be increased by any method that increases amplification. See *Amplification, Voltage and Power*. Volume is increased by using additional stages of either radio frequency amplification or of audio frequency amplification. It is also increased by using a power tube in the last audio stage. See *Tube, Amplifying Types of*; also *Amplifier, Audio Frequency, Power Type*.

The effect of grid bias on volume is treated under *Bias, Grid*.

The normal volume of a receiver may be reduced by various faults and troubles in the parts and circuits. Cases of this nature are considered under *Trouble, Receiver, Location and Remedy of*.

VOLUME LEAKAGE.—See *Leakage, Surface and Volume*.

V. T.—An abbreviation for vacuum tube. See *Tube*.

VULCANIZED FIBRE.—See *Fibre*.

W

W.—The symbol for energy in watt-hours, joules, etc.

WATT.—The watt is the practical unit of electrical power. A power of one watt is produced by a current of one ampere at a pressure of one volt. The number of watts of power is found by multiplying the number of amperes flowing in a circuit by the number of volts drop in the circuit or by the voltage measured across the ends of a circuit.

WATT-HOUR.—A unit of electrical work. One watt-hour is the work done by a power of one watt in one hour.

WAVE.—A wave is a disturbance in some elastic substance, the disturbance having a regular period or frequency both as to time between repetitions and as to extent or strength. A sound wave is a disturbance in the elastic medium air. An electric wave is a disturbance in the ether. The ether is assumed to pervade all things.

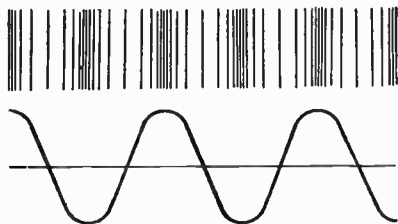

A Wave Disturbance and Its Symbol.

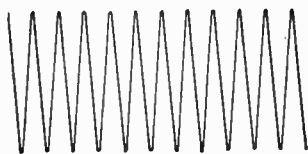

A Continuous Wave.

WAVE BAND.—See *Band, Wave*.

WAVE, CARRIER.—The high frequency wave sent out from a transmitting station. See *Band, Wave; Radiation; also Modulation*.

WAVE, CONTINUOUS.—A radio frequency wave which does not vary in frequency nor in amplitude but which continues with uniformity as long as transmitted. Abbreviated C. W.

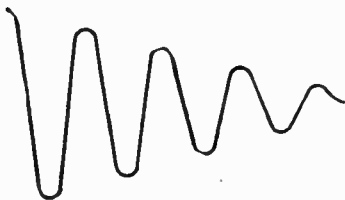

A Damped Wave.



An Interrupted Continuous Wave.

WAVE, DAMPED.—A wave whose amplitude or strength decreases from maximum to minimum because of damping or resist-

WAVE FILTER

ance in the circuit from which the wave is emitted. See also *Damping*.

WAVE FILTER.—See *Trap, Wave*.

WAVE, INTERRUPTED CONTINUOUS.—Continuous waves which are interrupted or stopped at intervals to form the dots and dashes of the telegraphic code. Abbreviated I. C. W.

WAVELENGTH.—The distance, usually measured in meters, which is covered by one complete radio wave in space from the peak of one positive alternation to the peak of the next positive alternation. The more rapidly the waves follow one another the shorter will be the wavelength and the greater will be the frequency. Thus there is a very definite relation between wavelength and frequency. See *Wavelength, Frequency Relation to*.

WAVELENGTH, ANTENNA FUNDAMENTAL.—See *Antenna, Fundamental Frequency of*.

WAVELENGTH, FREQUENCY RELATION TO.—Wavelength is the distance from the positive alternation of one wave to the positive alternation of the following wave as indicated in Fig. 1. If the waves are being sent out from the transmitter at

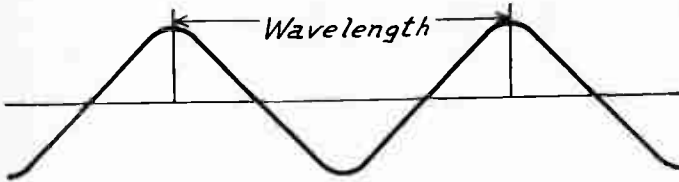

FIG. 1.—Wavelength.

such intervals that the crest of one has traveled 300 meters away from the transmitter before the crest of the second one starts, we have a separation of 300 meters between the two waves and we say transmission is on a 300 meter wavelength. If the frequency is lowered so that the first wave has had time to get 500 meters away from the transmitter before the second one starts, then we are transmitting on a wavelength of 500 meters.

It is easy to see that the more frequently the waves are sent out the less distance there will be between two successive waves. In other words, the faster the waves are sent out or the greater the frequency at which they are transmitted, the shorter will be the wavelength or the distance between successive waves. The less the frequency the greater will be the distance between the two successive waves and the longer will be the wavelength. This is shown in Fig. 2.

In the earlier days of radio it was customary to say that transmitters were operating at certain wavelengths and the receivers were tuned to a certain wavelength. Unfortunately this use of the length of a radio wave measured in meters is misleading, since it does not

WAVELENGTH, FREQUENCY RELATION TO

give a correct idea of the electrical separation between stations as they are tuned in by a receiver. For instance, there is twice the separation in frequency between two stations operating at 303 meters and at 309 meters as there is between two stations operating at 536 meters and 546 meters. The separation in wavelength between the latter two stations is ten meters while between the first two it is only six meters, yet the stations at 536 and 546 meters are only ten kilocycles apart while those at 303 and 309 meters are twenty kilocycles apart.

Radio waves travel away from the transmitter with the speed of light which is about 186,333 miles a second or 299,820,000 meters a second. The first wave will have traveled this distance, 299,820,000 meters at the end of the first second. If the waves are being sent out at a frequency of 600,000 per second there will be 600,000 complete waves between the station and the first wave sent out, that is, there will be 600,000 waves in a space of 299,820,000 meters. Therefore, each wave of the lot must be equal in length

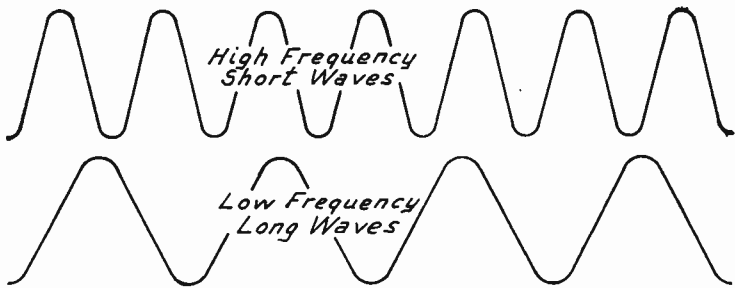

FIG. 2.—Frequency Relation to Wavelength.

to the distance divided by the number of waves or the frequency. In this particular case each wave would be 499.7 meters long and this station would be using a wavelength of 499.7 meters or approximately 500 meters.

In order to translate wavelength in meters into kilocycles of frequency divide 300,000 by the number of meters of wavelength. In order to change frequency in kilocycles to meters of wavelength divide 300,000 by the number of kilocycles. For more accurate results we would use the number 299,820 in place of the number 300,000 but the division would be more difficult and the result from using 300,000 is usually accurate enough.

There is a great advantage in thinking of kilocycles rather than of wavelength because the broadcasters and all other transmitters are assigned to certain frequencies in kilocycles rather than to certain wavelengths. As a general rule broadcasters and others operate at frequencies which are multiples of 5 or 10, that is, the number designating the frequency ends in a 5 or a 0. Wavelengths derived

WAVELENGTH, FREQUENCY RELATION TO

from these frequencies follow no such rule and generally end in a decimal fraction, something very inconvenient to work with.

The following table shows the relation between frequencies in kilocycles and meters of wavelength for the broadcasting band:

FREQUENCY IN KILOCYCLES TO METERS OF WAVELENGTH

Frequency in Kilocycles	Wavelength in Meters	Frequency in Kilocycles	Wavelength in Meters	Frequency in Kilocycles	Wavelength in Meters
550	545.1	900	333.1	1250	239.9
560	535.4	910	329.5	1260	238.0
570	526.0	920	325.9	1270	236.1
580	516.9	930	322.4	1280	234.2
590	508.2	940	319.0	1290	232.4
600	499.7	950	315.6	1300	230.6
610	491.5	960	312.3	1310	228.9
620	483.6	970	309.1	1320	227.1
630	475.9	980	305.9	1330	225.4
640	468.5	990	302.8	1340	223.7
650	461.3	1000	299.8	1350	222.1
660	454.3	1010	296.9	1360	220.4
670	447.5	1020	293.9	1370	218.8
680	440.9	1030	291.1	1380	217.3
690	434.5	1040	288.3	1390	215.7
700	428.3	1050	285.5	1400	214.2
710	422.3	1060	282.8	1410	212.6
720	416.4	1070	280.2	1420	211.1
730	410.7	1080	277.6	1430	209.7
740	405.2	1090	275.1	1440	208.2
750	399.8	1100	272.6	1450	206.8
760	394.5	1110	270.1	1460	205.4
770	389.4	1120	267.7	1470	204.0
780	384.4	1130	265.3	1480	202.6
790	379.5	1140	263.0	1490	201.2
800	374.8	1150	260.7	1500	199.9
810	370.2	1160	258.5		
820	365.6	1170	256.3		
830	361.2	1180	254.1		
840	356.9	1190	252.0		
850	352.7	1200	249.9		
860	348.6	1210	247.8		
870	344.6	1220	245.8		
880	340.7	1230	243.8		
890	336.9	1240	241.8		

WAVELENGTH, RESONANCE FOR.—See *Resonance, Inductance-Capacity Values for.*

WINDING, COIL, METHODS OF

tive headings in the section on coils. It is quite difficult to hand wind any type of coil so that its construction and workmanship in general will be a match for the commercial articles made by special machinery. Great difficulty is found in making two or more coils by hand so that they have the same inductance, the same distributed capacity, the same resistance and the same characteristics when in operation.

In winding any coil it is important to see that the spacing between turns, if spaced turns are used, remains the same throughout the entire coil as in Fig. 1. If the turns are close wound they should be really close wound as in Fig. 2, not pressed tightly together for part of the turns and then left loose for the remainder.

The wire must be straight as it is wound onto the form. Kinks and bends will prevent proper spacing of turns. Between the spool from which the wire is taken and the form on which it is being wound the wire should run through a piece of cloth held in the hand or better still run between two pieces of soft fibre or heavy canvas

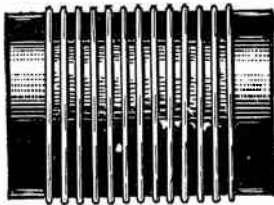

FIG. 1.—Space Wound Coil.

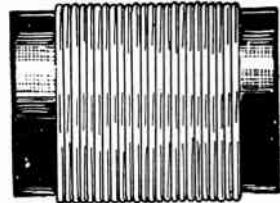

FIG. 2.—Close Wound Coil.

pressed together with spring tension. Wire that is badly twisted to begin with may be made straight and true in this manner.

Novices in coil winding generally are troubled with the turns being loose on the form after the work is completed. This makes a coil whose action will be changeable and uncertain when used for tuning. Such trouble may be avoided by winding the wire while it is hot. In cooling, the wire will then contract tightly around the form and will remain permanently tight.

There is little use in paying so much attention to the reduction of electrical losses that the finished coil is mechanically weak. Such a coil may give excellent results when new and when first installed, but it will give trouble later on when it begins to shake apart and when its joints start to corrode. It is far more satisfactory in the long run to build a strong and rugged coil, even though it may have slightly greater loss than the ideal form. There is generally a real advantage in fastening the end turns or all the turns with some good binder or cement for the sake of moisture-proofness and permanence.

Methods of winding are described for the various types of coils under their names following the general heading *Coil*. See also *Coil, Design* for the effect of winding methods.

WAVELENGTH, FREQUENCY RELATION TO

from these frequencies follow no such rule and generally end in a decimal fraction, something very inconvenient to work with.

The following table shows the relation between frequencies in kilocycles and meters of wavelength for the broadcasting band:

FREQUENCY IN KILOCYCLES TO METERS OF WAVELENGTH

Frequency in Kilocycles	Wavelength in Meters	Frequency in Kilocycles	Wavelength in Meters	Frequency in Kilocycles	Wavelength in Meters
550	545.1	900	333.1	1250	239.9
560	535.4	910	329.5	1260	238.0
570	526.0	920	325.9	1270	236.1
580	516.9	930	322.4	1280	234.2
590	508.2	940	319.0	1290	232.4
600	499.7	950	315.6	1300	230.6
610	491.5	960	312.3	1310	228.9
620	483.6	970	309.1	1320	227.1
630	475.9	980	305.9	1330	225.4
640	468.5	990	302.8	1340	223.7
650	461.3	1000	299.8	1350	222.1
660	454.3	1010	296.9	1360	220.4
670	447.5	1020	293.9	1370	218.8
680	440.9	1030	291.1	1380	217.3
690	434.5	1040	288.3	1390	215.7
700	428.3	1050	285.5	1400	214.2
710	422.3	1060	282.8	1410	212.6
720	416.4	1070	280.2	1420	211.1
730	410.7	1080	277.6	1430	209.7
740	405.2	1090	275.1	1440	208.2
750	399.8	1100	272.6	1450	206.8
760	394.5	1110	270.1	1460	205.4
770	389.4	1120	267.7	1470	204.0
780	384.4	1130	265.3	1480	202.6
790	379.5	1140	263.0	1490	201.2
800	374.8	1150	260.7	1500	199.9
810	370.2	1160	258.5		
820	365.6	1170	256.3		
830	361.2	1180	254.1		
840	356.9	1190	252.0		
850	352.7	1200	249.9		
860	348.6	1210	247.8		
870	344.6	1220	245.8		
880	340.7	1230	243.8		
890	336.9	1240	241.8		

WAVELENGTH, RESONANCE FOR.—See *Resonance, Inductance-Capacity Values for.*

WAVELENGTH, STRAIGHT LINE CONDENSER FOR

WAVELENGTH, STRAIGHT LINE CONDENSER FOR.—See *Condenser, Straight Line Types*.

WAVE METERS.—See *Meters, Frequency*.

WAVE, PROPAGATION OF.—See *Radiation*.

WAVE, RADIO.—An electric wave or series of waves sent out from the aerial of a transmitting station and passing through space. Radio waves are waves of a frequency high enough to cause their travel through space. Radio waves may be caused also by many kinds of electrical disturbances, such as sparks or the rapid change of voltage and current in electric circuits. These latter radio waves are classed as interference. Radio waves will travel through conductors, wires or otherwise, being guided by the conductors. See also *Radio, Principles of*, and *Radiation*.

WAVE, SINE.—A sine wave current is an alternating current that rises and falls in the form of a sine curve. Such a wave is shown by the curve. Were it possible to place an ammeter in an alternating circuit carrying a frequency low enough so that the meter's pointer might slowly follow the rise and fall, the values at any instant might be read directly. The values for a current which

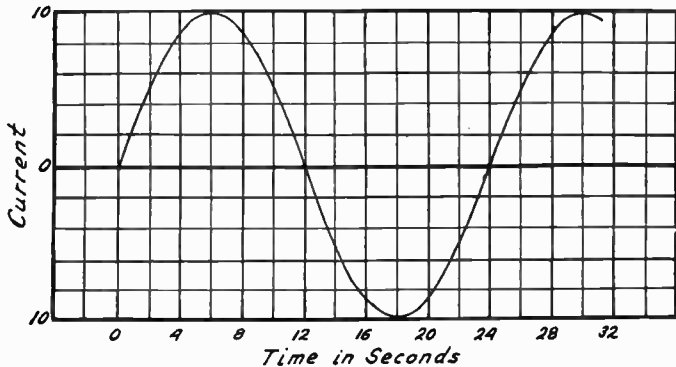

VALUES OF SINE WAVE CURRENT

Time in Seconds	Current Amps.	Time in Seconds	Current Amps.	Time in Seconds	Current Amps.
0	0.00	8	8.66	17	9.66
1	2.59	9	7.07	18	10.00
2	5.00	10	5.00	19	9.66
3	7.07	11	2.59	20	8.66
4	8.66	12	0.00	21	7.07
5	9.66	13	2.59	22	5.00
6	10.00	14	5.00	23	2.59
7	9.66	15	7.07	24	0.00
		16	8.66		

WAVE, SOUND

takes twenty-four seconds to complete one cycle are shown in the table and may be seen in the curve.

A sine wave current would be produced by a coil rotated in a uniform magnetic field. If the field is not uniform, as is usually the case, the current will not follow the true sine wave form.

WAVE, SOUND.—See *Sound*.

WAVE TRAIN.—See *Train, Wave*.

WAVE TRAP.—See *Trap, Wave*.

WAVE, UNDAMPED.—Another name for continuous wave. See *Wave, Continuous*.

WAXES, INSULATING.—Beeswax. Beeswax is an animal wax, acid free, of a dull yellow color. It melts at about 145 degrees Fahrenheit. Beeswax makes a good insulator, having a dielectric strength of about 250 volts per thousandth of an inch thickness. Its dielectric constant is 3.0 to 3.2. It has a phase angle difference or loss coefficient far higher than that of the other dielectric waxes, ceresin and paraffine.

Ceresin.—Ceresin is a prepared mineral wax having much greater dielectric strength and resistivity than either beeswax or paraffine, also having a very low loss at radio frequencies. Its dielectric constant is 2.5.

Paraffine.—Paraffine is a vegetable wax which is affected but little by any acids or other materials that attack and break down other insulating materials. Paraffine melts between 115 and 175 degrees Fahrenheit, depending on its composition. Paraffine has the lowest radio frequency loss of any of the common insulating waxes. Its dielectric strength is about 300 volts per thousandth of an inch and its dielectric constant is from 2.0 to 2.5.

See also *Resistance, Insulation*.

WEAK SIGNALS.—See *Fading; Distortion; and Trouble, Receiver, Location and Remedy of*.

WEATHER, EFFECT ON RECEPTION.—See *Range, Receiver; also Static*.

WHEATSTONE BRIDGE.—See *Bridge, Measurements by*.

WHISKER, CAT.—See *Detector, Crystal*.

WINDER, COIL.—A device which carries a form or support for a coil upon a rotating spindle or shaft so that the form may be turned while wire is fed onto it in forming a coil winding. Coil winders are of many types and kinds. Some are simple and others very elaborate, having many automatic features for spacing turns, maintaining even tension, etc. Different types of coil winders are made to handle plain cylindrical single layer coils, to handle basket weaves, honeycomb, spiderwebs and all other shapes of coils.

WINDING, BANK.—See *Coil, Bank Wound*.

WINDING, BASKET.—See *Coil, Basket Wound*.

WINDING, COIL, METHODS OF.—Forms for winding various special types of air-core coils are shown under their respec-

WINDING, COIL, METHODS OF

tive headings in the section on coils. It is quite difficult to hand wind any type of coil so that its construction and workmanship in general will be a match for the commercial articles made by special machinery. Great difficulty is found in making two or more coils by hand so that they have the same inductance, the same distributed capacity, the same resistance and the same characteristics when in operation.

In winding any coil it is important to see that the spacing between turns, if spaced turns are used, remains the same throughout the entire coil as in Fig. 1. If the turns are close wound they should be really close wound as in Fig. 2, not pressed tightly together for part of the turns and then left loose for the remainder.

The wire must be straight as it is wound onto the form. Kinks and bends will prevent proper spacing of turns. Between the spool from which the wire is taken and the form on which it is being wound the wire should run through a piece of cloth held in the hand or better still run between two pieces of soft fibre or heavy canvas

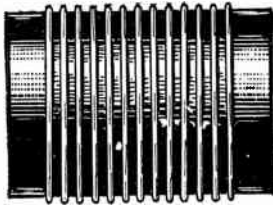

FIG. 1.—Space Wound Coil.

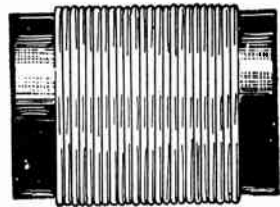

FIG. 2.—Close Wound Coil.

pressed together with spring tension. Wire that is badly twisted to begin with may be made straight and true in this manner.

Novices in coil winding generally are troubled with the turns being loose on the form after the work is completed. This makes a coil whose action will be changeable and uncertain when used for tuning. Such trouble may be avoided by winding the wire while it is hot. In cooling, the wire will then contract tightly around the form and will remain permanently tight.

There is little use in paying so much attention to the reduction of electrical losses that the finished coil is mechanically weak. Such a coil may give excellent results when new and when first installed, but it will give trouble later on when it begins to shake apart and when its joints start to corrode. It is far more satisfactory in the long run to build a strong and rugged coil, even though it may have slightly greater loss than the ideal form. There is generally a real advantage in fastening the end turns or all the turns with some good binder or cement for the sake of moisture-proofness and permanence.

Methods of winding are described for the various types of coils under their names following the general heading *Coil*. See also *Coil, Design* for the effect of winding methods.

WINDING, GRID

WINDING, GRID.—Any winding connected to the grid terminal of a vacuum tube may be called a grid winding.

WINDING, HONEYCOMB.—See *Coil, Honeycomb*.

WINDING, LATTICE.—See *Coil, Honeycomb*.

WINDING, LAYER.—A coil winding made by forming each layer evenly with the turns lying side by side and then placing all the layers evenly over each other, usually separating them with a wrapping of paper or cloth over each layer to form a foundation for the following one.

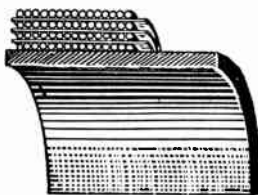

A Layer Winding.

WINDING, PLATE.—The winding of any coil which is connected to the plate terminal of a tube and which forms a part of the plate circuit is called a plate winding. The primary of a transformer is the plate winding when considered in this way.

WINDING, PRIMARY.—The input winding of a transformer is called the primary winding. See *Transformer*.

WINDING, RANDOM.—A winding made with no regard to the position of the turns or layers with reference to each other. The turns in one layer may cross other turns in the same layer and no separation is provided between successive layers.

WINDING, SECONDARY.—The output winding of a transformer. See *Transformer*.

WINDING, SINGLE LAYER.—See *Coil, Single Layer Type*.

WINDING, SPACED.—See *Coil, Space Wound*.

WINDING, SPIDERWEB.—See *Coil, Spiderweb*.

WINDING, TAPPED.—See *Coil, Tapped*.

WINDING, TRANSFORMER.—See *Transformer*.

WIRE, ALUMINUM.—Aluminum wire is very seldom used in the construction of radio receivers because of the difficulty in making good soldered joints with this metal. The resistance of aluminum wire of a given gauge size is 1.6 times that of copper wire. The weight of aluminum wire of given gauge size is approximately three-tenths that of copper wire. Aluminum makes satisfactory antenna wire.

WIRE, ANNUNCIATOR.—See *Wire, Bell*.

WIRE, ANTENNA.—See *Antenna, Wire for*.

WIRE, BARE.—Bare copper wire is sometimes used in the wiring of radio receivers and in making the windings of radio frequency coils. Bare wire used for wiring connections should be covered with fabric or rubber tubing, called spaghetti, wherever there is the slightest danger of its coming in contact with other metal parts or other wires.

Bare copper wire for connections is usually tinned to prevent corrosion. Untinned bare copper will corrode badly from the effects

WIRE, BELL

of gases in the atmosphere and will greatly increase its resistance at radio frequencies due to this surface corrosion.

WIRE, BELL.—Bell wire or annunciator wire is generally of number 18 gauge, although 16 gauge may also be had. The wire is double cotton covered and the covering is heavily impregnated with paraffine. The covering comes in white and also in various colors and color combinations. Only the white covered wire should be used in radio work.

This wire makes excellent windings for radio frequency coils. The cotton and paraffine covering has a low electrical loss, the paraffine prevents corrosion of the copper surface, and the thickness of the covering provides a desirable spacing between turns. The gauge size, number 18, is satisfactory for use at all broadcasting frequencies.

WIRE, BUS.—Bus wire or bus bar wire is tinned copper wire, either round or square in section. The tinning prevents corrosion and makes for easy soldering. The square bus wire is about 0.062 inch on a side and is the equivalent of number 14 round copper wire. Bus wire is sold in two-foot lengths and in rolls.

WIRE, CABLE TYPES.—A conductor made up of two or more separate conductors insulated from each other but bound together in a single wrapping is called a cable. The separate conductors are called leads. Conductor made of a number of uninsulated wires twisted or woven together is called stranded or braided wire.

WIRE, COIL.—See *Coil, Wire for*.

WIRE, COLORS FOR.—See *Wiring, Receiver*.

WIRE, CONNECTORS FOR.—See *Connector*.

WIRE, COPPER.—Wire made from annealed copper or soft copper is used in all radio construction for making connections and for winding all types of coils.

The table on the following page shows the gauge number, the cross sectional area in circular mils and in square inches, the ohms per foot and the number of feet per pound. These sizes are for the copper conductor alone, without insulation. The number of turns per inch of winding is given under *Wire, Turns per Inch*.

See also *Copper*. High frequency resistances are given under *Resistance, High Frequency*.

WIRE, COTTON COVERED.—Copper wire insulated with layers of cotton wound on over the metal conductor. With a single layer of cotton covering the wire is called single cotton covered, abbreviated S. C. C. With two layers it is called double cotton covered, abbreviated D. C. C.

The copper is sometimes covered first with a layer of enamel over which is laid a layer of cotton. This is called single cotton enamelled wire and is specified by the abbreviation S. C. E.

Cotton insulation has good dielectric properties and low electrical losses. The untreated cotton covering attracts moisture but quickly

WIRE, COPPER

dries out in dry air. Air-core radio frequency coil windings are made with double cotton covered wire rather than with single covered because the double covering gives a better spacing between turns and lowers the distributed capacity.

The thickness of each layer of cotton covering varies between .002 and .0025 inch so that a wire with single cotton covering will have a diameter between .004 and .005 inch greater than the bare wire. With double cotton covering the diameter will be from .008 to .012 inch greater than for bare wire.

RESISTANCE, SIZE AND WEIGHT OF COPPER WIRE

Gauge Number	Diameter in 1000ths of an Inch	Cross Section		Resistance in Ohms per Foot	Weight Feet per Pound
		Circular mils	Square inches		
10	101.9	10380.0	0.008155	.000999	31.8
11	90.74	8234.0	.006467	.001260	40.1
12	80.81	6530.0	.005129	.001588	50.6
13	71.96	5178.0	.004067	.002003	63.8
14	64.08	4107.0	.003225	.002525	80.4
15	57.07	3257.0	.002558	.003184	101.4
16	50.82	2583.0	.002028	.004016	127.9
17	45.26	2048.0	.001609	.005064	161.3
18	40.30	1624.0	.001276	.006385	203.4
19	35.89	1288.0	.001012	.008051	256.5
20	31.96	1022.0	.0008023	.01015	323
21	28.46	810.1	.0006363	.01280	408
22	25.35	642.4	.0005046	.01614	514
23	22.57	509.5	.0004002	.02036	648
24	20.10	404.0	.0003173	.02567	818
25	17.90	320.4	.0002517	.03237	1031
26	15.94	254.1	.0001996	.04081	1300
27	14.20	201.5	.0001583	.05147	1639
28	12.64	159.8	.0001255	.06490	2067
29	11.26	126.7	.0000995	.08183	2607
30	10.03	100.5	.0000789	.103	3287
31	8.93	79.7	.0000626	.130	4145
32	7.95	63.2	.0000496	.164	5227
33	7.08	50.1	.0000394	.207	6591
34	6.31	39.7	.0000312	.261	8310
35	5.62	31.5	.0000248	.329	10480
36	5.00	25.0	.0000196	.415	13210
37	4.45	19.8	.0000156	.523	16660
38	3.97	15.7	.0000124	.660	21010
39	3.53	12.5	.00000979	.832	26500
40	3.15	9.9	.00000777	1.049	33410

WIRE, CURRENT CARRYING ABILITY

WIRE, CURRENT CARRYING ABILITY.—Copper wire in transformers and chokes will safely carry a maximum number of milliamperes equal to the number of circular mils of cross section.

WIRE, ENAMELLED.—Enamel covered copper wire is generally used in all types of radio parts. The enamel is applied soft and then baked. The finished wire will stand high temperatures, a safe continuous working temperature being in the neighborhood of the boiling point of water. Enamel insulation will fail around 500 degrees Fahrenheit. Enamel has the advantage of being moisture-proof. It is quite tough and an enamelled wire may be bent around its own diameter without cracking the covering.

Enamelled wire should not be used for radio frequency coils because the enamel is a poor dielectric and alone does not provide sufficient space between turns to avoid high distributed capacity.

The enamel covering varies in thickness with the gauge of wire on which it is applied. The thickness on the very small sizes is about .0006 inch and on the large sizes runs up to about .002 inch.

WIRE, GAUGE SIZE OF.—See *Wire, Copper*.

WIRE, LITZENDRAHT.—See *Wire, Stranded*.

WIRE, MAGNET.—Copper wire used for winding various kinds of coils, both air-core and iron-core, is called magnet wire. It is insulated with various combinations of cotton, silk and enamel.

WIRE, RESISTANCE OF, OHMIC.—See *Wire, Copper*.

WIRE, RESISTANCE OF, HIGH FREQUENCY.—See *Resistance, High Frequency*.

WIRE, RESISTANCE TYPES OF.—See *Resistance, Materials for*.

WIRE, RUBBER COVERED.—Rubber covered wire is often used for making connections between the various parts of radio receivers. The rubber covering resists acids and the action of atmospheric gases and is an excellent insulator. No wire except that which is rubber covered should be used around storage batteries.

The sulphur used in vulcanizing the rubber will cause excessive oxidation of the copper in a wire that is rubber covered, thus increasing the wire's resistance at radio frequencies. The strands of copper wire should first be tinned before the rubber is applied and tinned rubber covered wire should be specified for radio work.

WIRE, SILK COVERED.—Copper wire insulated with one or more layers of silk wound over the conductor is called silk covered wire. With one layer of silk it is called single silk covered, abbreviated S. S. C., and with two layers it is called double silk covered and abbreviated D. S. C. The insulation is sometimes made from a layer of enamel with a layer of silk over it, this being called single silk enamelled wire and abbreviated S. S. E.

As an insulator silk is better than cotton and it is less affected by moisture in the air. The silk insulation should always be of double thickness for use in radio frequency coils because single silk covering lets the turns come too close together.

WIRE, SIZES AND GAUGES OF

The thickness of silk covering is only about half that of cotton covering. Each layer of silk is about .001 inch thick so that single silk covered wire has a diameter about .002 inch greater than that of the bare wire and double silk covering makes the diameter from .004 to .005 inch more than that for bare wire.

WIRE, SIZES AND GAUGES OF.—See *Wire, Copper*.

WIRE, SOLID.—Any wire made of only a single piece of conductor, without being stranded or braided from several smaller pieces, is called a solid wire.

WIRE, STRANDED.—A group of small wires used together as a single conductor is called a stranded wire. Stranded wire is flexible and will stand a great deal of bending without breakage of the conductor. In ordinary stranded wire the separate small wires are bare and are twisted or woven together. Such wire may have a greater resistance at high frequencies than a solid wire of the same

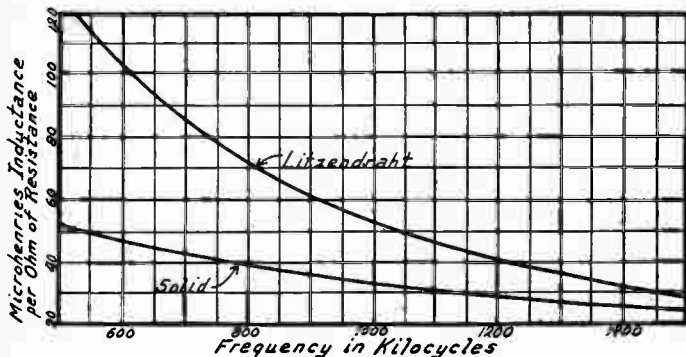

Comparative Inductance and Resistance of Stranded Litz Wire and Solid Wire

effective gauge size. Woven wire is more efficient in this way than twisted wire. It might be thought that the greater total surface area of all the small wires would lower the skin effect and lower the high frequency resistance. This is not true because there are small currents continually flowing through the points of contact between the small wires and this contact resistance may be quite high.

Litzendraht Wire.—This is a special stranded wire made up of a large number of small wires each of which is enamel covered so that they are insulated from one another. The strands are woven in such a way that each separate strand is on the surface of the wire for the same proportion of the total length as each other strand. This wire is specified according to the number of strands and the gauge size of one strand. Thus number 32-38 Litzendraht wire is made of thirty-two strands of number thirty-eight enamelled wire. The entire conductor is covered with silk or cotton.

WIRE, TURNS PER CENTIMETER

Litzendraht wire, or Litz wire as it is usually called, reduces the skin effect and the effective resistance compared with solid wire. Litz wire is most effective around the lower frequencies or higher wavelengths in the broadcasting band. Litz wire is often used for winding loop antennas. When used for windings of radio frequency coils the distributed capacity of the coil increases more rapidly than when solid wire is used for the winding.

When using Litz wire care should be taken at joints to solder to each of the small strands. The enamel may be removed by carefully heating the wire ends and dipping them in alcohol which will remove the hot enamel. It is customary to make careful tests of each strand to see that it is not broken and to see that it is not short circuited on other strands. The effect of various numbers of broken strands on a Litz wire composed of thirty-two strands of number 38 wire is shown by the following table. The tests were made at a frequency of 750 kilocycles.

RESISTANCE OF LITZ WIRE WITH BROKEN STRANDS

Broken Strands	Resistance ohms	Broken Strands	Resistance ohms	Broken Strands	Resistance ohms
none	3.1	12	4.4	24	9.5
2	3.2	14	4.5	26	13.5
4	3.3	16	5.4	28	16.5
6	3.4	18	6.1	29	21.7
8	3.6	20	7.4	30	42.4
10	3.8	22	7.8	31	51.6

The curve shows the relation between the inductance and effective resistance in a coil wound with Litzendraht wire when used at various frequencies in the broadcasting band. The improvement at the lower frequencies is very marked when considered in comparison with the ratio for solid wire which is shown on the same graph.

This may be contrasted with the condition brought about with bare or poorly insulated wires stranded together which are found experimentally to have the same resistance as a solid conductor whose cross sectional area is equal to the sum of the cross sections of all the strands together. At the higher frequencies such stranded bare wire shows additional loss because of the passage of current from strand to strand as has been mentioned. Spiraling or twisting the strands has the effect of still further increasing the resistance in comparison with parallel straight strands. A moderate thickness of insulation around each of the separate strands materially reduces the resistance regardless of the method of stranding or the arrangement. Increase of insulation thickness beyond a moderate amount does not have a proportionate effect.

WIRE, TURNS PER CENTIMETER.—See *Coil, Inductance of.*

WIRE, TURNS PER INCH

WIRE, TURNS PER INCH.—The following tables show the number of turns of wire per inch of length and per square inch in coil windings having the turns close together.

TURNS PER INCH OF LENGTH IN SINGLE LAYER COIL WINDINGS

Gauge Size of Wire	Cotton Covered			Silk Covered			Enamel Covered
	<i>Double D. C. C.</i>	<i>Single S. C. C.</i>	<i>Enamel S. C. E.</i>	<i>Double D. S. C.</i>	<i>Single S. S. C.</i>	<i>Enamel S. S. E.</i>	
16	16.4	17.2	17.6	16.8	18.0	18.2	19.2
17	18.1	18.8	19.4	18.5	20.2	20.5	21.3
18	20.0	21.0	21.5	20.8	22.5	22.9	23.8
19	21.8	23.6	24.0	23.2	25.5	26.0	27.0
20	24.0	26.4	27.0	25.5	28.0	28.6	30.0
21	26.2	29.7	29.5	28.7	31.3	31.8	34.2
22	28.6	32.1	32.5	31.0	34.8	35.2	38.4
23	31.2	36.4	36.1	34.3	38.2	38.7	41.8
24	33.6	39.0	39.5	38.0	43.0	43.5	47.7
25	36.2	43.1	43.3	41.5	47.7	48.1	52.6
26	40.0	47.0	47.5	45.8	52.4	53.0	59.0
27	42.6	51.2	52.0	50.0	58.0	58.8	66.6
28	45.5	56.5	57.5	53.5	64.7	65.0	77.0
29	48.0	61.4	62.3	58.5	71.3	71.4	83.3
30	51.0	67.6	67.2	66.5	80.2	80.5	91.0
31	56.8	72.3	72.5	71.7	87.9	88.0	100.0
32	60.0	79.0	79.0	76.2	95.0	94.3	116.5
33	64.4	85.0	85.4	83.0	105.1	106.0	129.8
34	68.6	91.8	91.7	88.7	110.0	110.0	142.8
35	73.0	98.6	97.8	104.3	130.9	129.0	160.6
36	78.6	106.0	103.5	110.4	140.0	136.0	178.6
37	84.0	114.0	111.0	115.0	150.0	143.0	200.0
38	89.0	123.0	118.0	120.0	160.5	154.0	222.0
39	95.0	131.0	130.0	131.0	182.0	175.0	245.0
40	102.0	139.0	139.0	140.0	200.0	195.0	270.0

The effect of various insulations on the spacing of wires in coils is clearly shown by the above table. For example, number 22 bare copper wire winds approximately 39.5 turns per inch.

While the values given in these tables are approximately correct for wire in general use it should be understood that the exact number of turns per inch will vary slightly according to the manufacturer and according to the grade and thickness of insulation used to cover the wire. This is the reason for variations between tables such as those presented here.

WIRED RADIO

TURNS PER SQUARE INCH OF SOLID LAYER WINDINGS

Wire Gauge	Wire Insulation						
	<i>Enamel</i>	<i>Single Cotton</i>	<i>Double Cotton</i>	<i>Cotton Enamel</i>	<i>Single Silk</i>	<i>Double Silk</i>	<i>Silk Enamel</i>
20	882	742	565	683	857	770	790
21	1110	910	675	835	1065	945	978
22	1380	1142	875	1040	1322	1155	1200
23	1725	1390	1040	1260	1635	1410	1475
24	2160	1690	1230	1525	2030	1720	1820
25	2715	2060	1445	1800	2495	2085	2235
26	3425	2465	1700	2230	3050	2550	2755
27	4300	2975	1975	2680	3745	3050	3375
28	5410	3565	2300	3200	4650	3660	4125
29	6730	4200	2610	3785	5585	4290	4980
30	8475	5000	3000	4475	6880	5125	5945
31	10425	5845	3370	5225	8335	6050	7235
32	13000	6825	3810	6130	9930	7000	8730
33	16550	7950	4250	7160	11950	8200	10525
34	20500	9210	4650	8215	14375	9520	12400
35	25500	10575	5200	9400	17000	10950	14700
36	31800	12000	5670	10700	20125	12520	17250
37	39800	13450	6150	12200	23500	14200	20300
38	49200	15100	6600	13550	27550	16000	23650
39	62500	16750	7050	15300	31900	18000	27900
40	77000	18500	7500	16850	36850	20000	32000

See also *Coil, Choke.*

WIRED RADIO OR WIRED WIRELESS.—See *Radio, Wired.*

WIRELESS.—A name applied to radio telegraphy and formerly to the whole field of radio communication.

WIRING, RECEIVER.—Upon the proper arrangement of the wiring depends much of the sensitivity and selectivity of a receiver. The various circuits may be considered one at a time in planning and laying out the complete wiring job. In considering the proper arrangement the following outline is a convenient guide since it classifies the wires according to their functions and their importance.

The wires which must be treated with greatest consideration as to their position and length include: The connection from the antenna to the first tuned circuit or to the grid of the first tube; all of the connections between the grid terminals of the tubes and the coils, transformers, chokes, resistances or condensers to which these wires attach; all of the connections between the plate terminals

WIRING, RECEIVER

of the tubes and the coils, transformers, etc., to which these wires attach. All such wires for a typical five tube receiver are shown in Fig. 1.

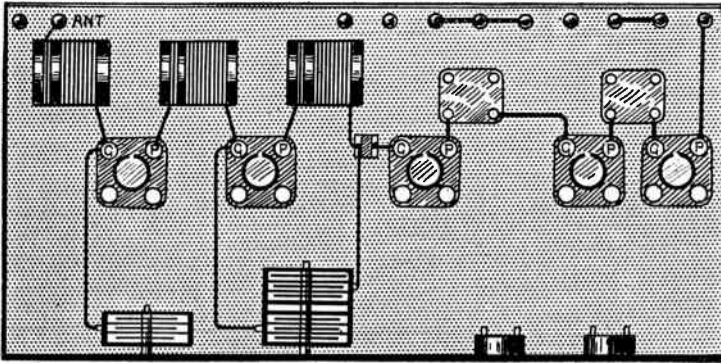

FIG. 1.—Grid and Plate Wiring Which Must Be Given First Consideration.

Wires which are next in importance include all which enter into circuits for the control of oscillation, regeneration and volume. These are the wires attached to neutralizing or balancing condensers or to any condensers or resistances used for control purposes.

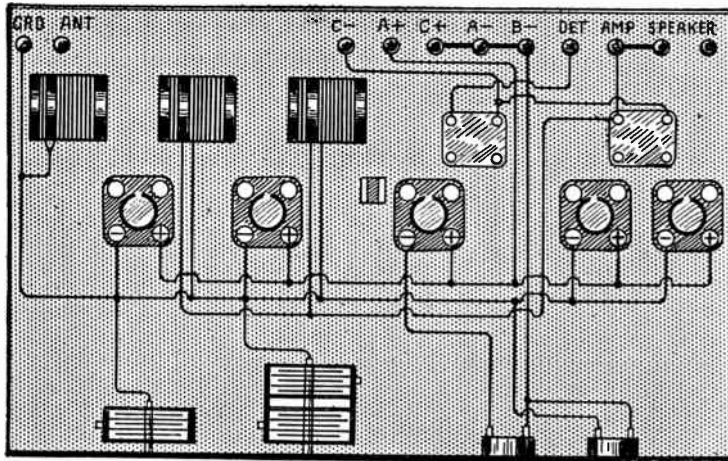

FIG. 2.—Battery, Power Supply and Ground Wiring for Receiver.

All the remaining wires are in the ground lines or in the battery lines. These are at the lowest voltage and they do not carry high frequency currents. Therefore all such wires may be placed in the

WIRING, RECEIVER

least important class. This class will include: All wires connected to the B-battery or power supply unit, all connected to the A-battery and all connected to the C-battery. This class also takes in all wires which are connected to the ground. Fig. 2 shows all these wires for the usual five tube receiver.

The parts which compose the receiver should be laid out so that the several classes of wires may be treated with due consideration. Parts which determine the wiring arrangement include tuning condensers, radio frequency tuning coils, audio frequency transformers, chokes or resistances, and all tubes.

The grid wires, the plate wires and the antenna wire must be as short as possible and should run in fairly direct paths between their terminals. Grid and plate wires must not run parallel to each

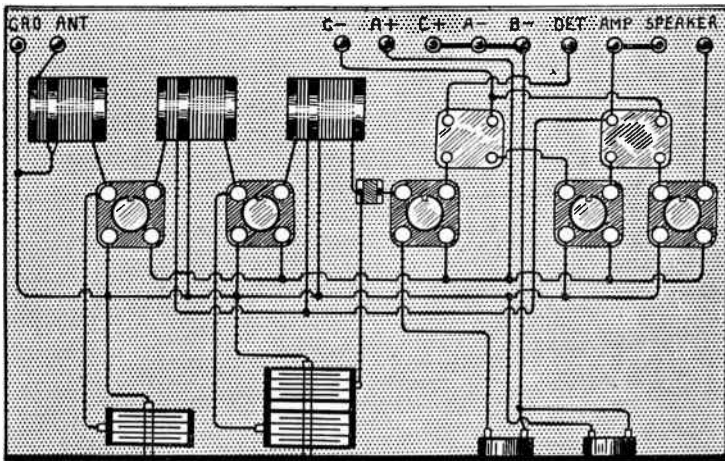

FIG. 3.—Receiver Layout for Correct Position of Wiring.

other and should be separated from each other as far as possible. When it becomes necessary to let grid and plate wires cross each other they should be approximately at right angles. The antenna wire should be kept well separated from all other wires and parts. These things are illustrated by Fig. 3.

Wires running to and from control condensers and resistances should be treated in much the same way as grid and plate wires since these control circuits are usually associated closely either with the plate circuits or the grid circuits of the receiver.

All battery wires; including all the filament wires, plate power supply wires and the grid bias wires; should be run together and cabled as shown in Fig. 4. The length of these wires is of no particular importance and it is far better to run them together and cabled than to save in length by running one or more such wires off

WIRING, RECEIVER

by themselves. The idea here is to keep these wires from forming inductive loops. These loops lead to oscillation and are apt to pick up unwanted signals independently of the tuned circuits.

Wires are seldom so long between terminals that it becomes necessary to provide supports other than afforded by the attachment at the wire ends. Cabling of the wires as shown in Fig. 4 helps to support each one from all the others. Small cleats made of metal or of fibre may be fastened to the sub-panel or base of the receiver and used for supporting long wires.



FIG. 4.—Cabling of Wiring.

Except where the ends of two wires can be fastened securely under terminal nuts it is absolutely essential that joints be soldered according to the methods explained under *Soldering*. It is best to fit all wire ends with terminals of the types shown in Fig. 5. These terminals may then be held under nuts and screws on the different units of the receiver and will insure a joint that remains in good condition. If terminals are not used the end of any stranded wire should be made into a solid piece with solder after which it can be bent into a loop or eye for proper fastening. Bare copper held under nuts and screws will corrode and cause a poor connection in time. The copper should always be tinned where exposed to the air.

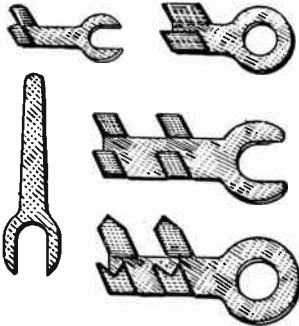

FIG. 5.—Wiring Terminals.



FIG. 6.—Lead Covered Clip for Battery Connection in Wiring.

Several types of connections are shown under *Post, Binding*. Whenever wires are attached to storage batteries, either A-batteries or B-batteries, the connection should be made with lead covered terminals similar to those shown in Fig. 5 or with lead covered spring

WIRING, RECEIVER

clips of the type shown in Fig. 6. Common connections for A- and B-batteries are explained under *Battery, Connection of A- and B-*.

Wiring connections between the units forming a receiver are generally made with rubber covered stranded wire, with spaghetti covered flexible wire or with bus wire either bare or covered. Suitable types of wire are described under *Wire, Bus; Wire, Rubber Covered;* and *Wire, Stranded*. Because of mechanical strength no wire smaller than number 18 gauge should be used for connections of any kind. For filament circuits numbers 14 and 16 are preferred.

Colors of Wire Connections.—A definite scheme of colors for receiver wiring has been adopted and should be followed wherever possible. Wires are made either with covering of a single solid color or are made with a cover mainly of one color but with a tracer or a single strand of some other color woven in.

In general the following plan is used:

Blue for the antenna circuit or loop circuit.

Reds and maroons for the B-battery or plate power supply circuits on their positive sides.

Yellow for the A-battery or filament circuits on their positive sides.

Green for the grid bias or C-battery circuits.

Brown for the loud speaker circuit.

Black for negative sides or low voltage sides of various circuits.

The color is chosen according to the point from which the circuit starts. Thus, circuits starting from the B-battery or power unit would be given red or maroon regardless of the other point to which connection is made.

The following list shows the colors used for the body of wires and also for the tracers in the circuits of receivers employing this scheme:

COLORS FOR RECEIVER WIRING

Antenna or grid side of loop	Blue
Ground or filament side of loop . .	Black with blue tracer
A plus, filament	Yellow
A minus, filament	Black with yellow tracer
A plus and B minus	Yellow with red tracer
A minus and B minus	Black
B plus, highest voltage	Bright red
B plus, intermediate voltage	Dark red
B plus, detector	Maroon
B plus, to speaker circuit	Red with brown tracer
B minus	Black with red tracer
C plus	Green
C plus and A minus	Green with yellow tracer
C minus, grid bias	Black with green tracer
Speaker positive	Brown
Speaker minus, plate side	Black with brown tracer
Speakers, interconnections	Brown with white tracer

When tracers are used to indicate that the wire forms a part of two different circuits the solid or principal color is chosen for the

WOOD

circuit having the higher voltage or the more positive voltage. Thus a wire in the A+ circuit and the B— circuit would have yellow as its main color because the A-battery side is of the higher voltage. The tracer would then be of red or maroon to indicate that the wire also enters into the B-battery or plate supply circuit.

WOOD.—The various kinds of wood used in radio construction have different characteristics when considered from the electrical standpoint. Hard woods are employed and when their insulating qualities are to be depended upon they are usually impregnated with paraffine. Used as insulators, woods should be placed so that the grain runs across the path that would be taken by current escaping through the wood.

Wood that has been well dried but not impregnated will stand 10,000 volts per inch of thickness. Impregnated wood ranks as an excellent insulator but moist wood is a very poor insulator.

Considered from the standpoint of electrical losses, basswood is the best of the materials commonly available. Cypress, fir, maple and white oak all have about the same degree of loss. The dielectric constants of bass, cypress and fir run between 2.0 and 3.0. The dielectric constant of maple runs as high as 4.5 while that of white oak may reach 6.0.

See also *Resistance, Insulation* for further information on woods.

WRENCHES.—See *Tools*.

X

X.—The symbol for reactance. See *Reactance*.

Y

Y.—The symbol for admittance in mhos. See *Admittance*.

Z

Z.—The symbol for impedance. See *Impedance*.

ZERO BEAT.—See *Beats, Formation of*.

THE END

