

ELECTRONICS

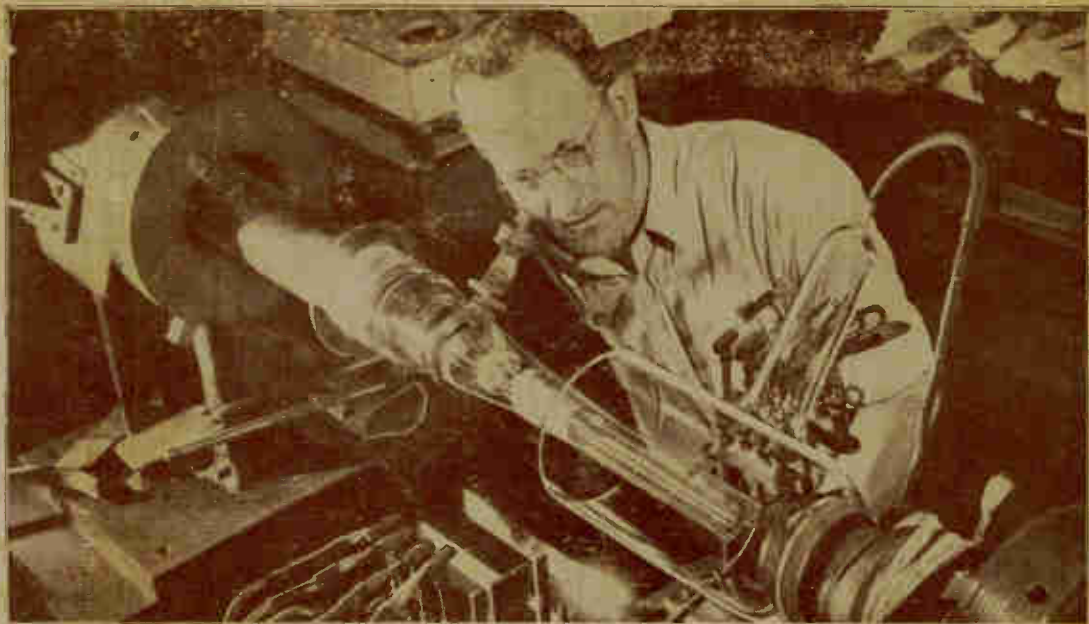

FOR RADIO MEN and ELECTRICIANS
and all those interested in
PRACTICAL ELECTRONICS

A practical Instruction Manual for Home Study and Job Use for men in Radio and Electricity, covering: OPERATION—INSTALLATION — MAINTENANCE — TESTING — TROUBLE SHOOTING

FOR

MANUFACTURING, COMMERCIAL AND HOME ELECTRONIC INSTALLATION. Includes THYRATRON, PIOTRON, PHANOTRON, KENOTRON, IGNITRON, PHOTOTUBE and others.

Published by **COYNE ELECTRICAL SCHOOL, CHICAGO, ILLINOIS**

At Last!

A PRACTICAL BOOK

ON ELECTRONICS FOR THE ELECTRICIAN OR RADIO MAN — OLD-TIMER OR BEGINNER!

Electronics has taken the industrial world by storm! Every manufacturer, mine operator, petroleum refiner, transportation executive, etc., has either installed electronic equipment or is giving it the most careful consideration.

To operate and maintain this vast array of Electronic apparatus and equipment will require an army of trained specialists. Here is an opportunity for getting into a new, uncrowded line of work — one offering an almost unlimited future. But how can a man prepare for such opportunities? **This book supplies the answer.**

In thoroughly practical, easy-to-understand language, "Electronics" describes the different kinds of tubes, their applications, servicing, testing and trouble shooting. A wealth of diagrams and illustrations is included.

Electricians — Radio Men

This handy, fact-packed manual will appeal to the man with years of electrical or radio experience who wishes to increase his earning power by becoming an electronics technician. Yet it is equally valuable to the beginner in this field.

After being studied at home, "Electronics For Radio Men and Electricians" will serve as a dependable reference guide on the job. A complete index makes it easy to locate desired data instantly.

This book can be indispensable to any man who wants to create a real future for himself in this field!

See These Sensational
New Books for

ELECTRICIANS and RADIO MEN!

APPLIED PRACTICAL ELECTRICITY

Prepared and published by the great 46-year old Coyne Electrical School for the man on the job or beginner. Seven Book Set includes: 1. Elementary Principle and Circuits Household Appliance Repairs, 2. Wiring for Light and Power, 3. D.C. Motors and Controls, 4. A.C. Motors and Controls, 5. Armature and Stator Winding and Repair, Electronics, 6. Refrigeration and Air Conditioning, Radio, 7. Automotive, Diesel, Battery.

Sent on 7 - Day FREE Trial

SEND NO MONEY. Ask to see them at my risk. If you don't want them after 7 days send them back and you owe nothing. If you keep them send \$3.00 after 7 days and \$3.00 per month until \$24.75 is paid. Cash price \$23.00. One year **FREE** Consultation Service and Bulletins if you act promptly.



BE A MASTER TROUBLE SHOOTER



Only Book of Its Kind
—Streamlined—Easy
— Thorough . . .

New **GIANT SIZE** manual on Electrical and Radio Trouble Shooting. 500 easy-to-follow diagrams. Amazing Step-by-Step Course in locating troubles on any Electrical or Radio equipment. Yours after 7 day **FREE TRIAL** for only \$3 down. \$3 monthly until \$9.95 is paid. Cash price, \$8.95—you save \$1.00.

OVER 500

Large Size Electrical and Radio Shop Prints—How to read and use them.

NEW ELECTRICIANS HANDBOOK

BRAND NEW — Just Off The Press—A Book Every Electrician Needs. 350 pages — hundreds of tables, charts, formulas — latest electrical rules, laws, methods. Includes dozens of practical ideas for "on the job" use. Be an authority on electrical questions in your plant — send for this great book **TODAY.** Price only \$3.25 after 7 day **FREE** inspection.

SEND NO MONEY: I'll ship any or all of these new Coyne books on 7 day **FREE** trial. If not satisfied return them and you owe nothing. If you keep them you can pay for them as outlined above. If order totals \$5.00 or more you can pay \$3.00 in 7 days and \$3.00 per month. Supply of books is limited due to paper restrictions. Send order **NOW** to Electrical Book Division, Dept. E.J. Coyne Electrical School, 500 S. Paulina St., Chicago, Illinois.

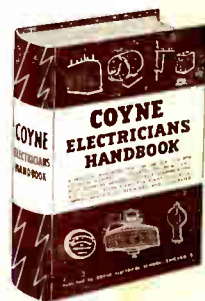

Coyne Has Kept Abreast of the Progress of Electronics Right Up To Its Present Development!

The COYNE ELECTRICAL SCHOOL, publishers of this book, is one of America's oldest, practical trade schools. It was established in 1899 as a school for men who were interested in practical "LEARN BY DOING" courses in Electricity and allied subjects. In addition to Electrical and Radio subjects Coyne has been teaching the principles of ELECTRONIC equipment from the very beginning right up to its present great development. This book covers the beginning and first uses in this field right up to its latest developments. TODAY, COYNE has a complete, practical shop course in ELECTRONICS, which has been added to our regular Electrical and Radio shop courses. In order that you may see the background behind our book "ELECTRONICS" we include below several photos of our training shops.

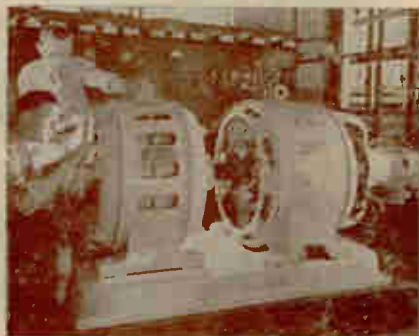

ELECTRICAL AND RADIO BOOK DIVISION

COYNE ELECTRICAL SCHOOL, CHICAGO, ILL.

Electronics

for

Electricians and Radio Men

•

An Instruction and Reference Book

•

**ELECTRONIC CONTROLS, MEASUREMENTS
AND PROCESSES FOR MANUFACTURING,
COMMERCIAL AND HOME INSTALLATIONS**

By

**THE TECHNICAL STAFF OF THE
COYNE ELECTRICAL SCHOOL**

COYNE ELECTRICAL SCHOOL, CHICAGO

1945

Copyright, 1945, By
COYNE ELECTRICAL SCHOOL
CHICAGO, ILL.

All Rights Reserved.

*This book, or any part thereof, must not
be reproduced in any form without the
written permission of the copyright owner.*

PRINTED IN THE UNITED STATES OF AMERICA

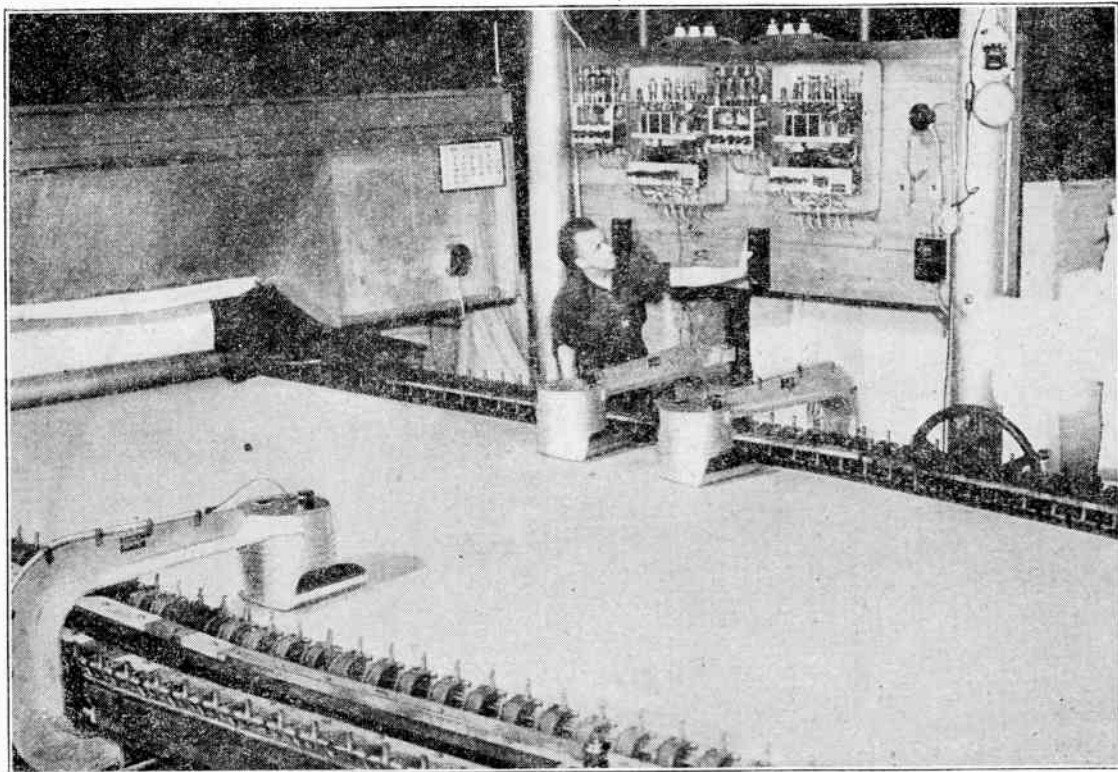

ELECTRONIC IN THE TEXTILE INDUSTRY: Electronic scanning mechanism of weft-straightening control equipment used in textile industry. Main control in background with engineer ready to start apparatus by manual control.

Electronics

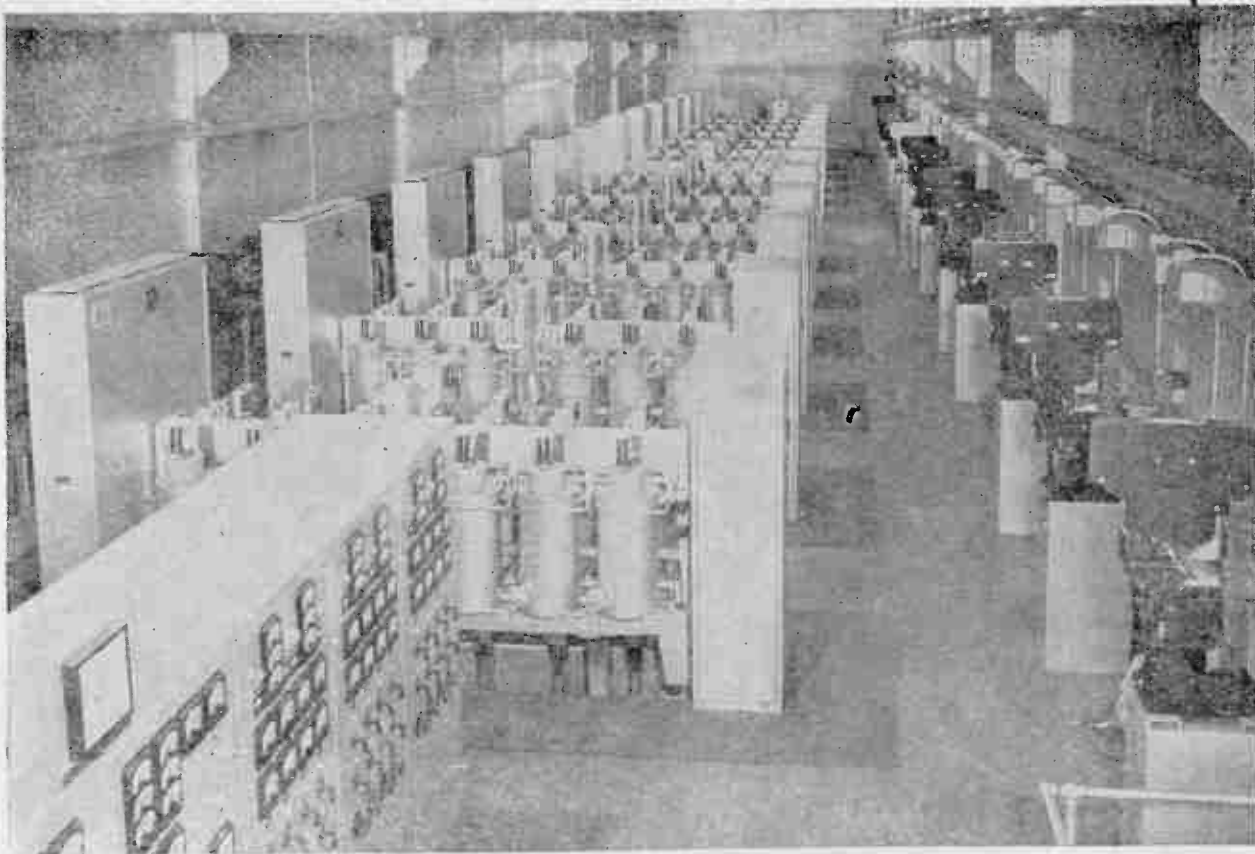

12 Unit Electronically controlled Mercury-Arc-Rectifier installation. Rectifier units are 12-anode, 5000 amperes, 645 volts. (3225 K. W.). View shows master duplex control panel (left foreground), 6-Pole high speed anode breakers (along left wall), Rectifier excitation cubicles, Ignition Rectifiers, Rectifier auxiliary control panels (left center) and Cathode Breakers (along right wall).

FOREWORD

In the last few years the application of **electronic tubes in radio, in electricity, in industry, in commerce, and in business** has been expanding with remarkable rapidity. The electron tube today is supplying the solution to many "impossible" control problems. Originally associated with and an integral part of radio, the application of the electron tube has developed until it has now invaded practically every field of applied electricity.

The rapidity with which **electronic equipment** has increased has created a demand for a book on all phases of **electronics**. It has created need for a simplified treatment of the subject that will bring a knowledge of this new field within the reach of the average person, regardless of whether or not he is directly associated with the **electrical or radio field**.

The primary purpose of this book is to give you a broad picture of the **electronic industries** as they actually exist today, enabling you to understand present methods and practices. With this knowledge you can select, install, and maintain the various types of **electronic apparatus**.

Because all of the instruction is wholly from the **electronic standpoint**, and because every technical word and term is explained in the simplest possible way the first time we use it, you need no previous knowledge whatsoever of electricity, of radio, or even of mathematics beyond simple arithmetic to understand and apply the knowledge obtainable from this book.

In studying each piece of **electronic apparatus** we shall first note the construction and how the parts perform in operation. The next step is to learn **why** they perform that way. In other fields it may be sufficient to know only the apparent manner in which equipment acts, (or is supposed to act), without knowing **why**. **Not so in electronics, for here the most important actions are invisible.** Nothing appears to move inside electronic tubes, wires and associated parts. Yet, it is the **invisible flow of electrons, with the changes of electrical pressures, that makes electronic equipment work as it does.**

In working our electronic problems, we first explain the separate elements, and the things that happen in each individual part. Then we combine these separate elements to form the complete installment. It is easy to understand the whole assembly because we already understand all its separate parts.

THIS BOOK DESIGNED FOR HOME STUDY AND FIELD REFERENCE

This book has many practical uses. It is intended both for home training and for reference work on the job. This makes it equally valuable to the experienced electrician or radio man at work in the field, as well as the "beginner," interested in learning how to install, repair and operate electronic equipment. Naturally, the experienced man will use it differently than the beginner. We present here some practical suggestions for each type of individual.

HOW THE EXPERIENCED ELECTRICIAN OR RADIO MAN CAN USE THIS BOOK

Today, more and more companies are installing electronic equipment to speed up production and to provide better safety for workers. A valuable man in any plant is the man who can keep this equipment operating to get the best possible service out of it. Naturally, the more information he has about electronic equipment, the more valuable he can be to his organization.

The experienced electrician or radio man—the fellow who has been "in the game" for some time—has great need for a reliable, authoritative complete reference book on electronics. He should have such material available at all times and be able to refer to it with confidence. This book, "ELECTRONICS" fills this need perfectly. It provides data and diagrams that have been field-tested in actual use.

REVIEW THE FUNDAMENTALS

Many veteran electricians and radio men find that it pays to brush up every now and then on the basic principles of electricity and radio.

In studying this book for information on **electronics**, don't overlook the chapters devoted to fundamentals. You'll be benefited even though much of it may be familiar to you.

MAKE YOURSELF AN ELECTRONIC TECHNICIAN

Electronics is so universal in its applications, so efficient and so time-saving, that we believe very soon practically every firm will have to consider using some type of **electronic equipment**.

You will be wise to get well acquainted with **each** of the **electronic** functions described in this book, not merely those now actually found in your plant at the present time.

LEARN TO USE THE INDEX

This book contains a complete, simplified index that will enable you to locate any desired fact immediately. The index is cross-referenced on every possible subject. When you're out on the job it's mighty important to know how to find the information you need on **electronic equipment** quickly. Whether it's a **problem of selecting the right electronic tubes or one of installation, operation, testing or trouble shooting—consult the index!**

HOW THE "BEGINNER" OR STUDENT CAN BEST USE THIS BOOK

This book should be of tremendous value to an electrical helper, a beginner in **radio or electricity** who is anxious to get ahead on his job, or anyone who wants to learn about **electronics**. We have written this book from the practical standpoint, using hundreds of illustrations and examples to explain the material. Our purpose in doing this was to make the material as easy as possible to understand. Take your time in reading this book—ask yourself three questions after you finish each subject—**WHAT** is it—**WHERE** is it used and **HOW** is it used.

After you have covered the material in this book, and thoroughly understand its application, the book will then serve as an excellent reference book for you in the future.

Unlike so many electrical or radio volumes, **this book is not the work of one individual**. The staff of the Coyne Electrical School has contributed toward making "**ELECTRONICS**" what we sincerely

feel is the best book on the practical application of electronic equipment available.

Not only that—

In preparing the material, we have had the co-operation of the leading electrical and radio companies specializing in construction, design and research on all types of electronic equipment.

We see daily that such knowledge is opening new opportunities for more interesting and profitable work to anyone sincerely interested in their own advancement.

It is with a sincere feeling of pride that after years of work in compiling and gathering of essential material, we present as an important contribution to the electrical and radio industry, our book, "ELECTRONICS."

A handwritten signature in cursive script that reads "A. B. Lewis". The signature is written in dark ink and is positioned above the printed name and title.

PRESIDENT

COYNE ELECTRICAL SCHOOL

An Acknowledgment

In the preparation of this book invaluable help has been freely extended by the leading manufacturers in the electronic and electrical industries, especially by

ALLEN B. DU MONT LABORATORIES, INC.

GENERAL ELECTRIC COMPANY

RADIO CORPORATION OF AMERICA

STRUTHERS-DUNN, INC.

SYLVANIA ELECTRIC PRODUCTS, INC.

WESTINGHOUSE ELECTRIC & MANUFACTURING
COMPANY

to all of whom we extend our sincere thanks for technical data, for numerous photographs, and for much instructional material relating to the installation, operation and maintenance of electronic apparatus.

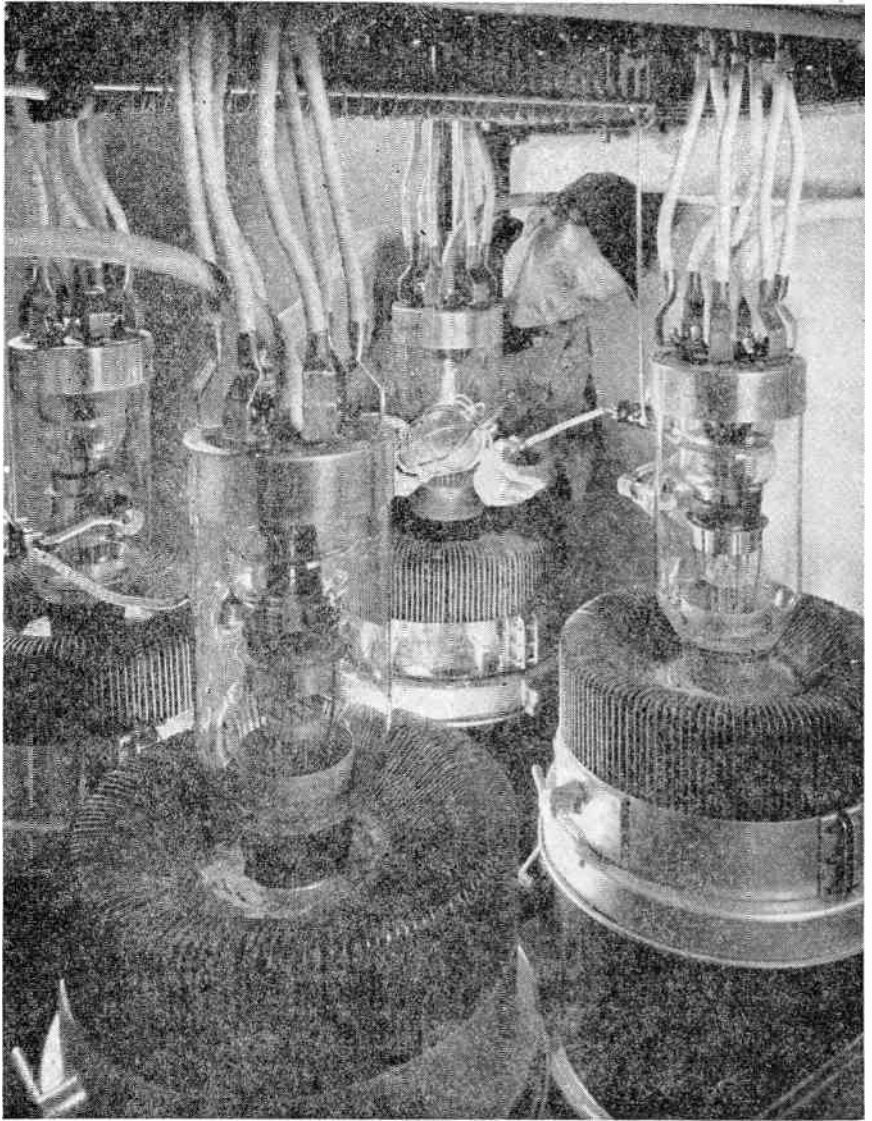

ELECTRONICS IN RADIO. Two of these big air-cooled 50,000 watt tubes are used as "spares." By simply pushing a button the operator can put them into service without interrupting program.

C O N T E N T S

Chapter 1—ELECTRONIC TUBES AND THEIR WORK.....	Page 1
The Secret of Electronics—Electronic Controls—Electrical Measurements —What Electronic Tubes Will Do—Types of Industrial Tubes—Amplifiers —Control Tubes—Converters—Generators—Indicators—Classification of Tubes and Their Uses.	
Chapter 2—THE FOUNDATIONS OF ELECTRONICS.....	Page 21
What Is Electricity?—Atoms and Electrons—Positive and Negative Bodies —Attraction and Repulsion—Electronic Flow—Electronic Circuit—Elec- tronic Pumps, Energy Sources—Work and Energy—Electric Potentials— Electric Circuit and Water Circuit—Measuring Electricity—Measuring Electrical Forces—Electric Charges—Conductors, Resistors and Insulators —Resistance and Heat—Electric Power—Electron Flow and Current Flow.	
Chapter 3—ELECTRON FLOW IN A TUBE.....	Page 47
How the Kenotron Is Operated—Electron Emission—Space Charge—Alter- nating Potentials—Alternating Electron Flow—Electron Flow and Poten- tial Differences for Rectifier—Maximum Alternating Potentials and Elec- tron Flows—Peak Inverse Potentials—Heater Cathodes.	
Chapter 4—HOW RECTIFIERS ARE USED.....	Page 61
Direct Electron Flow From Alternating Potential—Transformers—Trans- former Voltages—Center Taps—Connecting Rectifier To Load—Full-wave Rectifier—Full-wave and Half-wave Rectifier Tubes—Capacitors for Fil- tering—Capacitor Values—Filter Circuits—Filters Containing Inductors— Capacitor Input and Inductor Input.	
Chapter 5—RESISTORS FOR CONTROL OF POTENTIAL.....	Page 81
Voltage Divider—What Resistors Will Do—Factors Affecting Resistance —Heating Due To Electron Flow—Symbols for Electrical Quantities— Watts Dissipation of Resistors—Electron Flow and Potential Difference— Drop of Potential—Series Circuits—Parallel Circuits—Rule for Electron Flow, for Resistance—Equivalent Resistance of Parts in Parallel—Re- sistances in Series and Parallel.	
Chapter 6—GAS-FILLED AND VAPOR-FILLED TUBES.....	Page 105
Ionization In a Gas or Vapor—Potential Drop In the Tube—Effects of Pressure In Vapor or Gas—Preheating the Electron Emitter—Electron Flow Ratings.	

Chapter 7—THYRATRONS.....	Page 113
Thyratron Construction—Grid Action In a Thyratron—Stopping the Electron Flow—Control Characteristics—Negative and Positive Grid Control—Temperature Effects—Using a Thyratron—A Rectified Power Supply—Alternating Potential for the Plate—Potentials During a Quarter-cycle—Alternating Potential for the Grid—Effect of Thyratron Controls.	
Chapter 8—THYRATRON CONTROL AND OPERATION.....	Page 139
How Alternating Potentials Are Produced—Alternating Electron Flow In Capacitors—Reactance of a Capacitor—Phase Shifting Circuits—Cathode and Filament Connections—Effect of Phase-shift—Resistor-inductor Phase Shifting — Multiple Control — Thyratron Ratings — Ionization and Deionization.	
Chapter 9—THYRATRON APPLICATIONS	Page 161
Shield-grid Thyratrons Or Gas Tetrodes—Shield Grid Connections—Control Characteristics—Operating Voltages for the Grid—Circuit Capacitances —Protective Resistances—Base and Cap Connections—Cathode and Filament Returns.	
Chapter 10—THYRATRON-OPERATED CONTROLS.....	Page 177
Switch Contact Controls—Saturable Reactors—Saturating the Reactor—Voltage Regulator—Lamp Dimming—Phase-shift Controls—Motor Controls—Types of Motors—Speed and Reversing Controls—Generator Voltage Regulation.	
Chapter 11—GRID-GLOW TUBES AND GLOW TUBES.....	Page 197
Cold Cathodes—Action of Grid-Glow Tube—Characteristics, Advantages and Disadvantages—Grid-glow Controls—Cold-cathode Rectifiers—Types of Rectifiers.	
Chapter 12—VACUUM TUBES AS AMPLIFIERS.....	Page 207
Types and Construction—Action of Control Grid—Electron Flow In the Grid Circuit—Triode As an Amplifier—Grid Bias—Plate Characteristics of Triode—Load Lines—Voltage Gain—Determining Grid Voltage Changes —Load Resistance and Supply Voltage—Returns To Cathode—Operating Characteristics—Tetrodes and Pentodes—Thyratron Control Circuits.	
Chapter 13—AUTOMATIC TIMING	Page 229
Capacitor-Resistor Time Delay—Time for Charge and Discharge—Time Constant—Capacitor and Resistor In Parallel—Using a Time-delay Circuit —Charging From Grid Rectification—Time-delay Relay—Smoothing Capacitor—Copper-oxide Rectifier—Trigger-type Time Delay.	
Chapter 14—THE IGNITRON.....	Page 247
Ignitron Construction—The Ignitor—Operation and Action—Ignitor Control Circuits—Mounting and Care of Ignitrons.	

CONTENTS

XV

Chapter 15—WELDING CONTROLS	Page 257
Types of Resistance Welding—Time Controls for Welding—Sequence Timers—Ignitron Power Control—Leading-tube Trailing-tube Circuit—Sequence Timing—Timer for Four-period Sequence—Synchronous Timing—Peaking Transformers—Heat Control—Series Transformer Control—Timing for Seam Welding—Energy Storage Systems—Series Capacitors.	
Chapter 16—USING HIGH FREQUENCIES.....	Page 289
Induction Heating—Electrostatic Heating—Reactance and Impedance—Resonance—Oscillators—Feedbacks—Factors In Induction Heating—Power Oscillators—Methods of Electrostatic Heating—Oscillator Relay Controls—Grid Capacitor and Resistor—Oscillator Relays.	
Chapter 17—PHOTOTUBES	Page 315
Phototube Construction—Phototube Circuit—Measuring Light—Inverse Square Law—Foot-candles—Vacuum Phototube Action—Gas-filled Phototube Action.	
Chapter 18—PHOTOTUBE RELAYS	Page 331
Uses of Phototube Relays—Phototube To Amplifier Connections—Relay Operation—A-c Operation of Relays—Forward and Reverse Circuits—Action With Negative and Positive Bias—Sensitivity Adjustments—Relays Using Gas Triodes—Relays With Cold-cathode Tubes—Time-delay With a Phototube—Phase-shift Control—Phototube Relay Troubles.	
Chapter 19—THE CATHODE-RAY OSCILLOGRAPH.....	Page 355
Cathode-ray Tubes—Action of the Tube—Operating Voltages and Controls—Sweep Circuit Oscillator—Oscillator, Synchronizer and Amplifier—Oscillograph Measurements—D-c Measurements.	
Chapter 20—MAINTENANCE AND TROUBLE SHOOTING FOR ELECTRONIC APPARATUS	Page 371
Tube Maintenance and Testing—Inspection Schedules—Mountings for Tubes and Parts—Tube Temperature and Ventilation—Forced Air Cooling—Water Cooling Methods and Devices—Test Instruments—Circuit Testing—Voltage Tests—Wiring Trouble—Faults With Resistors and Capacitors—Transformers—Rectifiers—Relay Maintenance—Fuses and Circuit Breakers—Troubles With Tubes—Special Tests.	
INDEX	417-426

The Index is located at the back of this book, starting on page 417. The Index is a classified directory telling you where each specific Electronic subject can be found in the book. It will help you to locate the information you want quickly. We furnish both the table of contents and the Index for your convenience.

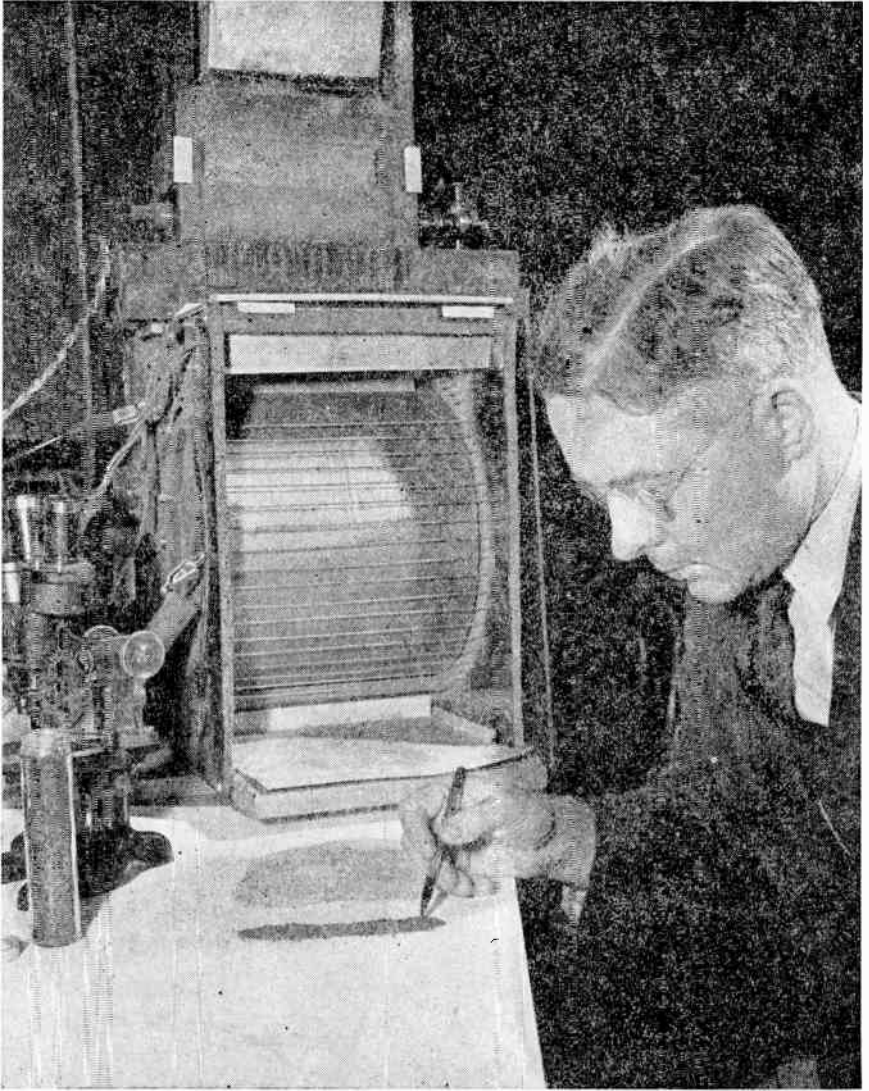

ELECTRONICS IN MINING. Working model of new electronic ore separator to extract metals from low grade ore—one of the many applications of electronics.

Electronics

Chapter I

ELECTRONIC TUBES AND THEIR WORK

The Secret of Electronics — Electronic Controls — Electrical Measurements — What Electronic Tubes Will Do — Types of Industrial Tubes — Amplifiers — Control Tubes — Converters — Generators — Indicators — Classification of Tubes and Their Uses.

SOME people think of electronics as made up of trick devices that do mystifying things like operating a window display when you wave your hand in front of a black box. Others think of electronics as something that some day in the future may do many new things in strange ways. But the truth is that right now electronic methods are at work in nearly every industry, saving thousands of hours of valuable time, producing better products, saving great quantities of scarce and valuable materials, doing dozens of things that never before have been possible.

Industrial electronics means the automatic control of manufacturing processes, it means positive safeguarding of machines and those who operate them, it means day and night protection of property, it means automatic sorting and grading of all kinds of products, it means measurements that are larger and smaller than ever before possible. Industrial electronics means the economical conversion of vast quantities of special kinds of industrial power that are essential in present-day processes such as the mass production of aluminum and magnesium, and in the automatic welding of intricate parts.

THE SECRET OF ELECTRONICS—Electronics, in the sense that we shall use the name, relates to the flow of electricity through spaces within glass bulbs or metallic enclosures in which are vacuums or gases. Such enclosures are electronic tubes, some similar in construction and performance to radio tubes, but many of them

special types such as developed in laboratories like that pictured in Fig. 1.

If you look down through the top of a glass radio tube you will see spaces between the parts inside the tube. Electricity enters the tube through metal connections, passes to metal parts inside the tube, flows across the space from one part to another, and leaves the tube through other metal connections.

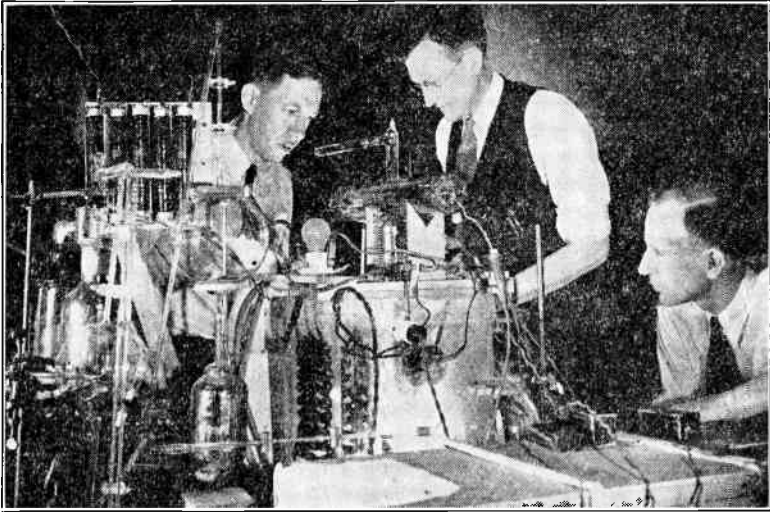

Fig. 1. The development of high-voltage electronic tubes in a laboratory.

The space inside the tube has had practically every particle of air pumped out to leave an almost perfect vacuum. Some tubes then are sealed to retain this vacuum, others have a small quantity of some gas admitted before they are sealed. The flow of electricity through the vacuum or gas is an electronic flow. Every one of the remarkable accomplishments of electronics depends on electricity leaving the metallic parts inside the tube and flowing through a space in which there is a vacuum or a gas.

Electricity that does such ordinary things as lighting lamps and driving motors remains within wires and other parts made of metals. When electricity flows through metals the ways in which we may modify that flow are strictly limited. But just as soon as we get electricity out of the solid metals and into the open space inside a tube we may control its flow to permit many things otherwise quite impossible. Here are only a few examples of what may be done:

The most minute forces will positively control other forces that are thousands of times greater.

A beam of light, or even a change of color, will control the operation of all manner of machines and manufacturing processes.

Electrical power equivalent to thousands of mechanical horsepower can be automatically applied and withdrawn, regulated in quantity, and controlled as to the exact instants and periods of application.

Actions occurring tens of thousands of times a second may be observed and measured as easily as though the parts were stationary.

We may see through inches of solid steel and through many other substances that are impervious to all light and to ordinary vision.

We may magnify objects so greatly that the sheet of paper on which these words are printed would appear to be forty feet thick.

Tools and machines may be automatically protected against breakage and costly delays in production, as is being done in Fig. 2. Even more important, those who operate the machines are protected by untiring electronic guards against injury.

ELECTRONIC CONTROLS—The strictly electronic portions of any apparatus are the tubes which control and modify electricity passing through their evacuated or gas-filled spaces. But electronic devices must include many things other than tubes. Electricity must be brought to the tubes and carried away from them. Suitable electrical or mechanical connections must be made to the machines and mechanisms which are to be controlled or operated. Other connections must be made to whatever is to be the basis of control and operation.

Many electronic installations might be compared to a man operating a punch press by pressing a foot treadle when he sees that metal to be worked is correctly placed in the press. The operation is directed by the man's brain, which, in an electronic control, is replaced by a tube. When the work is correctly placed, the man's brain is so advised by his eyesight. The electronic brain, which is a tube, would be informed through the ability of another tube, a phototube, to exercise electronic sight. Then the man's brain would direct his foot to press the treadle on the press. In the electronic installation the directing tube would actuate another power-controlling tube which would operate the press.

To replace the human operator, with his eyesight, his brain, and the force exerted by his foot, we use three electronic tubes—one

to see, one to direct, and one to control an operating force. Most electronic installations include more than one tube, and between the various tubes there are suitable electrical connections. To understand electronic devices we eventually must understand a great deal about electricity in general, but for the present we need know about only three things; electrical pressure, electrical rate of flow, and electrical power.

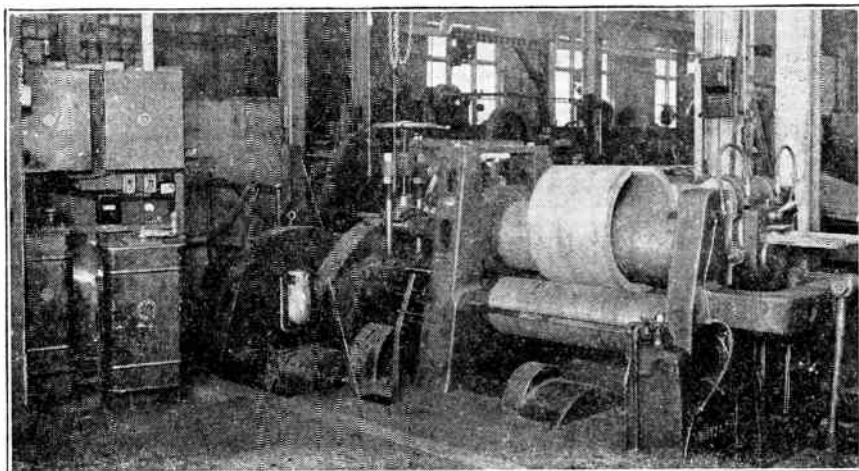

Fig. 2. A pyramid type bending roll equipped with an electronic strain gage that gives an alarm when the load exceeds the rated capacity of the machine.

ELECTRICAL MEASUREMENTS—The electrical difference in pressure that forces electricity to flow through wires and other parts is measured in volts. Electrical pressures measured in volts are comparable to water pressures measured in pounds per square inch, the differences in water pressures that force water to flow through pipes and other parts of a water system. Most of us already are familiar with many voltage measurements, such as the 110 to 120 volts required to force electricity through incandescent lamps, and the 6 volts of pressure employed in automobile starting and lighting systems.

The rate of flow of electricity through wires and other parts is measured in amperes. Electrical flow measured in amperes is comparable to water flow measured in gallons per minute. Both measurements refer to quantities or volumes that pass during a given time, neither has anything directly to do with speed. Either water or electricity may flow in great quantities at low speed, as

water in a river, or in small quantities at high speed, as water from an atomizing nozzle. To light the common 60-watt incandescent lamp requires a rate of flow of about one-half ampere of electricity. An electric flat iron requires a rate of flow of five to ten amperes, an automobile headlamp bulb takes about three amperes, a one-horsepower electric motor takes about 13 amperes when operating on a pressure of 110 volts.

Power furnished by electricity is measured in watts. Power of any kind means merely a rate of doing work. The most familiar

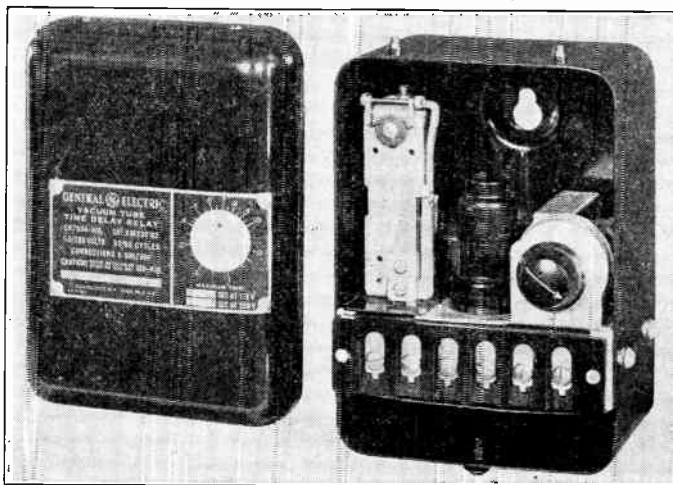

Fig. 3. A time-delay electronic relay.

unit of power is the mechanical horsepower, which is roughly equivalent to the rate at which work can be done continuously by a horse. The average man can work continuously at a rate equivalent to about one-seventh horsepower, or at a rate equivalent to about 100 watts of electric power. This means that you would have all the work you cared to do continuously were you to produce the power needed to keep a 100-watt lamp lighted to full brilliancy.

If we keep in mind approximate ideas of the values of electrical units, and if we remember that volts measure differences in electrical pressure, that amperes measure electrical rate of flow, and that watts measure electrical power, then we may talk quite intelligently about electricity.

WHAT ELECTRONIC TUBES WILL DO—Electronic tubes will do any one of five things. They will (1) amplify, (2) control,

(3) convert, (4) generate, or (5) indicate. Let's look into the meanings of each of these five functions.

1. Tubes will amplify or strengthen weak electrical impulses, or, more correctly, will strengthen changes of voltage, until the resulting changes will control still larger tubes or until they will perform certain kinds of work directly.

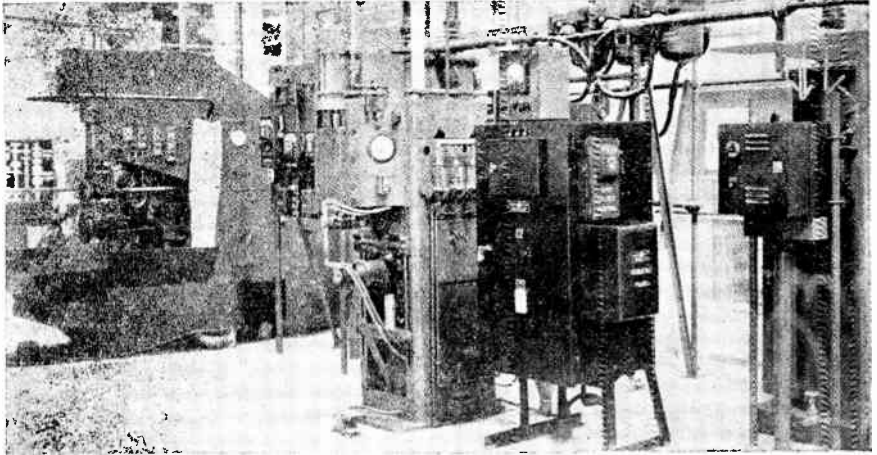

Fig. 4. Resistance welding machines which are automatically operated by electronic controls mounted in the cabinets near the machines.

Amplifying tubes or amplifiers are frequently mounted in units such as shown in Fig. 3. Here the tube is in the center, a control knob at its right, and a magnetic relay or switch at its left. This particular electronic device is a "time-delay relay" by means of which a motor may be started or stopped, or any other electrical device operated, at a definite time after something else happens. The time interval is adjustable by means of the knob.

2. Tubes will control electric power for the operation of motors, lamps, switches, and other electrical apparatus, power for manufacturing aluminum and other metals, for operating steel rolling mills, for driving electric locomotives, and for industrial processes such as automatic welding.

A typical welding installation is illustrated by Fig. 4. At the extreme right is a seam welder that uses the electrical equivalent of 270 horsepower. In the center is a spot welder using the equivalent of 100 horsepower. Electronic control tubes in cabinets near

the machines start, stop, time and regulate the power after the operator presses a button to begin the weld.

3. Tubes will convert alternating-current power into direct-current power. Such tubes are called rectifiers. Alternating-current electricity flows first in one direction and then in the opposite direction, commonly going through 60 complete changes or "cycles" every second. This is the kind of electricity delivered in most localities through the lighting and power lines to factories and other establishments. Generating stations and power transmission lines produce and carry alternating current, but for many industrial processes it is necessary to have direct current, which flows always in the one direction without any reversals. Fig. 5 illustrates a cabinet in which are four rectifiers for changing high-voltage alternating current into high-voltage direct current.

Tubes also will convert direct current into alternating current wherever the power supply is direct current and where alternating current is required. Tubes working in this manner are called inverters.

4. Tubes will generate around the outside of the tubes or around wires and other metals connected to the tubes forms of energy that produce uniform heating simultaneously throughout a substance, that permit detection of intruders, that allow examination or photography of structures for detection of internal flaws, that kill harmful bacteria in foods and medicines, that automatically bring elevators to correct levels, and that serve many other equally useful purposes.

The machine illustrated in Fig. 6 employs electronically generated heat to smooth out a coating of tin only a few millionths of an inch thick on steel sheets. This process of tin plating saves as much as two-thirds of the tin formerly required to produce uniform coating.

5. Tubes will indicate, and, as shown by Fig. 7, make clearly visible in luminous lines and curves the rise and fall of forces such

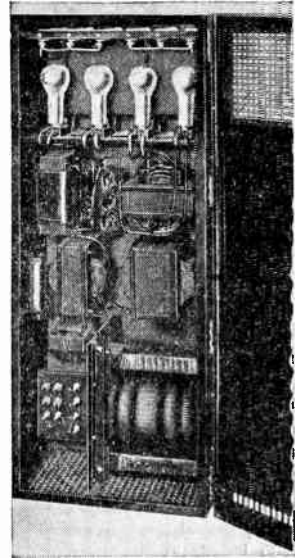

Fig. 5. High-voltage rectifier equipment which may be used in many industrial processes.

as those acting in a gun barrel during discharge, the electrical pressures that produce a spark, machine vibrations as small as one twenty-five thousandths of an inch, and many other things that happen in the briefest instants of time.

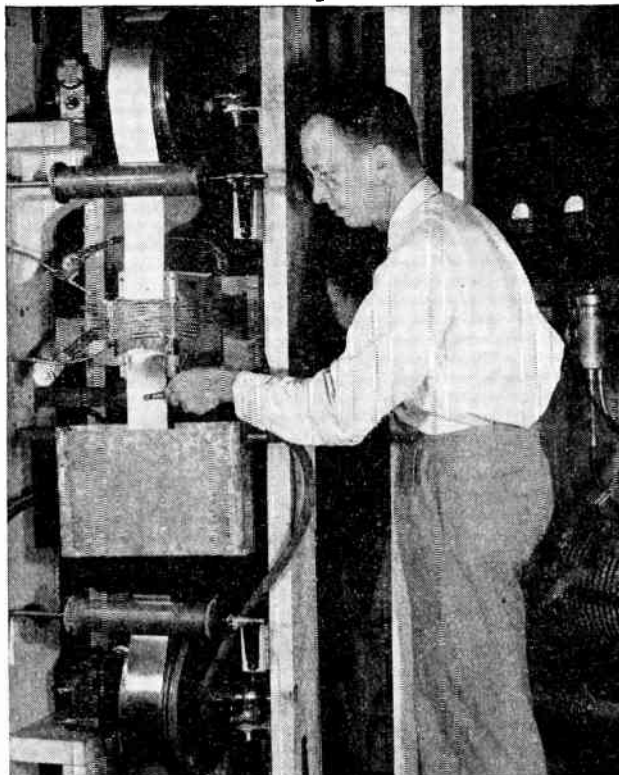

Fig. 6. Flowing a layer of tin into a smooth and uniformly distributed coating on steel plate by means of heat generated by high-frequency electronic tubes.

TYPES OF INDUSTRIAL TUBES—We have listed the functions of electronic tubes as amplifying, controlling, converting, generating, and indicating. Each of these functions may be performed by any one of several kinds of tubes, and often a single type of tube will perform different functions, depending on how it is connected to other parts of the apparatus. We shall classify the different types of tubes according to their primary purpose, as amplifiers, control tubes, converters, generators, and indicators.

AMPLIFIERS—Industrial types of amplifying tubes operate on exactly the same principles as tubes used in radios for increasing the strength of the weak signals coming in from the antenna until they are strong enough to produce sound at the loud speaker. The industrial amplifiers not only operate like radio tubes, but in many cases radio types of tubes are used in industrial apparatus.

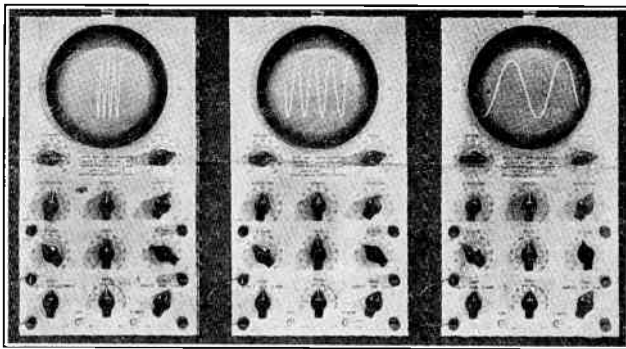

Fig. 7. Actions occurring during the briefest instants of time are made clearly visible through lines and curves on the screen of a cathode-ray tube.

Amplifiers include the types called triodes, tetrodes, and pentodes. A triode is so called because it contains three parts or three elements that are active in permitting flow of electricity through the evacuated space and in regulating this flow. Tetrodes have four such elements. They often are called screen grid tubes. Pentodes have five active elements.

Amplifiers especially designed for industrial work are called **pliotrons**. Pliotrons usually have either three or four active elements. Strictly speaking, the pliotron class of industrial tubes includes also five-element types or pentodes. All pliotrons have a vacuum inside their bulbs, none of them contain gas. Fig. 8 shows a three-element pliotron, a triode, which is designed to operate with voltages and rates of flow similar to those used for large "power tubes" in many radios.

CONTROL TUBES—Industrial types of control tubes differ materially from radio tubes, both in operating principles and construction. Three types of tubes in the control group are actuated by small changes of electrical pressure or voltage applied to one of the elements of the tube. These small control impulses regulate the

times during which large amounts of electricity are allowed to pass through the tube, and regulate also the total quantity of power. The three types of voltage actuated control tubes include thyratrons, grid-glow tubes, and ignitrons. All three contain gases or the vapor of mercury.



Fig. 8. A pliotron which will operate as an oscillator or as an amplifier.

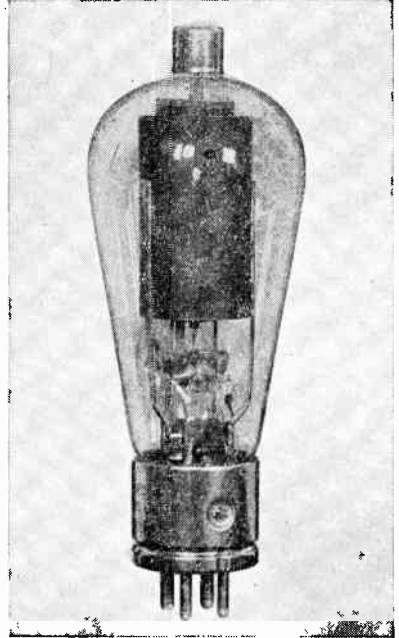

Fig. 9. A thyatron, the most generally adaptable industrial control tube.

A typical small thyatron is illustrated in Fig. 9. This particular tube will control electrical pressures as high as 2,500 volts, will easily control a one-horsepower electric motor continuously, and will handle peak powers equivalent to five or six horsepower. As we shall learn, thyratrons are the most commonly used and generally adaptable industrial control tubes.

Grid-glow tubes operate quite similarly to thyratrons, but have no internal element that must be kept heated, as is the case with the thyatron. Grid-glow tubes are a type of "cold-cathode" tube.

Fig. 10 shows an ignitron such as used for automatic control of welding machines. This tube, which is of medium size as ignitrons go, will regularly operate at a pressure of 600 volts while controlling

a flow of 75 amperes. When working at maximum capacity for short periods this ignitron will handle nearly twice as much power.

Ignitrons are the control tubes used in electrochemical industries, in steel mills, and in electric railroad service, where single groups of ignitrons may handle nearly 4,000,000 watts of power at pressures as high as 3,000 volts.

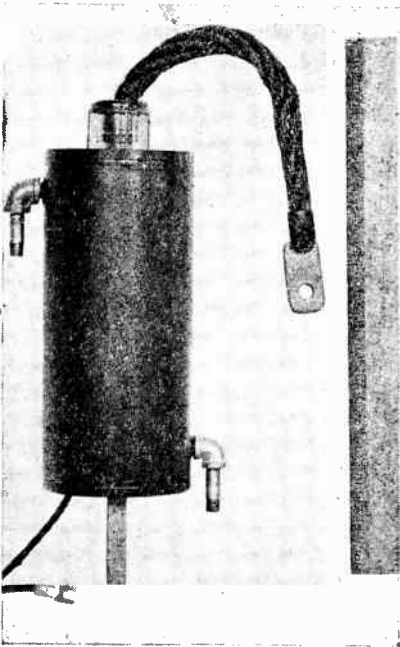

Fig. 10. An ignitron, the type of tube that will control great quantities of electric power.

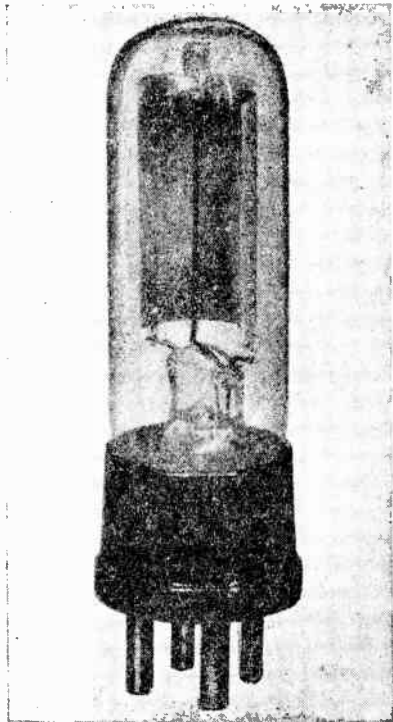

Fig. 11. A phototube which translates changes of light and color into corresponding changes of electrical pressure.

Another control tube, called a glow tube, will automatically maintain a nearly constant electrical pressure in electronic apparatus while the rate of flow of electricity varies in a ratio as great as eight to one. Ordinarily, when the rate of flow of electricity increases, the difference in pressure that maintains the flow will drop off—just as in a water system. Yet a glow tube permits the flow to vary through a wide range with scarcely any change in pressure.

Still another electronic tube used for control purposes is the phototube, undoubtedly the type most often associated in the popular mind with electronic controls. Phototubes translate changes of light and color into changes of voltage. These voltage changes then are applied to amplifier tubes or to control tubes such as thyratrons and grid-glow tubes.

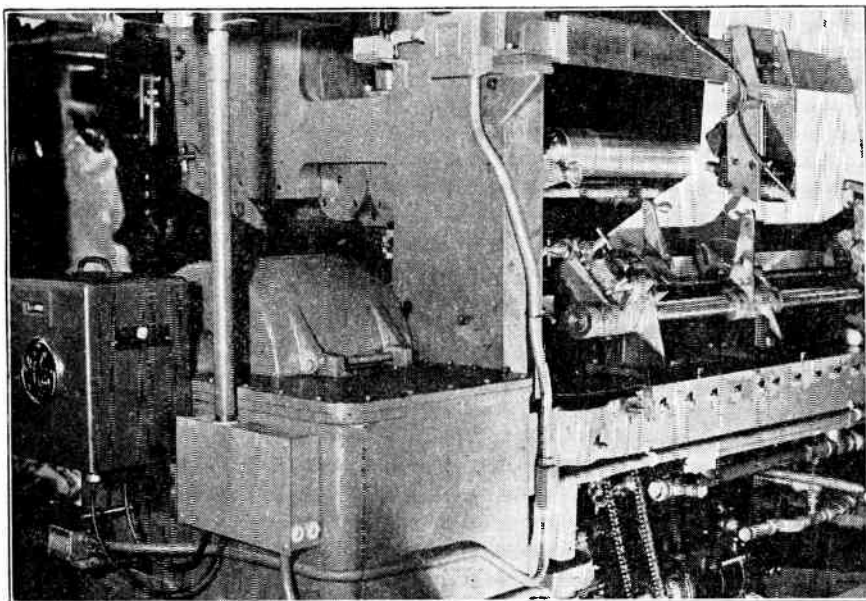

Fig. 12. Phototube controls insure correct registering of successive colors on a multi-color printing press running at high speed.

The possible applications of phototubes for control purposes are almost as extensive as the number of things you might do with your own hands while being guided by your sight. Anything that you can see as changes of light or color may be seen thus by the phototube, and the tube sees many things that are hidden from mortal sight. Almost anything you can do with your hands can be done by electrical devices controlled by the phototube. Therefore the phototube, in combination with amplifiers or other electronic tubes, is at least the equivalent of your sight and your muscular ability combined.

A phototube, of which one style is shown in Fig. 11, is of the simplest construction. There are only two internal elements, one to release electricity in quantities determined by the amount of light

reaching that element, and another to collect the electricity for delivery into the control circuits.

When combined with other electronic apparatus these simple phototubes will maintain the relative positions of cylinders on a multi-color printing press so that the misalignment of successively applied colors is less than one five-thousandth of an inch. Such an application is illustrated in Fig. 12.

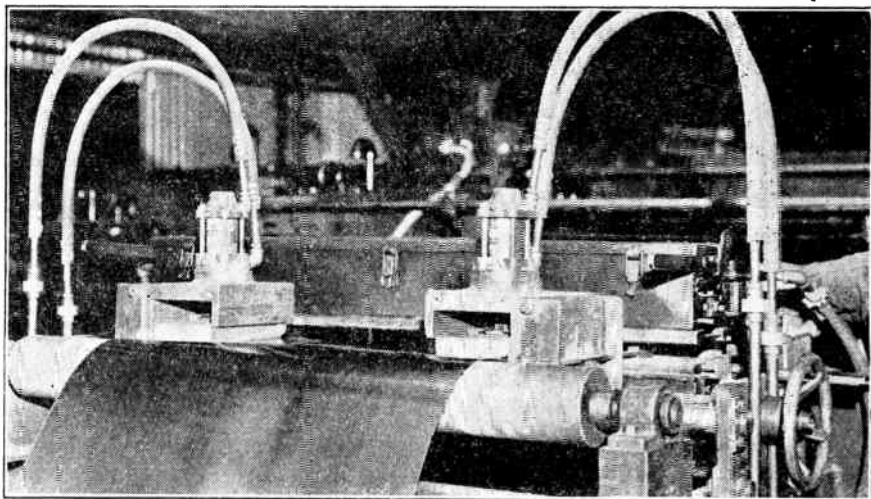

Fig. 13. Electronic equipment that detects the most minute holes in tin plate and automatically marks the sheet for rejection.

Fig. 13 shows phototubes arranged to detect the presence of holes as small as $1/100$ inch in diameter in tin plate running through the rolls at hundreds of feet a minute. By means of amplifiers and control tubes the impulses from these phototubes are made to mark defective sections of plate so that they may be rejected later on.

In Fig. 14 a phototube is watching the smoke rising through a stack, and connected electronic apparatus is making a written record of the density of smoke that occurs throughout the day and night. This, and other applications just mentioned, are only a few of literally hundreds of phototube applications in everyday use.

CONVERTERS—There are two classes of converters. Tubes in one class change alternating current to direct current. These are called **rectifiers**. In the other class are tubes that change direct current to alternating current, these being called **inverters**.

There are two types of industrial rectifiers. One type is called the **kenotron**. It is a vacuum tube, containing no gas. Kenotrons are capable of operating at very high voltages, some of them handling pressures as high as 150,000 volts, but they are designed to carry only small electrical flows. Fig. 15 is a picture of a kenotron that will handle a peak of 100,000 volts with a rate of flow of three-tenths of an ampere.

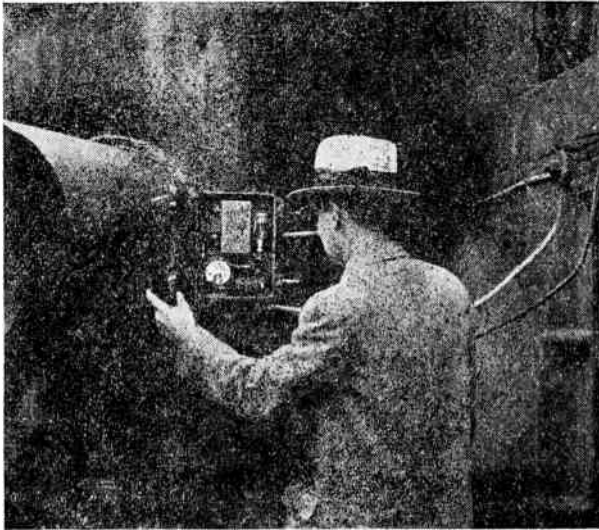

Fig. 14. A smoke density recorder making a written record of the amount of smoke rising through a large stack.

The other type of rectifier is called a **phanotron**. It is a gas-filled tube capable of carrying currents many times as large as those handled by kenotrons, but the peak operating pressures are only a few thousand volts. The phanotron of Fig. 16 will handle pressures up to 1,000 volts, average currents of $2\frac{1}{2}$ amperes, and peak currents as great as 15 amperes.

When we wish to change direct current to alternating current we may use either a thyatron or an ignitron with electrical connections that allow the tube to act as an inverter. Since most of our present-day generation and distribution of electric power is in the form of alternating current there is but infrequent need to produce alternating current from a direct-current supply.

GENERATORS—There are three general classes of generators. In one class are tubes used for generation of high-frequency electric

power, in another class are tubes that produce certain forms of radiant energy, and in a third class are tubes that produce visible light.

By high-frequency electric power we mean power produced by alternating current electricity that reverses its direction tens of thousands of times or even millions of times every second instead of only 60 times a second as in the usual power and lighting lines.

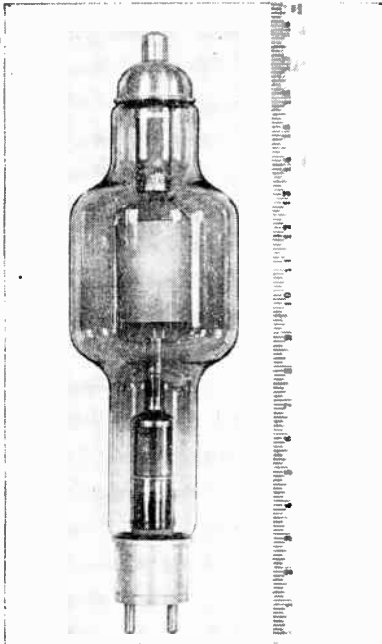

Fig. 15. A kenotron rectifier which will operate at electrical pressures as high as 100,000 volts.

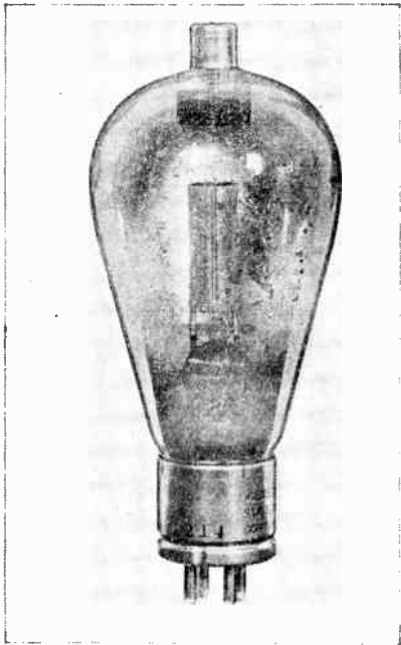

Fig. 16. A phanotron rectifier which changes large quantities of alternating current into direct current.

The behavior of high-frequency alternating current is so different from that of low-frequency power line current that there is a whole class of high-frequency industrial applications.

Tubes used to produce high-frequency currents are called oscillators. Most of the industrial oscillators are plotrons, the type of tube used also for amplifying. There is another type of oscillator tube, called a magnetron, which makes use of magnetism in controlling flow of electricity within the tube.

The difference between an inverter and an oscillator, both of which produce alternating currents, is that the inverter produces

frequencies comparable to those from power lines, such as 60, 50 or 25 "cycles" per second, while oscillators produce frequencies that seldom are less than 10,000 cycles per second.

High-frequency power from the oscillator apparatus back of the work bench in Fig. 17 is producing uniform heat for soldering. High-frequency heating is employed also for forging, brazing and hardening of metals, for bonding of plywood parts in the one-hun-

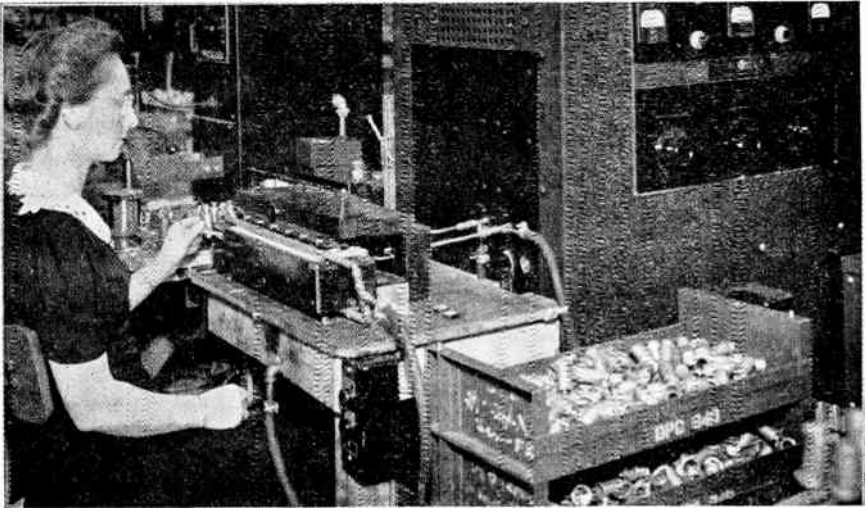

Fig. 17. A 5,000-watt oscillator being used for soldering crystal shells,

dredth part of the time formerly needed, for killing insect larvae without harming the substances in which they are deposited, and for innumerable other purposes where heat must be produced inside a material without raising the outside to a high temperature.

High-frequency heating is only one of the uses for oscillators. In other fields they make possible such things as burglar alarms, counters and timers for production units or highway traffic, automatic testing of continuous seam welds, detecting the presence of metal in the pockets of anyone passing through a gate, opening doors at the approach of someone wishing to pass through, and a long list of other purposes.

In the class of generators that emit radiant energy we have X-ray tubes and ultra-violet lamps. Radiant energy, it might be mentioned, includes light, heat and anything which may be emitted from a body and transmitted or radiated through space around the body.

The X-ray tube emits X-rays that will pass through steel, wood, plastics and other substances that are entirely opaque so far as human sight is concerned, and on the far side of such substances will produce a visible image on a suitable screen or will produce a photographic image.

Fig. 18 shows the "internal structure" of a man and his razor as made visible with X-rays. The same principles that made this interesting picture permit such practical things as the location of flaws within castings, forgings, molded plastic products, fibres, porcelains, enamels, cements and paints. X-rays will show whether the core of a golf ball is centered, whether the flux coating is uniformly applied to welding rods, whether insulation is correctly placed on wires, and will do dozens of other useful things.

Ultra-violet lamps emit rays that have shorter wavelengths than the shortest in visible light, and which will kill or prevent the growth of harmful bacteria.

INDICATORS—There are two types of indicator tubes, the cathode-ray tube which is widely used in industrial applications, and the target tube which is common in radios but infrequently used for industrial work.

In the cathode-ray a beam of electricity actually is focused to a small point much as a beam of light is focused to a point with lenses. The beam of electricity then is deflected in various directions by application of voltages, much as the light beam might be deflected by mirrors. The external appearance and internal structure of a cathode ray tube are illustrated in Fig. 19.

The voltages that deflect the beam in the cathode-ray tube are obtained directly from any parts in which instantaneous changes of voltage or current flow are to be measured and made visible, or are obtained indirectly through other electrical apparatus when it is desired to observe such things as vibration,

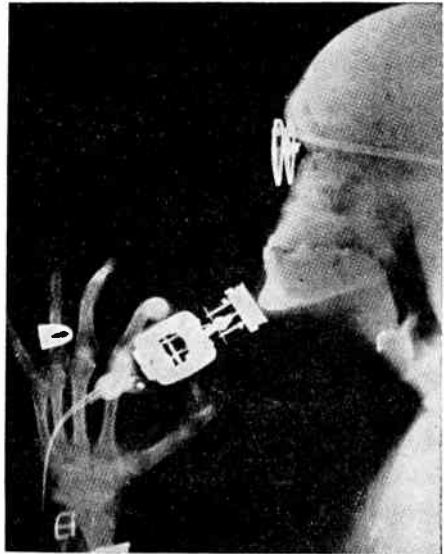

Fig. 18. An X-ray picture of a man shaving with an electric razor.

rapid bending due to applied forces, or anything else which is not primarily electrical in nature. The moving beam traces a visible pattern on the flattened end of the cathode-ray tube, which is coated with materials that become luminous under the action of the electric beam.

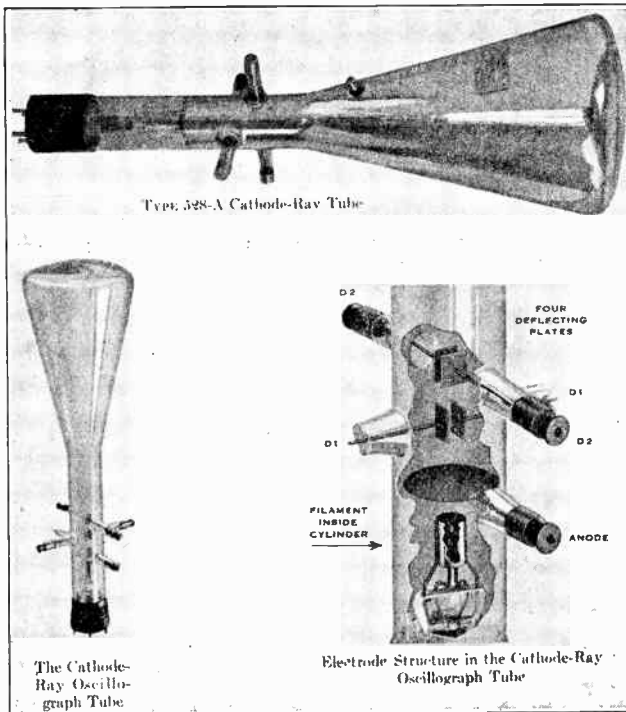

Fig. 19. The construction of a cathode-ray tube, showing the beam deflecting plates and the flattened end of the tube on which is the screen for luminous tracings.

The target tube is a type used to indicate whether a radio is correctly tuned to an incoming signal or is mistuned. In this tube a beam of electricity is made to cast a shadow which, by its shape and extent, indicates the strength of a voltage applied to the tube.

A CLASSIFICATION OF TUBES AND THEIR USES—Now we have completed a brief preliminary outline of the functions of the various kinds of electronic tubes used in industry, and have become acquainted with the names of these tubes. It will be well to stop long enough to make a tabulated listing of industrial tubes and their

principal uses, a listing which will act as a kind of map of the field that we are entering.

INDUSTRIAL TUBES AND THEIR FUNCTIONS

PRINCIPAL FUNCTION	NAMES OF TUBES USED	TUBE SPACE	TUBE CLASSIFICATIONS
AMPLIFY	{ Pliotron (triode) (tedrode) (pentode)	Vacuum	Voltage actuated
		Vacuum	
		Vacuum	
CONTROL	{ Thyratron Grid-glow Ignitron	Gas	Voltage actuated
		Gas	
	{ Glow tube Phototube	Gas	Voltage regulating
		Vacuum or gas	Light actuated
CONVERT	{ Kenotron Phanotron	Vacuum	Rectifiers
		Gas	
	{ Ignition Thyratron Ignitron	Gas	Inverters
		Gas	
		Gas	
GENERATE	{ Pliotron Magnetron	Vacuum	Oscillators
		Vacuum	
	{ X-ray Ultra-violet	Vacuum Vacuum	Radiators
INDICATE	{ Cathode-ray Target	Vacuum	Electric beam
		Vacuum	

When we speak of a tube space as containing gas, we mean that it actually contains some true gas such as argon or neon, or else that it contains the vapor of mercury which may return to the liquid condition when the tube is cold, and which again evaporates into the tube space when the tube is heated and ready for normal operation.

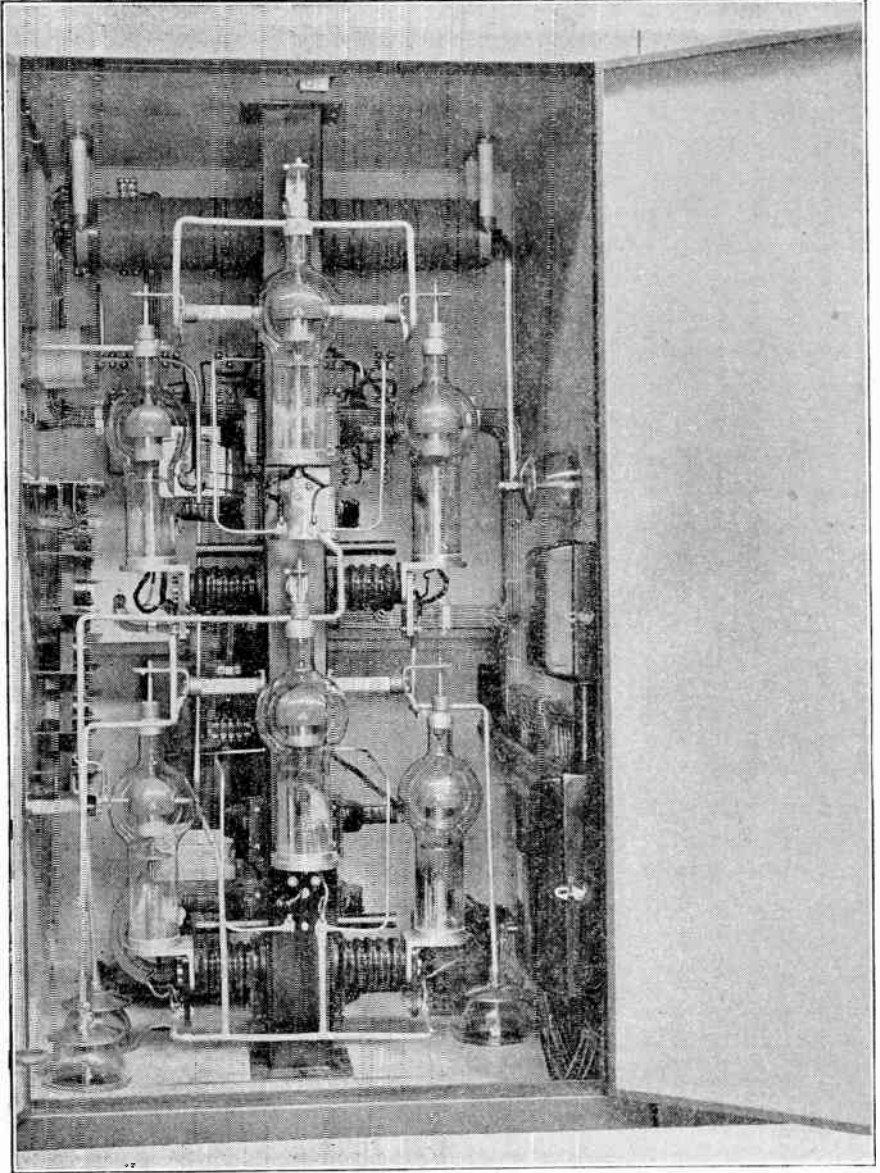

Compact, efficient electronic rectifier in which alternating current is converted into direct current. Thousands of these rectifiers are already in use in industrial plants all over the country.

Chapter 2

THE FOUNDATIONS OF ELECTRONICS

What Is Electricity? — Atoms and Electrons — Positive and Negative Bodies — Attraction and Repulsion — Electronic Flow — Electronic Circuit — Electronic Pumps, Energy Sources — Work and Energy — Electric Potentials — Electric Circuit and Water Circuit — Measuring Electricity — Measuring Electrical Forces — Electric Charges — Conductors, Resistors and Insulators—Resistance and Heat — Electric Power — Electron Flow and Current Flow.

The industrial miracles performed by electronics are made possible by the ease with which we control electricity in the open spaces inside of thyratrons, ignitrons and all the other types of tubes. Because of what this control enables tubes to accomplish they are well named the brains of our electronic devices.

However, a brain all by itself isn't much good—whether it is electronic or human. To provide the impressions which guide our human brain it is connected to a network of nerves which utilize the senses of sight, hearing, touch, smell, and taste; and the orders issued by our brain are transmitted through other nerves to muscles that carry out the orders.

Electronic nerves are the wires and other “conductors” that connect together all the parts of electronic apparatus. The electronic brain, a tube, must be connected with whatever is to determine the kind of control or measurement, and must be connected also with devices in which control, measurement, production or protection are made effective. Without all these connections even the most highly developed tube would be useless.

No one yet knows just what takes place in a nerve when it transmits an impression to our brain, or carries an order away from the brain. But in electronics we are much better off—we know exactly what happens, how it happens, and why it happens, in every part of our apparatus. Everything that happens is due to the action of electricity, and when we understand how electricity behaves we have the foundation for most of our practical work in industrial electronics.

Just as an expert machinist must understand the behavior of metals, as a plumber must understand the behavior of water, and a

carpenter the behavior of wood, so must the "electronic technician" understand the behavior of electricity, for it is with electricity that he works.

The machinist has measures for strengths, hardness and other properties of metals. The plumber measures quantities, pressures and rates of flow of water. The carpenter measures lengths, widths and shapes of lumber. The electronic technician measures quantities, rates of flow, pressures and other qualities of electricity.

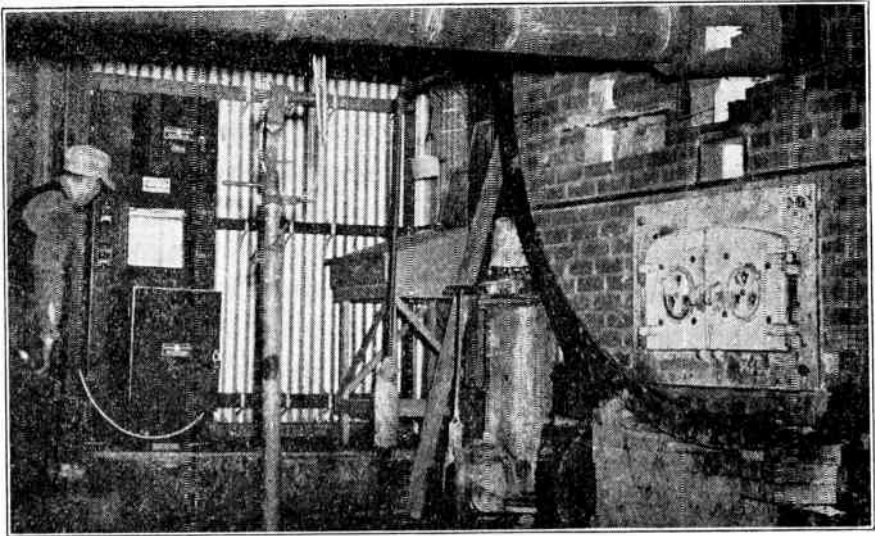

Fig. 20. Tubes operate in an electronic "nervous system" of wires and connections. Photograph of an electronic pyrometer for temperature control of an electrical cement kiln.

It is impossible even to talk intelligently about electricity and electronics, let alone doing any useful work in this field, without understanding electrical and electronic measurements and the units in which they are made. Houses have been built by so-called carpenters whose measurements are made by "the length of a hammer handle and a little bit over". Electrical installations have been made by self-styled experts of similar caliber, but nothing need be said about the results.

We are going to get acquainted with electricity; with what it is, how it acts, why it acts that way, and, most important of all, with how we measure its performance. On such a foundation we shall commence building your ability to adapt electronic methods to any situation.

WHAT IS ELECTRICITY?—First of all we must get acquainted with electricity itself. In an electrical dictionary written fifty years ago there is this definition: "Electricity.—The unknown thing, matter or force, or both, which is the cause of electric phenomena." Fortunately, electricity no longer is an unknown thing. We know that electricity consists of particles, some of which may be made to move about and do work. We know the size of these particles, we know their mass, and we know how many of them must be moved to do any given amount of work.

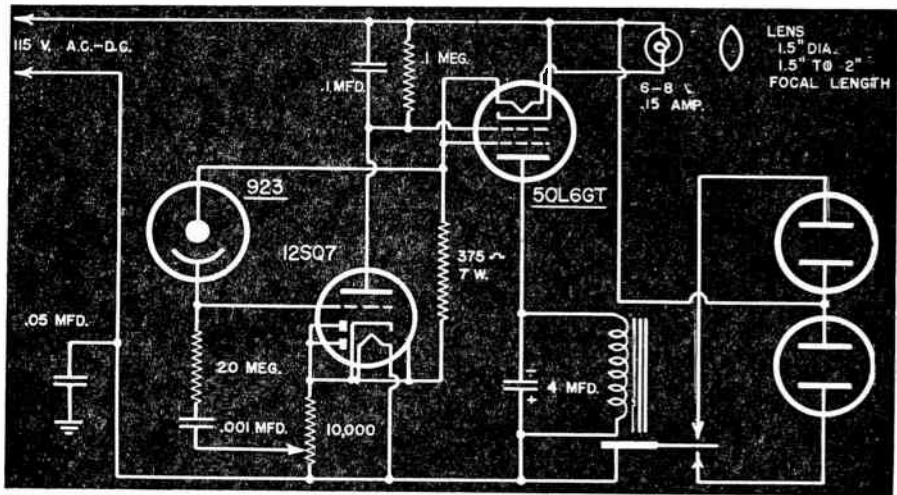

Fig. 21. It is with diagrams like this that we shall show the connections leading to and from electronic tubes. In this diagram are a phototube and two amplifiers.

There is electricity in every gas, every liquid, and every solid substance we know. All these substances are made up of different kinds of atoms in various combinations. Each atom consists of a central part, called the nucleus, around which, as Fig. 22, whirl anywhere from one to 92 electrons, the number of electrons depending on the kind of atom. Electrons whirl around their nucleus as the moon rotates around the earth, and as the earth and the other planets rotate around the sun.

An atom is small. It would take 250,000,000 atoms laid side by side in a row to extend one inch. Yet the central nucleus of the inconceivably small atom occupies only one ten-thousandth of the diameter of the atom, and an electron is only about one-fifth the diameter of the nucleus.

If you could magnify an atom until one of its electrons became the size of a baseball, you would see the baseball traveling around a path nearly two and one-half miles in diameter, at the center of which would be a nucleus the size of a football.

The only parts of the nucleus that interest us now are called **protons**, which are particles of **positive electricity**. We are much more interested in the **electrons**, which are particles of **negative electricity**. Our greater interest in the electrons arises from the fact that they can be separated from their atoms, and can be moved about and controlled. Electrons are the electricity with which we do things.

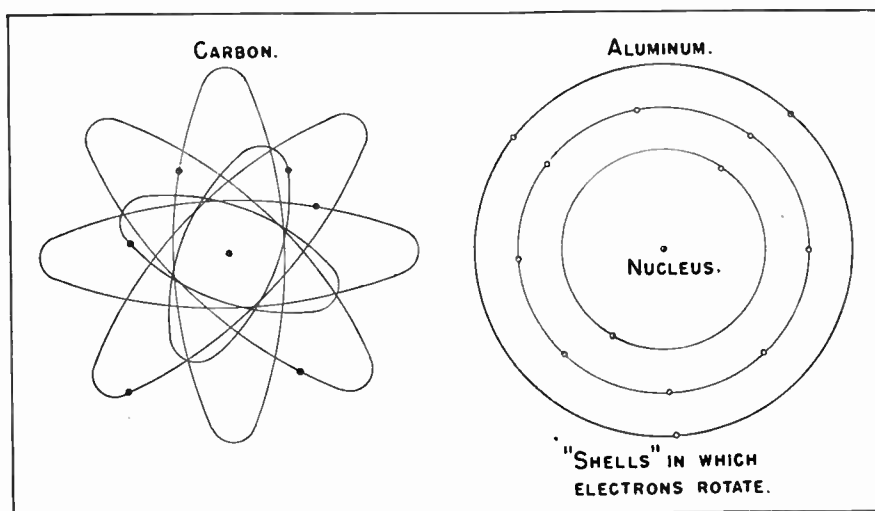

Fig. 22. At the left is represented an atom of carbon with its central nucleus, around which rotate two electrons in an inner "shell," and four more in an outer shell. At the right is a simplified diagram of an aluminum atom having three shells in which are respectively two, eight and three electrons, making 13 electrons in all.

Positive and negative electricity, that is, protons and electrons, have a strong attraction for each other. It is this attraction between the positive protons and the negative electrons that holds the atom together. It is a similar attractive force that prevents the earth and the other planets from flying off their orbits around the sun, and that keeps our solar system together.

ATOMS AND ELECTRONS—Now let's talk about a familiar substance—aluminum. In each atom of aluminum there are 13 negative electrons whirling around the positive nucleus. The attraction

between these 13 particles of negative electricity and the positive protons in the nucleus is sufficient to hold the negative electrons in the atom under normal conditions. The positive force in the nucleus is equal to the negative forces of the 13 electrons, as has been indicated in Fig. 23.

In the atoms of aluminum and of many other substances one of the negative electrons farthest from the nucleus frequently breaks away from the atom to become a free electron. Ordinarily these free electrons almost immediately enter other atoms which

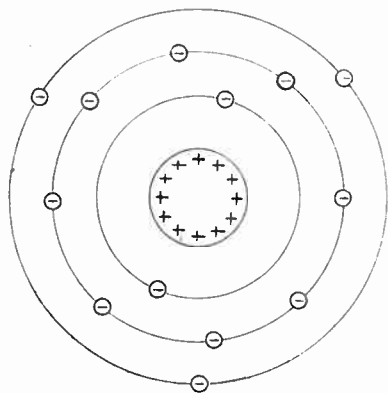

Fig. 23. The positive forces in the nucleus, represented by plus (+) signs, exactly balance the negative forces of all the electrons, represented by minus (-) signs.

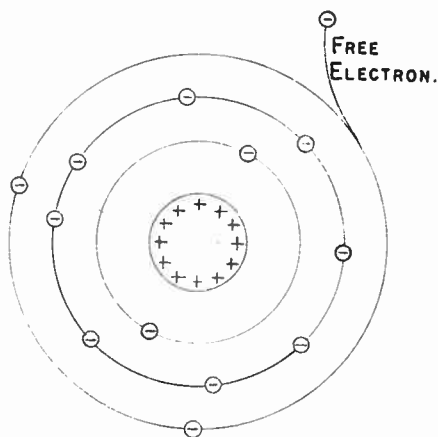

Fig. 24. The aluminum atom has lost one electron from its outermost shell, leaving the atom positive while the electron becomes a free particle of negative electricity.

have lost an electron, because of the attraction between the positive electricity in the atoms and the negative electricity of the free electrons. This matter of atoms losing and regaining electrons will bear a little more investigation.

Assume that an aluminum atom has lost one of its negative electrons, as in Fig. 24. That free electron now is wholly negative, it is a wandering particle of negative electricity. The nucleus of the atom still has just as much positive electricity as ever, it still has enough positive electricity to attract and hold 13 negative electrons, but actually there are only 12 electrons remaining in the atom.

This atom which has lost an electron contains more positive electricity than negative electricity. It has positive force to spare,

so we may call it a positive atom. This positive atom has strong attraction for any free negative electrons in its vicinity, and that is the reason that roaming free electrons are continually re-entering the atoms.

POSITIVE AND NEGATIVE BODIES—Now let's consider a whole piece of aluminum instead of just an atom, and let's assume that the total number of negative electrons (both in the atoms and free) is exactly the same as the number that would be in all the atoms were each atom complete. Then all the negative electricity in the piece of aluminum is exactly balanced by all the positive electricity, and the body as a whole is electrically **neutral**—meaning that it has neither an excess nor a deficiency of negative electricity. Such a condition is represented in Fig. 25.



Fig. 25. In a neutral body the positive and negative forces are balanced; in a negative body there is an excess of negative electricity; and in a positive body there is a deficiency of negative electricity.

In the actual operation of electronic apparatus we frequently force into a body more negative electrons than can be balanced by the positive forces in the atoms of that body. Then the body as a whole has an excess of electrons, which are negative electricity, and that body as a whole has been made **negative**.

At other times we remove many of the free negative electrons from a body. Then that body has too little negative electricity to be balanced by its positive electricity in the atoms. When there is this kind of a deficiency of negative electricity there remains an excess of positive electricity, so the body as a whole has become **positive**.

Whether a body is electrically neutral, is negative or is positive depends entirely on the relation between the number of negative electrons actually in that body, and the number that would be there were the positive and negative forces in exact balance. The electrical condition depends entirely on the quantity of negative electrons or negative electricity, because it is only negative electricity that can be separated from the atoms. The positive electricity remains fixed within the atoms and remains fixed within the body of the substance.

Just as a preview, one of the most important methods of controlling the flow of electricity in gases is by forcibly knocking extra electrons out of the gas atoms, so that we may have more free electrons than normally would exist. The additional free electrons thus produced in certain types of tubes make it possible to save great quantities of power otherwise required just for operating the tubes.

An even more important and widely used method of control is obtained by taking advantage of the attraction and repulsion of positive and negative bodies for electrons traveling in their vicinity.

ATTRACTION AND REPULSION—Nearly 2,500 years ago a Greek philosopher made note of the fact that when he rubbed a piece of amber with his dry hand the amber would attract small pieces of straw and other light objects. Two thousand years later

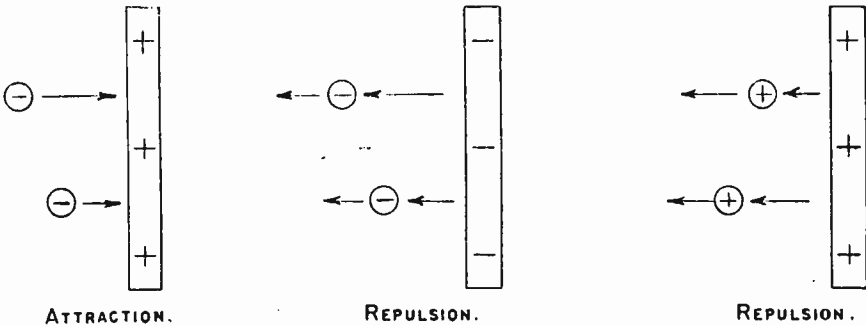

Fig. 26. Positive and negative bodies attract each other. Negative and negative, or positive and positive, repel.

it was discovered that many substances would either attract or repel other substances when rubbed together. Progress was slow in those days.

When things like amber, sealing wax and hard rubber are rubbed with your hand or with pieces of cotton, silk and wool, electrons are rubbed off the cloth or your hand and onto the substances rubbed. The cloth or your hand loses negative electrons and thus becomes electrically positive, while the substances rubbed gain electrons and become electrically negative.

When one body is electrically positive and another is electrically negative, they attract each other as shown in Fig. 26. This force of attraction is the same force that exists between posi-

tive protons and negative electrons in atoms. In electronic tubes we employ this force to attract negative electricity (electrons) to bodies that are electrically positive.

If two bodies are both electrically negative, if both have an excess of negative electricity or electrons, they not only fail to attract but actually repel each other. This effect is used in electronic tubes to hold back the flow of negative electricity or electrons by placing in their path a body that is electrically negative.

It is true also that two bodies which are electrically positive will repel each other, but this repelling effect is used less often in electronic apparatus than is repulsion between two negative bodies. The reason is that nearly all our controls are designed to affect the flow of electrons, and electrons are negative.

THE ELECTRON FLOW—By far the greater part of work done in electronic apparatus is done by electrons that are in motion. Electrons that stand still, or that merely circulate among the atoms in a substance, are only as useful as water that stands still or that eddies around in a reservoir. If the water is to do work, such as turning a water wheel or a turbine that furnishes power, the water must move. To get electrons to do work such as lighting a lamp or running a motor the free electrons must move out of their circular or random paths.

To move free electrons and keep them in motion there are two things we must do:

1. We must have a continual supply of electrons.
2. We must have a force capable of moving them and of keeping them moving.

In any substances, like copper wire, that ordinarily are used to carry moving electrons from place to place there are free electrons that can be moved. But the entire supply of free electrons in any substance would be exhausted before we obtained movement of enough of them to do much work.

The problem of moving the free electrons might be solved by providing a positive body that will attract these particles of negative electricity, and another negative body that will repel them at the same time. But here again we run into difficulties. The positive body quickly would gain so many negative electrons that all its excess positive force would be balanced, the body would become neutral and would have no further attraction. Also, the negative body that repels electrons because it has an excess of electrons soon would lose this excess, would become neutral, and would have no further repulsion.

We must do two things:

1. Overcome the lack of free electrons by providing a continual and ample supply.
2. Maintain the positive body in its positive condition, and the negative body in its negative condition, even while they continually gain and lose electrons.

We shall overcome the lack of free electrons by arranging all the connections between parts of our electronic apparatus to form electronic circuits. We shall maintain the positive and negative conditions of the bodies that provide attraction and repulsion by inserting in our circuits one or more electronic pumps. You have been in the habit of calling electronic pumps by the more common names of batteries, generators, and thermocouples.

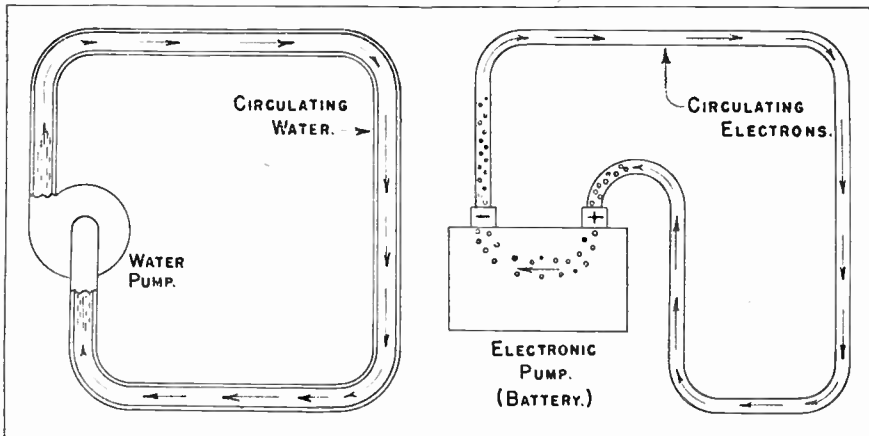

Fig. 27. The water circuit and the electronic circuit.

THE ELECTRONIC CIRCUIT—In Fig. 27 we have a water circuit and an electronic circuit. A water circuit means a complete path through which the same water may travel around and around continually. An electronic circuit means a complete path in which the same electrons may continue to circulate, coming in at one end as fast as they leave the other end, so that the circuit always remains full of free electrons.

Electrons or negative electricity in motion form what is called the electronic flow, just as water moving in a river or elsewhere is called a water flow.

ELECTRONIC PUMPS—CURRENT SOURCES—We started out by calling batteries, generators and thermocouples electronic pumps.

However, we shall not continue to use this name because it is not generally used by those in the electronic and electrical fields. Instead of calling these devices electronic pumps we shall hereafter use the more common term **energy source**. Batteries, generators and thermocouples really are sources of electronic flow, because it is in them that electrons or electricity are caused to move and thus to form a flow of electrons.

Every source of electrical energy produces within it a difference in electrical pressure that, inside the source, moves electrons from the positive terminal to the negative terminal as in Fig. 27. Thus is created a deficiency of electrons at the positive terminal and an excess at the negative terminal of the source. The force that moves electrons through energy sources is called **electromotive force**, a name which commonly is abbreviated to **emf**. The abbreviation is pronounced by naming its three letters in succession.

WORK AND ENERGY—It takes work to move electrons out of their normal paths. Work, in the technical sense, means the overcoming of some opposing force, and always implies the movement of a body against a force that opposes the movement. Work must be done to move electrons because it is necessary to overcome the forces of attraction in the atoms through which electrons move. The attractive force in the atoms must be overcome in order that electrons may be pulled away from their atoms and kept from rejoining other atoms.

Anything which has the ability to do work is said to possess **energy**. Energy is the ability to do work, or the capacity for doing work. There are many kinds of energy. You possess muscular energy that enables you to do work of many kinds. Electrons or electricity in motion possess electrical energy, which enables the electricity to do many kinds of work. Chemicals in a battery possess chemical energy, which is changed by the battery into the energy of moving electricity. The sole purpose of energy sources such as those of Fig. 28 is to change some other kind of energy into the energy possessed by electricity in motion.

An electric generator or dynamo changes the mechanical energy of motion into the energy of moving electricity or into the energy of moving electrons. A thermocouple is a device that changes the energy of heat directly into the energy of moving electricity. The thermocouple consists of two unlike metals joined together in a loop or an electric circuit. When one of the junctions between the metals is maintained at a temperature higher

than that of the other junction, the thermocouple translates heat energy into electromotive force that will move electricity.

ELECTRIC POTENTIALS AND THEIR MEASUREMENT—Our future studies in electronics will be made much easier if we make sure, here in the beginning, that we have a clear understanding of the force that causes flow of free electrons, and of how this force is measured. Such an understanding will be more easily gained if we first discuss the behavior of water, and then compare the behavior of electrons with that of water.

In Fig. 29 are two tanks partially filled with water and connected together through a pipe. In diagram A the water levels are the same in the two tanks, so there will be no tendency for water to flow from one tank to the other. In diagram B the left-

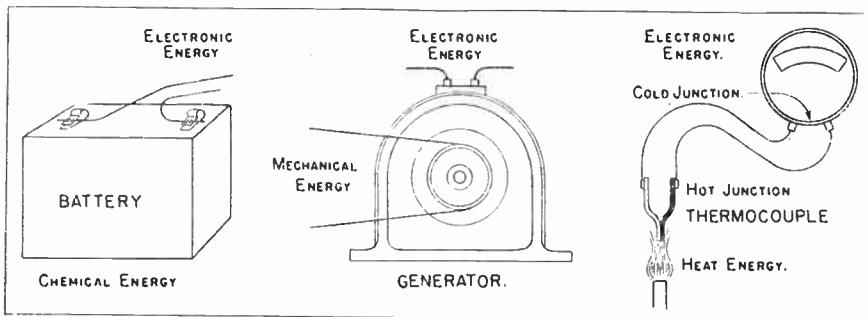

Fig. 28. Energy sources act like electronic pumps; changing chemical energy, mechanical energy, or heat energy into electronic energy.

hand tank has been raised slightly higher than the right-hand tank. Now water flows from the higher tank to the lower one. In diagram C the left-hand tank has been raised much higher than before. This causes water to flow from the higher to the lower tank at a greatly increased rate. The higher is the water level in one tank with reference to the level in the other tank the greater will be the rate at which water flows from the higher to the lower tank.

Whether the tanks and their pipe of Fig. 29 were in the basement or on the roof would have no effect on the rates of water flow between the tanks for any given differences between levels of the tanks. The rate of flow between tanks depends only on how much one tank is elevated above the other, and not at all on how far both tanks are above ground level.

With a connecting pipe of given kind, diameter, and length between the two tanks, the rate at which water flows from one tank to the other depends on the difference between the levels of water in the two tanks. The difference between the water

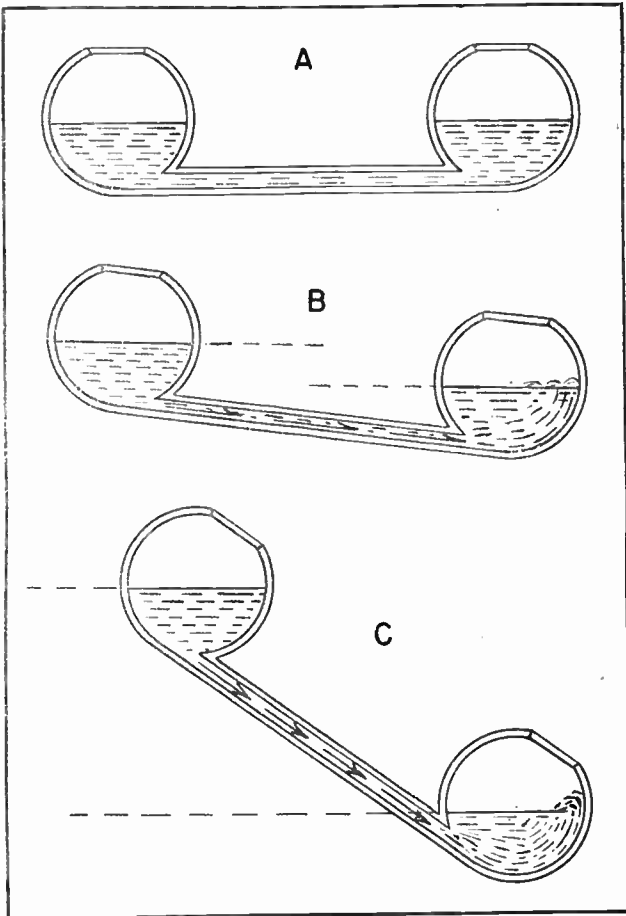

Fig. 29. The rate of water flow between two tanks depends on the relative levels of water in the tanks.

levels, specified in inches or feet, is a measure of the force that causes water to flow from the higher to the lower level.

Now we may examine the somewhat more elaborate water system illustrated in Fig. 30. Here we have a pump that elevates water from one tank to another, while the water flows back to the first tank through an inclined pipe. It is plain that the rate

of water flow from upper to lower tank in diagram A will be greater than the rate in diagram B. The reason is that there is a greater difference between water levels in diagram A. Always it is the difference between levels that determines the rate of flow.

The pump of Fig. 30 must force water from the lower tank into the upper one at the same rate that water flows from the upper tank to the lower one in order that a supply of water may be main-

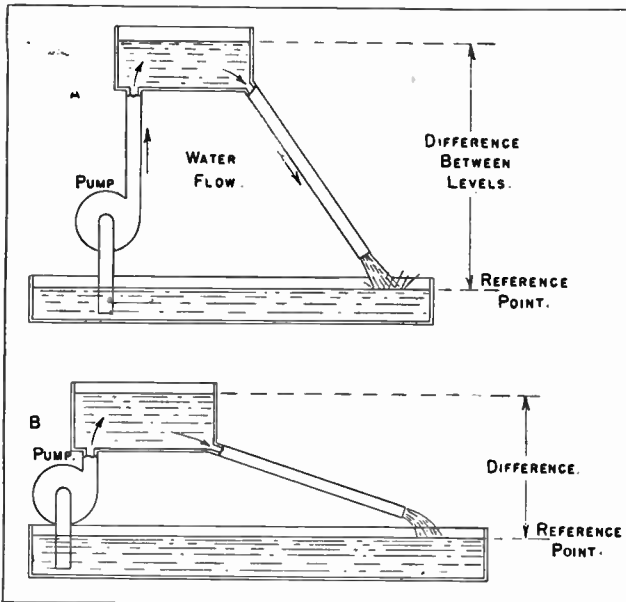

Fig. 30. It is the difference between water levels that determines the rate of water flow from one level to another.

tained at all points in the water circuit. The pump must continually raise water through the same distance that it falls back through the inclined pipe. In so doing, the pump provides the force that causes water to flow downward through the inclined pipe, because the pump maintains the difference between water levels that is necessary to cause water flow.

The lowest level in the water system may be called the **reference point**, as in Fig. 30, because it is with reference to this level that the height of all other levels may be measured. In some cases it may be more convenient to consider the pump as our reference point; then measuring the level in the lower tank as a certain distance below the reference point, and the level in the upper tank as

a certain distance above the reference point. As a matter of fact, we might take any level for our reference point, and measure all other levels as being above or below our chosen reference point.

In Fig. 29, also in Fig. 30, we may measure the difference in levels by any convenient unit of length, such as inches or feet. In any given water circuit, if there is a certain rate of flow in gallons per minute with a level difference of two feet there will be twice the flow in gallons per minute with a difference of four feet, and half the flow in gallons per minute with a difference of one foot. The rate of flow depends on the difference between upper and lower levels, or on how much the upper level is above the lower one when we take the lower one for our reference point.

THE ELECTRIC CIRCUIT AND THE WATER CIRCUIT—In Fig. 31 is an electric circuit which we may compare with the water circuit of Fig. 30. Instead of a flow of water we now have a flow of electrons. Instead of speaking of water levels and of differences between levels, we now speak of electric potentials and of differences between potentials. Instead of a water pump for moving water from one level to another, we now have an electric battery for moving electrons from one potential to another. The word **potential** used in electronics has a meaning almost identical with the word **level** used in hydraulics.

The point in an electric circuit at which there is the greatest deficiency of electrons sometimes is considered as the reference point, from which we may measure differences of potential to any other points in the circuit. In a battery or other source the greatest deficiency of electrons is at the positive terminal, so this terminal would be our reference point and all other points would be more negative. If more convenient we might take any other point in the circuit for the reference point, and measure the potentials of all other points in the circuit as being a certain number of volts more positive or more negative in potential than this chosen reference point.

In diagram A of Fig. 31 the battery is in a position corresponding to that of the pump in Fig. 30; with the reference point at the bottom, with electron flow upward through the battery and downward through the portion of the circuit that is outside the battery. A water system must be shown with water being lifted against gravity and flowing downward with gravity, because the force of gravity acts only in an up-and-down direction. But the parts of the electric circuit may be placed in any positions, as in diagrams B and C, and still the electron flow will be from the posi-

tive to the negative terminals inside the battery or other energy source and from negative to positive outside of the source.

In a water circuit we measure differences between levels in such units as inches or feet. It is the number of inches or feet of difference between levels that determines the rate of water flow in a given water system. In the electric circuit we measure differences between potentials in the unit called a volt. It is the

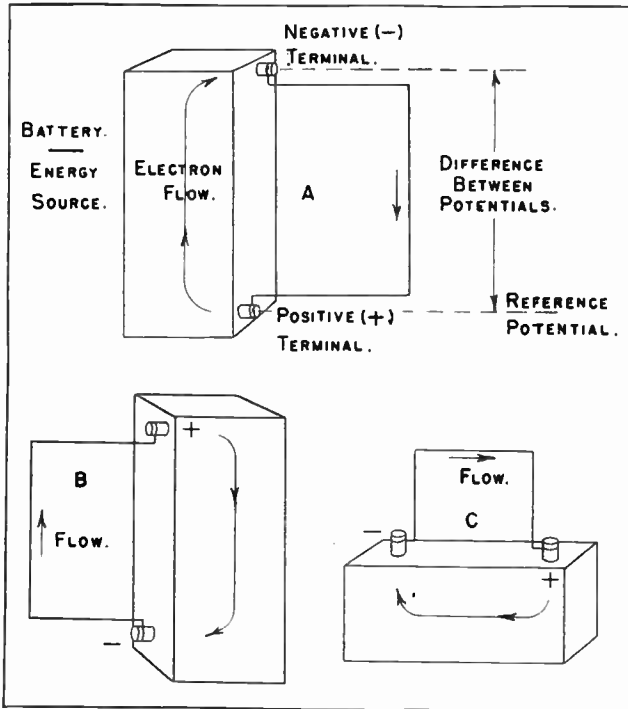

Fig. 31. An electric circuit in which rates of electron flow vary with differences of potential, just as rates of water flow vary with differences of water level in a water circuit.

number of volts difference between the potentials at two points in a circuit that determines the rate of electron flow between these points. If one battery provides a potential difference of six volts, and another one provides a difference of three volts, the rate of flow through a given external circuit will be twice as great with the six volts as with the three volts of potential difference.

In the following side-by-side paragraphs are repeated some of the more important statements from our discussion of the

water systems, together with statements in which the "water words" are changed to the equivalent "electronic words."

Water Circuits

If water levels are the same in two tanks there will be no flow of water from one tank to the other.

The higher is the water level in one tank with reference to the level in the other tank, the greater will be the rate at which water flows from the higher to the lower tank.

The difference between two water levels, specified in inches or feet, is a measure of the force that causes water to flow between the levels.

The pump must force water from the lower tank into the upper one at the same rate that water flows from the upper tank to the lower one in order that a supply of water may be maintained at all points in the water circuit.

The pump maintains the difference between water levels that is necessary to cause water flow.

In any given water circuit, if there is a certain rate of flow in gallons per minute with a level difference of two feet, there will be twice the flow in gallons per minute with a difference of four feet, and half the flow in gallons per minute with a difference of one foot.

Electronic Circuits

If electric potentials are the same at two points there will be no flow of electrons from one point to the other.

The higher is the potential at one point with reference to the potential at another point, the greater will be the rate at which electrons flow from the higher to the lower potential.

The difference between two potentials, specified in volts, is a measure of the force that causes electrons to flow between the points.

The battery or other energy source must force electrons through itself at the same rate that electrons flow through the parts of the circuit outside the source in order that a supply of electrons may be maintained at all points in the electric circuit.

The energy source maintains the difference between potentials that is necessary to cause electron flow.

In any given electric circuit, if there is a certain rate of flow in amperes with a potential difference of two volts, there will be twice the flow in amperes with a difference of four volts, and half the flow in amperes with a difference of one volt.

MEASURING ELECTRICITY—We have learned enough about electricity itself to commence discussing measurements of quantity, rate of flow, forces that cause flow, and opposition to flow through various materials.

The practical unit in which we measure quantities of electricity is the **coulomb**. One coulomb of electricity consists of about $6\frac{1}{4}$ billion, billion electrons—a number written as 6,250,000,000,000,000,000. The size of this number is reason enough for measuring quantities of electricity in coulombs rather than in numbers of electrons.

When the rate of flow of electricity in a circuit is such that one coulomb of electricity passes a given point in one second, the rate of flow is one **ampere**. The ampere is one of the units mentioned earlier in our talks about electronics.

Before we may define the unit of measurement for electromotive force, which is the **volt**, we must understand something about the opposition offered by all substances to flow of electrons or electricity through them. This opposition is called electrical resistance.

ELECTRICAL RESISTANCE—The arrangement of electrons in the atoms of various substances varies with the kind of substance, and the forces which must be overcome in getting free electrons past the atoms vary similarly. The result is that some materials offer much more resistance to passage of electrons through them than do other substances.

The metals, as a class, offer less resistance than any other substances to flow of electrons through them. Among the metals silver offers the least resistance. Next in order among the pure metals comes copper, then gold and then aluminum.

Any material in which a relatively great flow of electrons may be maintained by a moderate electromotive force is called an **electrical conductor**. Silver, copper, gold and aluminum are excellent conductors. The relatively high costs of silver and gold leave copper and aluminum as by far the most generally used conductors. Commercial grades of iron and steel have from ten to fifty times as much resistance as has copper.

The resistance of any material to flow of electrons or electricity through it is measured in a unit called the **ohm**. If an electric circuit or a part of a circuit has a resistance of one ohm, then an electron flow of one ampere will flow when we apply a difference in electrical pressure of one volt across the ends of the circuit or across the part of the circuit in which the flow takes place.

A relationship so simple as to allow us to say that one volt difference in pressure sends one ampere of electricity through one ohm of resistance did not come about by accident. Electrical units have deliberately been chosen to have just such simple relations as this, which helps a lot to make electrical calculations far easier than they otherwise would be.

MEASURING ELECTRICAL FORCES—The volt is a unit in which we may measure electric forces wherever they occur and however they are applied. We already have talked about the volt as a unit of measurement for electromotive force, the force that moves electrons or electricity inside of energy sources. The term electromotive force is correctly used in relation to electric forces that are produced inside an energy source, not to forces that exist outside of the source.

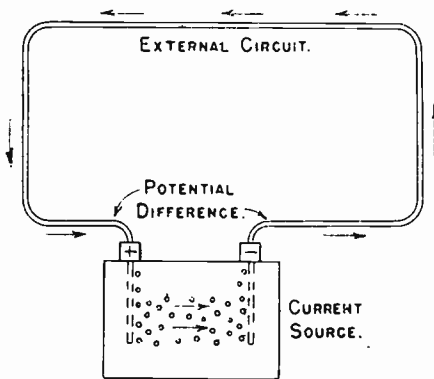

Fig. 32. The energy source applies a potential difference to the external circuit.

When, as in Fig. 32, a source of electrical energy is connected to the conductors that form an electric circuit, the force that moves electrons through the source from its positive terminal to its negative terminal is effective also in driving electrons through the "external circuit" from the negative terminal of the source all the way around the conductive path and back to the positive terminal. Here it will be natural for you to inquire why we speak of elec-

tromotive force as existing only inside an energy source and then say that it is the same force that drives current through the external circuit. Here is the answer.

The force that moves electrons through an energy source is not only equal to that applied by the source to the external circuit, it always is greater. It is greater because some of the electromotive force produced within the source is used in overcoming electrical resistance inside the source. We said that resistance exists in all substances, so it exists in the materials inside an energy source. It is only the force remaining after overcoming the internal resistance of the source that is available for sending electrons through the external circuit.

The force applied to the external circuit by the energy source is called an electric potential. An electric potential, in electrical measurements, is similar to the level of water in water systems or hydraulic systems. The difference in level of water determines the force which the water will exert when it falls from that level, and, in connection with the volume of water, determines the work that the water will do. The greater the difference in level from which the water drops the greater the force.

Electric difference in potential is measured in volts. The greater the difference in electrical pressure between two given points in a circuit the greater is the difference in potential, as measured in volts. Going back to the water comparison, it is plain that the force developed depends on the level above a point to which the water may drop; i. e., difference in level, so the force really depends on the difference between the higher and the lower water levels. Similarly, the true measure of electric force is the difference of potential between two points between which electricity flows.

Electric potentials frequently are spoken of as electric pressures. Pressure is a very good name, because potential in an electric circuit acts just as does water pressure in a water system. Electric pressures, of course, are measured in volts. We may speak of electric pressures or pressure differences of so many volts, just as we speak of potentials and potential differences.

Water flows through piping only when pressure is greater at one end than at the other, or only when there is a pressure difference. Were pressures equal at the two ends of a pipe there would be no movement of water through the pipe, for the equal pressures would balance each other. But just as soon as there is a pressure difference, water will flow from the point of higher pressure toward the point of lower pressure.

Electricity flows through conductors only when pressure or potential is greater at one point than at another, or only when there is a pressure difference or potential difference. If potentials are equal at two points, electricity between these points is pushed just as hard in one direction as in the other, and remains stationary. When the potential is higher at one point than at another electricity will flow from the higher toward the lower potential.

Parts of a circuit which are connected through conductors to the negative terminal of an energy source may be said to have negative potential, or simply to be negative. Parts connected to the positive terminal of a current source may be said to have positive potential, or to be positive. For example, in the tube of

Fig. 33 the part marked "anode" is connected with the positive terminal of the battery, so is positive or has positive potential. The part marked "cathode" is connected (indirectly) with the negative terminal of the battery, so is negative or has negative potential.

Any forces that move, or that tend to move, electrons or electricity are measured in volts. Electromotive force, measured in volts, is the force that moves or tends to move electrons inside a current source. Potentials and potential differences, or pressures and pressure differences, all measured in volts, are forces that move or tend to move electricity through external circuits.

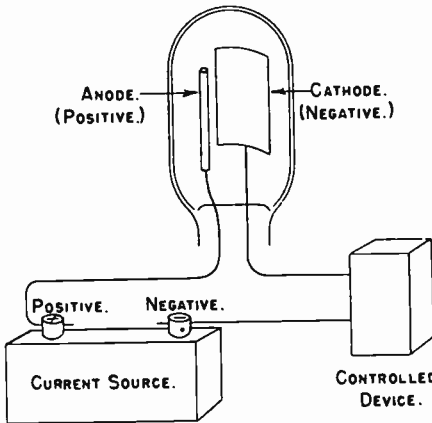

Fig. 33. Parts connected to the positive side of the energy source are positive, or have positive potential, while those connected to the negative side of the source are negative, or have negative potential.

We just mentioned forces that move or that tend to move electrons. A force that is capable of causing movement does not necessarily produce actual movement. If you push on a book, the book moves. But if you apply the same force to the wall of a building the wall doesn't move. Pressures in water systems move water only when valves or faucets are opened

to permit movement, but the pressures are there and are tending to cause movement all the time. It is the same with electricity; electromotive forces and potential differences may be present without causing flow of electrons. It is only when these forces are applied to a circuit completed through conductors that electron flow takes place.

ELECTRIC CHARGES—As we have mentioned many times, it is possible to have either an excess or a deficiency of electrons in a body. If there is an excess of electrons the body is said to be negative, or, it may be said to have a negative charge. If there is a deficiency of negative electrons, leaving an excess of positive force, the body is said to be positive, or it may be said to have a positive charge.

The unit of charge is the coulomb, which also is the unit of quantity of electricity. If a body contains $6\frac{1}{4}$ billion, billion elec-

trons more than it would have were it neutral, that body has a negative charge of one coulomb, for that is the number of electrons in one coulomb. If the body lacks $6\frac{1}{4}$ billion, billion or one coulomb of negative electricity (compared with its condition when neutral) that body has a positive charge of one coulomb.

Sometimes the word charge is used in the same sense as potential, although charge should be reserved to mean only such an excess of deficiency of negative electricity or electrons as might be measured in coulombs. It is quite common practice to say that a part such as the anode in Fig. 33 is positively charged, and that the cathode is negatively charged.

CONDUCTORS, RESISTORS AND INSULATORS—The paths or circuits through which electrons flow in electronic apparatus are composed of many different materials; some solid, some liquid, some gaseous, and quite frequently a part of the circuit consists of nothing at all—the vacuum within a tube.

Some parts of a circuit are provided solely to carry electricity from point to point with the least possible expenditure of energy or work. These are the wires and other parts made of copper, brass, aluminum and other metals having very little electrical resistance. They are the conductors. Devices such as illustrated in Fig. 34 have many conductors.

Other parts are connected into the circuits with the deliberate intention of limiting the rates of electron flow. Such limiting is necessary when the flow through some circuit or part of a circuit must be kept small, and when the only available difference in pressure or voltage is large. Electron flow-limiting materials have resistances many times greater than the resistances of materials generally used as conductors. Part of the available pressure difference then is used in overcoming the high resistance, and the pressure remaining is sufficient to force only a small current or a small flow of electricity through the path. High resistance materials used to limit electron flow are called resistors.

Still other parts in electronic apparatus are used to prevent the escape of electricity from paths in which it should remain. These materials are called insulators. Insulators or insulating materials are placed around wires and other conductors so that the electrons cannot escape into other paths, and so that people working around the apparatus are protected from high electrical pressures or voltages. Insulators are used also as supports for conductors that are carried on other conductive materials, such as steel frameworks, to which the electricity might escape.

In any material classed as a good insulator the electrons are so securely bound to their atoms that there are practically no free electrons. What is more, the electrons in good insulators refuse to leave their atom and form an electron flow, no matter how great the electrical force tending to make them do so.

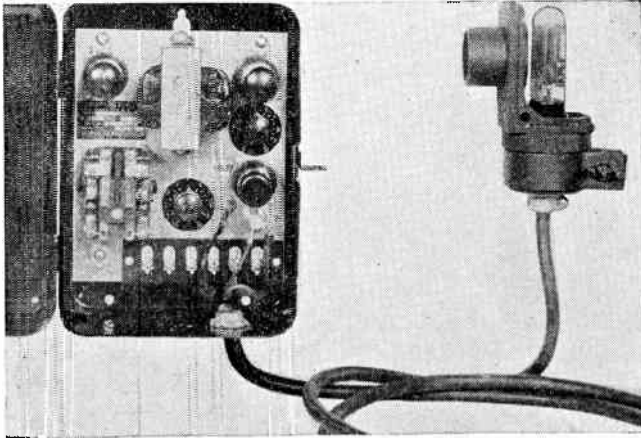

Fig. 34. In this photoelectric relay, conductors such as terminals in the bottom of the cabinet are mounted on insulators; wires between the units are covered with insulating materials; while resistors limit rates of electron flow to correct values in the circuits.

When very great electric voltages are applied to an insulator the electrons are moved a little farther from the centers of their atoms, but they are not freed from the atoms. Consequently, there can be no continuous flow of current through an insulator, for there are no free electrons to form a current. If the applied voltage is made high enough, electricity finally will be forced through the insulator. But with the electrons will go the atoms, too, the insulator will be punctured, and electricity will go through the hole.

There is no sharply drawn line between conductors, resistors and insulators. How a given substance will act depends greatly on the conditions under which it is used. Iron and steel are used as conductors in some telegraph wires, but as resistors in some types of electric motor controls. Electric switches sometimes are enclosed within an evacuated chamber because a vacuum is an excellent insulator, but in many electronic tubes the electricity is forced to flow through a vacuum, which then is a conductor of very high resistance.

RESISTANCE AND HEAT—It would be difficult to think of an operation in which work is done without producing more or less heat at the same time. If you cut metal with a hacksaw or wood with a wood saw, the saw gets decidedly warm. If you pump up a bicycle tire with a hand pump, the pump barrel gets hot. Everyone has rubbed his hands together to make them warmer in cold weather.

When an electric force does the work of pulling electrons away from their atoms and of keeping them away from the atoms to form an electric flow, the material in which the flow is formed gets warm. The greater the number of moving electrons or the greater the rate of flow, the greater the heating, because more electrons have to be pulled free to form the larger flow. The greater the resistance of the electron carrying material the more heat is produced, because it takes more work to pull electrons free in high-resistance materials.

The relations between electron flow, resistance and heat are so exact that we may make statements such as this: If a flow of one ampere flows for $1\frac{3}{4}$ minutes in a pound of copper wire of such diameter as to have a resistance of one ohm, the total amount of heat produced would raise the temperature of the copper by one degree Fahrenheit.

If we have a greater electron flow, or if we use metal of higher resistance, more heat will be produced and the temperature of the metal will undergo a greater rise. It is this kind of heating that raises the temperature of electronic tube filaments and cathodes to red heat, and of incandescent lamp filaments to white heat.

ELECTRIC POWER—Work, as previously explained, means the overcoming of an opposing force by moving something against a force that opposes the movement. Power means a rate of doing work. If you lift a ten-pound weight to a height of five feet you have done a certain amount of work in overcoming the force of gravity. You do exactly the same amount of work whether you do the lifting in a second, a minute or an hour. Here we are talking about work, not power.

Now follow the diagram of Fig. 35. If you lift the weight in ten seconds (diagram A) you have applied power at a certain rate. If you lift the weight twice as fast, or in five seconds (diagram B), you have used twice as much power, for your rate of working is twice what it was before. If you lift twice as much weight in the original time of ten seconds (diagram C) you have done twice as much work in that time, and again would have exerted twice the power.

If you lift the original weight only half as fast as at first, taking twenty seconds as in diagram D, you exert only half as much power, for you work at only half the original rate. Also, if you lift only half the original weight, but take the original ten seconds to do it, as in diagram E, you will have exerted only half the original power.

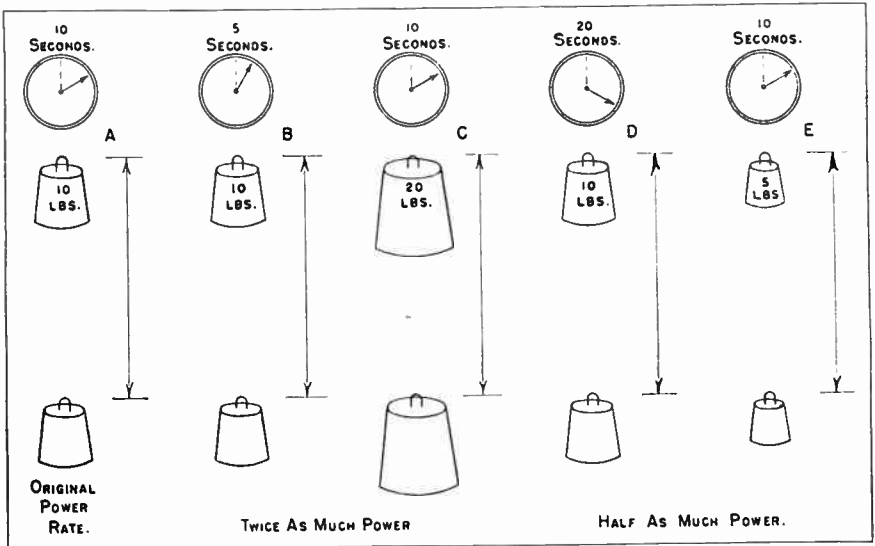

Fig. 35. Mechanical power depends on the amount of work done and on the time required to do it.

By following Fig. 36 we may see how rules for power work out when electricity is doing the work. Here we are using an "ammeter" to measure electron flow in amperes, and a "voltmeter" to measure force or potential difference in volts. To force twice the electrons or twice the rate of flow through a circuit takes twice as much power, for work has to be done twice as fast. This is illustrated by comparing diagrams A and B. By comparing diagrams C and D we note that twice the original power is required if we have to use twice the original pressure or voltage for the same electron flow, as might be the case were the resistance of the circuit to be doubled.

Since the electrical power rate varies according to the rate of electron flow and also according to the force that must be applied to cause the flow, we may say that the power rate varies with both rate of flow and force, or with both amperes and volts. It is a fact that electric power in watts is equal to the number of amperes of

electron flow multiplied by the number of volts potential difference required to maintain that flow.

Supposing we wish to double the rate of flow in a circuit of given resistance. In Fig. 37 the current of diagram A is doubled in diagram B. To drive double the number of electrons through the same resistance quite evidently will require twice the force, so at B we have twice as many electrons and twice as much voltage too. Since power is determined by the number of amperes of flow and also by the number of volts of pressure used, doubling both the electron flow and the voltage at the same time will mean four times as much power.

It is equally true that to triple the flow through a given resistance will take three times the voltage and nine times the power, for three times the original flow multiplied by three times the original voltage means nine times as many watts of power. It all works out to this: The power in watts used up in a given resistance is equal to the square of the number of amperes multiplied by the number of ohms of resistance.

In this chapter we have covered a lot of ground on the road to a mastery of electronics. We have learned to use many of the words in the language of electronics, words which will enable us to discuss electronic methods with clarity and precision of meaning in our future investigations.

The subjects we have gone over are the foundations of any understanding of practical electronics. They are so important that it would be an excellent plan to go back to the beginning and read the whole chapter through. It will astonish you how much easier and simpler everything appears after once you have been over the story.

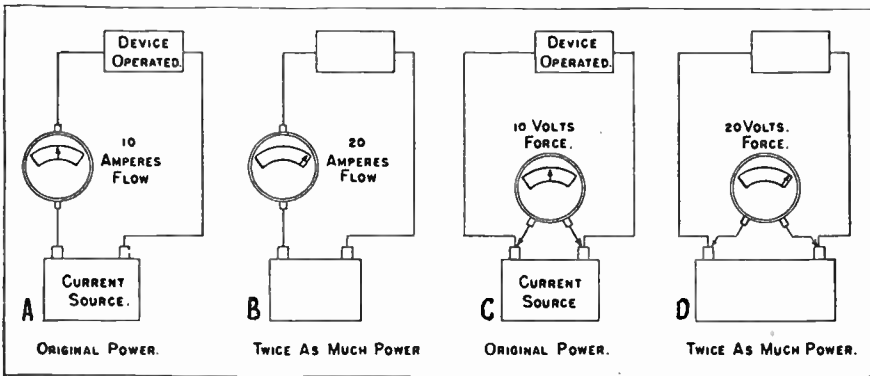

Fig. 36. The electrical power rate is increased when we increase either the rate of electron flow in amperes or the potential difference in volts.

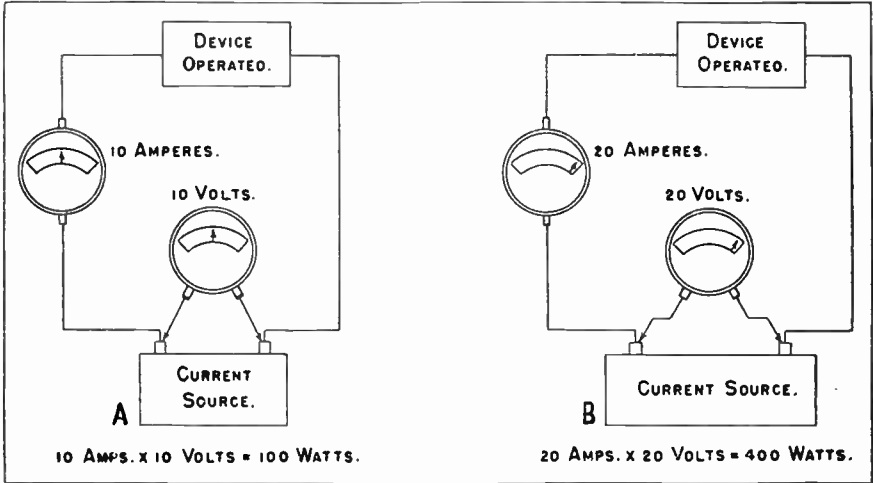

Fig. 37. Electric power in watts is equal to the number of amperes, multiplied by the number of volts used. In a circuit of given resistance the power in watts is directly proportional to the square of the electron flow in amperes.

ELECTRON FLOW AND CURRENT FLOW—In discussions of electrical and electronic subjects there frequently is confusion between electron flow and current flow. Although the two often are thought to be one and the same thing they really are distinctly different.

One direction of motion is based on the movement of free negative charges (electrons) which, being repelled by the negative terminal of the energy source and attracted by the positive terminal of the source, obviously move from negative to positive in the external circuit. This is the electron flow idea, and it is the one that we use in explaining the action of electronic apparatus.

The other direction of motion is based on the movement of free positive charges. Such charges are repelled by the positive terminal of the energy source and attracted by the negative terminal of the source, therefore, they move around the external circuit from positive to negative. This is the current flow idea.

Either of these ideas may be used in analyzing the behavior of circuits. However, we should stick to either one or the other, and should not confuse our thinking by using the terms electron flow and current flow interchangeably, even though this practice is followed by many writers and teachers. It is necessary only to keep in mind that electron flow proceeds from negative to positive, while current flow proceeds from positive to negative.

Chapter 3

ELECTRON FLOW IN A TUBE

How the Kenotron Is Operated — Electron Emission — Space Charge — Alternating Potentials — Alternating Electron Flow — Electron Flow and Potential Differences for Rectifier — Maximum Alternating Potentials and Electron Flows — Peak Inverse Potentials — Heater Cathodes.

The simplest of all electronic tubes, both in construction and operation, is the rectifier type from whose bulb have been removed air and all other gases to the greatest possible extent, leaving a nearly complete vacuum. Such a high-vacuum rectifier for industrial use is called a kenotron. A large kenotron was shown in Fig. 15.

Inside the bulb of a kenotron are two electrodes, one called the filament and the other plate, as illustrated in Fig. 38. In small kenotrons which operate at moderate potential differences the two ends of the filament are connected to two pins on the base of the tube, and the plate is connected to a third pin on the base. In large kenotrons, or in any which operate at high potential differences, the ends of the filament are connected to pins on one end of the tube, while the plate is connected to a metallic cap on the other end of the tube. Thus we have, in the high-potential tube, the entire length of the glass bulb as insulation for the great potential differences between filament and plate connections.

Fig. 38 shows symbols such as are used to indicate kenotrons in wiring diagrams. The symbol at A may be used for any kenotron having one filament and one plate, regardless of the kind of connections on the actual tube represented. The symbol at B represents a kenotron having a top connection, "P", for the plate and having its filament connected between two pins on the tube base. There are four pins on the base, to provide good support for the tube, but two of them have no connections to parts inside the tube.

HOW THE KENOTRON IS OPERATED—As shown at A in Fig. 39, the two ends of the filament of the kenotron are connected to any energy source whose potential difference will cause an electron flow through the filament. The filament energy source ordinarily is supplied from the alternating-current power and lighting lines and causes an alternating flow of electrons in the filament. However, the filament might just as well be connected to a source of

direct potential which would cause electron flow in the filament to always be in the same direction. The only purpose of the electron flow in the filament is to heat the filament to a high temperature, anything from a dull red to brilliant white, depending on the kind of filament used.

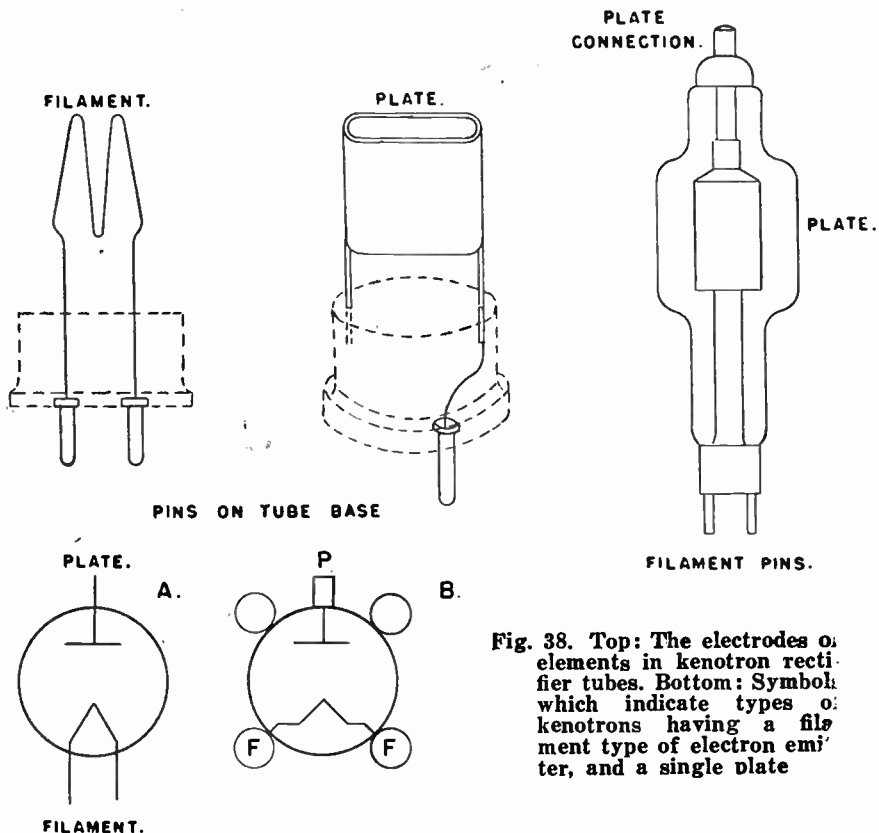

Fig. 38. Top: The electrodes of elements in kenotron rectifier tubes. Bottom: Symbols which indicate types of kenotrons having a filament type of electron emitter, and a single plate

The source of alternating potential from which we wish to obtain a direct electron flow is connected to the plate and to one side of the filament of the tube, as shown at B in Fig. 39. Either end of a source of alternating potential becomes first positive and then negative. Consequently, as shown by Fig. 39, the plate of the kenotron is first made positive while the filament is negative, then the plate becomes negative with the filament positive. Now, with the plate alternately positive and negative with reference to the filament, and with the filament maintained at a high temperature, let's see what happens to flow of electrons between filament and plate.

ELECTRON EMISSION—Within the metal of which the filament is made there are at all times great quantities of free electrons moving about among the atoms of the metal. When the filament is heated these free electrons travel at higher and higher speeds or velocities between particles of the metal. If the temperature of the filament is made high enough many of the electrons leave the

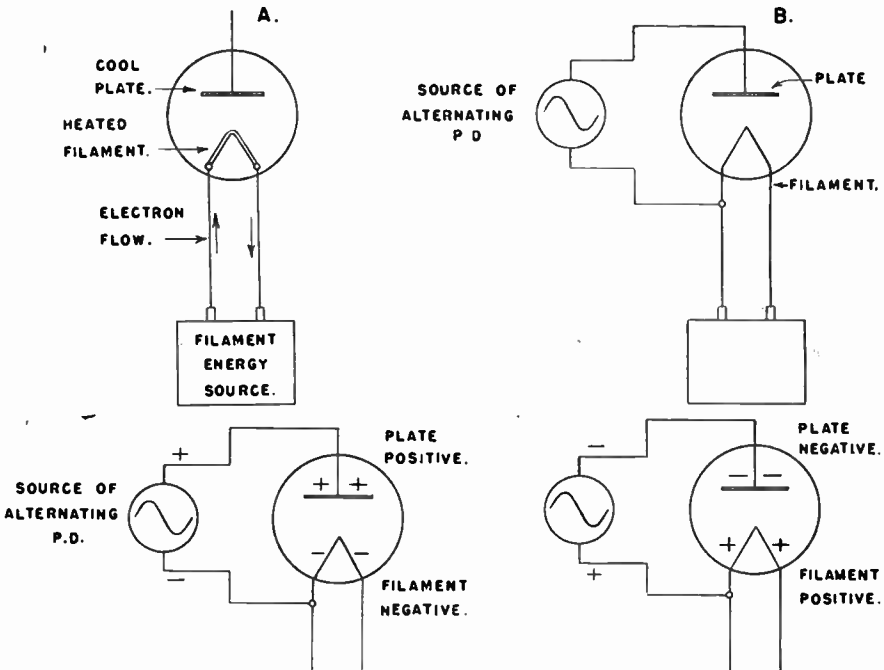

Fig. 39. Top: Connections to the filament and plate of a kenotron rectifier. Bottom: The plate becomes alternately positive and negative with reference to the filament or electron emitter.

metal of the filament and, for a brief interval, emerge into the space around the filament. Thus we have in the space near a very hot filament a cloud of electrons, which are particles of negative electricity.

If the plate of the tube has a positive potential with reference to the filament, this positive potential exerts a strong attraction for the negative electrons which are around the filament. Many of the negative electrons pass across the space within the tube and enter the plate. So long as the plate remains positive there is a continual stream of negative electrons from filament to plate, the supply of electrons being maintained by emission from the hot filament.

As indicated in diagram A of Fig. 40, electrons that enter the plate are attracted to the terminal of the potential source that is positive. Inside the potential source these electrons are forced to flow from the positive to the negative terminal, and from the negative terminal they flow back to the filament, there to replenish the supply that is being reduced by electron flow through the tube space from filament to plate. So long as the plate remains positive and the filament remains very hot there will be an electron flow through the circuit indicated by arrows at A in Fig. 40.

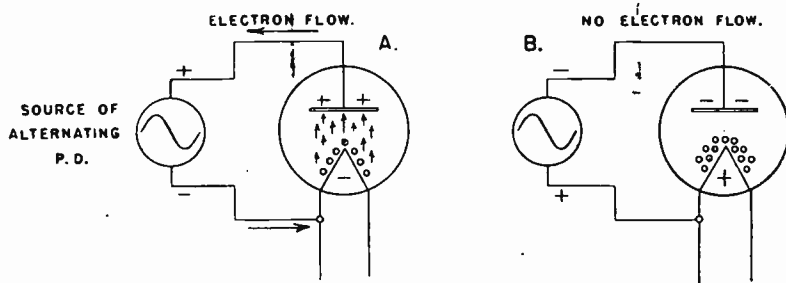

Fig. 40. Electron flow from filament to plate, and through the circuit, occurs only while the plate is positive.

When the alternating potential reverses and the plate becomes negative with reference to the filament, as in diagram B of Fig. 40, the negative electrons in the space around the filament are repelled by the negative plate and none of them pass through the space from filament to plate. Electrons still are emitted from the hot filament, but they remain around the filament and in the space between filament and plate. Thus, with the plate negative, we have no electron flow in the tube, and, of course, no electron flow anywhere else in the circuit between filament and plate.

Although the potential differences between plate and filament continue to alternate in direction, there is an electron flow through the circuit only while the potential difference is in one direction—the direction that makes the plate positive with reference to the filament. In the circuit connected to the plate and filament we have electron flow from the plate through the potential source and back to the filament, never from the filament through the source and to the plate. The alternating potential produces an electron flow in only one direction. Such a “unidirectional” flow is called a direct flow. The rectifier tube causes an alternating potential to produce a direct flow of electrons.

The reason that we have a one-way electron flow through the rectifier tube is that the filament is red hot while the plate is relatively cool. So long as the plate remains cool, free electrons cannot reach speeds that allow them to escape through the surface of the plate. As a result, even though the filament becomes positive with respect to the plate, there are no electrons available at the plate for attraction toward the positive filament.

SPACE CHARGE—Although many of the electrons emitted from the hot filament are drawn to the positive plate and form an electron flow in the connected circuit, many more of the negative electrons remain briefly in the space between filament and plate, then fall back into the filament. They fall back into the filament because loss of negative electrons by the filament leaves it somewhat less negative than the electrons themselves, and the relatively positive filament attracts the wholly negative electrons.

The electrons that are in the space between filament and plate at any one time form what is called the space charge. Because two negative bodies repel each other the negative electrons in the space charge repel other negative electrons as they attempt to emerge from the filament. Consequently, the space charge hinders or retards emissions of electrons from the hot filament.

The negative electrons of the space charge have, in effect, a negative potential, while the plate has a positive potential. These two potentials oppose each other, so the negative space charge counteracts a portion of the positive potential of the plate. The greater the space charge the less will be the electron flow through the tube for any given potential difference between filament and plate.

The rate of electron flow through the rectifier tube and through the circuit connected to the rectifier depends chiefly on the amount of space charge and on the difference of potential between plate and filament. The amount of space charge depends largely on the construction details of the tube, such as the distance from filament to cathode. The less this distance the smaller must be the space charge and the more freely electrons may flow. The greater the potential difference between the plate and filament the greater will be the rate of electron flow while the plate is positive.

As we stated earlier, not all rectifier tubes have a high degree of vacuum in their bulbs, some have a small quantity of some gas that has been intentionally admitted after the bulb first is evacuated. The action of gas tubes will be examined later on, but for the present we should know that the more completely all gases are removed from a tube that is to operate with a vacuum the more

freely electrons pass from filament to plate. With a very complete vacuum there are but few molecules to impede the electron flow. A complete vacuum also allows easier emission of electrons from the filament.

ALTERNATING POTENTIALS—The alternating potentials that are applied to a rectifier tube, and, for that matter, all other alternating potentials, may be represented by a curve such as that of Fig. 41. Points on this curve indicate potential differences that exist at any instant between the terminals of a source of alternating potential, between the filament and plate of a rectifier tube, or between any other places at which there are potential differences.

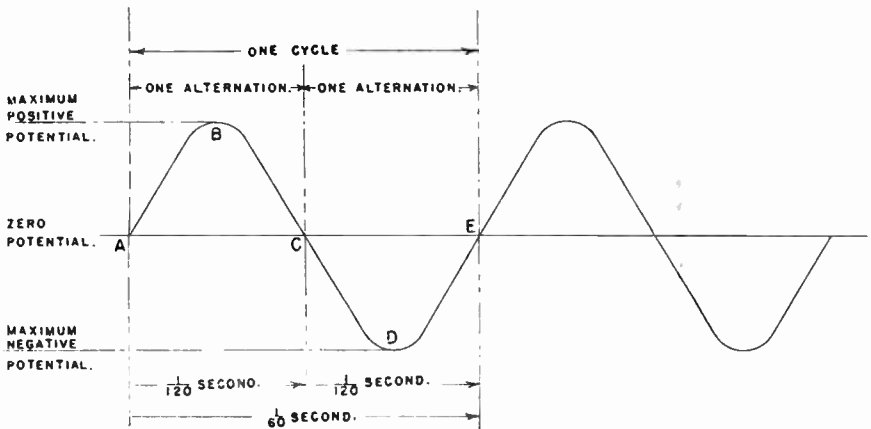

Fig. 41. A curve which represents an alternating potential.

We start, from the left-hand end of the curve, with zero potential difference at the point marked A. Then the potential difference increases until, at the point marked B, the potential at one terminal reaches its maximum positive value with respect to the other terminal. Then the potential of the terminal commences to decrease or to become less positive with reference to the other end of the circuit, and by the time we reach point C the potential difference between terminals has fallen to zero, meaning that both ends of the circuit or both terminals are at the same potential.

Now the potential of the terminal being considered commences to increase again, but in the opposite direction, and by the time we reach point D on the curve the potential of this terminal has reached its maximum negative value with reference to the other end of the circuit. Then the potential of the terminal being considered commences to decrease once more, and by the time we reach point E

the potential difference between opposite ends of the circuit again has reached to zero.

Each change of potential from zero to maximum and back to zero is called an alternation. From A to B to C is one alternation, and from C to D to E is another alternation. The changes of potential from zero to maximum in one direction, then to maximum in the opposite direction, and back to zero, as from A to E on the curve, are called one cycle.

In most power and lighting units that deliver alternating potentials the changes occur at such a rate as to make 60 complete cycles every second, so each cycle takes up $1/60$ second of time and each alternation takes up $1/120$ second, as shown in Fig. 41. We call such a power supply a 60-cycle supply.

The number of cycles per second of an alternating potential is called the frequency. With a 60-cycle supply we have a frequency of 60 cycles, or a frequency of 60 cycles per second. From some power supply lines we may obtain frequencies of 25 cycles (per second), and in other cases may find 50 cycles (per second) or various other frequencies. Power line frequencies ordinarily are less than 150 cycles per second, and are spoken of as low frequencies.

In electronic heating we use frequencies of 250,000 to 2,000,000 cycles per second, and for industrial X-ray work we use frequencies as high as 100 billion, billion cycles per second. Frequencies of 10,000 cycles and more are spoken of as high frequencies.

ALTERNATING ELECTRON FLOW—Rates of electron flow produced by alternating potentials increase and decrease in the same

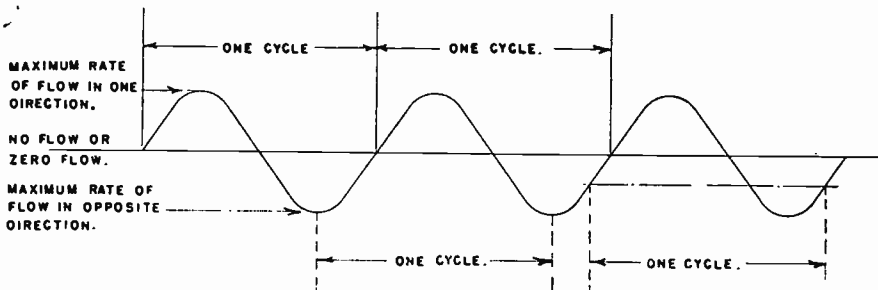

Fig. 42. A curve which represents an alternating flow of electrons.

general manner as do the potentials that cause the flow, and the direction of electron flow reverses just as does the direction of alternating potentials. An alternating flow of electrons may be represented by a curve like that of Fig. 42.

Electron flow caused by an alternating potential difference increases from zero flow to the maximum flow rate in one direction, then the flow rate decreases to zero and increases to maximum in the opposite direction, after which the rate again drops to zero ready to start over again. Each change of flow from zero to maximum in one direction, through zero to maximum in the opposite direction, and again back to zero is called one cycle. The cycles per second, or the frequency, of electron flow are the same as frequency of the alternating potential that causes the flow.

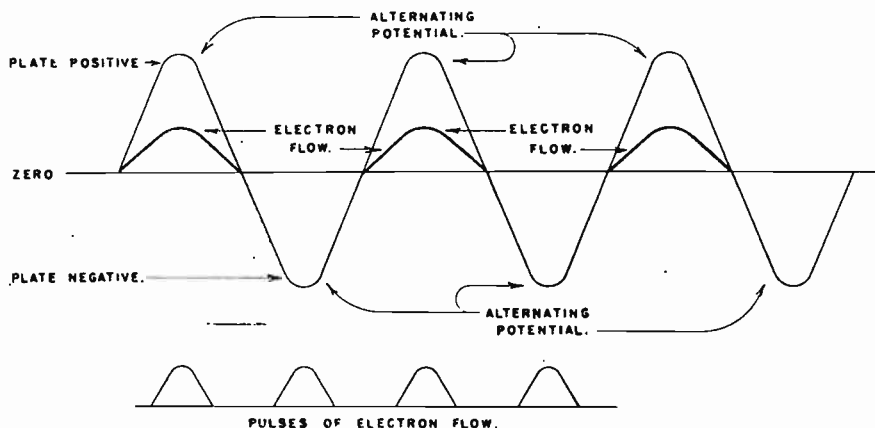

Fig. 43. Electron flow in the rectifier tube and in its plate circuit occurs only during the half-cycles when the plate is positive, thus producing pulses of direct electron flow.

How the rectifier tube actually operates is shown by Fig. 43. Here the alternating potential is shown as making the plate of the rectifier alternately positive and negative with reference to the filament. Electron flow takes place only while the plate is positive. While the plate is negative with reference to the filament there is no electron flow, although the potential difference still exists. The result is a series of pulses of electron flow, all in the same direction, and occurring during one-half of each cycle. We have produced a pulsating electron flow, but it is a direct flow because it occurs in only one direction.

ELECTRON FLOW AND POTENTIAL DIFFERENCES FOR A RECTIFIER—As we have mentioned before, vacuum types of rectifier tubes are designed to operate with high voltages or with high potential differences between plate and filament, but handle only small rates of electron flow. Large rates of electron flow are

measured in amperes, but small rates are measured in milliamperes. One milliampere is equal to 1/1,000 of an ampere. It takes 1,000 milliamperes of flow to equal one ampere of flow.

If we apply a gradually increasing difference of potential between the plate and the filament of a rectifier, with the plate positive with reference to the filament, and measure the resulting electron flows in milliamperes, we might find such relations as these:

Potential Dif. Plate-Filament volts	Electron Flow milliamps.	Potential Dif. Plate-Filament volts	Electron Flow milliamps.
0	0	94	25
30	5	110	30
50	10	132	35
65	15	165	40
80	20	240	44

In this tabulation we have listed the potential difference in volts between plate and filament at each increase of five milliamperes in electron flow. Note that we increase the potential difference from zero to 30 volts to obtain the first five-milliampere increase in electron flow, but increase the potential only another 20 volts to obtain the following five-milliampere increase of flow. Then we have a fairly steady increase of electron flow at the rate of five milliamperes for every increase of 14 to 16 volts of potential difference until we reach a flow of 30 milliamperes. But then it takes a potential increase of 22 volts, from 110 to 132, to raise the electron flow to 35 milliamperes. Finally, the potential increase of 33 volts from 132 to 165 volts increases the electron flow by only another four milliamperes.

The only way in which we can learn much from changes of potential and electron flow that occur together is to show the relations by means of a curve, as has been done in Fig. 44 for the potentials and flows just listed for the rectifier tube. A curve with suitable scales of values is called a graph, because it really is a graphic picture of what happens.

In the graph of Fig. 44 the left-hand vertical scale applies to rates of electron flow in milliamperes. The main divisions are marked 0, 10, 20, and so on. Each of the intermediate horizontal lines corresponds to two milliamperes. The bottom horizontal scale shows potential differences in volts, with each of the main divisions corresponding to 50 volts, and each vertical line corresponding to 10 volts.

If we wish to know the potential difference for an electron flow of 10 milliamperes we trace from the 10-milliamperere point on the left-hand scale across to the curve, and from the intersection of this 10-milliamperere line with the curve we trace downward to the scale of volts—where we read 50 volts as the potential difference for an electron flow of 10 milliamperes. We may trace from any other electron flow to the curve and then down to the volts scale, or we may trace from any potential difference in volts upward to the curve, then to the left and find the corresponding electron flow in the left-hand vertical scale.

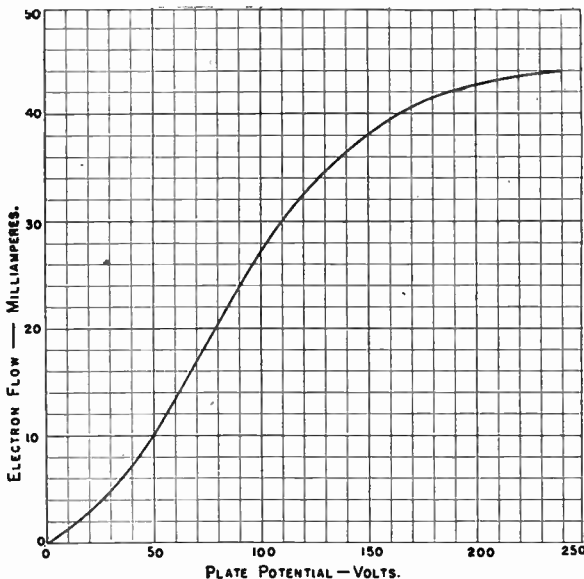

Fig. 44. How the rate of electron flow through a rectifier tube varies with changes of potential difference between plate and filament.

From the curve of Fig. 44 it is plain that electron flow increases more slowly through the low plate potentials than through the intermediate plate potentials. But at the top of the curve we see that relatively great changes or increases of potential differences cause but small increases of electron flow. It is apparent that no matter how much we increase the potential difference above 240 volts there will be very little further increase of electron flow.

The relatively small increases of electron flow at the bottom of the curve result from the fact that the many electrons in the

negative space charge counteract much of the positive potential of the plate. Then, in the middle of the curve, where we have an increase of electron flow almost directly proportional to increases of potential, the positive plate is pulling electrons fast enough to lessen the effect of the space charge.

The flattening off at the top of the curve means that the positive plate is drawing to itself all the electrons that the filament is able to emit. The only way to get more electron flow would be to raise the filament temperature or to use a larger filament or to use a filament capable of greater electron emission.

Electron tubes should not be operated at potential differences and rates of electron flow where all possible emission is being used. Such operation will severely damage the surface of the filament because the excessively high emission from some areas will quickly overheat these areas and make them useless. Then the remaining surface is overloaded more than ever, and soon the filament will either fail to deliver a normal emission rate or actually will burn in two.

Tubes should always be operated so that the filament is capable of emitting electrons at a much faster rate than actually being used for electron flow in the tube circuits. Under this condition the rate of flow from filament to plate is limited by the negative space charge in the tube, and the filament surface is not overloaded. Such safe operation is secured along the straight portion of the curve for plate potential and electron flow. In Fig. 44 this straight portion extends from about 10 milliamperes and 50 volts up to about 27 milliamperes and 100 volts. With this particular tube the plate potential should not exceed 100 volts as an absolute maximum.

Manufacturers of tubes usually furnish curves such as that in Fig. 44. In some cases there is a set of curves, one curve for each of several voltages that may be applied across the filament to heat the filament. In the published ratings for each tube are specified maximum limits for electron flow in the plate circuit, for a given potential difference between plate and filament, and for given voltages applied across the filament for heating it.

MAXIMUM ALTERNATING POTENTIALS AND ELECTRON FLOWS—Since the tube for which a curve is shown in Fig. 44 may be safely operated with plate-to-filament potential differences as great as 100 volts, it might be natural to expect safe operation when connected to a power line whose normal voltage is 100 or less—but

such an assumption would be entirely wrong, as we shall see by examination of Fig. 45.

Fig. 45 represents the increase and decrease of an alternating potential or an alternating electron flow during one alternation or one-half cycle. Considering this to be a curve for electron flow, the maximum flow is 1,000 milliamperes. If we were to measure the instantaneous rates of flow at twelve equally spaced time intervals the number of milliamperes would be as shown below the curve, provided the alternating flow were of the ideal form called a sine wave.

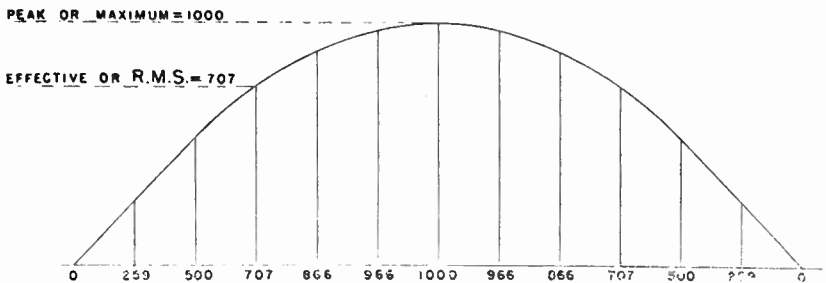

Fig. 45. The changes of potential difference and of rate of electron flow during a half-cycle of an alternating sine wave.

It is quite apparent that the total effect of all the instantaneous values shown, and all the intermediate ones which might have been included, will not be as great as though the flow were at the maximum value of 1,000 milliamperes throughout the entire alternation. The total effect of the alternation in heating a conductor would be the same as though the flow rate had remained at 707 milliamperes for the whole alternation. Since all following alternations are like this one, we find that the **effective value** of a sine wave alternating electron flow is equal to 707/1,000 or 0.707 times the **maximum value**, which also may be called the **peak value**. Similar relations exist with an alternating potential; the effective potential is equal to only 0.707 times the peak potential. **Effective potentials** and **effective flow rates** sometimes are called **root-mean-square values**, which is abbreviated to **r.m.s. values**.

If an effective value of an alternating potential difference or the effective value of an alternating electron flow is equal to 0.707 times the peak value, then the peak value is equal to 1.414 times the effective value or to $1.414/1,000$ times the effective value.

Alternating potentials and alternating electron flow rates ordinarily are specified in their effective values unless otherwise men-

tioned. When you say that the power and lighting line in a building furnishes an alternating voltage of 110 you are speaking of the effective voltage or effective potential difference. The peak potential difference is 1.414 times 110 volts, or is 155.5 volts.

Now we know why the rectifier tube whose maximum plate potential may not exceed 100 volts must not be operated from a 100-volt source. It is because the 100-volt source delivers peak potentials of 141.4 volts. Tubes nearly always are rated at maximum potentials for the plate, which means at peak potentials. You must remember that the effective potential applied to the tube may be no more than 0.707 times the peak potential. As a matter of fact we seldom should use an applied potential even as great as 0.707 times the peak potential, because ordinary variations in power and lighting line potentials may cause actual potentials much above the effective values at which the lines are rated.

PEAK INVERSE POTENTIALS—In the published ratings of rectifier tubes you always will find one value specified as “maximum peak inverse plate potential” or as some value described as an inverse potential or voltage. This is the maximum potential difference that may be applied when the plate is negative and the filament positive without forcing electrons to flow from plate to filament rather than in the normal direction from filament to plate. The peak inverse potential ranges from about three times to a great many times the usual plate-to-filament potentials applied in normal operation.

As you will observe from Fig. 43, the alternating potential applied to the plate when the plate is negative is practically the same as the plate potential when the plate is positive, so with usual circuits and ordinary operating conditions there is no danger that electrons will be forced backward through the rectifier tube.

HEATER-CATHODES—So far we have been talking about tubes in which electron emission is obtained directly from the surface of a filament that is heated by an electron flow through the metal of the filament. In other types of tubes the electron emission is obtained from a separate element or electrode called the electron emitter or the cathode, which is heated by electron flow through another metallic wire not directly connected to the cathode. One construction for an indirectly heated cathode is shown in Fig. 46.

The cathode of Fig. 46 is a cylinder of some high melting-point metal, frequently a nickel alloy, on the outer surface of which is a coating of materials that readily emit great quantities of elec-

trons at dull red heat. Inside the cathode is the heater wire which is raised to a high temperature by electron flow through it. Around the outside of the cathode, and separated a little way from the cathode, is the plate. There are many other forms of separately heated cathodes, but the operating principle is the same as shown here.

Strictly speaking, any element from which electrons enter a vacuum or a gas is a cathode, so the filament of a tube may be correctly called the cathode or may be called a directly heated cathode or else a filament-cathode to distinguish it from the indirectly heated cathode or the heater cathode shown in Fig. 46. It is true also that the plate of the tube is an anode, because anode means an element at which electrons leave a vacuum or a gas. Both the cathode and the anode may be called electrodes of the tube,

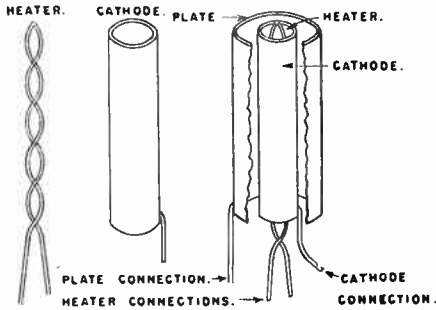

Fig. 46. The construction of a rectifier having a heater-cathode.

for electrode refers to either of the conductors at which electrons enter or leave a vacuum or a gas.

Symbols used in wiring diagrams to indicate rectifier tubes with heater-cathodes are shown in Fig. 47. The symbols having small circles around the large one indicate tubes having four

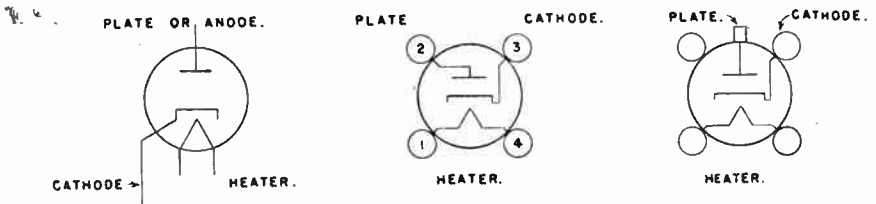

Fig. 47. Symbols for rectifier tubes having a heater-cathode.

connection pins on their base. One of these symbols indicates that the plate is connected to a cap on top of the bulb. The symbol having no small circles for base pins may be used to indicate any kind of tube having a heater, a separate cathode, and one plate or anode.

Chapter 4

HOW RECTIFIERS ARE USED

Direct Electron Flow From Alternating Potential — Transformers — Transformer Voltages — Center Taps — Connecting Rectifier to Load — Full-wave Rectifier — Full-wave and Half-wave Rectifier Tubes — Capacitors for Filtering — Capacitor Values — Filter Circuits — Filters Containing Inductors — Capacitor Input and Inductor Input.

Rectifier tubes are used wherever a direct electron flow is needed and where the available power supply delivers only an alternating potential. Direct electron flow is required for electric welding, for the economical production of many important chemicals, for charging storage batteries, for operating magnetic couplings and brakes, for separators that remove pieces of iron and steel from wood scrap which is to be processed, for powerful lifting magnets such as used in steel mills, for the testing of electric cable insulation, for operating oscillographs and X-ray apparatus, for separating impurities from air, and for driving electric motors at widely varying speeds. These are a few of the more important uses of direct electron flow such as may be secured from rectifiers.

In some of the applications just mentioned we use kenotron rectifiers which operate with high potential differences, with rather small electron flow, and with a nearly complete vacuum in the bulb. Other applications require rectifiers in whose bulbs there is a little gas or vapor, and in still other cases we use rectifiers which have, in addition to the plate and the filament or cathode, a third electrode that will time the electron flow and regulate the rate of flow.

In some rectifier applications we use an intermittent or pulsating direct electron flow such as shown by Fig. 43, with the flow occurring only on alternate half-cycles of the applied potential. In other cases we provide pulsations of electron flow during every half-cycle of the applied potential, and in still other cases we arrange that the direct electron flow shall be of practically uniform rate, with hardly any traces of pulsations remaining from the alternating potential of the supply. To understand these other methods of using rectifiers we first should examine the device by which alternating potentials are applied to rectifier tubes, this device being a transformer.

TRANSFORMERS—By means of a transformer it is possible to change the alternating potential of the supply line into any other alternating potential which will produce the potential or the potential difference required by parts to which the rectifier furnishes an electron flow.

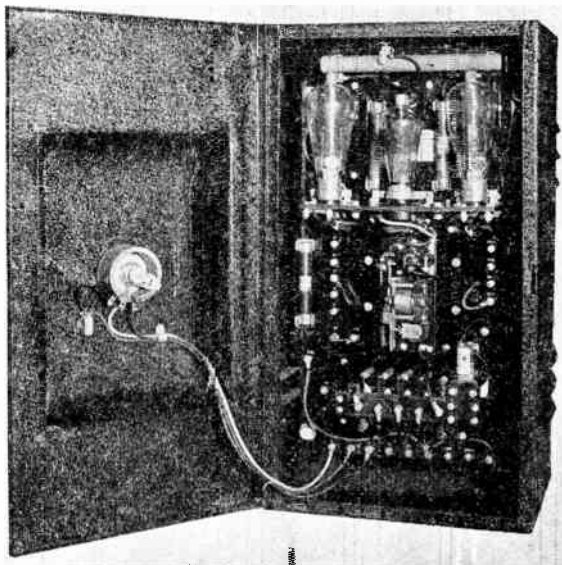

Fig. 48. This synchronous timer for electric welding operates with rectifiers that time the electron flow and regulate its rate.

A transformer consists of a "core" assembled from many thin sheets of iron or steel, with coils of insulated wire placed around a portion of this core. One style of core used in large transformers is illustrated in Fig. 49. When the coils or windings of insulated wire are placed around the central section of this core the transformer appears as in Fig. 50.

In this book we shall represent a transformer having an iron core and two separate coils or windings by the symbol shown at A in Fig. 51. In other publications you frequently will find the symbol shown at B as representing an iron-core transformer. We are using the symbol at C to represent a resistor, but wherever you find the symbol at B for a transformer you will find resistors indicated by the symbol shown at D. That is, symbols A and C are used together in a diagram, or symbols B and D are used together.

TRANSFORMER VOLTAGES—Whichever winding of a transformer is connected to the supply line is called the **primary winding** of the transformer. A winding connected to whatever appara-

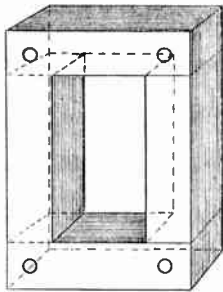

Fig. 49. The core for a large power transformer. (General Electric)

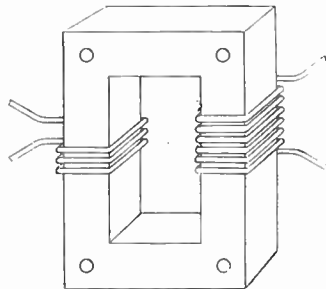

Fig. 50. The core of the power transformer with the coils or windings in place and the connection leads attached. (General Electric)

tus or device is to be furnished with electron flow is called a **secondary winding** of the transformer. This is illustrated in Fig. 52.

If the numbers of turns are the same on the primary winding and on the secondary winding, as at A in Fig. 52, the potential differ-

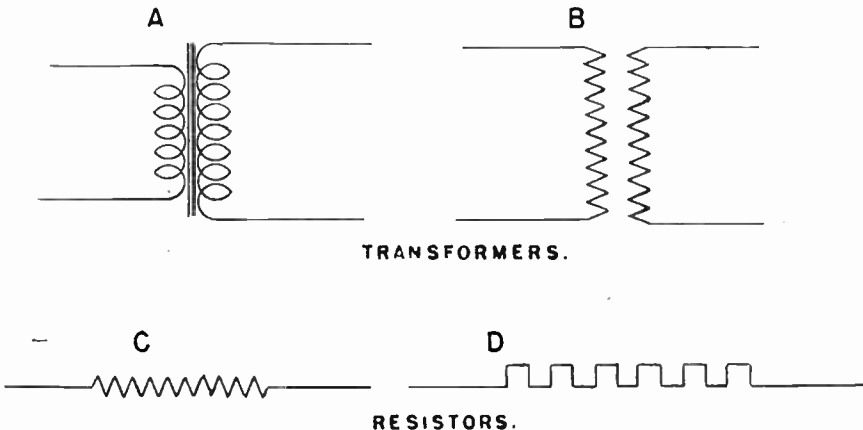

Fig. 51. Symbols for transformers and for resistors.

ence furnished from the secondary will be the same as the potential difference applied to the primary. If, as at B, there are twice as many turns on the secondary as on the primary winding, the poten-

tial difference from the secondary will be twice as great as the potential difference applied to the primary. If, as at C, the secondary winding has only half as many turns as the primary winding, the secondary potential difference will be only half as great as the primary potential difference. In any case the ratio of secondary potential difference to primary potential difference is the same as the ratio of the secondary turns to the primary turns.

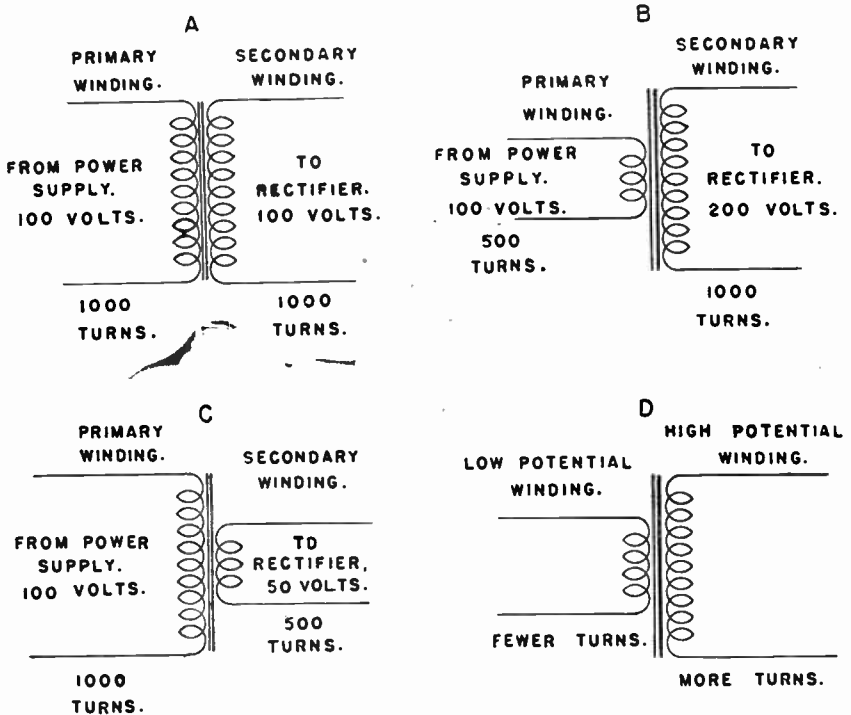

Fig. 52. The relation between primary and secondary turns and primary and secondary potential differences of transformers.

If we wish to apply a 500-volt potential difference between plate and filament of a tube, and at the same time apply a 10-volt potential difference across the ends of the filament, we may obtain both voltages from the same power line by using two transformers with suitable numbers of secondary and primary turns. From the secondary winding of the plate transformer we will obtain a 500-volt alternating potential, and from the secondary of the filament transformer will obtain a 10-volt alternating potential.

Of two transformer windings, the one with more turns must always operate at a higher potential difference than the one with

fewer turns, so, as shown in Fig. 52 at **D**, we may call the winding with more turns the **high potential winding** and the one with fewer turns the **low potential winding**. The high potential winding sometimes is called the high tension winding, and the low potential winding is called the low tension winding.

Many transformers have two secondary windings, one furnishing high potential for the plate and the other furnishing low potential for the filament or for the heater of a separate cathode. Such a transformer is shown in the diagrams of Fig. 53. The simple arrangement of diagram **A** would operate the tube, but electron flow returning from the plate circuit and plate winding to the filament would flow into only one side of the filament. This side of the filament would carry most of the electron flow for the plate circuit

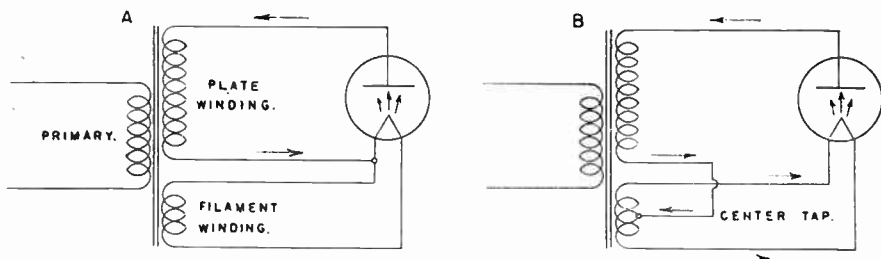

Fig. 53. Electron flow with no center tap on filament winding, and the more evenly distributed flow through the filament when there is a center tap.

and would be more heavily "loaded" than the other side of the filament. The unbalance of electron flow in the filament may be avoided by using a center tap on the filament winding of the transformer, and connecting the plate return to this center tap. Now the electron flow returning from the plate circuit flows equally into both sides of the filament.

TRANSFORMER CENTER TAPS—A connection brought out from the "electrical center" of a transformer winding is called a center tap. A center tap is connected approximately midway in the number of turns in the winding, at a point where the potential always remains midway between the potentials at the ends of the winding.

In the transformer of Fig. 54, operating with a secondary potential difference of 100 volts, we may consider that the ends of the secondary winding become alternately 50 volts positive and 50 volts negative. Then the center tap, placed midway between the two ends of the winding, always will be at a potential midway between the potentials of the ends. Look at Fig. 55.

CONNECTING THE RECTIFIER TO ITS LOAD—In Fig. 53 we have a direct electron flow in the plate circuit of the rectifier tube, but this electron flow simply passes around and around the plate circuit without doing any useful work. Before the rectifier can do anything useful, such as charging a storage battery, it must be connected to its load circuit. The load circuit for a rectifier is any circuit in which we desire to have and to utilize in some way or other, a direct electron flow.

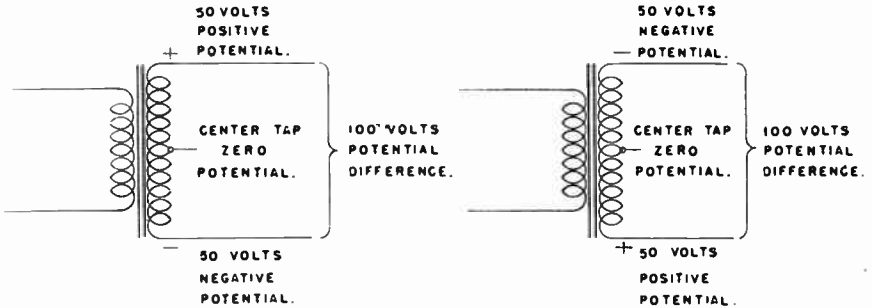

Fig. 54. The center tap remains at a constant potential, midway between the alternating potentials at the two ends of the winding.

For convenience in explanation of rectifier action we shall represent a load circuit as a resistor. The resistor stands for any device or apparatus in which there is to be produced a direct electron flow. Using a resistor to represent a load, we connect the

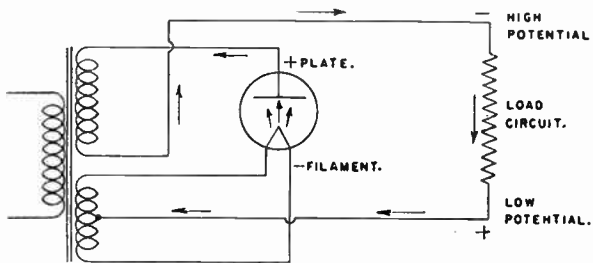

Fig. 55. How the rectifier is connected to a load.

rectifier to its load as in Fig. 55. Arrows show the direction of electron flow in the rectifier tube, the transformer windings, and the connected load. By comparing Fig. 55 with Fig. 53 you will see that we have opened the connection from the plate winding of the transformer to the center tap of the filament winding, and have run leads from these two points to the load.

Electron flow always moves from a point of negative potential toward another point of positive potential. The direction of electron flow in the load of Fig. 55 shows that the load terminal connected to the plate winding of the transformer is the negative terminal, and that the load terminal connected to the filament winding is the positive terminal. In Fig. 55 we have a practical circuit for a rectifier furnishing pulses of direct electron flow on alternate half-cycles of alternating potential applied to the rectifier. A rectifier used in this manner is called a **half-wave rectifier** because it uses only half of each wave or each cycle of applied alternating potential.

A FULL-WAVE RECTIFIER—By using two rectifier tubes, a center-tapped filament winding or filament transformer, and also a center-tapped plate winding or plate transformer we may produce a pulse of direct electron flow from both half-cycles of alternating potential applied to the rectifiers. By rectifying both half-cycles we have what is called a **full-wave rectifier system**.

One of the most commonly used circuits for full-wave rectification is shown in Fig. 56. Diagram A shows how the filaments of

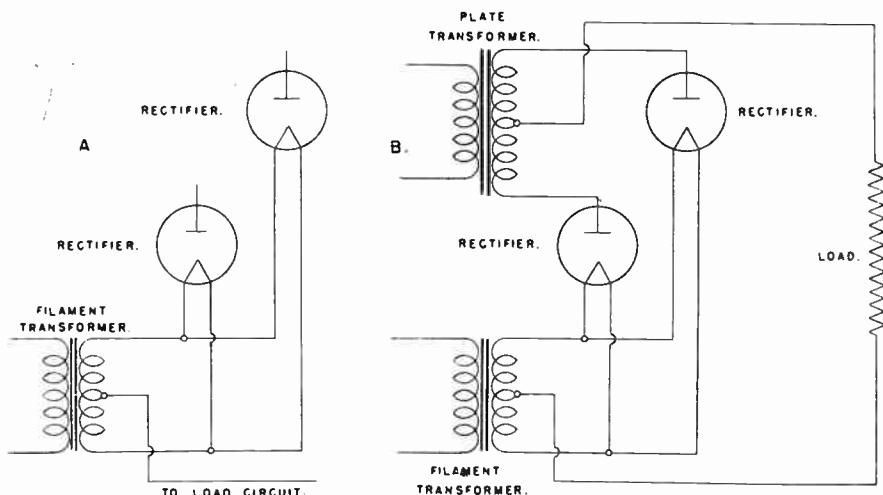

Fig. 56. A full-wave rectifier circuit containing two rectifier tubes. The filament circuit is shown at A, and the complete circuit at B.

the two rectifier tubes are connected "in parallel" to the filament transformer. Diagram B shows the complete rectifier system, with the plates of the rectifier tubes connected to the plate transformer, and with the load connected between the center taps of the plate transformer and filament transformer.

Fig. 57 shows what happens during one complete cycle (two half-cycles or alternations) of alternating potential from the secondary winding of the plate transformer. During the first half-cycle

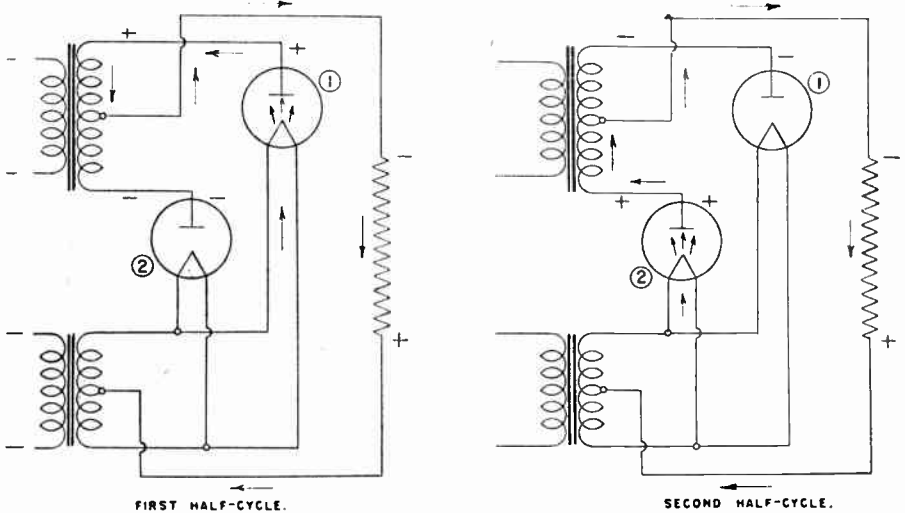

Fig. 57. Each of the two rectifier tubes conducts electron flow during one of the two half-cycles of an alternating potential cycle.

the upper terminal of the plate transformer secondary is positive and the lower end negative. This makes the plate of rectifier 1 positive and the plate of rectifier 2 negative with respect to the filaments or electron emitters. Electrons flow from filament to positive plate in rectifier 1 and through the remainder of the circuit as shown by arrows. No electrons flow to the negative plate of rectifier 2.

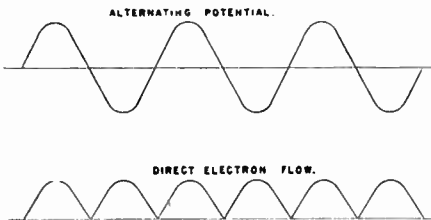

Fig. 58. The full-wave rectifier delivers pulses of direct electron flow on every half-cycle of the applied alternating potential.

During the second half-cycle the plate of rectifier 2 is made positive and the plate of rectifier 1 is made negative with respect to the emitters. Consequently there is electron flow from filament to plate in rectifier 2, and around the circuit as shown by arrows, but there is no electron flow in rectifier 1, whose plate now is negative with respect to the

emitters. During both half-cycles the electron flow through the load is in the same direction, from top to bottom in the diagrams. Just as with the half-wave rectifier, the negative terminal for the

load is the one connected to the plate and the positive terminal for the load is the one connected to the filament winding. The resulting pulses of direct electron flow in the load circuit are as represented in Fig. 58. There are two pulses of direct electron flow during each cycle of alternating potential, and the average direct electron flow in the load is twice the value it would be with one similar rectifier tube in a half-wave circuit.

FULL-WAVE AND HALF-WAVE RECTIFIER TUBES—Rectifier tubes having a single plate are called half-wave rectifiers because each such tube is capable of rectifying only half of an applied alternating potential. It was only by using two half-wave rectifier tubes in Fig. 57 that we were able to secure full-wave rectification.

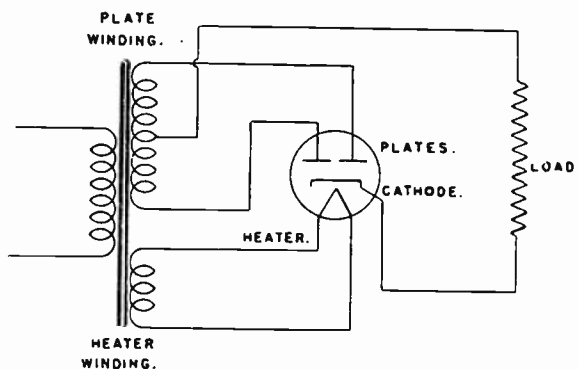

Fig. 59. A circuit containing a single rectifier tube of the full-wave type.

In other types of rectifier tubes, called **full-wave rectifiers**, there are two plates and a single filament or a single separate cathode. Such a full-wave rectifier of the separate cathode type or heater-cathode type may be used in the circuit of Fig. 59 for full-wave rectification. The two plates become alternately and oppositely positive and negative, just as do the two plates of the separate tubes in Fig. 57. Electrons flow from the single cathode or emitter to whichever plate is positive. The load is connected between the center tap of the plate winding and the cathode of the rectifier tube. The heater of the tube and the heater winding on the transformer are not parts of the circuit in which rectification takes place.

In addition to the full-wave rectifier tube represented by the symbol in Fig. 59 there are many others having the various arrangements of filaments and heater-cathodes shown by the symbols in Fig. 60. At A there are two sections of the filament, one for each

plate. At B and C there are heaters and cathodes for each of the plates, with the cathodes connected together and brought out to a separate terminal on the tube. At D and E there are heaters and cathodes for each of the plates, but the cathodes are connected together and to the heater circuit inside the tubes. The connections for all full-wave rectifier tubes follow the principles illustrated in Fig. 59.

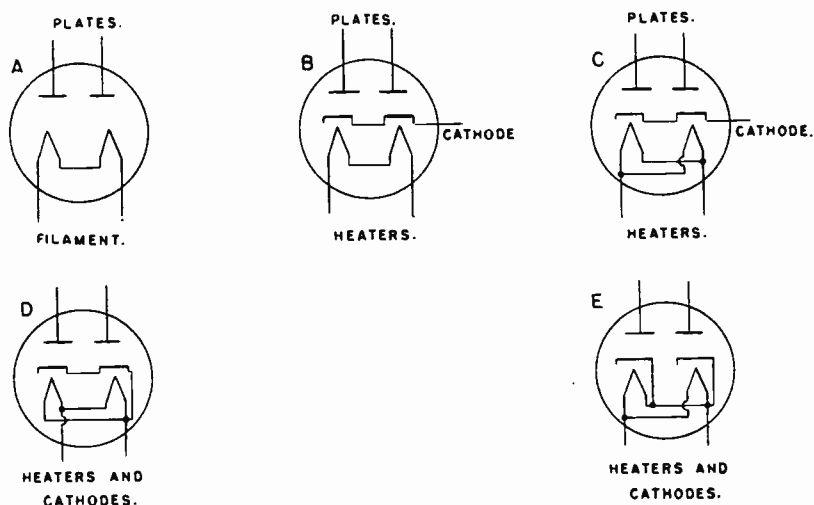

Fig. 60. Full-wave rectifier tubes may be constructed with various arrangements and connections of cathodes and heaters.

CAPACITORS FOR FILTERING—For many installments we require a smooth and practically unvarying direct electron flow rather than the rapidly pulsating direct electron flow represented in Fig. 58. Changing the pulsating direct flow to a smooth and steady direct flow is called filtering, and the apparatus used is called a filter. All filters include one or more capacitors, so before proceeding to apply a filter system to our rectifier we must learn something about the behavior of capacitors.

As shown in Fig. 61, a capacitor consists of one or more metallic sheets or plates separated by thin layers of some insulating material. Insulating material is called the dielectric when employed in a capacitor.

When a potential difference is applied to the plates of a capacitor the surfaces of the dielectric are negatively and positively charged as shown at A in Fig. 62. The side of the dielectric to which negative potential is applied through a plate becomes negatively charged, meaning that it acquires an excess of electrons. The

side of the dielectric to which positive potential is applied through the other plate is positively charged, meaning that it loses electrons. The deficiency of electrons on the positively charged side of the dielectric is exactly equal to the excess of electrons on the negatively charged side of the dielectric.



Fig. 61. A capacitor consists of insulating material, called the dielectric, between conductive plates of metal.

Because there is a difference between the number of electrons on the two sides of the dielectric there is a difference of potential between the two sides. The dielectric is an insulator, and electrons cannot move freely from place to place in an insulator as they do in a conductor. Therefore the excess of electrons persists on one side of the dielectric, while the deficiency persists on the other side.

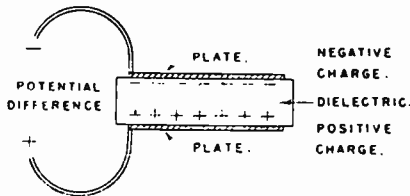

Fig. 62. The dielectric of the capacitor is charged by a potential difference applied to the dielectric through the plates.

A charged dielectric material might be removed from between the plates and the charges still would remain on the dielectric. There still would be a potential difference between the two sides of the dielectric, and if the two sides were connected together by means of a conductor, the potential difference would cause a flow of electrons through the conductor from the negatively charged side to the positively charged side of the dielectric. The electron flow would cease when the excess electrons from one side of the dielectric had passed to the side on which there was a deficiency. Then both sides would have their normal number of electrons, or

would be neutral, and there would be no remaining difference of potential to cause further electron flow.

When the dielectric of a capacitor is connected through the plates to a potential difference, the capacitor will be **charged** and the potential difference between the sides of the dielectric will become the same as the applied potential difference. If the capacitor is disconnected from the source of potential difference the capacitor will retain its charge or its potential difference. If the capacitor then is connected to any points between which there is no difference of potential, or between which the potential difference is less than that of the capacitor, the potential difference of the capacitor will cause an electron flow to the connected points. The flow will be away from the negatively charged side of the capacitor and toward its positively charged side.

If a capacitor is connected to a source of alternating potential the capacitor will be charged first in one direction and then in the opposite direction. If the capacitor is connected to a source of pulsating direct potential difference the capacitor first will be charged as the applied potential difference increases, then will discharge back through the source as the potential difference of the source decreases. The capacitor will be charged to a higher and higher potential difference so long as the applied potential difference increases, and will discharge as the applied potential decreases, because this leaves the potential difference of the capacitor higher than that of the source.

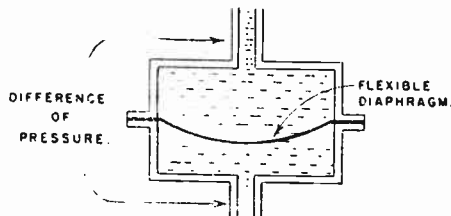

Fig. 63. A flexible elastic diaphragm in a water system acts in many ways like a capacitor in an electric circuit.

The action of a capacitor may be compared with that of a flexible diaphragm enclosed in a housing as shown by Fig. 63. If this flexible diaphragm, such as might be made from a sheet of thin rubber, is connected into a water system the diaphragm will be flexed one way or the other, depending on the difference between water pressures on opposite sides of the diaphragm.

If the housing with its flexed diaphragm were disconnected from the source of water pressure there would be a pressure difference remaining in the housing. If the housing then were connected to some water system in which there was no pressure difference, or in which the pressure difference was lower than in the housing, the diaphragm would exert its pressure and cause a flow of water into the connected piping.

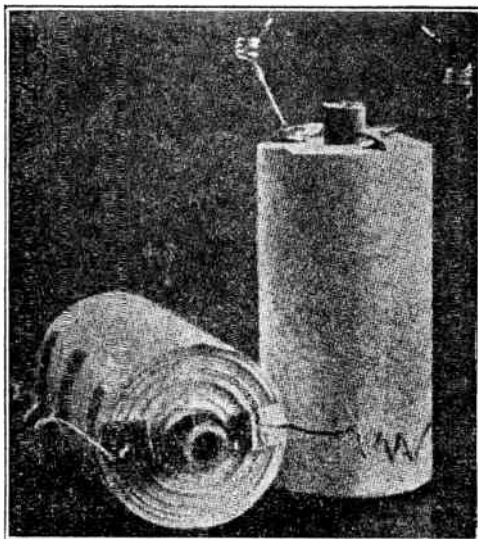

Fig. 64. Capacitors made with paper dielectric and metal foil plates rolled into a compact cylindrical shape.

The dielectric for capacitors used at potential differences up to about 1,000 volts usually is made from several thin sheets of paper impregnated with wax or oil forced into the capacitor during manufacture. For still higher potential differences the dielectric may be mica. The plates in these capacitors are made from aluminum foil or from tin foil in sheets only a few thousandths of an inch thick. Fig. 64 shows capacitors made with alternate thin sheets of paper and metal foil rolled into a cylinder. Leads or connections are brought out from the two plates.

One or more capacitors are placed in housings such as illustrated in Fig. 65, leads or terminals are brought out from the capacitor plates, and the housing is filled with insulating material. The three units at the top of Fig. 65 are "paper capacitors," mean-

ing that they are made with paper for their dielectric. The three at the bottom are **electrolytic capacitors**. In an electrolytic capacitor the dielectric is a very thin layer of gas that is formed on the surface of a metallic plate immersed in a liquid or else having a liquid held in absorbent material.



Fig. 65. Paper capacitors (top row) and electrolytic capacitors (bottom row) such as used in filter systems.

A paper or mica capacitor will withstand just as much potential difference in one direction as in the opposite direction without danger that the dielectric may be punctured and allow free flow of electrons through the capacitor. An electrolytic capacitor will withstand much greater potential differences in one direction than in the opposite direction without breaking down. Consequently, the terminals or leads of electrolytic capacitors are marked positive and negative to show which side should be connected to the positive potential and which to the negative potential of the source. Electrolytic capacitors are suitable for use only in circuits carrying a direct potential. If connected to an alternating potential there will be a large electron flow through the capacitor when the potential acts in one direction. This electron flow will overheat and quickly ruin the capacitor.

CAPACITOR SYMBOLS—In diagrams to follow we shall represent capacitors of any type by the symbol shown at A in Fig. 66. In some other diagrams a capacitor is represented by the symbol

at B. When we wish to show a movable contact which will open and close a circuit we shall use the symbol at C. In diagrams that have the symbol at B for capacitors, movable contacts are represented by the symbol at D, which is the same as our symbol for a capacitor.

In diagrams that have symbols B and D of Fig. 66 for capacitors and contacts you will find symbols B and D of Fig. 51 for transformers and resistors. When you commence to use any circuit diagram it is important to note which symbols are employed, otherwise there is danger of confusing resistors with transformers, and capacitors with movable contacts.

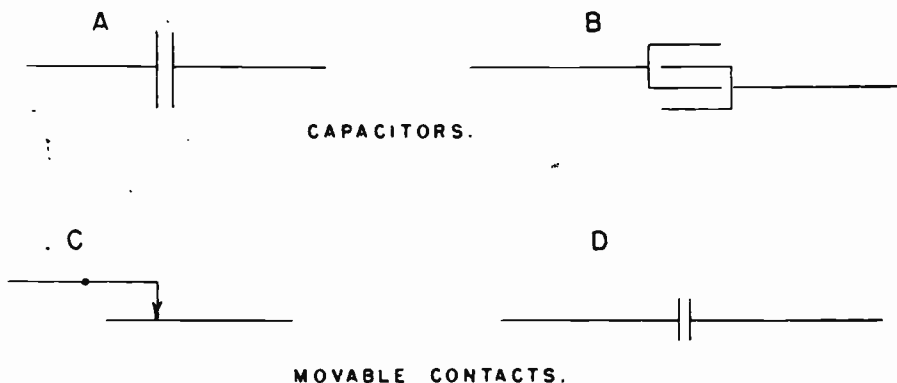

Fig. 66. Symbols used to indicate capacitors and movable contacts in wiring diagrams or circuit diagrams.

Capacitors frequently are called electrostatic condensers or simply **condensers**. The name capacitor is preferable because the property of an assembly of plates and dielectric that enables it to receive and retain a charge is called capacitance or electrostatic capacity.

The capacitance of a capacitor is measured in a unit called the **farad**. One farad is the capacitance in which a potential difference of one volt will produce a charge of one coulomb of electricity, or which will produce a charge represented by one coulomb more electrons on the negative side of the dielectric than on the positive side. Even though a capacitor were made with very thin plates and very thin dielectric it would have to be the size of a small room to have a capacitance of one farad. Capacitors of practical size have capacitances measured in **microfarads**. One microfarad is equal to the one millionth part of a farad, or it takes a million microfarads to

equal one farad. Very small capacitors have capacitances measured in micro-microfarads. One micro-microfarad is equal to the one millionth part of a microfarad.

FILTER CIRCUITS—Fig. 67 shows the simplest electrical filter system, with its counterpart for a water system. The electrical filter consists of nothing more than a capacitor connected across the load. The water system has a flexible diaphragm connected across the portion of the system in which there is high resistance to flow of water due to the small diameter and great length of the tubing.

When pulsating water pressure is increasing, the pressure forces water to flow through the high-resistance tubing and at the same time flexes the diaphragm. When the water pressure commences to decrease, the higher pressure remaining in the diaphragm chamber continues to force water through the tubing. If the diaphragm is of correct size for the water circuit, it will maintain a pressure to force water through the tubing even while the pressure from the source falls to zero.

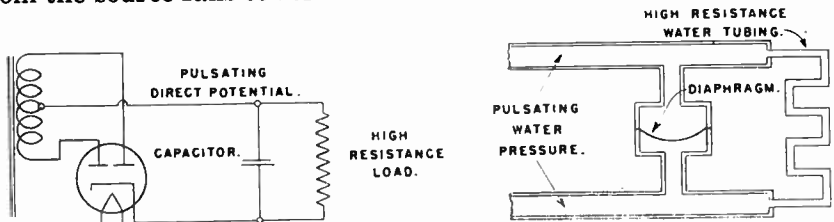

Fig. 67. A simple filter system consisting of a capacitor connected across a high-resistance load in which there is but small electron flow.

In the electrical filter system of Fig. 67 the capacitor is charged while the potential difference from the rectifier is increasing, and while this potential difference is forcing electrons to flow through the load resistance. When the potential difference from the rectifier commences to decrease, the higher potential difference of the capacitor causes a greater electron flow through the load than would take place from the applied potential alone. If the capacitor has a capacitance suitable for the load and for the electron flow in the circuit, the potential difference of the capacitor will carry over the period during which the rectifier potential drops to zero and commences to rise again. Thus the capacitor causes a relatively steady and constant electron flow through the load.

The higher potential difference remaining in the capacitor cannot force electron flow backward through the rectifier, because

that would require an electron flow from the positive plate to the negative filament—which is impossible. Thus the higher potential difference of the capacitor can force electrons to flow only through the load.

The simple filter of Fig. 67 is suitable for a high-resistance load in which there is a small electron flow. But to smooth out the rate of flow through a low-resistance load carrying a relatively large electron flow we would have to have an immense capacitance in the filter capacitor. This becomes clear if you consider the water circuit, in which we would need a very large diaphragm to smooth out the large flow through a tubing of large diameter and short length.

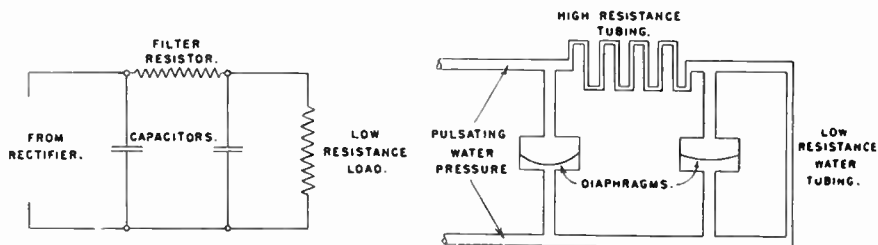

Fig. 68. A filter system consisting of two capacitors and a filter resistor between them, suitable for a low resistance load in which there is a fairly large electron flow.

For a load of relatively low resistance, say 1,000 ohms or less, we may use the filter system of Fig. 68. First we shall consider the water system of Fig. 68, where we have between the pulsating water pressure and the low-resistance tubing two diaphragms with a length of high-resistance water tubing between them. The action of the diaphragm nearest the source is much like that of the diaphragm in Fig. 67, and through the length of high-resistance tubing we have smaller pulsations than from the source. These smaller pulsations then act on the second diaphragm. This second diaphragm still further smooths the pulsations, and in the low resistance tubing we have a nearly constant rate of water flow.

In the electric filter of Fig. 68 the capacitor nearest the rectifier reduces the variations of potential difference that reach the filter resistor, just as the capacitor in Fig. 67 reduces variations of potential that reach the load resistance in that circuit. The reduced variations of potential coming through the filter resistor of Fig. 68 are applied to the second capacitor and to the load, but the second capacitor still further reduces the fluctuations, and through the load we have a fairly steady rate of electron flow.

FILTERS CONTAINING INDUCTORS—If the low-resistance load of Fig. 68 is to carry a large electron flow, the large flow through the filter resistor will cause a large drop of potential across this resistor. The potential difference furnished from the rectifier then will have to be great enough to provide the drop across the filter resistor and still leave enough drop for the load. To avoid much of the potential drop in a filter supplying a large electron flow we may substitute for the filter resistor an inductor.

An inductor consists of many hundreds of turns or thousands of turns of insulated conductor wire placed on an iron core, as shown in principle by Fig. 69. Cores for inductors generally are quite similar to those used for some types of transformers, but on the inductor we have only a single coil or winding instead of the several windings used on a transformer.

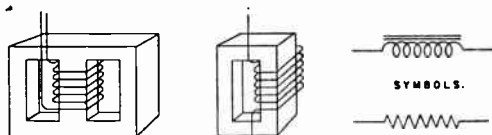

Fig. 69. The constructional principle of inductors such as used in filter systems, and symbols used for inductors.

Symbols for an inductor with an iron core are shown in Fig. 69. We shall use the symbol that appears like a coil with straight lines along one side to represent the iron core. The zig-zag line for an inductor is used with symbols B and D of Figs. 51 and 66.

An inductor possesses a most remarkable property. When there is any change of the rate of electron flow in the winding of an inductor, there is produced in the winding a potential difference that tends to oppose the change of electron flow. When the rate of electron flow is decreasing the "induced" potential difference acts in such direction as to maintain the electron flow. When the rate of electron flow is increasing, the potential difference induced in the winding is in such a direction as to oppose increase of electron flow. This property of the inductor is called **inductance**.

Inductance is measured in a unit called the **henry**. In an inductor having an inductance of one henry, the induced potential difference will be one volt when the rate of flow is changing by one ampere per second. Commonly used inductors have inductances of between three or four henrys and 100 henrys.

The inductor is an ideal unit for lessening the variations of electron flow and potential in the filter circuit. The resistance of an inductor to a steady direct flow of electrons through it is only the resistance in ohms of the wire in the winding, yet the effect of the inductance in opposing changes in the rate of electron flow may be as great as would be the effect of dozens of times its resistance. The inductor offers little opposition to the direct electron flow that we want in the load, yet offers great opposition to changes in the rate of flow, which we do not want in the load.

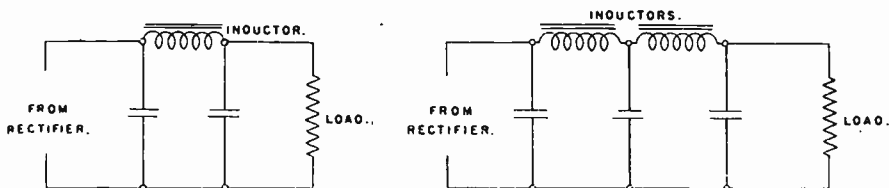

Fig. 70. Filter systems containing inductors instead of filter resistors.

Fig. 70 shows filters made with inductors and capacitors. If one inductor and two capacitors do not eliminate enough of the fluctuation in potential and electron flow we may add a second inductor and a third capacitor, as shown in one of the diagrams. A filter having two inductors and three capacitors will furnish to the load a practically constant direct potential difference and direct electron flow provided the values of capacitance and inductance have been correctly chosen. Inductors frequently are called **choke coils** or simply **chokes**, because they tend to choke back the fluctuations of electron flow.

CAPACITOR-INPUT AND INDUCTOR-INPUT FILTERS—In all the filters so far examined we have had a capacitor across the input terminals of the filter system, which means that there is a capacitor across the output from the rectifier. These are called capacitor-input filters or condenser-input filters. If we omit the first capacitor, as in Fig. 71, the input to the filter system is through an inductor, and we have what is called an inductor-input filter or a choke-input filter.

Because capacitors tend to maintain the potential difference from the filter when the rectifier potential difference drops to zero, the omission of the first capacitor from a choke-input filter will lower the potential difference across the load. However, with changes of resistance in the load, and consequent changes for elec-

tron flow demand in the load, there will be smaller changes of load potential difference with a choke-input filter than there would be under similar operating conditions with a condenser-input filter. This statement assumes that the potential difference supplied to the filter by the rectifier tube remains the same in both cases.

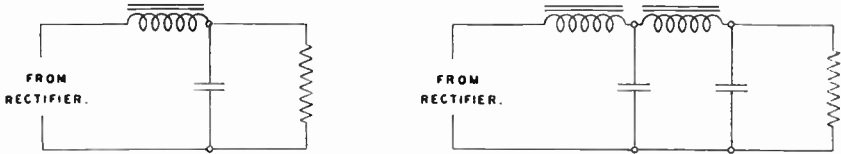

Fig. 71. Choke-input or inductor-input filters with which one side of the rectifier circuit is connected only to an inductor rather than to a capacitor and an inductor as in capacitor-input filters.

Chapter 5

RESISTORS FOR CONTROL OF POTENTIAL AND FLOW

Voltage Divider — What Resistors Will Do — Factors Affecting Resistance — Heating Due to Electron Flow — Symbols for Electrical Quantities — Watts Dissipation of Resistors — Electron Flow and Potential Difference — Drop of Potential — Series Circuits — Parallel Circuits — Rule for Electron Flow, for Resistance — Equivalent Resistance of Parts in Parallel — Resistances in Series and Parallel.

In many kinds of electronic apparatus which operate with direct electron flow we require not only a single value of direct potential but two or more different values. As many different potentials as are needed may be secured from one rectifier system as shown by Fig. 72. Instead of connecting the output side of the filter directly to the load circuit, as has been done in preceding diagrams, we here have connected the filter output to a resistor which is to act as a voltage divider.

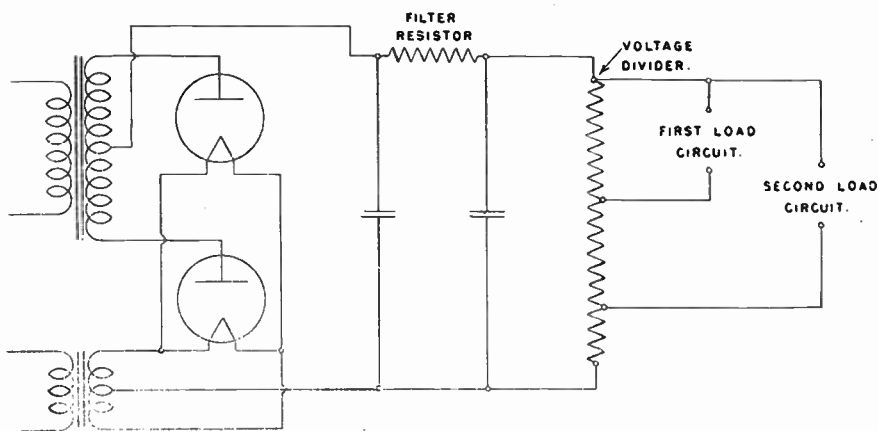

Fig. 72. A voltage divider between the rectifier filter and the load circuits.

The voltage divider of Fig. 72 is arranged to furnish two different direct potentials and two different rates of electron flow to the two load circuits. Any additional number of direct potentials and electron flows might be supplied to still other load circuits by making additional connections to the voltage divider.

The elementary principle of a voltage divider is exceedingly simple, as you may see by examining Fig. 73. Across the filter output we have a resistor in which the potential difference between the two ends is 100 volts. If the resistor is of uniform resistance from end to end there will be a uniform change of potential from one end to the other. Then, if we make connections to one end and to the middle of the voltage divider resistor, as in diagram B, the difference of potential between these two connections will be 50 volts, or will be one-half the total difference across the entire voltage divider. If we make the connections at one end and at a point three-fourths of the way from that end to the other, as in diagram C, the potential difference between the connections will be three-fourths of the total potential difference across the entire voltage divider, or will be 75 volts.

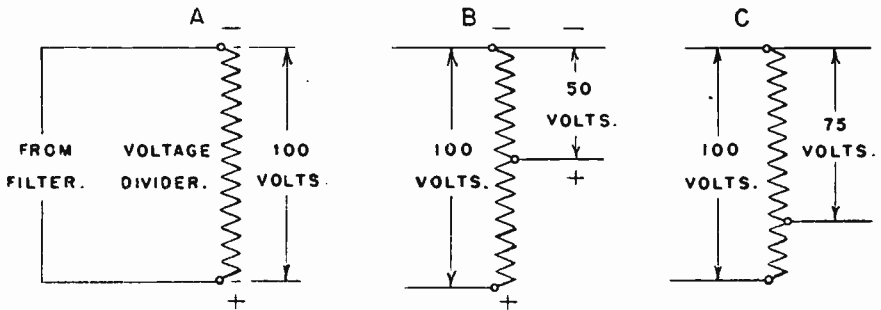

Fig. 73. The basic principle of a voltage divider.

When we come to apply this simple principle of the voltage divider to actual electronic circuits we encounter some difficulties. So long as no electron flow is taken from the voltage divider the potential differences remain exactly proportional to the portion of the total resistance that is included between the connections. But just as soon as we commence to deliver electron flow to the load circuits this simple relation no longer holds true. If we learn to calculate the resistance in ohms that should be used in a voltage divider, and in the sections of the divider between load connections, we shall have learned at the same time to solve a large portion of all the problems encountered in practical electronic applications.

If you were to examine wiring diagrams or circuit diagrams for generally used types of electronic apparatus you would find various kinds of electronic tubes represented in all of them, because without tubes the apparatus would not be electronic. But in addi-

tion to the tubes you will find many resistors, sometimes a few capacitors, usually a transformer or two, and occasionally some inductors. In the usual circuit you will find that resistors outnumber all the other elements combined. This is because resistors, when correctly chosen and applied, will limit potential differences and electron flows to any needed values; they will cause a total electron flow to divide and flow in any required portions through any paths; they will permit the application of suitable potential differences to any devices; and they will produce various potential differences from nearly any rate of electron flow. In fact, when we know how to choose and use resistors we can make electronic apparatus behave just about as we want it to behave under any operating conditions.

With all the things that resistors will do it might be natural to think that a study of their action, and of the rules and laws applying to resistors, would be quite difficult. Actually, however, almost everything we need to know about resistors is told by a single law or rule that tells us about the relations between resistance, the rate of electron flow through the resistance, and the potential differences that cause the electron flow. Before learning to use this law we shall investigate the features of a conductor that affect its resistance, or the features that determine how well suited is a conductor for use as a resistor.

FACTORS WHICH AFFECT RESISTANCE—The resistance of any electrical conductor is affected by four things; length, cross section, kind of material, and temperature.

If we consider a conductor, such as a wire, of any given size around and any given material, its resistance in ohms will be directly proportional to length. If a conductor of a certain length has a resistance of 100 ohms, a similar conductor of half the length will have half the resistance, or 50 ohms, while one of twice the length will have twice as much resistance, or 200 ohms.

The cross section of a conductor, or the cross sectional area, is the area in units such as square inches of the exposed end when the conductor is cut straight through from side to side. The resistance in ohms of a conductor of given length and material varies inversely with the cross sectional area, which means the greater the area the less the resistance, and the less the area the greater the resistance. If a conductor with a cross sectional area of one square inch were to have a resistance of 100 ohms, a conductor with a cross sectional area of two square inches, but otherwise similar, would have only half as much resistance, or 50 ohms,

while a conductor of one-half square inch cross section would have twice the original resistance, or 200 ohms.

Material has a decided effect on resistance. Metals, as a general class, have the least resistance and are the best conductors. Carbon and graphite are fairly good conductors, or have fairly low resistance, as are also many solutions of acids, salts and alkalies in water.

A convenient way to compare various materials as to their resistance is to list the resistances of conductors made from the materials, taking a diameter of 1/1,000 inch (0.001 inch) and a length of one foot. The cross sectional area of a round conductor 0.001 inch in diameter is called a circular-mil, and a conductor having a length of one foot and a uniform cross sectional area of one circular-mil is called a **circular-mil-foot**. The accompanying table lists resistances in ohms of circular-mil-feet of various conductor materials used in electronic work.

Resistances in Ohms Per Circular-Mil-Foot

Silver	9.80	
Copper	10.37	
Aluminum	17.02	ALLOY RESISTOR MATERIALS
Tungsten	33.2	Advance
*Brass	49	Comet
*Nickel	52	Constantan
Pure Iron	60	Ideal
Platinum	62	Lucerno
*Soft steel	96	*Manganin
*Hard steel	162	*Nichrome
*Cast Iron	540	Novar
Mercury	570	
Graphite	4800	

*Resistances differ in various grades and compositions.

Alloy resistor materials, manufactured under various trade names, are mixtures or alloys consisting chiefly of differing proportions of copper, nickel, chromium, iron, and manganese. In addition to having high resistances these alloys have other properties making them especially well suited to use as resistors. Many of them will operate without harm to themselves at very high temperatures, others change their resistance but little with large changes of temperature, and still others are able to withstand the

corrosive effects of certain chemicals. There are dozens of other resistor alloys in addition to the few listed.

All the pure metals and most of the resistor alloys increase their resistance to a greater or lesser extent as their temperature rises. In a copper conductor having a resistance of 100 ohms at a temperature of 70 degrees (Fahrenheit) the resistance will increase by about 9 ohms when the temperature is raised to 110 degrees. With nickel the increase would be about 14 ohms, but with soft steel it would be only about 2 ohms. With the same

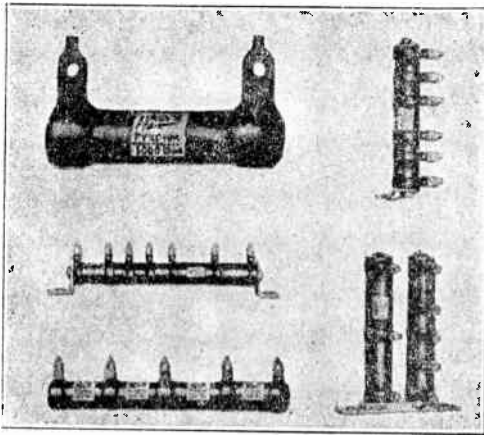

Fig. 74. A resistor with two terminals (upper left) and others with many taps or intermediate connections for use as voltage dividers.

starting temperature and same temperature rise, Lucerno alloy would increase its resistance by about $1 \frac{1}{3}$ ohm, Advance by $\frac{1}{25}$ ohm, Constantan by $\frac{1}{60}$ ohm, and Novar by $\frac{1}{100}$ ohm. One of the disadvantages of copper is its great change of resistance with change of temperature. Aluminum changes its resistance at approximately the same rate as copper.

HEATING DUE TO ELECTRON FLOW—This matter of change of resistance with change of temperature in a conductor is especially important in view of the fact that electron flow through any conductor produces heat in that conductor, and ordinarily produces a rise of temperature. Thus, since electron flow raises the temperature, and a rise of temperature increases resistance, we may say that electron flow increases the resistance of a conductor in which the flow takes place.

As an example of heating due to electron flow assume that we have a soft steel wire 1/100 inch in diameter and of such length that its resistance is 400 ohms. If an electron flow of one ampere is maintained in this wire, and if all the heat produced is kept within the wire, the temperature of the wire will go up at the rate of 20 degrees every minute. If the wire did not immediately commence to lose heat to its surroundings it would soon become red hot.

If the steel wire actually were to increase its temperature at the rate of 20 degrees per minute, due to the electron flow of one ampere, the resistance of the wire would increase at the rate of about 7 ohms per minute. Instead of the original resistance of 400 ohms we would have a resistance of 407 ohms at the end of one minute, and at the end of ten minutes would have 470 ohms of resistance.

Heating due to electron flow in conductors of high resistance is useful for raising the temperature of filaments and heaters of electron tubes and for many other applications where we wish to produce heat and high temperatures. But in resistors whose purpose it is to control potential differences and electron flows we do not want wide variations of resistance, consequently must maintain their temperatures reasonably constant.

The rate of heat production in any conductor depends on the resistance of the conductor and on the rate of electron flow in the conductor. The power that is used up in producing heat is measured in watts. The number of watts of power is equal to the square of the number of amperes of electron flow multiplied by the number of ohms of resistance. The square of any number is that number multiplied by itself. As an example of power used for heating a conductor, assume that there is an electron flow of three amperes in a resistance of 20 ohms. Then we have,

$$\begin{aligned} \text{amperes}^2 \times \text{ohms} &= \text{watts} \\ 3 \times 3 \times 20 &= 180 \end{aligned}$$

SYMBOLS FOR ELECTRICAL QUANTITIES—Instead of using the full names for electrical quantities such as amperes, ohms and watts when writing formulas and rules it is the more common practice to use letters as symbols for these quantities. For instance, instead of writing "amperes² × ohms = watts", we would write $I^2 \times R = P$. Here the letter **I** is the symbol for electron flow in amperes, the letter **R** is the symbol for resistance in ohms, and the letter **P** is the symbol for power in watts.

In the writing of formulas we do not use the sign of multiplication (×), but simply indicate quantities to be multiplied by

placing their symbols next to each other. The formula for power in watts would be written $I^2 R = P$, with I^2 and R placed side by side to show that they are to be multiplied together.

The accompanying list shows the letters used as symbols for many electrical quantities, also the units in which it is understood that these quantities are measured unless otherwise stated. As an example, the symbol I ordinarily stands for electron flow measured in amperes. But, if mention is made of the fact, this symbol may stand for electron flow in milliamperes or in microamperes. Similarly, R ordinarily stands for resistance measured in ohms, but may be used also for resistances measured in megohms. One megohm is equal to one million ohms.

LETTERS USED AS ELECTRICAL SYMBOLS

Letter	Thing Measured	Usual Unit
C	capacitance	farad
E	potential difference	volt
f	frequency	cycles per second
I	electron flow	ampere
L	inductance	henry
P	power	watt
Q	quantity or charge	coulomb
R	resistance	ohm
t	temperature	degrees
V	voltage	volt
W	energy	watt-hour

The symbol V is used only when it is necessary to distinguish between a potential difference and a single potential. Then we use V for the potential difference and E for the single potential. However, in practically all cases the symbol E stands for any value which may be measured in volts. A watt-hour of energy, whose symbol is W , is the amount of energy expended, or work done, during one hour when power is being used at the rate of one watt. Note that small letters rather than capitals are used as the symbol f for frequency and t for temperature as ordinarily measured. It always must be noted whether temperatures are measured in degrees Fahrenheit or in degrees centigrade.

WATTS DISSIPATION OF RESISTORS—When you specify a resistor for use in an electrical circuit it is not enough to give only the number of ohms required, but you must specify also the “watts

dissipation" or the rating of the resistor in watts. The watts dissipation is the number of watts of power that may be used up in the resistor without causing its temperature to rise so high as to endanger surrounding materials or the resistor itself.

The watts rating of a resistor is the maximum number of watts of power that it will dissipate or use up without causing a temperature rise of more than 250 degrees centigrade, which is equal to 450 degrees Fahrenheit, when the resistor is surrounded by at least one foot of free air space on all sides, and when the starting temperature is 40° C. or 104° F.

You might find that a 1000-ohm resistor is to carry an electron flow of 300 milliamperes, which is a flow of 0.3 amperes. Then,

$$I^2 R \text{ will be } 0.3 \times 0.3 \times 1000 = 90 \text{ watts.}$$

In this resistor the actual power dissipation will be 90 watts, and to prevent overheating we might select a unit rated at least at 100 watts. If the resistor were to be used in a confined space where heat could not be carried away readily by circulation of air around the resistor, we should select a unit rated at 150 or 200 watts. When a resistor of higher wattage rating is used, its operating temperature will not be excessive even though the heat cannot be carried away at a rapid rate.

ELECTRON FLOW AND POTENTIAL DIFFERENCE—We started out to select resistors for a voltage divider, and although we have learned something about the behavior of resistors, we have not yet learned to use the rules that allow selecting the ohms of resistance that permit a desired electron flow with an available potential difference, nor can we as yet determine the potential difference needed to produce a desired electron flow in a given resistance.

Our investigation of the relations between resistance, electron flow, and potential difference may commence with these simple facts:

1. All conductors possess more or less resistance.
2. There can be no electron flow through a resistance unless there is a difference of potential between the ends of the resistance.
3. When there is an electron flow through a resistance there must be a difference of potential across the ends of the resistance.

There can no more be an electron flow without a potential difference than there can be a flow of water through piping without a pressure difference between the ends of the piping. With no difference of pressure on the water there is no force to move the

water, and with no potential difference there is no force to move the electrons. Since there can be no electron flow without a potential difference, it follows that a potential difference always accompanies a flow of electrons in a resistance. Electron flow and potential difference always exist together.

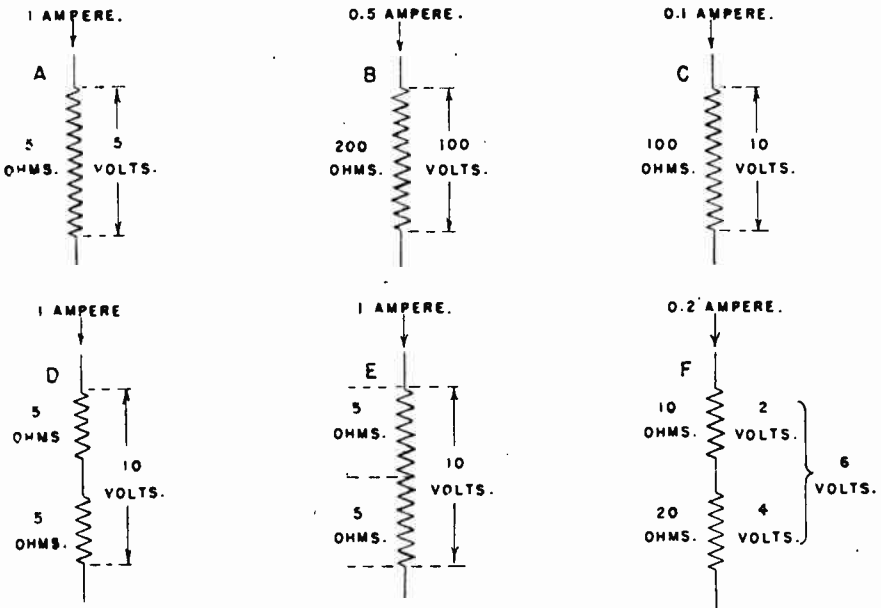

Fig. 75. Relations between resistances, electron flows, and potential differences.

Now let's inquire how many volts of potential difference will be needed to produce an electron flow of so many amperes in a resistance of so many ohms. The answer is that the potential difference in volts is equal to the number of amperes multiplied by the number of ohms. With symbols the law is stated thus:

$$E = IR$$

At A in Fig. 75 there is an electron flow of 1 ampere through a resistance of 5 ohms. Multiplying 1 (ampere) by 5 (ohms) shows that the potential drop across the resistance must be 5 volts. At B the flow is $\frac{1}{2}$ ampere and the resistance is 200 ohms. Multiplying $\frac{1}{2}$ (ampere) by 200 (ohms) shows the potential drop must be 100 volts. At C the electron flow of $\frac{1}{10}$ ampere produces a potential difference of 10 volts in a resistance of 100 ohms, because $\frac{1}{10} \times 100 = 10$.

At **D** in Fig. 75 there are two resistances of 5 ohms each connected end to end. It is plain that the rate of flow must be the same through any resistances connected end to end, just as the rate of water flow in gallons per minute must be the same through two lengths of hose connected end to end. The potential drop in each of the two 5-ohm resistances must be $1 \text{ (ampere)} \times 5 \text{ (ohms)}$, or must be 5 volts. If there is a potential difference of 5 volts in one of the resistances, and another potential difference of 5 volts in the other resistances, the total potential difference across both resistances must be 10 volts.

The resistances of the conductors that connect resistances or resistors together and to other parts of a circuit ordinarily may be neglected when these conductors are of low-resistance materials such as copper, and when they are so short as in most electronic devices. The resistance of 10 feet of copper wire of the size commonly used for connections is only $3/100$ of one ohm.

At **E** in Fig 75 we have a single resistor consisting of two sections, in each of which the resistance is 5 ohms. The potential difference across the two sections must be the same as across the two 5-ohm resistances at **D** or must be 10 volts. At **E** there are two resistances, one of 10 ohms and the other of 20 ohms. The rate of electron flow is $1/5$ ampere, and with the resistances connected end to end the flow must be the same in both units. Then in the 10-ohm resistance we have a potential difference of $1/5 \times 10$ or 2 volts. In the 20-ohm resistance the potential difference is $1/5 \times 20$, or 4 volts. Then the total potential difference across both resistances will be $2 + 4$, or 6 volts.

The potential difference in volts across a resistance of so many ohms always is equal to the number of amperes of electron flow in that resistance multiplied by the number of ohms of resistance. The rule or formula, $E = IR$, answers two questions that continually are recurring in electronic work;

1. What potential difference in volts must be provided to cause an electron flow of a required number of amperes in a given resistance?

2. What potential difference in volts results from a certain rate of flow in amperes through a given resistance?

DROP OF POTENTIAL—In Fig. 76 we have a circuit consisting of three resistances; 10 ohms, 5 ohms, and 15 ohms, connected to an energy source furnishing an electron flow of 2 amperes. This 2-ampere rate of flow must exist in all three resistances, starting from the source and returning to the source. By using the formula

$E = IR$ we find that the potential differences across the 10-, 5-, and 15-ohm resistances are respectively 20, 10 and 30 volts. The total potential difference across the entire circuit must be the sum of these separate differences, so is equal to $20 + 10 + 30$, or to 60 volts. This is the potential difference that must be furnished by the energy source.

In diagram B of Fig. 76 the left-hand terminal of the source is shown as being negative (—) and the right-hand terminal positive (+). Electron flow always is from negative to positive, so must be in the direction shown by arrows. Because of the direction of electron flow through the resistances, each resistance must have one end negative with reference to the other end, which is positive. Note that the positive end of a resistance is connected to the negative end of a resistance which follows in the circuit.

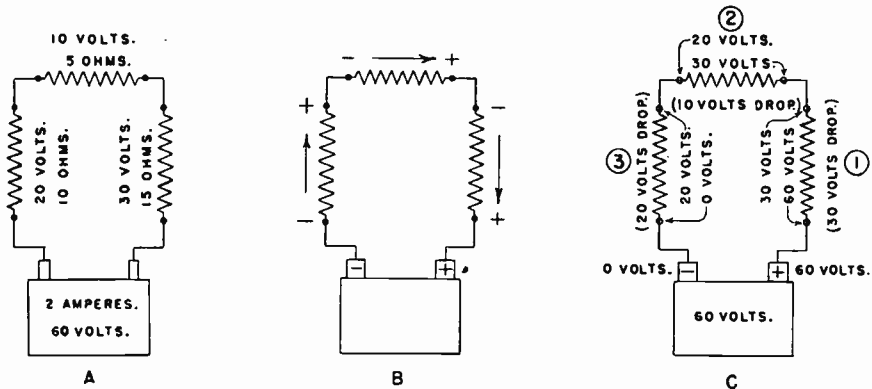

Fig. 76. Drop of potential around a circuit is proportional to the resistances in the circuit.

At the negative terminal of the source there is an excess of negative electrons. It is because of this excess of negative electricity that we speak of this terminal as negative. At the positive terminal there is a deficiency of negative electrons. Such a deficiency leaves this terminal with more positive electricity than negative electricity, so we call this the positive terminal.

We might consider that the force driving negative electrons through the circuit external to the source is due to repulsion between the excess negative electricity at the negative terminal and negative electrons in the circuit conductors. On the other hand, we might consider that the positive charge at the positive terminal attracts negative electrons from the circuit conductors, thus pulling electrons through the circuit toward the positive terminal of the source.

Actually, electron flow through the external circuit is due both to repulsion and attraction.

To make it easy to picture in our minds what happens in an external circuit it is convenient to consider that there is only one force that moves electrons, to think of this force as being of maximum strength (potential) at either the negative terminal or at the positive terminal, and to consider that this force decreases as we move through the circuit to the other end, where all of the force will have been used up. In other words, we may look at things in either of two ways: (1) maximum potential exists at the negative terminal, and zero potential at the positive terminal, or (2) maximum potential exists at the positive terminal, and zero potential at the negative terminal.

It is customary to consider the negative terminal of an energy source as being at zero potential or as at zero voltage, and to consider the positive terminal as at the maximum positive potential or voltage. This has been done at C of Fig. 76. Considering the potential difference across a resistance as the force that drives electrons through that resistance, we must use up 30 volts of our total potential of 60 volts in resistor 1, this being the potential difference across this resistance as determined in diagram A. Having a potential of 60 volts at one end of resistance 1, and using 30 volts in this resistance, leaves 30 volts of potential at the other end. In this resistor we have a 30-volt drop of potential.

The 30-volt potential left over from resistor 1 is applied to one end of resistance 2. In resistance 2 we must use up to 10 volts, as determined in diagram A, so in this resistance we have a 10-volt drop of potential, and have 20 volts remaining from the 30 volts applied. The 20-volt potential is applied to one end of resistance 3, in which we have two 20-volt potential difference or a 20-volt potential drop, leaving no potential or zero potential at the end of resistance 3 that is connected to the source.

SERIES CIRCUITS—Any circuit in which all of the electron flow that passes through any one part must pass also through every other part is called a **series circuit**. The circuit of Fig. 76 is a series circuit because every bit of electron flow in one of the resistances passes also through the other two resistances. Any parts of a circuit that are so connected together that all the electron flow through one passes also through the others are said to be connected in series. The resistances of Fig. 76 are in series with one another and with the energy source. The resistances at D and F of Fig. 75 are in series with each other.

In the simple half-wave rectifier circuit of Fig. 77 the parts connected in series include the load, the rectifier tube, and the transformer secondary winding. These parts, with the connections between them, form a series circuit, because all the electron flow through any one of them passes also through the others.

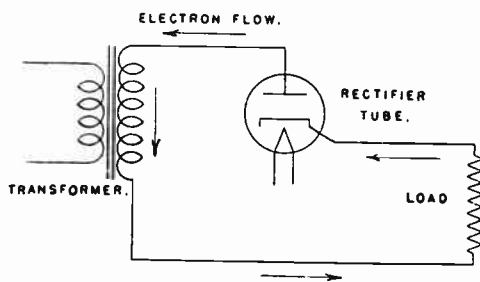

Fig. 77. The rate of electron flow, in amperes, is the same in all parts of a series circuit.

We may sum up our findings in relation to series circuits as follows:

1. Electron flow in amperes is the same in all parts of a series circuit.
2. The total resistance in ohms of all the parts in a series circuit, or of any parts connected in series, is equal to the sum of their separate resistances in ohms.
3. The total potential difference in volts of an entire series circuit, or of any parts connected in series, is equal to the sum of the potential differences or potential drops across the separate parts.
4. The potential difference of an energy source connected to a series circuit must be equal to the total potential difference of the entire circuit.

PARALLEL CIRCUITS—If you look back at Fig. 72 you will see that many of the parts are not connected in series. The two rectifier tubes are not in series because the electron flow in one of them does not pass through the other. The two loads are not in series, because each has its own separate electron flow.

In Fig. 78 we have energy sources connected to several resistances. Electron flow from the source divides, part going through one resistance and part through the others. The electron flow in one resistance is distinct and separate from electron flows in other resistances connected to the same source. When resistances or other units are connected together in such manner that the total electron flow divides between them these parts are connected in **parallel**. A

circuit consisting of parts in which the total electron flow divides between the parts is a parallel circuit.

Fig. 79 shows several resistances connected in parallel with one another, and in parallel across the energy source. The energy source furnishes a potential difference of 20 volts. Because of the negligible

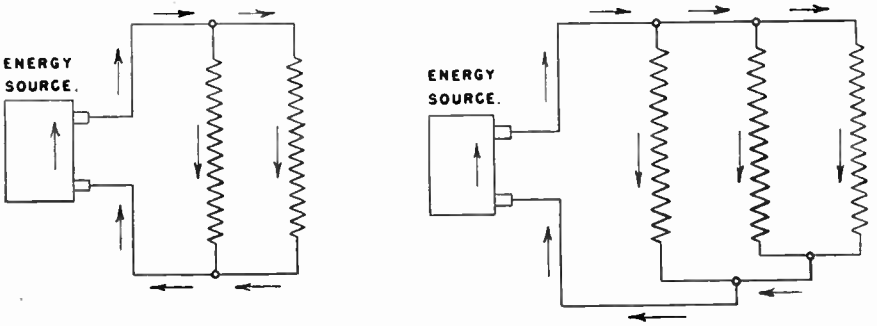

Fig. 78. The total electron flow divides between resistances connected in parallel.

resistance in the connections from the source to the resistances we consider that there are no potential drops in these connections. Consequently the potentials at the ends of the resistances are the same as the potentials at the end of the source to which they are connected, the potential drops across the resistances are the same as the potential difference provided by the source, and the potential differences are equal across all the resistances connected in parallel.

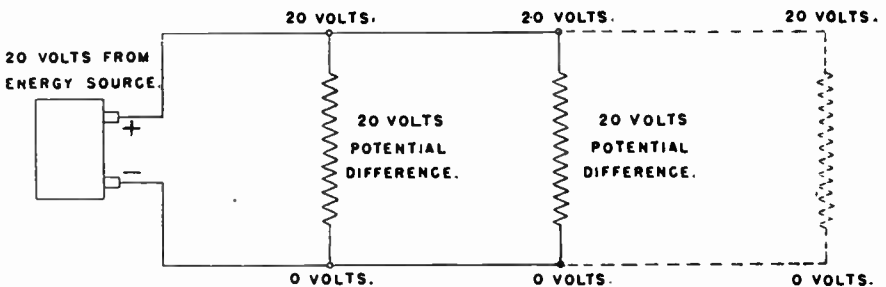

Fig. 79. Potential differences are the same across all resistances connected in parallel.

Since the potential differences are alike, and equal to the source potential, it will be easy to calculate the rate of electron flow in each resistance when we know the number of ohms of resistance in each. This, and any other calculations for electron flow rates, are made with the help of simple rule.

RULE FOR ELECTRON FLOW—The electron flow in amperes through any resistance is equal to the number of volts potential difference across the resistance divided by the number of ohms resistance. Using our symbols for amperes, volts and ohms, we may write this rule as,

$$I = \frac{E}{R} \text{ or } I = E/R$$

When one quantity is to be divided by another we write the two quantities in the form of a fraction, with the quantity to be divided above the line and the one by which the division is made below the line. Any fraction really means that the upper quantity is to be divided into as many equal parts as are shown by the lower quantity.

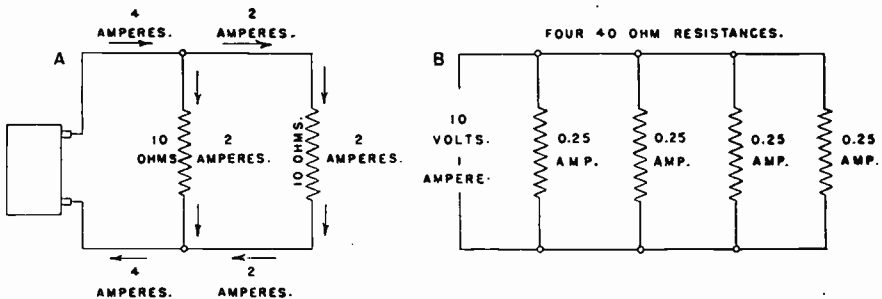

Fig. 80. Total electron flow to and from parts in parallel is equal to the sum of the flows in the separate parts.

At A in Fig. 80 there are two 10-ohm resistances in parallel across a source furnishing 20 volts potential difference, and a potential difference of 20 volts across each resistance. Now we may use our new formula :

$$I = E/R \text{ or } I = 20/10 = 2 \text{ amperes}$$

Thus we find that there is an electron flow of 2 amperes in each of the two resistances. If each resistance takes 2 amperes the total electron flow to be furnished from the source must be 4 amperes, of which 2 amperes goes through one resistance and 2 amperes through the other resistance.

At B in Fig. 80 there are four resistances of 40 ohms each. Again we use our formula to determine the electron flow in each resistance;

$$I = E/R \text{ or } I = 10/40 = \frac{1}{4} \text{ ampere}$$

If a flow of $\frac{1}{4}$ ampere passes through each of the four resist-

ances, the total flow delivered to the four resistances in parallel must be 4 times $\frac{1}{4}$ ampere, or 1 ampere.

In Fig. 81 there are three resistances of 10, 5, and 15-ohm value connected in parallel across a potential difference of 60 volts. For each resistance we calculate the electron flow by using the formula $I = E/R$, finding that the flow rates are respectively 6, 12 and 4 amperes. Then the total electron flow to the three resistances in parallel must be the sum of the separate flows in each, or must be 22 amperes. Note that in Fig. 76 the same resistances connected in series across the same potential difference allowed a flow of only 2 amperes.

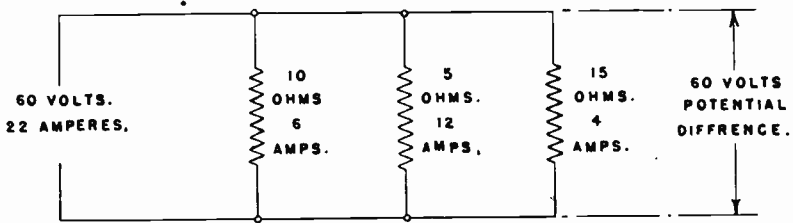

Fig. 81. Different resistances of parallel parts permit different rates of electron flow in the parts.

So far we have learned that the potential difference is the same across any number of parts connected in parallel, and have learned also how to calculate the total electron flow when we know the resistances of the several parts or several branches of the parallel group. Now we should like to know the **equivalent resistance** of several parts in parallel, or should like to know the value of a single resistance that would replace all the separate resistances and still permit the same rate of electron flow. Before we may calculate this equivalent resistance of parts in parallel we must get acquainted with a rule for determining any resistance when we know the potential difference and the rate of electron flow.

RULE FOR RESISTANCE—The resistance in ohms of an entire circuit or of any portion of a circuit is equal to the number of volts potential difference across the circuit or part, divided by the number of amperes electron flow in the circuit or in part of a circuit being considered. This rule may be shown as follows:

$$R = \frac{E}{I} \quad \text{or} \quad R = E/I$$

All we need do to check this rule or formula is to look back at

the values of ohms, volts and amperes shown in some of the preceding diagrams, thus:

Figure No.	R in ohms	= $\frac{E}{I}$	or $\frac{\text{volts}}{\text{amps.}}$	Figure No.	R in ohms	= $\frac{E}{I}$	or $\frac{\text{volts}}{\text{amps.}}$
75-A	5	=	$\frac{5}{1}$	76-A	2	=	$\frac{20}{10}$
75-B	200	=	$\frac{100}{\frac{1}{2}}$	76-A	2	=	$\frac{10}{5}$
75-C	100	=	$\frac{10}{\frac{1}{10}}$	76-A	2	=	$\frac{30}{15}$
75-D, E	10	=	$\frac{10}{1}$	81	10	=	$\frac{60}{6}$
75-F	1/5	=	$\frac{6}{30}$	81	5	=	$\frac{60}{12}$
80-A	10	=	$\frac{20}{2}$	81	15	=	$\frac{60}{4}$
80-B	40	=	$\frac{10}{\frac{1}{4}}$				

Now we have three rules and three formulas for the relations between potential difference in volts, electron flow in amperes, and resistance in ohms, either in a complete series circuit or in any one part of a circuit which may be a series circuit or a parallel circuit. Here are the three rules and formulas:

- $E = IR$ Potential difference in volts is equal to electron flow in amperes multiplied by resistance in ohms.
- $I = \frac{E}{R}$ Electron flow in amperes is equal to potential difference in volts divided by resistance in ohms.
- $R = \frac{E}{I}$ Resistance in ohms is equal to potential difference in volts divided by electron flow in amperes.

All three rules and formulas hold true in any part of a circuit or in any complete circuit where one of them applies. Which one we use depends on whether we wish to learn the value of potential difference, electron flow, or resistance when the other two values already are known. The three rules simply are different ways of expressing the law that electron flow always is proportional to the potential difference and inversely proportional to the resistance in which the flow takes place. This law was first stated by Georg Simon Ohm in 1826, and is called Ohm's law.

EQUIVALENT RESISTANCE OF PARTS IN PARALLEL—A most useful rule for determining the equivalent resistance of two resistances in parallel is as follows: The equivalent resistance in ohms is equal to the product of the two resistances divided by the sum of the two resistances, all in ohms. That is, you first multiply the numbers of ohms together, then you add the numbers together, and then divide the first result by the second. Written as a formula we have,

$$\text{Equivalent resistance} = \frac{\text{first resistance} \times \text{second resistance}}{\text{first resistance} + \text{second resistance}}$$

Supposing we have resistances of 10 ohms and 15 ohms in parallel, and wish to find the equivalent resistance. Here is the solution:

$$\text{Equivalent resistance} = \frac{10 \times 15}{10 + 15} = \frac{150}{25} = 6 \text{ ohms}$$

The same rule may be used to determine the equivalent resistance of any number of resistances in parallel. All we need do is to start with two of the resistances and determine their equivalent resistance, which gives us a single resistance that will take the place of the two we start with. Then we take this equivalent single resistance and another of the separate resistances which are in parallel, thus obtaining two more resistances whose equivalent may be found.

For an example assume that we have paralleled resistances of 10, 15 and 5 ohms, as shown in Fig. 81. First we calculate the equivalent resistance of 10 ohms and 15 ohms by using our rule of dividing the product by the sum. We already have calculated this equivalent resistance as 6 ohms. Now all we need do is calculate the equivalent resistance of this 6 ohms and the 5 ohms of the third resistance.

$$\text{Equivalent resistance} = \frac{6 \times 5}{6 + 5} = \frac{30}{11} = 2 \frac{8}{11} \text{ ohms}$$

We may prove that the equivalent resistance of 10, 15 and 5 ohms in parallel is $2 \frac{8}{11}$ ohms from Fig. 81, where we have a potential difference of 60 volts and a total electron flow of 22 amperes. Ohm's law says that resistance in ohms is equal to potential difference in volts divided by electron flow in amperes, or that $R = E/I$. Substituting our known volts and amperes we have,

$$R = \frac{60 \text{ (volts)}}{22 \text{ (amps)}} = 2 \frac{8}{11} \text{ ohms}$$

Were there four resistances in parallel we would calculate the

equivalent resistance of any two of them, then use this equivalent resistance together with one more of the separate resistances to get another equivalent resistance, and finally use this second equivalent resistance, and finally use this second equivalent resistance with the remaining original separate resistance. Any greater number of parallel resistances may be handled in similar manner.

To find the equivalent resistance of any number of equal resistances in parallel, simply divide the resistance of one branch by the number of branches or the number of resistances. For example, the equivalent resistance of three 45-ohm resistances in parallel is equal to 45 divided by 3, or is 15 ohms.

Often it is important to keep in mind that the equivalent resistance of any separate resistances in parallel is less than the least separate resistance. This means that the total electron flow for the group of parallel resistances always is more than the flow that would take place through any one alone with the same potential difference.

RESISTANCES IN SERIES AND PARALLEL—In many electronic circuits we have control resistors in parallel, or have a control resistor in parallel with a load, and at the same time have other re-

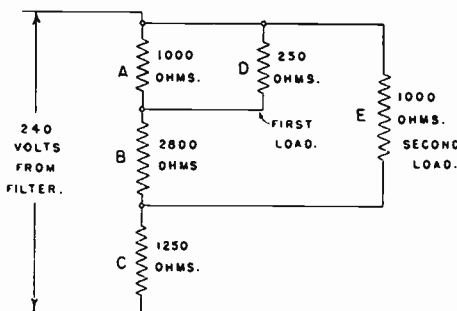

Fig. 82. Resistance values assigned to sections of the voltage divider and to the loads.

sistors or loads in series. The loads and voltage divider of Fig. 72 form such a combination of parallel and series resistances. The first load is in parallel with the upper section of the divider, the second load is in parallel with the two upper sections of the divider, and the lower section of the divider is in series with all the other parts.

We may gain valuable practice in analyzing the effect of resistances in series and in parallel by considering the voltage divider

and loads to have the resistances shown in Fig. 82. The first step in analysis is to consider the parallel resistances A and D shown separately at 1 in Fig. 83. The equivalent resistance of 1000 ohms and 250 ohms in parallel is 200 ohms, so we may represent resistors A and D as the 200-ohm resistor A-D in diagram 2. The 200 ohms of A-D is in series with voltage divider resistor B, whose resistance is 2800 ohms. Since the resistance of resistors in series is equal to the sum of the separate resistances, we may represent resistors A-D and B as a single 3000-ohm resistance at A-D-B of diagram 3.

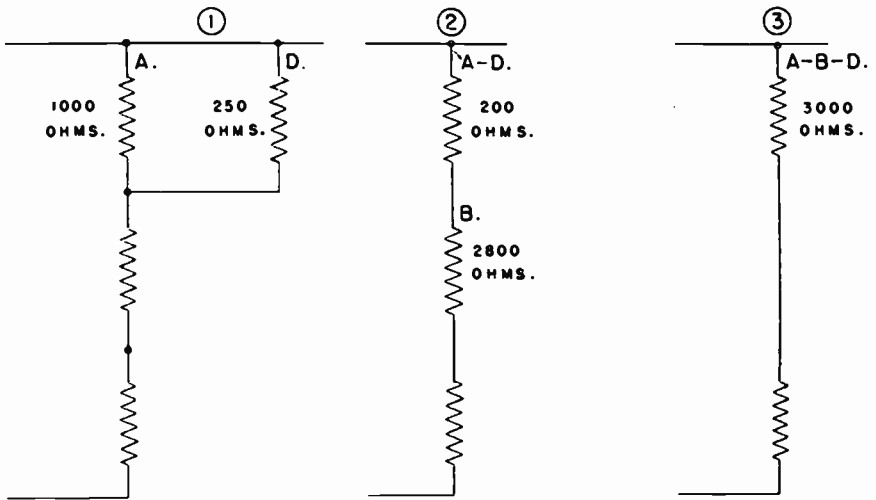

Fig. 83. Equivalent values are found for parallel resistances, and these equivalents are considered as being in series with other resistances.

Our 3000-ohm resistance A-D-B is in parallel with the 1000 ohms of load resistor E, as shown by diagram 1 in Fig. 84. The equivalent resistance of 3000 ohms and 1000 ohms in parallel is 750 ohms, as represented by the equivalent resistance A-D-B-E of diagram 2. The equivalent resistance of 750 ohms is in series with voltage divider resistor C of 1250 ohms, so the two together have a total resistance of 2000 ohms, as in diagram 3.

Now we have a potential difference of 240 volts across a combination of resistances equivalent to 2000 ohms. The electron flow will be found from the formula $I = E/R$. Dividing 240 volts by 2000 ohms gives $240/2000$ ampere of electron flow, which is equal to $120/1000$ or 0.120 ampere, and is the same as 120 milliamperes. When dealing with fractions of amperes it almost always is easier

to use the milliampere (1/1000 ampere) as our unit of electron flow.

To determine how the total electron flow of 120 milliamperes and the total potential difference of 240 volts divide in the resistances of the voltage divider and loads we shall work backward through the diagrams. Diagram 1 of Fig. 85 corresponds to diagram 2 of Fig. 84. The total potential difference of 240 volts divides proportionately to the resistances, so in equivalent resistance A-D-B-E we have 90 volts potential difference and in resistor C have 150 volts. The electron flow must be the same, 120 milliamperes, in these series resistances.

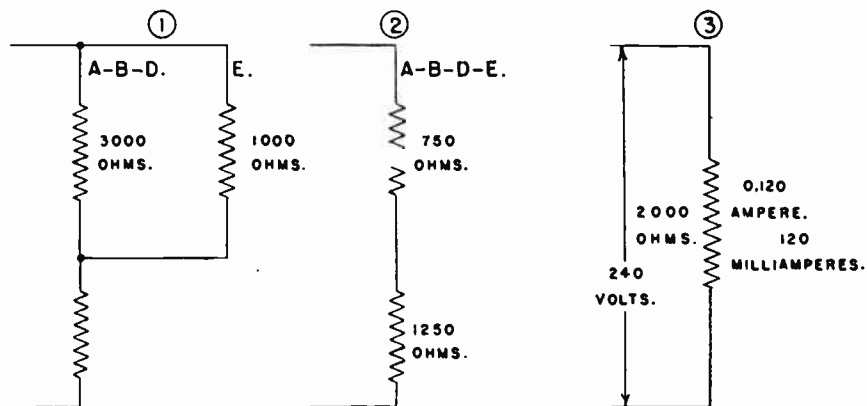

Fig. 84. Continuing with equivalent resistances for units in parallel, and determining total resistance for parts in series, reduces the voltage divider to a single equivalent resistance in which the rate of electron flow is easily determined.

In diagram 2 of Fig. 85 we have separated the resistances into the equivalent A-D-B of 3000 ohms, and load resistor E of 1000 ohms. Potential difference is the same across resistances in parallel, so here we have a potential difference of 90 volts across the 3000 ohms of A-B-D, and have 90 volts across the 1000 ohms of E. To determine the rates of electron flow in A-D-B and in E we may use Ohm's law for electron flow, $I = E/R$, as follows:

In A-D-B $I = 90/3000 = 30/1000$ ampere, 30 milliamperes.

In E $I = 90/1000 = 90/1000$ ampere, 90 milliamperes.

Note that the ratio of resistances in A-D-B and E is 3000 to 1000, or 3000/1000, or 3 to 1. Note that the ratio of electron flows in A-D-B and E is 30 to 90, or 3/9, or 1 to 3. Electron flows in

parallel resistances are inversely proportional to the respective resistances, meaning that inverting the ratio of resistances gives the ratio of electron flows, and vice versa.

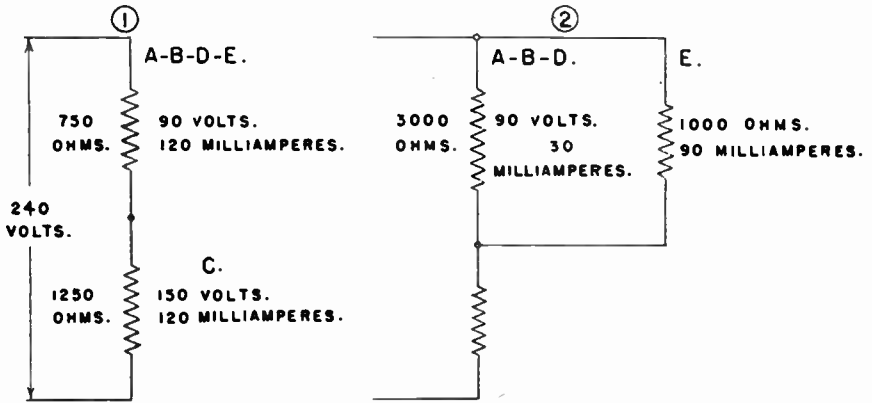

Fig. 85. Separating series resistances, and dividing equivalent resistances into their parallel parts, allows determining electron flows and potential differences across the parts.

In diagram 1 of Fig. 86 (corresponding to 2 of Fig. 83) we have separated resistances A-D with 200 ohms and B with 2800 ohms. The total potential difference of 90 volts divides in propor-

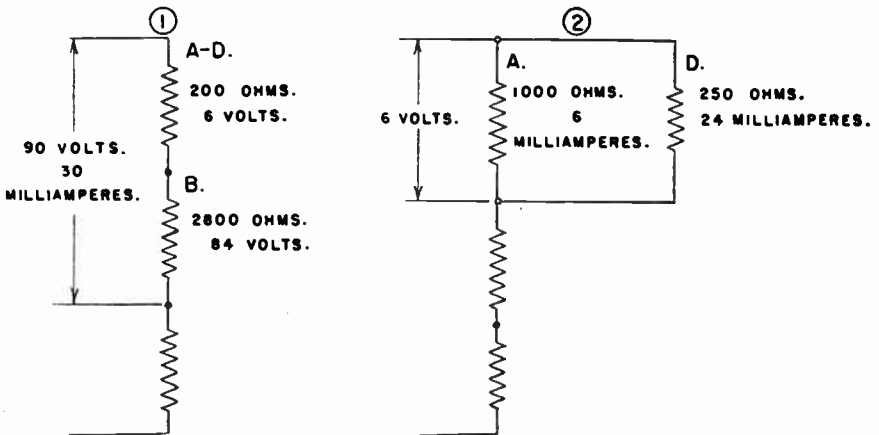
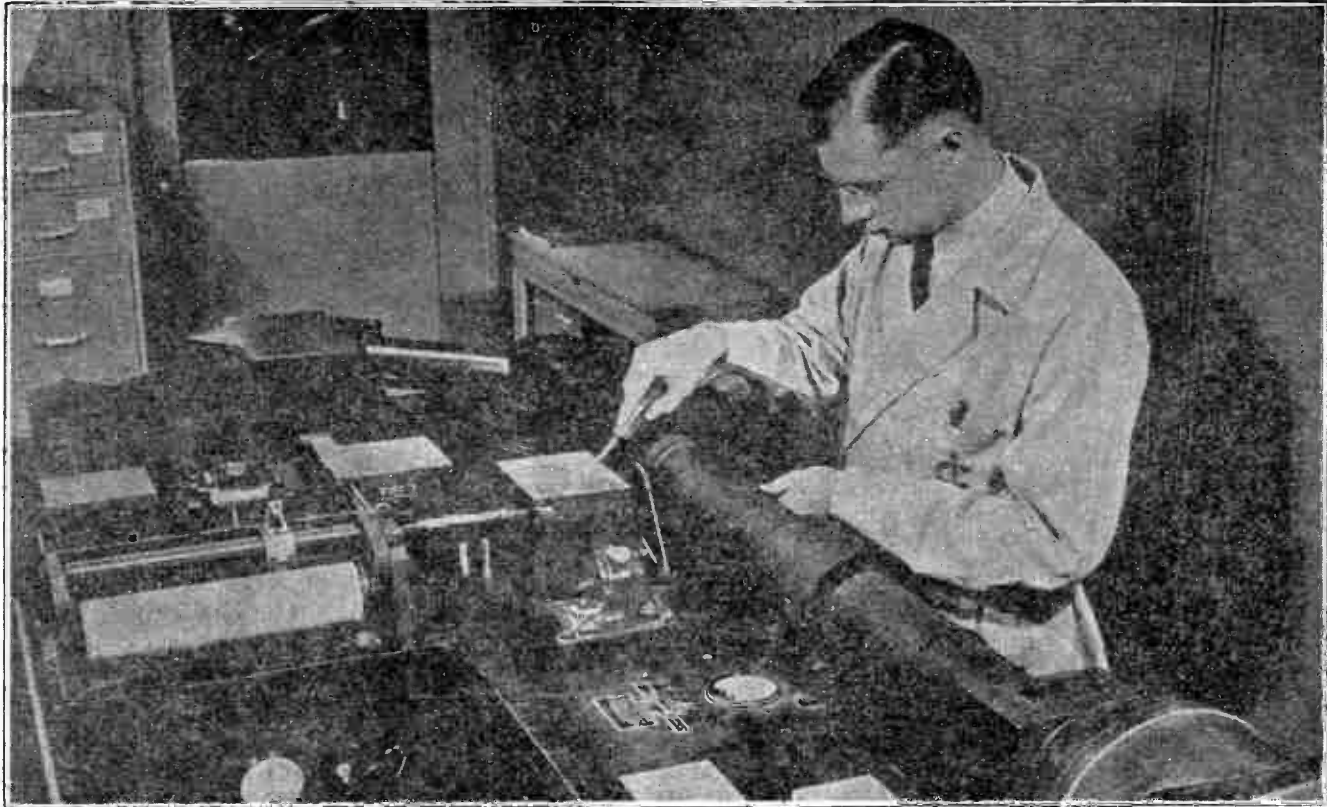

Fig. 86. Electron flow rates and potential differences finally are determined for all the resistances of the voltage divider and loads.

tion to the resistances, so we have a 6-volt drop across A-D and an 84-volt drop across B. The electron flow of 30-milliamperes goes through both the series resistances.

In diagram 2 of Fig. 86 (corresponding to 1 of Fig. 83) we have separated the parallel resistances A and D. The total electron flow of 30 milliamperes divides inversely as the resistances in ohms, so we have 6 milliamperes in the 1000 ohms of resistance A, and have 24 milliamperes in the 250 ohms of resistance D. Note that the ratio of the resistances A and D is $1000/250$ or $4/1$, and that the ratio of the electron flows is $6/24$ or $1/4$. We simply invert the ratio of resistances to find the ratio of electron flows. The potential difference is, of course, the same across these two resistances which are in parallel.

Now we have determined the electron flows in milliamperes and the potential differences in volts for both loads and for every section of the voltage divider. Whenever you work with circuits containing resistances both in series and in parallel it is necessary first to change the parallel resistances into equivalent resistances, then to consider the equivalent resistances as being in series with other parts of the circuit.



A RECORDING SPECTROPHOTOMETER, a high precision electronic instrument widely used in the paper, textile, chemical and paint industries for analyzing quality and color of product. Radio men and electricians with a knowledge of electronics are needed to install, maintain and operate this as well as other types of electronic equipment.

Chapter 6

GAS-FILLED AND VAPOR-FILLED TUBES

Ionization In a Gas or Vapor — Potential Drop In the Tube — Effects of Pressure In Vapor or Gas — Preheating the Electron Emitter — Electron Flow Ratings.

The high-vacuum rectifier tubes which we have been studying are capable of working in circuits that deliver great potential differences to the loads, but the peak rates of electron flow through these tubes ordinarily are less than one ampere. To obtain greater

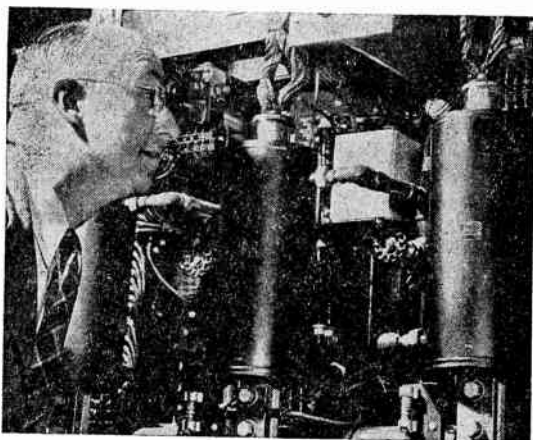

Fig. 87. An engineer examines a pair of sealed ignitrons installed in a portable mercury-arc rectifier unit for producing direct electron flow from an alternating potential.

rates of electron flow would require so much power just to force electrons through the tube as to make such operation inefficient or uneconomical.

The power required to send an electron flow through a tube depends on the rate of flow in amperes and on the potential difference applied between plate and filament to cause electron flow. Most high-vacuum rectifiers require potential differences of 200 to 300 volts for every one-tenth ampere of electron flow. This potential

drop for the tube must be supplied by the plate transformer, yet it never reaches the load and so represents a loss. At rates of electron flow between 30 milliamperes and one-quarter ampere, which are common for kenotron rectifiers, the loss of voltage and power is not serious, but would be a great disadvantage with high rates of electron flow.

The disadvantage of a high potential drop and high energy loss in the tube itself is overcome by admitting to the bulb, after it has been evacuated, a small amount of some gas such as argon, helium, neon or xenon, or else by placing a drop or two of liquid mercury in the tube so that evaporation will produce mercury vapor while the tube is operating.

Symbols for tubes containing either a gas or mercury vapor have a dot within the circle, as in Fig. 88, to distinguish these tubes from high-vacuum types.

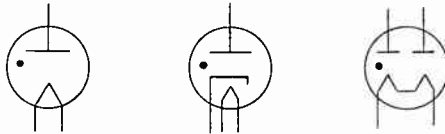

Fig. 88. Symbols for gas-filled and vapor-filled tubes have a small dot to distinguish them from symbols for high vacuum tubes.

IONIZATION IN A GAS OR VAPOR—In a tube containing a gas or the vapor of mercury there are billions of molecules or atoms of the gas or vapor. The atoms are neutral, each containing balanced quantities of positive and negative electricity in the form of a positive nucleus and negative electrons. Negative electrons traveling at high velocity from the cathode or filament to the positive plate of the tube collide with the neutral atoms. One such collision is about to take place at A in Fig. 89. Countless similar collisions are occurring.

The high-velocity negative electron strikes the neutral atom with sufficient force to knock one or more negative electrons off the atom. At B in Fig. 89 one electron has been knocked off the atom. Then there are two negative electrons traveling toward the positive plate. The atom which has lost some of its negative electricity now is positive because it contains more positive electricity than negative electricity. This positive atom is called a **positive ion** or just an **ion**. The production of ions in a gas or vapor is called **ionization**.

The positive ion is attracted toward the mass of negative electrons which form the negative space charge in the tube, and moves toward the negative filament or cathode as at C in Fig. 89. The positive ion re-combines with enough negative electrons to again make the ion a neutral atom as at D. Thus the quantity of negative electrons near the filament or cathode is reduced, which means that a great part of the negative space charge disappears. Since

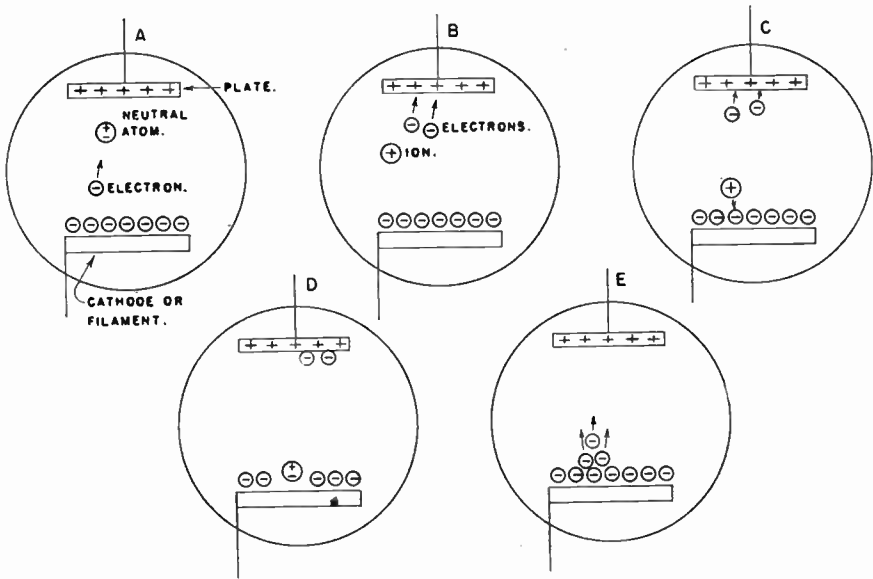

Fig. 89. How ionization takes place in a gas or vapor, and how the positive ions neutralize most of the negative space charge to permit free flow of electrons from the emitter to the plate.

it is the negative space charge that retards emission of electrons from the cathode or filament, reduction of the space charge permits a greatly increased rate of emission, as at E.

The increased rate of emission means that there are many additional electrons traveling toward the plate, colliding with neutral atoms to knock still more electrons from those atoms. With the retarding effect of the space charge all but completely removed, the rate of electron flow through the tube depends only on the transformer potential and the load resistance, and on the maximum emission that the filament can deliver, this maximum emission depending in turn on the filament material and the filament temperature.

POTENTIAL DROP IN THE TUBE—In a high-vacuum tube the number of negative electrons in the space between filament and plate increases with the rate of electron flow through the tube. Consequently, with higher rates of flow, there is more negative space charge to be overcome and it is necessary to provide a plate-to-filament potential difference that increases at almost the same rate as the electron flow. For example, in one kenotron the electron flow may be doubled by increasing the plate potential about 70 per cent, and may be doubled again by increasing the potential another 65 per cent.

The practical absence of negative space charge in a gas-filled or vapor-filled tube not only reduces the required plate-to-filament potential difference to very low values, but makes this potential difference almost constant regardless of the rate of electron flow through the tube.

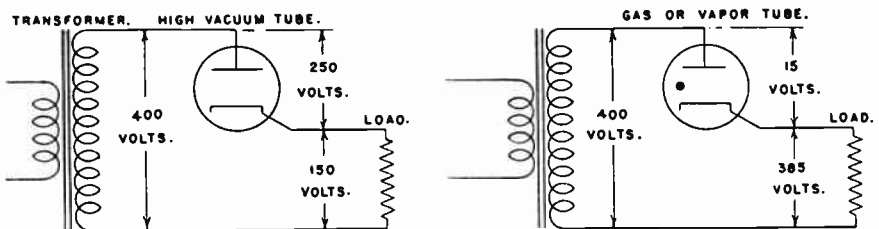

Fig. 90. The potential drop across a load connected to a high-vacuum tube is much reduced by the high potential drop in the tube, but with gas- and vapor-filled tubes most of the transformer potential difference reaches the load.

Through gas-filled tubes we commonly have potential drops of 15 to 25 volts, and in mercury-vapor tubes have drops of 5 to 20 volts, and these small drops of potential through the tube remain almost constant at all electron flow rates within the capacity of the tube.

The capacity of a tube is limited largely by heating and possible overheating of the tube, and heat production in the tube depends largely on the rate of electron flow and the potential drop through the tube. The low potential drops in gas- and vapor-filled tubes permit smaller sizes for carrying the same electron flow as in larger sizes of high-vacuum tubes.

If a high-vacuum rectifier and its load resistance are connected to a transformer secondary winding delivering a potential difference of 400 volts, as in one of the diagrams in Fig. 90, the potential drop through the tube may be something like 250 volts, leaving a poten-

tial difference of 150 volts across the load. If the same transformer voltage is applied to a gas- or vapor-filled tube and a load there will be a drop of only about 15 volts in the tube, leaving 385 volts for the load.

A high-vacuum tube may safely be connected across a circuit having no resistance or no opposition to electron flow, because the space charge in such a tube will use up so much of the applied potential difference as to limit the rate of electron flow to a value within the capacity of the tube. But if a gas- or vapor-filled tube is thus connected, there will be no appreciable space charge effect, and the electron flow will be so great as to permanently damage the tube, the transformer, or both. A potential difference must not be applied to a gas- or vapor-filled tube unless there is enough resistance in the circuit to limit the rate of electron flow to values within the ability of the tube and transformer to handle. The tube itself will not limit the electron flow to safe values.

To cause the initial ionization in a tube, and to thus reduce the space charge effect to a point that allows a normal electron flow, requires a plate-to-filament potential difference somewhat greater than is necessary after ionization is established. This higher breakdown voltage or pick-up voltage, as it is called, may be from 25 to 50 volts for gas-filled tubes and from 12 to 15 volts for mercury-vapor tubes.

EFFECTS OF PRESSURE IN VAPOR OR GAS—Ordinarily, when we speak of pressures of gases such as air, we think of pressures greater than that of the air or atmosphere around us. The pressure of atmospheric air usually is between 14 and 15 pounds per square inch. When we say that an automobile tire is pumped up to a pressure of 30 pounds we mean that it is pumped to a pressure 30 pounds greater than that of the surrounding atmosphere. However, in most technical fields, pressures are measured with reference to a complete absence of all pressure. The pressure of atmospheric air is 14 to 15 pounds per square inch greater than zero pressure. Pressures measured with reference to the absolute zero of pressure are called absolute pressures.

The absolute pressure of the gas with which a gas-filled tube is "filled" usually is somewhere between 200 millionths and 1,000 millionths of one pound per square inch, and the absolute pressure of mercury vapor in a mercury-vapor tube will vary from about 20 millionths to maybe 500 millionths of one pound per square inch while the tube is in operation.

The gas pressure or vapor pressure always must be low enough so that there can be no backward flow of electrons from plate to filament or cathode while the plate is negative and the filament positive, yet must be high enough to provide plenty of neutral molecules or atoms for ionization to take place. The greater the pressure the more atoms or molecules are present, and the more atoms or molecules that are present the greater is the pressure inside the tube.

The difference between a gas and a vapor is this: A vapor may be produced by evaporation from a liquid. Mercury vapor in a tube is produced by evaporation of some of the liquid mercury placed in the tube. Water vapor in the air about us is produced by evaporation of liquid water. When the temperature of a liquid is raised, some of the liquid evaporates into vapor, and when the temperature of the vapor is lowered some of the vapor condenses back into liquid. A gas, such as air and the gases used in tubes, cannot be condensed into a liquid at any temperatures ordinarily reached, and will not condense even at very low temperatures unless it is greatly compressed at the same time.

Since gases are practically unaffected by temperature, some gas-filled tubes may be successfully operated at any temperatures throughout a great range. Most gas-filled tubes may be operated when the temperature of the surrounding air is anything from a few degrees below zero to about 180 degrees above zero, Fahrenheit.

As the temperature of a mercury-vapor tube is raised, more of the liquid mercury evaporates into vapor, and with more vapor the pressure becomes greater inside the tube. As the tube is cooled some of the vapor condenses, and the pressure inside the tube becomes lower. Between 70 and 180 degrees Fahrenheit the "vapor pressure" of mercury increases from about 20 millionths to about 1,800 millionths of one pound per square inch. To maintain satisfactory operating pressures, mercury-vapor tubes are maintained at temperatures from about 20 to 55 degrees centigrade, which is from 68 to 130 degrees Fahrenheit.

It is much easier to force an electron flow through a gas or vapor than through a high vacuum from a cold plate that is negative to a hot filament. Consequently, the maximum peak inverse plate potentials of gas- and vapor-filled rectifier tubes are much lower than for high-vacuum rectifiers. The peak inverse potentials in large phanotrons or gas-filled rectifier tubes seldom exceed 20,000 volts, and in many of the small types used for industrial work may be less than 1,000 volts.

PREHEATING THE FILAMENT OR CATHODE—When operating any gas- or vapor-filled tube of large size or capacity the filament or cathode should be heated to its normal operating temperature before a potential difference is applied between plate and filament or cathode. Until this preheating produces a cloud of negative electrons around the filament or cathode, the first positive ions produced will go directly to the filament or cathode surface, “bombarding” it with such force as to damage the emitting surface. Particles of emissive material actually may be knocked off the emitting surface.

When a mercury-vapor tube is first installed, or when it has been moved or handled for any reason, particles of liquid mercury are lodged on the anode and on the tube walls. With these tubes the preheating must continue until all these particles of mercury evaporate and until the excess of liquid mercury condenses in the lower part of the tube. Unevaporated mercury particles frequently cause “arc-back”, a large electron flow in the reverse direction through the tube.

Published ratings give preheating times for the various tubes during normal operation. For gas tubes this time may be something like 30 seconds, and for mercury tubes may be two or three minutes. When a mercury tube is first installed, or after it has been handled, the initial preheating should be for 15 to 45 minutes, and ordinarily is at least 30 minutes. In some of the small gas and mercury-vapor rectifiers used in radio work and for charging small batteries no preheating is required, the cathodes or filaments in such tubes being capable of withstanding the moderate amount of ion bombardment that occurs.

ELECTRON FLOW RATINGS—In published ratings for gas-filled and mercury-vapor rectifiers you will find values for maximum average amperes and for maximum peak amperes. The maximum average amperes refer to the highest average direct electron flow through the tube that will not cause overheating or other damage. This is the rate of flow that would be measured with an ordinary “direct-current” ammeter when there is a steady flow of electrons through the load.

The maximum peak amperes refer to the greatest instantaneous electron flow that should be permitted at the peaks of pulses of flow through the tube. The peak rate of flow usually is from three times to six times the average rate. The peak rates of flow will be greater, with reference to the average rate, when using a capacitor-input filter than when using a choke-input or inductor-

input filter, which is one of the reasons the inductor-input filter sometimes is preferred for rectifying circuits.

Phanotrons generally used in low-voltage industrial electronic apparatus are rated to deliver all the way from one-half ampere to 30 amperes of average electron flow, and to stand peak flows of from three to 150 amperes. In half-wave types having a single plate these are the ratings for the tube, while in full-wave types having two plates they are the ratings for each plate, with the tube rating double that for each plate. Most phanotrons are of the filament type, although some of them have separate cathodes and heaters.

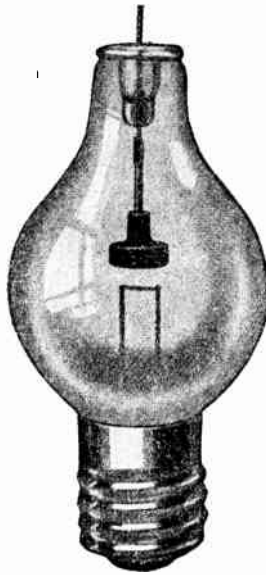

Fig. 91. A Rectigon gas-filled rectifier tube.

Gas-filled rectifier tubes of the general style illustrated in Fig. 91 are designed for such uses as battery charging in automobile service stations. These tubes contain gas at relatively high pressure, which lowers the maximum permissible peak inverse potential to between 275 and 300 volts, but which permits starting the rectification without preheating the filament, which is made from pure tungsten. Average electron flow rates are from two to 15 amperes, and maximum peak flow rates are from six to nearly 50 amperes.

Chapter 7

THYRATRONS

Thyratron Construction — Grid Action In a Thyratron — Stopping the Electron Flow — Control Characteristics — Negative and Positive Grid Control — Temperature Effects — Using a Thyratron — A Rectified Power Supply — Alternating Potential for the Plate — Potentials During a Quarter-cycle — Alternating Potential for the Grid — Effect of Thyratron Controls.

No electronic tube has a wider range of usefulness than the thyratron. This tube is used for regulation and control of electric welding, of lights in theatres and for outdoor displays, of temperatures in any industrial process, of the speed of motors and the potential difference of generators, and it often is used to control the operation of the still larger tubes called ignitrons. Thyratrons control the timing of successive steps in all manner of production work, such as the molding of plastics, and they will count the number of pieces produced or will count events of practically any kind. Thyratrons help to accurately measure dimensions and the smallest variations of dimensions in manufactured parts, they help test the effectiveness of electrical insulation, they will protect electrical machinery against excessive potentials and rates of electron flow, and will do other things that literally are too numerous to mention.

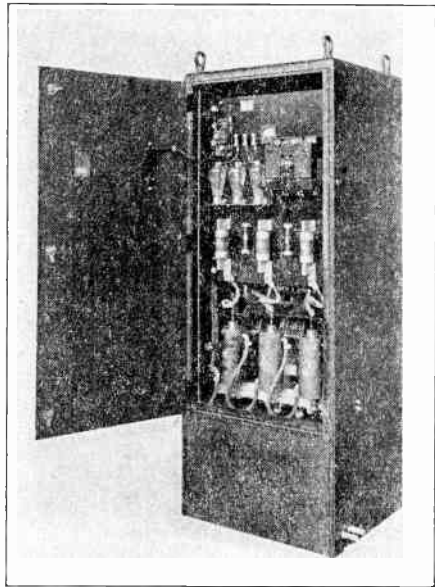

Fig. 92. This is an ignitron welding rectifier. Three large ignitron rectifiers may be seen in the lower part of the cabinet. At the left-hand side of the cabinet, near the top, are three thyratron tubes.

Thyratrons are filled either with mercury vapor, with some gas, or with a mixture of gas and vapor. The electron emitter may be either a filament or else a cathode with separate heater.

So far the thyatron is like the phanotron, but, instead of only the electron emitter and the plate of the phanotron, we have in the thyatron a third electrode called the grid. The grid always permits us to control the exact instant at which electrons commence to flow through the thyatron, and in circuits most commonly used, the grid permits not only exact timing of the electron flow but control of the rate of electron flow through the thyatron and its connected circuit.

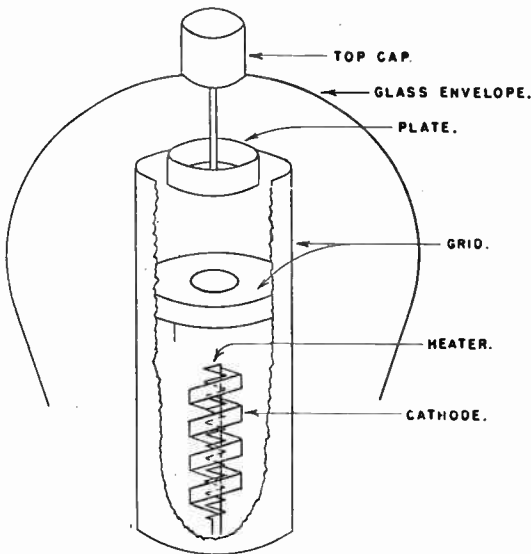

Fig. 93. The relative positions of the plate, grid, cathode and heater in one style of thyatron.

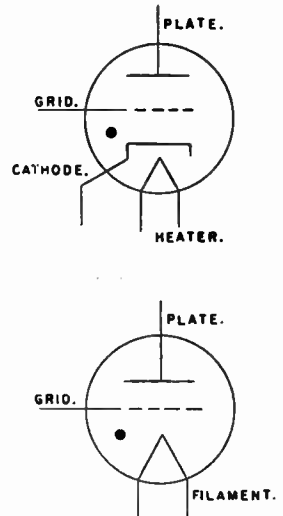

Fig. 94. Symbols which indicate thyatron rectifiers.

The grid always is located, with reference to the emitter and the plate, so that electron flow from the emitter to the plate must pass to and through the grid. There are various constructions for accomplishing this object. One method is shown by Fig. 93, where the grid consists of a cylinder that almost completely encloses the cathode and plate, with a perforated disc within the cylinder and between the cathode and plate. The cathode in this case is in the form of an open spiral placed around the heater. The plate is cup-shaped, and is connected to the top cap on the glass envelope of the tube.

Symbols for thyatrons are shown in Fig. 94 for the type of tube having a separate cathode and heater, also for type in which

a filament forms the heated electron emitter. Note that in these thyatron symbols we find the small dot indicating that the tubes contain either a gas, a vapor, or both.

GRID ACTION IN A THYRATRON—The diagrams of Fig. 95 show how and when the grid controls flow of electrons through the thyatron tube. In diagram A the plate is highly positive with reference to the cathode, while the grid is much more negative than the cathode. Just now the exact manner of making the plate positive and the grid negative, with reference to the cathode, is not important; it might be done with a voltage divider or in various other ways—even by using batteries.

Heating of the cathode causes quantities of negative electrons to be emitted from its surface. The positive plate tends to exert attraction for these negative electrons, but the strongly negative grid repels the negative electrons. The electrons are affected by the negative grid more than by the positive plate, because the grid is between plate and cathode. Furthermore, the grid being much closer to the electron emitter than the plate is, it exerts a greater control effect for a given potential on it. Electrons are thus prevented from flowing from the cathode to the plate, and there is no electron flow through the thyatron or the circuit to which it is connected.

In diagram B the grid has been made less negative with reference to the cathode, while the anode still is strongly positive with reference to the cathode. Making the grid less negative permits the attractive force of the positive plate to partially overcome the repelling force of the negative grid on the negative electrons around the cathode. Then some negative electrons travel toward the positive plate, going through the openings or perforations of the grid. The space within the tube is filled with molecules or atoms of gas or vapor. The flying negative electrons strike these particles of gas or vapor, and many of the collisions result in knocking a negative electron out of an atom or molecule. This is the action that produces ionization, just as in the gas- or vapor-filled phanotron.

Atoms or molecules which have lost one or more of their negative electrons then are positive, or are positive ions shown in diagram C of Fig. 95. The positive ions are attracted to the cloud of negative electrons around the cathode surface, and they neutralize the negative space charge just as positive ions in the phanotron neutralized the negative space charge in that type of tube. With practically all negative space charge neutralized, there is a tremen-

dous increase of electron flow from the cathode and an equally great increase in rate of electron flow to the positive plate.

But the positive ions are attracted not only to the negative space charge around the cathode, but also to the negative grid. Consequently, as in diagram D, the positive ions form a sort of positive sheath around the negative grid. This sheath of positive ions around the grid prevents the negative potential of the grid from having any appreciable effect in repelling negative electrons. The

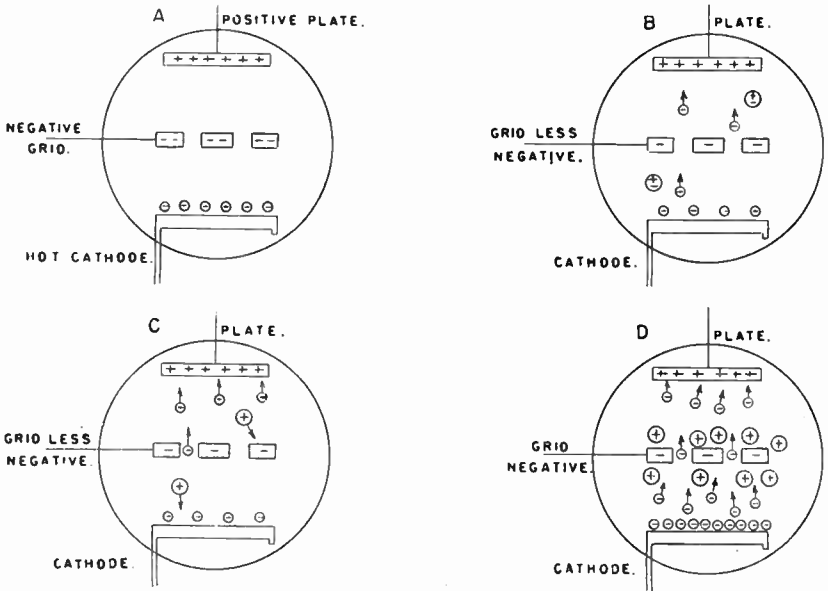

Fig. 95. A. With the grid negative there is no electron flow from cathode to plate. B. With the grid less negative, electrons flow through the tube space and collide with neutral molecules of gas. C. Ionization releases additional electrons which go to the plate. D. Positive ions form a sheath around the grid.

more negative the grid is made with reference to the cathode, the more positive ions collect around the grid. No matter how negative the grid is made, within any practical limits, it no longer has any effect on the rate of electron flow through the thyatron so long as the plate remains positive with reference to the cathode.

With the grid quite strongly negative with reference to the cathode, and with the plate positive, the negative grid is capable of preventing the initial electron flow that starts ionization and allows the greater flow through the thyatron. As the grid is made less and less negative with reference to the cathode, a potential

finally is reached at which ionization commences. Then, within the one hundred-thousandth part of a second, ionization permits the full rate of electron flow. Once the normal electron flow has begun, the grid completely loses control over the rate of electron flow. No matter how the grid-to-cathode potential difference is changed, again within practical limits, the grid can neither increase the electron flow, decrease the flow, nor stop the flow.

The grid-to-cathode potential difference at which electron flow commences may be called the critical potential, the break-down potential, or the pick-up potential. We shall use the term **critical potential**. So long as the actual grid potential is less than the critical potential there will be no electron flow through the thyatron. The instant the grid reaches the critical potential the full rate of electron flow occurs almost instantaneously.

STOPPING THE ELECTRON FLOW—The only way to stop electron flow through the thyatron, once this flow commences, is to stop ionization within the tube. The only way to stop the ionization is to so far reduce the difference of potential between plate and cathode that electrons no longer collide with atoms or molecules with enough force to knock out additional electrons and leave positive ions. The plate-to-cathode potential difference at which ionization stops is only a few volts, so in practice we consider that this potential difference must be reduced to zero in order to stop flow of electrons through the thyatron.

Of course, it is true also that making the plate negative with reference to the cathode will stop electron flow and ionization, and will allow the grid to regain control.

Just as soon as the plate potential has been reduced to zero, or nearly to zero, and kept there long enough for ionization to cease, we are right back to the condition of diagram A in Fig. 95. Then the grid once more may control the instant at which the next normal electron flow commences. Reducing the plate potential to zero allows the grid to regain its control ability.

CONTROL CHARACTERISTICS—The grid-to-cathode potential difference which will just permit electron flow to begin depends largely on the plate-to-cathode potential difference. That is, the critical voltage of the grid depends on the plate voltage. The relations between plate voltage and critical grid voltages which permit electron flow to commence in a typical thyatron tube are shown by the curve of Fig. 96. Such a curve illustrates what is called the **control characteristic** for the tube.

In Fig. 96 the grid voltages begin at zero on the right, and become increasingly negative with respect to the cathode as we go toward the left. Positive plate voltages, with reference to the cathode, begin at zero on the bottom and become progressively more positive toward the top of the graph.

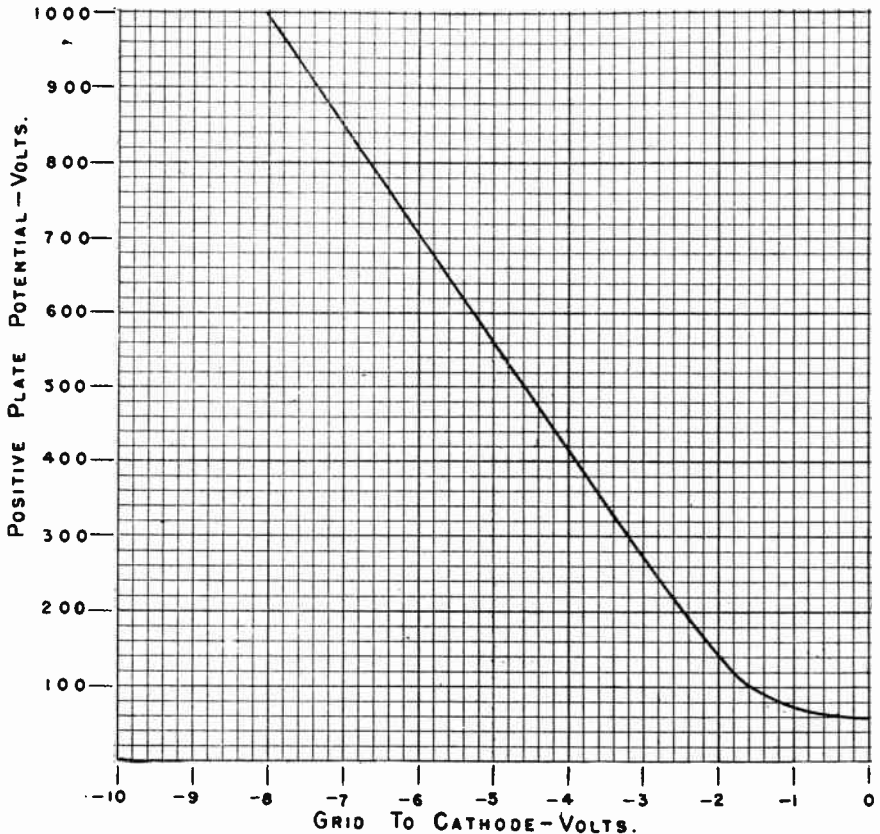

Fig. 96. The control characteristic for a thyratron.

As an example in using a characteristic curve, assume that the plate of the tube represented by Fig. 96 is 560 volts positive. Tracing from 560 volts on the left-hand vertical scale across to the curve, and from the intersection downward to the grid voltage scale, shows that the corresponding grid voltage (the critical voltage) is 5 volts negative. This means that so long as the grid is more than 5 volts negative, electron flow will not commence when the plate potential is 560 volts, but when the grid is 5 volts negative, or has

any other less negative voltage, electron flow will start and continue in the tube. All grid potentials to the left of the curve mean no electron flow, and all that lie on the curve or to the right mean an electron flow.

Now assume that we knew only the grid was to be 5 volts negative. Tracing up the curve and to the left shows that the corresponding plate potential is 560 volts positive. With the grid 5 volts negative, any plate potential below 560 volts will not cause electron flow, but a plate potential of 560 volts, or any higher voltage, will cause electron flow to start. All combinations of grid and plate potentials to the left of the curve and below it mean no electron flow, and all combinations on the curve, or above it and to the right, mean that electron flow will commence and continue.

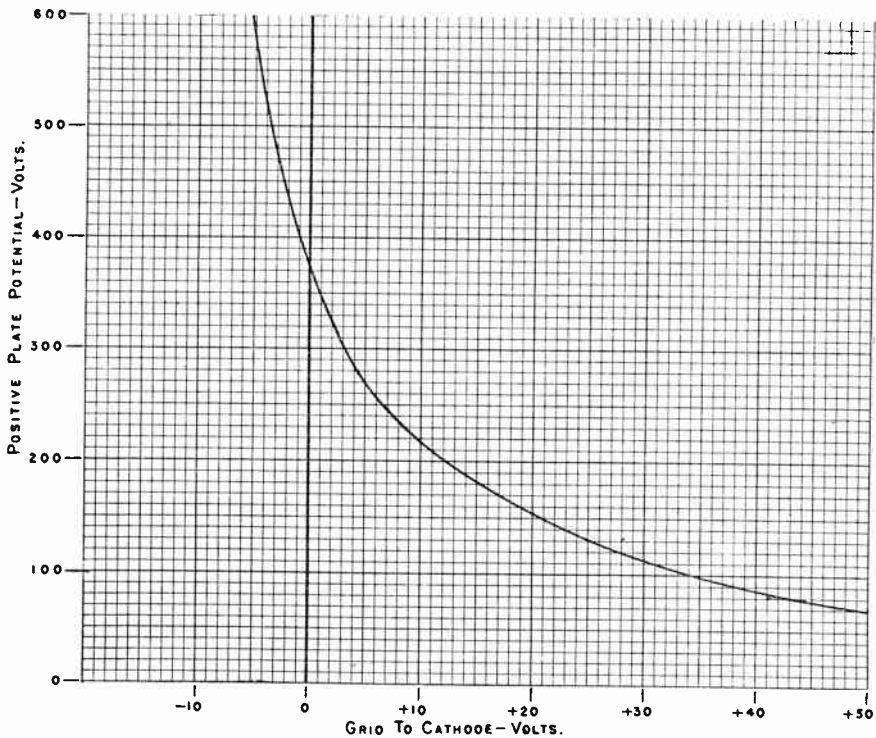

Fig. 97. A control characteristic with which most of the useful control range is obtained with the grid positive with reference to the cathode.

NEGATIVE AND POSITIVE GRID CONTROL—For all of the plate potentials that normally would be used with the thyatron represented by Fig. 97, all the grid voltages that permit control

of starting the electron flow are negative voltages. All the useful grid voltages are negative with reference to the cathode. Not all thyratrons are designed to operate with negative grid control, some are designed to permit control with the grid positive with reference to the cathode, while still others are designed to operate sometimes with the grid negative and again with its positive. Fig. 97 shows a control characteristic with which most of the useful control range is secured while the grid is positive with reference to the cathode. Whether the tube is a negative or positive control type depends principally upon the design of the grid.

TEMPERATURE EFFECTS—Mercury-vapor thyratrons are affected by changes of temperature just as are mercury-vapor phanotrons, while gas-filled thyratrons are practically unaffected by any ordinary changes of temperature, as are also gas-filled phanotrons.

In any mercury-vapor tube an increase of temperature within the normal operating range causes evaporation of more mercury, which means more mercury atoms or molecules in the tube, and a greater degree of ionization. The increased ionization means a greater rate of electron flow, so we may say that higher operating temperatures result in greater electron flows.

The effect of temperature is graphically shown by the curves in Fig. 98, which are average control characteristics for a Westinghouse WL-631 mercury-vapor thyatron. Curves are shown for "condensed mercury temperatures" of 30, 40, 60 and 80 degrees centigrade, which correspond respectively to Fahrenheit temperatures of 86, 104, 140 and 176 degrees.

Condensed mercury temperature refers to the temperature of the coolest part of the bulb of the tube, for it is at the temperature of this coolest part that mercury vapor condenses from vapor to liquid. The more vapor that condenses, the less vapor remains in the tube space and the lower becomes the pressure in that space. Since pressure cannot well vary from point to point in a space so small as that within the tube, the pressure within the entire space depends on that maintained by condensation of vapor to liquid. Therefore, the pressure and the amount (density) of vapor within the tube depends directly on the temperature of the coolest part of the bulb. When we see curves for different temperatures we really are seeing curves for different pressures and densities of vapor.

On the graph of Fig. 98 there are two scales for plate potentials. The left-hand scale is marked "Ep-D. C. or Instantaneous

Anode Volts." In the symbol E_p , the letter E stands for potential in volts, and the letter p stands for plate. The letters $D. C.$ are an abbreviation for "direct current," which we speak of as direct electron flow. Instantaneous volts means the potential difference in volts applied at any instant. If the potential is steady, as with a direct potential, the potential is the same at all instants, but if the potential is alternating its value changes from one instant to another.

The right-hand vertical scale of Fig. 98 is marked " E_p -R.M.S. Anode Volts." The abbreviation E_p again stands for plate potential in volts. The abbreviation R.M.S. stands for root-mean-square. A root-mean-square potential is an effective alternating potential. As we have learned before, an instantaneous potential in a sine-wave, if it is a peak potential, is equal to 1.414 times or to approximately 1.4 times the effective potential. You will find that the potentials on the left-hand scale are 1.4 times as great as those on the right-hand scale.

Checking the plate potentials for a grid potential of 6 volts negative in Fig. 98, we find that with a temperature of 30° C. the D. C. anode (plate) voltage is 910, with a temperature of 40° C. it is about 710 volts, with 60° C. it is about 595 volts, and with 80° it is only about 540 volts. The higher the operating temperature the lower is the plate potential at which the tube will commence to carry an electron flow with any critical grid potential. The curves of Fig. 98 show also that for any given plate potential a higher operating temperature allows break-down at grid potentials that are increasingly negative. If you compare the 40-degree curve of Fig. 98 with the single curve of Fig. 96 you will find that they show the same critical potentials.

In addition to changes of critical grid voltages for various plate potentials as caused by variations of operating temperature,

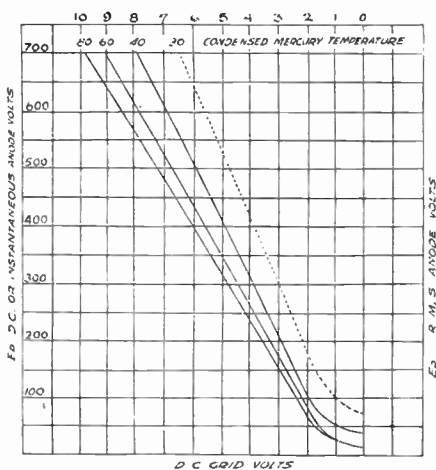

Fig. 98. Average control characteristics at four condensed-mercury temperatures for a type WL-631 mercury-vapor thyatron.

there are some differences between individual tubes of a given type, and the same tube undergoes some changes of characteristics as it is continued in use. Ordinary variations between tubes, and in the same tube as it ages in use, are shown by the curves of Fig. 99.

The typical curve Fig. 99 shows average performance of the tube represented. With mercury-vapor tubes the curves apply to

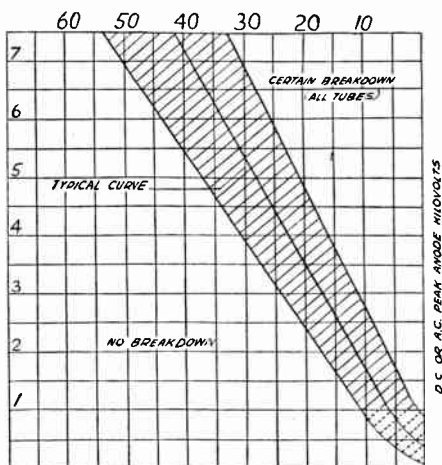

Fig. 99 The range of control characteristics at a condensed-mercury temperature of 45° C. for a type WL-677 mercury-vapor thyatron.

some one operating temperature. In Fig. 99 the operating temperature, or condensed mercury temperature, is shown as being 45° C. The left-hand curve shows combinations of the lowest plate potentials and most negative grid potentials for breakdown. The right-hand curve shows highest plate potentials and least negative grid potentials for breakdown. It is certain that no tube that is in good condition will permit breakdown to occur at combinations of potentials to the left of the curves and below them, and all tubes in good condition certainly will break down at combinations of potentials above and to the left of the curves.

USING A THYRATRON—Fig. 100 shows one method of using a thyatron to control electron flow in a load. Because the flow in the load is to be small and the operating potentials relatively low, we shall employ a 2A4G tube, whose control characteristic is shown by Fig. 101. The highest permissible average rate of direct electron flow in this tube is 1/10 ampere or 100 milliamperes. The maximum potential difference between plate and cathode may not exceed 200 volts, this being the plate voltage before breakdown or before the tube commences to carry an electron flow. After ionization permits a normal electron flow, the potential drop between plate and cathode decreases to 15 volts. When there is **electron** flow through a thyatron the potential drop across the tube is very low, and is practically independent of the rate of electron flow. This is the same condition found with phanotrons.

In diagram A of Fig. 100 we see that the plate circuit, between plate and cathode of the tube, includes the 1500-ohm resistance that represents the load, also a switch, and a battery furnishing a potential difference of 120 volts. The switch is necessary because, once electron flow commences through the tube, the grid loses control and in order to stop the flow we must reduce the plate potential to zero or practically to zero. Opening the switch removes potential from the plate.

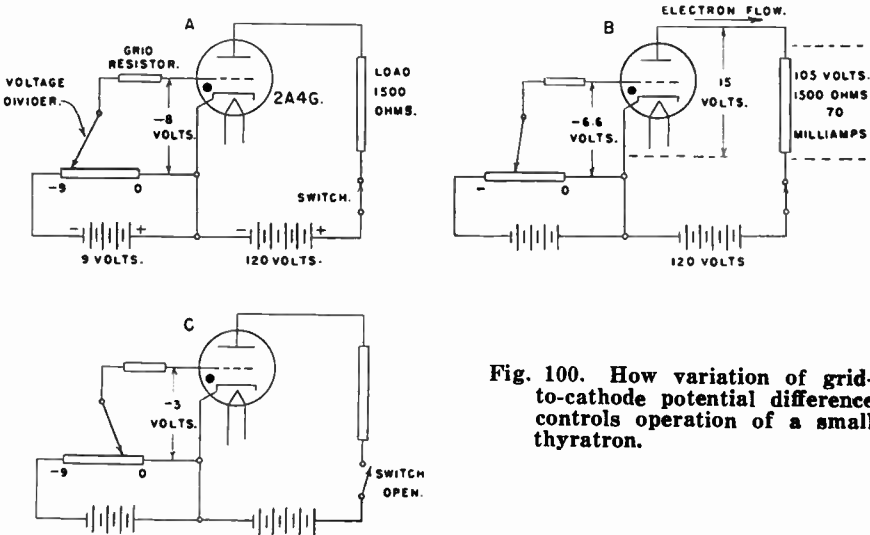

Fig. 100. How variation of grid-to-cathode potential difference controls operation of a small thyatron.

The potential difference between grid and cathode is determined by the position of a contact arranged to slide along the resistor of a voltage divider. The voltage divider resistor is connected across a 9-volt battery, the positive terminal of the battery being connected to the tube cathode. In diagram A the slider is shown at a position that makes the grid 8 volts negative with reference to the cathode. With the switch closed in the anode circuit, the potential difference of the 120-volt battery is applied between the plate and cathode, with the plate positive with reference to the cathode.

Referring to the characteristic curve of Fig. 101, we find that the tube cannot break down and carry an electron flow because, with the grid 8 volts negative, it would take a plate potential of about 170 volts to cause breakdown, and the plate potential actually is only 120 volts.

In diagram B of Fig. 100 the slider of the voltage divider has been moved from the negative end of the resistor toward the

end connected directly to the cathode, at which there would be no potential difference or zero difference between the grid and cathode. This new position of the slider makes the grid 6.6 volts negative with reference to the cathode. Referring to the curve of Fig. 101 we find that the critical grid potential is 6.6 volts negative for a plate potential of 120 volts, so now the tube breaks down and commences to carry electron flow.

Just as soon as electron flow commences, the potential drop across the tube decreases from the 120 volts that started the flow to the 15 volts with which the flow continues. With a total potential difference of 120 volts from the battery, and with 15 volts used up across the tube, we have 105 volts remaining across the load.

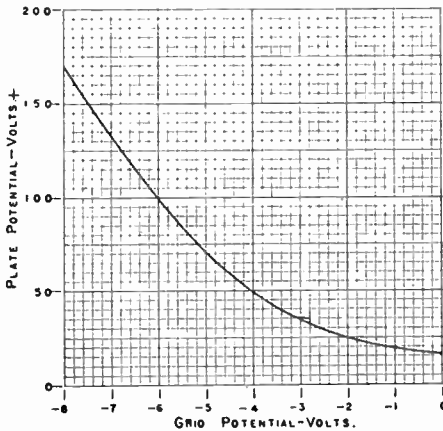

Fig. 101. The control characteristic for a type 2A4G thyatron. This is a gas-filled type containing argon.

Using Ohm's law for electron flow, $I = E/R$, we divide 105 volts by 1500 ohms to find that the rate of flow will be 0.070 ampere, which is 70/1000 ampere or 70 milliamperes.

Even though the tube drop were zero we still would have 120 volts from the battery across the 1500-ohm load, and $I = E/R$ works out to 0.080 ampere or 80 milliamperes. Were the tube drop doubled, making it 30 volts, we would have the remaining 90 volts from the 120-volt battery across the 1500-ohm load.

Then $I = E/R$ shows that the electron flow would be 60 milliamperes. Decreasing the tube drop to zero, or else doubling the drop, makes a total change in electron flow only from 80 to 60 milliamperes. Were the total circuit voltage greater than 120 volts, as it would be with any of the larger thyatrons, the potential drop through the tube would have even less effect on the electron flow, because it would represent a lower percentage of the total voltage applied.

Supposing the load resistance in Fig. 100 were reduced to 500 ohms. Still we would have only 15 volts drop in the tube and would have 105 volts across the load. Then $I = E/R$ shows that the electron flow would be 0.210 ampere or 210 milliamperes. The

maximum average plate current for the 2A4G tube is only 100 milliamperes, so the tube would quickly be ruined by the excessive electron flow allowed by the 500-ohm resistance.

The resistance of the load circuit connected to a thyatron must not be less than the amount which will limit the electron flow to the maximum average rating of the tube. To determine this maximum load resistance we first subtract the tube drop in volts from the total or maximum potential difference of the energy source in the plate circuit, thus finding the potential difference remaining for the load resistance. Then we use Ohm's law for resistance, $R = E/I$. The value of E is the load potential difference just determined, and the value of I is the maximum average electron flow for the tube.

For the circuit of Fig. 100 we would subtract the tube drop in volts, 15, from the battery voltage, 120, to find that 105 volts will be applied across the load. We know that the tube is rated at 1/10 ampere or 0.1 ampere maximum average electron flow. So the formula becomes,

$$R = \frac{E}{I} \quad \text{or} \quad R = \frac{105}{0.1} = 1050 \text{ ohms}$$

Thus we find that the plate circuit connected to the tube must have a resistance of at least 1050 ohms in order that the electron flow through the tube shall not exceed the rated 0.1 ampere.

Once electron flow commences in a circuit such as that of Fig. 100 it may be stopped only by opening the plate circuit by means of the switch, as in diagram C, or in reducing by some other method the potential difference between plate and cathode practically to zero. With the plate circuit open, there will be no electron flow, regardless of the grid potential. However, if the grid potential is made equal to or less than the critical value for the existing plate potential, as it is in diagram C, electron flow will occur in the plate circuit just as soon as the switch is closed in this circuit.

A RECTIFIED POWER SUPPLY—In actual installations we seldom use batteries as the energy sources, but ordinarily secure the necessary operating power from power and lighting lines that furnish alternating potentials. Fig. 102 shows the thyatron control circuit connected to a rectified power supply consisting of a full-wave rectifier tube T, a filter, and a voltage divider VD.

The rectifier and filter system are no different from some of those previously examined.

The thyatron cathode is connected to point **O** on the voltage divider. All points on the divider from **O**, which is used as the reference potential, to the top, which is the negative end of the whole divider, then are more negative than the cathode point **O**, while all points from **O** down to the lower positive end of the entire divider are more positive than the cathode point **O**. From the voltage divider we thus obtain some potentials that are more negative and others that are more positive than the cathode of the thyatron, and we consider the cathode as having zero potential, since it has been selected as the reference point.

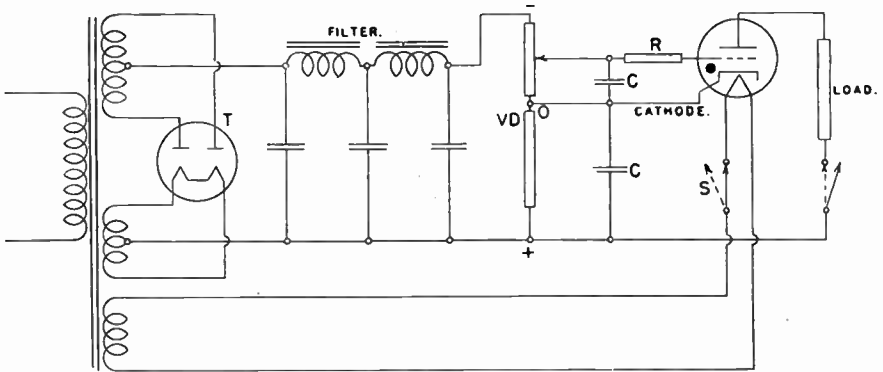

Fig. 102. The control circuit for a thyatron connected to a voltage divider and filter operating from a full-wave rectifier.

The part of the voltage divider above **O** in Fig. 102 takes the place of the battery voltage divider in Fig. 100, and on this section is the sliding contact which is connected through the grid resistor **R** to the grid of the thyatron. The purpose of the grid resistor is to prevent an excessive electron flow between grid and cathode of the tube, as might happen under some conditions with the grid zero or positive with reference to the cathode.

Capacitors **C-C** of Fig. 102, connected between the cathode and the grid, and between cathode and plate, prevent any slight variations of potential that may come through the filter from affecting operation of the thyatron tube. When the thyatron grid potential is close to the critical point, even a slight variation of this potential would cause breakdown or would prevent breakdown, depending on the direction of the variation. The bypass

capacitors, C-C, tend to smooth out any potential variations occurring across the sections of the voltage divider.

In order to prevent injury to the emitter from ion bombardment, the cathode of the 2A4G thyatron must be heated for at least 2 seconds before electron flow is allowed through the anode circuit, so in the circuit of Fig. 102 we have switch S in the heater circuit to permit closing this circuit before the tube is allowed to carry electron flow.

ALTERNATING POTENTIAL FOR THE PLATE—With the circuits of Figs. 100 and 102 it is necessary to open the switch in the plate circuit every time we wish to stop flow of electrons through the thyatron and the plate circuit. Obviously, the operation of such a switch would be a decided disadvantage in many kinds of apparatus where we wish the action to be entirely automatic. While it is entirely possible to open a switch automatically after the expiration of any desired time period, this kind of automatic operation calls for more mechanism and more intricate circuit arrangements.

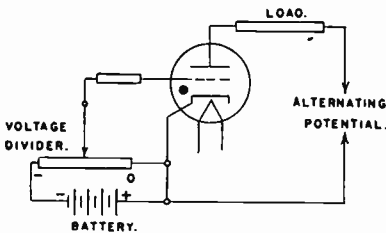

Fig. 103. Alternating potential for the plate circuit of the thyatron, with direct potential for the control grid.

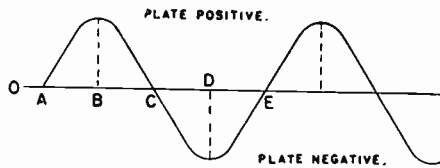

Fig. 104. Variation of the thyatron plate-to-cathode potential difference when alternating potential is used in the plate circuit.

An exceedingly simple method of periodically stopping ionization in the tube, and of allowing the grid to regain control, is to supply an alternating potential rather than a direct potential to the plate circuit, as has been done in Fig. 103.

Now the plate becomes alternately positive and negative with reference to the cathode. An alternating potential is represented by the curve of Fig. 104. During the period of time from A to B, which is one-quarter cycle, the plate potential increases from zero to its maximum positive value. During the next quarter-cycle the plate potential drops back to zero at C, increases to maximum negative value at D, comes back to zero at E, and so continues so long as the alternating potential is applied.

While the plate is positive with reference to the cathode, as during the time from A to C in Fig. 104, the tube will conduct an electron flow provided the grid potential is less negative than the critical potential for whatever plate potential exists. While the plate is negative with reference to the cathode, as during the period from C to E, electron flow will cease because there is no force to draw electrons from cathode to plate inside the tube.

Just as soon as ionization ceases, the grid is again able to control starting of the following period of ionization and electron flow. Therefore, every time the plate becomes negative with respect to the cathode, the grid regains control. The plate becomes negative once during each cycle, so with an alternating potential of 60 cycles per second the grid may regain control 60 times during each second.

POTENTIALS DURING A QUARTER-CYCLE—It is quite important that we understand exactly what may happen during the quarter-cycle from A to B of Fig. 104, and during every other similar quarter-cycle during which plate potential increases from zero to positive maximum. To commence our analysis we may examine the upper half of the graph in Fig. 105, which, as you will see, represents the rise of plate potential during a quarter-cycle like that from A to B of Fig. 104.

In Fig. 105 we are using a peak plate-to-cathode potential difference of 1,000 volts, as shown on the left-hand vertical scale. The quarter-cycle has been divided into nine equal periods of time, numbered 1, 2, 3 and so on along the top of the graph. The curve represents the ideal form of alternating potential called a sine wave. With a sine-wave potential the plate potential will be 174 volts at the end of period 1, will have increased to 342 volts at the end of period 2, to 500 volts at the end of period 3, and will increase to values shown along the top of the graph at the end of each following period.

After reaching the peak potential of 1,000 volts we would have decreases of potential during each period of the following quarter-cycle (B to C in Fig. 104) at the same rate as the increases in the quarter-cycle.

Assume that we are using the thyatron whose control characteristic is shown in Fig. 96. This characteristic curve shows the critical grid potentials at which the tube will break down for all plate potentials up to 1,000 volts. From Fig. 96 we may read the critical grid potentials for the plate potentials existing at the end

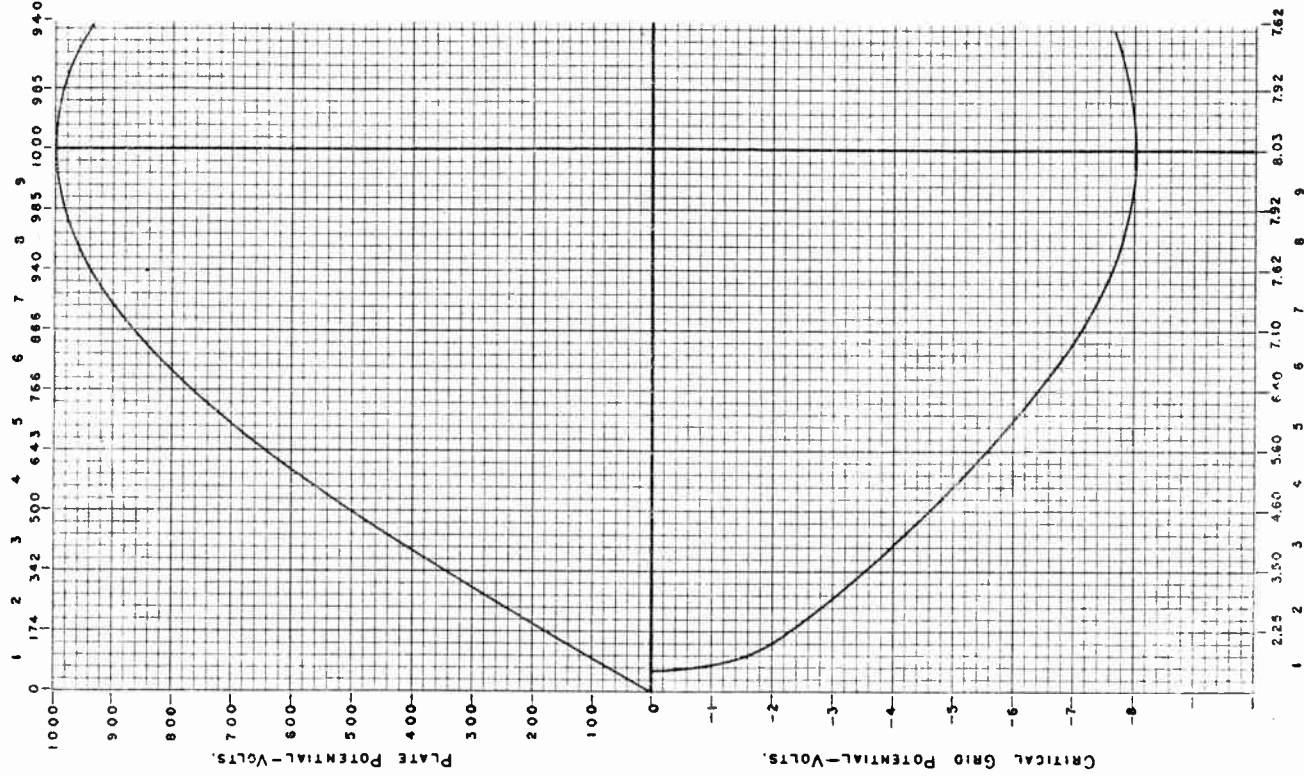

Fig. 105. Relations between critical grid potentials and plate potentials during a quarter-cycle in which the plate-cathode potential difference is increasing from zero to maximum, or peak, positive voltage.

of each of the nine periods of time shown on the graph of Fig. 105. Here are the critical grid potentials:

Plate potential	174 volts	=	-2.25	critical grid potential volts.				
"	"	342	"	=	-3.50	"	"	"
"	"	500	"	=	-4.60	"	"	"
"	"	643	"	=	-5.60	"	"	"
"	"	766	"	=	-6.40	"	"	"
"	"	866	"	=	-7.10	"	"	"
"	"	940	"	=	-7.62	"	"	"
"	"	985	"	=	-7.92	"	"	"
"	"	1000	"	=	-8.03	"	"	"

The curve in the lower part of Fig. 105 shows all these critical grid potentials which correspond to the plate potentials existing at the end of each of the nine periods of time, also all intermediate potentials. From the two curves of Fig. 105 we may read the plate potential existing at any instant during the quarter-cycle, and may read also the critical potential of the grid that would just allow ionization and conduction to begin at any instant during the quarter cycle.

Going back to Fig. 103, assume that the voltage divider is set to provide a negative grid potential of 5.0 volts. From the lower curve of Fig 105 we note that this is the critical grid potential for a plate potential of 560 volts. We might learn the same thing from Fig. 96. But from Fig. 105 we see that breakdown will occur during the fourth period of the quarter-cycle. Now we must remember that once electron flow commences in the thyatron, it will not cease until the plate potential becomes zero. The plate potential will not become zero until the end of the half-cycle. Consequently, conduction will occur during the portion of the cycle shown at A in Fig. 106.

If we make the grid 3.0 volts negative we find from Fig. 105 that conduction will begin during the second period, and, of course, will continue until the plate goes negative at the end of the cycle. With this 3-volt negative grid potential there will be conduction during the portion of each cycle shown at B in Fig. 106. If the grid is made 7.0 volts negative we find that conduction begins during the sixth period in Fig. 105, and the total period of conduction will be shown at C in Fig. 106. If we are able to hold the grid potential at exactly the critical value for the peak plate potential, conduction will not begin until this plate potential is reached at the end of the quarter-cycle. Then, as at D in Fig. 106, conduction will

occur only during the last half of each positive half-cycle of alternating potential on the plate.

It is apparent from Fig. 106 that changes of grid potential will allow electron flow either during a complete positive half-cycle, as with zero grid potential, or during only half of the half-cycle, as at D in Fig. 106, or during any intermediate portion of the positive half-cycle. But we cannot reduce the electron flow to periods less than quarter cycles, as at D, no matter how we vary the grid potential, for increasing the negative grid voltage value would then result in no electron flow at all.

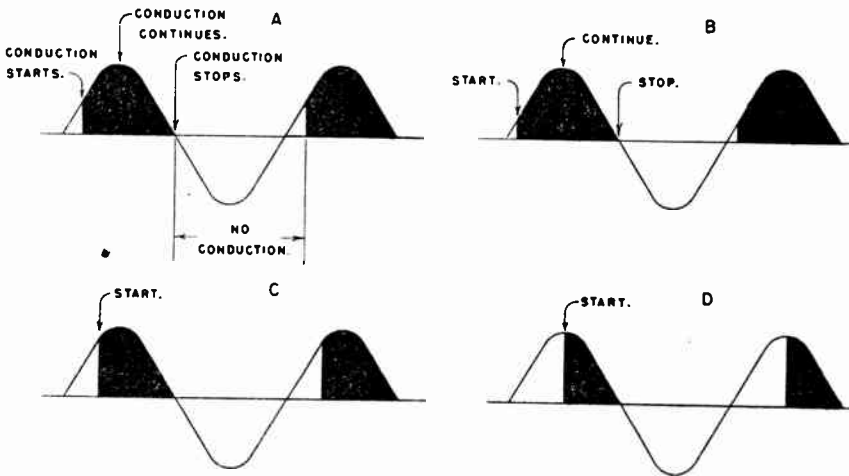

Fig. 106. Portions of positive half-cycles during which conduction or electron flow may take place.

ALTERNATING POTENTIAL FOR THE GRID—In the preceding diagrams showing alternating potential applied to the plate circuit of the thyatron, direct potential from a battery still was used for the grid circuit. It is, however, entirely practical to use alternating potential for the grid as well as for the plate, and to have such variation of grid potential as will vary the instant at which the tube breaks down and conducts electron flow.

If control of the thyatron is to be had with a varying negative grid potential we must have a grid potential that is negative while the plate is positive, for the plate must be positive in order to have conduction.

How a positive plate potential and a negative grid potential may be had at the same time is evident from Fig. 107. At A we have two secondary windings on a transformer, one winding for the

plate circuit and the other for the grid circuit of a tube. While one end of any transformer secondary winding is positive the other end must be negative, and when the first end becomes negative the second will be positive. With the windings connected as shown, the grid will be negative with reference to the cathode while the plate is positive with reference to the cathode.

Were one of the secondary windings wound around the core of the transformer in the opposite direction, the positive and negative ends would be reversed. This is indicated by diagram B in Fig. 107. But here it is necessary only to interchange the connections to the grid and cathode of the tube to make the grid negative while the plate is positive. Obtaining opposite potentials for

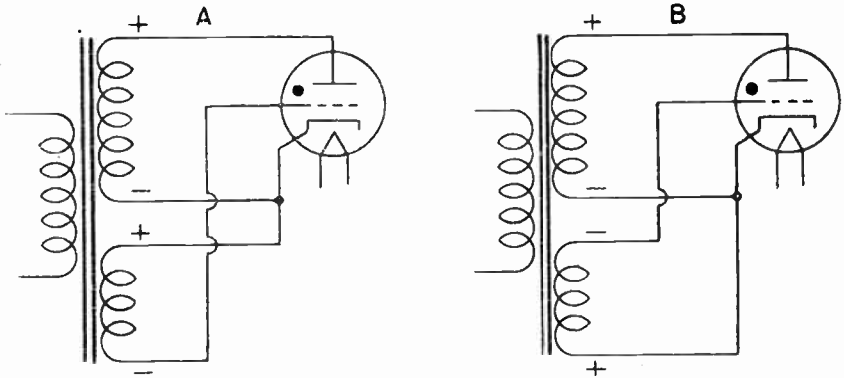

Fig. 107. How a negative grid-to-cathode potential is obtained at the same time as a positive plate-to-cathode potential for the thyatron.

the grid and plate requires only suitable connection of the transformer secondaries to the tube circuits. If one method of connection does not give desired potential relations, reversing the connections to either one of the secondaries will do so.

To control the point at which the tube breaks down during the alternating cycle of plate potential we must be able to vary the grid potential, so that we may obtain the critical grid potential for any plate potential up to the peak plate potential being used. One method of varying the alternating grid potential, while keeping it negative with reference to the cathode of the tube, is shown by Fig. 108.

In Fig. 108 the positive (+) and negative (—) signs on the ends of the transformer secondaries are merely to indicate which potentials occur together, and to show that the plate will be positive while the grid is negative. Across the grid winding of the

transformer is connected a voltage divider, with the slider connected to the grid of the thyatron and with the end of this winding that is instantaneously positive connected to the end of the

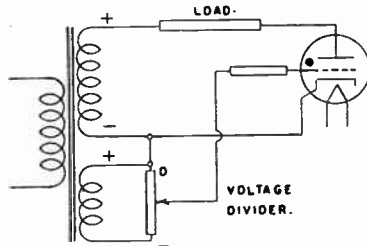

Fig. 108. A method of varying the amplitude of alternating potential for the thyatron grid while keeping the grid negative with reference to the cathode.

plate winding that is at the same instant negative, and connected also to the cathode of the tube.

It is apparent that with the voltage divider slider moved all the way up to the end marked zero (0) the grid of the tube will be

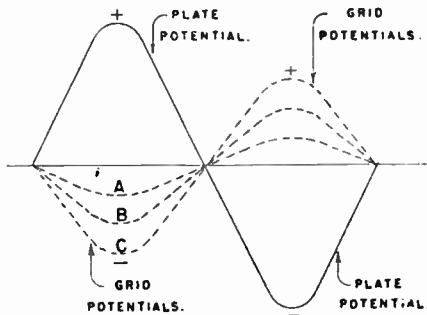

Fig. 109. Varying amplitudes of grid-cathode potential. Note that the grid is negative while the plate is positive, and that the grid is positive while the plate is negative.

connected through the low resistance wiring to the cathode, and will have no potential difference or zero difference with reference to the cathode. As the slider is moved toward the end of the divider marked negative (—) more and more of the alternating potential from the transformer will appear between the grid and the tube cathode. When the plate is positive, moving the slider

downward will make the grid more and more negative, with reference to the cathode.

In Fig. 109 the change of plate potential with reference to the cathode, during one cycle, is shown by the full-line curve. The changes of grid potential with reference to the cathode are shown by broken-line curves for the same cycle. The grid is negative while the plate is positive, and when the plate becomes negative the grid becomes positive. As the slider of the voltage divider is moved farther and farther away from the zero end and toward

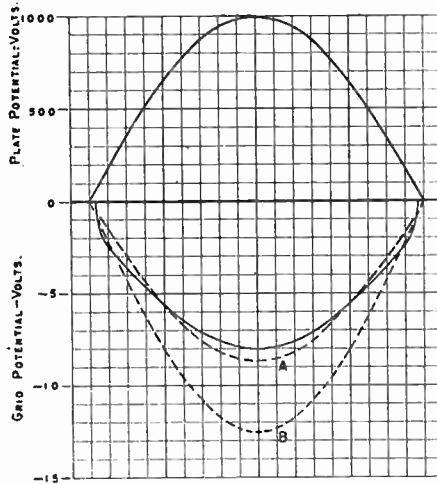

Fig. 110. Changing the amplitude of the grid potential causes the curve of actual grid voltage to cross the curve of critical grid voltages at different instants during the cycle.

the negative end, the amplitudes of the grid potentials become greater and greater, as indicated by the successive curves A, B and C.

Amplitude is a word frequently used when referring to alternating potentials or alternating electron flows. It refers to the greatest increase in either direction, positive or negative, from the average value or the zero value of the wave.

Now we have means for keeping the grid negative with respect to the cathode while the plate is positive, and we have means for varying the value of this negative grid potential, but still we have not a particularly satisfactory method of control. The reason is shown in Fig. 110. Here the upper curve is the same curve for plate potential that appeared in Fig 105, but now it

is completed for the entire half-cycle. The lower curve drawn in a solid line is the curve of critical grid potentials taken from Fig. 105, but not completed for the half-cycle.

The broken-line curves at the lowest part of Fig. 110 show negative grid potentials of two amplitudes, such as might be produced by moving the slider on the voltage divider of Fig. 108. Curve A is for a potential having an amplitude of about 8.7 volts negative, and curve B is for a potential having an amplitude of 12.5 volts negative. Curve A crosses the curve for critical grid potentials at about 5.5 volts negative, so that the tube will break down at the

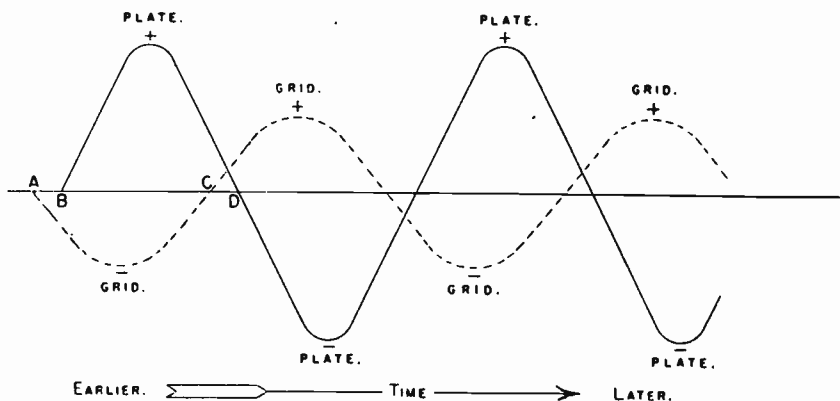

Fig. 111. Alterations of grid potential may be shifted with reference to alterations of plate potential.

point in the cycle where the plate potential is that corresponding to a critical grid potential of 5.5 volts. Curve B first crosses the critical potential curve at about one-half volt negative and again at 3.0 volts negative, so with this grid potential or amplitude the tube will break down almost as soon as the half-cycle commences.

The trouble is that the curves for actual grid potentials (broken-line curves) have almost the same form as the curve for critical potential. A very small change of actual grid voltage will move the intersection of the curves a long way up or down, or will make a big change in the point during the cycle at which the tube breaks down and conducts electron flow. This control would be too "critical", it would require too fine an adjustment of grid potential with the slider to obtain breakdown at any particular point in the cycle, and the least variation of transformer potential from any cause would greatly affect the time of control.

The trouble just explained may be avoided by shifting the grid potential half-cycle a little bit in relation to the plate potential

half-cycle, so that the grid commences to go negative a little before the plate commences to go positive. We want a relation between grid and plate potentials something like that shown by Fig. 111. The grid commences to become negative at the instant of time represented by position A, while the plate does not commence to go positive until the slightly later time represented by position B. At the end of the half-cycle the grid goes positive at C slightly before the plate goes negative at D, but this relation does not upset operation of the tube because once conduction begins, it continues until the plate goes negative, regardless of grid potential.

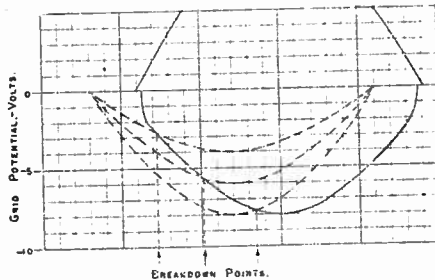

Fig. 112. A more gradual control, or a less critical control, is obtained when changes of grid potential occur a little earlier than corresponding changes of plate potential.

Fig. 112 shows what happens when we displace the grid potential in relation to the plate potential and use various amplitudes of grid potential. As on other graphs, the full-line curve at the bottom shows critical grid potentials at which breakdown occurs for corresponding plate potentials. The three broken-line curves shown represent three different amplitudes of grid control potential. For one curve the amplitude (maximum negative potential) is four volts, for another it is six volts, and for the third is eight volts. Breakdown points for the three control grid amplitudes are indicated by arrows at the bottom of the graph.

It is apparent that the control method illustrated by Fig. 112 is a great improvement over that of Fig. 110, for now it is necessary to make much greater changes of grid control potential to shift the breakdown point a given amount, and the control is correspondingly less critical and is less subject to troublesome variations when in practical operation. There are several possible ways of displacing the alternating grid potential with reference

to the alternating plate potential in order to obtain the effect illustrated in Fig. 111. We shall talk about methods of shifting one potential with reference to another when discussing still other types of control in which such shifting is the chief means for varying the breakdown point.

EFFECT OF THYRATRON CONTROLS—We should not forget that the thyatron is always a rectifier, and that alternating potentials applied to the plate circuit of the thyatron produce a direct electron flow, not an alternating flow, in the plate circuit and the load.

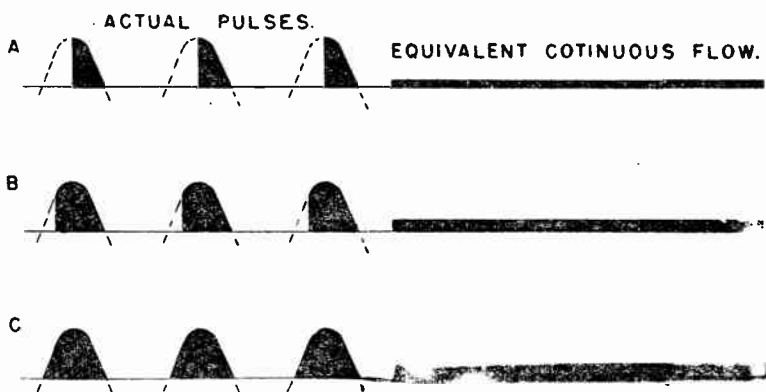

Fig. 113. Pulses of electron flow occurring always in the same direction are equivalent in many ways to continuous electron flows.

With any of the methods of control that have been described we obtain pulses of direct electron flow such as shown by the shaded portions of the cycles in Fig. 113. The portion of the cycle during which electron flow takes place may be varied to a limited extent, from a quarter-cycle as at A to an entire half-cycle as at C. The values of an equivalent steady or continuous flow are shown by the shaded bars toward the right. The pulses occur so many times each second that the effect in many types of loads is the same as an equivalent continuous flow. For example, with a 60-cycle alternating supply potential, a single thyatron will deliver 60 pulses every second. Two thyatrions connected in a full-wave circuit, much as two rectifiers of any other type are connected, will deliver 120 pulses every second with a 60-cycle supply potential, and will deliver twice the value of continuous flow that may be had from one thyatron when the tubes are alike.

Because none of the control methods so far examined permit reducing the direct electron flow to zero, and because none of them permit a gradual variation from zero to maximum rate of flow, they are essentially **on-or-off controls**. The electron flow may be stopped completely by setting the grid voltage so far negative that the tube never breaks down. If the grid is made less negative, and breakdown is permitted, there will be an equivalent continuous electron flow, as in Fig. 113, until the grid again is made so negative as to stop all flow. Control methods that will either permit an electron flow or stop the flow, but that have only a limited effect on the rate of flow, often are called **trigger controls**. The next control that we shall study is one that permits complete and gradual control from zero to maximum flow.

Chapter 8

THYRATRON CONTROL AND OPERATION

How Alternating Potentials Are Produced — Alternating Electron Flow In Capacitors — Reactance of a Capacitor — Phase Shifting Circuits — Cathode and Filament Connections — Effect of Phase-shift — Resistor-inductor Phase Shifting — Multiple Control — Thyatron Ratings — Ionization and Deionization.

With the last method of thyatron control described in the preceding chapter, we shifted the time of the alternating grid potential in relation to the time of the alternating plate potential, then varied the amplitude of the grid potential to secure a limited effect on the average rate of electron flow. Now, to provide a control method of still wider usefulness, we shall maintain the grid control potential at a fixed or constant amplitude, and shall vary the time relation between the grid potential and the plate potential. This new method is called phase-shift control.

The word phase, in the sense that we now are using it, refers to the relative instants of time at which the peaks of alternating potentials or alternating electron flow occur. When comparing two potentials or two flows, the two peaks compared must both be positive or both negative. Both quantities may be potentials, both may be electron flows, or one may be a potential and one an electron flow.

Phase relations are of enough importance in electronic work to warrant spending a few minutes in discussing them. One complete cycle of alternating potential, or one complete cycle of electron flow, extends through a time period consisting of 360 electrical degrees, just as a circle consists of 360 angular degrees. The reason for this use of degrees is shown by Figs. 115 and 116.

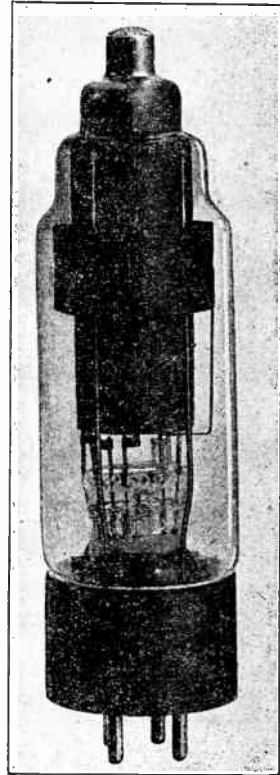

Fig. 114. A thyatron, type WL-672.

In Fig. 115 we have a magnet whose ends or poles are formed into a hollow cylinder. The "magnetomotive force" of the magnet produces lines of magnetic force which are assumed to extend from one pole to another, and to move from the north pole to the south pole of the magnet. The north pole is the end which would point north were the magnet freely suspended, while the south pole would point south. The space in which the magnetic lines of force exist is called the magnetic field. In a suitably designed magnetic structure the lines of force are almost equally distributed in the field, and we have a uniform magnetic field.

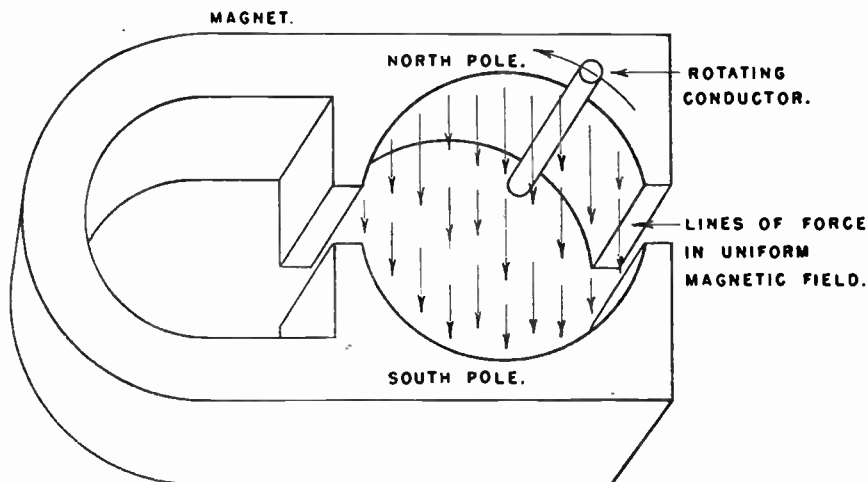

Fig. 115. An electromotive force is induced in a conductor rotating in a uniform magnetic field. If rotation is at a constant rate and around a center, the rises and falls of emf follow a sine wave.

If a conductor is rotated at constant speed in a uniform magnetic field, as indicated in Fig. 115, there is an electromotive force induced in the conductor. An electromotive force, frequently abbreviated emf, is the force that produces a potential difference throughout the conductor. If the conductor is part of a complete circuit or a closed circuit this emf will cause an electron flow in the conductor and in the circuit. The direction of the emf, and the direction of any electron flow, depends on the direction of the magnetic lines of force and on whether the conductor rotates clockwise or counter-clockwise through the field.

The left-hand diagram of Fig. 116 represents the conductor at four positions, A, B, C and D, in one travel through the magnetic field. Since the circle around which the conductor travels con-

sists of 360 angular degrees we may identify the four positions according to the number of degrees through which the conductor has moved from its starting point, which here is considered to be position A and is marked 0°. One-quarter way around the circle the conductor has moved through 90 degrees, and is at B. At C the conductor has traveled a half-circle, or 180° from its starting point, at D it has traveled three-quarters of a circle, or 270°, and then comes back to position A which represents a travel of 360 degrees and also the start of the following revolution, or 0 degrees.

The strength of the emf induced in the rotating conductor depends on the number of lines of force that the conductor cuts through during each second of time. When the rate of cutting is 100,000,000 magnetic lines of force per second the induced emf has a value of one volt.

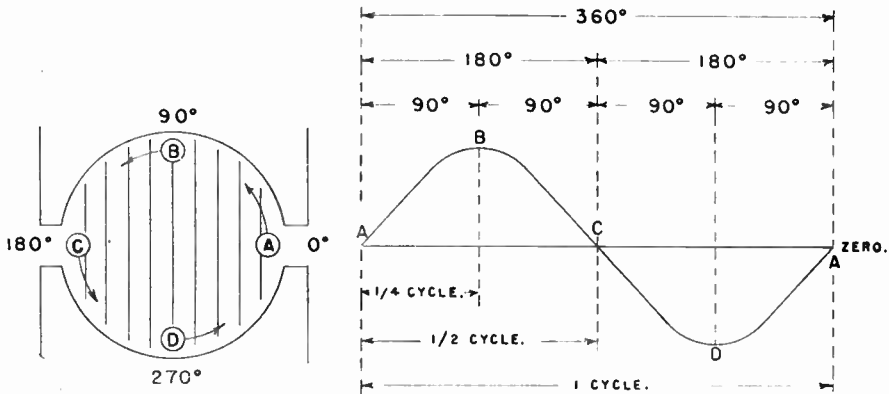

Fig. 116. The sine wave of electromotive force produced in the rotating conductor may be divided into 360 degrees of one cycle, and into smaller numbers of degrees representing portions of the cycle.

When the conductor of Fig. 116 is at position A it is, for the briefest instant, moving exactly parallel with the lines of force, and is not cutting across any lines. At this instant there is no induced emf, no potential difference, no electron flow—so we show this condition on the zero potential line of the curve in Fig. 116. As the conductor travels from A to B it cuts through more and more lines at every degree of travel, so the emf and potential difference increase as shown by the rise from A to B on the curve. With the conductor at position B it is cutting straight across the magnetic lines, so is cutting them at the maximum rate, and the induced emf and potential difference reach their peak values—just as shown at B on the curve.

From B to C the conductor cuts magnetic lines at a decreasing rate, then the rate increases from C to D, reaching a peak value at D, decreasing again from D to A. All the corresponding changes of emf and potential difference are shown by the curve.

The curve shows one cycle of alternating potential, and because this one cycle results from travel of the conductor around the 360 degrees of the circle, we divide the cycle into degrees. Each quarter-cycle covers 90 degrees, each half-cycle or alternating covers 180 degrees, and the full cycle covers 360 degrees.

When the conductor rotates at a constant rate in a uniform magnetic field the changes of emf and potential are proportional to the sine of the angle through which the conductor has traveled from its starting point, considered as zero degrees. A curve show-

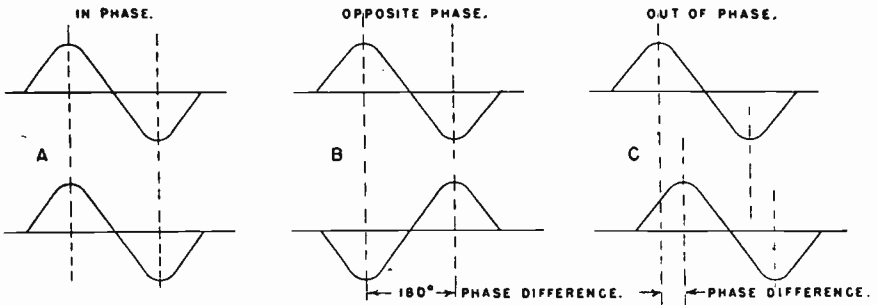

Fig. 117. Phase relations of two alternating potentials, two alternating electron flows, or one potential and one electron flow.

ing such changes is called a curve of sines, and the potential or electron flow is said to be a sine-wave potential or a sine-wave electron flow. Should you wish to determine the value of a sine-wave potential or electron flow at various points in the cycle, as identified in degrees, simply look in any table of natural sines and there you will find the relative values for each degree.

In two potentials or two electron flows, or one potential and one electron flow, have their positive and negative peaks occurring at the same instant or at the same position in the cycle the two quantities are **in phase**, as shown at A in Fig. 117. If the positive peak of one quantity occurs at the same instant as the negative peak of the other quantity the two are of **opposite phase**, as at B. Unless the two quantities are in phase they are said to be **out of phase**. One **out-of-phase** condition is shown at C, but the **phase difference** might be any other, and so long as there is a difference

the two quantities are out of phase. Opposite phase is the extreme case of being out of phase.

If the positive and negative peaks of one quantity occur before the corresponding peaks of another quantity, as at A in Fig. 118, the first quantity is said to lead the second. Here the upper quantity (a potential or an electron flow) leads the lower one by a phase difference of 45 degrees. At B the peaks of the upper quantity occur later in the cycle than do the corresponding peaks of the lower quantity, and the upper quantity lags the lower one. Here the phase difference is 90 degrees. Amplitude has nothing to do with phase relations.

What we want for our phase-shift control of a thyatron tube is an alternating grid potential that may be made to lag or lead the alternating plate potential, and we wish to have an adjustable phase difference so that we may shift the phase of the grid potential with reference to the plate potential as may be desirable for control purposes.

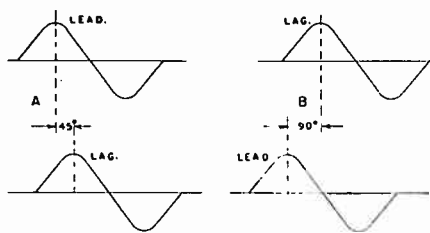

Fig. 118. Lag and lead of alternating potentials or electron flows.

PHASE-SHIFT PRINCIPLES—Fig. 119 shows one of the many different circuit arrangements which may be used for phase-shift control. The load is connected between the plate of the thyatron and one end of the high-potential winding of the transformer. The grid of the thyatron is connected to the other end of the high-potential winding through a capacitor C, with an adjustable resistor called a rheostat between the grid connection and the plate. The purpose of grid resistor R is to prevent an excessive flow of electrons in the grid circuit. The cathode of the tube is connected to a tap on the high-potential winding of the transformer.

In operating the circuit of Fig. 119 we should find that increasing the amount of rheostat resistance reduces the average electron flow through the thyatron, and that decreasing the resistance increases the electron flow. Changing the resistance shifts the

phase of the grid potential with reference to the plate potential. To learn just why the phase is shifted by changing the rheostat resistance requires that we examine the behavior of a capacitor in an alternating-potential circuit.

First; alternating potential will cause electron flow in a circuit having a capacitor in series, but direct potential will cause no such flow. Direct potential cannot cause an electron flow because the dielectric of the capacitor is an insulator, because the direct potential acts always in one direction, because any electron flow would have to continue in one direction, and because there can be no continuous electron flow through an insulator.

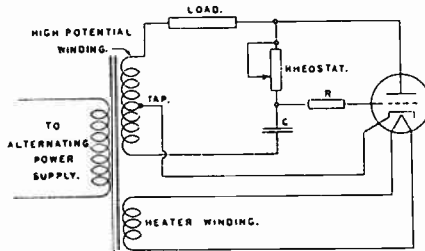

Fig. 119. One type of phase-shift control for a thyratron.

The reason that an alternating potential may cause an alternating electron flow in a circuit containing a capacitor in series is shown by Fig. 120. At the top of the diagram is shown the capacitor with its two plates and the dielectric between them. The positive and negative signs on the dielectric surfaces indicate positive and negative charges; a positive charge being a deficiency of negative electrons, and a negative charge being an excess of electrons, as compared with the balanced condition of a neutral body. Below the capacitor is shown a source of alternating potential whose terminals become alternately zero, positive and negative during a cycle. The arrows show directions of electron flow between the source and the capacitor. At the bottom of the diagram is a curve representing the changes of potential from the source during one cycle. This is what happens, step by step:

1. The source potential difference is zero, the dielectric of the capacitor is neutral (having no charges), and there is no electron flow.

2. One terminal of the source becomes increasingly positive, this being the terminal whose potential changes are represented by the curve. Of course, the other terminal of the source is at the

same time becoming increasingly negative. Electrons flow from the negative terminal of the source to one side of the dielectric, and an equal number of electrons flow from the other side of the dielectric to the positive terminal of the source. The capacitor is becoming charged.

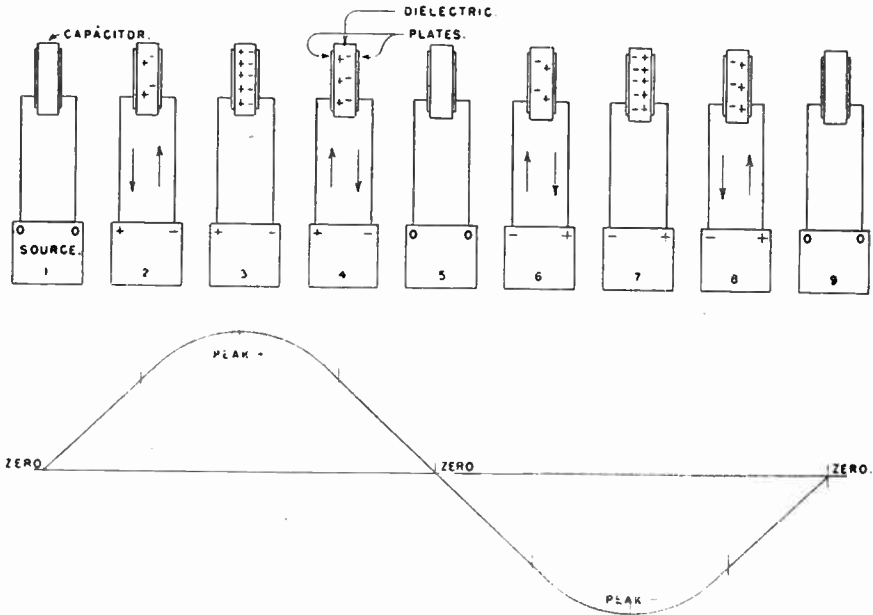

Fig. 120. How a capacitor is charged and discharged during one cycle of alternating potential. Resulting electron flow into and out of the capacitor permits alternating electron flow in a circuit connected to the capacitor.

3. The source terminals reach their peak potentials. The dielectric now has become fully charged. The difference of potential across the dielectric, due to the differences between electron quantities at the two sides, now is equal to the potential difference of the source. Because there is the same potential difference across both the capacitor and the source, there is no electron flow.

4. The source potential is decreasing. The higher potential difference across the capacitor causes electron flow from the negative side of the capacitor to the source, and electrons flow from the positive side of the source to the capacitor.

5. The source potential difference has fallen to zero, the capacitor has discharged completely, and for just an instant there is no electron flow.

6. The source potential difference is increasing, but in the opposite direction. Conditions are similar to step 2, but the directions of electron flow and the electrical stress in the dielectric are now reversed.

7. The capacitor is fully charged in the reverse direction, its potential difference becomes equal to the potential difference of the source, so electron flow stops. Compare step 3.

8. The source potential difference has fallen below the potential difference of the capacitor, so electron flow is as shown by the arrows.

9. The source potential difference again is zero, the capacitor has discharged, and we are ready to start over again. Conditions here are exactly the same as for step 1.

We have seen that an alternating potential will alternately charge a capacitor in opposite directions, and that the electron flow for charging and discharging the capacitor periodically reverses its direction, so is an alternating electron flow.

REACTANCE OF A CAPACITOR—Alternating electron flow is not so free in a circuit containing a capacitor as in a circuit formed wholly of good conductors. The opposition offered by a capacitor to alternating electron flow is called **capacitive reactance**. The greater the stress produced in the dielectric by a given difference of applied potential the greater must be the electron flow in the circuit. This greater electron flow means less reactance in the capacitor.

As you will recall, we measure the capacitance of a capacitor in farads, or for practical purposes in microfarads. Capacitance measures the charge that a capacitor will take with a given applied potential difference. So the greater the capacitance in microfarads the less is the reactance of a capacitor.

The opposition effect called capacitive reactance is measured in ohms, just as is the opposition called resistance. This reactance depends on the capacitance of the capacitor and on the frequency of the applied alternating potential.

$$\text{Capacitive reactance in ohms} = \frac{159,155}{\text{frequency in cycles} \times \text{Capacitance in microfarads}}$$

This formula shows that capacitive reactance becomes less as the frequency increases, also that the reactance becomes less as the capacitance is increased. For a frequency of 60 cycles, capaci-

tive reactance in ohms is equal approximately to 2,653 divided by the number of microfarads of capacitance.

PHASE SHIFTING CIRCUITS—If a resistance and a condenser—or a resistance and an inductance—be connected in series as shown in Fig. 121, a potential difference will appear across points A and B. Assuming the secondary winding of the supply transformer T to be center tapped, the alternating potential difference between A and B will equal one-half that of the secondary winding.

Changing the value of R does not alter the value of the potential difference between A and B but it does change the phase of this P. D. (potential difference) with respect to the P. D. across X and Y. This means that the instant when the alternating P. D.

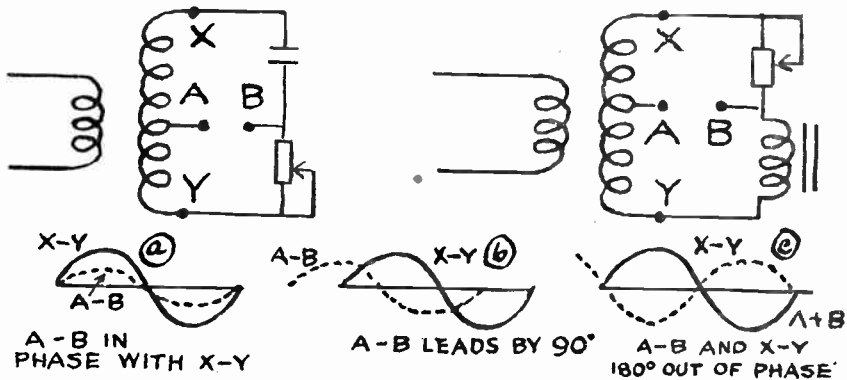

Fig. 121. The circuits above illustrate the basic phase shifting work; the curves below indicate how the phase of A-B may be changed with respect to X-Y.

across A-B reaches its maximum value with respect to the P. D. across X-Y will be changed as the value of R is altered. This arrangement, which provides us with a means of shifting the phase of one P. D. with respect to another, is called a phase-shifting network. It is frequently used for the control of thyratrons, for if point A is connected to the cathode of the tube and point B to the grid, as shown in Fig. 122, then the phase of the grid potential may be shifted with reference to the plate potential in order to control the firing of the tube.

In the ordinary type of phase shift control circuit, the plate P. D. of the tube to be controlled is usually in phase with X-Y; therefore, as the P. D. applied to the grid of the tube is represented in Fig. 121 by A-B, the three sets of curves show how the grid P. D. may be shifted with respect to the plate P. D. in order

to control the firing point of the tube. With the plate-grid relation shown in (a) the electron flow in the plate circuit of the tube would be maximum; in (c) it would be zero; and in (b) it would have some intermediate value.

The phase may be shifted by varying the resistance, by varying the capacitance, or by varying both of them. In the phase-shift circuit of Fig. 119 we vary the resistance to shift the phase of the grid potential with reference to the plate potential. Fig. 122 shows another phase-shifting circuit containing a capacitor C and an adjustable rheostat for varying the resistance.

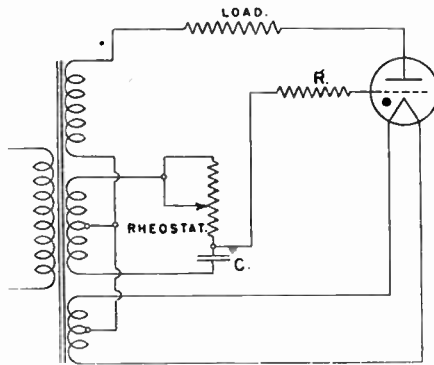

Fig. 122. A phase-shift circuit in which grid potentials are secured from a separate winding on the transformer.

CATHODE AND FILAMENT CONNECTIONS—Doubtless you have noticed that in some circuits we show tubes having separate cathodes with heaters, as in Fig. 119, and in other circuits show tubes with filaments as the emitter, as in Fig. 122. Which kind of emitter is used has nothing in particular to do with the operating principle of the remainder of the circuit, but simply is a matter of what type of tube is selected.

In Fig. 123 at A we have a tube with separate cathode, at B we have a tube with a filament emitter connected to a center-tapped filament winding on the transformer. At C we have a filament heated by an untapped winding, but have a center-tapped resistor across the winding. The cathode at A, the transformer tap at B, and the resistor tap at C, are all equivalent points in the general circuit. Any parts connected to a cathode might be con-

nected to a center tap, and vice versa, all depending on the type of tube that happens to be used.

EFFECT OF PHASE-SHIFT—Now that we have a means for shifting the grid potential with reference to the plate potential, let's see what it will accomplish when operated as shown by the graphs in Fig. 124. The alternating plate potential is indicated by a full-line curve for a complete cycle. The critical grid potential is shown by a full-line curve below the zero position, extending only across the half of the cycle during which the plate is positive. The actual alternating grid potential is shown by a broken-line curve for a complete cycle. These curves are similar to those in Figs. 105, 110 and 112.

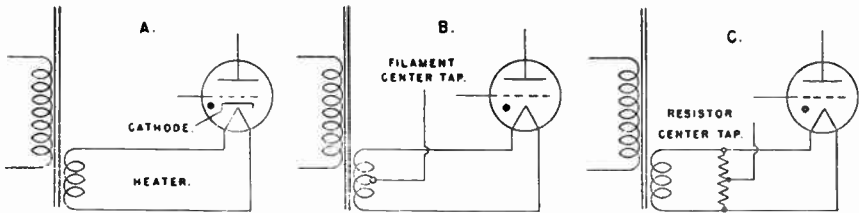

Fig. 123. Three equivalent connections for permitting electrons from the external circuit to return to the emitter of the tube.

At A in Fig. 124 the grid potential is of opposite phase with reference to the plate potential. The grid is more negative than the critical voltage during the entire half-cycle in which the plate is positive. Therefore, the tube never will break down and there will be no conduction.

At B we have shifted the phase to give the grid potential a lead of 60 degrees with reference to the plate potential. Now the grid potential remains more negative than the critical potential until the instant marked "breakdown." There the actual grid potential becomes less negative than the critical value, ionization commences, and the tube conducts electrons from this instant to the end of the half-cycle during which the plate is positive. The portion of the cycle in which conduction takes place is indicated by the shaded part under the plate potential curve.

At C in Fig. 124 we have shifted the grid potential another 60 degrees in the same direction as before. Now the grid potential becomes less negative than the critical value much earlier in the half-cycle, and we have conduction from the instant marked

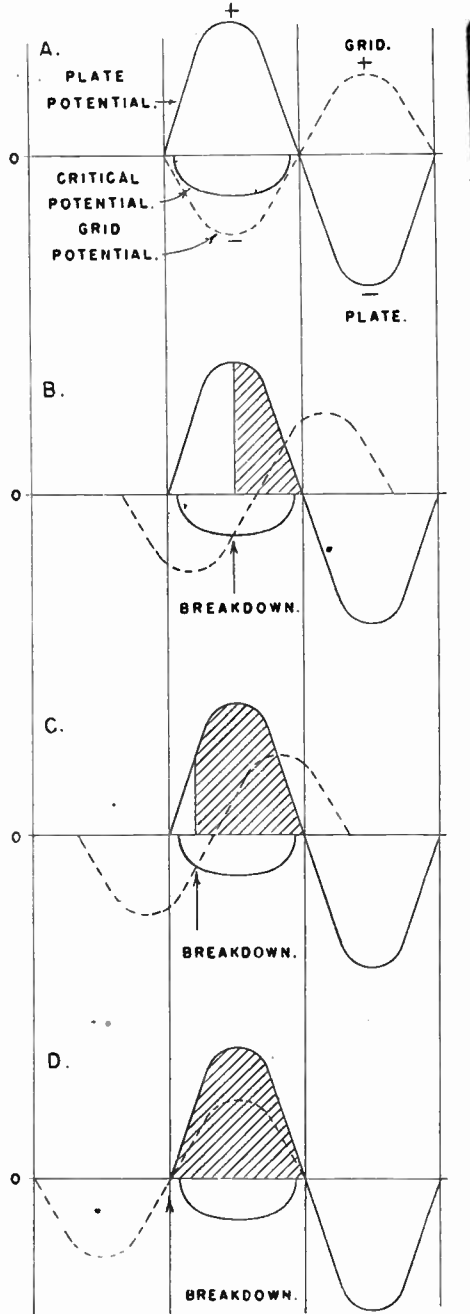

Fig. 124. The effect on time of electron flow of shifting the negative grid potential with reference to the positive plate potential.

“breakdown” to the end of the half-cycle in which the plate is positive.

At D the grid potential has been shifted so far that it is in phase with the plate potential. Now the grid is positive during the entire half-cycle in which the plate is positive, so there is conduction during this entire half-cycle. By shifting the grid potential we are able to control electron flow in the plate circuit all the way from zero flow to the maximum flow corresponding to conduction during all of the half-cycles in which the plate is positive.

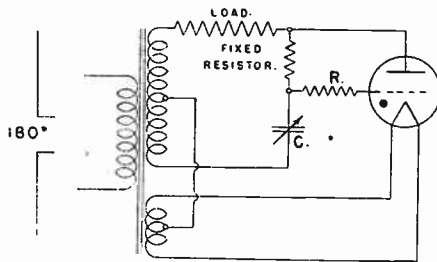

Fig. 125. Phase-shift control may be had with an adjustable capacitor and a fixed resistor.

With capacitor-resistor phase-shift control as in Figs. 119 and 122 the grid potential is shifted as from A to D in Fig. 124 by decreasing the resistance of the rheostat, for this allows the capacitor to have more and more effect, and to give the grid potential a greater and greater lead.

Instead of using an adjustable resistor (rheostat) and a capacitor of fixed capacitance we might use a fixed resistor and an adjustable capacitor as indicated in Fig. 125. Now the electron flow in the plate circuit is increased by increasing the capacitance of the capacitor, thus increasing the effect of the capacitance in comparison with that of the resistance.

Adjustable capacitors usually are constructed with one plate or one set of plates movable with respect to the other plate or set of plates. The greater the separation between plates, or the greater the thickness of the dielectric, the less is the capacitance of the unit.

Note that with the capacitor-resistor control we increase the average electron flow in the plate circuit by decreasing the resistance, or we may increase the flow by increasing the capacitance.

RESISTOR-INDUCTOR PHASE-SHIFTING—In Fig. 126 we have replaced the capacitor with an inductor in the phase-shifting circuit. An inductor, as we learned when studying filters, possesses the property called inductance. Inductance opposes any change of the rate of electron flow because inductance causes an induced emf that tends to oppose any change in the value of the electron flow. Such behavior on the part of an inductor means that it strongly opposes alternating electron flow, because an alternating flow is constantly changing.

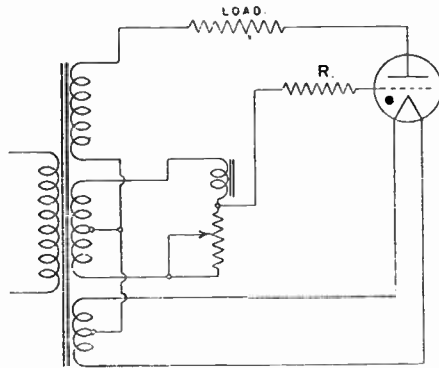

Fig. 126. A phase-shift employing an adjustable resistor and an inductor of fixed inductance.

The opposition offered by an inductor to alternating electron flows is called **inductive reactance**. Like all other oppositions, inductive reactance is measured in ohms.

$$\text{Inductive reactance in ohms} = 6.2832 \times \text{frequency in cycles} \times \text{inductance in henrys}$$

This formula shows that inductive reactance increases with increase of frequency and also with the inductance in henrys. Capacitive reactance decreases with increase in frequency. The effects of reactance are in many other ways just the opposite of the effects of capacitance. If we were to use an inductor instead of the capacitor in Fig. 121, the potentials in the circuit containing inductance would lag the potentials in the circuit containing only resistance, whereas capacitance causes leading potentials.

Because inductance causes a phase shift we may use an inductor as in Fig. 126. The greater the inductance in henrys and the greater the inductive reactance in ohms the more the potential will lag in the inductive grid circuit. The greater the

resistance in comparison with the inductance the more nearly the potential is pulled back into phase.

The graphs of Fig. 124 represent phase-shift with an inductor just as well as with a capacitor. We may begin at A with the grid potential of opposite phase to the plate potential, and consider that the grid potential is lagging the plate potential by 180 degrees. Increasing the resistance, to overcome the effect of inductance, or decreasing the inductance directly, will produce the effects at B and C, where the lagging grid potential is being brought more and more nearly into phase with the plate potential. At D the increase of resistance has so far overcome the effect of inductance as to bring the potentials practically in phase, or, we might consider that the inductance has been reduced to such a low value as to have practically no effect.

Adjustable inductors usually are made so that the coil winding and the iron core are movable with reference to each other. The farther the core is moved out of the coil, or the farther the coil is moved off the core, the less becomes the inductance. Moving the core into the coil increases the inductance.

Note that varying the resistance one way or the other in a phase-shift control using resistance and capacitance has the opposite effect of a similar variation of resistance in a control using a combination of resistance and inductance. Here is a summary of the affect on average electron flow of variations in reactance, capacitance, and inductance in the two types of control circuits that have been examined:

<p>Circuit with RESISTANCE AND CAPACITANCE</p>	<p>More flow with less resistance, or more capacitance. Less flow with more resistance, or less capacitance.</p>
---	--

<p>Circuit with RESISTANCE AND INDUCTANCE</p>	<p>More flow with more resistance, or less inductance. Less flow with less resistance, or more inductance.</p>
--	--

From this summary we learn that the effect of increasing either a capacitance or an inductance is opposite to the effect of increasing the resistance in the same type of circuit, and that a decrease of either capacitance or inductance has the same effect as an increase of resistance in the same circuit.

MULTIPLE CONTROL—Any phase shifting control may be used to feed its shifted potential to the grid circuits of additional thyratrons as shown in principle for one type of control in Fig. 127. In the circuit shown, the shifted potentials are fed from the phase-shift circuit through coupling transformers into the grid circuits of two thyratrons.

There are many phase-shifting methods and devices other than those shown. One is a machine somewhat similar to one type of alternating-potential motor in which are stationary and movable

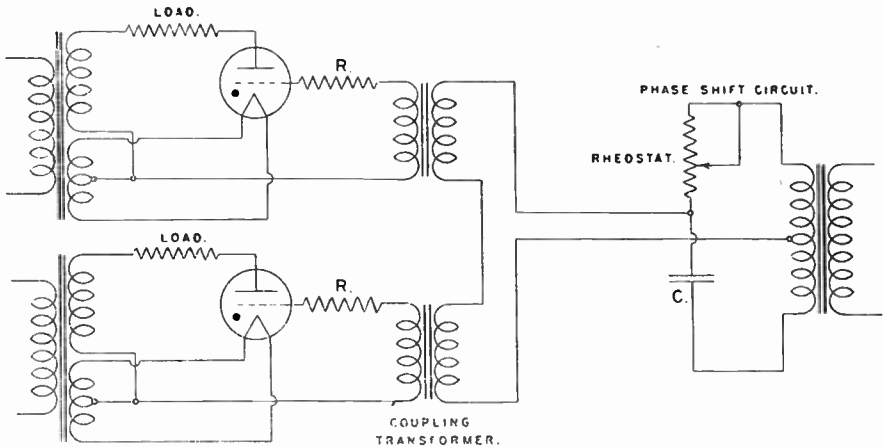

Fig. 127. Control potentials from a separate phase-shift circuit may be introduced into the control grid circuits of several thyratrons through coupling transformers.

windings whose relative position may be varied for control purposes. Such an induction phase-shifter is used on three-phase power supply systems. A three-phase system is one in which there are at the same time three separate alternating potentials and three corresponding electron flows in the one set of conductors.

Phase-shifting, however controlled, is preferable for applications in which there is to be control of electron flow or power all the way from zero to the maximum which may be handled by the tube. Phase-shift controls are less affected than other methods by aging of the tubes, by differences in characteristics of different tubes of a given type, by changes of heater or filament potential, and by the many other variables that occur in normal operation.

A single thyatron is a controlled half-wave rectifier; controlled because it permits varying the average electron flow, and half-wave because flow occurs on only every alternate half-cycle. To provide full-wave controlled electron flow two thyratrons may

be used as in Fig. 128. Arrows show the direction of electron flow in each tube and in its portion of the center-tapped power transformer. Electron flows from both tubes pass through the load in the same direction. The grid control potential here is intro-

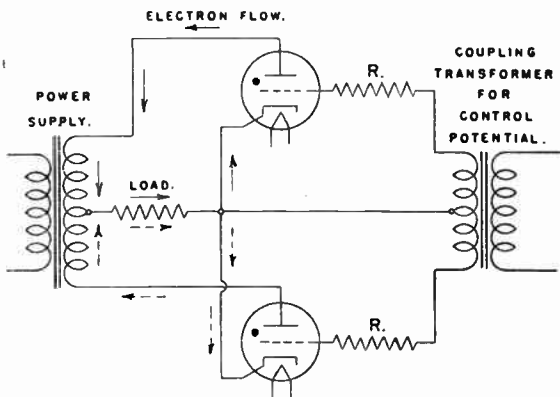

Fig. 128. Two thyratrons may be used in a full-wave circuit to provide full-wave rectified electron flow.

duced through a separate transformer from any circuit in which there are suitable alternating potentials for phase-shifting.

Two thyratrons may be used to control an alternating electron flow without rectification, meaning that the flow still is alternating after passing through the tubes, but that its rate may be regulated. The principle is shown by Fig. 129. The plate of one tube is connected to the cathode of the other, and the plate of the second to the cathode of the first. Flow in the direction of full-line arrows passes through the left-hand tube, while flow in the opposite direction goes through the right-hand tube as indicated by broken-line arrows. Any type of grid control may be used. No grid circuits are shown in this diagram, which illustrates only the general principle of the circuit.

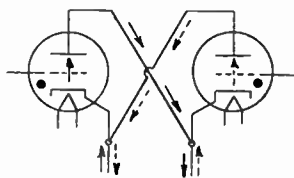

Fig. 129. Two thyratrons connected in such manner as to control average electron flow while the flow remains alternating. This connection does not deliver a direct electron flow.

THYRATRON RATINGS—Ratings published by tube manufacturers list information that is absolutely essential to have if the

tubes are to be correctly used and if normal life is to be obtained. There is some variation in the number and kind of items given by various manufacturers, but the following values are quite typical of those ordinarily included. These values apply to a three-element mercury-vapor thyratron, Westinghouse type WL-631. The items are here numbered for reference in explanations to follow.

POTENTIAL DIFFERENCES

	Plate; maximum values—		
(1)	peak, inverse	1000	volts
(2)	peak, forward	1000	volts
	Grid; maximum values—		
(3)	peak, negative	500	volts
(4)	peak, positive	12	volts
	Plate to cathode drop—		
(5)	maximum	24	volts
(6)	minimum	10	volts
(7)	average	15	volts

ELECTRON FLOWS

	Plate, maximum values—		
(8)	instantaneous	15	amperes
(9)	average	2.5	amperes
(10)	surge	90	amperes
	Grid		
(11)	maximum instantaneous	1.0	ampere
(12)	maximum average	.25	ampere
(13)	average just before breakdown	5	microamps.
(14)	Maximum time for averaging	15	seconds

CATHODE HEATER

(15)	Potential difference	5	volts
(16)	Electron flow rate	4.5	amperes
(17)	Minimum heating time	300	seconds

TEMPERATURE, condensed mercury

(18)	Maximum	80	° cent.
(19)	Minimum	40	° cent.
(20)	Optimum range	40-45	° cent.

IONIZATION TIMES, approximate

(21)	For ionization	10	microsecs.
(22)	For deionization	1000	microsecs.

The following numbered notes of explanation apply to correspondingly numbered ratings in the list. It should be understood that any value given as maximum, for this or any other tube of any kind, means that this value should not be exceeded under any circumstances. Each maximum rating stands by itself, and any one of them may fix the operating limits of the tube. For in-

stance, a maximum peak grid electron flow must not be exceeded, even though this means keeping all other values well below their permissible maximums. Maximum and peak do not mean the same thing. Maximum refers to an operating limit for the tube; peak refers to the greatest value or the crest value of an alternating quantity—potential or flow.

(1) Maximum peak inverse voltage means the same for thyratrons as for phanotrons; it is the greatest potential difference that the tube will withstand in a direction opposite to that for normal conduction without permitting electron flow in the reverse direction, from plate to emitter. In single-phase circuits such as have been shown in all our diagrams, the peak is equal to 1.414 times the rms or effective value when potentials are sine wave. Distorted waveforms and surges of potential or electron flow in power lines may greatly increase the actual peak. In case of doubt the actual peaks are measured with an oscillograph or by means of a spark gap, in which the distance across which a spark is forced indicates the peak potential difference.

(2) Maximum peak forward voltage is a rating that applies only to controlled tubes such as thyratrons. It is the greatest potential difference, applied in the normal direction, that can be controlled by the grid voltage without allowing breakdown and conduction.

(3-4) Maximum peak negative grid potential is limited by the design of the tube. Positive grid potential must be limited to prevent excessive electron flow in the grid circuit. Ordinarily the grid circuit is designed to provide greater potentials or potential differences than required by the control characteristic showing critical values.

(5-6-7) Maximum and minimum values for plate to cathode potential drop represent the normal variations due to different tubes of a given type, to age of the tube, and to variations in electron flow in the load. Tube drop becomes important only when the potential for the load and plate circuit is small, for then the tube drop becomes a greater portion of the entire drop in the plate circuit.

(8) Maximum instantaneous electron flow in the plate circuit is the greatest rate of flow that the tube may safely carry when operating conditions are normal. It would be the electron flow at the peak of positive plate potential.

(9) Maximum average electron flow in the plate circuit is the greatest rate of flow that the tube may carry continuously without

overheating. The flow rate is to be averaged over a period of time no greater than given under item 14. Since the electron flow is in pulses, and in a half-wave circuit exists during only half of each cycle as a maximum, the average flow always must be much less than the peak flow.

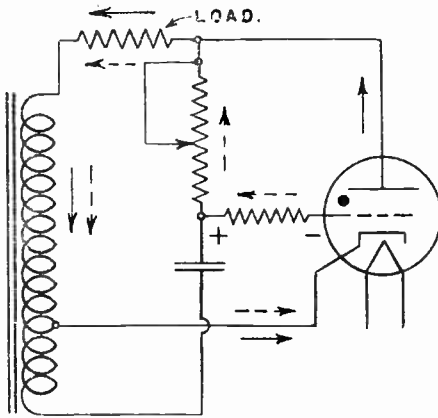

Fig. 130. Electron flow in the grid circuit of a thyatron is shown by broken-line arrows.

(10) Maximum surge electron flow is not a basis for any normal operation of the tube, but is a basis solely for selection or adjustment of fuses, circuit breakers or other external devices which limit the maximum flow when there is a short circuit which removes resistances and other oppositions to flow from the plate circuit, and which

would allow a rate of flow ruinous to the tube were it not stopped very quickly. Such a surge electron flow must not be permitted to continue for more than one-tenth second.

(11-13) When the grid becomes positive with reference to the cathode, the grid collects negative electrons coming from the cathode just as does the positive plate, but because the positive grid potential is so much less than the positive plate potential (see item 4) the rate of electron flow to the grid is relatively small.

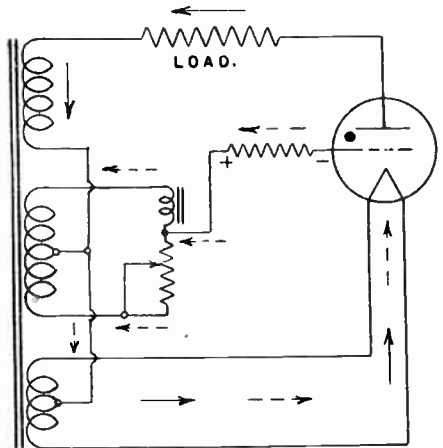

Fig. 131. The broken-line arrows show direct electron flow in the grid circuit where an inductor is used for phase-shifting.

Electron flow in the grid circuit of Fig. 125 is shown by brokenline arrows in Fig. 130, with plate circuit flow shown by full-line arrows. Electron flow in the grid circuit is rectified just as in the plate circuit, and is a direct flow. A direct flow cannot continue through a capacitor, so all of the grid flow goes

through the phase-control resistor, joins the plate flow through the load, and returns through the transformer to the tube cathode Fig. 131 shows grid circuit electron flow for the circuit of Fig. 126. Here direct electron flow may pass through both the phase-control resistor and the inductor, after which this flow joins the plate flow and returns through the center-tapped filament transformer to the filament emitter of the tube.

The direction of direct electron flow through the grid resistor makes the end of that resistor nearest the grid become negative and the end toward the cathode or filament become positive. This negative potential at the grid tends to make the grid less positive than it otherwise would be.

Instantaneous and average maximum grid flows, items 11 and 12, are limits for the grid circuit which are similar to those for the plate circuit mentioned under items 8 and 9. The average grid electron flow just before breakdown is the rate of flow with the grid still just enough negative to prevent breakdown. Note that this rate of flow is in microamperes, which are millionths of an ampere.

(14) The maximum time for averaging applies to maximum average electron flows in the plate and grid circuits, items 9 and 12. The greater the length of time during which a pulsating electron flow is averaged, the less apparent will be the effects of any peaks greater than others. By limiting the time for averaging, any abnormal peaks or pulses will noticeably affect the average value obtained.

(15-16) The potential difference applied to the heater of a tube with separate cathode, or to the filament with a filament emitter, should be kept as nearly as possible at the value specified, and usually it is specified that the actual applied potential difference should not be more than five per cent above or below this value. The potential difference determines the emitter temperature. Low temperatures do not cause enough electron emission for the applied plate potential, and the emitter surface will be damaged. High potentials overheat the emitter and shorten its life. The electron flow rate is listed only so that a filament or heater transformer may be selected to have the needed capacity in amperes.

(17) Minimum heating time has been explained in connection with phanotrons; it is the minimum time for the emitter to reach a temperature at which electron emission is great enough to supply normal electron flow. Longer heating times are required when the tube first is installed, and when it has been moved or

handled. When tubes are operated only at intervals, the emitter sometimes is kept continually heated to avoid the delay for pre-heating before each period of use.

(18-20) Condensed mercury temperatures have been explained in connection with phanotrons of the mercury-vapor type. For the tube whose ratings are given, the most desirable temperatures are between 40 and 45 degrees centigrade, 104 and 113 degrees Fahrenheit.

(21-22) Ionization time is the length of time required to form enough positive ions around the emitter to permit maximum electron flow through the tube without damaging the emitter surface. It is assumed that this time is measured with the grid somewhat less negative than the critical potential for breakdown, and that there is enough plate potential to produce the electron flow.

Deionization time is the length of time required for the positive ions to become neutralized to an extent that allows the grid to regain control, the time being measured after the plate potential falls below a value that will maintain ionization and after there has been a normal rate of electron flow. Listed deionization times are only approximate, because the actual time depends on potentials and electron flows in both the plate circuit and the grid circuit, also on the actual operating temperature.

Deionization time limits the highest frequency at which the tube will operate successfully, because should there be a great many positive ions after the half-cycle in which the plate is positive there will be a reverse electron flow through the tube. Ionization time always is so brief that it has little importance except at extremely high operating frequencies. Note that both these times are measured in microseconds, which are millionths of one second.

Chapter 9

THYRATRON OPERATION

Shield-grid Thyratrons Or Gas Tetrodes — Shield Grid Connections — Control Characteristics — Operating Voltages for the Grid — Circuit Capacitances — Protective Resistances — Base and Cap Connections — Cathode and Filament Returns.

A disadvantage of the three-element thyatron for some applications is that there may be a rather large electron flow in the control grid circuit. This flow may result from ionization within the tube while there is a large potential difference between the plate and the control grid, from electron emission from the grid when its temperature becomes high, from electron flow to the grid when its potential is more positive than that of the emitter, and from other factors. Any current flowing through resistance in series with the control grid tends to alter the grid potential, and must be balanced by a suitable potential acting in the opposite direction.

Flow of electrons and positive ions from and to the control grid may be greatly hindered, and grid electron flow in the grid circuit thereby reduced, by introducing a fourth electrode which shields the control grid from the plate. This fourth element is called a shield grid. Tubes containing this extra grid are called gas tetrodes or mercury-vapor tetrodes, or may be called shield-grid thyratrons or four-element thyratrons. The word tetrode is derived from the Greek "tetra," which means four.

Fig. 132 shows the construction of small gas-filled tetrodes, types RCA-2050 and RCA-2051. The part numbered 1 is a shielding mica which is coated with conductive material so that it may form a part of the shield structure of the tube. There is a second shielding mica below the elements. The part marked 2 is an insulating mica which supports and insulates the elements. Part 3 is the cathode which is of the internal heater type. Number 4 is the control grid, in the form of a rather high and narrow open loop between the cathode and plate. Number 5 is the shield grid, partly cut away to show the other elements. This shield grid, in combination with the shielding micas, encloses the cathode, the control grid and the plate. Part number 6 indicates a partition of the

shield for separating the control grid from the plate except for an opening which permits electron flow from the cathode through the control grid to the plate. Number 7 is the plate, which actually is a small flat plate. Number 8 is a glass insulating sleeve enclosing the support and connection for the plate. Number 9 indicates the

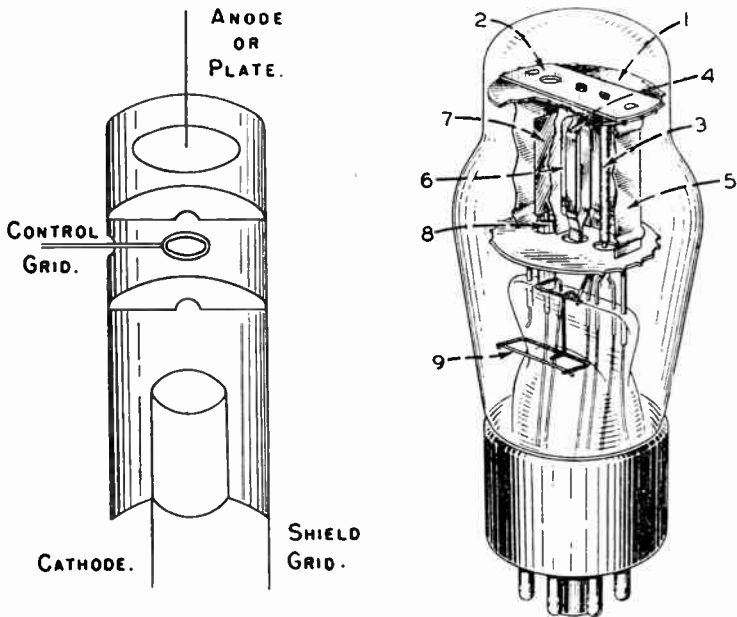

Fig. 132. Left: The shield grid partially encloses the cathode and anode, forcing electron flow through the space in which is the control grid. Right: Structure of RCA-2050 and RCA-2051 gas tetrodes; 1, shielding mica; 2, insulating mica; 3, cathode; 4, control grid; 5, shield grid; 6, opening through partition in shield grid; 7, plate; 8, glass insulating sleeve; 9, getter.

position of the "getter," which is material flashed inside the tube during manufacture to get rid of unwanted gas while the tube is being evacuated.

In addition to reducing electron flow in the grid circuits, the shield grid greatly lessens the capacitance existing between the control grid and the plate. This capacitance exists because the control grid and plate act like two conductive plates of a capacitor, while the gas or vapor in the bulb acts as the dielectric. The greater the capacitance between control grid and plate the greater is the effect on control grid potentials of changes of potential on the plate. With the shield grid located between the control grid

and the plate, and suitably connected to the external circuit, changes of potential differences that otherwise would affect the control grid are largely absorbed and dissipated by the shield grid.

SHIELD GRID CONNECTIONS—Fig. 133 shows circuit connections for operating an electromagnetic relay through a gas-tetrode when there is a change of resistance in a variable control resistance of any kind. An adjustable grid-cathode potential difference is obtained from a voltage divider fed from a rectifier and filter system, and the plate-cathode potential difference is secured from the potential drop across a bleeder resistor.

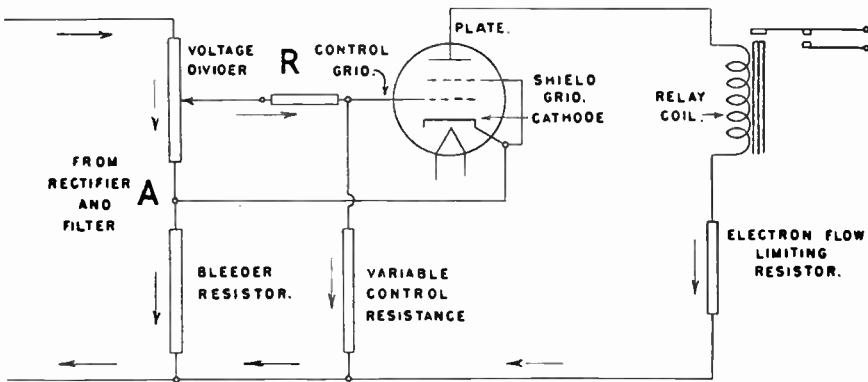

Fig. 133. Thyatron-operated relay circuit with trigger operation by change of any variable control resistance. Direct potential differences are furnished by a voltage divider on a rectifier-filter system.

Note that the symbol for a tetrode is similar to that for a triode except that there is the additional shield grid between the control grid and plate of the tetrode. In Fig. 133 the shield grid is connected directly to the cathode, thus maintaining the shield at zero potential with reference to the cathode. This is the shield grid connection most often used with this type of tube.

Arrows show the directions of electron flow through the resistors of Fig. 133. With the variable control resistance so great as to nearly stop the flow through it and grid resistor R , the control grid is held more negative than the cathode by the potential drop between the slider of the voltage divider and the cathode connection at A . As variable control resistance is lessened, more electron flow goes through this resistance and resistor R . The direction of flow through R is such as to make the control grid more positive with reference to the cathode. When control grid

potential reaches the critical value the tube breaks down and there is electron flow through the plate circuit which includes the relay coil, thus operating the relay.

Fig. 134 shows a phase-shift control circuit for a thyratron of the tetrode or four-element type. The phase shift circuit contains an adjustable rheostat and a capacitor such as used in other circuits which have been examined. Here again the shield grid is connected to the tube cathode. A potential difference for the cathode heater is obtained from the secondary of the transformer. The higher alternating potential difference for the plate and load circuit is obtained by connecting this circuit directly to the power line on the primary side of the transformer.

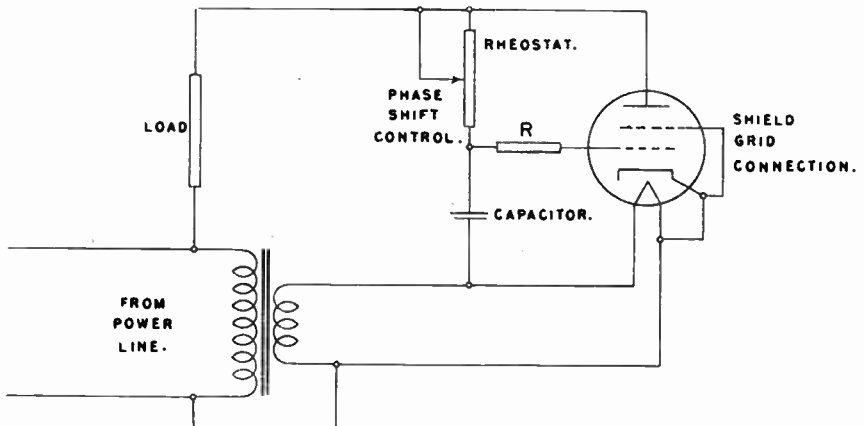

Fig. 134. A phase-shift circuit for a gas tetrode. The plate and load circuit is connected directly to the power line.

ELECTRICAL NAMES AND ABBREVIATIONS—When first discussing electron flows and differences of potential we learned that the potential at any point in a circuit may be measured only with reference to the potential at some other point. We always are dealing with differences of potential, not with isolated or independent potentials. For instance, when we speak of a “grid potential” we really mean the difference of potential between the grid and the electron emitter.

We learned also that the volt is the unit in which differences of potential are measured. When we speak of the number of volts at any point in a circuit we really are referring to the number of volts of potential difference between that point and the reference point. In all of the instructions up to this point care has been

taken to specify not merely a potential or a number of volts, but to speak of potential differences—thus emphasizing the fact that mention of a potential always implies that it exists and is measured in relation to some other potential, or in relation to our reference potential.

Provided we keep in mind that we deal only with differences of potential between a reference point and some point which we are considering, there is no objection to speaking of the voltage of a point in a circuit—as of grid voltage, plate voltage, and so on. The word voltage always means the potential difference in volts between the grid, plate or other point, and our reference point—which may be the electron emitter in a tube, a terminal of an energy source, or some other point in the circuit being considered. In following pages, instead of always specifying potential differences in volts between points in a circuit, we frequently shall speak of only the voltage of some part, meaning the potential difference in volts between this part and a reference point.

While on the subject of different words which mean the same thing there is one more matter which should be mentioned. It is a method of specifying alternating electron flows and potentials, and direct electron flows and potentials. An alternating electron flow or potential periodically reverses its direction, while a direct electron flow or potential acts always in the one direction.

It is common practice in the electrical and electronic fields to speak of alternating electron flow as “alternating current,” to speak of alternating potential as an “alternating-current potential” or “alternating-current voltage,” also to speak of a direct or one-way electron flow as a “direct current,” and of a direct or one-way potential as a “direct-current potential” or a “direct-current voltage.”

Instead of writing out the words “alternating-current” when describing some action involving alternating electron flow we may employ the abbreviation “a-c.” Thus we may speak of an “a-c voltage” or of an “a-c electron flow,” meaning that the voltage or the electron flow is alternating. Instead of writing “direct-current” we may use the abbreviation “d-c.” We may speak of a “d-c voltage” or of a “d-c electron flow” when the voltage or the electron flow acts always in the one direction.

In our work to follow we shall employ the word voltage and the abbreviations a-c and d-c when they fit into our descriptions. This is chiefly for the purpose of simplifying the explanations and to acquaint you with these terms as they ordinarily are employed.

CONTROL CHARACTERISTICS FOR SHIELD GRID TUBES—

Fig. 135 shows a typical control characteristic for a shield grid thyratron. As you will recall, a control characteristic is a curve showing control grid critical voltages at which the tube breaks down with various plate voltages. This characteristic of Fig. 135 is for the tube with its shield grid connected directly to the cathode, so that the shield grid is at zero voltage with reference to the cathode. The relations between critical control grid voltages and plate voltages are similar to those for a three-element thyratron.

If the shield grid is not maintained at zero voltage with respect to the cathode, it may be made either more positive than the cathode or else more negative than the cathode. Each change of shield grid voltage produces a different control characteristic. Fig. 136 shows control characteristics for a shield grid thyratron with the shield grid at several potentials with reference to the cathode. Curves are shown for shield grid potential differences of five volts and two volts positive, for zero potential, and for one, two and three volts negative.

Fig. 136 shows that, for any given plate voltage, the control grid critical voltage for breakdown becomes more negative as the shield grid is made more positive, and that the breakdown voltage for the control grid becomes less negative (or more positive) as the shield grid voltage is made more negative (or less positive) with reference to the cathode. For example, with a plate voltage of 500 volts, breakdown occurs with the control grid about eight volts negative with the shield grid five volts positive, but with the shield grid at zero volts we have breakdown with the control grid only four and one-half volts negative.

Fig. 137 shows clearly the effect of shield grid voltage on the breakdown voltage or control grid critical voltage. Here it is plain that as the shield grid is made less positive or more negative the control grid critical voltage becomes steadily less negative or more positive.

The shield grid voltage may be varied to produce different control characteristics during normal operation of a thyratron when such changes are required, but it is more common to vary the shield grid voltage only to compensate for differences between an original tube and a replacement, or to compensate for changes of performance that occur as a tube ages while in use. Changes of shield grid potential may be employed also to compensate for small changes of control characteristics that occur when more or less

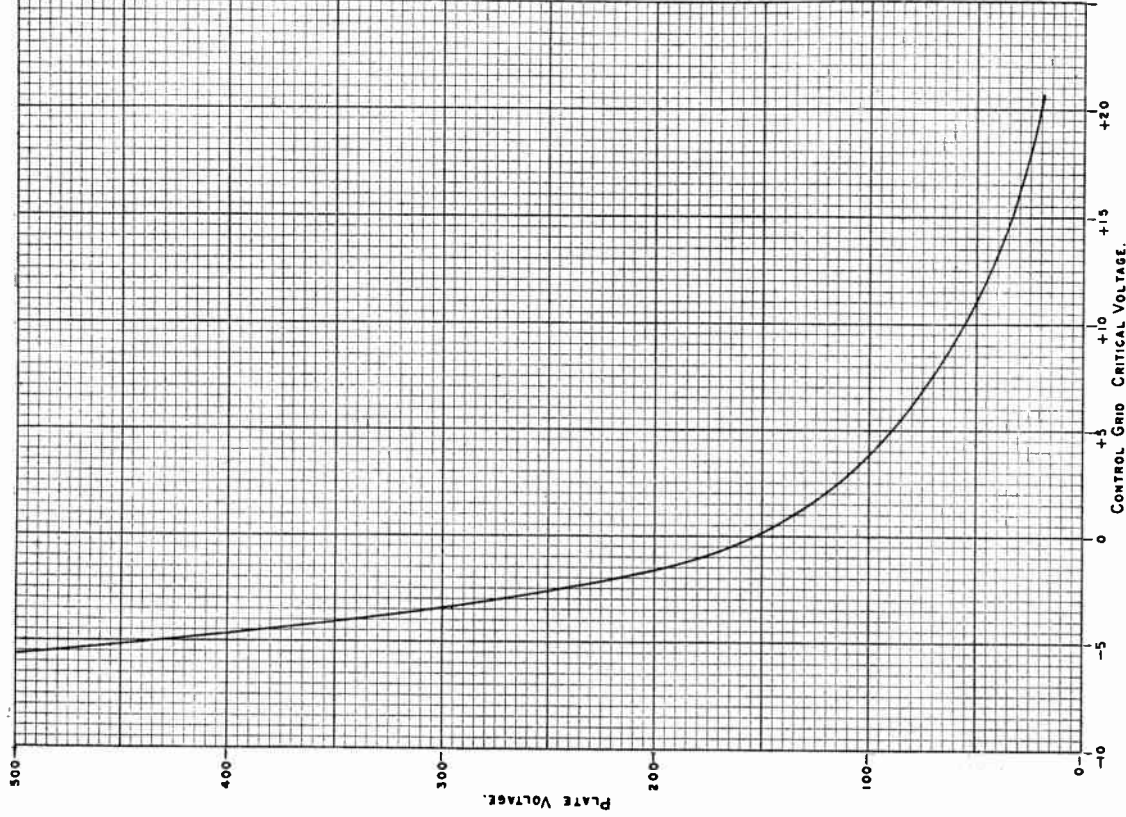

Fig. 135. A control characteristic showing typical operation of a shield grid thyatron with the shield connected directly to the cathode.

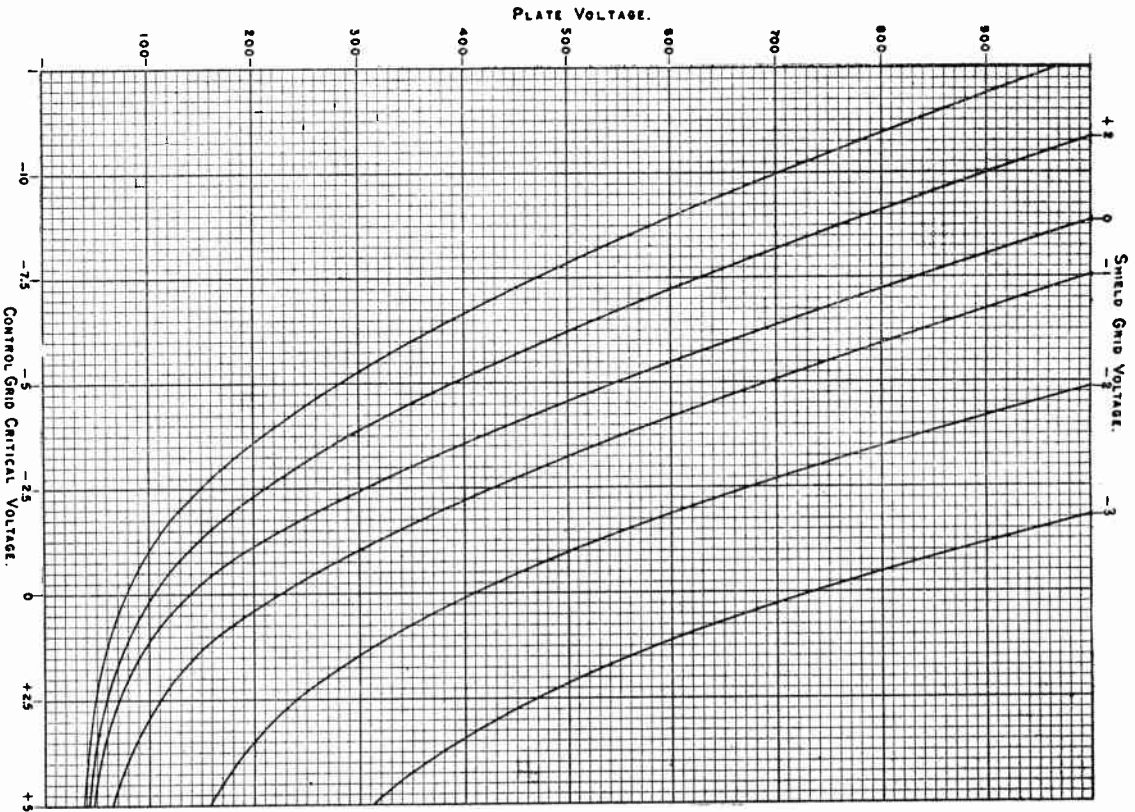

Fig. 136. A group of control characteristics for a shield grid thyatron operated with the shield grid at various potential differences with reference to the cathode.

resistance is used in the grid circuit of the tube. It always should be remembered that with a shield grid thyatron the plate voltage at which the tube breaks down depends on both the control grid voltage and the shield grid voltage, not on either one alone.

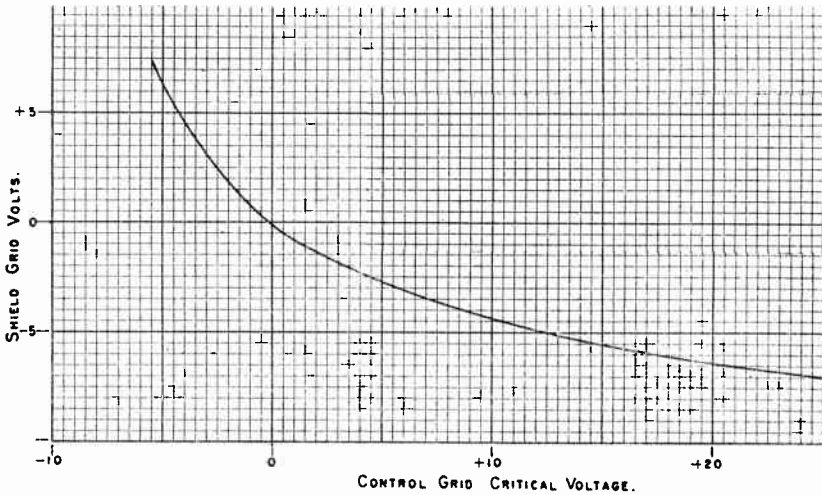

Fig. 137. The effect of varying the shield voltage on the critical voltage for breakdown in a typical shield grid thyatron.

THYRATRON OPERATION—With reference to the practical operation of all types of thyatrons there are several points which should be noted. First, the critical voltages for the control grid will undergo some change as a tube ages in service, will vary with temperatures of mercury-vapor types, and will vary between tubes of the same type. Further variation comes about because of normal fluctuations in power supply voltages, and because of changes in actual values of circuit resistances. Because of these things, thyatron circuits are designed to allow adjustment of grid voltages by a few volts either way from the value that would be average for the performance desired.

Tubes which break down and start conducting while the control grid is negative with reference to the cathode take less power in the grid circuit than do tubes with which the control grid is positive at breakdown. Therefore, the negative control tubes are usually preferred for circuits in where the control grid must be operated from a high resistance high impedance source. Impedance is the opposition to alternating electron flow offered by combinations of resistance, inductive reactance and capacitive reactance.

With any circuit in which the control grid may become positive with reference to the cathode, while the plate is negative, the positive grid voltage should be kept as low as possible. When the peak grid voltage is more than 10 or 15 volts more positive than the cathode potential there may be ionization between cathode and positive grid, just as between cathode and positive plate during normal operation.

The closer the actual control grid voltage may be kept to the critical voltage the less change of grid voltage is needed to bring about breakdown. Then the tube responds to small changes of grid voltage, or is highly sensitive to small changes in the controlling forces. Such sensitivity is, of course, desirable, but it means that any small external voltage that gets into the grid circuit may cause the tube to break down when it should not conduct, or may prevent breakdown when conduction should occur.

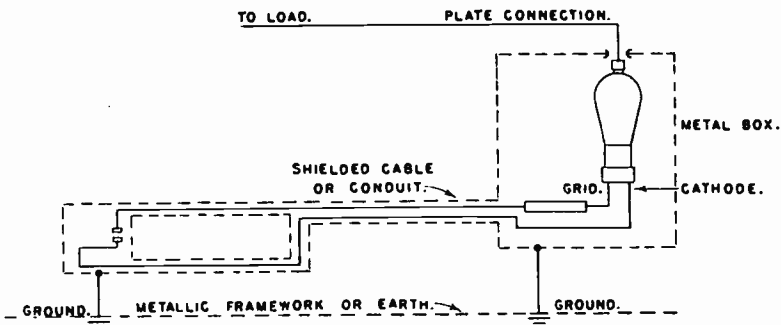

Fig. 138. The grid circuit for the thyatron, also the tube itself, may be protected against external electric and magnetic fields by a grounded metallic enclosure.

To prevent external voltages or electric fields from affecting a highly sensitive grid circuit the tube itself frequently is enclosed by a metallic housing that is grounded, and the grid circuit wiring may be made with shielded cable or run in metallic conduit that is grounded. The principle of such a shielded grid circuit is illustrated by Fig. 138.

A ground connection is a connection to the metallic framework or supports of electronic apparatus. With all parts of the framework in metallic contact with one another all these parts must remain at practically the same potential. The electrical resistance of such a metallic structure is so low that any difference of potential would immediately cause electron flows which would equalize the potentials. With a framework at uniform potential, any parts

of the apparatus that are connected to the framework must remain at the same potential as the framework, and must themselves be at uniform potential.

The framework, or metallic boxes and conduit, sometimes are connected to cold water piping or to other building structure members that extend from the building into the surrounding earth or into the ground. Because the earth itself is everywhere at practically the same potential, any parts electrically connected to it are maintained at uniform potential or at ground potential.

When external electric and magnetic fields reach a grounded metallic enclosure any emf's that are induced by these fields appear chiefly in the enclosing metal or in the shield rather than in wiring conductors that are enclosed. Thus the enclosed conductors are almost completely protected from outside influences.

CIRCUIT CAPACITANCES—Several times we have mentioned that the capacitance existing between the plate and control grid inside the tube allows changes of plate potential to affect control grid potentials. This grid-plate capacitance is made small by suitable design of tube parts. In three-element thyratrons the grid-plate capacitance may be from two to five micro-microfarads. The shield grid in four-element thyratrons may reduce the grid-plate capacitance to about one-fifth micro-microfarad.

The advantage of low grid-plate capacitance inside the tube may be lost by capacitance between external wires or conductors which are connected to the grid and to the plate. As shown in Fig. 139, two insulated conductors running close to and parallel with each other form a capacitor. The conductors act as the plates of the capacitor, while

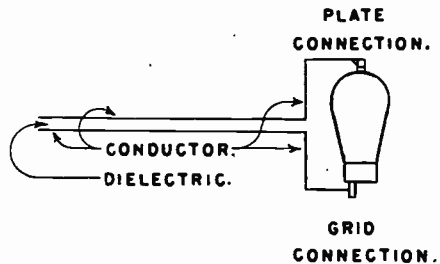

Fig. 139. Parallel conductors close together act like a capacitor.

insulation and air space separating the conductors act as the dielectric. Such external wiring capacitance becomes greater as the conductors are run closer together and as they are run for greater distances while close together.

If the grid circuit is protected with grounded shielding, as in Fig. 138, the capacitance between the grid wiring and any other wiring outside the shielding is negligible. If the grid circuit is not

shielded, the plate wiring and grid wiring should be kept well separated and not run parallel for distances greater than are necessary.

Sudden changes of voltage applied to the control grid will raise the grid voltage to the critical point and cause the tube to break down if the tube is being operated near the critical point. Such sudden changes sometimes result from waveforms that depart greatly from a sine wave; these changes tend to be very abrupt rather than gradual. The effect of such waveforms may be avoided and the grid voltage maintained relatively constant by connecting a capacitor between the control grid and the emitter terminals as shown in Fig. 140.

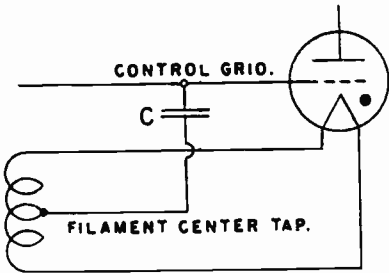

Fig. 140. Bypass capacitors may be used between the control grid and cathode to prevent electron surges in the plate circuit when there are sudden slight changes of grid potential difference.

The capacitor is charged by the sudden changes of potential, thus effectively absorbing the charges, and then discharges back into the grid circuit.

PROTECTIVE RESISTANCES—In the plate circuit of every thyatron there must be enough resistance to prevent the electron flow from exceeding the limit for the tube after the tube breaks down. As we have learned, the voltage drop through the tube itself becomes very small after breakdown, so resistance in the external plate circuit must be depended on to limit the electron flow.

Electron flow in the grid circuit must be limited to the maximum permitted for the tube being used. This limit value is specified in the tube ratings. Electron flow usually is limited by a resistor having a resistance between ten thousand and fifty thousand ohms connected in series with the grid terminal, unless there is some other positive means for preventing excessive grid current.

BASE AND CAP CONNECTIONS—Filaments, heaters, cathodes, plates, control grids and screen grids are connected in many different ways to pins or prongs on the base and to metal caps on

the bulb of thyatron tubes. Some of the more common arrangements are shown by Fig. 141. Pins or prongs are shown in their relative positions around the bases, while cap connections are indicated on a partial outline of the bulb above the base. Terminal markings refer to the connected electrodes of the tubes.

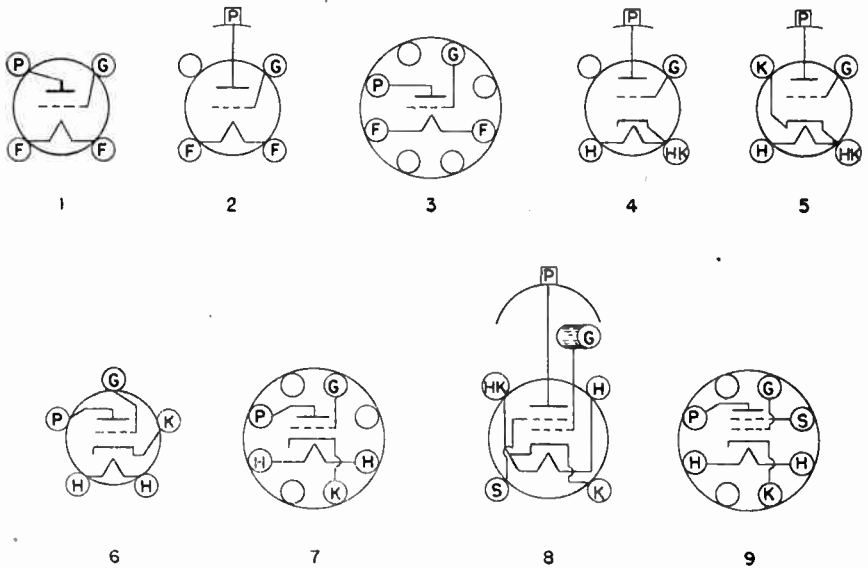

Fig. 141. Connections of thyatron electrodes to base pins and to caps on the bulb. Terminal symbols are: F, filament. G, control grid. H, Heater. HK, heater and cathode. K, cathode. P, plate. S, shield grid.

Types shown at 2, 4, 5 and 8 have the plate connected to a metal cap on the top of the glass bulb. The type shown at 8 has its control grid connected to a cap on one side of the bulb. Tubes shown by diagrams 6, 7 and 9 have their cathodes brought out to a separate pin on the base. Those at 4, 5 and 8 have the cathode connected to the heater internally, so that one of the base pins provides an external connection to the cathode and heater. The two tubes at 8 and 9 are shield grid types. All others are three-element types, or triodes.

CATHODE AND FILAMENT RETURNS—In Fig. 142 are shown by arrows the directions of electron flow through a tube and through its plate and grid circuits. Electron flow from cathode or filament to the plate must pass through the load and all other parts of the plate circuit, then must return to the cathode or filament. Any current from cathode to grid must pass through

all the parts in the grid circuit, then must return to the electron emitter. The connection at which all electron flow from all the external circuits finally comes back to the cathode or the filament of the tube is called the **cathode return** or the **filament return**.

In Fig. 123 it was shown that the return connection to the electron emitter may be directly to a separately heated cathode, to the center tap of a filament transformer, or to a center tapped

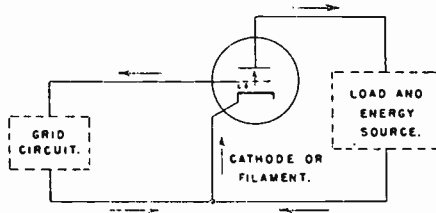

Fig. 142. All electron flows through the grid and plate circuits, and through a shield grid circuit if used, must return to the cathode or filament.

resistor connected across an untapped filament transformer. Fig. 143 illustrates certain special cases of emitter returns to which the following notes apply:

A. With direct potential applied to a filament, the return is made to the negative filament terminal.

B. Sometimes a center-tapped transformer is available, although the center tap is not needed. In this case the return should **not** be made to the center tap of such a transformer.

C. If separately heated cathode is connected internally to one end of the heater and there is also a separate base pin for the cathode only, the return should be made to this cathode pin terminal. (See diagram 5 and 8 of Fig. 141.)

D. The tube may have a center tapped filament, with a base pin for this center tap. The return should be made to such a filament center tap.

E. The cathode sometimes is connected to a center tap on the heater transformer, with the return made to this connection.

F. In some circuits there is a resistor between the cathode and a connection to the heater. Electron flow through this resistor should be in such direction as to make the heater negative with reference to the cathode, thus lessening the chance of electron mission into the heater.

G. When two or more tubes are connected in parallel the return should be made to the same pin terminal on all tubes, thus helping to insure uniform electron emission in all.

With the return to the negative end of the filament, as at A, the grid is made negative with reference to the average voltage of the filament, whereas the grid would be positive were the return

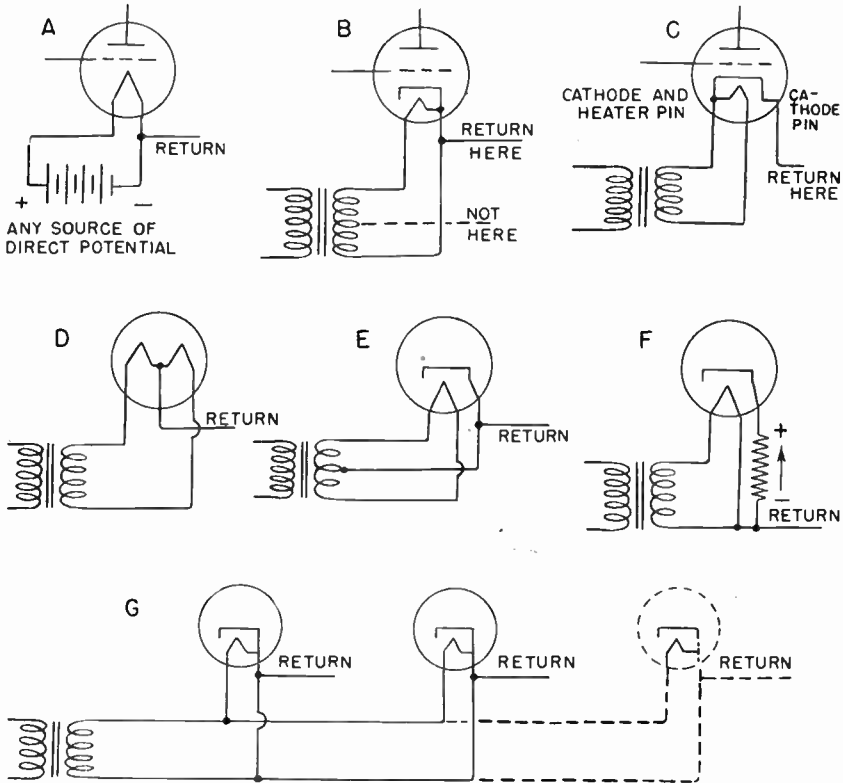

Fig. 143. Points at which returns should be made with various arrangements of filament, heater and cathode.

to the positive side of the filament. We must consider that the voltage of the filament, considered as a whole, is the average of the voltages at its ends. With a return to the negative end of the filament the grid voltage is less than the average voltage of the filament, while a return to the positive end would make the grid voltage higher or more positive than the average.

As at C, the return always should be made to a cathode pin regardless of whether or not the heater is internally connected

to the same pin. This insures grid and plate voltages with the cathode potential as the reference point, rather than with one end of the heater, which may be at a voltage different from that of the cathode.

A return to the tap of a center-tapped filament, as at D, insures that grid and plate voltages are with reference to the average voltage of the filament, which, of course, exists at the center of the filament.

Connecting the cathode and the return to the center tap of the heater winding, as at E, insures a zero average potential difference between the cathode and the heater, since the average voltage of the heater is the same as that at the center of its transformer winding. Zero potential difference usually is desirable between the cathode and heater.

With the heater made negative with reference to the cathode, as at F, none of the electron emission from the cathode will be drawn to the heater, although electrons then might pass from the heater to the relatively positive cathode. This practice is contrary to that in some high-gain vacuum tube circuits for radio receivers, where the heater is made slightly positive with reference to the cathode so that fluctuating emission due to alternating potential in the heater cannot be drawn to the cathode circuits and produce an audible "hum" after being amplified.

If the returns are to various pin terminals instead of always to the same pin as at G, a return sometimes might be to the negative end and again to the positive end of a filament, or sometimes might be directly to a cathode and again through a heater to the cathode.

Chapter 10

THYRATRON-OPERATED CONTROLS

Switch Contact Controls — Saturable Reactors — Saturating the Reactor — Voltage Regulator — Lamp Dimming — Phase-shift Controls — Motor Controls — Types of Motors — Speed and Reversing Controls — Generator Voltage Regulation.

Thyratrons are used in so many kinds of industrial and commercial control devices that it would be impossible even to list all the applications, and new uses are being found every day. However, when you understand the operating principles of thyratrons themselves, and understand the general laws that govern electron flow in conductors, resistors and other circuit elements, it is not difficult to determine from a circuit diagram how the apparatus is supposed to act.

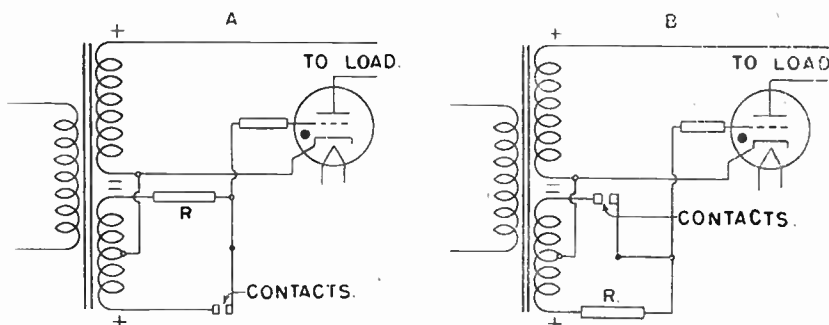

Fig. 144. A simple thyratron-controlled circuit in which there is trigger action. At "A" the thyratron conducts no electron flow until the contacts are closed. At "B" there is conduction so long as the contacts are open, and it is stopped by closing the contacts.

One of the simplest of thyratron-operated controls is shown by Fig. 144. The plate-cathode circuit, which includes the load, is furnished with alternating potential and electron flow from the upper secondary winding on the transformer. A-c grid voltages are furnished by the lower secondary winding. Connections to the two secondary windings are made in such manner that with the line through the load to the plate positive, the line to the control grid through resistor R is negative. With the contacts separated,

as shown, the control grid is thus held so far negative that the thyatron does not break down and there is no electron flow in the load. When the contacts are closed the control grid of the tube is connected directly through these contacts to the end of the grid secondary that is positive while the plate is positive. Then the tube breaks down and allows maximum electron flow through the load.

If the positions of the contacts and resistor R are interchanged, as at **B** in Fig. 144, the thyatron will conduct electron flow for the load so long as the contacts are separated, and will stop the flow when the contacts close. The tube conducts with the contacts open because then the control grid is connected through resistor R

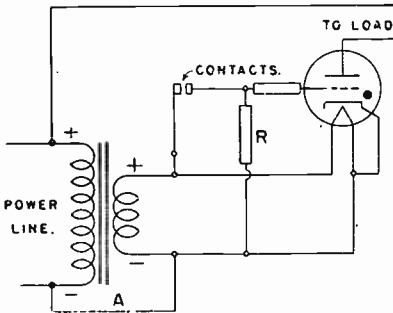

Fig. 145. A contact-operated thyatron control circuit in which the plate and load circuit is connected directly to the power line as the source of high potential.

to the side of the grid winding that is positive while the plate is positive. Conduction is stopped when the contacts close, because then the control grid is connected directly to the end of the grid winding that is negative while the plate is positive.

In apparatus such as shown by Fig. 144 the contacts may be closed and opened by a thermostat which responds to changes of temperature in any substance, by a bellows which expands and contracts with changes of gas pressures or liquid pressures, by

motion of any part of a machine or other object, or by any of dozens of other control devices. The load might be the coil of a relay which opens and closes a power circuit, it might be a magnetically operated counter, a resistor used for heating, a signal lamp, an alarm bell, or anything else which is to be controlled in accordance with whatever force operates the contacts.

Fig. 145 shows another simple control circuit. Here the transformer has a secondary winding only for the thyatron heater. High voltage for the load is obtained by connecting the load directly to one side of the power line, and through the thyatron plate and cathode, and connection **A**, to the other side of the power line. With the contacts separated, the thyatron control grid is connected through resistor R to the end of the secondary winding that is negative while the plate is positive, so the tube does not break

down and there is no electron flow through it and the load. With the contacts closed the control grid is connected through them to the end of the secondary winding that is positive while the plate is positive. Then the tube breaks down and conducts electron flow for the load.

Reversing the positions of the contacts and resistor R in Fig. 145 will reverse the operation of the control. Then there will be no electron flow through the load while the contacts are separated. As with other simple controls, the contacts may be actuated by any force that is to control the operation, and the load may be anything which may be operated by electron flow through the thyatron.

SATURABLE REACTORS—One of the simplest, yet most efficient, devices for regulating alternating electron flow is called a saturable reactor. The reactor consists of nothing more complicated than an iron core, much like that for a transformer, on which are several coils or windings. The a-c electron flow to be regulated passes through one set of windings, and a d-c electron flow is passed through the others. A very few amperes of d-c electron flow will control tens of thousands of watts of power in the alternating circuit. The few amperes of d-c flow are regulated by a thyatron, and the grid of the thyatron may be energized by any small force in accordance with which the a-c power is to be regulated.

Saturable reactors and thyatrons are used for control of heating in ovens for heat treating, annealing, and chemical processes, in furnaces, boilers, steam superheaters and air heaters. Saturable reactors and thyatrons are used also for maintaining constant voltage on a power supply, for the dimming of lights in theatres and other public places, and for complete speed control of direct-current motors operated on alternating power lines.

The easiest way to understand the action of a saturable reactor will be to build one up step by step as we examine the relations between electron flow and magnetic lines of force. When there is a flow of electrons through the turns of a coil of wire the coil becomes a magnet, an electromagnet, so long as the electron flow continues. The coil will attract iron and steel just as will any other magnet, and if the coil is freely suspended it will turn until one end points north and the other south, just as does the magnet in a compass.

In the upper diagrams of Fig. 146 is represented a coil of a few turns through which there may be an electron flow when connected to an energy source. Just below the coils is shown a part of an alternating cycle during which electron flow first is zero,

then increases, decreases, and returns to zero. This represents the electron flow in the coil. While the rate of electron flow is increasing, magnetic lines of force arise from the turns in ever increasing number and expand outward from the coil and its center, cutting through the turns of the coil on the way. As electron flow decreases in rate, the magnetic lines fall back toward and into the coil, and in so doing they cut across the turns in a direction the opposite of that during their expansion.

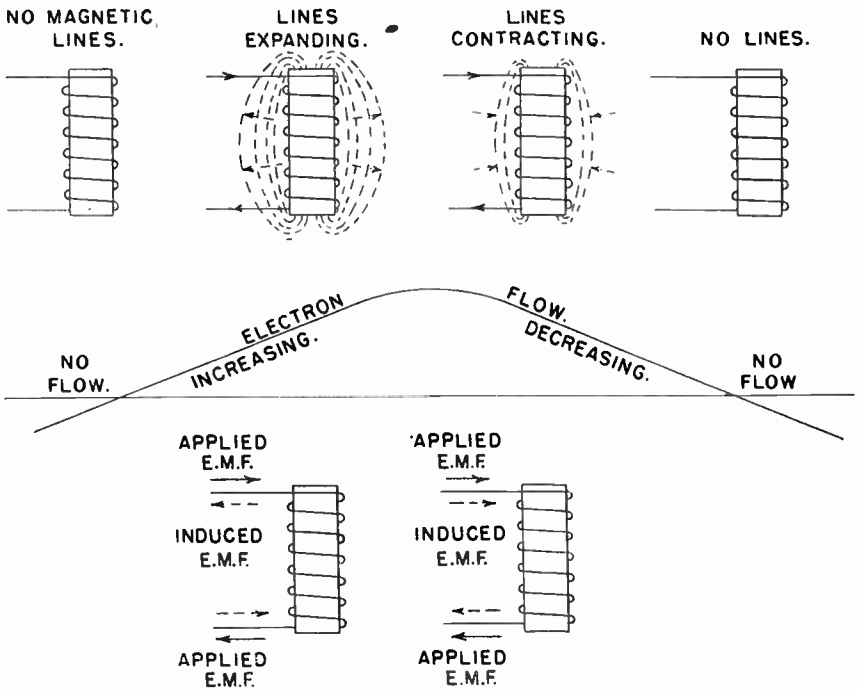

Fig. 146. Magnetic lines expand and contract through the turns of a coil as electron flow increases and decreases. The cutting of the magnetic lines through the coil turns induces emfs that oppose both increase and decrease of electron flow in the coil.

When magnetic lines of force cut through a conductor they induce an emf in the conductor. The direction of the induced emf depends on the direction in which the lines cut the conductor. In the lower diagrams of Fig. 146 it is shown that the induced emf opposes the change in applied emf while the rate of electron flow is increasing, and that the induced emf also opposes the change in applied emf while the rate of electron flow is decreasing. Thus every change in the rate of electron flow is opposed by this

induced emf. As has been mentioned before, this opposition to all change of a-c electron flow is the kind of opposition that we call inductive reactance.

It is assumed that the direction in which magnetic lines of force flow through a coil and return around the outside of the coil is as shown by Fig. 147. If you were to look lengthwise of the left-hand coil, and at its lower end, the direction of electron flow around the turns of the coil would be counter-clockwise and magnetic lines of force would be flowing away from you through the center of the coil. Looking similarly at the right-hand coil, the electron flow would be clockwise, and the magnetic lines of force would be flowing toward you through the center of the coil.

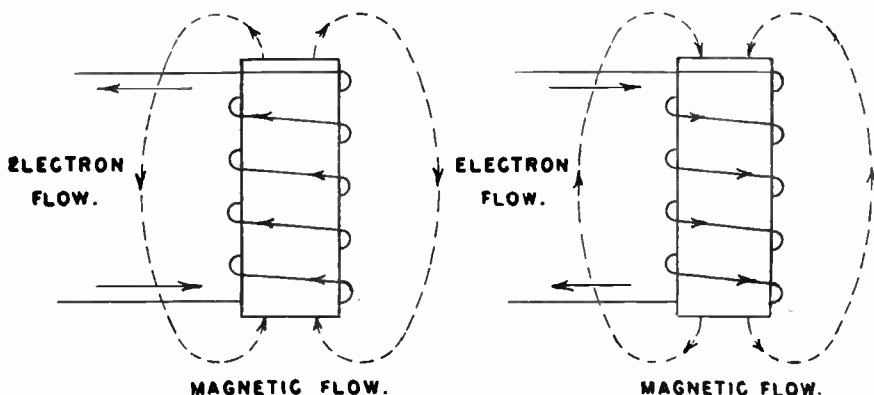

Fig. 147. The assumed directions of magnetic lines of force in relation to the direction of electron flow around the turns of a coil.

It is only with great difficulty that magnetic lines of force pass through air and through every other substance except iron or steel. Consequently, with coils such as those of Figs. 146 and 147, where the lines of force pass through air inside and around the coil, it would take large rates of electron flow to produce an appreciable flow of magnetic lines. There would be only a relatively few magnetic lines cutting the coil turns, as at the top of Fig. 146, and the inductive reactance of the coil would be small.

In Fig. 148 we have wound our coil on a core made of iron or of soft steel. The opposition of iron or steel to flow of magnetic lines is so small that hundreds of times as many lines will flow with an iron or steel core as with any other substance inside the coil. Consequently we have in Fig. 148 a greatly increased flow of magnetic lines with the same coil, the same rate of electron

flow, and the same rate of change or the same frequency of the alternating flow. Note that the direction of magnetic flow in relation to the direction of electron flow in the coil is the same in Figs. 148 and 147.

In Fig. 149 we have placed a second coil on the other "leg" of the iron core. Note how the two coils or windings are connected together so that both produce magnetic flow in the one direction around the core. Coils and cores such as shown by Figs. 148 and 149 are called reactors when they are used to provide inductive reactance to alternating electron flow.

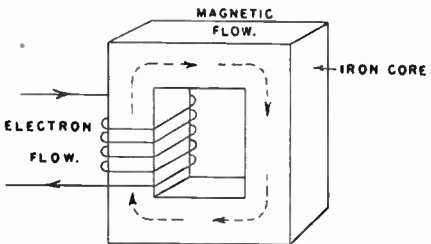

Fig. 148. Placing a coil or coils on a core of iron or steel greatly increases the number of magnetic lines, the inductance, and the inductive reactance.

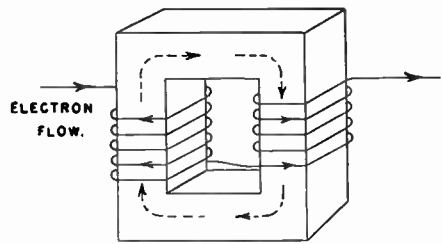

Fig. 149. Two coils on a single core may be connected together so that both produce magnetic flow in the same direction.

Inductive reactance in ohms increases directly with increase of frequency in cycles, with cross-sectional size of the core, and with "permeability" of the core, which is a measure of how freely the core material permits flow of magnetic lines through it. Inductive reactance increases with the square of the number of turns in the coil or winding. Usually there are many hundreds of turns. Inductive reactance varies inversely with the length of the path followed by magnetic lines in going around the core; meaning that the longer this path the less is the reactance.

SATURATING THE REACTOR—Now, keeping in mind that inductive reactance depends on opposing induced emf's (shown by Fig. 146), and that the strength of these emf's depends on the rate at which magnetic lines cut the turns of the coil, we may examine the "saturation curve" of Fig. 150. This curve shows the relation between amperes of electron flow in a winding and the resulting number of magnetic lines produced in a particular core material. Since the curve shows the effect of amperes of electron flow on the number of magnetic lines it shows also how

electron flow in the winding will affect inductive reactance of the winding.

Assume that we have a change of five amperes in the rate of electron flow, that the flow varies from zero to five amperes as it might with an a-c electron flow. The curve of Fig. 150 shows that there will be no magnetic lines with zero electron flow, and 5,500 lines with five amperes. This change of five amperes causes a change of 5,500 lines. This change of 5,500 magnetic lines of force will determine the inductive reactance opposing the five-ampere change of electron flow.

Supposing that it were possible to have the same five-ampere change of electron flow, but that it might be from five to ten amperes, then from 10 to 15 amperes, and so on—the same change, but at higher and higher levels. Here are the changes of magnetic lines that would accompany these five-ampere changes of electron flow:

Electron Flow amperes	Magnetic Flow lines	Change of Magnetic Flow
0 to 5	0 to 5500	5500 lines
5 to 10	5500 to 11000	5500 lines
10 to 15	11000 to 14300	3300 lines
15 to 20	14300 to 16250	1950 lines
20 to 25	16250 to 17350	1100 lines
25 to 30	17350 to 17800	450 lines

The higher the level at which we have our fixed change of electron flow the smaller is the change in magnetic lines. Consequently, the higher the level the less will be the inductive reactance. Small rates of electron flow in the coil cause rapid increase of magnetic lines, but as the electron flow becomes greater the rate of increase of magnetic lines becomes less and less. Finally we reach a point where large changes of electron flow cause little increase of magnetic lines. Here the core iron is said to be saturated. The curve of Fig. 150 shows where we approach and reach saturation.

To get ready to use the thyatron for controlling the degree of saturation and the reactance to a-c electron flow we shall now put an extra "leg" in the iron core and place the windings for alternating electron flow on the two outer legs, as in Fig. 151. At an instant when direction of a-c flow is as shown by arrows on the coil conductors, magnetic flow from the two windings is as shown by arrows in the core. Magnetic flow from one winding goes one

direction through the center leg while magnetic flow from the other winding goes in the opposite direction. What really happens is that the two magnetic flows neutralize each other so far as the center

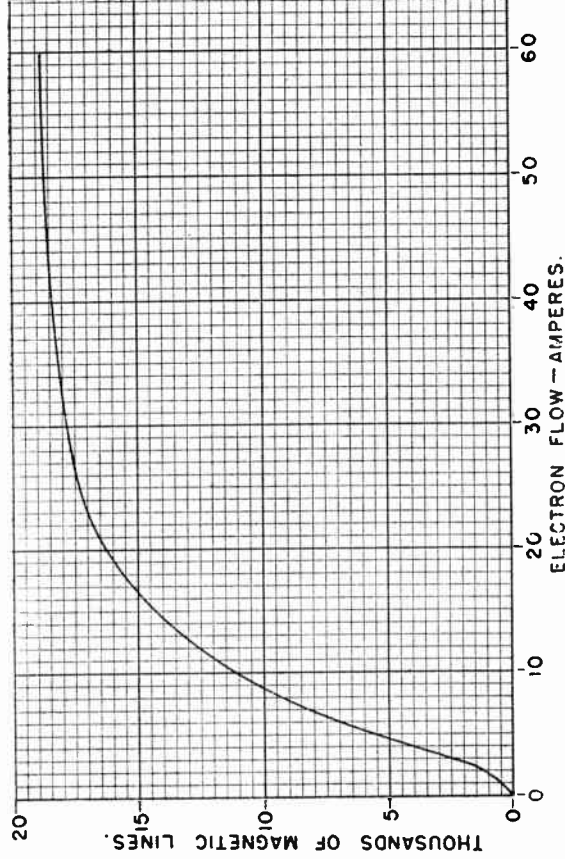

Fig. 150. The number of magnetic lines increases with electron flow through the winding, but finally there is a point at which additional electron flow causes little increase in magnetic lines.

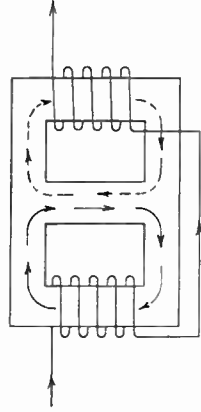
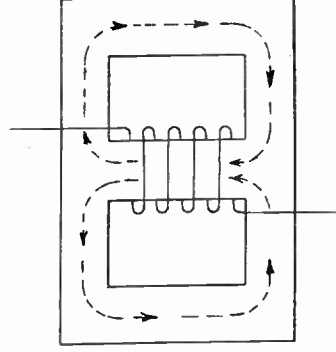

Fig. 151. Magnetic flows are in opposite directions in the center leg, so they neutralize each other.

leg is concerned and in this leg there is practically no magnetic flow due to a-c electron flow in the two windings.

The next step is to place a winding on the center leg, as in Fig. 152. Through this winding we shall send a d-c electron flow from



DIRECT ELECTRON FLOW.

Fig. 152. Magnetic flow produced by electron flow in a winding on the center leg may saturate the core.

a thyatron. Magnetic lines from the center winding flow through the center leg and through both outside legs, so if we have enough d-c electron flow we may saturate the whole core and reduce the inductive reactance of the other windings to a very low value. If the direct electron flow is made very small, or is stopped altogether, we shall have the full amount of inductive reactance that is due to alternating electron flow. The direct electron flow simply raises the operating point on the curve of Fig. 150 to whatever number of magnetic lines results from this direct flow, while the changes of magnetic lines about this operating point result from the alternating electron flow.

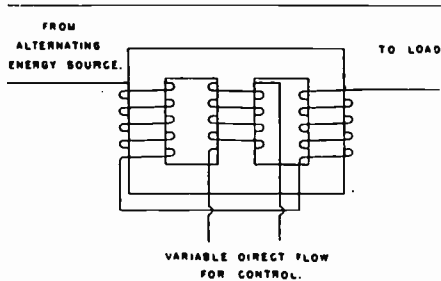

Fig. 153. The saturable reactor is connected in series with one side of the alternating-potential line, and reactance is controlled by varying direct electron flow in the center winding.

Finally, as in Fig. 153, we place all three windings on the three-legged core to form our saturable reactor. The reactor is connected in series with one side of the alternating line between the source and the load to be regulated, and is connected to the variable direct flow from a thyatron tube used for control.

VOLTAGE REGULATOR—Fig. 154 shows the principle of apparatus designed to maintain a practically constant voltage for a load when there are variations in voltage from the supply line. A saturable reactor in series with one side of the line to the load provides reactance which uses up any voltage above a certain minimum value which is to be supplied to the load. The reactor can only lower the line voltage, not raise it. Therefore, the load voltage always will be lower than the lowest voltage from the supply line.

The transformer primary is connected to the regulated side of the line, so secondary voltages will vary in accordance with changes of regulated voltage. Direct electron flow for the center winding of the reactor comes from the plate of the thyatron through the flow limiting resistor R-1, goes through secondary winding P, which furnishes the necessary voltage for the plate circuit, and returns to the cathode of the thyatron.

A phase-shift grid-control circuit consists of secondary winding G, adjustable resistor R-2, and inductor L. Voltage is applied to the thyatron grid through grid resistor R-3. Load voltage is set for a desired average value by adjusting R-2.

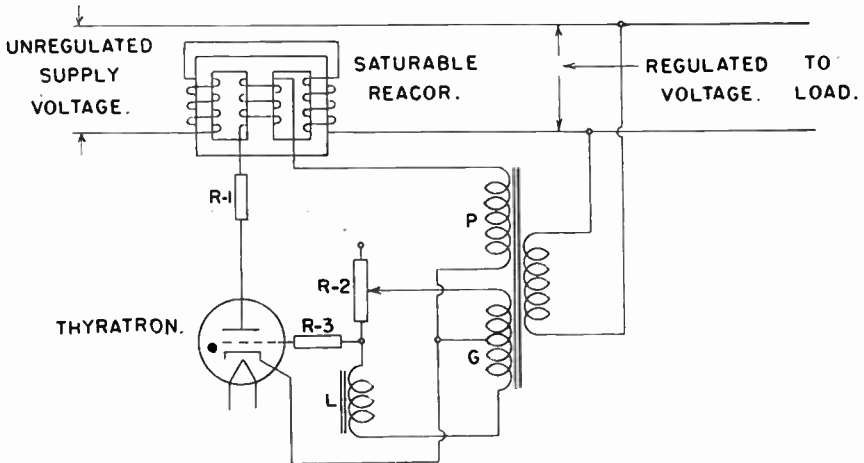

Fig. 154. A line-voltage regulator using saturable reactor and a thyatron.

If the regulated voltage increases, the resulting increase of potential difference across winding G on the transformer increases the amplitude of the negative grid voltage, thus allowing the thyatron to conduct during a shorter portion of each cycle and decreasing the average direct electron flow through the center winding of the reactor. This increases the reactance in series with the supply line and lowers the regulated voltage to compensate for the increase that started the control process. A drop in regulated voltage decreases the amplitude of the negative grid voltage, allows more flow through the center winding of the reactor, thus lessens the reactance and allows a rise of regulated voltage.

LAMP DIMMING—The elementary principle of a lamp dimming control is shown by Fig. 155. Here again we have a saturable reactor in series with one side of the a-c power line which furnishes

electron flow for the controlled lamps. The plate circuit of the thyatron includes flow limiting resistor R-1, the center winding of the reactor, secondary winding P which furnishes the necessary voltage, and the return from this winding to the thyatron cathode.

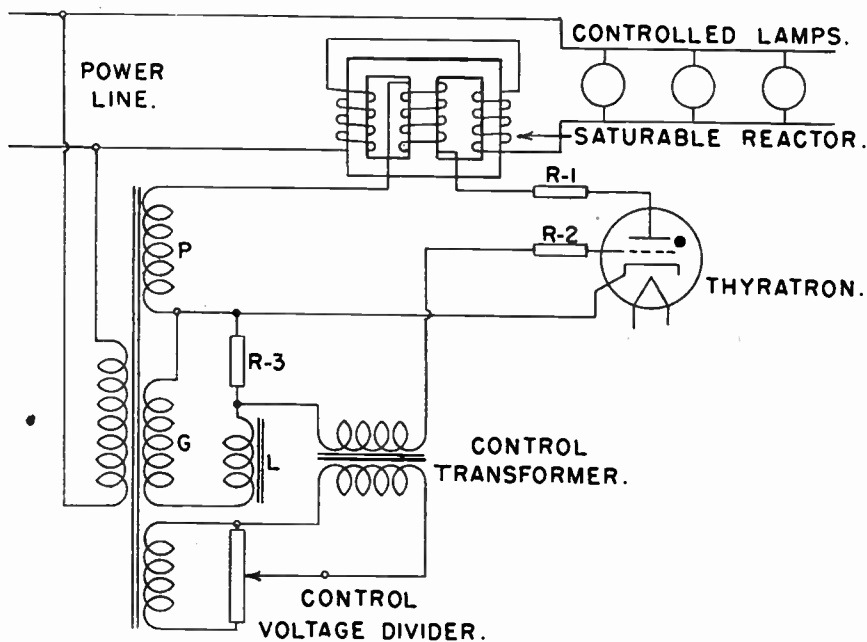

Fig. 155. A lamp-dimming control employing a saturable reactor and a thyatron whose control grid potential difference is regulated by a voltage divider.

Grid potential is applied through grid resistor R-2 from the phase-shift circuit consisting of secondary winding G, resistor R-3, and inductor L. Between the phase-shift circuit and the grid resistor is the secondary winding of a control transformer. Consequently, the voltage actually applied to the thyatron grid is a combination of the voltage obtained from the phase-shift circuit and that supplied by the secondary winding of this control transformer.

The primary winding of the control transformer is connected to a voltage divider across one of the windings of the main transformer. Adjustment of the slider of this voltage divider permits more or less voltage to be applied to the primary winding of the control transformer, and more or less voltage to appear across the secondary winding which is in series with the grid line.

Adjustment of the voltage divider changes the amplitude of the grid voltage. This alters the average d-c electron flow through the thyatron and the center winding of the reactor. Varying this d-c electron flow changes the reactance of the saturable reactor and thus changes the voltage applied to the controlled lamps.

Only a very small electron flow is needed in the voltage divider circuit to make relatively large changes in thyatron grid voltages. These changes of voltage cause changes of average d-c electron flow which are large in proportion to the grid potential changes. Moderate variation of direct electron flow in the reactor will make large changes of its reactance and will control large lamp loads. The illumination from incandescent lamps varies at a rate much greater than changes of voltage across the lamps. For instance, a 15 per cent reduction of voltage causes a drop of about 50 per cent in light.

The small electron flows and small voltages in the voltage divider of Fig. 155 and its connections permit this control unit to be made light in weight and small in size, and to be located at any convenient point remote from the remainder of the control apparatus.

PHASE-SHIFT CONTROL—A saturable reactor may be used in any control situation where it is necessary to provide an adjustable reactance or to have an adjustable inductance in an a-c circuit. Fig. 156 shows a saturable reactor as the adjustable inductor in a thyatron phase-shift circuit consisting of the reactor on one side, resistor R-1 on the other side, secondary winding G as the voltage source, and the connection from point A through grid resistor R-2 to the grid of the thyatron.

Changing the d-c electron flow through the center winding of the reactor shifts the phase of the control grid voltages and varies the electron flow in the plate circuit and the load. D-c electron flow for the reactor is furnished with a small vacuum type rectifier in series with the center winding of the reactor and secondary winding C. With the slider of adjustable resistor R-3 moved all the way to the left, electron flow from the rectifier plate goes from the slider through winding C and back to the rectifier cathode. With the slider moved all the way to the right the full resistance of R-3 is between the rectifier plate and winding C, consequently electron flow from the plate takes the easier path through the reactor coil and the small resistor to winding C. Thus movement of the slider on R-3 varies direct electron flow in the reactor coil from zero to the maximum provided by the rectifier system,

varies the reactor reactance from maximum to minimum, and shifts phase of the grid voltage for the thyatron. Adjustable resistor R-3 becomes the control for electron flow in the load circuit of the thyatron.

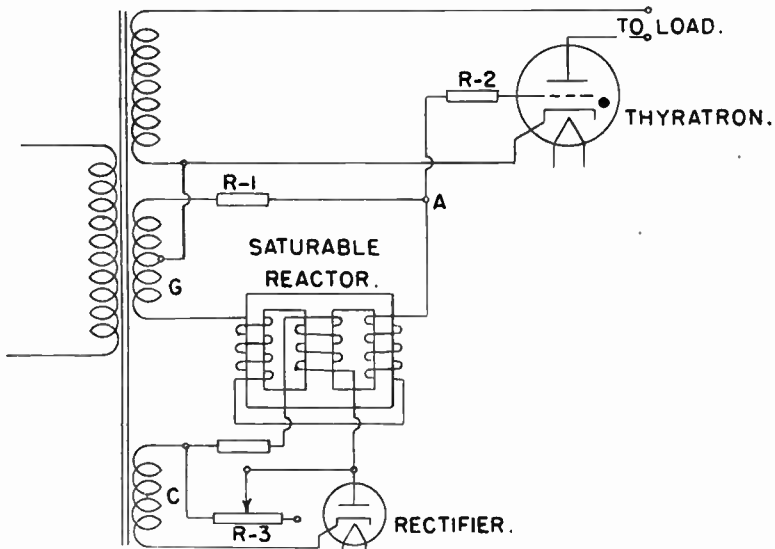

Fig. 156. A saturable reactor used as the adjustable inductance in a phase-shift circuit for a thyatron control grid.

MOTOR CONTROLS—Most power supply lines furnish a-c voltages and electron flow rather than d-c flow. Motors designed for operation on a-c voltage and electron flow are much simpler in construction and more rugged than motors designed for operation on d-c voltage and electron flow. Hence the greater portion of electric power has been obtained from a-c motors. However, the a-c motor, especially in the smaller sizes, is inherently a constant speed machine. To provide variable speeds for a-c motors requires apparatus that is rather costly and quite elaborate. The d-c motor has the great advantage of easily controlled speed over a wide range.

Thyratron tubes provide an economical means for operating d-c motors with rectified d-c electron flow obtained from a-c power lines. Grid control of the thyratrons permits furnishing variable voltages which will drive the d-c motor at variable speeds. The result of these abilities of the thyatron is that we have a great variety of speed controls allowing d-c motors to be operated from a-c lines.

The principal parts of a d-c motor are shown by Fig. 157. Fastened to the inner surface of the enclosing frame or shell are steel extensions called the field poles. On these poles are placed coils of insulated wire called the field windings. Inside the field poles is a cylindrical steel armature core, in lengthwise slots on which are coils of insulated wire called the armature winding. At one end of the shaft that carries the armature is a commutator consisting of many copper sections or segments insulated from one another, but connected to ends of the armature winding coils. Resting against the cylindrical surface of the commutator are brushes usually made from graphite or carbon. The armature

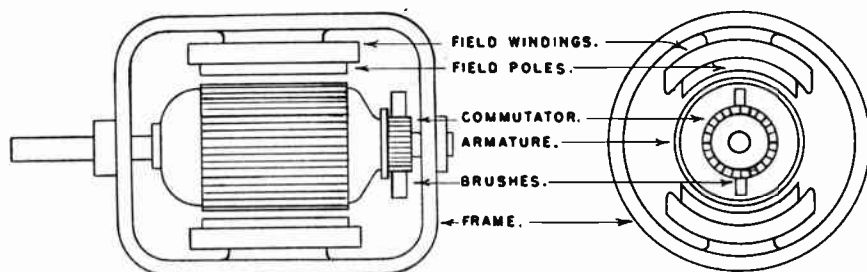

Fig. 157. The principal parts of an electric motor designed for operation with direct potential and electron flow.

winding is connected through the commutator and brushes to a source of d-c voltage. The field windings are connected in various ways to the same or a different source of d-c voltage.

The applied voltage causes a direct electron flow through the armature and field windings. Electron flow through the windings produces magnetic fields and flow of magnetic lines of force through the field poles, the armature core and the frame of the motor. Reaction between the magnetic fields of the armature windings and field windings causes the armature and its shaft to rotate. Rotation of the commutator under the ends of the stationary brushes maintains such connections between the voltage source and the armature winding as to insure continued rotation of the armature and shaft so long as the voltage is applied.

In wiring diagrams it is convenient to represent electric motors by their armature, brushes and field winding as in Fig. 158. In the type of motor called a shunt wound motor the armature and the field winding are in parallel across the energy source. Shunt is another name for parallel. In this type of motor the armature and field winding receive the same voltage.

In a series wound motor the field winding is connected in series with the armature, so that all the electron flow through one passes also through the other. A compound wound motor has both a shunt field winding and a series field winding, as shown in one of the diagrams.

Shunt wound motors are the ones most commonly used in constant speed and in controlled speed installations because this type naturally has good speed regulation with changes of load. Good speed regulation means that the speed tends to remain fairly constant as the motor is required to exert more turning force (torque) to drive a greater load.

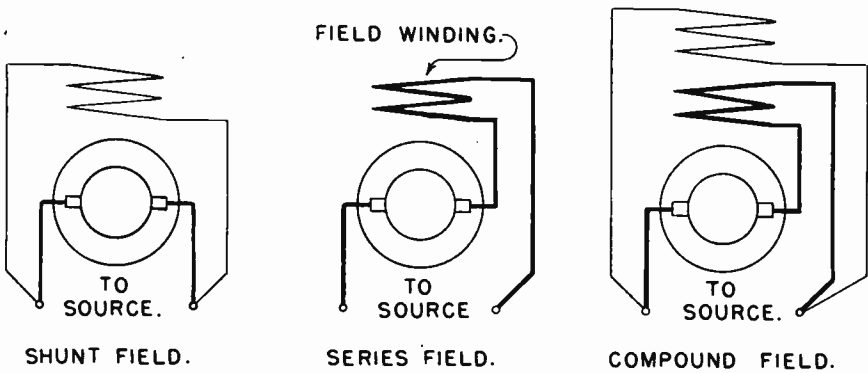

Fig. 158. The field winding and armature connections for three basic types of direct-potential motors; shunt wound, series wound, and compound wound.

The speed of a shunt wound motor may be varied in either or both of two ways, by reducing the voltage across the armature brushes and the electron flow through the armature, or by reducing the voltage and electron flow for the field winding.

Field voltage and electron flow might be reduced by placing an adjustable resistor in series with the field winding as at A in Fig. 159. With resistance in series part of the voltage from the source is used up in the resistance and less remains across the field winding. The lessened electron flow in the field winding causes the shunt wound motor to run at higher speed. The less becomes the field electron flow, within limits, the higher is the motor speed. With all resistance cut out the motor will run at the lower speed corresponding to source voltage for the field winding.

At B in Fig. 159 there is an adjustable resistor in series with the armature and the source voltage. As this series resistance is increased there is less voltage remaining across the armature,

there is less electron flow through the armature, and the motor speed decreases. As the armature resistance is cut out the motor speed increases, and with no resistance the speed is that corresponding to the voltage from the source.

It should be kept in mind that a reduction of electron flow through the shunt field will increase the motor speed, while a reduction of electron flow through the armature will decrease the motor speed. Most automatic speed controls for shunt wound motors operate to vary the electron flow in the field winding while maintaining a nearly constant voltage across the armature. Auto-

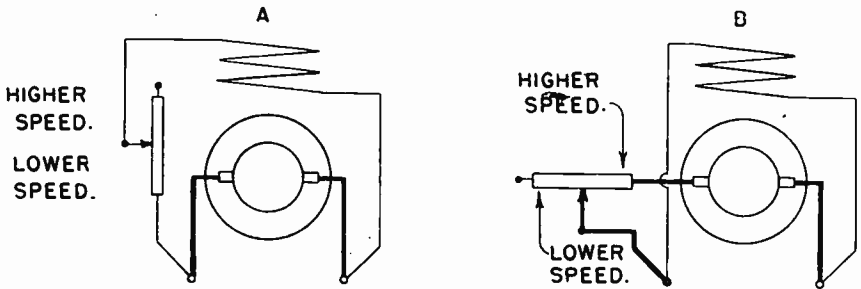

Fig. 159. The speed of a shunt wound motor may be controlled by varying the electron flow through the field winding, through the armature, or through both field and armature.

matic variation of voltage across the field winding and of electron flow in this winding then will maintain a nearly constant motor speed with reasonable changes of line voltage and of load on the motor.

The basic principle of all speed controls employing thyratrons is that any departure from the adjusted speed shall affect the control grid circuits of the thyratrons in such manner as to increase the voltage furnished to the motor. Some of these controls make use of the fact that armature electron flow increases almost directly with the torque or load increase which would tend to lower the motor speed. Change of voltage drop across a resistor carrying the armature current may be used to alter the grid voltage of the thyratrons as the potential drop increases with a slight decrease of motor speed.

Fig. 160 shows the elementary principle of a thyatron control for motor speed. Two thyratrons at the top of the diagram furnish d-c voltage and d-c electron flow for the field winding of the motor. Phase-shift control of these tubes will vary the field electron flow and the motor speed. The control may be adjusted for the desired

speed, then the speed may be automatically maintained by any suitable compensating action on the phase-shift.

The two lower thyratrons furnish d-c voltage and electron flow for the motor armature. The armature voltage may be maintained at constant value by automatically compensated adjustment of the phase-shift for these two tubes, or may be automatically varied to maintain constant speed or to change the speed of the motor.

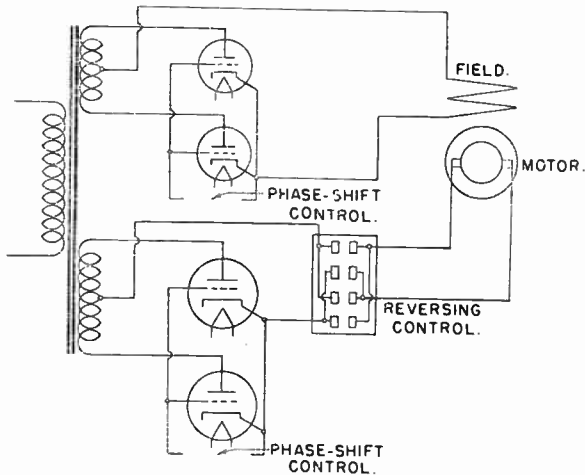

Fig. 160. The elementary principle of one type of thyatron control for speed of a shunt wound motor. One pair of thyratrons connected in a full-wave rectifying circuit furnishes electron flow for the motor field. Another pair, also connected full-wave, furnishes electron flow for the armature.

The reversing control of Fig. 160 is shown in more detail by Fig. 161. The direction of rotation of the armature in a d-c motor may be reversed by reversing the direction of electron flow through either the armature or the field, but if the direction of electron flow is reversed through both armature and field at the same time, the motor will run in the same direction as before. With the upper two pairs of contacts closed in Fig. 161 electron flow from the thyatron circuit passes as shown by arrows through the armature from left to right. We may assume that this causes forward rotation. With the upper pairs of contacts opened and the two lower pairs closed, electron flow through the armature is from right to left, and would cause a reversed direction of rotation. With

all pairs of contacts open there would be no electron flow through the armature, and the motor would be stopped. Thus these contacts may act for starting, stopping and reversing the motor.

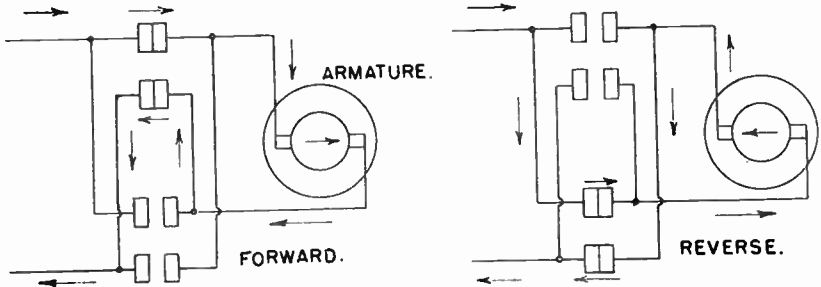

Fig. 161. How one type of reversing control reverses the direction of electron flow through the motor armature.

A thyatron reversing control for small shunt wound motors is shown by Fig. 162. With the switch above the two thyratrons in its forward position, as shown, electron flow is in the direction shown by arrows. This flow is from the lower secondary winding of the transformer through the motor armature from left to right, through the left-hand thyatron and back to the transformer

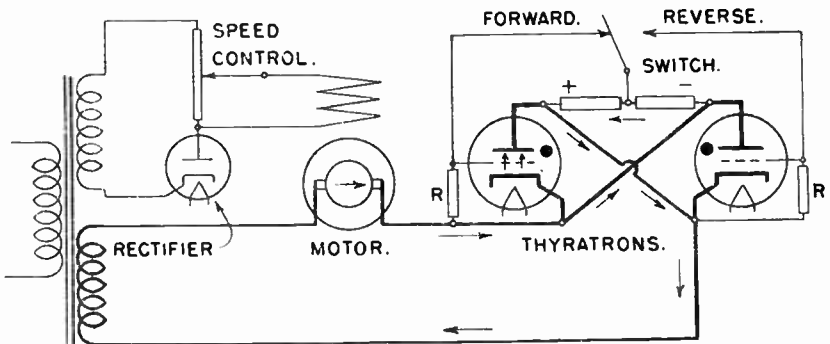

Fig. 162. A thyatron reversing control for small shunt wound motors.

winding. The left-hand thyatron is conducting because its control grid is more positive than its cathode. The control grid is positive because of the instantaneous direction of electron flow through the resistor to which the reversing switch is connected. This direction of flow makes the reversing switch connection (leading to the control grid) more positive than the connection leading down to the cathode of the left-hand tube.

If the reversing switch is moved to its reverse position the control grid of the right-hand thyatron will be made positive and that tube will conduct. Then the direction of electron flow through the motor armature will be reversed, and the motor will reverse its direction of rotation. High resistances R and R are used to maintain the control grids at cathode potential while the grids are not connected through the reversing switch. Electron flow for the motor field winding is taken through a small rectifier in whose plate circuit is a voltage divider for varying the voltage across the shunt field of the motor, thus providing adjustable speed control.

GENERATOR VOLTAGE REGULATION—A generator of a-c voltage, or an alternator as it usually is called, has field windings to which d-c electron flow is furnished, and has an armature from which a-c potential and a-c electron flow are secured when the machine is driven by some external source of power such as an

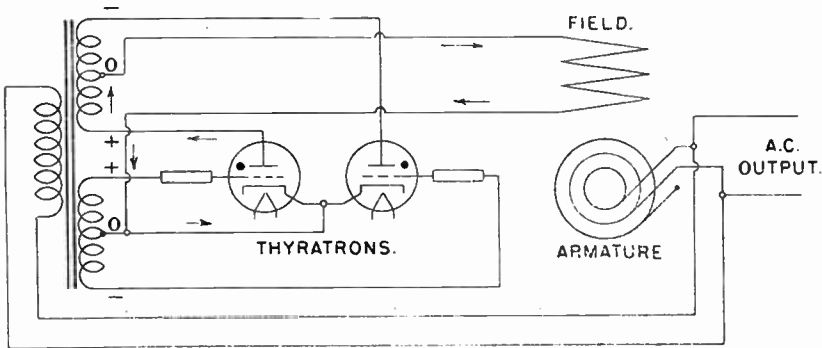

Fig. 163. A thyatron-operated control for maintaining practically constant output potential difference from an alternating potential difference generator, or alternator.

engine or turbine. In most alternators of small and medium size the armature revolves and the field windings are stationary, as in d-c machines. In large alternators the armature may be stationary, with the field windings and core forming the revolving portion of the machine. With either construction, variation of the d-c voltage and electron flow for the field windings will vary the output voltage of the alternator.

The principle of one method for maintaining a nearly constant output voltage from an alternator is shown by Fig. 163. The field winding receives its d-c voltage and electron flow from two thya-

trons connected in a full-wave circuit. Plate voltages and control grid voltages for the thyratrons are taken from secondary windings of a transformer whose primary winding is connected to the a-c voltage output circuit of the alternator being regulated.

If the output voltage of the alternator decreases, the resulting lowered potential difference between control grids and cathodes of the thyratrons makes the grids less negative. This permits a greater average electron flow through the thyratrons and the alternator field winding, and raises the alternator output voltage to compensate for the drop that started the control action. A rise of alternator output voltage makes the thyatron grids more negative, lessens the alternator field flow, and reduces the output voltage to the regulated value. In a complete and practical control system we ordinarily would have some type of phase-shift system to provide a gradual variation of field electron flow.

Chapter 11

GRID-GLOW TUBES AND GLOW TUBES

Cold Cathodes — Action of Grid-Glow Tube — Characteristics, Advantages and Disadvantages — Grid-glow Controls — Cold-cathode Rectifiers — Types of Rectifiers.

When there is a difference of potential between two cold electrodes in a gas-filled tube there is some ionization of the gas. Negative electrons separated from atoms or molecules of gas are drawn toward the electrode that is positive, while the positive ions travel toward the electrode that is negative. If the potential

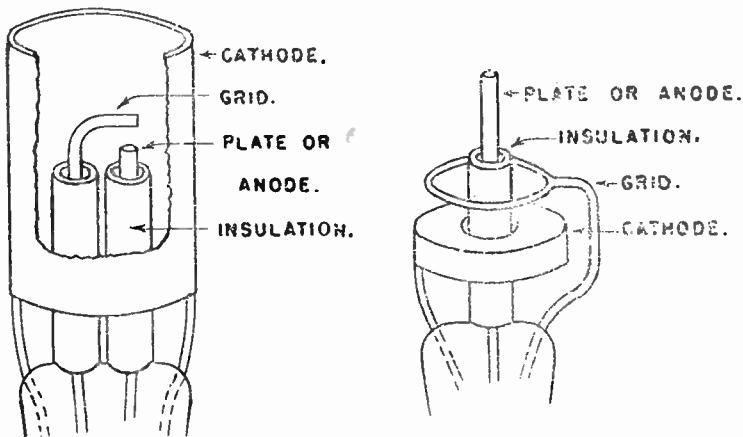

Fig. 164. Electron arrangements used in cold-cathode grid-glow tubes.

difference is great enough, ionization will continue and there will be a greatly increased electron flow through the tube. The cold electrode that is negative becomes the cold cathode for this tube, and the positive electrode becomes the plate.

If we place a third electrode within the tube, forming a construction on the order of those shown by Fig. 164, this third electrode or grid will control the starting of the electron flow between cathode and plate, just as the grid controls starting of the electron flow in the thyatron. A cold-cathode gas-filled tube having one or more electrodes for controlling starting of the d-c

electron flow is called the **grid-glow tube**. The control electrode may be called either the grid or else the starter-anode. Some of the various symbols commonly used to represent grid-glow tubes are shown in Fig. 165.

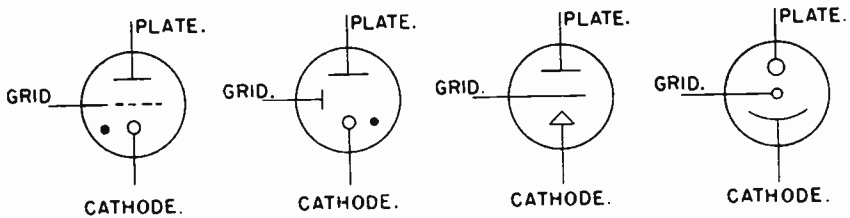

Fig. 165. Wiring diagram symbols for grid-glow tubes.

ACTION OF THE GRID-GLOW TUBE—If there is a great enough difference of potential between the plate and the cathode the ionization will take place to start and maintain an electron flow between these two electrodes. Whether the flow is from cathode to plate or from plate to cathode depends largely on which one is positive with reference to the other. Since both the cathode and the plate are cold we are not depending on heating to assist electron emission, and either of these cold electrodes may act as the emitter provided the potential differences are great enough.

Most grid-glow tubes are constructed so that it is easier for electron emission to take place from the electrode intended for the cathode than from the one intended for the plate. This is accomplished by making the cathode of much larger surface area than the plate, by coating the cathode with substances that readily permit emission, or by making the cathode large and coating its surface.

The potential difference between anode and cathode normally is less than that required for breakdown and for maintaining an electron flow. If the potential difference between the grid and cathode then is made fairly high there will be ionization and a small electron flow between these electrodes, as at A in Fig. 166. If there is established a fairly high potential difference between the grid and plate there will be ionization and electron flow between these two, as at B in Fig. 166. In either case the ionization of the gas within the tube makes it possible for the main electron flow to commence and continue between the cathode and plate as at C.

Once the electron flow is established between cathode and plate, and is being maintained by the relatively high plate voltage,

the grid loses all ability to control the flow—just as in the thyatron. The grid may start the electron flow between cathode and anode, but cannot regulate the rate of flow nor stop the flow.

The cathode-to-plate electron flow may be stopped only by lowering the cathode-to-plate voltage below a value that depends on the type of tube, and doing so while the grid voltage is no longer of the value required for starting the flow. With a d-c voltage on the plate this voltage must be dropped usually to between 50 and 200 volts in small and large grid-glow tubes respectively. Then the grid regains control and retains control even though the plate voltage again is raised. With a-c voltage on the plate the voltage drops to zero twice during each cycle, consequently the grid may regain control twice in each cycle.

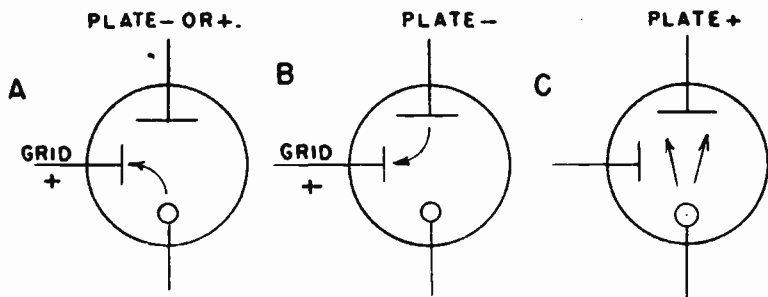

Fig. 166. Electron flows due to initial ionization between the grid and the cathode or the plate permit establishment of ionization and electron flow between cathode and plate.

The potential drop in the grid-glow tube while operating is lower than the potential difference required to start the electron flow, but in relation to the breakdown voltage the operating drop is not anywhere near so low as in a thyatron. Fig. 167 shows typical operation of a 0A4-G grid-glow tube. At breakdown the plate-cathode voltage must be at least 110 volts and the grid-cathode voltage about 65 volts. While the tube is conducting electron flow or is operating, the plate-cathode drop is about 70 volts and the grid-cathode drop about 60 volts. These are effective a-c voltages. The potential drop remains practically constant over a wide range of electron flows, just as with the thyatron.

In the Westinghouse KU-618 grid-glow tube there is a small metallic cylinder called the shield around the upper end of the anode or plate, extending above the insulating sleeve. This construction, also the symbol for such a tube, are shown in Fig. 168.

This shield is maintained at a constant voltage with reference to the cathode by connecting it to the cathode through a resistor of 10 megohms, as shown by one of the sketches in Fig. 168.

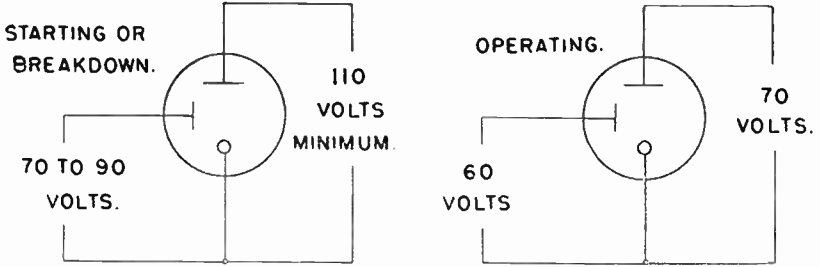

Fig. 167. Breakdown voltages and operating voltages of an OA4G glow-tube.

Fig. 169 shows two control characteristics for the KU-618 grid-glow tube. One of the curves applies with a resistance of five megohms in series with the grid, and the other with a resistance of 27 megohms. These curves show the relations between plate voltages and grid voltages at which the tube breaks down and

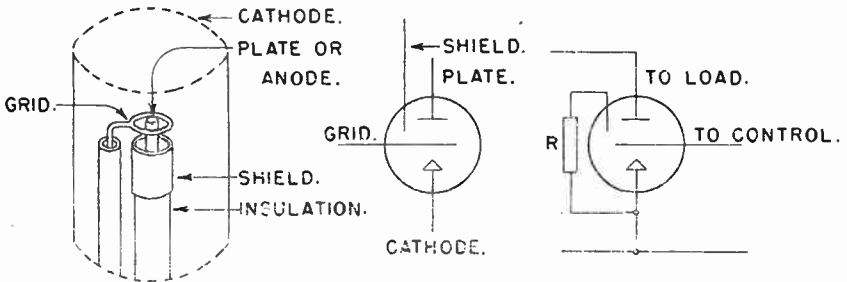

Fig. 168. Construction, symbol and connections for a shield-grid glow-tube.

conducts an electron flow. Note that the voltages are effective or r.m.s a-c values, not d-c or peak a-c values, and note also that all the grid voltages are positive with reference to the cathode. The more positive we make the grid the lower is the plate voltage at which breakdown occurs. This is true also with thyratrons.

Grid-glow tubes have the advantages of requiring no power for heating of the cathode and of practically instantaneous starting without any delay for preheating the cathode. They are useful

for services in which operating periods occur only at fairly long intervals, since they do not deteriorate or age when not operating.

Among the disadvantages of grid-glow tubes are their small rates of electron flow, which, for most tubes, is a maximum of 15 to 25 milliamperes, with permissible peak flows not to exceed 100 milliamperes. Another disadvantage for some applications is the rather large electron flow in the grid circuit. Grid electron flow may be almost anything up to 200 microamperes; the lower the plate

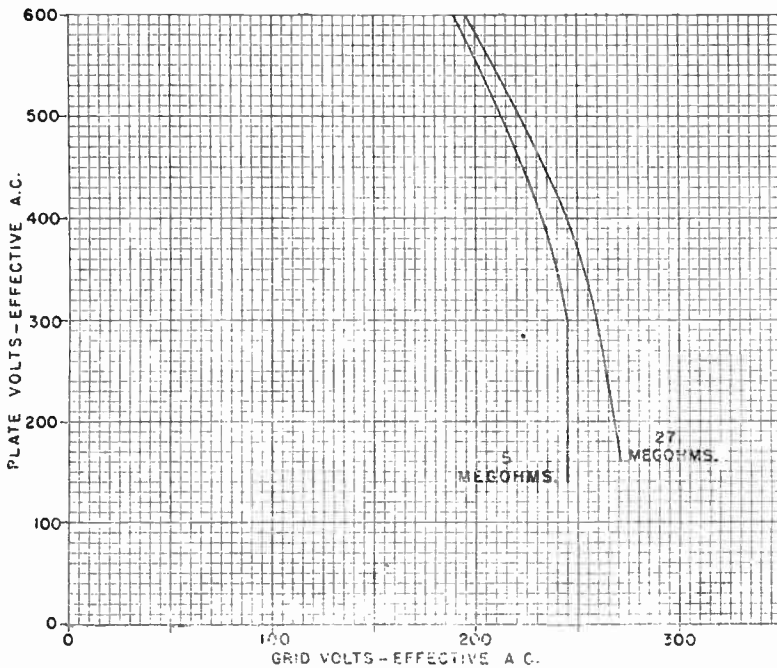

Fig. 169. Control characteristics for a KU-618 grid-glow tube.

voltage the greater being the electron flow in the grid circuit which is necessary to provide the ionization for breakdown. Because the gas pressures in grid-glow tubes are quite high it does not take an inverse voltage much greater than the maximum forward voltage to cause breakdown of the tube in the reverse direction. If the control voltages are somewhat critical, or if the tube is operated close to its breakdown point, it may be necessary to prevent external light from reaching the electrodes, since there may be an effect somewhat like that in a phototube and a breakdown due to excessive illumination as well as to changes of grid voltage.

GRID-GLOW CONTROLS—The grid-glow tubes may be operated with any of the control systems which have been described for use with thyratrons. That is, we may have any form of d-c or battery control, a-c amplitude control or a-c phase-shift control. Since electron flow in the grid circuit of a grid-glow tube ordinarily would not exceed the one-hundredth part of the flow in the anode or plate circuit, the controlling power applied to the grid circuit may be quite small in relation to the power controlled in the plate circuit and the load.

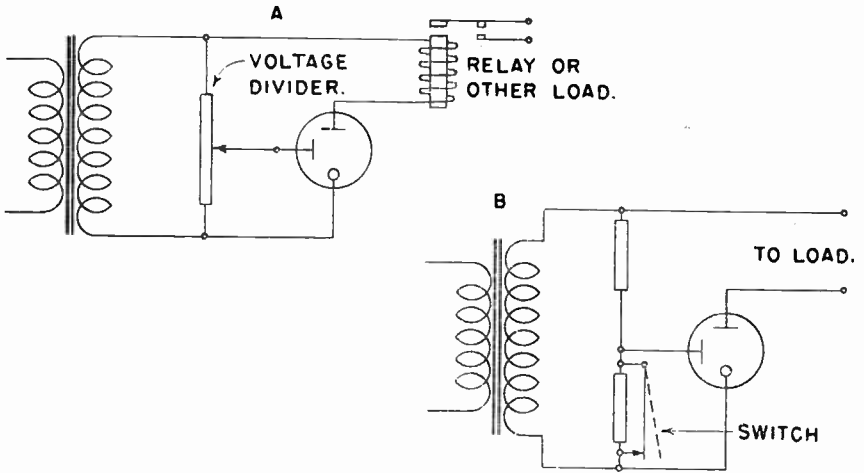

Fig. 170. Grid-cathode voltage controls for operating grid-glow tubes.

At A in Fig. 170 is shown one of the simplest means for changing the grid-to cathode voltage. Considering the half-cycle in which the transformer winding makes the plate positive with reference to the cathode, moving the slider upward on the voltage divider will make the grid more positive. With the grid made sufficiently positive the tube will break down and conduct an electron flow for the load which is in the plate circuit. The voltage divider slider might be moved by any force which is to exercise control over the load.

At B in Fig. 170 we have essentially the same method of control, but instead of a voltage divider and slider have a switch that either short circuits a portion of the control resistance or else allows this resistance to be in the grid circuit. With the switch closed the grid is connected directly, or through low resistance conductors, to the cathode. Consequently the grid-cathode voltage

is zero. Opening the switch forces electron flow to pass through the resistance between the grid and cathode. This flow is in such direction as to make the grid positive with reference to the cathode. The resistance and the electron flow may be selected of such values as to make the grid sufficiently positive to cause breakdown of the tube.

Fig. 171 shows circuits for two styles of control which are similar in principle to some of those examined when studying thyratrons. Between the plate and the anode are a capacitor and a variable or adjustable resistor in series. The grid is connected between the capacitor and resistor. Varying the resistance causes

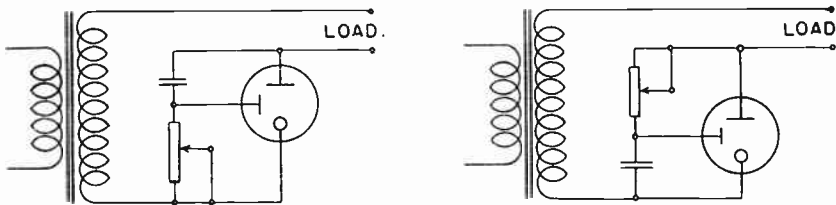

Fig. 171. Grid control applied to grid-glow tubes.

a change of grid voltage and makes the tube break down. The resistance may be varied by any force in accordance with which the load is to be controlled.

Instead of the variable resistances and fixed capacitors of Fig. 171 we might obtain control with a fixed resistor and an adjustable capacitance in each circuit. Frequently the resistance is automatically varied by the controlling force, while the capacitor is made adjustable to act as a setting for the exact point of breakdown or to act as a "sensitivity control" for the apparatus.

COLD-CATHODE RECTIFIERS—The earliest type of cold-cathode tubes in common use was a full-wave rectifier containing two plates or anodes and a cold cathode. Fig. 172 shows a full-wave rectifier circuit in which this tube may be used.

Fig. 173 illustrates one of the principal reasons why we may have electron emission from a cold cathode in a gas-filled tube, while such emission would be difficult to produce in a vacuum tube. Both graphs represent a tube in which the plate is 0.20 inch from the cathode and in which there is a potential difference of 100 volts between anode and cathode.

With the vacuum type of tube there is a nearly uniform drop of potential from plate to cathode. For instance, half way between

plate and cathode the potential has fallen to only a little less than 40 volts. The "potential gradient" or slope is about the same all the way from the plate to the cathode.

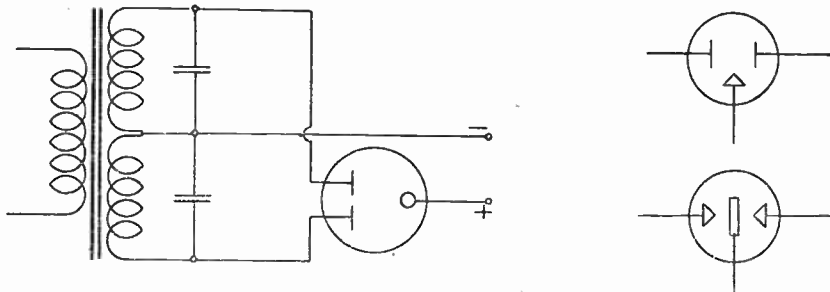

Fig. 172. A cold-cathode glow tube used in a full-wave rectifier circuit; also some of the symbols for glow tubes.

But in the gas-filled tube there is but little drop of potential until we get almost to the surface of the cathode. At 0.02 inch from the cathode we still have 90 volts, and at 0.01 inch still have 80 volts. Then, in the last 0.01 inch we have an exceedingly great

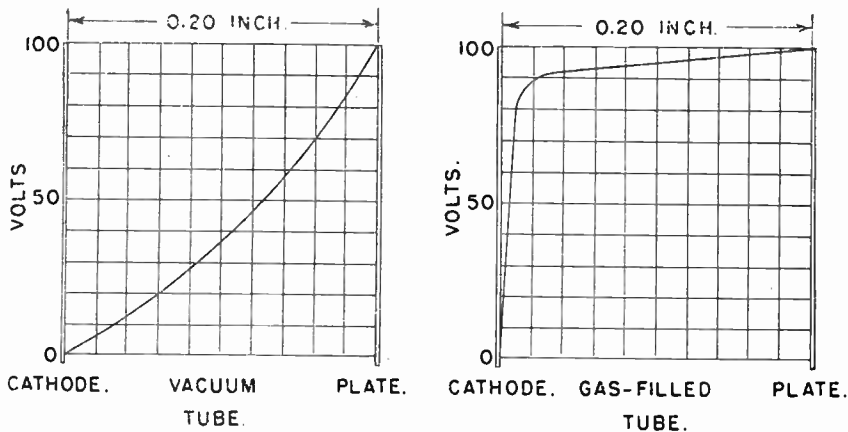

Fig. 173. Potential gradients or slopes from a positive plate to the negative cathode in a vacuum tube and in a gas-filled tube.

drop of potential per unit of distance. The result is that in the gas-filled tube the very high potential close to the cathode surface actually pulls electrons right out of the cold cathode. The potential difference close to the cathode of the vacuum tube is relatively so low as to impart little additional energy or velocity to electrons in the cathode and near its surface.

In the cold-cathode gas-filled rectifier there is a luminous glow over part or all of the cathode surface so long as the electron flow from cathode to anode does not exceed a moderate value. Hence this type of tube is called a **glow tube**. During such operation the voltage drop in the tube is quite small and is nearly constant with wide variations in electron flow.

If the electron flow through the tube is allowed to exceed a certain value the ion bombardment of the cathode surface becomes so severe as to form a bright spot on the cathode surface. The bombardment has raised the temperature of this spot to a point at which we have thermionic emission, or have emission due to heating of the cathode just as in a hot cathode tube. The heating due to this arc discharge materially shortens the life of the cathode in comparison with operation only with a glow discharge.

With the most commonly used cold-cathode rectifier, the OZ4, we may have a maximum d-c output of 75 milliamperes, and must always have at least 30 milliamperes in order to maintain the cathode temperature for emission. The minimum peak plate voltage for breakdown is 300 volts, while the voltage drop through the tube after breakdown is 24 or 25 volts. The maximum d-c output voltage is 300, the maximum permissible potential difference between the two plates is 1,000 volts, and the maximum peak electron flow is 200 amperes.

With the BH type of cold-cathode rectifier, illustrated in Fig 172, the maximum d-c output is 125 milliamperes. The minimum peak plate voltage for breakdown is 350 volts, while the average voltage drop through the tube, after breakdown and while operating, is 90 volts. The maximum effective a-c forward voltage per plate is 350 volts and the peak inverse voltage is 1,000. The peak electron flow in the plate circuit is 400 milliamperes.

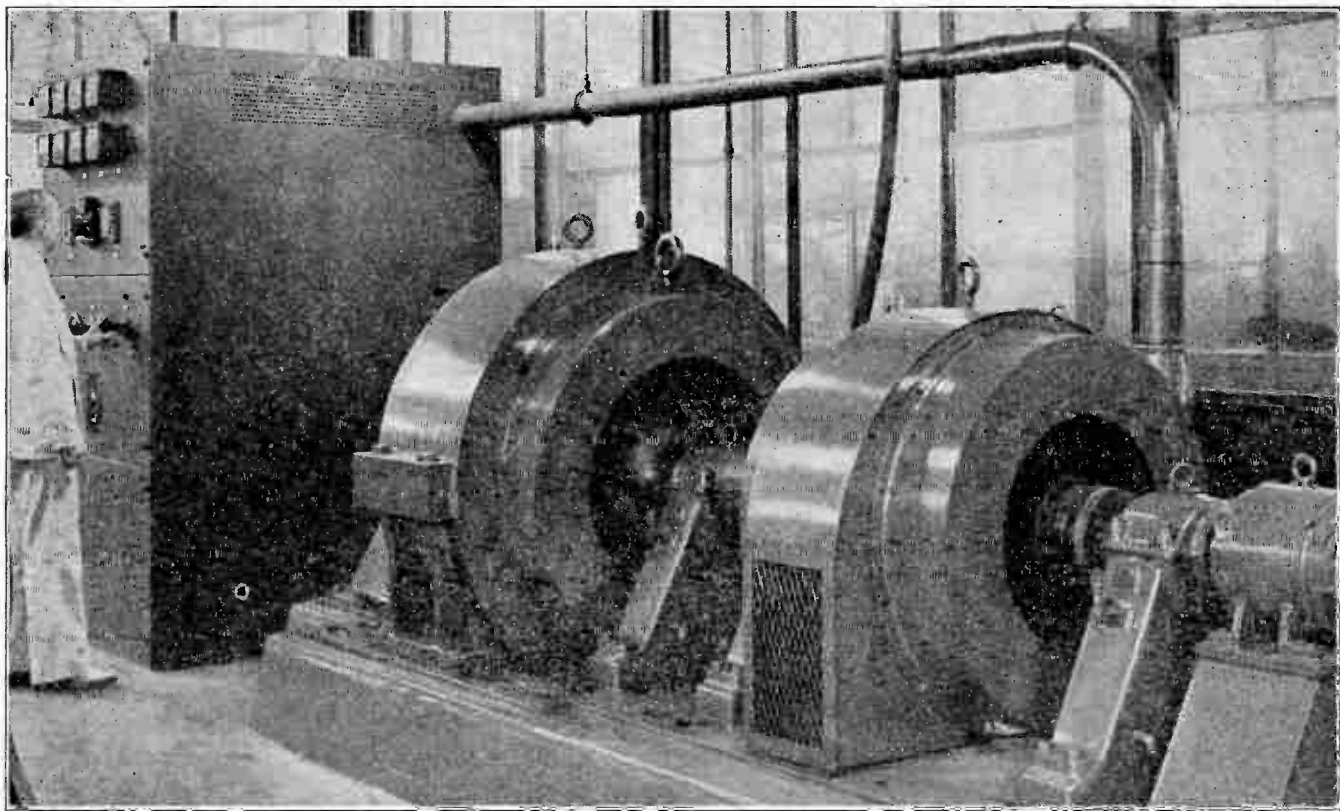

Electric expert operates controls of H. F. inducting heating units. This field offers tremendous expansion and uses for electronic applications.

Chapter 12

VACUUM TUBES AS AMPLIFIERS

Types and Construction — Action of Control Grid — Electron Flow In the Grid Circuit — Triode As an Amplifier — Grid Bias — Plate Characteristics of Triode — Load Lines — Voltage Gain — Determining Grid Voltage Changes — Load Resistance and Supply Voltage — Returns To Cathode — Operating Characteristics — Tetrodes and Pentodes — Thyatron Control Circuits.

In much the same way that electron flow in the plate circuit of a gas-filled tube is regulated by a grid between the plate and

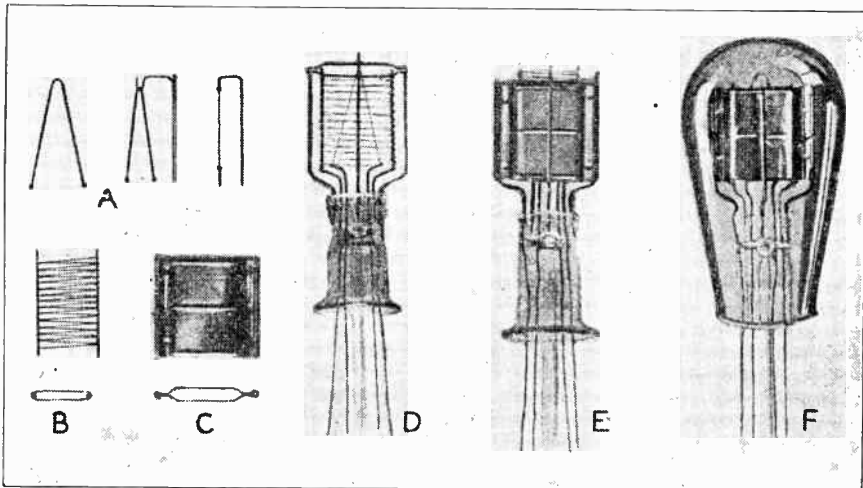

Fig. 174. The construction of a small vacuum triode. A, Types of filaments. B, Control grid. C, Plate. D, Filament and control grid mounted. E, The plate is added. F, The elements in the glass envelope.

the electron emitter, so may electron flow in the plate circuit of a vacuum tube be controlled by a grid between the plate and emitter. A vacuum tube having a heated electron emitter and one or more electrodes whose purpose is to control electron flow through the tube is called a **plotron**.

A high-vacuum thermionic (heated electron emitter) tube with an electron emitter, a plate, and a control grid is called a **triode**.

Adding a shield grid gives us a vacuum tetrode, a shield-grid tube or a screen-grid tube, whichever we may choose to call it. Adding still another electrode, called a suppressor grid, makes the tube into a pentode. We shall study the action of these vacuum tubes as they are used for amplifiers, to produce in their plate circuits a voltage or power much greater than that which is applied to their control grid circuits.

Among the advantages of vacuum tubes over gas-filled tubes is the much smaller electron flow in the grid circuit of the vacuum

type, which allows the vacuum tube to be operated from a grid circuit of very great resistance or impedance in which there may be but a very small electron flow. The vacuum tube has the further advantage of smooth and gradual control of electron flow from zero to the full capacity of the tube, without the sudden increases and decreases of electron flow that occur in the gas-filled tubes. This makes the vacuum tube preferable for precise measurements and anywhere that the electron flow or voltage in the plate circuit must at all times cor-

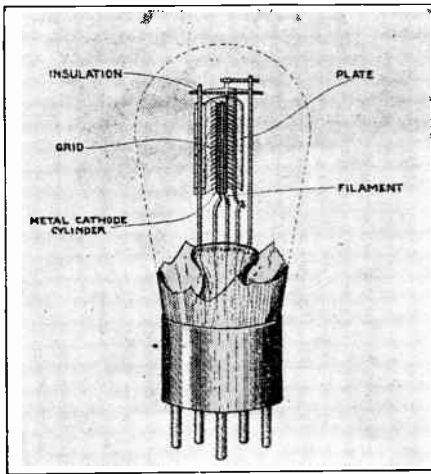

Fig. 175. Construction of a small vacuum triode with heater-cathode.

respond to voltage or to electron flow in the grid circuit.

The vacuum tubes have the disadvantage of carrying very small electron flows in comparison with those which may be handled by gas-filled tubes, consequently the vacuum tube can control only small powers, and when large power or electron flow is to be controlled must work through thyratrons or electromagnetic relays which are actuated by the vacuum tube. The vacuum tube has also the disadvantage of a great drop of potential in the tube itself, thus leaving much less of the supply potential for the plate circuit load than is the case with gas-filled tubes.

Fig. 174 shows the construction of a typical small vacuum triode. At A are three styles of filaments, at B is the control grid consisting of a spiral of small-diameter wire, and at C is the plate. At D are the filament and control grid, attached to their supports,

with lead wires connected, and mounted on the glass "press." At E the plate has been placed around the outside of the grid, and at F all the parts have been placed within a glass envelope ready for mounting on a base with its pins or prongs for external circuit connections.

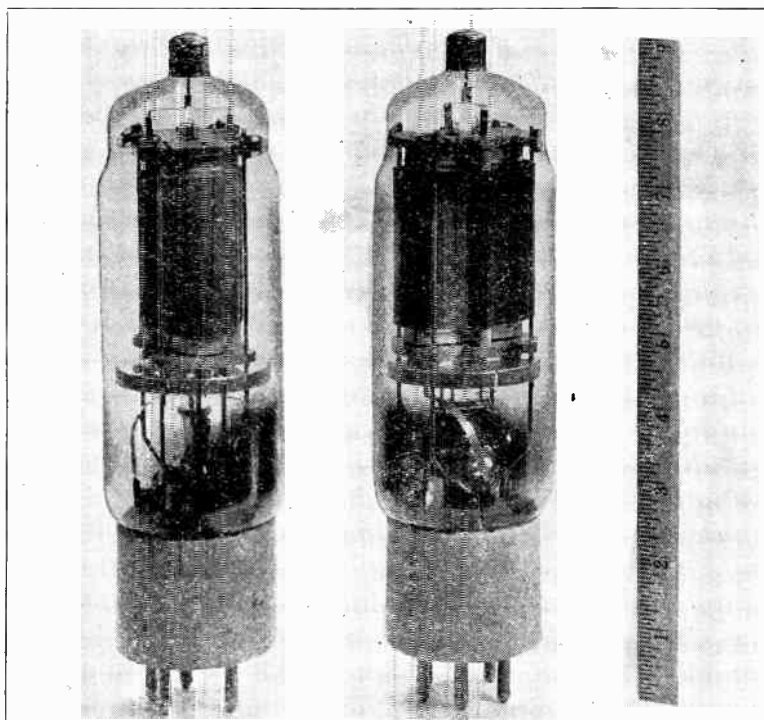

Fig. 176. A power pentode Type WL-803; showing construction details and the size of the tube as compared with the ruler.

Fig. 175 shows the construction of a small vacuum triode having an indirectly heated cathode instead of a filament for its emitter. Inside the plate is the spiral-wire control grid, inside the grid is the cathode, and inside the cathode is the heater. Fig. 176 shows quite clearly the construction of a large power-type pentode tube.

Symbols for vacuum types of tubes are shown in Fig. 177. The symbols for triodes and tetrodes are like those for thyratrons having the same electrodes, except that here we have no dot within the envelope — thus indicating no gas and a vacuum type of tube.

Some pentodes have the suppressor internally connected to the cathode, while others have the suppressor connected to one of the pins on the tube base. Plates or control grids may be connected to a metal cap on top of the tube rather than to one of the base pins.

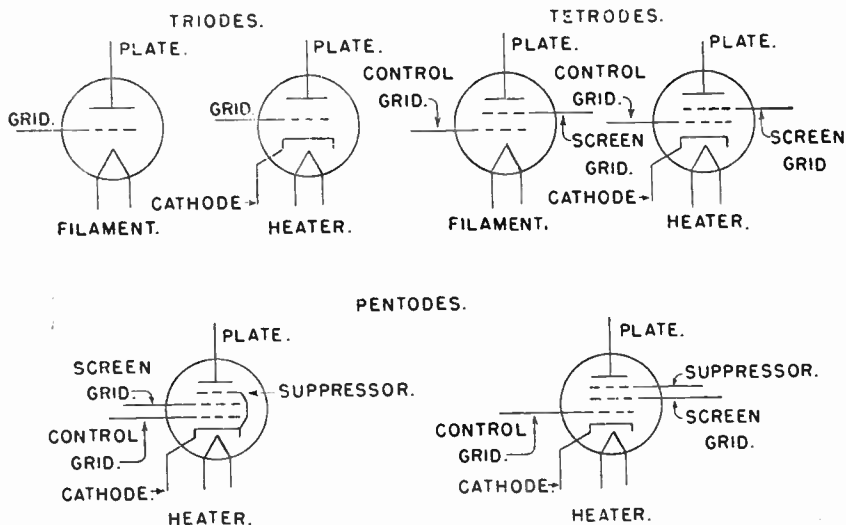

Fig. 177. Wiring diagram symbols for vacuum triodes, tetrodes and pentodes.

ACTION OF THE CONTROL GRID—To determine the effect on electron flow in the plate circuit of variations in grid voltage and plate voltage of a vacuum triode we might use the testing arrangement of Fig. 178. Here we have a grid battery and voltage divider for applying various differences of potential between grid and cathode, also a plate battery and voltage divider for applying various differences of potential between plate and cathode. Between the grid and cathode is a meter for measuring grid voltages, between the plate and cathode is a meter for measuring plate voltages, and in series with the plate circuit is a meter for measuring electron flows in milliamperes.

For the first test we should set the plate battery voltage divider at a point giving 250 volts on the plate, or making the plate 250 volts positive with reference to the cathode. Then we should vary the grid voltage by small steps while taking readings of electron flow in the plate circuit. If the voltages and electron flows were plotted on a graph we should have the left-hand curve of Fig. 179, the curve marked "250 Plate Potential Volts." Repeating

the test with plate voltages of 200, 150, 100 and 50 would yield the other curves which are marked with these plate potentials.

The curves of Fig. 179 show that, with any given plate voltage, the electron flow is decreased by making the grid more negative with reference to the cathode and is increased by making the grid less negative. We observe too that the control is perfectly gradual, that there are no abrupt changes of electron flow at any point.

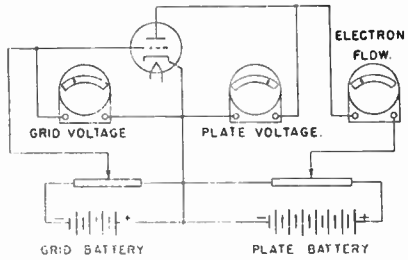

Fig. 178. A circuit for testing the performance of a triode with various values of plate voltage and grid voltage.

As we learned when studying the vacuum type rectifier tube, the kenotron, electron flow in the plate circuit is limited by the space charge of negative electrons around the cathode. The negative space charge partially counteracts the attraction exerted by the positive plate. By placing the control grid closer to the cathode than is the plate, and by making the grid more or less negative with reference to the cathode, we may regulate the amount of negative space charge held at and near the cathode and thus may control electron flow to the plate.

As may be seen from Fig. 179, the grid may be made sufficiently negative to reduce the electron flow to zero even though there is a high plate voltage. Such a grid voltage is called the **cutoff voltage**. As the grid is made less negative the electron flow increases at a faster and faster rate until the grid voltage reaches zero. If the grid then is made positive with reference to the cathode there will be a further increase of electron flow. In many tubes the electron flow with a positive grid is large enough to exceed the safe operating capacity of the tube.

ELECTRON FLOW IN THE GRID CIRCUIT—If the grid is made positive with reference to the cathode, as in Fig. 180, there will be electron flow from the heated negative cathode to the cold positive grid just as there would be electron flow from cathode to plate. When there is resistance in the grid-to-cathode path, as usually is the case, the electron flow is in such a direction through this resistance as to make the end toward the grid **negative** with reference to the other end. This potential drop across the grid circuit resistance partially balances the potential difference that

is making the grid positive and is causing electron flow. However, the grid circuit electron flow will be decreased only to a value that leaves the grid at least somewhat positive.

With a positive grid, and the resulting electron flow in the grid circuit, we lose one of the chief advantages of the vacuum type of tube—which is its freedom from appreciable grid circuit elec-

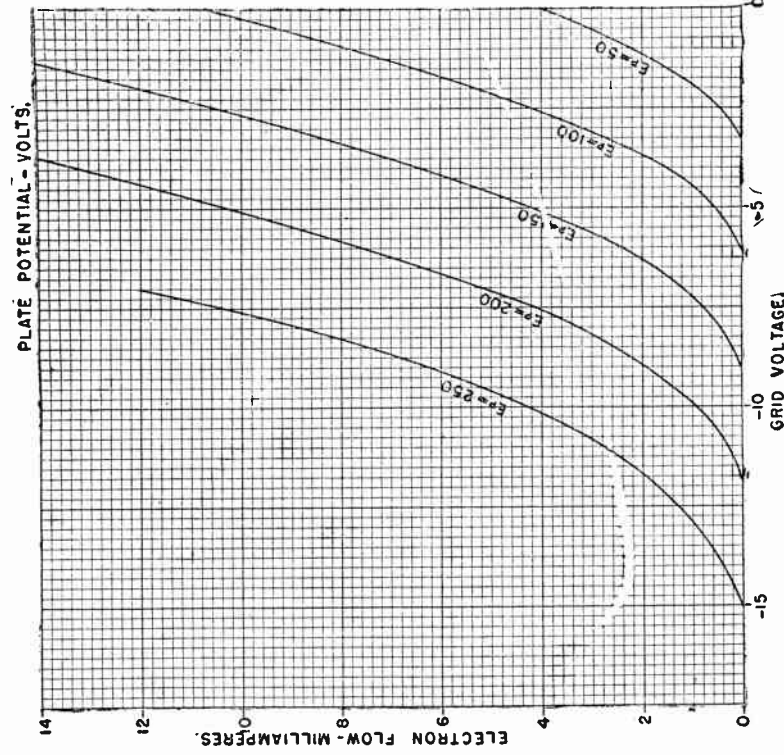

Fig. 179. The effect of grid voltage changes with various constant values of plate voltage. These are average grid characteristics for a 6J5 tube.

tron flow when the grid is maintained at a negative potential with reference to the cathode.

There always should be a conductive path of one kind or another between the control grid and the cathode. Otherwise what is called a free grid. With a free grid some negative electrons will go to the grid and remain there, thus slowly building up a negative potential of varying strength which makes the action of the tube highly erratic.

In all of this discussion about vacuum tubes we should keep in mind the fact that all these tubes are essentially rectifiers in that it is possible for electron flow to take place only from the heated cathode to the plate when the plate is positive, and not from the cold plate to the cathode when the plate is negative. In the plate circuits of all vacuum tubes we have a unidirectional electron flow or a d-c electron flow.

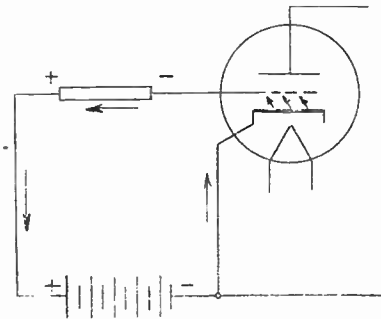

Fig. 180. Electron flow in the grid circuit when the grid is positive with reference to the cathode.

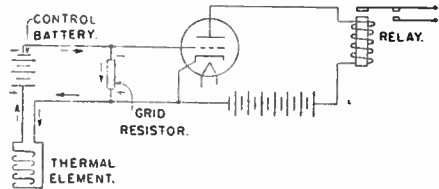

Fig. 181. The circuit which utilizes a vacuum triode for operation of an electro-magnetic relay when there are changes of temperature at a thermal element.

USING THE TRIODE AS AN AMPLIFIER—Fig. 181 is a circuit diagram for apparatus that will operate an electromagnctic relay when there is a change of temperature. The temperature-sensitive unit is a "thermal element" consisting of a coil of wire of any alloy that changes its resistance rapidly as its temperature changes, a rise of temperature causing the resistance to increase, and a drop of temperature causing the resistance to decrease.

In series with the thermal element is a control battery and a grid resistor. The grid resistor is connected also between the grid and cathode of the triode tube. Electron flow through the control battery, the thermal element and the grid resistor is in the direction of the arrows. This flow makes the grid more negative than the cathode by a number of volts equal to the number of ohms grid resistance multiplied by the number of amperes of electron flow in this resistance.

In the plate circuit of the triode is an electromagnctic relay. Electron flow will pull down the relay armature and close the contacts in the load circuit. With the armature up and the contacts separated, the load circuit is kept open.

Suppose there is an increase of temperature at the thermal element. The resistance of this element is increased, there is less

electron flow through it and the grid resistor, and the grid of the triode becomes less negative than before. Making the grid less negative allows an increased electron flow in the plate circuit which includes the relay coil. This increased electron flow is enough to operate the relay and close the load circuit.

If there is a drop of temperature at the thermal element its resistance will decrease, there will be more electron flow through the grid resistor, the grid will be made more negative, thus decreasing the electron flow in the plate circuit and relay coil to allow the relay contacts to open.

Commonly used types of sensitive relays open when electron flow in the coil is about half that required for closing. If we assume that the relay of Fig. 181 closes with eight milliamperes and opens with four milliamperes electron flow we may find from the curves of Fig. 179 that we need less than two volts change at the triode to produce the required change of electron flow. If the grid resistor is of 10,000 ohms resistance it requires a change of only $2/10$ milliamperes ($I=E/R$) for a change of two volts potential drop. Thus a change of $2/10$ milliamperes in the grid circuit causes a change of four milliamperes in the plate circuit, and the triode tube has acted as a current amplifier.

GRID BIAS—Oftentimes the control voltage applied to a resistor in the grid circuit of an amplifier tube may become alternately positive and negative at either end. To use a control voltage that sometimes is positive, yet keep the grid of the tube negative with reference to the cathode, we apply a d-c bias voltage to the grid as shown by Fig. 182.

The grid of the tube in Fig. 182 is given a negative bias by connecting in the grid circuit anywhere between the grid and cathode a battery with its negative terminal toward the grid and its positive terminal toward the cathode. Keeping in mind the fact that there is no appreciable electron flow in the grid circuit when the grid is negative, it is plain that there will be no electron flow in the grid resistor of diagram A, and that there will be no potential difference across this resistor. Consequently, the grid is more negative than the cathode by an amount equal to the bias battery voltage, which here is three volts.

At B in Fig. 182 we have connected to the grid resistor a source of control voltage, which changes through a range of two volts alternately positive and negative. At the instant represented in diagram B this control voltage is acting in such a direction as

to make the upper end of the grid resistor negative and the lower end positive. With reference to the cathode, the grid of the tube now is being made three volts negative by the bias battery and an additional two volts negative by the control voltage, so the grid is five volts negative.

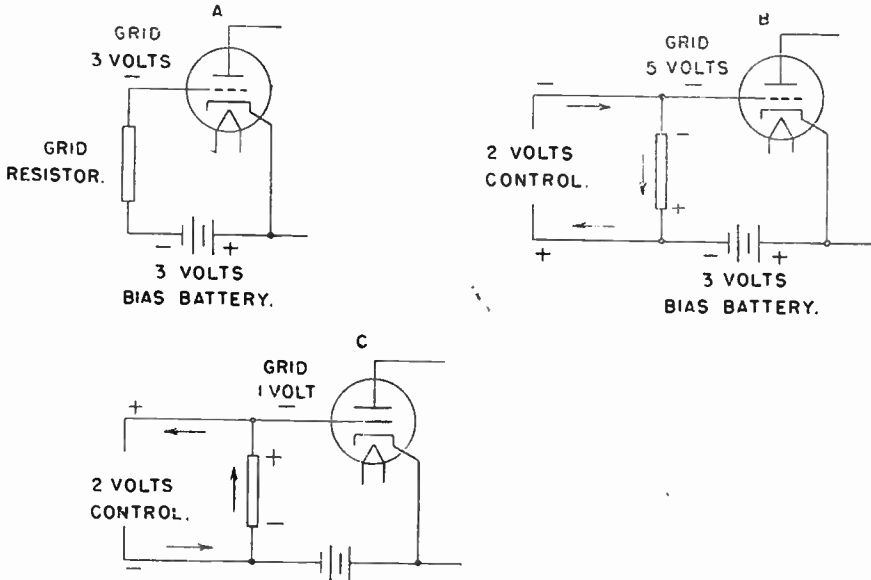

Fig. 182. A negative grid bias of suitable value maintains the control grid always negative with reference to the cathode while the control voltage becomes alternately negative and positive.

At C in Fig. 182 the control voltage has reversed its direction or polarity, and is now in such a direction as to make the upper or grid end of the grid resistor positive with reference to the lower or cathode end. The two volts from the control circuit opposes the three volts from the bias battery and leaves the grid one volt negative. Thus we have used a control voltage that swings from two volts negative to two volts positive, and it changes the grid voltage from five volts negative to one volt negative. We have the full four volts of grid "swing" but the grid always remains negative.

PLATE CHARACTERISTICS OF THE TRIODE—Now we shall go back to the testing circuit of Fig. 178 and run a new series of tests by varying the plate voltage while maintaining fixed values of grid voltage. For the first test we shall set the grid voltage at zero, so that there is no potential difference between the grid and

cathode, and then gradually increase the plate voltage while reading the milliamperes of electron flow in the plate circuit. By plotting the electron flows for various plate voltages with zero grid voltage we would develop the left-hand curve of Fig. 183. Making similar tests with grid voltages more and more negative, at intervals of

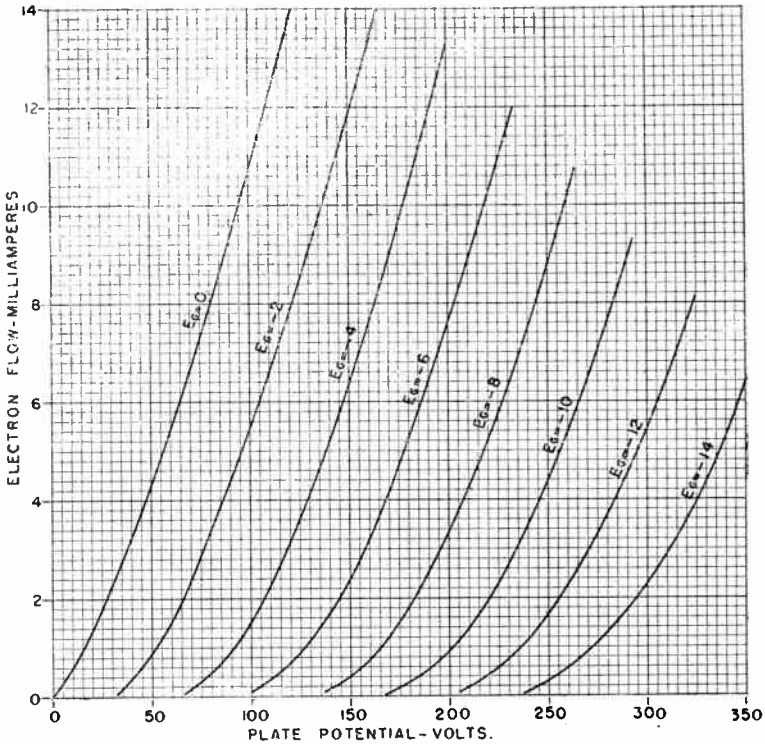

Fig. 183. The effect of plate voltage changes with various constant values of grid voltage. The curves are a family of average plate characteristics for a 6J5 tube.

two volts, will yield the other curves of Fig. 183. Such a group of curves for a particular tube is called a "family" of plate characteristics. From such a group of curves we may learn just about everything that is necessary to know about the performance of the tube that they represent.

Supposing we wish to determine the electron flows and potential differences with our tube used in the circuit of Fig. 184. The control voltage applied across the grid resistor changes from four volts positive to four volts negative. The grid bias is six volts nega-

five. The plate battery or other plate supply delivers a potential difference of 300 volts. The load has a resistance of 20,000 ohms. This load represents any electrical device to be operated by changes of electron flow in the plate circuit.

We wish to determine the change of electron flow in the load, also the change of voltage across the load.

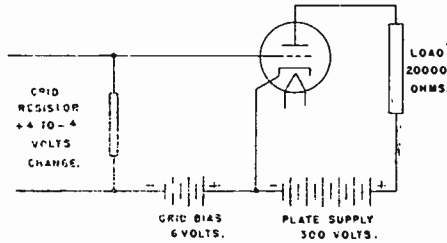

Fig. 184. The circuit in which we wish to determine changes of voltage and electron flow in the load.

The first step is to draw a 20,000-ohm load line on the family of plate characteristics, so to begin with we shall learn how to draw load lines for any load resistance on any plate characteristics and for any plate supply voltage.

LOAD LINES—A load line is a straight line along which lie all the combinations of electron flows, plate voltages and grid voltages which may occur together when the plate circuit load is of a certain number of ohms resistance.

A number of load lines have been drawn on the graph of Fig. 185 in order to illustrate the method of drawing them. Later we shall place a 20,000-ohm load line on the plate characteristic for the tube we are using. To draw a load line we proceed as follows:

1. Multiply the number of ohms in the plate circuit load by the number of milliamperes corresponding to any line on the graph of plate characteristics, and divide the result by 1,000. Usually it is convenient to select a number of milliamperes equal to about one-third of the maximum range of the graph. What we are doing is multiplying ohms of resistance by milliamperes of electron flow, and dividing by 1,000 to find a number of volts. Remember that $E = IR$. We divide by 1,000 because the electron flow is measured in thousandths of amperes (milliamperes) rather than in amperes as called for by the formula.

2. From the number of volts furnished by the plate supply subtract the number of volts calculated in step 1 above.

3. On the graph mark a point at the intersection of the plate voltage determined in step 2 and the electron flow selected in step 1. This will be one point on the load line.

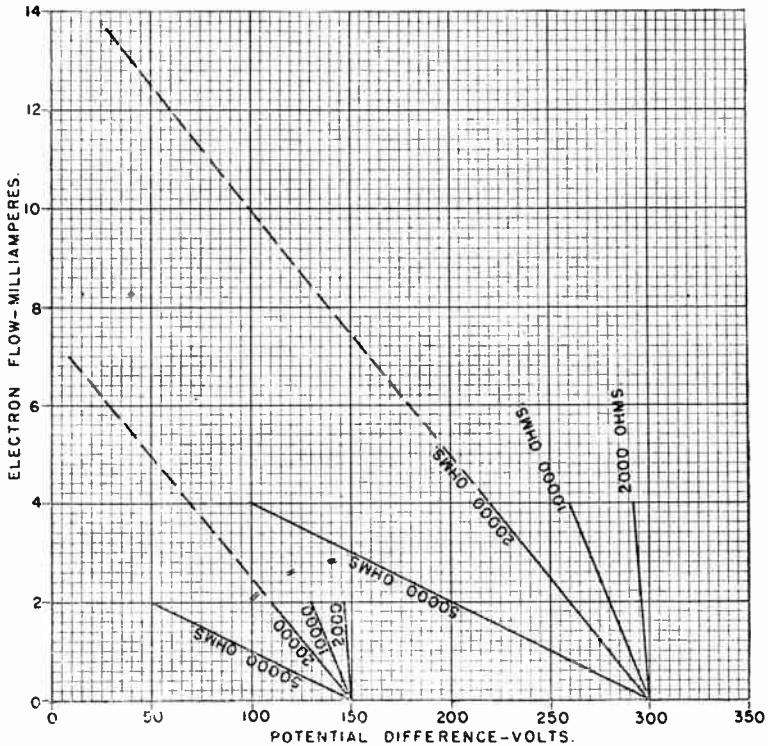

Fig. 185. Load lines as laid out on a graph for potential differences and electron flows at the plate. One set of lines is for a 150-volt supply, the other for a 300-volt supply.

4. Another point on the load line will be at zero electron flow and at the plate potential corresponding to the voltage of the plate supply.

5. Draw a straight line through the two points laid out in steps 3 and 4. Extend this straight line so that it passes through all the curves on the graph. This is the load line for a load of the resistance used in step 1.

On Fig. 185 have been drawn two sets of load lines, using the foregoing rules. One set of lines is drawn for a plate supply of

300 volts, using an electron flow of four milliamperes. The 20,000-ohm line is extended as a broken line to show how any of the lines might be extended. The second set of load lines is drawn for a plate supply of 150 volts, using an electron flow of two milliamperes, and again the 20,000-ohm line is extended. Note that the slope of load lines for any given resistance are the same no matter what plate supply voltage is used.

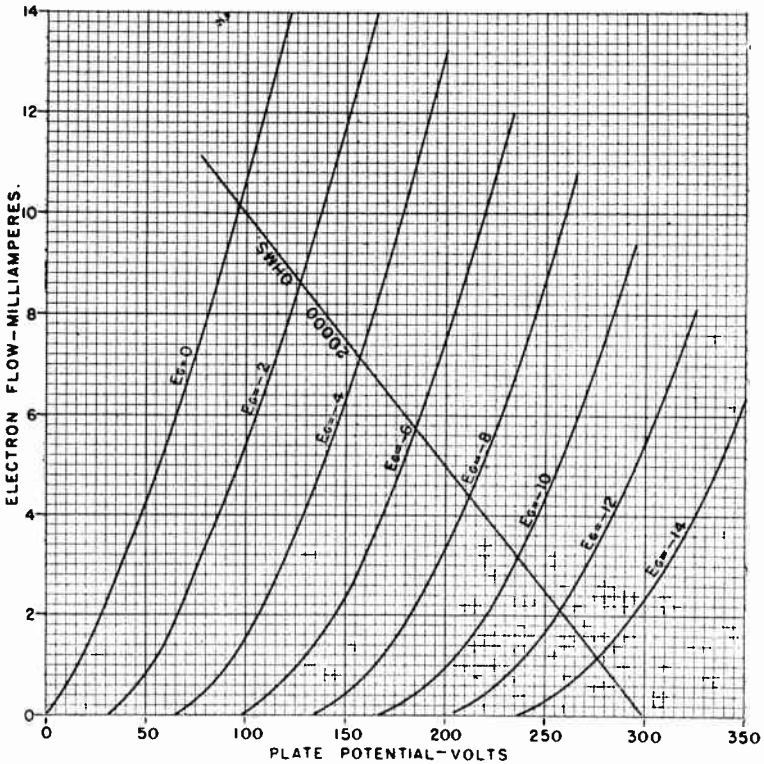

Fig. 186. On the family of plate characteristics is drawn a load line for 20,000 ohms and a 300-volt supply.

Fig. 186 shows a 20,000-ohm load line for a plate supply of 300 volts drawn on the family of plate characteristics for the tube we are using. This load line allows us to proceed with determination of electrons flows and voltages for the circuit of Fig. 184.

Referring to Fig. 184, the grid bias is six volts negative and the control voltage on the grid resistor changes from four volts positive to four volts negative. Consequently the grid voltage

changes from two volts negative to ten volts negative as the control voltage is alternately subtracted from and added to the bias voltage.

Now we go to Fig. 186 and, on the load line, pick out the intersections with two volts negative and ten volts negative. Here are the electron flows and the plate potentials at these grid voltages:

At - 2 volts grid, 8.65 milliamperes, 127 volts.

At - 10 volts grid, 3.15 milliamperes, 236 volts.

These electron flows go through both the tube and the load. But the plate potentials are potential differences in the tube alone, because the curves apply to tube behavior. To determine the potential differences across the load we must subtract the tube potentials from the supply voltage.

300 (supply volts) - 127 (tube volts) = 173 load volts

300 (supply volts) - 236 (tube volts) = 64 load volts

Now we have learned exactly what happens in the load resistance of 20,000 ohms as the control voltage changes from four volts positive to four volts negative.

	Grid volts	Control volts	Plate and Load milliamperes	Tube Plate volts	Load volts
Maximum					
Control	+ 4	- 2	8.65	127	173
Minimum					
Control	- 4	- 10	3.15	236	64
	<hr/>	<hr/>	<hr/>	<hr/>	<hr/>
Difference or Change	8	8	5.50	109	109

VOLTAGE GAIN—The tube that we have been using is one that is classed as a voltage amplifier, meaning that its greatest usefulness is in increasing any voltage changes applied to the grid and producing greater voltage changes across a load in the plate circuit. In the case we have analyzed, the change of voltage at the grid is 8 volts, and the change of voltage across the load (also across the tube at the plate) is 109 volts. The voltage gain is equal to 109 divided by 8, or is approximately 13.6 for the particular circuit being studied.

Other amplifier tubes are classed as power amplifiers, meaning that they will produce relatively large amounts of power in watts in a plate circuit load. Because of the small electron flows handled

by voltage amplifiers in their plate circuits and loads there is but little power developed in the load. Power amplifiers are capable of handling much larger electron flows in their plate circuits, and since power in watts is proportional to the square of the electron flow these power amplifiers produce considerable power in a connected load.

DETERMINING REQUIRED GRID VOLTAGE CHANGES—

When we know the resistance of a load, know the change of electron flow required to operate the load, and have a family of plate characteristics for the tube to be used, it is easy to draw a load line for the load resistance and plate supply voltage, then determine the required change of grid voltage.

If we assume a load of 20,000 ohms resistance, a plate supply of 300 volts, and a change of electron flow between six and two milliamperes we may use the graph of Fig. 186 for the tube it represents. Following the load line we find that an electron flow of six milliamperes corresponds to approximately 5.6 negative grid volts and that two milliamperes corresponds to approximately 12.2 negative grid volts. Thus we learn that the grid voltage must change between about 5.6 and 12.2 volts, a "swing" of about 6.6 volts. Other load resistances and other plate supply voltages would require only the drawing of a suitable load line, after which the grid voltages would be determined as just explained.

DETERMINING LOAD RESISTANCE AND SUPPLY VOLTAGE—

Frequently we may wish to produce in the load a change of electron flow between two definite values in milliamperes, and may have available only a certain change of grid voltage. We must determine the load resistance and the supply voltage that will satisfy our fixed factors.

As an example we may assume that electron flow is to vary between 9 and 2 milliamperes in the load circuit when the grid voltage changes from 2 volts to 8 volts negative. The solution is shown by Fig. 187 where we have taken from the family of plate characteristics the curves for the grid voltages to be used—2 volts negative and 8 volts negative. On the 2-volt curve we spot the intersection of the 9-milliamperere line, at A, and on the 8-volt curve spot the intersection of the 2-milliamperere line at B. This fixes our load line. Continuing the load line down to the bottom of the graph, as has been done in a broken line, we find that the plate supply voltage must be close to 197.5 volts.

To determine the required load resistance in ohms we must divide the change of plate volts by the change of electron flow in amperes, because $R = E/I$.

At A the plate voltage is 130 volts.
 At B the plate voltage is 182 volts.
 The change is 52 volts.

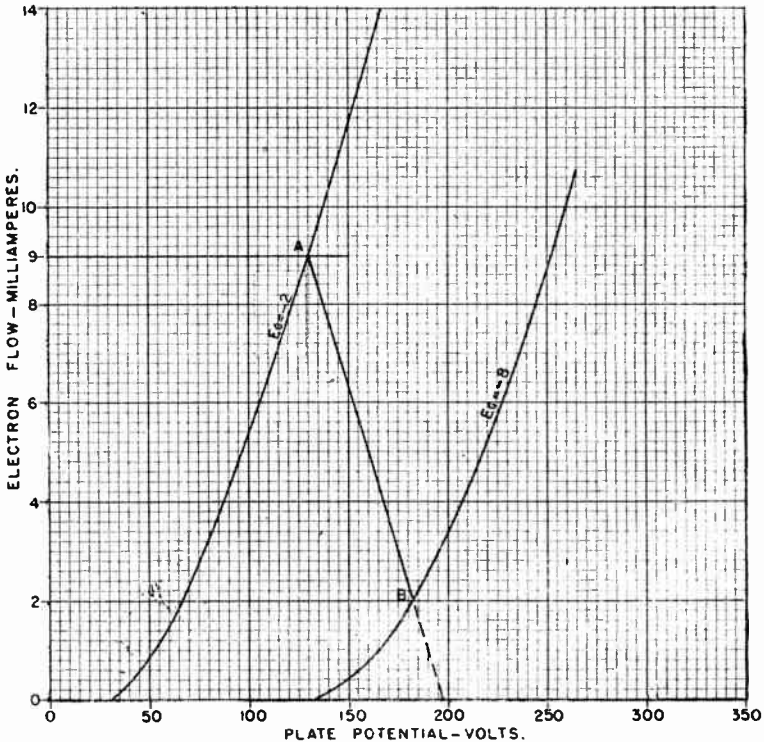

Fig. 187. Knowing only the required change of electron flow in the load and the available change of control grid voltage, we may determine the necessary load resistance, and supply voltage.

The change of electron flow is from 9 to 2 milliamperes, a change of 7 milliamperes or of 0.007 ampere. Then,

$$52 \text{ (volts change)} \div 0.007 \text{ (ampere change)} = 7,430 \text{ ohms.}$$

Thus we learn that there will be a change of electron flow from nine to two milliamperes when there is a change from 2 to 8 volts negative at the grid if we provide a plate supply of 197.5 volts and a load resistance of 7,430 ohms for the particular tube

represented by the plate characteristics. Any similar problem may be solved in the same manner.

In all our problems we have selected values of electron flow and grid voltages easily located on the graph showing plate characteristics. For values intermediate between the curves it is quite easy to estimate proportional positions or to sketch in an extra curve for the grid voltage being used.

CIRCUIT RETURNS TO CATHODE—When studying circuits used for thyratrons there were shown various ways of connecting the grid circuit, plate circuit and other circuits to the electron emitter, the cathode or filament. All of the instructions there given apply as well to vacuum types of tubes. With vacuum triodes, tetrodes and pentodes we use center-tapped filament and heater windings, center-tapped resistors, observe positive and negative ends of filaments, and do all the other things which have been described for thyratron circuits.

OPERATING CHARACTERISTICS OF TUBES—In published listings of typical operating characteristics of various tubes you will find specified certain plate voltages, plate electron flows, and grid voltages. In addition you will find specified values for amplification factor, for plate resistance in ohms, and for transconductance or mutual conductance in micromhos. The three latter characteristics may be determined by reference to a family of plate characteristics.

Amplification factor is a number found by dividing a change of plate volts by the accompanying change of grid volts when the plate electron flow remains unchanged. The smaller the changes of voltages measured the more accurate will be the calculation. The changes may be read on any line for a selected value of plate electron flow, using a family of plate characteristics.

Plate resistance in ohms is found by dividing a small change of plate voltage by the accompanying change of plate electron flow in amperes, not milliamperes, when the grid voltage remains unchanged. The plate voltage and electron flow may be read from the curve for the grid voltage being used.

Transconductance, called also mutual conductance, is found by dividing a small change of electron flow in milliamperes by the accompanying change of grid volts, then multiplying by 1,000, under the condition that the plate voltage remains unchanged. The electron flow and grid volts may be read from any line for a plate voltage being used.

Amplification factor, plate resistance and transconductance indicate in a general way the abilities of the tube as an amplifier. The trouble is that these values are measured with unchanging electron flow in one case, with unchanging grid voltage in another, and with unchanging plate voltage in the third, and since all three of these are constantly varying while a tube operates in a practical circuit we cannot do much of our calculating from these operating characteristics and obtain accurate results. It is far more satisfactory to make use of a family of plate characteristics and the suitable load lines.

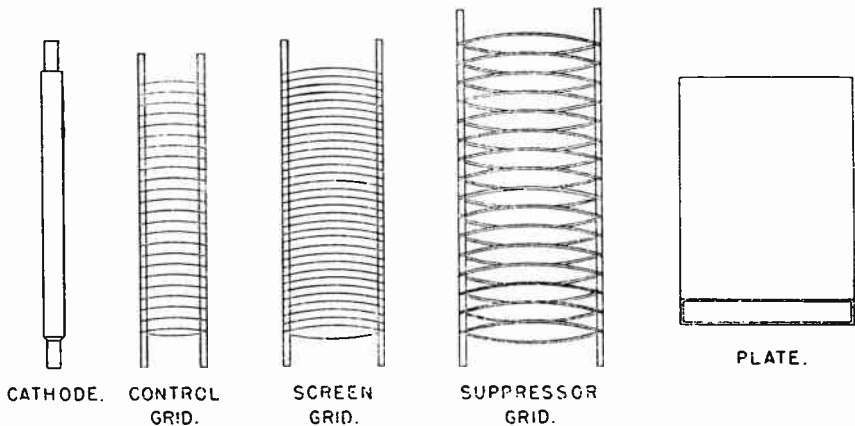

Fig. 188. The five active elements used in one style of pentode. With the exception of the suppressor grid, the same elements may be used in a tetrode.

TETRODE AND PENTODE TUBES—The screen grid first was added to the triode type of construction to overcome certain difficulties that sometimes arise when using triodes. The screen grid tube or tetrode developed some troubles of its own, and to overcome them the suppressor grid was placed between the screen and the plate to make the pentode.

Fig. 188 shows the five active elements or electrodes of a pentode. The three grids are spirals of small diameter wire. The control grid surrounds the cathode, around the control grid is the screen grid, around the screen is the suppressor grid, and on the outside is the plate. How the grids are placed in one style of pentode is shown by Fig. 189.

Sometimes we encounter trouble in operation of a triode because, as indicated at A in Fig. 190, the metallic plate and the

metallic control grid act as the two plates of a capacitor whose dielectric is the vacuum within the tube. The capacitance between plate and grid is small, but, as with any other capacitor, any charge on one of its plates tends to produce an equal and opposite charge on the other. Thus the potential of the control grid is affected to some extent by the changes of potential at the plate, and instead of grid potentials being affected only by forces applied to the grid circuit they are affected also by changes of potential in the plate circuit.

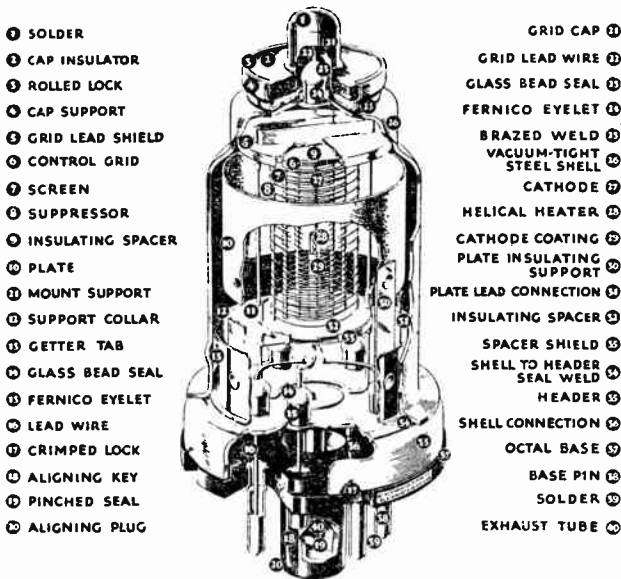

Fig. 189. How the three grids are placed between the cathode and plate in one style of small pentode tube.

At B in Fig. 190 the screen grid has been inserted between plate and control grid. The screen and plate are closer together than the control grid and plate, so potential changes on the plate that formerly would have affected the control grid now affect only the screen grid and are diverted through the screen and voltage supply to the tube cathode.

The voltage of the screen grid with reference to the cathode may be made as high or nearly as high as the plate voltage. The strong positive charge thus placed on the screen exerts a strong attraction on negative electrons with the result that electrons from the cathode are greatly speeded in their travel through the control grid. A small portion of the electron emission enters the screen

grid, but the greater part goes through the open spaces of the screen and reaches the plate. The positive voltage or charge on the screen has such a great effect on electron travel that electron flow to the plate and in the plate circuit is almost unaffected by moderate changes of plate voltage throughout most of the normal operating range.

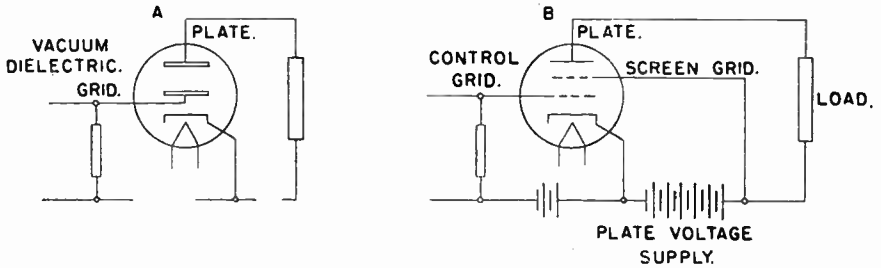

Fig. 190. A, The grid and plate act as plates of a capacitor whose dielectric is the insulating vacuum within the tube. B, The screen grid is placed between the plate and the control grid, and is maintained at a high voltage with reference to the cathode.

The amplification or the possible voltage gain with a screen grid tube is many times that obtainable with a triode, but the electron flow in the plate circuit of the screen grid tube is much smaller than in the plate circuit of a triode.

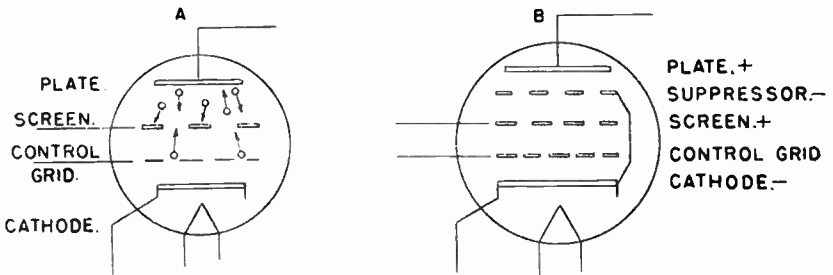

Fig. 191. A, High-velocity electrons strike the plate and cause emission of secondary electrons. B, The negative suppressor is placed between the positive plate and positive screen, forming the pentode.

THE PENTODE—The screen grid tube or tetrode of usual construction suffers from the effects of “secondary emission.” Secondary emission is emission of electrons from a relatively cold surface because the surface is being violently bombarded by other electrons reaching it at high velocity. At A in Fig. 191 are indicated electrons traveling in the desired manner from the cathode

through the control grid and screen grid to the plate. A high voltage on the screen gives these electrons such high velocity as they near the plate that they literally knock extra secondary electrons out of the plate.

Secondary electrons leaving the plate go instantly to the screen, because the screen has a high positive voltage. If there are very large changes of potential in the plate circuit it is quite possible for the plate voltage sometimes to become lower than the screen voltage, with the result that there is a large flow of secondary electrons from plate to screen. These electrons leaving the plate are, in effect, subtracted from those arriving at the plate from the cathode, and thus there may be a material reduction of electron flow in the plate circuit.

As shown at B in Fig. 191 we have in the pentode a **suppressor grid** between the plate and screen. The suppressor most often is connected directly to the cathode, so is at the same potential as the cathode and is negative with respect to the plate. This negative electrode so close to the plate has a strong repelling effect on secondary negative electrons attempting to leave the plate and go to the screen. The result is that secondary emission is almost wholly "suppressed" by the suppressor grid.

Pentodes are used both for voltage amplification and for power amplification. The pentode may be operated with very great changes of electron flow and potential differences in the plate circuit and load without difficulties arising from secondary emission as in the screen grid tube or from plate-to-grid "feedback" as in the triode, yet the pentode has the high voltage gain of the screen grid tube and will amplify extremely small grid circuit voltages until they are strong enough to actuate the control grid circuits of large thyratrons.

THYRATRON CONTROL CIRCUITS—Fig. 192 illustrates the use of a triode voltage amplifier tube for on-and-off control or trigger control of a thyatron. Assuming the use of a thyatron and a triode which will operate with the same plate voltage and the same heater voltage it is possible to connect one end of the high-potential transformer winding to the thyatron plate through the load and directly to the triode plate. Electron flow to the cathode of the triode passes upward through the voltage divider, making the upper end positive and the lower end negative. With the lower end of the voltage divider connected to the thyatron cathode and the slider to the thyatron grid the slider may be set at a position to cause **breakdown** of the thyatron with any desired electron flow in the

triode and voltage divider. A variation of control voltage applied between grid and cathode of the triode causes corresponding variations in electron flow in the voltage divider and in voltage applied to the thyatron grid. Adjustments may be made to allow breakdown of the thyatron at any desired value of control voltage on the triode.

A phase-shift thyatron control circuit is shown by Fig. 193. The phase-shift is caused by a combination of a capacitor and an adjustable resistor, with a triode tube acting as the adjustable resistor. In capacitor-resistor phase-shift circuits which were examined when studying the action and control of thyatrons, break-

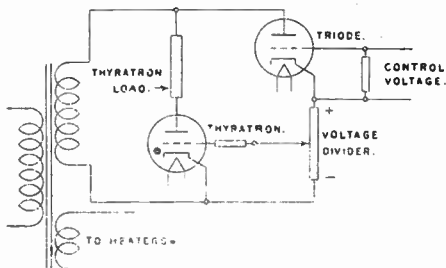

Fig. 192. A triode used for on-and-off control or trigger control of a thyatron.

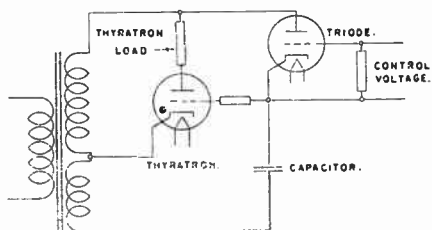

Fig. 193. A triode may be used instead of an adjustable resistance in one leg of a resistor-capacitor type of phase-shift control for a thyatron.

down of the thyatron was caused by variation of the resistance to cause a change of electron flow through that unit. In Fig. 193 we cause a change of electron flow through the triode by changing the control voltage applied between its grid and cathode, thus producing an effect equivalent to that in the capacitor-resistor type of phase-shift control.

The triode control tubes shown in Figs. 192 and 193 might be replaced with pentodes in case the changes of control voltage are so small as to require the high amplification provided by the pentode.

Chapter 13

AUTOMATIC TIMING

Capacitor-Resistor Time Delay — Time for Charge and Discharge — Time Constant — Capacitor and Resistor In Parallel — Using a Time-delay Circuit — Charging From Grid Rectification — Time-delay Relay — Smoothing Capacitor — Copper-oxide Rectifier — Trigger-type Time Delay.

A resistor and a capacitor, together with an electronic tube, form a combination capable of automatically timing almost any process that is to continue from a small fraction of a second to many minutes. Electronic time-delay circuits are used for the control of welding, annealing, brazing and many other heating processes, for the control of automatic molding, for counting, for operation of dish washing machines, and for innumerable other applications where there must be a time interval between successive operations.

TIME DELAY WITH CAPACITOR AND RESISTOR—

At the top of Fig. 195 is a flexible diaphragm between two water chambers, with the water chambers connected to a pump and with a valve in one side of the water circuit. The

instant the valve is opened the diaphragm will be stretched by pressure and suction from the pump. The stretching will be whatever is required to make the back pressure exerted by the diaphragm equal to the forward pressure exerted by the pump, then the stretching will cease, and the pressure in the water chambers will be equal to the pressures at the pump.

The flow of water from the pump to the chamber on one side of the circuit, and the flow from the chamber to pump on the other side, will continue only so long as the pressure at the pump or

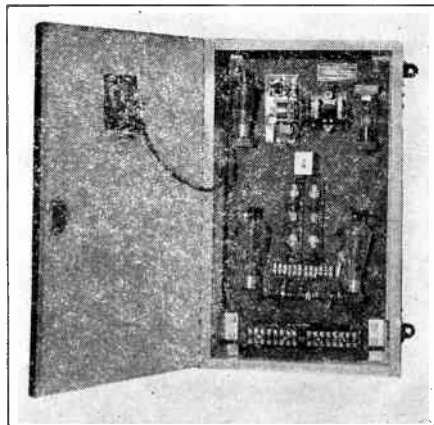

Fig. 194. A timing control for spot welding, showing the thyatron tubes.

from the pump is greater than the back pressure developed by the stretched diaphragm. As soon as the pressures become equal the water flow will cease.

At the bottom of Fig. 195 is a capacitor with its plates connected to a battery and with a switch in one side of the electric

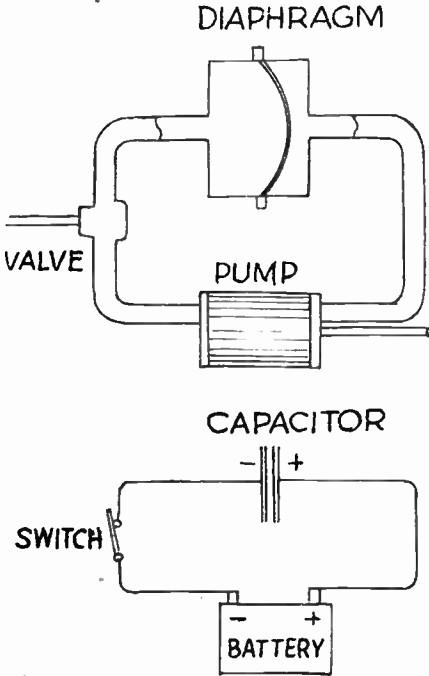

Fig. 195. A capacitor in series with a battery and switch acts much like water chambers and a flexible diaphragm in series with a pump and valve.

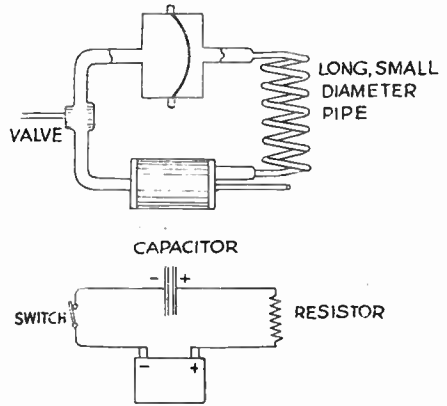

Fig. 196. Adding resistance in the series circuit delays the rate at which the capacitor is charged or the diaphragm stretched.

potential difference between the plates of the capacitor equal to the potential difference of the battery, then the charging will cease, and the voltage across the capacitor will be equal to the voltage of the battery.

Electron flow from the negative side of the battery to the capacitor plate that is charged negatively, and from the capacitor plate charged positively to the positive side of the battery, will continue only so long as the voltage of the battery is greater than the voltage developed in the capacitor due to its being charged. As soon as the voltages become equal the electron flow will cease.

circuit. Let's compare the action in this electric circuit with that in the water circuit. The instant the switch completes the circuit the capacitor will be charged by the potential difference from the battery. The charging will be whatever is required to make the poten-

In Fig. 196 we again have the water circuit with diaphragm, water chambers and pump, and have the capacitor with a battery. But now there is a long, small-diameter pipe in one side of the water circuit, and a resistor in one side of the electric circuit.

If the force at the pump is the same in Fig. 196 as in Fig. 195 the diaphragm will not be stretched so quickly with the high resistance of the extra pipe in the water circuit. This is because a given force cannot cause water to flow so rapidly through the high-resistance pipe as through the original short, large-diameter connections. But if we wait long enough the diaphragm will be stretched to just the same degree in both cases, and this stretching will be proportional to the difference in pressure provided by the pump. Furthermore, when the diaphragm finally is fully distended, the back pressure from the diaphragm will be exactly equal to the pressure from the pump.

Considering the electric circuit of Fig. 196, where there is a resistor in series with the capacitor, it will take longer to charge the capacitor than as though no resistor were in the circuit. However, if we wait long enough, the capacitor will be charged to just the same degree and will have just the same potential difference across it as though no resistor were present, assuming, of course, that the applied voltage is the same with and without the resistor. The effect of the resistor is to delay charging of the capacitor, and the more the resistance the slower will be the charging.

This time delay of charging due to resistance is easy to understand if we think about a few well known facts. First, a charge consists of a surplus and a deficiency of electrons in some definite quantity. Second, quantities of electrons are measured in coulombs. Third, to take longer to move a given quantity of electrons means that we require a flow of fewer coulombs per second. But coulombs per second are amperes, so for a slower charge we need fewer amperes. Finally, from Ohm's law we know that amperes are equal to volts divided by ohms, or that amperes are inversely proportional to ohms of resistance. So, to have fewer amperes, and a slower charge, all we need is more ohms of resistance.

CHARGING A CAPACITOR—The total quantity of electrons, or the total coulombs, that will be added to and taken from a capacitor depends on the charging voltage that is applied to the capacitor. The higher the voltage of a battery or other source of charging voltage the more electrons or the more coulombs will be added to and taken from the capacitor, and the greater will be the final charge as measured in coulombs.

The total quantity of electrons, or the total coulombs, that can be added to and taken from a capacitor depends also on the capacitance of the capacitor is measured in farads or microfarads. The greater the capacitance the more coulombs will be moved into and out of a capacitor by a given charging voltage. We may think of capacitance in farads or microfarads as a measure of the ability of a capacitor to hold electrons just as we think of gallons as a measure of the ability of a tank to hold a certain quantity of water.

TIME FOR CHARGE AND DISCHARGE—If the battery voltage or other voltage that is acting to charge a capacitor remains of constant value the rate of charging becomes slower and slower. The reason is made apparent by Fig. 197 where we have a charging

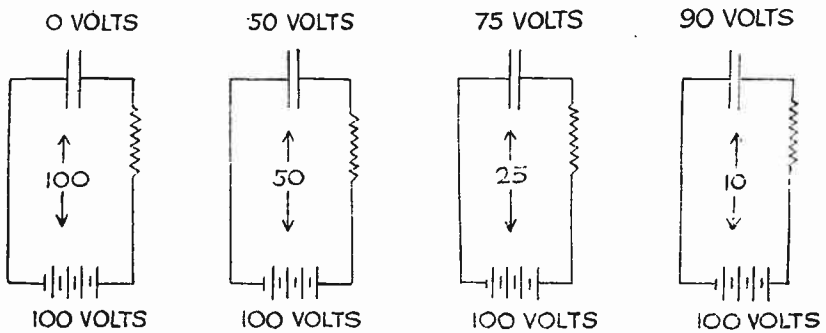

Fig. 197. The greater become the charge and the voltage of the capacitor, the less becomes the voltage difference between source and capacitor, and the slower the charging proceeds.

battery whose potential remains constant at 100 volts while the connected capacitor is being charged. At the left the uncharged capacitor has no voltage and the battery has 100 volts, so the difference of potential acting to charge the capacitor is 100 volts and the charge starts in at a high rate. In the next diagram the capacitor has been half charged, so now it has a potential difference of 50 volts that opposes the battery voltage, and the charge is proceeding at only half the original rate because there is only half the original voltage applied to it. In the following diagrams the capacitor becomes charged to 75 volts, leaving only a 25-volt difference to cause charging, then becomes charged to 90 volts, leaving only a 10-volt difference between battery and capacitor. Thus the difference between the voltage of the battery and that of the capacitor becomes less and less as the charging proceeds, and the rate of charging becomes ever slower.

When a capacitor and a resistor in series are connected to a voltage source, as in Fig. 198, the capacitor will be charged to a voltage equal to 63.2 per cent of the source voltage in a number of seconds equal to the number of microfarads of capacitance multiplied by the number of megohms of resistance. For example, in the left-hand diagram we have 1 microfarad and 1 megohm, and since $1 \times 1 = 1$ the capacitor will be charged to 63.2 volts from the 100-volt source at the end of one second. In each of the other diagrams the number of microfarads multiplied by the number of megohms equals the number of seconds for the capacitor voltage to reach 63.2 per cent of the source voltage.

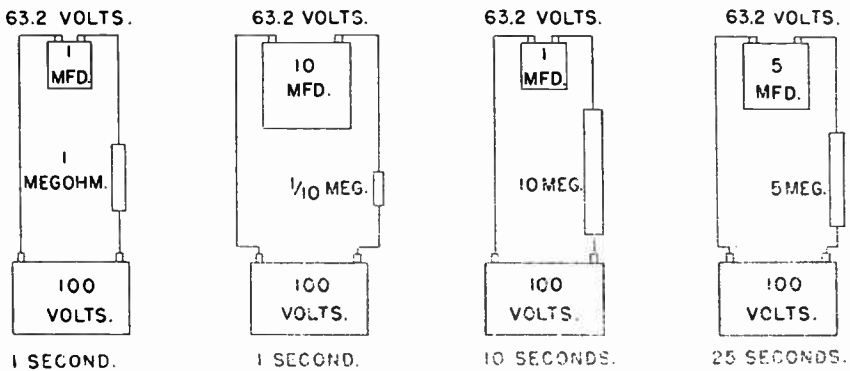

Fig. 198. The time constant for charging a capacitor to 63.2 per cent of the source voltage depends on the capacitance and the resistance.

The time required for the capacitor in series with a resistor to reach a voltage equal to 63.2 per cent of the charging voltage is called the **time constant** of the capacitor-resistor combination.

$$\text{Time constant,} \quad = \quad \text{capacitance,} \quad \times \quad \text{resistance,}$$

$$\text{seconds} \quad \quad \quad \text{microfarads} \quad \times \quad \text{megohms}$$

The times in seconds shown by Fig. 198 are time constants of the capacitor-resistor combinations.

At the end of a time-constant interval the charging does not stop, but continues at a diminishing rate determined by the difference between capacitor voltages and source voltages. The curve of Fig. 199 shows how the capacitor voltage increases with time. At the end of an interval equal to one time constant the capacitor voltage will be 63.2 per cent of the source voltage. At the end of a second equal interval the capacitor voltage will be 86.5 per cent of the source voltage, at the end of a third equal interval it will

be 95 per cent of the source voltage, and at the ends of following intervals will be 98.2 and 99.3 per cent of the charging voltage, and finally will reach the voltage of the source.

A resistor in series with a capacitor not only retards the rate at which the capacitor is charged by an external voltage, but retards also the rate at which the capacitor may discharge and lose its voltage. At the end of an interval equal to one time constant the voltage of a capacitor discharging through a resistor will have dropped to 36.8 per cent of the voltage of the capacitor before it

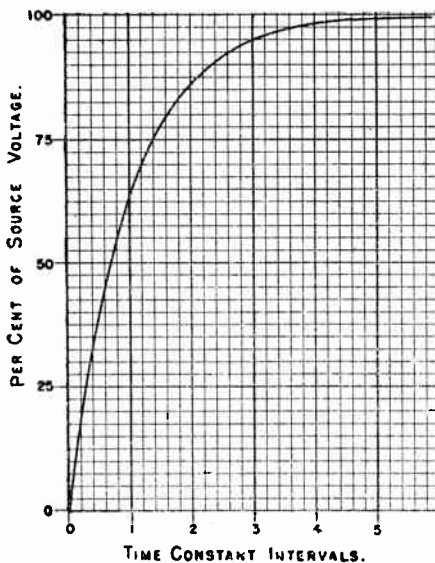

Fig. 199. The rate at which the capacitor is charged becomes less and less with time.

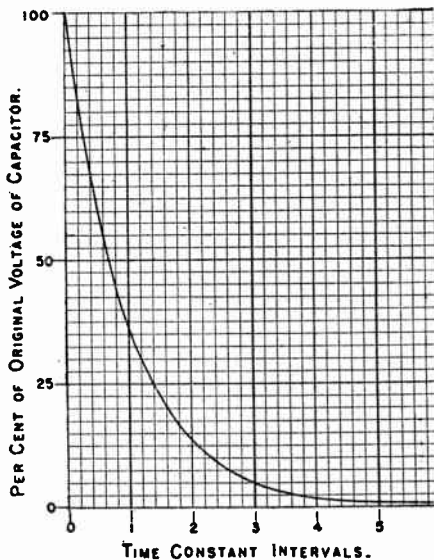

Fig. 200. The time-discharge curve is similar to the time-charge curve, but is inverted.

commenced to discharge. Fig. 200 shows how the voltage of a capacitor drops during discharge through a resistor. After the drop to 36.8 per cent of the original voltage at the end of the first time-constant interval, the drop will be to 13.5 per cent at the end of a second equal interval, then to 5.0 per cent, 1.8 per cent and 0.7 per cent at the ends of following equal times. It will take quite a length of time for the capacitor voltage to drop to zero when there is any considerable resistance in the discharge circuit.

CAPACITOR AND RESISTOR IN PARALLEL—In Fig. 201 we have a capacitor C and a resistor R connected in parallel across a source of voltage or electron flow. The resistances of the conductors

between the source and the capacitor and resistor are so small as to be negligible. Consequently, the capacitor is instantly charged to the same voltage as that of the source and the voltage across the resistor is the same as that of the source. This relation between voltages is indicated by the left-hand diagram.

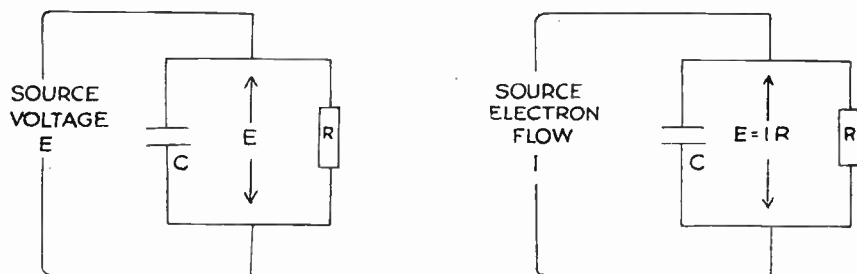

Fig. 201. Voltage across the capacitor becomes equal to the applied voltage, or equal to the product of electron flow and resistance in a paralleled resistor.

If we know only the electron flow from the source, as indicated by the right-hand diagram of Fig. 201, this electron flow in amperes will pass through the resistor. Then the potential difference in volts across the ends of the resistor will be equal to the electron

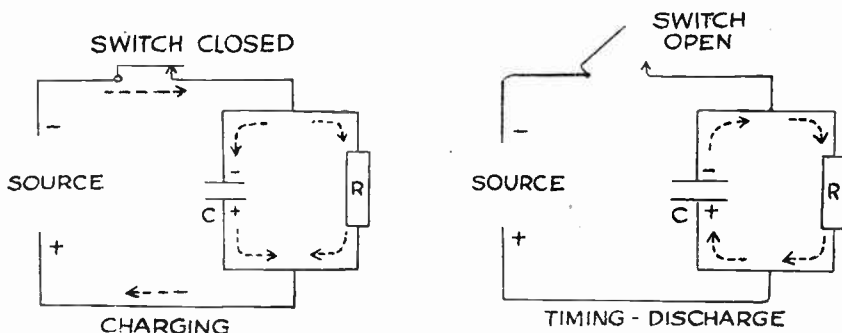

Fig. 202. The capacitor is charged with the switch closed, and the time-delay commences when the switch is opened.

flow in amperes multiplied by the resistance in ohms, or will be equal to IR . Since the capacitor is in parallel with the resistor, the voltage across the capacitor must be the same as that across the resistor, or must be IR .

In Fig. 202 we have placed a switch between the source of voltage and electron flow and the paralleled capacitor and resistor.

In the left-hand diagram the switch is closed and the capacitor is being charged to the same voltage as that of the source. In the right-hand diagram the switch has been opened. Now the voltage of the charged capacitor causes electron flow through the resistor as shown by arrows. The voltage of the capacitor will decrease as in Fig. 200, the time rate of decrease depending on (1) the initial or charged voltage of the capacitor, (2) the ohms or megohms of resistance in the resistor, and (3) the capacitance in farads or microfarads of the capacitor.

By varying the charging voltage, the resistance and the capacitance we have in Fig. 202 an arrangement whereby a voltage (of the capacitor) may be caused to drop to any required value at the end of any desired time interval after the switch is opened. For any given initial voltage the time delay in seconds after opening the switch is directly proportional to the megohms of resistance multiplied by the capacitance in microfarads.

USING THE TIME-DELAY CIRCUIT—Now we are ready to connect the capacitor-resistor time-delay circuit into the grid circuit of an electronic tube, either a vacuum tube or a gas-filled tube. The connections are shown by Fig. 203.

With the switch open, the control grid of the tube is connected through resistor R to the cathode of the tube, so the grid is at zero voltage with reference to the cathode. Assuming that we have a vacuum type of tube, this zero grid voltage will permit enough electron flow in the plate circuit and load to pull in a relay or operate some other kind of load.

Closing the switch connects the negative side of the battery to the tube grid and connects the positive side of the battery to the cathode. Thus the grid is made so highly negative as to cut off all electron flow in the plate circuit. The capacitor C is charged, just as in Fig. 202, so that its plate connected to the tube grid is highly negative with reference to the other plate which is connected to the cathode.

Opening the switch while the capacitor is charged starts the timing period. Now the capacitor discharges more or less slowly through resistor R , the capacitor voltage drops, and since the capacitor is between grid and cathode, the grid becomes less and less negative. At some value of negative grid voltage depending on the kind of tube, the load, and the plate voltage, the electron flow in the plate circuit and load will have increased to a value that operates the load. The time interval between the instant of closing the switch and the instant at which the relay or other load is

operated depends on the initial charging voltage from the battery, on the resistance of the resistor, and on the capacitance of the capacitor.

The time-delay interval may be changed by altering the resistance, the capacitance, or both. Increasing either the resistance or the capacitance increases the time-delay interval. Decreasing either resistance or capacitance decreases the interval. Adjustments usually are made by changing or adjusting the resistance value, because adjustable resistors are simpler and less costly than adjustable capacitors in values that are suitable for use in time-delay circuits.

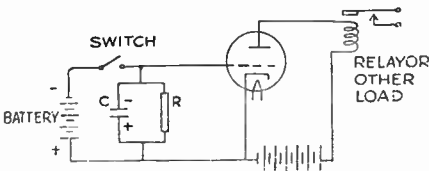

Fig. 203. The capacitor - resistor time-delay combination connected in a grid circuit.

Supposing we have a time-delay circuit in which the capacitor is charged to a maximum of 40 volts, and is connected to make the grid of the tube 40 volts negative when the capacitor is fully charged. Assume also that the capacitor has a capacitance of one microfarad and that the resistor has a resistance of one-half megohm. The time constant then is equal to 1 (microfarad) times $\frac{1}{2}$ (megohm), or to $\frac{1}{2}$ second. The time constant of one-half second is the time for the capacitor to discharge 63.2 per cent of 40 volts, or to have remaining 36.8 per cent of 40 volts, which will be 14.7 volts. Fig. 204 is like the discharge curve of Fig. 200, but is scaled in actual negative grid voltages instead of percentages of the original voltage, and in seconds of time delay instead of in time-constant intervals. Fig. 204 is a discharge curve applied to a practical case.

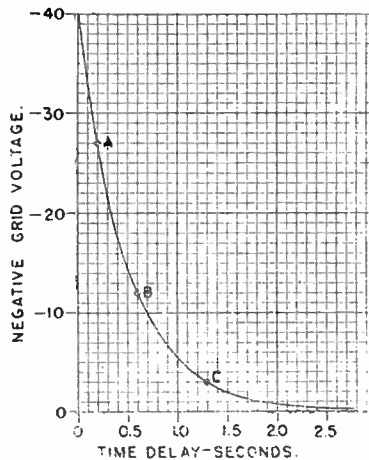

Fig. 204. Actual time delay in seconds depends on the grid voltage at which electron flow in the plate circuit operates the load.

It is apparent from Fig. 204 that the actual time delay in seconds between the opening of the switch and the instant at

which electron flow in the plate circuit operates the load will depend on the negative grid voltage at which we obtain this required electron flow in the plate circuit. If the electron flow is sufficient when the grid becomes 27 volts negative the time interval will be 0.2 second, as shown by point A on the curve. If the grid must become only 12 volts negative to have the needed electron flow the time delay will be 0.6 second (point B), or if the grid must become only 3 volts negative (point C) the time delay will be 1.3 seconds. Thus we find that the actual time delay is not necessarily equal to the time constant of the capacitor-resistor combination; the time constant being useful merely to lay out discharge intervals or a discharge curve as in Figs. 200 and 204.

Relatively long time delays require either a large capacitance or a high resistance. Capacitors of large capacitance increase in cost quite rapidly as the capacitance goes up, while either fixed or adjustable resistors increase but little in cost as the resistance is increased. Consequently, it is less costly to use high resistance than high capacitance for long time delays. But when we use very high resistances in the time-delay circuit these resistances become comparable to the resistance of leakage paths over the surfaces of tube bases and sockets between grid and cathode terminals, and over or through the insulating supports for the resistor, capacitor and other parts of the time delay circuit. If the leakage resistances are low enough in comparison with the timing resistance, the rate of discharge of the capacitor will be affected as much or maybe more by these leakage resistances as by the timing resistance. If we use high-resistance resistors in the timing circuit, and wish to have accurate and dependable timing action, the insulation and the general construction must be of good quality and must be kept clean and free from any deposits through which there may be an electron flow.

CHARGING FROM GRID RECTIFICATION—In Fig. 205 we have a time-delay circuit operated from an a-c voltage source in which the potentials periodically reverse. In this circuit the timing capacitor is charged by d-c electron flow secured by using the control grid and cathode of the tube as the two elements of a rectifier. When the control grid is positive and the cathode negative, there will be an electron flow from cathode to grid in just the same way as there is flow from the negative cathode to the positive plate in a two-element rectifier. Since there is electron flow only from cathode to grid, with the grid positive and the cathode negative, and there can be no flow in the opposite direction when the grid

is negative and the cathode positive, we have a one-way or a d-c electron flow in the grid circuit. We are securing a direct electron flow by the method called grid rectification.

In diagram 1 of Fig. 205 the grid of the tube is connected through timing capacitor C and resistor R to a voltage divider between the two sides of the a-c supply line. When the line potentials are positive and negative as shown, the grid connection on

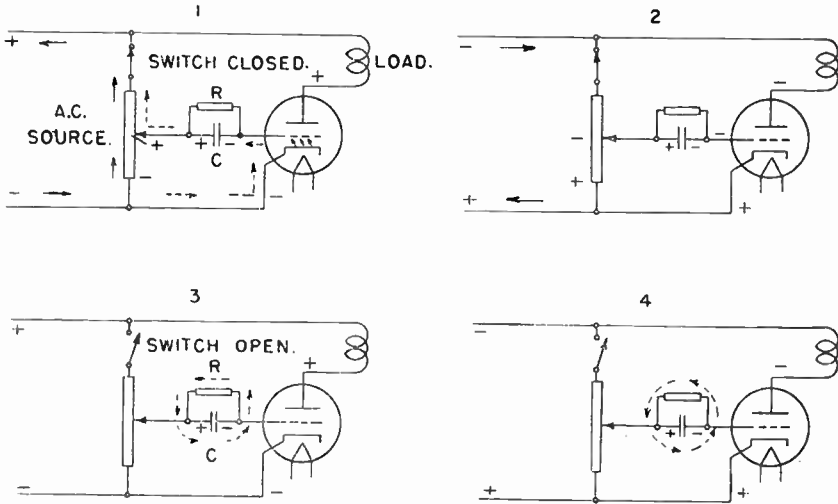

Fig. 205. A time-delay circuit operated directly from an a-c source.

the voltage divider is more positive than the cathode connection, and there is electron flow from the negative cathode to the positive grid and to the grid side of the capacitor, which thus is negatively charged. From the other side of the capacitor there is electron flow back to the positive line, leaving this side of the capacitor with a positive charge. The capacitor will be charged to a voltage equal to the voltage drop between the grid connection (+) and the lower end (—) of the voltage divider.

In diagram 2 the supply line potentials have reversed. Because the grid of the tube now is negative with reference to the cathode there can be no electron flow from grid to cathode, and the capacitor cannot discharge through the tube. Because the plate of the tube is negative with reference to the cathode there can be no electron flow in the plate circuit and the load. In diagram 1 there can be no plate circuit electron flow because the grid is so highly negative due to the charge on the condenser.

In diagram 3 the switch has been opened to disconnect the voltage divider from the supply line or source. The source potentials are the same as for diagram 1. Now the time delay commences as the capacitor discharges through resistor R. The plate of the tube is positive with reference to the cathode, so, as soon as the capacitor voltage falls to a value permitting electron flow in the plate circuit this flow will be established through the load.

If the timing interval lasts longer than during a half-cycle of the supply voltage, the half-cycles during which the plate is negative will be represented by diagram 4. The capacitor still discharges through the timing resistor, but even though the capacitor voltage falls to the value for plate circuit electron flow there will be no such flow during this half-cycle when the plate is negative.

Movement of the slider along the voltage divider changes the maximum voltage to which the capacitor is charged. Since the value to which the grid voltage will have is dropped at any instant depends on the voltage from which the discharge started it is apparent that the length of the time-delay may be varied by adjustment of the slider. The higher the slider is moved on the voltage divider the greater will be the charging voltage and the longer the time delay for whatever combination of capacitor and resistor are used.

TIME-DELAY RELAY—Fig. 206 shows a time-delay circuit using a type 2051 shield-grid thyatron (or gas tetrode) tube and a double-throw electromagnetic relay with normally closed contacts between terminals 1 and 2, and with normally open contacts between terminals 2 and 3. The timing combination consists of capacitor C1 and resistor R1, with maximum charging voltage determined by the position of the slider on the 250,000-ohm voltage divider. The 50,000-ohm resistor in series with the voltage divider limits electron flow through the divider and brings control grid voltages into the desired portion of the total voltage drop. The 10,000-ohm resistor completes the tube cathode circuit while the capacitor is being charged.

As shown in Fig. 207, capacitor C1 is charged by grid rectification with electron flow from the a-c source during the half-cycle when the upper line is negative and the lower one positive. With the switch open, as shown, the cathode of the tube is connected to the negative side of the line through the 10,000-ohm resistor, while the control grid is connected to the positive side of the line through resistor R1 and the voltage divider. With the control grid thus positive with reference to the cathode there will be electron

flow in the direction indicated by broken-line arrows. This direction of electron flow charges negatively the side of capacitor C1 that is connected to the control grid, and charges positively the other side of the capacitor.

The switch is operated from whatever apparatus is to control the timing. When the switch is closed the time-delay period begins. Capacitor C1 has been charged to a voltage sufficiently high that

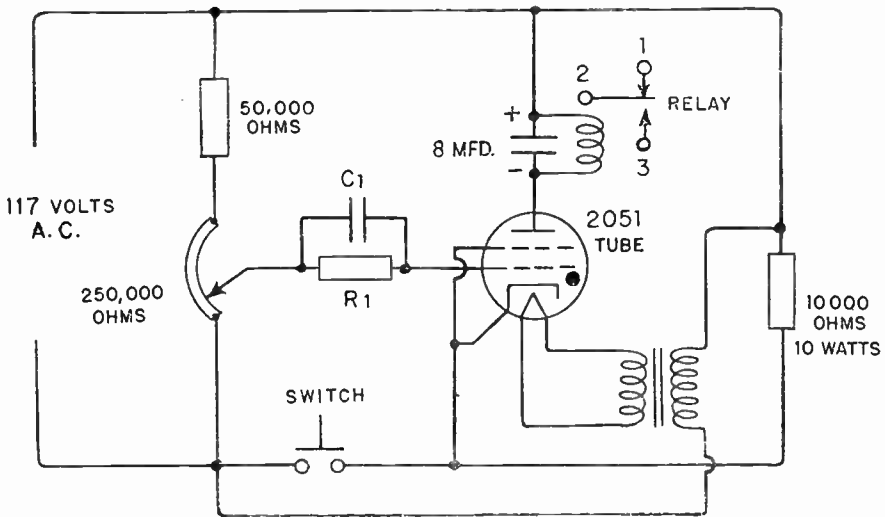

Fig. 206. The circuit for a time-delay apparatus using a gas-tetrode and a double-throw electromagnetic relay.

its negative potential on the control grid side, and the resulting negative potential of the grid, prevents electron flow in the plate circuit and relay even during half-cycles in which the plate is positive with reference to the cathode.

Capacitor C1 is now discharging through resistor R1 to a lower and lower voltage. When the capacitor voltage and the negative voltage of the control grid drop low enough there will be electron flow in the plate circuit and relay during half-cycles in which the plate is positive with reference to the cathode. Then the relay will pick up, will open the contacts between 1 and 2, and will close the contacts between 2 and 3. Thus, at the end of the time delay period, the relay will either close or open the load circuit, depending on whether this circuit is connected to terminals 2 and 3, or to 1 and 2.

Note that with the line voltages as shown in Fig. 207 there will be some electron flow from the negative side of the line through the 50,000-ohm resistor and the voltage divider to the positive side of the line. However, the combined resistance of the 50,000-ohm unit and the portion of the divider resistance above the slider is so much greater than the resistance of the 10,000-ohm unit that most of the flow during this half-cycle is as shown by the arrows.

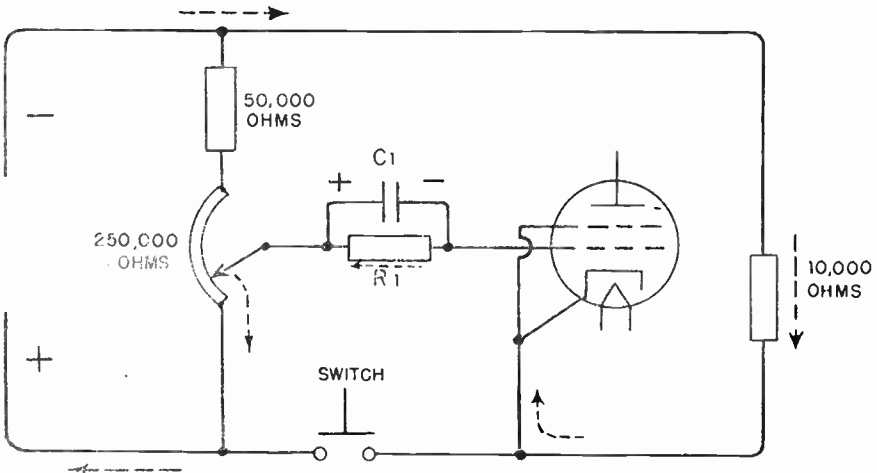

Fig. 207. The timing capacitor is charged by grid rectification while the switch is open.

THE SMOOTHING CAPACITOR—When an electromagnetic relay is operated by electron flow from a tube operated directly from an a-c source the coil of the relay receives one-way or direct electron flow, but it receives this flow only during the half-cycles of alternating potential which make the tube plate positive and the cathode negative. The relay tends to drop out during the half cycles when there is no electron flow in its coil, and there is quite likely to be chattering or vibration of the relay armature to an extent that damages the contacts and that partially or wholly interrupts electron flow in the external load circuit. Such chattering may be prevented by connecting across the ends of the relay coil a smoothing capacitor of suitable capacitance, as is done in the circuit of Fig. 206.

During the half-cycles in which there is electron flow from the tube plate through the relay coil the voltage across the relay coil charges the smoothing capacitor. During the alternate half-cycles, when there is no electron flow through the tube, the capacitor dis-

charges through the relay coil, thus providing an electron flow through the coil during the periods when the tube is not conducting. The relay must discharge through the relay coil, not through the tube, because during these half-cycles the tube plate is negative, and electron flow cannot pass from a negative plate to the positive cathode in the tube. The capacitance of the smoothing capacitor must be great enough, and the charging voltage high enough, so that the discharge through the relay coil is enough to hold the armature steady. The capacitance in microfarads depends on the resistance of the relay coil, on its magnetic properties, and on the electron flow needed to hold the relay armature. Capacitances usually are between one and eight microfarads.

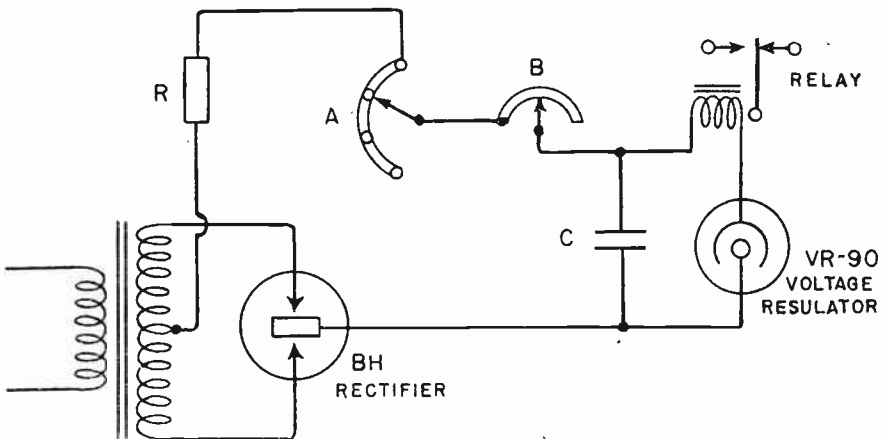

Fig. 208. A trigger-type time-delay relay using a full-wave rectifier and a voltage regulator tube.

A TRIGGER-TYPE TIME-DELAY RELAY—Fig. 208 shows the circuit for a time-delay relay apparatus in which capacitor C is charged by d-c electron flow from a BH cold-cathode rectifier at a time rate determined by resistors R, A and B which are in series with one another, the capacitor, and the rectifier. The rheostat at A is a range adjustment or a rough adjustment for the timing, while B allows a more exact setting to some particular time period.

The VR-90 voltage regulator is a gas-filled two-element tube which breaks down and allows electron flow through it when the potential difference across the tube reaches a minimum of 125 volts. Consequently, at the end of a time period in which capacitor C is charged to this voltage, there is a discharge electron flow

through the relay coil and the VR-90 tube which causes the relay to pull in. The relay then drops out until the capacitor again becomes charged to the voltage that causes another breakdown of the VR-90 and another capacitor discharge through the relay.

COPPER-OXIDE RECTIFIERS—In time-delay circuits and in other applications d-c electron flow may be required. Where it is necessary to charge a capacitor, for example, the charging must be done with a one-way or d-c electron flow, since an alternating flow would merely charge the capacitor during one half-cycle and discharge it during the following half-cycle. The d-c electron flow for charging may be obtained from a battery or through the process of grid rectification when the circuits permit such methods, but in many cases it is more convenient to obtain the d-c electron flow from a copper-oxide rectifier.

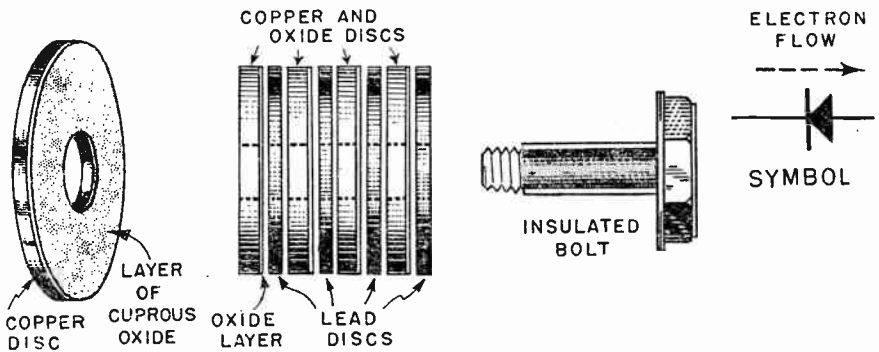

Fig. 209. The copper-oxide rectifier and its construction.

A copper-oxide rectifier, as shown by Fig. 209, consists of a disc of copper which has been heated and cooled to produce a surface layer of cuprous oxide. The oxide layer is allowed to remain on one face of the disc. When a potential difference is applied across the copper and the disc there will be a practically free electron flow from the copper into the oxide layer, but only a negligible flow in the opposite direction, from the oxide layer to the copper. The junction between the copper and the oxide permits only a one-way electron flow, so acts as a rectifier which will produce a one-way flow or a d-c electron flow from an alternating potential difference.

Each rectifying disc will withstand only a limited potential difference, so it is common practice to allow handling higher potentials with a number of discs assembled in series. The assembly usually is made by placing discs of soft lead between pairs of recti-

fyng discs, as illustrated in Fig. 209, then drawing the assembly securely together by means of an insulated bolt. The lead discs provide a conductive connection from the oxide layer on one rectifying disc to the copper on the following rectifying disc, but have no part in the rectifying action.

The symbol for a copper-oxide rectifier, or for any other similar "dry rectifier" is a triangle against a straight line. Electron flow is in the direction from the straight line to the triangle. This symbol represents one or more rectifying discs as may be required to form an element capable of handling the circuit voltages.

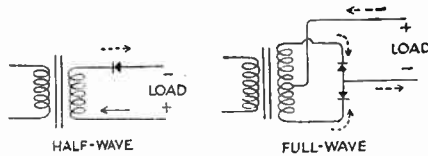

Fig. 210. Half-wave and full-wave circuits for the copper-oxide rectifier.

Fig. 210 shows a half-wave rectifying circuit using a single copper-oxide rectifier, also a full-wave circuit using two rectifier elements with a center-tapper transformer secondary winding. The rectifier in the half-wave circuit might be connected directly to one side of the a-c supply line were the line voltage not too high for the rectifier rating.

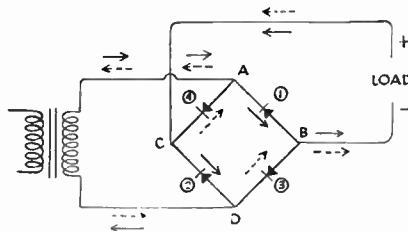

Fig. 211. A bridge circuit using four copper-oxide rectifier elements and an untapped secondary winding for full-wave rectification.

Fig. 211 shows a bridge rectifier employing four rectifying elements connected as shown, either to an untapped transformer winding or directly across an a-c supply line when the rectifier voltage rating is suited to the line voltage. During one of the half-cycles the electron flow is as indicated by full-line arrows; from the top of the transformer secondary to A, through rectifier 1, to B,

through the load to C, through rectifier 2, to D, and back to the lower end of the transformer winding. On the alternate half-cycle the electron flow is as indicated by broken-line arrows; from the lower end of the transformer winding to D, through rectifier 3, through the load to C, through rectifier 4 to A, and back to the upper end of the transformer winding.

Note that in the bridge circuit rectifier elements 1 and 2 carry electron flow during one-half cycle, while rectifiers 3 and 4 carry the flow during the alternate half-cycle. Two rectifier elements are in series with each other during each half-cycle. Electron flow through the load is, of course, in the same direction for both half-cycles.

The copper-oxide rectifier allows some reverse flow during the half-cycles between those in which there is practically free forward flow. However, the reverse flow ordinarily is only about one milli-ampere for each ampere of forward flow with the same potential difference in both directions. Higher temperature of the rectifier allows somewhat greater electron flow in both directions, but excessive operating temperatures quickly and permanently damage the rectifier. These rectifiers have a life of several years in constant operation when rated voltages and electron flows are not exceeded. The life is much extended by keeping the operating temperature under 140° F. The rectifier output drops with age, even though the rectifier is not used more than a small part of the time. The drop is gradual at first, then levels off.

Other dry rectifiers are made with selenium and iron, in which electron flow is from selenium to iron, and others are made with magnesium, cupric sulphide and copper, in which electron flow is through the substances in the order named. Dry rectifiers are used to provide d-c electron flow for battery charging, for the operation of magnets and solenoids, for the firing of ignition tubes, for operation of small d-c motors, with many types of relays, and in combination with d-c types of electric meters for measurement of a-c electron flows and voltages.

Chapter 14

THE IGNITRON

Ignitron Construction — The Ignitor — Operation and Action — Ignitor Control Circuits — Mounting and Care of Ignitrons.

We have studied kenotrons and pliotrons which are capable of carrying electron flows no greater than an ampere, we have studied phanotrons and thyratrons whose electron flows may be measured in tens of amperes, and now we come to the ignitron which easily carries hundreds of amperes.

The electron-carrying ability of the vacuum kenotrons and pliotrons is limited largely by the heating produced by electron flow through the high resistance of the evacuated space. This resistance is reduced to a negligible amount in the gas-filled or vapor-filled phanotrons and thyratrons, but then we come up against the limiting effect of cathodes which may be ruined by excessive emission. In the ignitron we retain the vapor-filled feature to reduce the internal voltage drop and heating due to internal resistance, and instead of a solid or coated cathode we use for the cathode a pool of liquid mercury. The surface of the pool is continually shifting as the mercury evaporates and condenses, and the electron emitting ability is almost unlimited, without the slightest danger of damaging the cathode.

Away back in Fig. 10 we looked at the outside of a medium sized ignitron. The inside of this tube is illustrated in Fig. 212, and in Fig. 213 the parts are shown and named on a sectional drawing. Here is shown also the usual symbol for an ignitron. The cylindrical jacket of the tube illustrated in Figs. 10 and 212 is less than $9\frac{1}{2}$ inches long and only a little more than four inches in diameter, yet it will continually carry an average electron flow of nearly 150 amperes, will handle nearly 5,000 amperes for brief periods, and will withstand the almost unbelievably high surge of 13,500 amperes at 250 volts.

The envelope of this ignitron is a double-walled cylindrical steel jacket. Water is circulated through the jacket to remove excess heat and thus maintain a suitable temperature and pressure of the mercury vapor which evaporates from the liquid pool. The

anode is of graphite, supported in the top of the shell by an insulating seal of glass, and connected to the external load circuits through a large, flexible cable.

The electron-emitting cathode is the mercury pool in the bottom of the metal shell. The cathode connection in medium and large sized ignitrons is a strong lug extending from the bottom

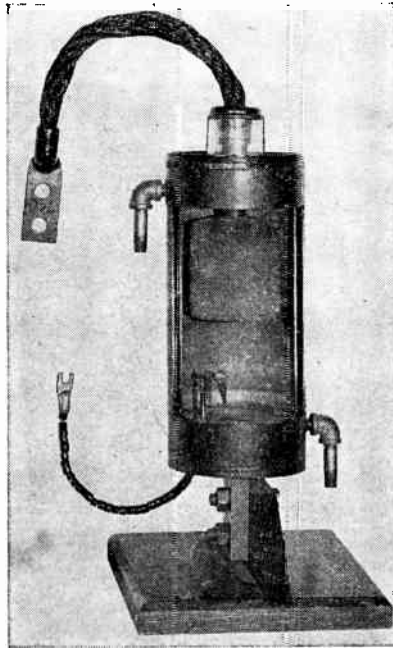

Fig. 212. The internal construction of a FG-235-A ignitron, as shown with part of the envelope cut away.

of the shell to provide a mounting as well as an electrical connection. Since the liquid mercury is in direct contact with the steel shell, the entire outer shell and jacket are always at the same potential as the cathode. Therefore, never touch the shell of these tubes while the circuit is energized.

THE IGNITOR—In any type of tube having a cathode of liquid mercury the electron flow from cathode to anode will take place only after ionization is caused to take place in mercury vapor between cathode and anode. The necessary ionization is started

by producing a small spark or arc at the surface of the mercury, between the mercury and some other electron-carrying electrode. Before the coming of the ignitron most starting devices were of types requiring some kind of mechanical motion to break contact between the starting electrode and mercury, whereupon the re-

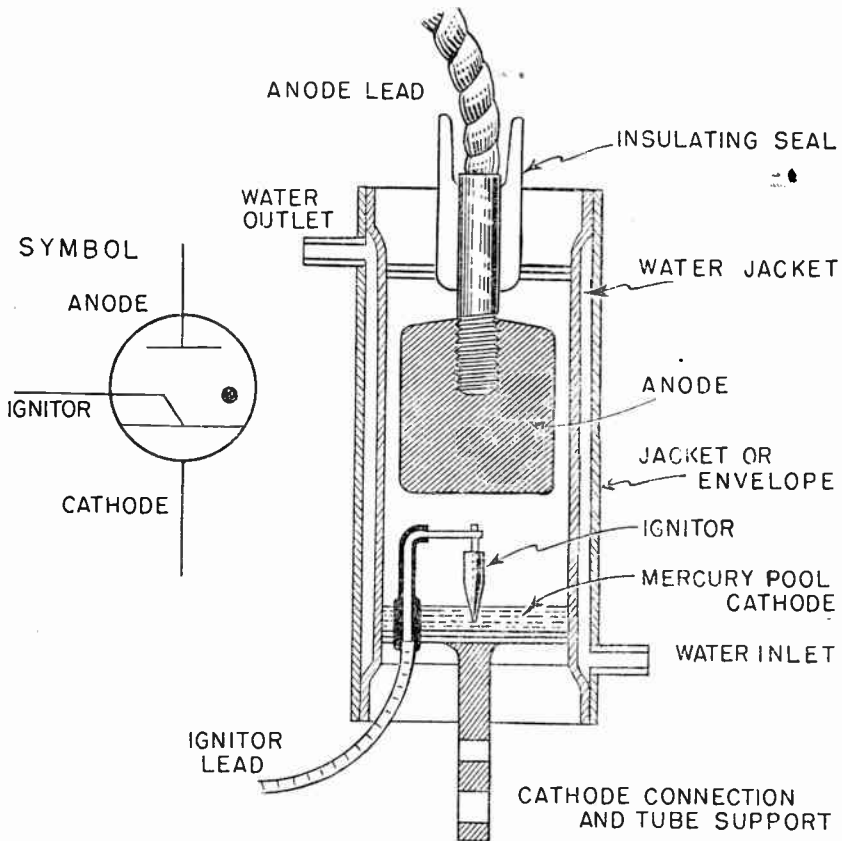

Fig. 213. The names of the various parts of a sealed water-jacketed ignitron.

sulting arc ionized some of the vapor and permitted electron flow to transfer instantly to the cathode-anode path.

The great advantage of the ignitron is that the starting arc is produced by a stationary electrode, called the ignitor, which dips a little ways below the surface of the mercury as shown in Fig. 213. The ignitor electrode is made of silicon carbide or other hard, crystalline substance of rather high resistance in proportion to its size.

While the ignitor is made momentarily positive with reference to the cathode, as in Fig. 214, if the electron flow is great enough from cathode to ignitor a small arc is produced at the imperfect contact between the mercury and some part of the crystalline surface of the ignitor. If, at this instant, the anode is sufficiently positive with reference to the cathode, the ionization allows an immediate electron flow from cathode to anode.

Now the ignitor has done its work, so its circuit is opened as shown in the second diagram of Fig. 214. Were electron flow allowed to continue in the ignitor circuit the ignitor would be seriously overheated. The sole function of the ignitor is to start the electron flow from cathode to anode, just as the function of

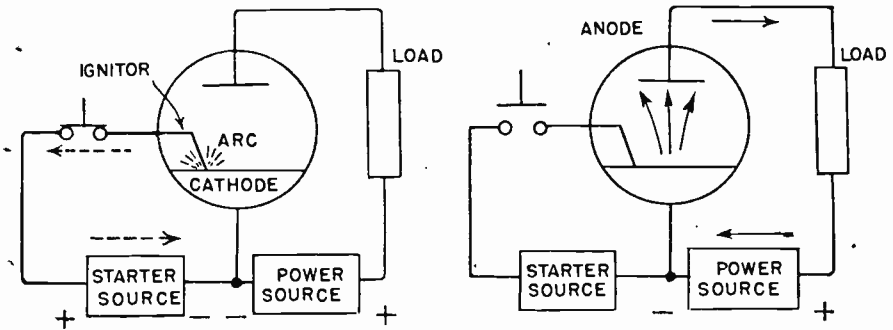

Fig. 214. Electron flow from cathode to ignitor causes an arc which starts ionization and allows the main cathode to anode flow.

the grid in a thyratron is to start cathode-plate electron flow in that tube. The instant during an a-c cycle at which cathode-anode electron flow begins in the ignitron is determined by the time of ignition or by the time at which the ignitor establishes the electron flow between the mercury and itself. This timing of the main electron flow in the ignitron is similar to the timing obtained in grid-controlled thyratrons. The cathode-anode electron flow stops only when the cathode-anode voltage drops to zero, again just as with a thyratron.

The ignitron is a form of cold-cathode tube, in that electron emission takes place without the necessity of heating the cathode from some external source of power. Once the main electron flow commences it is maintained by the high "voltage gradient" near the surface of the mercury, just as was explained when studying the action of other cold-cathode tubes.

Some ignitrons are provided with two ignitors, with only one connected into the operating circuits and the other held in reserve. Some types have an additional small anode, or an auxiliary anode, which relieves the ignitor from carrying electron flow once the main flow has commenced. Ignitrons many times larger than those for welding and small industrial work are employed in the manufacture of metals and chemicals on a large scale, in railway propulsion, in steel mills, and in mining, where single sets of these tubes or "tanks" handle millions of watts of electrical power. Such large ignitrons are not permanently sealed, but are kept continually evacuated by pumping equipment.

IGNITRON OPERATION AND ACTION—Ignitrons are able not only to carry very large average electron flows for their size, but the permissible peak rates of flow are even larger, relatively, than in other tubes. Once the mercury vapor within the tube is ionized, it would be just as easy for electron flow to pass from the cold anode to the cold cathode as from cathode to anode. Consequently, the maximum peak inverse voltage for an ignitron is the same as the maximum peak forward voltage, whereas in hot cathode tubes the inverse voltage is much higher than the forward voltage.

As with other vapor-filled tubes, the operating voltage drop through the ignitron is very small. The drop ordinarily is something between 10 and 20 volts. It increases somewhat with an increase of instantaneous or peak anode electron flow, and varies with the temperature of the mercury vapor, with the age of the tube, and between various tubes.

The ignitor starts the main electron flow in the tube with a pulse of electron flow in the ignitor circuit that lasts at a maximum only $1/10,000$ second. However, the electron flow during this pulse may have to be as great as 40 amperes and the potential drop may have to be from 125 to 250 volts. Although the electron flow and voltage are high, the ignition time is so exceedingly short that negligible energy is required. Ignition is sure to occur when either the maximum required electron flow passes or when the maximum required voltage is applied between ignitor and mercury.

IGNITOR CONTROL CIRCUITS—The ignitron may be used as a heavy-duty rectifier, with no control of the timing or of the average rectified d-c electron flow other than through changes of applied voltage and of load resistance or impedance. Such a rectifier circuit is shown by Fig. 215 where we have a small rectifier tube, marked "firing rectifier," connected between the supply line

and the ignitor of the ignitron. During the half-cycle in which the cathode of the ignitron is negative, the anodes of both tubes will be positive, and the cathode of the firing rectifier will be negative because it is directly connected to the negative cathode of the

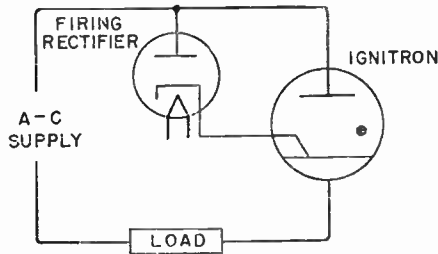

Fig. 215. An ignitron used as an uncontrolled heavy-duty rectifier.

ignitron. Electron flow from the ignitron cathode through the ignitor and the firing rectifier will cause the ignitron to break down or to "fire" and conduct electron flow for the load circuit. On the following half-cycle, with electrode voltages reversed, there will be no firing and no conduction for the load.

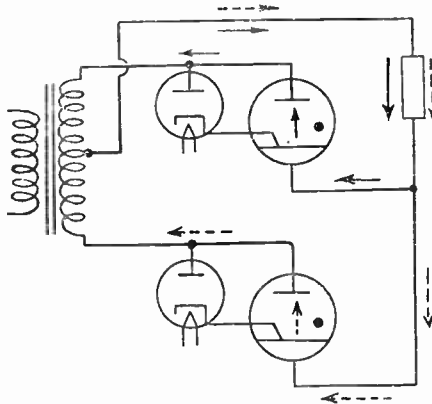

Fig. 216. A full-wave heavy-duty rectifier circuit with two ignitrons.

Fig. 216 shows a full-wave rectifier circuit using pairs of ignitrons and firing rectifiers. Electron flow through one of the ignitrons and the load is shown by full-line arrows for one half-cycle, and by broken-line arrows for the alternate half-cycle. Instead of the tube-type firing rectifiers shown in Figs. 215 and 216

it would be entirely practicable to use copper-oxide rectifiers. With copper-oxide rectifiers there may be a resistor in series with the rectifier to prevent excessive electron flow in the firing circuit, also a fuse or breaker to protect parts of the firing circuit in case of overload.

Fig. 217 shows a thyatron substituted for the firing rectifier. Now there can be electron flow through the ignitor circuit, which contains the thyatron, only when the thyatron breaks down. The grid voltage of the thyatron may be controlled by any of the methods explained when studying thyatron control systems,

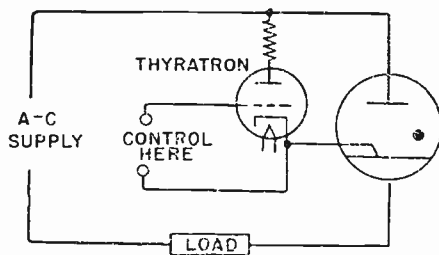

Fig. 217. The thyatron grid circuit is used to control the instant of breakdown in the thyatron and of firing of the ignitron.

and it might be controlled with the help of a time-delay system. Thus, by control of small voltages and electron flows in the thyatron grid circuit we may control the instant during a half-cycle at which the ignitron breaks down or fires.

As soon as the ignitron breaks down and conducts electron flow between its cathode and anode, the voltage drop through the ignitron (which is also the voltage drop across the paralleled thyatron) becomes too small to maintain conduction through the thyatron circuit with its extra resistor. Then the thyatron ceases to conduct and electron flow is cut off in the ignitor circuit before the ignitor has time to overheat.

The basic circuit of Fig. 217 is one with which we may control the average electron flow through the ignitron by allowing the firing to occur at any desired instant during the half-cycle in which the ignitron anode is positive. The result on electron flow in the ignitron load circuit is just like the flow in a thyatron load circuit when we control the instant of thyatron breakdown—this being something which we studied in considerable detail when discussing

thyratrons. With this general method of ignitron control, the thyatron most often is controlled by some phase-shift method. The phase-shift control applied to the thyatron is, in effect, carried right through the thyatron and applied to the ignitron, so that the ignitron becomes a controlled rectifier.

Fig. 218 is a full-wave rectifier circuit similar to the circuit of Fig. 216 except for having thyratrons as control tubes instead of the simple firing rectifiers. Just as the circuit of Fig. 217 provides a half-wave controlled rectifier circuit, so Fig. 218 provides a full-wave controlled rectifier circuit.

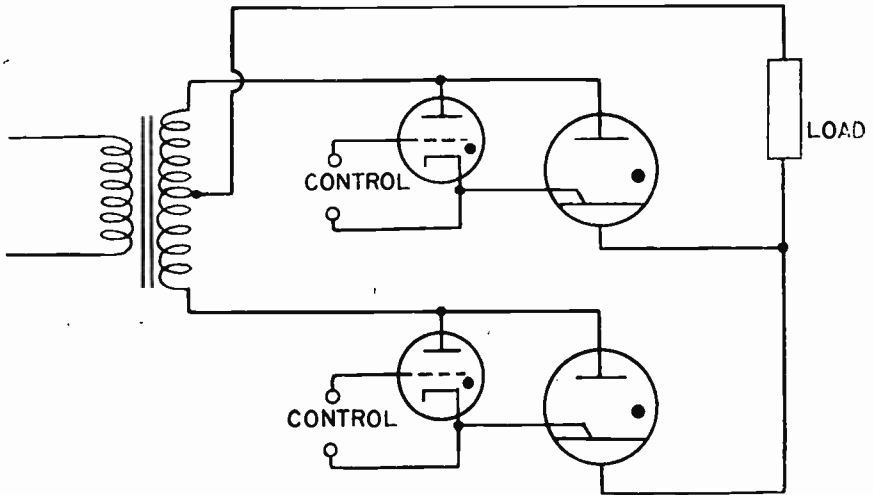

Fig. 218. A full-wave controlled rectifier circuit with thyratrons to control the firing of the ignitrons.

In the ignitron circuits at which we have been looking, electron flow for the firing control tube, whether it be a two-element rectifier or a thyatron, comes from the a-c supply line or the load circuit. In Fig. 219 the control thyatron receives its electron flow from a separate circuit energized by the transformer.

In Fig. 219 the capacitor C is charged as shown by one-way flow through the dry rectifier during the half-cycles when the upper end of the transformer secondary winding is positive and the lower end negative. The charging flow is indicated by broken-line arrows. When the grid-cathode voltage on the thyatron is made of the value for breakdown of the thyatron, the capacitor discharges through the path indicated by full-line arrows.

The pulse of electron flow due to discharge of the capacitor flows from cathode to ignitor in the ignitron, causing the ignitron to fire. This electron flow passes from the ignitor through the thyatron and an inductor L which limits the rate at which electron flow increases through the ignitor. Circuit connections are such that the ignitron anode is negative during the half-cycles in which the capacitor is being charged.

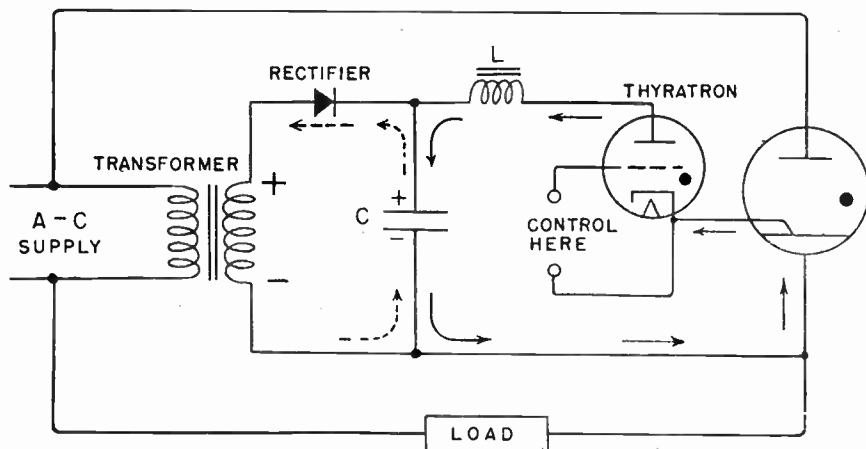

Fig. 219. An ignitron control circuit supplied with power from a separate source (the transformer) rather than from the a-c supply line for the ignitron.

MOUNTING AND CARE OF IGNITRONS—Because of their mercury pool cathode, ignitrons must be mounted only in a vertical position with the cathode connection down and the anode lead up. Tubes with bottom lugs such as shown in Figs. 212 and 213 are bolted by means of this lug to a bus bar large enough to provide secure support and ample carrying capacity for the amperes of electron flow. The flexible anode connection must not be pulled so tightly as to put possible strain on the glass insulating bushing.

Shock or any unusual vibration may disturb the surface of the mercury enough to cause operating trouble. It is possible that during shipment or handling of ignitrons the liquid mercury has caused a short circuit from the anode to the steel shell or jacket. Such trouble will be disclosed by a test lamp. It may be relieved by holding the tube in a half horizontal position and striking it with your bare hand. Sudden tilting of an ignitron may cause the mercury to displace or damage the ignitor.

Leads to the ignitor should not be run close to conductors carrying large electron flows, such as welding leads, or near any conductors in which there may be sudden and large changes of electron flow, or near any wiring carrying high-frequency electron flows, since it is possible for any of these to set up potential differences which will fire the ignitron.

You must keep in mind that while ignitrons are in operation, or while the supply circuit is completed, the entire tube is alive. The shell and exposed metal are at the potential of the cathode side of the circuit, and the anode lead is at anode potential. An ignitron **never should be touched** while the supply circuit is closed.

Chapter 15

WELDING CONTROLS

Types of Resistance Welding — Time Controls for Welding — Sequence Timers — Ignitron Power Control — Leading-tube, Trailing-tube Circuit — Sequence Timing — Timer for Four-period Sequence — Synchronous Timing — Peaking Transformers — Heat Control — Series Transformer Control — Timing for Seam Welding — Energy Storage Systems — Series Capacitors.

Electronic controls have made electric welding a precision process capable of handling in a much improved manner all not only the steels which always have been electrically welded, but aluminum and other low- and high-resistance alloys which have been difficult or impossible to weld in the past, and of doing all this efficiently in every field from small scale assembly to mass production.

Electronic controls have been developed chiefly in resistance welding, the process of joining metals by melting small areas while they are brought together under pressure, then letting the metal cool to form a solid junction. The heat for melting is produced by electron flow of thousands or even tens of thousands of amperes through the electrical resistance of the metal and the surfaces in contact.

For spot welding, which is one kind of resistance welding, the pieces of metal to be joined are held between so-called "electrodes" of copper alloy, such as may be seen above and below the work piece held by the operator in Fig. 220. At either side on the front of the welding machine are the electronic control adjustments. Within the housing of the machine are the controls, also a transformer whose primary winding receives a-c electron flow regulated by ignitrons, and whose secondary winding delivers electron flow to the electrodes at potential differences of only 1 to 20 volts.

In the majority of welding controls, thyratrons regulate the instants at which electron flow passes through the ignitrons, the fractions of a second that each flow continues, and in many cases the average value of the flow in regulating the temperature to which the weld is heated.

TYPES OF RESISTANCE WELDING—Fig. 221 illustrates several methods of resistance welding. In spot welding the two pieces of the work are joined in a small circular spot between the ends of the electrodes where the concentrated pressure permits most of the electron flow to pass. For butt welding the two pieces of work

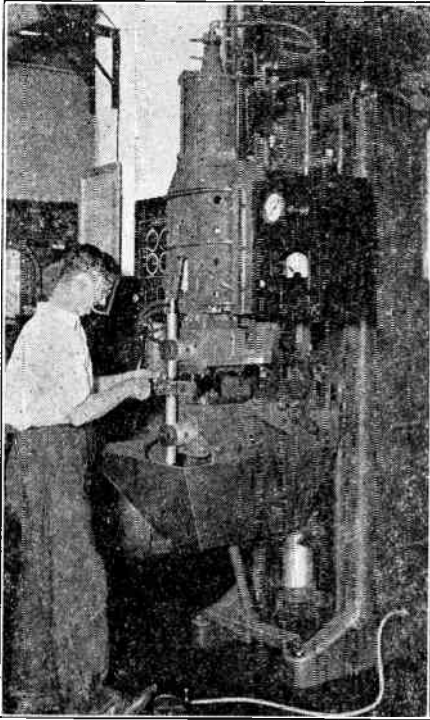

Fig. 220. A spot and projection welding machine with timing adjustments on the panels in front of the machine. The electronic controls are mounted inside the welding machine.

are clamped in dies and pressed together at the point where the weld is to be made. In seam welding the parts to be joined are passed between copper rollers which act as the electrodes for short periods of electron flow which form many successive welds, which either may be spaced apart or may overlap to form a continuous joint. For projection welding one or both of the sheets to be joined is rolled or otherwise formed with small projections which make contact where the welds are formed.

Pulsation welding is a variety of spot welding in which the work pieces remain under pressure while several electron flows are passed through them with intervening periods of no flow. Each pulse of electron flow produces at the contacting surfaces of the work pieces heat which escapes slowly during

the periods of no electron flow, thus permitting the retained heat to finally produce the welding temperature. The copper-alloy electrodes, which are cooled with circulating water, lose their own heat rapidly during the periods of no electron flow. The result is relatively cooler electrodes on welds which require a considerable total electron flow or total heating of the welded metal.

Flash welding is a variety of butt welding in which high temperature is produced by arcing or flashing between parts of

the work brought together first with comparatively light pressure which is increased when the parts reach welding temperature.

TIME CONTROLS FOR WELDING—The simplest resistance welding operation is for a single spot weld. Such a weld requires at least three operations.

1. Bringing the electrodes onto the work and applying the necessary pressure. This may be done by hand or foot power, with levers, or may be done by an electric motor and cams, or it may be done with compressed air or a liquid working in a cylinder with a piston connected to one of the electrodes. In electronically controlled automatic welding the time period between first turning on the power and the instant at which welding electron flow com-

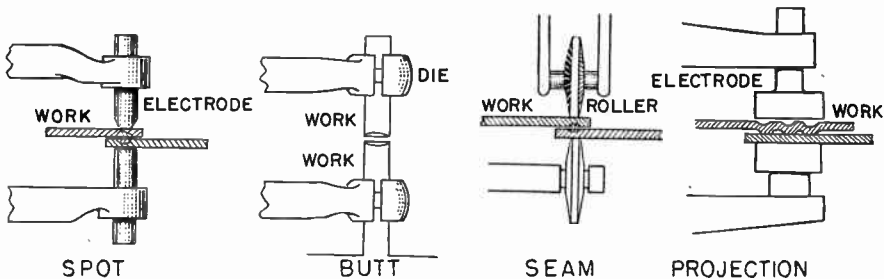

Fig. 221. Four methods of resistance welding.

mences is called the squeeze time. The squeeze time allows for bringing the electrodes onto the work and building up the necessary pressure. Pressure usually is applied by compressed air or a liquid whose flow is controlled by an electrically operated or magnetically operated solenoid valve connected to the time system. The squeeze time is adjustable from 1/20 second to 1 full second.

2. The next operation is that in which electron flow passes through the work being welded. This period is called the weld time. It may be adjusted to between 1/20 and 1/2 second.

3. After the welding electron flow is stopped, pressure is maintained on the work pieces for long enough to let the molten or plastic metal cool and solidify or set. This period is called the hold time. It is adjustable from 1/20 second up to 1 full second.

Welding time intervals or periods ordinarily are specified and controlled not in seconds and fractions of a second, but in cycles. With 60-cycle supply each cycle takes 1/60 second. Then, instead of adjusting a time to 1/20 second, we adjust it to 3 cycles; instead of 1/2 second we speak of 30 cycles, and instead of one second we say 60 cycles.

If we are doing pulsation welding the weld time will consist of several heating periods alternating with periods of no electron flow during which the electrodes may cool. The alternate periods are called heat time and cool time, and the total period of alternate heating and cooling is called the weld interval. Fig. 222 illustrates the arrangement of time periods for plain spot welding and for pulsation welding. Heat times may be adjusted from 3 to 30 cycles, as may also the cool times. The weld interval may be set to extend as long as 300 or 360 cycles, five or six seconds in all.

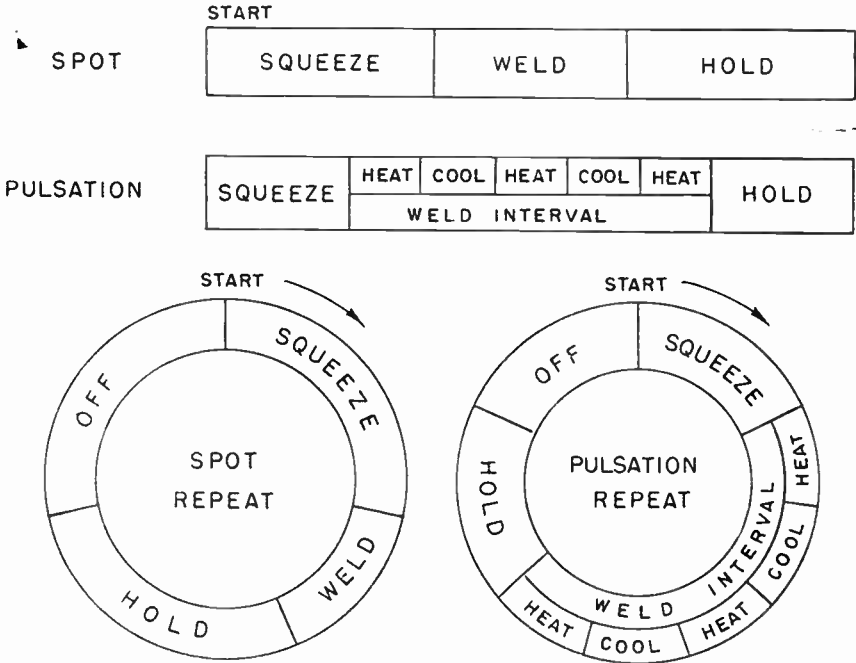

Fig. 222. The orders or sequences in which welding operations occur for spot and pulsation welding, with and without repeating.

On many types of work it is required to make welds rapidly one after another as the work is moved through the welding machine, or as a portable "gun welder" is moved along the work. This is called repeat welding, and to make such welding automatic we need an off time during which the electrodes are released from the work, the work or the welder moved to a new position, and everything made ready for the following squeeze time. The off time usually is adjustable to between 3 and 60 cycles, but sometimes for even longer times. Timing "sequences" including off times are illustrated in Fig. 222.

SEQUENCE TIMERS.—The number of timing controls for carrying out any welding operation depends on the number of time periods to be regulated. Each time period is controlled by a separate time-delay circuit containing capacitance and resistance, and a time control tube, called a “keying tube” or “trigger tube,” which usually is a thyatron. The time period is altered by adjusting the value of the time-delay resistance or of the capacitor charging voltage in the time-delay apparatus.

The apparatus which controls the order of operations and the length of time for each is called a **sequence timer**. For the control of two time periods there would be two keying tubes and two resistance adjusting dials or knobs, for three time periods there would be three tubes and three dials, and so on for whatever number of periods are to be controlled.

Fig. 223 illustrates a sequence timer with individual timing adjustments for squeeze, weld interval, heat, cool, hold and off times. For each of these periods there is a thyatron tube and a dial graduated in cycles. At the lower left corner of the panel is a switch for low or high weld intervals, the low range being used for intervals up to

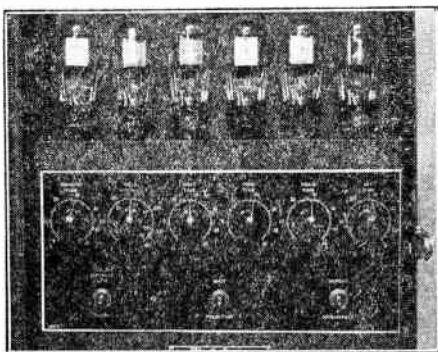

Fig. 223. The keying tubes, the time adjustment dials, and selector switches of one style of sequence timer designed for either spot or pulsation welding, with or without repeating operation.

60 cycles and the high range up to 360 cycles. In the lower center of the panel is a switch for changing from spot welding, using a continuous weld interval or time, to pulsation welding using alternate heat and cool times. In the lower right-hand corner of the panel is a switch for changing from repeat to non-repeat operation, for stopping the sequence after one weld or for using the off time and then automatically repeating for following welds.

IGNITRON POWER CONTROL—Fig. 224 shows the manner in which two ignitrons may be used to permit a-c electron flow through the primary winding of a welding transformer. The two ignitrons are numbered 1 and 2. Copper-oxide rectifiers which prevent reverse electron flow through the ignitors are marked A, B, C and D. The timer switch is an external switch operated by

hand or by a foot treadle to start and end each weld time. The flow switch is controlled by flow of cooling water for the ignitrons; it stops operation of the ignitrons should there be no water flow, or should the water (and the ignitrons) become too hot for safe operation. The fuse will blow if there is a continued excessive electron flow in the ignitor circuits.

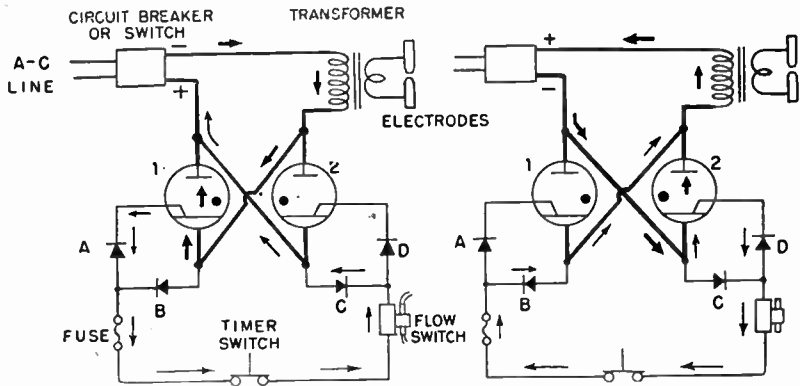

Fig. 224. In this welding circuit the two ignitrons are used to carry the two halves of each cycle of a-c electron flow for the transformer primary winding.

The power line is connected to the apparatus through an automatic circuit breaker or a fused switch that opens the power circuit in case of overload. One of the diagrams in Fig. 224 shows by arrows the electron flow for the ignitor of one ignitron when the upper end of the power line is negative and the lower end positive. The other diagram shows ignitor electron flow on the alternate half-cycles, with the upper end of the power line positive and the lower end negative.

Electron flow with the upper end of the power line negative is as follows: From the circuit breaker through the primary of the welding transformer to the cathode of ignitron 1; then from the cathode into the ignitor, through rectifier A, the fuse, the timer switch, the flow switch, rectifier C, and then back to the positive side of the line. This electron flow from the mercury pool cathode to the ignitor in ignitron 1 fires this ignitron and it conducts the large electron flow required by the transformer primary while welding.

With the lower end of the power line negative, electron flow is from this end through the cathode and ignitor of ignitron 2,

then through rectifier D, the flow switch, the timer switch, the fuse, rectifier B, and back through the transformer primary winding to the positive side of the line.

Note that in this circuit of Fig. 224 we are using what amounts to two half-wave rectifier tubes (the ignitrons) connected in such a way that they conduct a-c electron flow for the welding transformer primary. As may be seen from the two diagrams, electron flow in the transformer primary is in one direction during one half-cycle and in the opposite direction during the alternate half-cycle. We are using rectifier tubes not for rectifying, but for handling a-c electron flow during both halves of each a-c cycle. This arrangement of two rectifiers may be called back-to-back, reverse parallel, or inverse parallel connection.

Copper-oxide rectifiers A and D permit electron flow from cathode to ignitor in their respective ignitrons, but, being in series with the ignitors, they prevent a reverse flow from ignitor to cathode. Rectifiers B and C force the electron flows to pass up through the cathode, to the ignitor, and down through the other rectifiers, instead of taking the shorter paths through A and D.

So long as the timer switch remains closed, as shown in the diagrams, the ignitrons will continue to fire and conduct a-c electron flow for welding. When the timer switch is opened, both ignitor circuits or both starting circuits are opened and the ignitrons no longer are fired. Thus the welding time is the same as the time during which the timer switch is closed.

The required electron flow from cathode to ignitor for firing the ignitrons used for welding service may be as large as 40 amperes, yet the fuse in the starter circuit is of only 3-ampere capacity. The use of a small-capacity fuse is made possible because the fuse metal takes a certain length of time to heat to the melting temperature after there is an electron flow in excess of the fuse capacity. Normally the starter electron flow need continue for only about $1/10,000$ second, and an electron flow of even 40 amperes cannot in this short time heat the fuse metal to the melting or "blowing" point. However, should something go wrong and allow a continued flow of more than three amperes in the ignitor and starter circuit, the fuse will blow and prevent further operation of the apparatus until the wrong conditions have been corrected.

With the ignitron welding circuit of Fig. 224 the starter electron flow or ignitor electron flow passes through the primary winding of the welding transformer. Since the ignitor flow for starting may have to be as much as 40 amperes with welding

types of ignitrons the minimum electron flow through the transformer primary would have to be 40 amperes. Otherwise starting would be delayed and the life of the ignitrons would be shortened.

Under some conditions the primary electron flow may be less than 40 amperes. This will happen if the welding electrodes are separated from the work so that no electron flow may take place in the secondary winding of the transformer. When a transformer is thus operated with an open-circuited secondary it will take in its primary winding only a small electron flow called the magnetizing electron flow. There is a similar effect in any very high resistance secondary circuit, such as is formed when welding steel covered with scale, or any metal which offers high resistance. There will be a small primary electron flow and a small secondary circuit flow also during certain periods of flash welding, when using a welding machine of small capacity, and also when using certain styles of high-speed spot welders.

With any conditions which reduce electron flow to below 40 amperes maximum instantaneous flow in the welding transformer primary it is necessary to connect across the primary, or in parallel with the primary, a resistor through which may pass the required additional amperes of electron flow for starting. The General Electric Company recommends using a parallel resistor of 9 ohms on a 220-volt supply, and of 18 ohms on a 440-volt supply. With a sine-wave supply voltage the corresponding peak values would be 311 and 622 volts. Dividing by the recommended resistances, 9 and 18 ohms, shows that the electron flow through the added resistor would be 34.6 amperes—this because $I = E/R$.

Causes for blowing of the 3-ampere control circuit fuse are as follows: Electron flow in primary of welding transformer too small or too great. Outlet water temperature too high. External short circuit between ignitor and cathode of ignitron. Disconnected starter lead. Defective copper-oxide rectifier.

THE LEADING-TUBE, TRAILING-TUBE CIRCUIT—Fig. 225 shows an important type of welding circuit in which the firing of one ignitron, called the leading tube, times the firing of the other ignitron, called the trailing tube. All weld times begin with firing of the leading tube and end when the trailing tube ceases to conduct. When the leading tube fires, the trailing tube must follow it, and since each tube handles one of the half-cycles in a full cycle of power, every weld must continue for a time measured in full cycles. That is, we may have a weld time of 3, 4, 5 or more cycles, but cannot have such times as $3\frac{1}{2}$, $4\frac{1}{2}$ and other half-cycle times.

In Fig. 225 ignitron 1 is the leading tube and ignitron 2 is the trailing tube. Thyratron A fires ignitron 1, and thyratron B fires ignitron 2. Resistor R1 is the limiting resistor for electron flow in the grid circuit of thyratron A. Resistors R2 and R3 increase resistance in the thyratron plate circuits and limit electron flow in these circuits.

A timing impulse consisting of a momentary or continued voltage is applied between grid and cathode of thyratron A, making

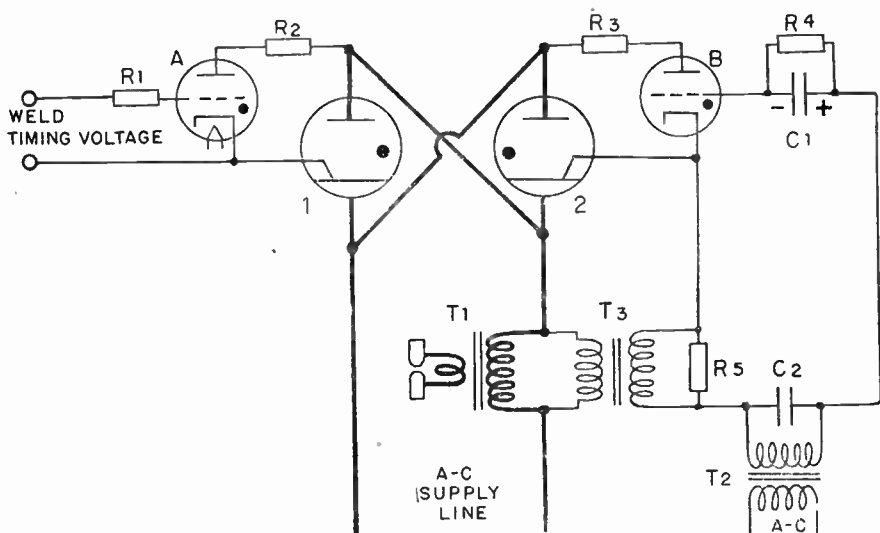

Fig. 225. The leading-tube, trailing-tube circuit in which the trailing tube is fired at the end of the conductive half-cycle in the leading tube.

the grid voltage positive, allowing the thyratron to break down and conduct ignitor electron flow for ignitron 1, and thus firing this ignitron. The ignitron conducts the half-cycle of electron flow from the supply line and through the primary winding of welding transformer T1. At the end of this half-cycle, electron flow in the primary winding drops suddenly to zero. Now let's see how firing of the trailing ignitron is controlled.

Between the grid and cathode of thyratron B we have resistor R4 and capacitor C1 in parallel, then the secondary winding of transformer T2 across which is capacitor C2, then resistor R5 which is across the secondary winding of transformer T3. The primary winding of transformer T2 is connected to the a-c voltage source, and the secondary is connected into the thyratron grid circuit. The secondary voltage is made to charge capacitor C1 by

grid rectification in the thyatron, making negative the side of the capacitor connected to the thyatron grid. The charge slowly leaks off through resistor R4, but the repeated voltage impulses from transformer T2 maintain enough charge to keep the thyatron grid negative and to prevent breakdown of this tube. Resistor R5 completes the capacitor charging circuit around the impedance of the secondary of transformer T3.

At the end of the conducting half-cycle of ignitron 1 we have the sudden drop of electron flow in the primary of the welding transformer T1. This sudden change of electron flow causes a pulse of voltage and electron flow in the primary of transformer T3 which is connected across T1. The voltage from the secondary of transformer T3 opposes the voltage from the secondary of T2 and is of a potential greater than that being maintained on capacitor C1 and on the grid of thyatron B. The positive voltage thus delivered to the grid of thyatron B by transformer T3 causes the thyatron to break down. When the thyatron breaks down it conducts electron flow for the ignitor of ignitron 2 and this, the trailing tube, fires. Capacitor C2 permits passage around the secondary inductance of T2 of the timing impulse from T3.

The leading and trailing ignitrons will fire in succession during each cycle of a-c supply voltage so long as thyatron A has a grid-cathode voltage which permits this tube to carry electron flow from the ignitor of ignitron 1 during each half-cycle in which the plate of A and the anode of 1 are positive. If ignitron 1 fires, ignitron 2 also must fire, so we always have conduction for a full cycle.

SEQUENCE TIMING—A sequence timer, as has been mentioned in preceding pages, times the number of cycles for periods of squeeze, weld, hold, off, heat, cool, and weld interval. Such a timer also causes these operations to occur in correct order or sequence. For each operation to be started, timed and stopped we will have one complete time-delay circuit. Relays connected to those time-delay circuits and to control switches close and open the various circuits in the correct order and at the correct times.

The time-delay relay which we studied in Figs. 206 and 207 may be used for each of the control sections in a sequence timer. Fig. 226 shows that time-delay relay with its circuit redrawn to provide terminals in convenient locations for connection later into a complete circuit diagram for a sequence timer. Tube T is the shield-grid thyatron. The time-delay period is determined by capacitor C1, resistor R1, and adjustment of voltage divider VD.

Resistor R2 is in series with the voltage divider, R3 completes the cathode circuit while C1 charges, and C2 is the smoothing capacitor across the relay coil.

The a-c supply is connected to terminals 1 and 2 of Fig. 226. The relay coil is connected to terminals 3 and 4. When the external

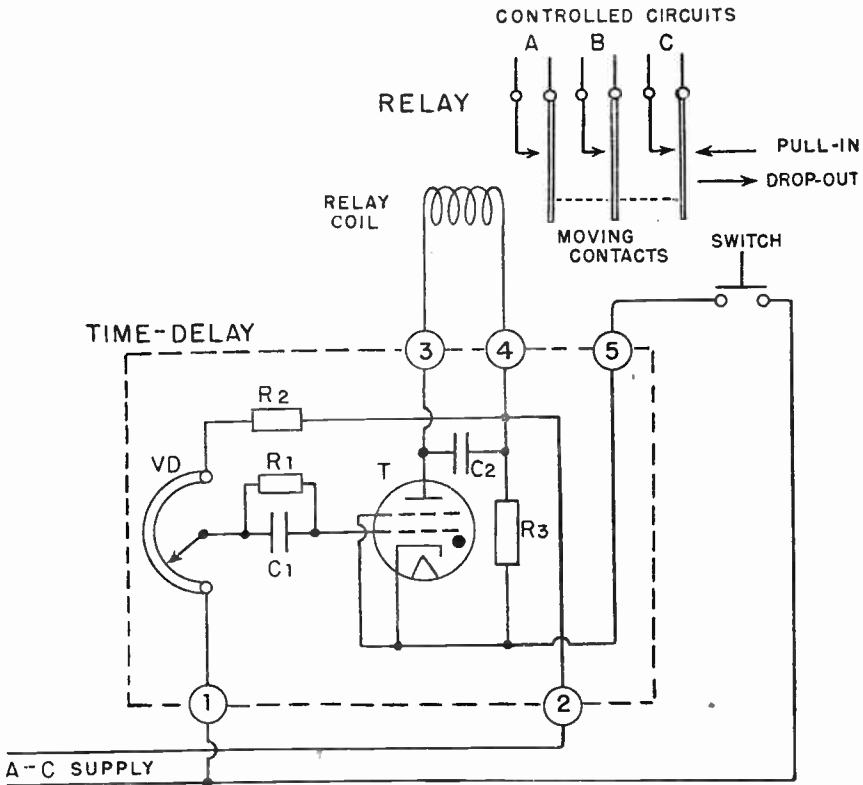

Fig. 226. The time-delay circuit shown within the broken lines is connected to the a-c supply and to the coil of a multi-contact relay having three normally open contacts which simultaneously close three circuits when the relay pulls in.

switch is closed between terminals 5 and 1 the time-delay period commences, and at the end of this period the relay will pull in.

In a sequence timer it is necessary to use various combinations of normally open and normally closed contacts on the relays. One such relay is shown by Fig. 226. Here we have three normally open contacts. When the relay coil carries enough electron flow its armature is attracted to its core. Attached to the armature are the three moving contacts, which move to the left on pull-in as

the armature moves toward the core, come against the three stationary contacts, and simultaneously close circuits A, B and C. The broken line joining the moving contacts indicates that all those thus joined move together. When electron flow in the coil decreases and releases the armature, the relay drops out and simultaneously opens the three circuits. Many other combinations are possible, but this diagram shows how relays of this general type may be indicated in wiring diagrams. Fig. 227 illustrates relays used in one type of welding timer.

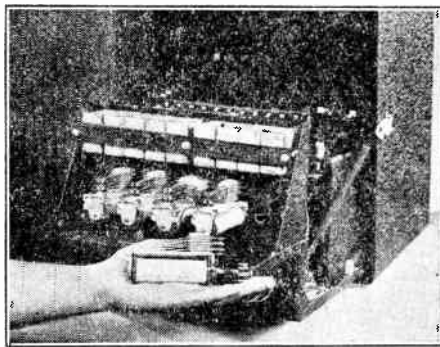

Fig. 227. These are the fast-operating relays in one style of sequence timer. The relays plug into sockets like those used for radio tubes and are held in place by a clamping bar.

TIMER FOR A FOUR-PERIOD SEQUENCE—Fig. 228 shows the circuit connections for a sequence timer for control of squeeze, weld, hold and off periods. At the bottom of the diagram are shown the four time-delays, all four of which are exactly like the one shown by Fig. 226. Since the internal parts and connections are the same for all four time-delays, they are shown only in the one for squeeze time.

There are six relays, numbered from 1 to 6. Relay 1 is like that of Fig. 226, having three normally open contacts marked A, B and C. This relay, as we shall see, is operated by the starting switch which is the push button or footswitch used by the welding operator. Relay 2 has a single set of normally open contacts. It closes the circuit for firing the ignitrons which carry electron flow for the welding transformer primary.

Relay 3 has two normally open contacts, marked A and B, and its coil connected to the "squeeze" time-delay. Relay 4 has normally

closed contacts A and normally open contacts B, with its coil connected to the "weld" time-delay. Relay 5 is a "double-pole, double-throw" type with normally open contacts at A and C, with normally closed contacts at B and D, and with its coil connected to the "hold" time delay. Relay 6 is a simple normally closed single-contact type with its coil connected to the "off" time delay. The off time period will be used only when the repeat switch is closed.

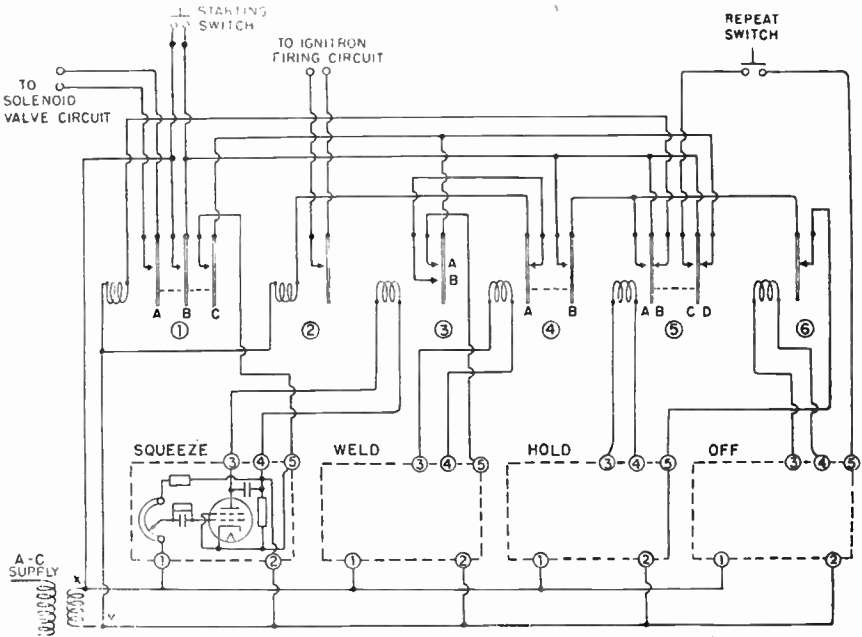

Fig. 228. Circuits of a sequence timer for control of squeeze, weld, hold, and off periods.

When the operator closes the starting switch there is electron flow from X on the transformer secondary through the switch, through closed contacts B on relay 5 to the coil of relay 1, and back to Y on the transformer. Relay 1 pulls in, closing its contacts A, B and C. Contacts A close the circuit for the solenoid valve which permits air or liquid pressure to bring the welding electrodes onto the work. Contacts B are in parallel with the starting switch, and with these "holding" contacts closed the starting circuit will remain complete through them even though the operator releases the starting switch. This method by which a switch causes pull-in of a relay whose contacts close the same circuit as the switch is commonly used in many control devices. It permits momentary

closing of a switch to establish a circuit which then is kept closed during some controlled operation. The arrangement may be called a lock-in or a holding contact.

Contacts C, which are closed with the others on relay 1, complete a connection from terminal 5 on the "squeeze" time-delay, through the contacts, to and through closed contacts D on relay 5, back through closed contacts B on relay 1, to X on the transformer, and to 1 on the "squeeze" time-delay. This connection from 5 to 1 on the time-delay apparatus starts the timing period for squeeze, which has been adjusted to a suitable number of cycles by the adjustment on the time-delay apparatus.

At the end of the squeeze period the thyatron in the squeeze time-delay breaks down and delivers electron flow to the coil of relay 3, which now pulls in and closes its contacts A and B. Contacts A make a connection from 5 on the "weld" time-delay through these contacts to closed contacts D on relay 5, through closed contacts B on relay 1 to X and to terminal 1 on the "weld" time-delay. This connection from 5 to 1 starts the weld period timing.

Contacts B on relay 3 simultaneously close the circuit for the coil of relay 2, which instantly pulls in and closes the circuit for firing the ignitrons at the beginning of the weld period. The circuit for the coil of relay 2 is as follows: Transformer X, contacts B on relay 1, contacts D on relay 5, contacts B on relay 3, contacts A on relay 4, through the coil on relay 2, back to Y on the transformer.

At the end of the timed weld period the thyatron in the weld time-delay breaks down and energizes the coil of relay 4. This relay pulls in to open its contacts A and close contacts B. Opening of contacts A breaks the circuit through relay 3 and the coil of relay 2, thus allowing relay 2 to drop out and open the ignitron firing circuit to stop electron flow to the welding transformer and electrodes.

The simultaneous closing of contacts B on relay 4 completes a circuit from terminal 5 on the "hold" time-delay through the closed contacts of relay 6, closed contacts B of relay 4, closed contacts B of relay 1, to X and then to terminal 1 on the hold time-delay, thus starting the time-delay for the hold period.

At the end of the hold period the thyatron in the hold time-delay breaks down, conducts electron flow for the coil of relay 5, and causes this relay to pull in. This pull-in closes contacts A and C, and opens contacts B and D. Opening of contacts B opens the circuit through the coil of relay 1, which then drops out. Opening

of contacts A on relay 1 opens the solenoid valve circuit and releases the electrodes from the work. Opening of contacts B returns control for a following operation to the starting switch, while opening of contacts C makes the "squeeze" time-delay ready for a following sequence of operations.

All of the operations which have been described occur with the repeat switch open, and at the end of one sequence of squeeze, weld and hold periods we are back where we started, ready to begin another similar sequence when the starting switch is closed.

If the repeat switch is closed this switch completes a circuit from terminal 5 on the "hold" time delay through closed contacts C of relay 5. If the starting switch is being held closed, as it must be for repeat welding, the circuit is carried on through the closed starting switch to X on the transformer and to terminal 1 on the "off" time delay. The connection from terminal 5 to terminal 1 starts the off period of timing. Contacts A, which now are closed on relay 5, are in parallel with contacts B on relay 4, so the "hold" time-delay and the coil on relay 5 continue to be energized even though relay 4 has been dropped out by the dropping out of relay 3.

At the end of the hold period the thyatron in the "hold" time-delay conducts electron flow for the coil of relay 6, which opens its contacts to cut off terminal 5 on the "hold" time delay, and thus allows relay 5 to drop out. When relay 5 drops out it re-closes its contacts B to again complete the circuit through the coil of relay 1, which then closes and starts the following cycle with the squeeze period. So long as the operator holds the starting switch closed, with the repeat switch closed, there will be repeated sequences of squeeze, weld, hold and off periods.

In tracing the action of this one sequence time we have found that the starting switch closes the electrodes and starts the squeeze period, that the end of the squeeze period fires the ignitrons and starts the weld period, that the end of the weld period starts the hold period, that the end of the hold period starts the off period and releases the electrodes, and that the end of the off period starts the following squeeze period. With a generally similar method of allowing one time-delay to control the following one we might add heat and cool periods. Timers utilizing time-delay relays are used not only for the control of welding but also for the control of any processes in which timed operations are to follow one another in a certain order.

The operation of the several timing circuits often may be checked without applying power to the welding transformer or

welding machine, simply by watching the glow that indicates electron flow in the thyatron control tubes. Incorrect timing periods, with possible overlapping, may be noted from their effect on performance. For example, if the electrodes flash when separated from the work it would indicate that the weld period had not yet ended.

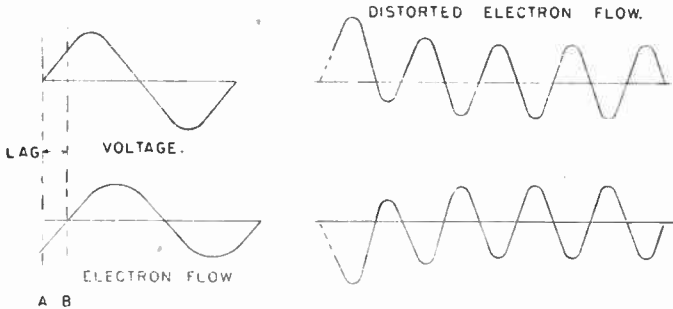

Fig. 229. Unless the weld time is started at an instant on the voltage wave corresponding to zero electron flow the first few cycles of electron flow will be of distorted wave form.

SYNCHRONOUS TIMING—In the circuit of a welding transformer there is so much inductance in comparison with the resistance that the electron flow is not in phase with the voltage, rather it lags the voltage by a considerable time as indicated in Fig. 229. This effect gets us into difficulties on short period welds, on welds which must be made with an electron flow of 10 cycles or less.

It is apparent that applying the voltage at zero on the voltage wave, A in Fig. 229, will not start the electron flow at the instant which naturally would correspond to zero electron flow, but will start the electron flow before it naturally would reach zero. Applying the voltage before or after the instant at which electron flow naturally would be zero causes an actual electron flow which is much distorted during the first few cycles. The effect, as illustrated by one of the diagrams in Fig. 229, may be an excessively high or low electron flow until conditions reach normal, with the result that we have either too much or too little heating of a short-period weld.

To have uniform and controlled heating of short-period welds it is necessary that the circuit be closed at a point in the voltage wave which corresponds exactly to the natural zero electron flow point, point B in Fig. 229. The time by which this instant is de-

layed after the instant of zero voltage depends on the relations between inductance and resistance in the circuit or on the lag of normal electron flow in relation to the voltage. Every weld must be started at just the right point on the voltage wave. When this is done we have what is called synchronous timing.

PEAKING TRANSFORMERS.—It is apparent that if we are to start every weld at a precise instant on a voltage wave whose total existence covers but a small fraction of a second, we must have a control which is accurate to better than the one-thousandth part of a second. One method of producing the exceedingly brief, yet accurate pulses of control voltage is by use of a peaking transformer.

To understand the action of a peaking transformer we first must investigate the manner in which a primary voltage results in a secondary voltage in any transformer, such as the one represented in Fig. 230 by primary and secondary windings on a core. Voltage applied to the primary causes electron flow around the primary winding. This primary electron flow causes magnetic lines of force, called magnetic flux, to circulate in the core as indicated by arrows. When the flux changes the change of flux causes an emf or voltage to appear in the secondary winding, and this secondary voltage causes electron flow in the secondary winding if it is part of a closed circuit.

Because the primary of the transformer has great inductance and little resistance the electron flow in the primary lags the primary voltage by almost 90 degrees, as shown by the curves for primary voltage and electron flow in Fig. 230. Since the flux is caused by primary electron flow, the flux rises, falls and reverses with the primary electron flow, and may be indicated by the same curve.

Secondary voltage is caused by change of flux, so will be maximum when the flux is changing at the greatest rate and will be zero when the flux is not changing at all. The flux is not changing at all for just an instant when it reaches its maximum value in either direction, for there the flux stops changing, and so at these stationary points on the flux curve we have zero secondary voltage. The flux is changing at the greatest rate as it goes through the zero points on its curve, for here the direction of flux reverses, and no change could be greater than a complete reversal of direction. At these zero points on the flux curve we then have the maximum secondary voltage.

If you compare the curves for primary and secondary voltages at 2, 4, 5 and 6 you will see that these two voltages are of opposite phase, each is positive when the other is negative at their maximum points. If we add resistance in the primary circuit, to partially overcome the effect of so much inductance, the primary electron flow and the flux will not lag so far behind the primary voltage. Then the secondary voltage will be brought more nearly into phase with the primary voltage, but always will lag somewhat more

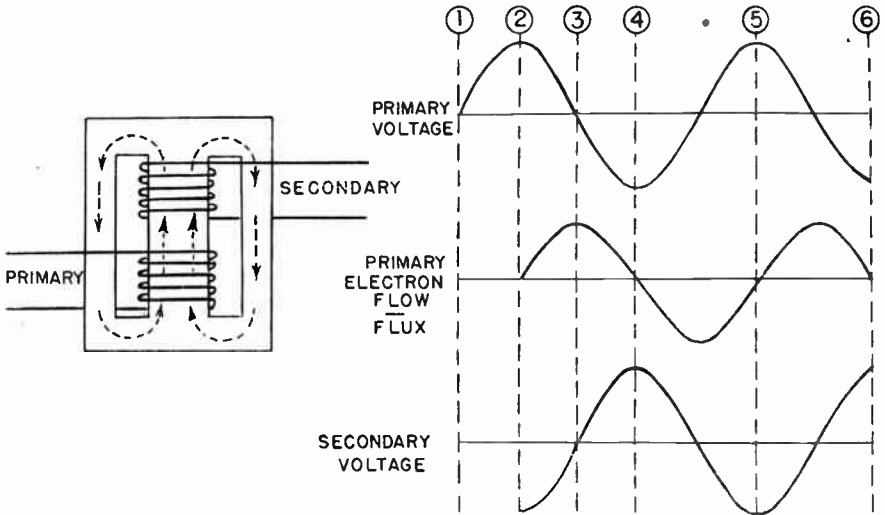

Fig. 230. The time relations or phase relations between voltages, primary electron flow, and magnetic flux in an ordinary transformer.

than 90 degrees because its peak which first is at line 4 can, at the most, be brought back only nearly to line 3, even were the primary electron flow and flux nearly in phase with the primary voltage.

Now we must look at the manner in which electron flow in a coil, such as the transformer primary, causes flux to increase in iron or steel forming the core for the coil. The curves of Fig. 231, which apply to two different kinds of core material, show how flux increases with increase of electron flow in the coil. With either core material the flux increases at a great rate with the first small increase of electron flow, but as the electron flow continues to increase there is not a corresponding increase of flux. Soon we reach a condition with which large increases of electron flow cause very small increases of flux.

When the core material reaches a condition where there is but little change of flux regardless of the change of electron flow

the material is said to be saturated. The curves of Fig. 231 may be called saturation curves. The place where a saturation curve stops rising almost vertically and turns to a nearly horizontal direction is called the "knee" of the curve. With any ordinary core material the first relatively small changes of electron flow from its zero value cause considerable changes of flux, but when the electron flow goes beyond that corresponding to the knee of the saturation curve there is very little further change of flux.

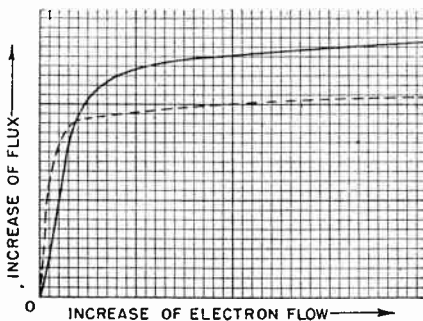

Fig. 231. Typical saturation curves or magnetization curves for two iron-alloy materials used for magnetic cores.

If we wish to avoid saturation we must operate below the knee of the curve by using core material which does not quickly saturate (the solid line curve of Fig. 231), by using fewer turns of wire in the coil, or by using less electron flow. To cause saturation we may use a smaller core sections, use core material that quickly reaches saturation (the broken-line curve of Fig. 231), use more turns on the coil, or use more electron flow.

Now we may build a transformer with core material which quickly saturates and whose saturation curve is almost flat or horizontal above the knee, and we shall use a cross section of core which is small in relation to the number of turns in the primary winding and to the primary electron flow. With such a transformer we have the relations between primary voltage, flux and secondary voltage shown by Fig. 232-A, where the instants of time numbered 2, 4, 5 and 6 are the same as similarly numbered instants in Fig. 230.

The primary voltage wave is the same as before, but instead of the flux following the ordinary curve shown by a broken line it can increase only to the point of saturation, then remains steady

until the following point of reversing and increasing in the opposite direction to saturation. The only time the flux changes is shown by the sloping portions of the flux curve, for there can be a change only between points of saturation. Since secondary voltage is caused only by changes of flux we have a rise and fall of secondary voltage only during the short periods in which the flux is changing. The result is a succession of secondary voltage peaks, one positive and one negative during each cycle, and we have a peaking transformer.

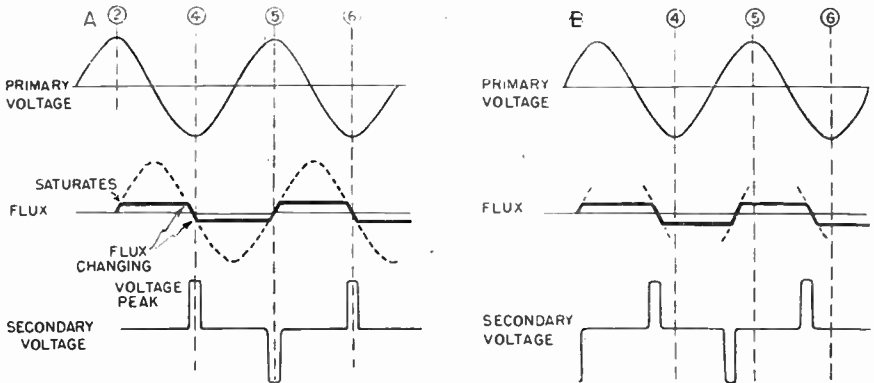

Fig. 232. Left: Primary voltage and flux, and secondary voltage peaks, with no extra resistance in series with primary of peaking transformer. Right: Voltage and flux relations when much extra resistance is in series with primary winding.

If now we place resistance in series with the primary, to lessen the effect of the primary inductance, the flux wave will be brought more nearly in phase with the primary voltage. Then, as shown by Fig. 232-B, the peaks of secondary voltage, which result from flux changes, will be brought forward in the cycle or will occur earlier. If the series resistance is adjustable it gives us some control over the phase relation between the primary and secondary voltages.

With any of these peaking transformers the length of time or the number of degrees during which the peaks of secondary voltage exist becomes less as the core material saturates more quickly. That is, core material having a saturation curve as shown by a broken line in Fig. 231 will give shorter peaks than material represented by the full line curve. The flatter the curve above the knee the more nearly we will have zero secondary voltage between the peaks.

Fig. 233 shows the construction of one style of peaking transformer and illustrates the differences between it and an ordinary transformer. In the peaking transformer the secondary winding is on a portion of the core made of permalloy, which is of high magnetic permeability. The cross sectional area of this secondary core is much smaller than that of the primary core. Consequently, the secondary core saturates very quickly, while the primary core material still is operating below the knee of its saturation curve. The magnetic shunts carry the excess of primary flux that does not pass through the secondary core. The result of this construction is a secondary peaked voltage wave with steep sides and a nearly flat top, and with nearly straight zero-voltage portions between the successive peaks.

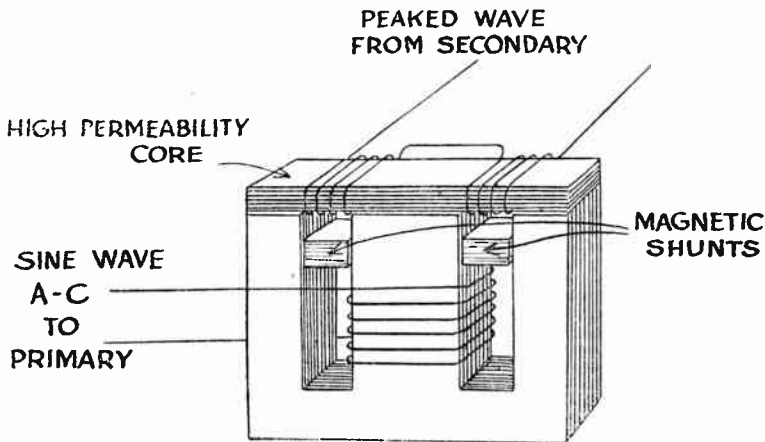

Fig. 233. Construction of a peaking transformer using a saturated secondary core and an unsaturated primary core.

A SYNCHRONOUS TIMER—Now we are ready to investigate the circuit of a synchronous timer which will deliver weld timing voltage to leading thyatron A in Fig. 225, and in which we shall use a peaking transformer. This circuit is shown in Fig. 234, at the bottom of which is the leading thyatron A with its grid resistor R1.

The synchronous timer is operated with d-c voltage and electron flow obtained from a rectifier and filter system with the negative side connected at the upper left and the positive side at the upper right in Fig. 234. The cathode of thyatron A is connected through voltage divider R9 and resistors R10 to the positive side of the d-c supply, while the grid is connected to voltage divider

R3 which is toward the negative end of the d-c supply. Consequently, the grid of thyatron A is negative with reference to its cathode by the voltage drop from the positive side of the d-c supply to the slider on R3, so the thyatron does not break down.

Shield-grid thyatron B is the keying tube or trigger tube for the synchronous timer. The protective grid resistor for this tube is R8. The grid of tube B is connected through the secondary winding of the peaking transformer to the negative side of the d-c supply, while its cathode is connected to the other side of resistor R2. Therefore, the grid of this tube is more negative than its cathode by the voltage drop through resistor R2.

The secondary voltage of the peaking transformer is enough greater than the negative grid voltage produced by resistor R2 to overcome this negative voltage and make the grid highly positive during a positive voltage peak from the transformer. Adjustable resistor R11, in series with the primary of the peaking transformer, varies the instant of secondary voltage peaks in relation to the primary voltage as has been shown in Fig. 233. By adjusting resistor R11 it is possible to make keying tube B break down at the exact point of the primary voltage wave which will insure starting the secondary electron flow in the welding ignitron as its natural zero point—this being the object of synchronous timing.

A starting switch for use by the operator is in series with the coil of the relay. When the switch is closed the relay coil receives the voltage drop across resistor R4 and pulls in. Before the starting switch is closed, while the relay still is dropped out as shown in the diagram, the plate of keying tube B is disconnected from the remainder of the circuit and this tube is inoperative. While the relay is dropped out, as shown, its closed contacts connect capacitor C to resistor R5 so that any charge on this capacitor leaks away through R5 and leaves the capacitor discharged, with both sides at the same potential.

When the operator closes the starting switch the relay pulls in, disconnecting R5 from the capacitor and connecting the plate of tube B through resistor R7 to the positive side of the d-c supply, while the cathode is connected to a point more negative between R2 and R3. Now the first positive peak from the peaking transformer will cause tube B to break down, and there will be electron flow from its plate through the relay and resistor R7 to the positive side of the d-c supply.

The instant that tube B breaks down we have the following conditions: The cathode of thyatron A is connected to the bottom of capacitor C. Capacitor C has been completely discharged, so its

top connection is at the same potential as its bottom connection, and the cathode of A is at the same potential as the top of the capacitor. The top of the capacitor is connected through the relay to the plate of tube B, so these two points and the cathode of A are all at the same potential. The voltage drop through keying

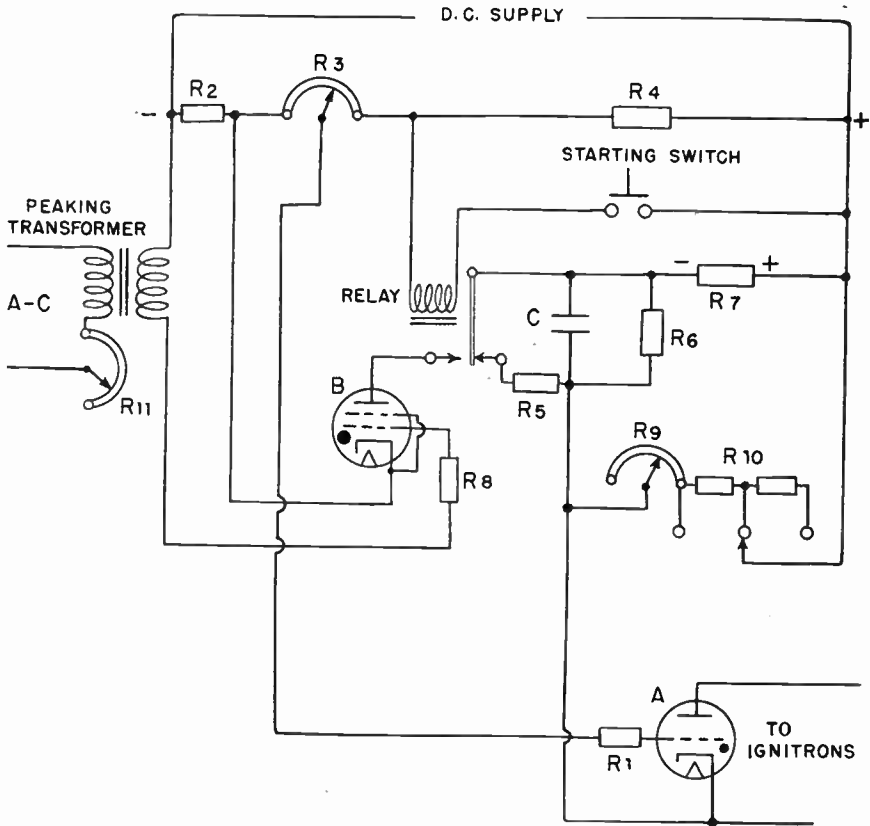

Fig. 234. The synchronous timer circuit, with which is combined the time-delay adjustment which governs the length of the weld period.

tube B is only about 15 volts, so its cathode potential is only 15 volts different from its plate potential. Therefore, the cathode of tube A is at a potential only about 15 volts different from the cathode of tube B. The cathode of tube B is connected to a point between resistors R2 and R3, and so, except for the 15 volts drop through B, we have brought the cathode of tube A to the potential existing between resistors R2 and R3. But the grid of tube A still is connected to the slider of voltage divider R3, which is more

positive than the point between R2 and R3. Thus breakdown of tube B has made the grid of tube A much more positive than its cathode, whereas before breakdown of B the grid of A was more negative than its cathode.

In effect, the breakdown of tube B has suddenly switched the cathode connection of tube A from the positive side of the d-c supply almost to the negative side, while grid potential remains unchanged. The breakdown of tube A fires the leading ignitron, to commence the weld time at the instant of the first positive voltage

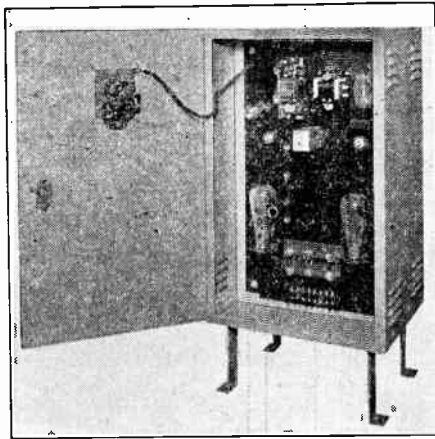

Fig. 235. A synchronous timer designed for control of small spot welders.

peak from the peaking transformer after closing of the starting switch. Thus we have synchronous timing of the beginning of the weld period.

Now let's see how the remaining parts of the synchronous timer of Fig. 234 control the length of the weld period, or control the number of cycles in the weld period. The voltage applied between the cathode and plate of the keying thyatron B is a d-c voltage, and we have learned that a thyatron tube which once breaks down continues to conduct until the plate voltage falls nearly to zero, so tube B now will continue to conduct as long as the starting switch remains closed and the relay completes the plate circuit.

As has been noted, capacitor C has been discharged through resistor R5, but now this capacitor commences to charge. The charging voltage is the voltage drop across resistor R7, produced by electron flow from tube B through R7. This charging voltage

is applied to the capacitor through resistors **R9** and **R10** which are in series with the "voltage source" **R7** and the capacitor. Thus the capacitor and the series resistors form a capacitor-resistor time-delay circuit, with the charging time for the capacitor adjusted by voltage divider **R9** and the setting of the contact on the taps shown for **R10**. The more resistance brought into the circuit by **R9** and **R10** the longer it will take the capacitor to charge to any given voltage. Resistor **R6**, in parallel with the capacitor, has a resistance many times that of **R9** and **R10** combined, so that **R6** does not materially affect the time period but does prevent effects of other small voltages which may enter the circuit.

The capacitor is being charged in such a direction by the voltage from resistor **R7** that the upper connection of the capacitor becomes negative and the lower end positive. The lower end of the capacitor is connected directly to the cathode of thyatron **A**. Consequently, as the capacitor charges, the cathode of tube **A** is made more and more positive, which is the same as making its grid more and more negative. After a time period determined by the rate of charging the capacitor, the grid of tube **A** becomes so negative with reference to its cathode as to stop conduction and stop firing at the ignitrons, thus ending the weld period. The time for charging the capacitor to this stopping voltage and ending the weld period may be adjusted to a desired number of cycles by resistors **R9** and **R10**.

Now the starting switch is opened, as by one of the relays in a sequence timer, thus allowing the relay of Fig. 234 to drop out. This cuts off keying tube **B** and discharges the capacitor **C** through resistor **R5**, leaving everything ready for the next weld. Fig. 235 illustrates one style of synchronous timer for small spot welders.

HEAT CONTROL FOR WELDING—The quantity of heat produced at a weld, and the temperature to which the welded metal is raised, depend on the resistance at the weld and on the square of the number of amperes of electron flow passed through the weld. That is, the power in watts that is changed into heat is equal to I^2R . The degree of heating is varied by changing the voltage in the secondary circuit of the welding transformer, and the voltage in the secondary circuit is varied by changing the electron flow in the primary winding of the welding transformer. A common method of controlling the degree of heating consists of taps at various points along the primary winding and of a tap-changing switch.

More accurate control of welding heat is secured by using a phase-shift circuit to actuate the thyratrons which fire the ignitrons. As we learned when studying phase-shift control circuits, the instant at which a thyatron breaks down during a cycle may be advanced or retarded by adjustment of a resistor, a capacitor or an inductor. Such an adjustment, which determines the instant of thyatron breakdown, also determines the instant in the conductive half-cycle at which ignitrons fired by the thyratrons will fire. Then the ignitrons conduct electron flow during only the remainder of the half-cycle. Consequently, the average electron flow through the ignitrons may be varied, and since this average electron flow passes through the primary of the welding transformer we have "heat control" by means of phase-shift.

SERIES TRANSFORMER WELDING CONTROL—The principle of one of the earliest thyatron-controlled welding circuits is illustrated by Fig. 236. No ignitrons are used, but the primary of the welding transformer is connected across the a-c power supply in series with the primary winding of an "impedance transformer" whose secondary winding is connected to two thyratrons as shown.

In any transformer the electron flow in the primary is nearly proportional to electron flow in the secondary. That is, to have increased electron flow in the secondary we must have proportionately more flow in the primary in order to supply to the primary the power being taken from the secondary side. If impedance or opposition to a-c electron flow in the secondary circuit is reduced beyond a certain value the secondary electron flow will continue to increase while less power is delivered into the reduced impedance of the secondary load. If impedance of the secondary circuit is made very low, or almost zero, there will be a very large electron flow in the primary because, under such conditions, the primary offers almost no impedance to the power supply. On the other hand, if the impedance in the secondary circuit is made very high, or if the secondary circuit is opened so that it has no electron flow, the electron flow through the primary winding becomes very small. Under this condition the impedance offered by the primary to the power supply becomes so high that it permits only enough electron flow to maintain flux in the core and to make up for slight losses such as due to heating.

In view of the transformer action just explained, it becomes apparent that with the thyratrons of Fig. 236 non-conducting there can be no electron flow in the secondary of the impedance transformer, and the impedance of the primary winding will be very

great. With the primary of the impedance transformer in series with the primary of the welding transformer there will be very little electron flow to the welding transformer. If the thyratrons are caused to break down and become conductive, the only opposition to electron flow in the secondary circuit of the impedance transformer is the voltage drop through the tubes. Consequently the impedance of the primary becomes very small, and electron flow is passed freely to the welding transformer.

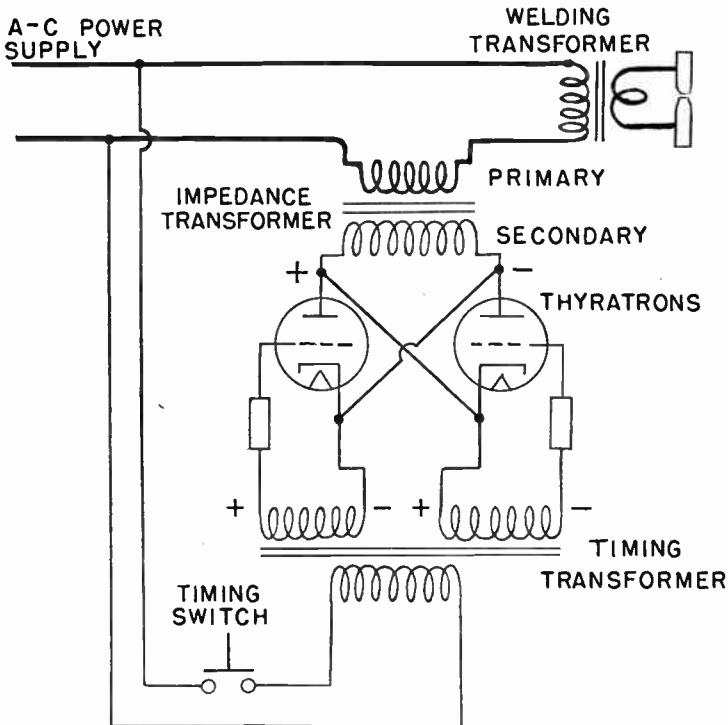

Fig. 236. The impedance transformer or series transformer method of starting and stopping electron flow in the welding transformer primary by means of two thyratrons.

The timing switch of Fig. 236 connects the primary winding of the timing transformer to the a-c power supply when a weld is to be made. Grid and plate voltages then have the relations shown by positive and negative signs to make the thyratrons conductive so long as the timing switch is closed.

TIMING CONTROL FOR SEAM WELDING—Fig. 237 illustrates seam welding on aluminum with the work being passed between the roller electrodes. The ignitron control is in the cabinet at the

right of the welding machine. In the front of the cabinet is a timing disc shown in more detail by Fig. 238. This aluminum disc is rotated by a motor at exactly one revolution each second. Around the edge of the disc are 120 equally spaced holes, each hole corresponding to $1/120$ second of time or to one-half cycle.

For each half-cycle during which the ignitrons are to conduct electron flow for welding, a steel pin is inserted in the aluminum disc. As the disc rotates, each pin passes between the poles of a permanent magnet to induce a voltage used for starting electron flow in a half-cycle. The pins do not touch the magnet poles, but merely pass through the magnetic field. The ten pins inserted in

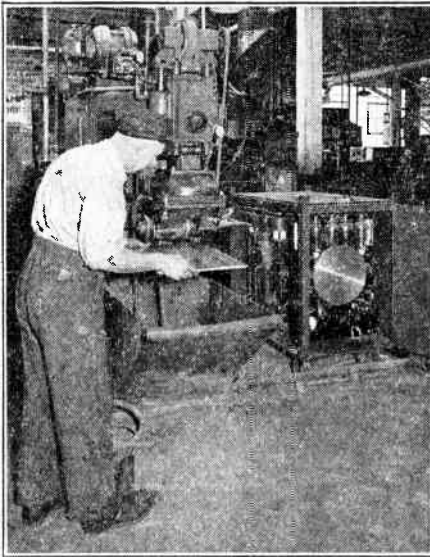

Fig. 237. A seam welder operating on aluminum. In the cabinet at the right may be seen the ignitron control which includes a timing disc for weld periods and intervening off periods.

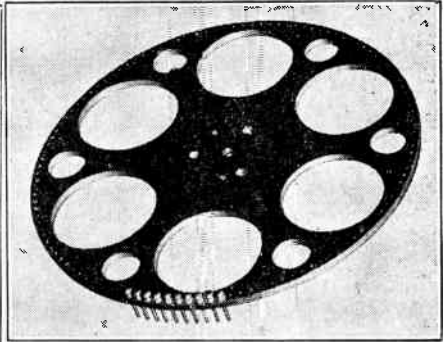

Fig. 238. Ten steel pins inserted in a timing disc for a seam welding control to provide a weld period of five cycles.

the disc of Fig. 238 would maintain welding electron flow during ten half-cycles or five full cycles. The number of holes without pins determines the off time between welds. Were it desired to have timing of two cycles on and three cycles off, the disc would be arranged with four pins followed by six empty holes, then another four pins and six more empty holes, and so on around the disc. Any welding cycle may be similarly arranged for whatever job is to be handled.

ENERGY-STORAGE SYSTEMS—The usual welding equipment takes very great amounts of power from the supply line for a fraction of a second, then takes almost no power during a following

period while no weld is being made. Supply lines which have plenty of electron flow capacity for motors and other electrical devices in manufacturing establishments often have insufficient capacity to handle the large pulses of welding electron flow without serious drops in voltage in the lines. There are several methods of overcoming this difficulty by taking energy at a slow rate from the power supply, storing it during a period of one-quarter to a full second, then suddenly discharging the stored energy through the primary of the welding transformer to make a weld.

There are two general methods of energy storage. With one method the energy is stored in the form of a charge in a group of

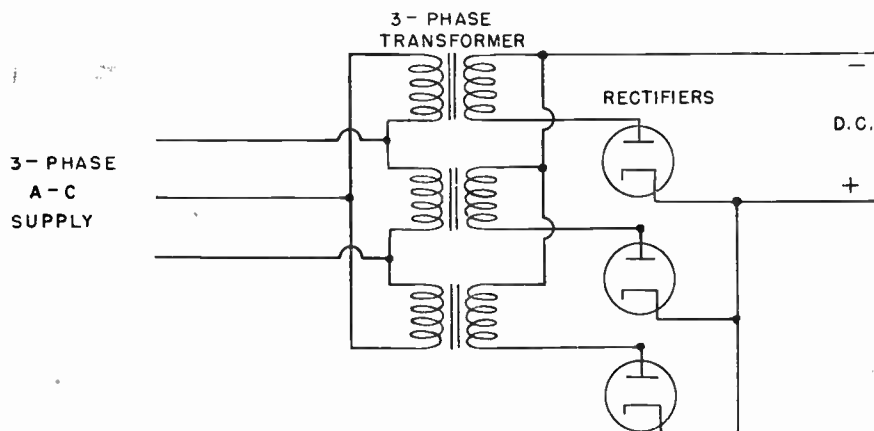

Fig. 239. Principle of rectifying from a three-phase power supply. This is a half-wave circuit.

capacitors, which discharge through the welding transformer. With the other method the energy is stored in the form of a magnetic field around the magnetic circuit of the welding transformer and is released through the secondary circuit containing the welding electrodes.

Energy-storage welding is especially desirable when power comes from three-phase supply lines such as feed most large manufacturing establishments. A three-phase supply line usually has three conductors or wires. In the wires are three distinct voltages and electron flows whose peaks are separated by 120 degrees. Welding transformers operate with single-phase electron flow in which there is but a single wave of electron flow and one of voltage. If a welding transformer or a welding installation is connected to only one phase of a three-phase system the large electron flows in this

one phase seriously unbalance the operation of the whole power supply.

In all energy storage systems the alternating voltages from the supply lines are rectified to produce the d-c voltages and electron flows used for charging the capacitors or for building up magnetic energy in the welding transformer. Fig. 239 shows the principle of a rectifying system fed from a three-phase power line and delivering d-c voltage and electron flow to a single circuit.

The elementary principle of a capacitor energy storage is shown by Fig. 240. The a-c power supply is connected to the rectifier and the capacitors are charged to a voltage determined by a voltage-limiting control. Until the operator is ready to make a weld the capacitors are maintained at this voltage by a small con-

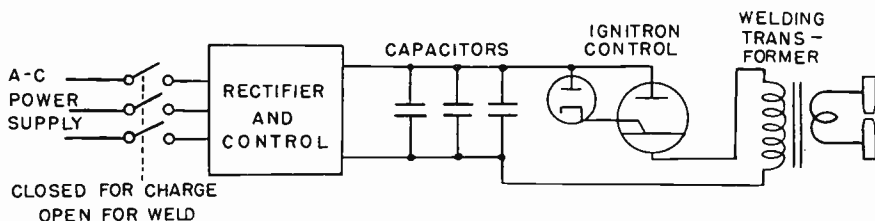

Fig. 240. The elementary operating principle of a capacitor-type energy storage system.

tinuing charge rate which compensates for slight leakage that may occur. When a weld is to be made the ignitrons are allowed to fire, thus discharging the capacitors with a sudden large pulse of rising and falling electron flow through the primary of the welding transformer. The resulting pulse of voltage and electron flow in the secondary circuit through the electrodes makes the weld. The capacitors may be charged to between 1,000 and 3,000 volts.

The principle of the magnetic energy-storage system (the Sciaky process) is shown by Fig. 241. After the welding electrodes are closed on the work the ignitrons are fired and permit electron flow from the rectifier through the primary winding of the highly inductive or high-reactance welding transformer. The inductive reactance of this transformer is so great as to cause a strong counter-voltage which limits the electron flow to a relatively slow rate of increase. The gradually changing rate of electron flow in the transformer primary causes a small electron flow in the secondary circuit, which passes through the work to preheat it. When

a weld is to be made the primary circuit of the transformer is opened. The resulting sudden collapse of the flux in the core causes a large electron flow in the secondary circuit, which discharges the energy held in the transformer magnetic circuit as the weld is made. It is the high inductance of the welding transformer which permits it to store a large amount of energy.

The chief advantage of the energy-storage systems is that, instead of requiring something like 2,000 amperes for possibly 1/10 second, they will require for the same weld about 400 amperes for 1/2 second or only 200 amperes for one second, thus greatly reducing the required electron flow capacity of the supply line. Because the time required for energy storage usually is at least one-quarter second the intervals between successive welds cannot be less than this time, which limits the usefulness of these systems for high-speed work of some kinds.

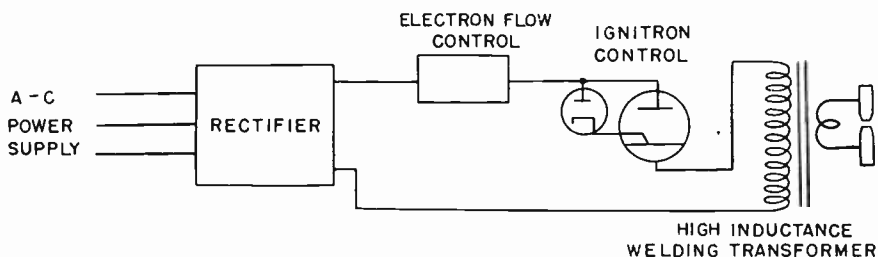

Fig. 241. The principal elements of a magnetic energy-storage system using a high-inductance welding transformer.

SERIES CAPACITORS—A disadvantage of a-c welding machines in general is that they have poor “power factors,” and when connected directly to an a-c supply line they cause an electron flow in the line which is much greater than that which would be required when delivering the same amount of power to apparatus having a better power factor. Power factor is the ratio of the electron flow actually used for useful work to the total alternating electron flow in the supply line and the apparatus. The reason that a high-inductance circuit, such as the primary circuit of a welding transformer, must carry useless electron flow is that every change in the rate of electron flow causes energy to be stored in the magnetic field and core of the transformer, and then this stored energy from the magnetic circuit is returned to the line as the magnetic field collapses. Thus, in addition to the electron flow that does useful work in transferring energy over into the secondary circuit, there is a rather large electron flow doing nothing more

than put energy into the magnetic system, then carrying it away again. All this extra electron flow through the resistance or impedance of the power supply circuit causes a proportional voltage drop which affects every other piece of equipment connected to the same supply system or line.

The power factor may be much improved, and the useless electron flow greatly lessened, by connecting capacitors in series with the primary winding of the welding transformer as in Fig.

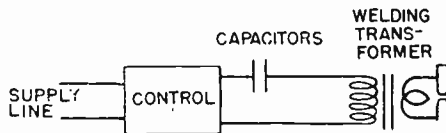

Fig. 242. The point at which capacitors are connected in a series-capacitor welding installation.

242. Such a system causes voltages much higher than the line voltage in the capacitors themselves, in the control apparatus, and, unless another voltage-reducing transformer is used, at the welding transformer primary. Consequently, series capacitor systems require equipment especially designed to withstand these higher voltages. A correctly designed series capacitor system will so improve the power factor and reduce the useless electron flow as to permit supply lines of given capacity to carry welders much larger than ordinarily is possible.

When the ignitrons fail to fire, but the control tubes operate for normal timing, the series capacitors may not be charged. These capacitors may be charged by temporarily energizing the welder at a reduced heat setting (phase control) and then readjusting the heat control dial for the desired operating point.

Chapter 16

USING HIGH FREQUENCIES

Induction Heating — Electrostatic Heating — Reactance and Impedance — Resonance — Oscillators — Feedbacks — Factors In Induction Heating — Power Oscillators — Methods of Electrostatic Heating — Oscillator Relay Controls — Grid Capacitor and Resistor — Oscillator Relays.

In all our electronic work up to this point we have used only direct electron flow or else alternating electron flow at power line frequencies of 60 cycles or thereabouts. Now, with the help of tubes operated as oscillators, we are ready to work with frequencies of hundreds of thousands or even of millions of cycles per second. With electric power at these high frequencies we may have induction heating, electrostatic heating, and many remarkable methods of industrial processing and control.

Induction heating will raise the temperature of metals to any degree, even to the melting point, by producing heat within the metals themselves while they are not even touching the heating element and while that element remains relatively cold.

Induction heating may sometimes be accomplished in a matter of seconds after the high-frequency power is applied, with no long delay as with other methods while heat penetrates from a high-temperature heating element into the work. Induction heating causes no injury either to the surface finish or the internal structure of the objects heated.

Induction heating is used for annealing or softening metal parts, also for surface hardening or case hardening over the whole surface or any selected part on gears, shafts, valves and such

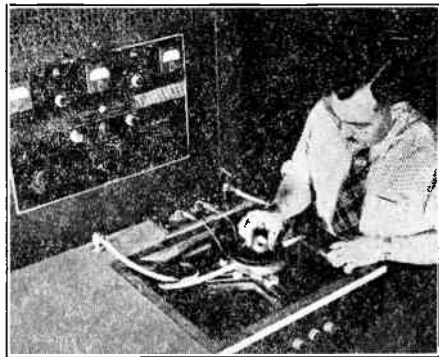

Fig. 243. The operator is placing a small gear in a fixture for induction heating as part of the process of surface hardening. The power oscillator to which connections are made is a 15-kilowatt unit.

pieces. Steel parts may be quickly softened for forging, upsetting and forming operations in general. Melting temperatures may be produced almost instantly for soldering, for brazing, for flowing a tin coating on sheet steel, for joining two different metals, or for bonding metals to glass.

Electrostatic heating will quickly and uniformly raise the temperature throughout the whole mass of many non-metallic or

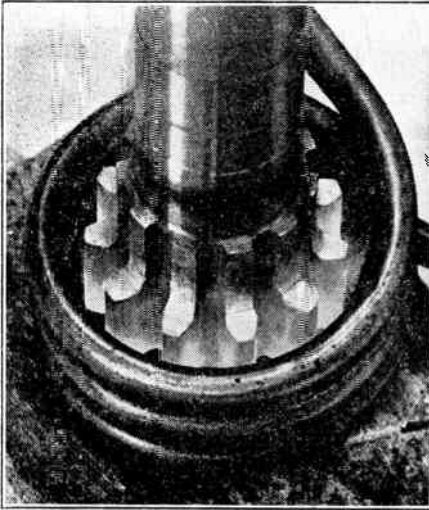

Fig. 244. This one-inch diameter gear is being inductively heated for hardening, using the 15-kilowatt power oscillator.

non-conductive materials such as wood, plastic or porcelain. Such heating is used for softening and then setting plastics during manufacture, for drying cements in concealed joints, for bonding plywood assemblies in minutes where it used to take days. Electrostatic heating is used also for killing insects and larvae which may have infested any non-conductive substances, and this heating even has been tried for roasting coffee and peanuts and for popping corn.

With low-power high-frequency circuits containing oscillator tubes it is possible to produce changes of voltage

and electron flow which may be amplified or relayed for many industrial and commercial testing and control purposes. Such circuits are used in position controls or level controls as on elevators, they are used for door openers, for burglar alarms, for detecting the presence of metals, for counting, for thickness gages, for measurement of moisture in materials, for checking flaws in welded joints, and for a great variety of other purposes.

To produce high-frequency power from the low-frequency power available from commercial and industrial power lines it is necessary first to change the a-c line power into d-c power, after which the d-c power is used in the oscillator circuits to produce high-frequency power. Between the supply line and the oscillator circuit we may have rectifiers to change the a-c power to d-c power. Some oscillators may be operated directly off the a-c circuit.

We already are familiar with the operation of rectifiers, but to understand the operation of the high-frequency end of the new apparatus we must become acquainted with a number of new principles relating to oscillating circuits in general and to the ways in which high-frequency power is used for heating or control. It will be well to get these new principles attended to right here in the beginning, especially since they apply also in many other fields of electronics, and will be useful for reference.

REACTANCES—We have learned that resistance is the opposition of a conductive path or circuit to any electron flow in the circuit. Resistance opposes a steady, one-way, continuous d-c electron flow, it opposes a changing electron flow such as an a-c flow or a pulsating d-c flow, and opposes any combination of d-c and a-c electron flows existing together in the circuit.

We learned also that inductive reactance is the opposition offered by inductance to a-c electron flow or to any changing electron flow in the inductance, and that capacitive reactance is the opposition offered by capacitance to a-c electron flow or to any changing electron flow in the capacitance.

In a preceding chapter we had the following formula for inductive reactance:

$$\begin{array}{l} \text{Inductive} \\ \text{reactance} \\ \text{in ohms} \end{array} = 6.2832 \times \begin{array}{l} \text{frequency} \\ \text{in cycles} \end{array} \times \begin{array}{l} \text{inductance} \\ \text{in henrys} \end{array}$$

Inductances so large as to be measured in henrys are found in iron-cored or steel-cored inductors and transformers such as are used in low frequency circuits connected to a-c power lines. From the formula it is apparent that the greater the frequency in cycles the greater will be the inductive reactance in ohms. Were we to use iron-cored inductors with high frequencies of hundreds of thousands of cycles the losses in the iron core would be so great as to make the apparatus useless. Consequently, with high-frequency apparatus we must use very small inductances, such as are measured in millionths of a henry or in **microhenrys**. These small inductances are secured with coils or "windings" having no iron or steel core but having only air and non-magnetic supports around and within the turns. They are called **air-core coils**.

To change the inductive reactance formula for use with microhenrys of inductance we would have to multiply the term 6.2832 by one million, since we divide the inductance term by one million.

The formula may be simplified by dividing instead of multiplying to give,

$$\text{Inductive reactance in ohms} = \frac{\text{frequency in cycles} \times \text{inductance in microhenrys}}{159155}$$

Now lets look at a formula previously given for capacitive reactance in ohms.

$$\text{Capacitive reactance in ohms} = \frac{159155}{\text{frequency in cycles} \times \text{capacitance in microfarads}}$$

Certainly there is a great resemblance between the formulas for capacitive and inductive reactances. In one we divide 159,155 by the product of frequency and capacitive reactance, while in the other we divide the product of frequency and inductive reactance by 159,155.

If we have a given inductance in microhenrys, and if we gradually increase the frequency, the inductive reactance in ohms will increase directly with the increase of frequency. But if we have a given capacitance in microfarads, and gradually increase the frequency, the capacitive reactance in ohms will become less and less as the frequency increases. As the frequency changes, inductance and capacitance act oppositely; the former increasing its reactance and the latter lessening its reactance.

If a circuit contains one or more coils or inductors, and no capacitors, the reactance of that circuit will be chiefly inductive. If a circuit contains one or more capacitors, and no coils, its reactance will be chiefly capacitive. If a circuit contains both coils and capacitors its reactance may be either inductive or capacitive, depending on which kind of reactance is the greater. If the inductive reactance in ohms of the coil or coils is greater than the capacitive reactance in ohms of the capacitor or capacitors, then the net reactance of the circuit is inductive. If the capacitive reactance is the greater, then the net reactance is capacitive.

It is interesting to note that every circuit contains some inductance and some capacitance even though there are neither coils nor capacitors in that circuit. Every circuit contains inductance because every conductor, including the straightest wires, possesses some inductance. This comes about because a change of electron flow causes a change of magnetic lines of force around the conductor, and when these lines of force expand or collapse

on the conductor they induce an emf that opposes the change of electron flow—and this is the property that we call inductance. Every circuit possesses capacitance because conductors in some parts of the circuit are separated from those in other parts by insulation which acts as the dielectric, and because when electron flow exists there are potential differences between various parts of the circuit which act like potential differences on the plates of a capacitor.

IMPEDANCE—It is impossible to construct a circuit with only the opposition of inductive reactance, of capacitive reactance, or of both reactances, because in every circuit consisting of conductors we have also the resistance of the conductors. The total opposition to changing electron flows in a circuit then is due to a combination of resistance and reactance. This combined opposition is called **impedance**. Like all other oppositions to electron flow, impedance is measured in ohms.

The formula for impedance in ohms isn't quite so easy to use as our other "opposition" formulas because it reads that impedance in ohms is equal to the square root of the sum of the squares of the resistance and the net reactance in ohms, or,

$$\text{Impedance in ohms} = \sqrt{\left(\begin{array}{c} \text{resistance} \\ \text{in ohms} \end{array}\right)^2 + \left(\begin{array}{c} \text{net reactance} \\ \text{in ohms} \end{array}\right)^2}$$

Fortunately, it is possible to determine the approximate impedance when we know the resistance and net reactance by using a simple device called the impedance triangle as shown in Fig. 246.

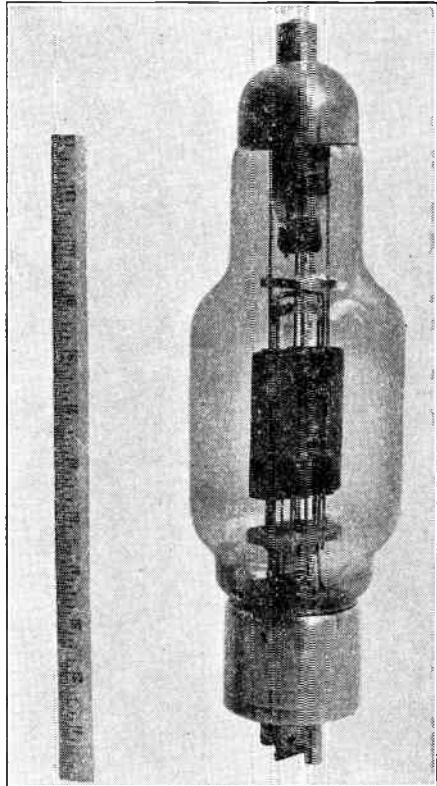

Fig. 245. A type WL-204-A air-cooled vacuum triode for use at high frequencies.

It is necessary only to draw a right angle, or a square corner, extend one side to a length proportional to the resistance in ohms, extend the other side to a length proportional to the net reactance in ohms, then measure the distance between the far ends of these lines—which will be proportional to the impedance in ohms. Note that this construction and formula refer to a series connection of units involved.

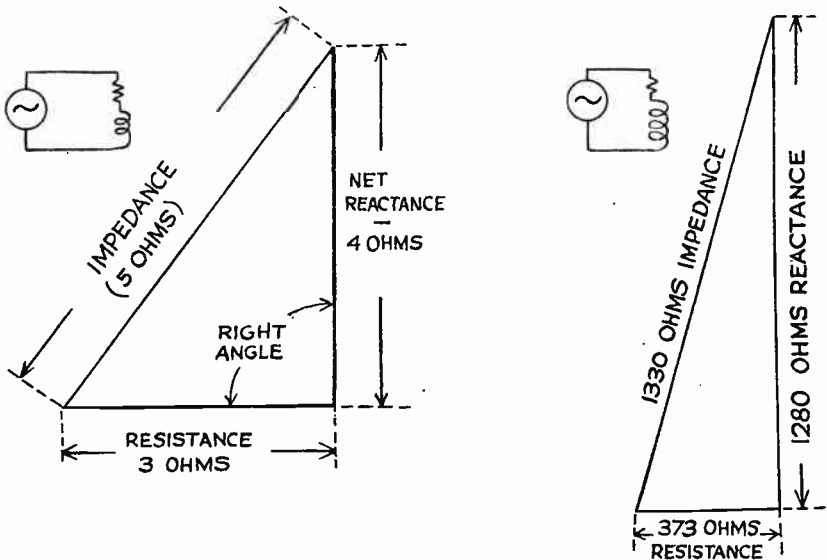

Fig. 246. The impedance triangle and how it may be used.

One of the triangles in Fig. 246 is laid out for a resistance of 3 ohms and a net reactance of 4 ohms. The units of length might be 3 inches and 4 inches, or any other convenient units such as quarters or eighths or hundredths of an inch. The length of the impedance side of the triangle, measured in the same unit, then gives the impedance, which in this case is 5 ohms. The other triangle is laid out for 373 ohms of resistance and 1280 ohms of net reactance. Measurement of the third side shows the impedance to be about 1330 ohms. Actually it is 1333 ohms.

As a matter of convenience in writing formulas and making calculations we generally use letter symbols for reactance and impedance as follows:

X stands for reactance, either inductive, capacitive, or net.

X_L stands for inductive reactance.

X_C stands for capacitive reactance.

Z stands for impedance.

RESONANCE—In Fig. 247 we have a source capable of furnishing high-frequency voltages. Connected to the source is a circuit in which is inductance of 101.3 microhenrys, capacitance of 0.001 microfarad, and total resistance of 5 ohms in all the conductors.

We shall figure out the capacitive and inductive reactances, also the impedance, of this circuit at frequencies of 400,000 cycles, 500,000 cycles, and 600,000 cycles. Frequencies so high as these generally are specified as so many kilocycles. One kilocycle is equal to 1,000 cycles, so the frequencies just named would be specified as 400 kilocycles, 500 kilocycles, and 600 kilocycles. The word kilocycle may be abbreviated to kc.

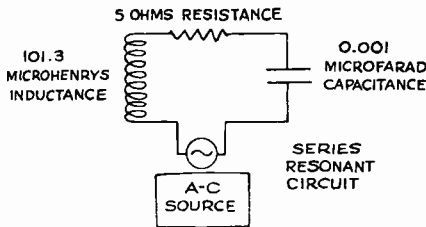

Fig. 247. The series circuit which is resonant at 500,000 cycles.

Here is a list of the reactances and impedances for the circuit:

Frequency kilocycles	Inductive reactance ohms	Capacitive reactance ohms	Net reactance ohms	Impedance ohms
400	254.6	397.9	-143.3	143.4
500	318.3	318.3	0	5.0
600	382.0	265.3	+116.7	116.8

Here we observe the important fact that for one certain frequency the inductive and capacitive reactances balance or cancel each other, leaving the impedance equal to only the resistance. At either lower or higher frequencies we have a considerable reactance, either inductive or capacitive, and so have relatively high impedances. The frequency at which the reactances balance and leave the impedance equal to the resistance is called the **resonant frequency**, and at this frequency the circuit is said to be in **resonance**.

In Fig. 247 the applied voltage, the inductance and the capacitance are in series with one another. When these three are in series we have what is called a **series resonant circuit**. In Fig. 248 at A we have another series resonant circuit, because the voltage is

introduced by induction into the inductance from another inductance in a separate circuit, but when it appears in the resonant circuit this voltage is in series with the inductance and capacitance.

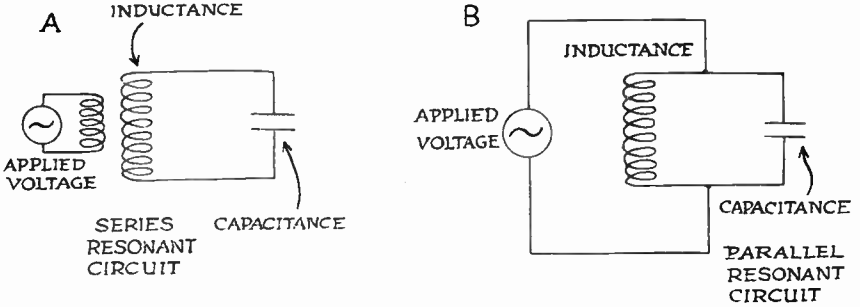

Fig. 248. At A a series resonant circuit, at B a parallel resonant circuit.

At B in Fig. 248 we have a resonant circuit in which the inductance and capacitance are in parallel with respect to the applied voltage. As with other parallel circuits, the voltage of the source is applied equally to the inductance and the capacitance. This is a parallel resonant circuit.

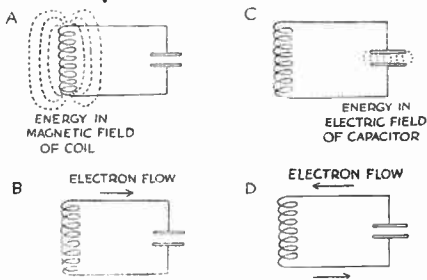

Fig. 249. The action of a resonant circuit as energy shifts between the coil and the capacitor.

A coil and condenser combination that is resonant to some particular frequency will exhibit the resonance effect regardless of whether the applied voltage is connected in series or in parallel with the coil and condenser combination. However, the opposition offered by the resonant circuit to the applied voltage will be different, for in the series resonant circuit the impedance is minimum at resonance but in the parallel resonant circuit the impedance at resonance is maximum.

The action of a resonant circuit may be represented as in Fig. 249 where we begin at A with practically all the energy momentarily stored in the magnetic field which has been built up around the coil by a change of electron flow in the coil. As the magnetic field collapses, its energy re-enters the coil and causes an electron flow as at B. This flow charges the capacitor, whereupon the energy is stored in the electric field or "electrostatic" lines of force between the capacitor plates as at C. Then the capaci-

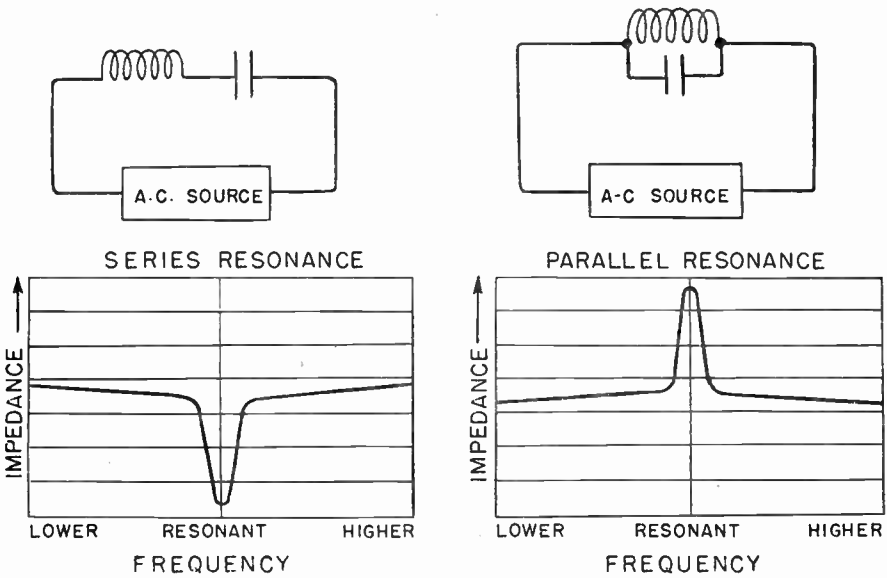

Fig. 250. With reference to the voltage source or energy source a series resonant circuit has minimum impedance, while a parallel resonant circuit has maximum impedance, at the resonant frequency.

tor discharges to force an electron flow in the opposite direction, as at D, and another magnetic field appears around the coil so that we start over again at A. These circulating electron flows and transfers of energy continue at the resonant frequency.

Fig. 250 shows how resonant circuits behave with reference to the source of a-c voltage. With series resonance, as at the left, the impedance drops gradually as the frequency increases, until, at and near resonance, the impedance offered to the source drops to a low value. This allows the source voltage to send a large electron flow through the resonant circuit at the resonant frequency. With a parallel resonant circuit, as at the right, the im-

pedance offered to the sources increases slowly until, at and near resonance, the impedance increases to a high value.

With parallel resonance, as at the right in Fig. 250, there is minimum electron flow from the source into the resonant circuit, but in the circuit itself there are large circulating electron flows represented in Fig. 249. Although the electron flow from the source is small, the impedance in its path is so great as to result in delivery of much power into the resonant circuit, and this power maintains the circulating electron flow in the resonant circuit.

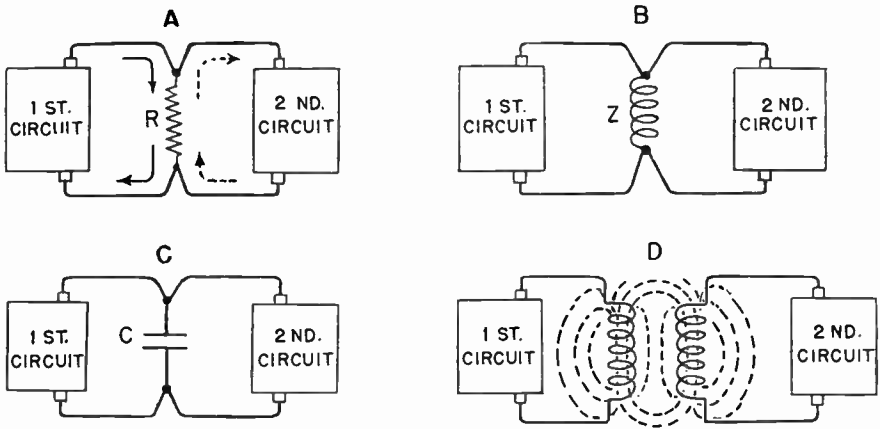

Fig. 251. Some common methods of coupling two circuits. A, resistance coupling. B, direct inductive coupling. C, capacitive coupling. D, coupling by mutual inductance.

COUPLED CIRCUITS—Two or more circuits are said to be coupled when some of the energy produced by voltages and electron flows in one circuit is transferred to another circuit where it produces an emf and also an electron flow if the other circuit is closed to complete a path for electron flow. There are several ways of obtaining coupling between circuits.

At A in Fig. 251 we have resistance coupling. Resistor R is common to both circuits or is a part of both circuits. It is plain that if the first circuit causes electron flow through the resistor as shown by solid-line arrows there will be a potential difference across the resistor, and this potential difference will cause electron flow through the second circuit.

At B in Fig. 251 we have direct inductive coupling. The impedance of the inductor or coil Z acts to transfer a potential difference from the first to the second circuit just as resistor R causes

such a transfer in diagram A. At C we have **capacitive coupling**, where the impedance of capacitor C causes potential differences, due to its charging from the first circuit, to be applied to the second circuit.

At D in Fig. 251 we have **inductive coupling** or have coupling by **mutual inductance**. The lines of magnetic force which are caused to rise and fall in one coil by changes of electron flow in that coil cut through not only the turns of this first coil but also through the turns of the other nearby coil, and this cutting of the conductors in that other coil by lines of force produce in it emf's. Thus there is a transfer of energy from the first to the second circuit. Mutual inductance is a property of coils close together by which each produces in the other an emf whenever there is a change of electron flow and a resulting change of magnetic lines of force in either coil.

OSCILLATORS—An oscillator for the production of high-frequency voltage and electron flow consists of one or more vacuum-tube tubes, one or more circuits which may be made resonant at the desired operating frequency, and some type of coupling between plate and grid circuits to allow a part of the power in the plate circuit to be fed back into the grid circuit.

A simple oscillator circuit is shown by Fig. 252. The resonant circuit, consisting of capacitor C and coil L1 is connected between the grid and cathode of the triode tube. In the plate circuit is a coil which is inductively coupled to coil L1 in the grid circuit. The plate-circuit coil allows "feedback" of energy from the plate circuit to the grid circuit through the coupling.

What happens in the circuit of Fig. 252, and in other types of oscillator circuits, is this: With d-c power applied to the circuit there is bound to be some small change of voltage or electron flow in the plate connections. The change might result from turning on the power, from a slight variation in cathode heating, or from a slight change of the applied d-c voltage. Let's assume that the grid of the tube is at zero potential with reference to the cathode at this instant, and that the change taking place is an increase in plate voltage.

Now electron flow in the plate circuit will increase to some value which is determined by the zero grid voltage, the type of tube, the applied plate voltage, and the impedance and other characteristics of the circuit. This rise of plate electron flow is a change of flow, and through the coupling it induces a voltage in

the grid circuit. The coupling is arranged in such relation that the increase of plate electron flow would make the grid positive and a decrease will make the grid negative. At the end of the rise of plate electron flow there is a moment at which this flow stops changing in value and, with no change of plate electron flow, there is no voltage induced in the grid-circuit, so the grid voltage becomes zero and the electron flow in the plate circuit starts to decrease. But as soon as the plate electron flow commences to decrease we have a change that makes the grid negative and this makes the plates electron flow decrease still more.

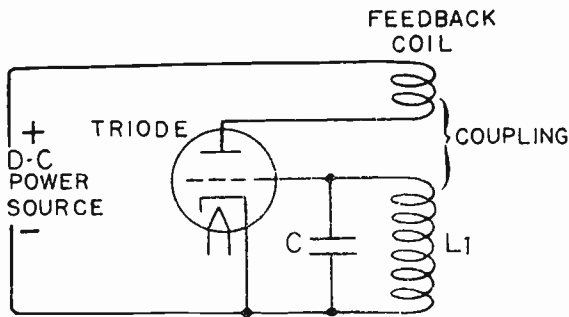

Fig. 252. Oscillator with a resonant (tuned) grid circuit and with feedback from a coil in the plate circuit.

The plate electron flow continues to decrease until it reaches a minimum value that depends upon the values of the circuit parts and the applied voltage. With momentarily no change in plate electron flow the grid voltage goes back to zero. This allows the plate electron flow to increase toward the value permitted by zero grid voltage, but this increase of plate electron flow makes the grid positive by inductive action, and so the electron flow continues to increase to a value limited by the applied plate voltage and the properties of the circuit. There the increase stops, the grid goes back to zero, the plate electron flow reverses, and so the action continues.

The frequency at which the plate electron flow goes through a complete cycle of changes from maximum to minimum and back to maximum will be the frequency to which the grid circuit is resonant, for that is the only frequency at which impedance in the resonant grid circuit will be minimum and will allow comparatively free circulating electron flow in that circuit.

Instead of a resonant grid circuit we might have a resonant plate circuit as at A in Fig. 253, and the circuit would oscillate as before. Another way would be to have both the grid circuit and the plate circuit resonant to the same frequency, as at B. Here the feedback coupling is capacitive, it is through the capacitance

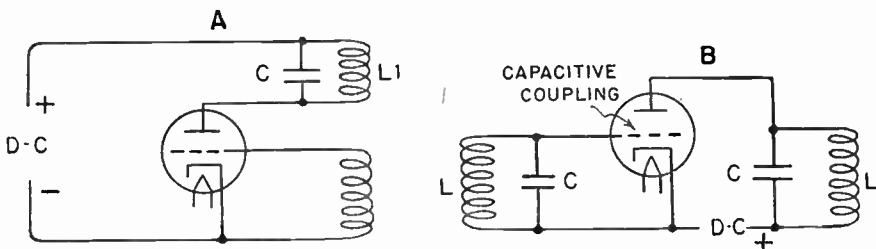

Fig. 253. A "tuned plate" oscillator with resonant plate circuit at A, and a "tuned-grid tuned-plate" oscillator with both circuits resonant at B.

between plate and grid inside the triode tube. Incidentally, a resonant circuit frequently is called a tuned circuit, especially when either the inductance or the capacitance (usually the capacitance) may be varied in order to tune the circuit or make it resonant to some certain frequency.

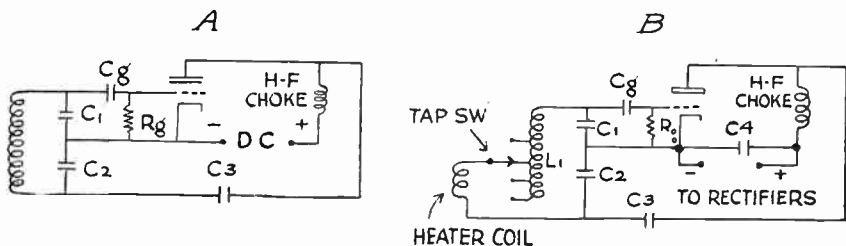

Fig. 254. The basic Colpitts oscillator circuit at A, and at B the principle of its application to a power oscillator for induction heating.

Diagram A of Fig. 254 shows the elementary principle of the "Colpitts" oscillator. Diagram B shows added parts needed for practical operation. This type of circuit is used in many high-frequency power units. The resonant circuit consists of capacitors C1 and C2 and inductance coil L1. Capacitor C3 blocks d-c electron from the rectifier system so that it cannot enter the resonant circuit.

The high-frequency choke has a high inductive reactance at the resonant frequency, which prevents high-frequency electron flow in the resonant circuit from getting back into the rectifier system. Capacitor C4 bypasses any escaping high-frequency electron flow

back to the cathode of the oscillator tube. Part of the inductance in the resonant circuit consists of coil L1 while the remainder is in the heater coil. The two coils are connected together through taps which allow using heater coils of various amounts of inductance while maintaining approximately constant total inductance by cutting in more or less of coil L-1.

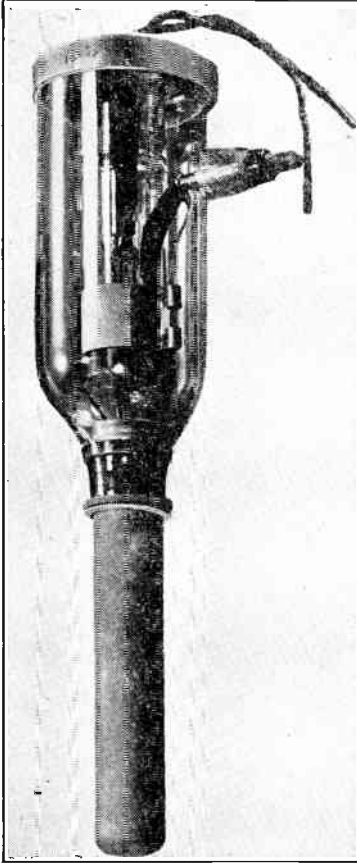

Fig. 255. A water-cooled pliotron such as used in high-frequency oscillators.

Feedback coupling in Fig. 254 results from having capacitor C1 in the plate circuit (between plate and cathode) and capacitor C2 in the grid circuit (between grid and cathode), while both capacitors are in the oscillating circuit with coil L1. Oscillating or circulating electron flow in the resonant circuit charges and discharges both capacitors simultaneously in each cycle. Voltages across capacitor C2 are applied between the tube grid and cathode. The relative voltages in the plate and grid circuits are determined by the relative capacitive reactances of the two capacitors C1 and C2.

Any single oscillator tube is, in effect, an amplifier for its own grid voltage changes, and supplies those grid voltage changes from its own plate circuit. High power outputs in the resonant circuit are secured by the use of large pliotron tubes such as the types illustrated in Figs. 245 and 255. In some circuits the oscillator tube is of relatively small power capacity, and the high-frequency output voltages from this small tube are amplified by one or more

power tubes which furnish the high power output for the system. It is possible also to use two oscillator tubes in various circuits, one of which is shown by Fig. 256.

In Fig. 256 the resonant circuit consists of capacitors C1 and C2, coils L1 and L2, and the heater coil. Feedbacks for the grid circuits are through coils L3 L4. The blocking capacitors C3 and

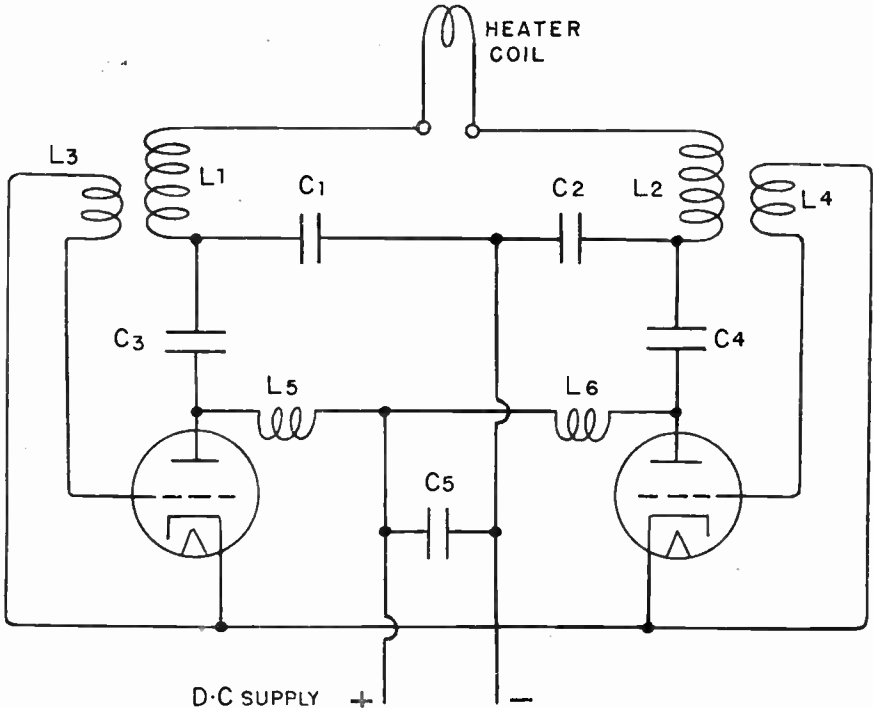

Fig. 256. A power oscillator circuit in which two oscillating tubes are connected to a single resonant circuit.

C4 isolate the resonant circuit from the d-c supply, while high-frequency chokes L5 and L6 together with bypass capacitor C5 keep high-frequency electron flow out of the d-c supply system.

INDUCTION HEATING—When any metallic object is placed within the turns of a coil carrying high-power high-frequency electron flow, as in Figs. 243 and 244, the magnetic lines of force produced by the coil pass through the metallic object and produce heat in the object. Heat is produced by electron flow which is induced in the metal object by lines of force from the coil. The electron flow circulates within the metal, and in so doing must

overcome resistance of the metal. The result is an expenditure of power proportional to electron flow and resistance, the well known I^2R relation, and this power produces the heat.

The electron flows that circulate in the metal being heated are called eddy currents because they whirl or eddy around and around within the metal. How they are produced is explained in Fig. 257. At A are represented the primary and secondary windings of a transformer. They are single-turn windings, to make a simple diagram, but they act like any number of turns. When electron flow in the primary is in the direction of solid-line arrows there will be an induced electron flow in the secondary in the direction of broken-line arrows if the secondary is in a closed circuit. This we

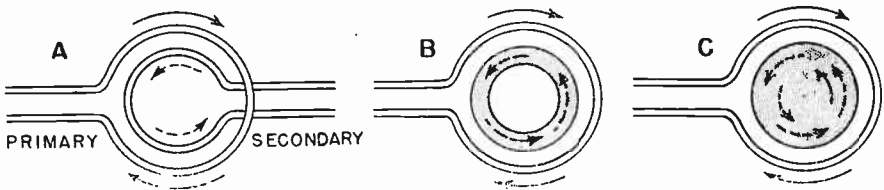

Fig. 257. How eddy currents or circulating electron flows are induced in a piece of metal to be heated by induction.

know from having studied the relations of primary and secondary voltages in transformers, and from the fact that electron flows are in directions corresponding to the voltages. At B we have closed the secondary into a ring, but, of course, still have the circulating electron flow. At C the ring has been made a solid disc, which represents a solid piece of metal being heated, and here still we have the circulating or eddying electron flow.

If the heated material is iron or steel it is magnetized by the magnetic lines of force from the heating coil. Every time the directions of electron flow and magnetic lines reverse, the direction of the magnetism must be reversed; the "poles" which were south poles must be changed to north poles, and vice versa. Magnetic polarity of a piece of iron or steel results from a lining up of the poles of the molecules or particles in the iron or steel, and to shift these molecular poles back and forth at a high-frequency rate requires much work or much power. All this shifting of magnetism causes heating which we may think of as resulting from a kind of molecular friction in the metal.

Another peculiar action which occurs with induction heating is called skin effect. At very high frequencies the magnetic lines of force, or flux, concentrate near the surface of a metal, so that

by far the greater portion of the electron flow is near the surface with hardly any remaining in the interior of the work. The result is that nearly all the heat due to I^2R appears at the surface of the material and heating of the interior is due chiefly to heat conducted inwardly from the hot surface. The skin effect is greater in iron or steel than in non-magnetic metals such as copper and aluminum. Of two non-magnetic materials, the one of lower resistance in proportion to size will have the greater skin effect.

It is skin effect that makes possible very high temperatures at surfaces of work which is to be surface-hardened or case hardened, with relatively very little heating of the interior provided the high-frequency electron flow is shut off before the interior has time to get hot by conduction from the surface. The higher the frequency the more the heating is concentrated at the surface. For surface heating, especially of small parts, the frequency may be many millions of cycles per second. When it is desired to heat the work more uniformly throughout its mass we may use lower frequencies which cause less skin effect. Frequencies of 15,000 to 60,000 cycles per second may be used to produce uniform heating such as required for melting or fusing the work material.

POWER OSCILLATOR FEATURES—An industrial oscillator will have a transformer for stepping up the a-c line voltage to something like 7,500 to 15,000 volts ahead of the rectifiers, which ordinarily are mercury-vapor phanotrons. The high-frequency output power may be varied by adjusting the transformer voltage applied to the rectifiers. Maximum high-frequency output electron flows may be between 100 and 200 amperes. Sometimes the high-frequency voltage to a heater coil is reduced, while the electron flow rate is increased, by connecting the heater coil to the resonant circuit through a step-down transformer consisting of air-cored coils.

Heating coils such as shown in Fig. 244 usually are shaped so that there is but little clearance between them and the work. The less the clearance, without taking a chance of the work touching the heater coil and short-circuiting its turns, the greater will be the energy transferred to the work and the quicker a given temperature will be produced.

High-frequency conductors, both for resonant circuit coils inside the oscillator and for heater coils, may be made of copper tubing rather than solid. Because of skin effect the effective resistance of tubing of certain diameter may be less than that of a

solid conductor of the same diameter, since there would be very little electron flow inside the solid conductor were it used. Cooling water may be circulated through the coil tubing, and in high-power oscillators water cooling may be used for the capacitors in the resonant circuit and for oscillator tubes of the style illustrated in Fig. 255. Heating and cooling time periods may be automatically controlled by time-delay circuits and relays.

ELECTROSTATIC HEATING—Electrostatic heating makes use of the fact that the material of the dielectric between the plates of any capacitor becomes heated to a greater or less extent when

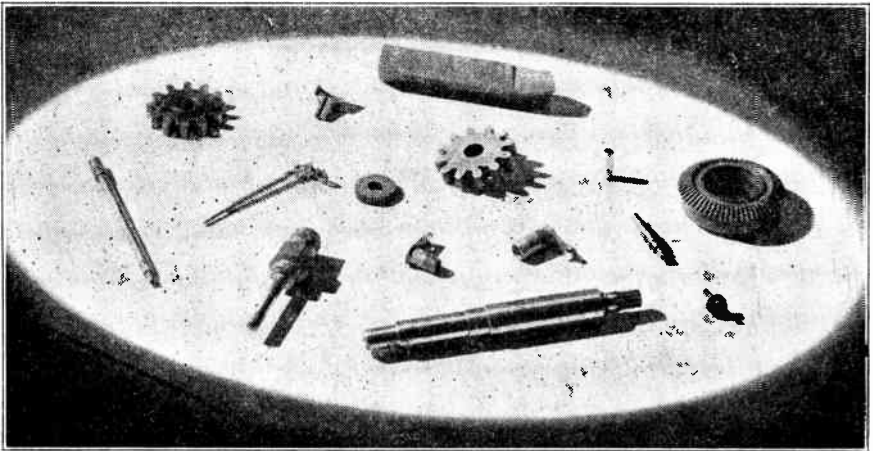

Fig. 258. Typical small parts which are brazed or hardened by induction heating.

alternating potentials are applied to the capacitor plates. The material to be heated is used as the dielectric between two or more plates connected to the resonant circuit or an oscillator. Inasmuch as the dielectric of a capacitor always must be an insulator, this method of heating is possible only for materials which are insulators, such as wood and plastic compositions. Thus for raising the temperature in insulating materials we have electrostatic heating, and for raising the temperature in conductors we have inductive heating.

Dielectric heating is called electrostatic heating because the name **electrostatic** relates to anything having to do with electric charges, with capacitors, or with electric fields and lines of force such as exist around and between charged bodies.

The chief reason that a dielectric becomes heated is illustrated by Fig. 259 where the atoms or molecules which remain stationary in a dielectric material are represented by large circles with plus signs, and negative electrons by smaller circles with minus signs. When the capacitor plates are charged, the negative electrons are displaced or attracted a little ways toward the positive plate and repelled from the negative plate. When the charges reverse, the electrons are displaced in an opposite direction as they move toward the plate which has changed from negative to positive and away from the one which has changed from positive to negative.

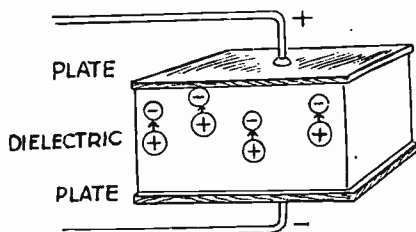

Fig. 259. Electrons in any substance acting as a dielectric are slightly displaced from their atoms or molecules when the capacitor plates are charged.

The electrons are displaced one way and the other during every cycle of alternating potential difference on the plates, which may be hundreds of thousands of times a second. This electron movement in the dielectric produces heating just as does electron movement in a conductor which is carrying electron flow. The higher the frequency the greater is the heating when the power is maintained at a value causing a given electron displacement.

The voltage applied to the plates must be increased as the thickness of the heated material (the dielectric) is increased provided the heating is to be done in the same length of time. From Fig. 259 it is quite obvious that heating will be uniform through the material if the material is of the same nature throughout. For very thin materials the potential difference may be only a few hundred volts. The upper limit is about 15,000 volts, because at any higher voltages there is danger of a "corona discharge" or "brush discharge" from the edges of the plates. This is a visible pale purple glow around the corners and edges of a conductor which is highly charged or which is operating at high voltages. The glow results from ionization of the gases in the surrounding air.

Connections of the heater plates for electrostatic heating are shown by Fig. 260. In all the diagrams the resonant circuit consists of capacitors C1 and C2, and coil L, which are connected to the other circuits and the oscillator tube as in preceding diagrams. At A the capacitors C3 and C4 are in series with the heater H so that their capacitive reactance reduces the voltage applied across material which may be thin, or which for any reason has a resistance or impedance so low that high voltages would permit electron flow to be forced right through it. At B the heater is connected directly to the resonant circuit so that high voltage may be applied to heated materials having relatively high resistance. At C is shown the arrangement of several heater plates connected alternately to the two sides of the resonant circuit, with the plates inserted at various points in a thick mass of material to be heated.

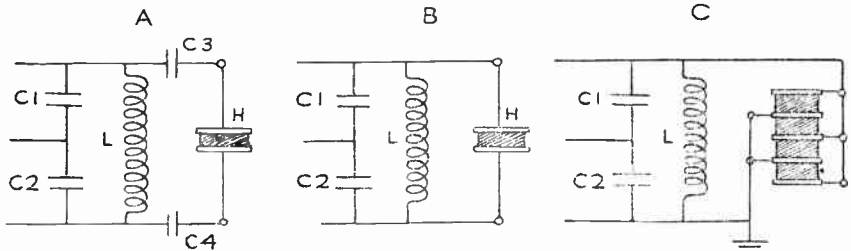

Fig. 260. Various connections of the capacitor plates or heater plates between which is the material to be heated as it becomes the dielectric of a capacitor.

OSCILLATOR RELAY CONTROLS—Low-power oscillators employing tubes of sizes similar to those for radio work are used for relay operation in many kinds of control circuits. A sensitive relay may be operated directly from the oscillator, but it is more common practice to use a second tube controlled by the oscillator output, with the relay coil in the plate circuit of this second tube.

The action of the oscillator in control circuits may be varied in many ways, chief among which are the following:

1. Starting and stopping oscillation. There is electron flow in the resonant circuit during oscillation and none when oscillation stops. There may be less or greater d-c electron flow through the plate during oscillation than when there is no oscillation. The changes of either high-frequency or d-c electron flow may be used to actuate a control device or an indicating meter.

2. Varying the amplitude of the oscillating electron flow and voltage in the resonant circuit; that is, varying the strength or

intensity of oscillation. Part of the oscillating voltage may be rectified to produce a d-c voltage which is applied to the grid of the following amplifier or power tube.

3. Changing the "tuning" of the resonant circuit so that the frequency of oscillation is varied. The frequency may be changed by varying the capacitance or by varying the inductance in the resonant circuit. The changes of frequency are identified or detected, often by comparing them with another high-frequency which is maintained at a constant value.

The majority of these small control oscillators employ what is called the Hartley circuit or some modification of it. A typical Hartley oscillator circuit is shown by Fig. 261. The resonant circuit consists of capacitor C1 and coil L1. The coil is divided into

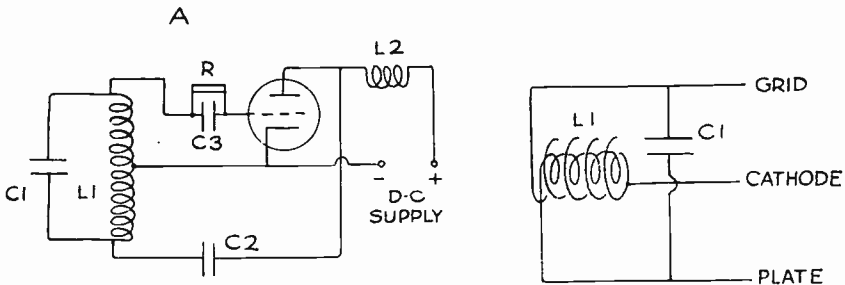

Fig. 261. One variety of the Hartley oscillator circuit.

two sections by a tap connected to the tube cathode. The upper part of the coil is in the grid circuit and the lower part in the plate circuit. Oscillating voltages in the plate and grid circuits are proportional to the relative inductances and inductive reactances of the portions of L1 included in each circuit. Feedback coupling occurs through the capacitive reactance of capacitor C1, which is in both the plate circuit and grid circuit. Additional feedback may be had if the two sections of coil L1 are placed close together, as indicated by diagram B, so that there is mutual induction and inductive coupling between the sections.

The negative side of the d-c supply is connected to the cathode of the oscillator tube, and the positive side is connected through high-frequency choke L2 to the plate, thus keeping high-frequency out of the d-c supply circuit because of the high reactance of this choke at the operating frequencies. High-frequency electron flow between the plate and the resonant circuit goes through capacitor

C2, which is of great enough capacitance to have very little capacitive reactance at the operating frequencies.

GRID CAPACITOR AND RESISTOR—Capacitor **C3** and resistor **R** in parallel with each other and in series with the grid circuit of Fig. 261 act to maintain such a negative bias on the grid of the oscillator tube as will insure satisfactory and stable operation of the circuit. During each half-cycle in which the grid is positive, capacitor **C3** is given some charge because of grid rectification in the oscillator tube. During the alternate half-cycles some of this charge leaks off through resistor **R**, but the rate of leak or discharge is small. The result is that the charge on the capacitor gradually increases and makes the grid more and more negative. As the grid is made more negative, the pulses of electron flow in the grid circuit decrease, because they result from a positive grid voltage. The grid voltage thus is maintained at a value which permits just enough grid electron flow to keep the capacitor at a fixed charge or at a fixed voltage, which becomes the negative grid bias.

The value of the grid bias maintained by the capacitor may be varied by changing the resistance of **R**, which changes the rate at which the capacitor discharges. The amplitudes of the oscillating voltage and electron flow in the resonant circuit depend on the maximum plate electron flow. The maximum plate electron flow depends on the grid bias. Consequently, by varying the resistance of **R**, we may vary the amplitude of the oscillations.

The time constant of the grid resistor **R** and capacitor **C3** (megohms \times microfarads) must be very long in comparison with the rate of oscillation. For example, with oscillation at 50 kilocycles which means a cycle length of $1/50,000$ second, the time constant must be much greater than $1/50,000$ second or else we will have a rapid charge and discharge of the capacitor which will cause such rapid changes of grid bias as to give a starting and stopping of electron flow at a frequency determined by the time constant rather than by the resonant circuit. Furthermore, the capacitive reactance of the grid capacitor **C3** must be negligible in comparison with the resistance of resistor **R** at the operating frequency. As an example, with a frequency of 50 kilocycles the reactance of a capacitance of 0.0005 microfarads would be about 6,870 ohms, and by using resistance of something like one megohm for **R**, we would have negligible capacitive reactance in comparison with the resistance. With a frequency of 50 kilocycles, a capacitor of 0.0005

microfarad, and a resistor of 1 megohm, the time constant for the resistor and condenser combination would be 0.0005 second whereas the period of oscillation for the resonant circuit would be 0.00002 second.

The resistor-capacitor combination in series with the grid has here been shown for the first time in connection with a Hartley oscillator, but this combination has no particular connection with this one oscillator. The resistor, usually called a "grid leak", and the capacitor are merely a convenient and economical combination for automatically obtaining a self regulating grid bias, and it may be used in any circuit where the grid becomes positive during at least a portion of every cycle of applied voltage.

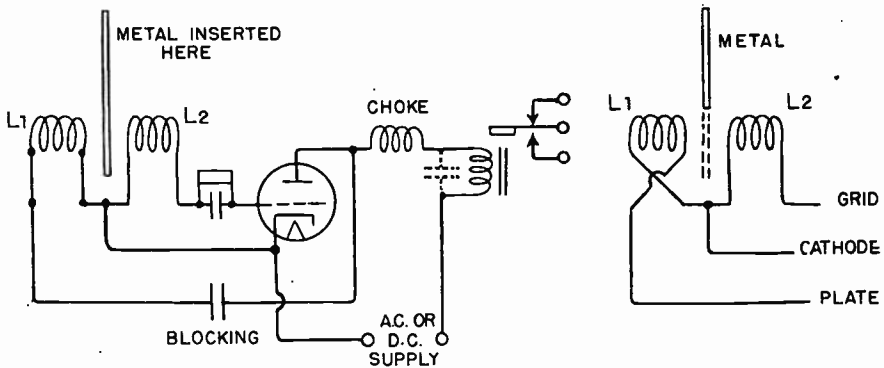

Fig. 262. A circuit in which oscillation may be stopped or started by insertion or withdrawal of metal in the space between plate and grid coils.

OSCILLATOR RELAYS—Fig. 262 shows the circuit for an oscillator-operated relay. The circuit is a modification of the Hartley type with the resonant circuit consisting of coils L1 and L2 and of the capacitance between the grid and plate of the oscillator tube. Most of the feedback is obtained by arranging L1 and L2 for inductive coupling. The relay coil is in the d-c plate circuit. If operation is from an a-c supply we have self-rectification in the tube, and use a smoothing capacitor across the relay coil as shown in broken lines.

When metal of any kind comes into the space between coils L1 and L2 the metal absorbs and dissipates as eddy-current heating the energy that otherwise would feed back from the plate to the grid circuit, thus stopping oscillation or preventing it from starting. The resulting changes of d-c electron flow or rectified d-c flow

in the plate circuit and relay coil pull in or drop out the relay. If the grid leak resistor is of such value as to produce a highly negative bias during oscillation the electron flow will be less while the tube oscillates than when it stops oscillating.

If either of the coils is reversed in relation to the other, as indicated by one of the diagrams in Fig. 262, the phase relation of voltages in the two coils will be reversed so that energy fed back from the plate circuit acts not to promote oscillation but to prevent it. This is a "degenerative" feedback. If metal now comes between the coils it prevents feedback of the reversed energy and we have oscillation.

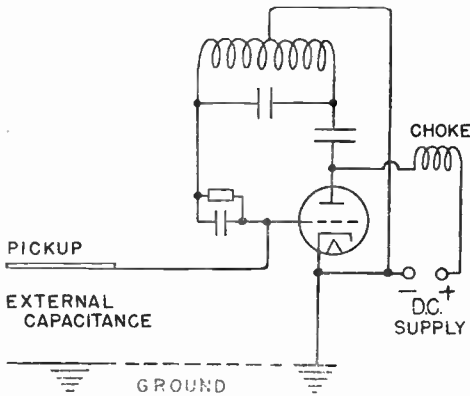

Fig. 263. An oscillator with a capacity pickup connected to the grid of the tube.

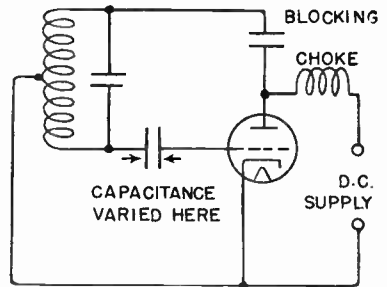

Fig. 264. Amplitude of oscillating voltages and electron flows may be varied by changing the capacitance (and reactance) of a capacitor between the resonant circuit and the grid of the tube.

The principle illustrated by Fig. 262 may be applied in many ways. The two coils and the oscillator may be mounted on an elevator car, with pieces of metal placed at the various floor levels. A relay acts to prevent opening of the elevator doors until the car is correctly leveled with metal between the coils. In many applications the metal is a small, thin piece of aluminum attached to the pointer of some kind of indicating meter whose pointer movements and indications are changed into relay action. The relay may be replaced with a magnetically operated counter which will register every time some metal object passes between the coils. Time intervals can be recorded in accordance with periods between passing of metal objects between the coils.

If, as shown in Fig. 263, a metal plate or a wire is attached to the grid of an oscillator tube, and the cathode or the d-c supply

circuit is connected to ground, there is capacitance between the external "pickup" plate or wire and ground, and this capacitance is between the grid and cathode of the tube. When any object or any person comes into the space between the pickup and ground that object or person is in the dielectric of the capacitor formed by the pickup and ground. The resulting change of grid-to-cathode capacitance will change the operating frequency of the oscillator, will change the amplitude of the oscillations, or, if the person or object comes very close to or in contact with the pickup, the oscillation will be stopped.

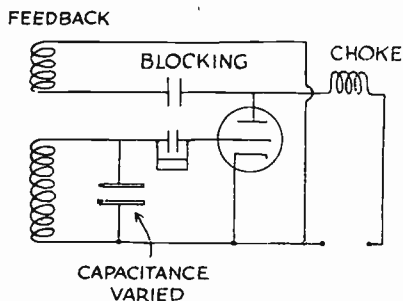

Fig. 265. Tuned grid oscillator in which the resonant frequency is varied by changing the grid capacitance.

When an oscillator fitted with a grid pickup or a "capacitance pickup" is arranged to operate a relay, the apparatus may be used for such things as counting objects that pass the pickup, it may be used for a burglar alarm, for opening a door at the approach of a person, to stop the feed of a machine tool, for filling of bottles to certain levels, for protection of safes which are made to act as the pickup, and for numerous other applications.

In Fig. 264 the grid circuit of the oscillator tube is connected to the resonant circuit through a capacitor whose capacitance may be varied, usually by movement of one plate or set of plates with reference to the other plate or set of plates. The lower the value of the variable capacitance, the greater will be its reactance, and the weaker will be the amplitude of the oscillations.

The frequency of any oscillating circuit may be varied by changing the capacitance in the resonant circuit. Such a variable capacitance is shown for a "tuned grid" circuit in Fig. 265. A variable capacitor in a tuned plate circuit would serve the same

purpose, or with a Hartley oscillator we would vary the capacitance which is across the two-section coil in the resonant circuit. The plates of a variable tuning capacitor may be moved closer together to increase the capacitance and lower the frequency, or farther apart for less capacitance and higher frequency. Movement may be caused by changes of thickness in manufactured material passing between rollers mechanically connected to the tuning plates, by changes in length of a fibre or fabric ribbon as it stretches and contracts with changes of moisture in the surrounding air, and in many other ways.

The frequency of oscillation may be varied also by arranging the tuning capacitor plates so that manufactured materials pass between them, and in so doing change the dielectric to vary the capacitance. One way of detecting a change of high-frequency is to feed it, along with another high-frequency voltage, to the grid of an amplifier tube with the two frequencies combined to produce a new one which is low enough to produce an audible note in headphones or a loud speaker.

Chapter 17

PHOTOTUBES

*Phototube Construction — Phototube Circuit — Measuring Light —
Inverse Square Law — Foot-candles — Vacuum Phototube Action —
Gas-filled Phototube Action.*

No electronic tube is simpler in construction than a phototube, for it contains only a cathode and an anode in a glass bulb which in some cases is highly evacuated, and which in others contains a small quantity of gas to allow ionization. The action of a phototube is almost as simple as its construction, for the phototube is, for practical purposes, a resistance whose value may be changed by exposing it to changes of light and of color.

The possibilities for control and measurement opened to us by this phototube resistance which changes with light and color are almost endless. Realizing that a change of resistance in a circuit containing a voltage source will bring about changes of electron flow and of potential drop, and thinking back over all the things we already have been able to do with changes of electron flow and potential drop, we may have some idea of the possibilities of phototube application.

Controls which respond to changes of light mean that we may work with a beam of light. As a light beam has no weight to delay its motion, it will travel 100 feet in the ten-millionth part of a second; moreover it may be reflected, focused, turned on and off, and otherwise directed as we wish. This is the "tool" with which we may work with the help of phototubes.

PHOTOTUBE CONSTRUCTION—Most of the phototubes used in industrial and commercial controls are constructed much as shown by Fig. 267. The cathode consists of a metal plate formed as part of a cylinder. The inner surface of the cathode is coated with "light-sensitive" materials which emit electrons when light reaches them in much the same way that a hot-cathode surface emits electrons when heated. The anode usually is a straight vertical wire supported centrally so that it is partially surrounded by the light-sensitive surface of the cathode. With this construction it is

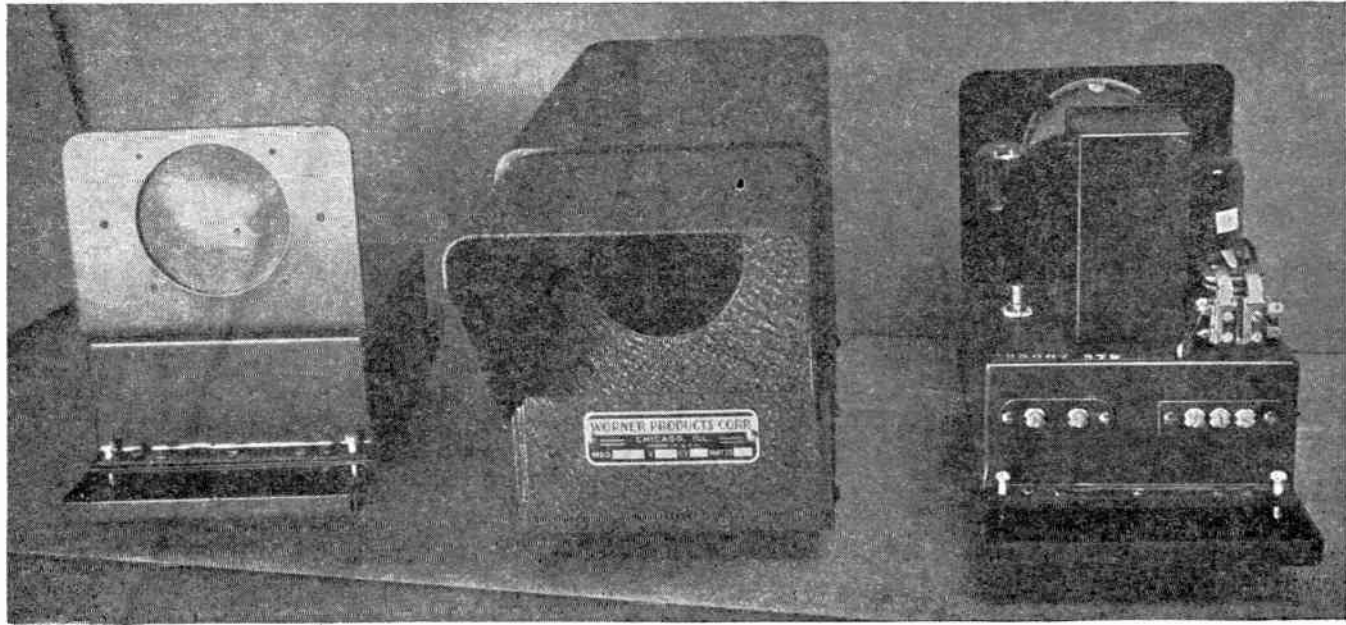

Fig. 266. This "invisible fence" uses a phototube, an amplifier, a relay and a beam of light to give warning when anyone crosses a line.

possible for light to reach the sensitive cathode surface through one side of the glass bulb, with little obstruction offered by the small anode.

Other phototubes, used chiefly for measurement work with light and color, are constructed with the light-sensitive cathode material deposited on the inside of the glass bulb as illustrated by Fig. 268. Light enters this phototube through a clear area called the window on one side of the bulb. Electrical connection to the cathode material is made through a metallic cap on the side of the

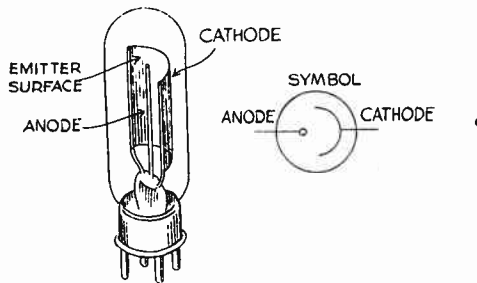

Fig. 267. The internal construction of a typical phototube, and the symbol used for any phototube containing one cathode and one anode.

bulb opposite the window. Fig. 269 illustrates another construction with which there is a window on one side of the bulb. All common styles of phototubes have bases and base pins or prongs much like those on radio tubes, and fit into sockets similar to those used for radio work. Since circuit connections are required for only two elements, cathode and anode, additional prongs on the tube base have no internal connections and serve only as mechanical supports for the tube.

The majority of present-day phototubes used for control work and for many kinds of measurement have a sensitive cathode surface consisting of an exceedingly thin layer of the metal cesium over a layer of cesium oxide which is supported on silver. These are called cesium-oxide or cesium phototubes. The special-purpose tube of Fig. 268 has a cesium-magnesium cathode and the one of Fig. 269 has a sodium cathode surface.

A PHOTOTUBE CIRCUIT—What might be called a basic phototube circuit is shown by Fig. 270. The anode of the phototube

is connected to the positive side of an energy source, and the cathode is connected through a resistor to the negative side of the source. When light reaches the phototube cathode there is electron emission from the cathode. The negative electrons are attracted to and enter the positive anode, and the electron flow

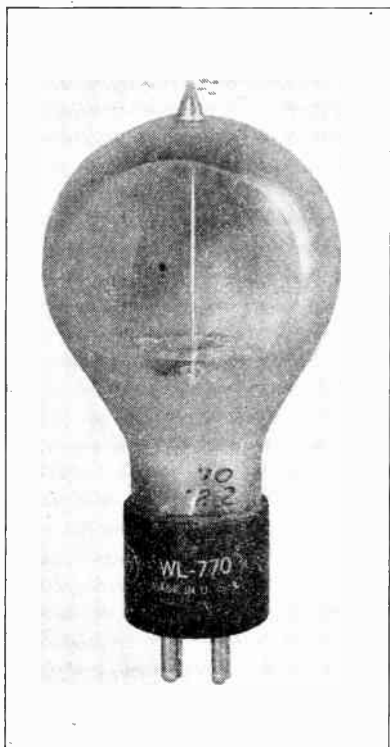

Fig. 268. WL-770 phototube which has its maximum response to energy just beyond that of visible light. It responds to the near ultra-violet "light" which our eyes tell us is darkness.



Fig. 269. FJ-405 phototube in which the cathode surface is the light-sensitive metal sodium.

proceeds through the source and the resistor. Electron flow through the resistor causes a potential drop across the ends of the resistor, and this potential drop may be applied to other circuits, such as the grid-cathode circuit of an amplifier tube. The rate of electron flow and the potential drop across the resistor are directly proportional to the light reaching the cathode of a vacuum-type phototube, and almost so in a gas-filled phototube.

In vacuum phototubes all of the energy that speeds up electrons to the point where they are emitted from the cathode surface comes from the energy in the light that falls on the cathode, and in gas-filled phototubes nearly all the electron emitting energy comes from the light. Thus it is unnecessary to heat the phototube cathode, and, in fact, cathode heating would be decidedly harmful to the sensitive surface. The phototube is a cold-cathode tube.

With hot-cathode tubes the electron emission from the cathode is usually greater than the rate at which electrons are attracted to the plate, leaving a negative space charge around the cathode. Electron flow in the plate circuit of a two-element hot-cathode tube

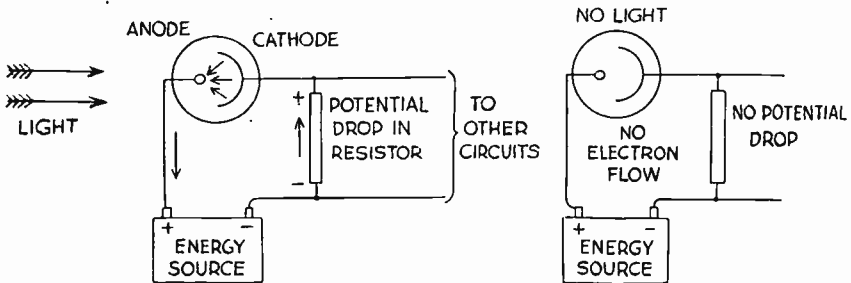

Fig. 270. The direction of electron flow in the basic phototube circuit when light reaches the phototube cathode.

is varied by changes of plate supply voltage or changes in cathode heating. But phototubes are operated at anode voltages high enough to draw all the emitted electrons to the anode, and to leave no space charge. Consequently, changes of phototube electron flow normally result only from changes of light on the cathode, and not from changes of anode supply voltage.

Phototubes always act as rectifiers, permitting only a one-way or d-c electron flow through them and their circuits. This is because the cold cathodes are coated with substances which emit electrons under the action of light, but the cold anodes are not so coated. So electron flow can be only from cathode to anode, and cannot reverse even with reversal of cathode-anode voltage unless that voltage is made destructively high.

MEASURING LIGHT—Since the electron emission in a phototube and the electron flow in its circuit is determined chiefly by flow of light energy to the cathode, it is as necessary to have measurements for light flow as it is to have measurements for electrical

forces affecting other kinds of tubes. The unit of light flow with which we shall be mostly concerned is the lumen, and next in importance is the foot-candle.

Light is a kind of energy that flows through space and through transparent materials. If light were not a form of energy it would not be able to knock electrons out of the cathode surface. Instead of speaking of light flow we shall speak of **light flux**, simply because it is customary to use the word flux.

Light flux and energy may come from the sun, from many types of lamps, or from any luminous object. A light source may be thought of as spraying light flux outwardly and more or less uniformly in all directions, just as a water sprinkler head might

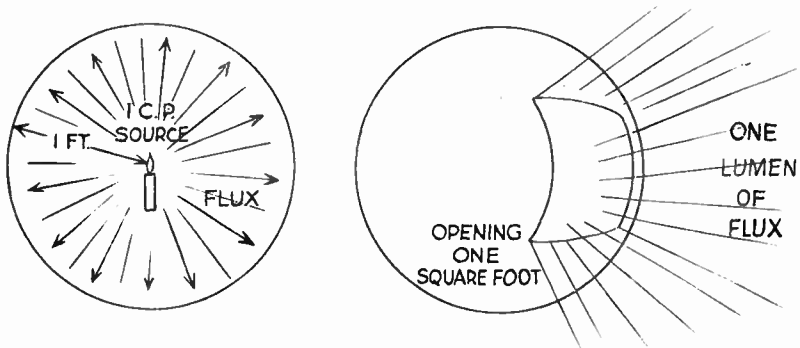

Fig. 271. A source of one-candlepower delivers one lumen of luminous flux through an opening of one square foot which is one foot from the source.

spray water. The total quantity of water flow may be measured in gallons per minute. The total quantity of light flux may be measured in lumens, the lumen being merely a unit for measurement for the quantity of light flux.

It is plain that a washtub set near the sprinkler head will receive more gallons of water per minute than will a teacup, simply because the tube has a greater opening or a greater exposed area in which to catch the water flow. Similarly, a large surface near a light source will receive more light flux in lumens than will a smaller surface placed in the same position.

Now for another comparison between a water spray and light flux. The water spray spreads out thinner and thinner as we move away from the sprinkler head, and light flux spreads thinner and thinner as we move away from the source. If we move the tub

far enough from the sprinkler it may receive no more water flow, than the teacup set close to the sprinkler, and if we move the large surface far enough from the light source it may receive no more lumens of flux than a smaller surface near the source.

Getting down to figures, a light source of one candlepower intensity emits a total light flux of 12.57 lumens. It happens that the total surface area of a ball or sphere having a radius from center to surface of one foot is just 12.57 square feet. If we place the one-candlepower light source at the center of a hollow sphere of one-foot radius, as in Fig. 271, there will be a total flux of 12.57 lumens on a total surface of 12.57 square feet, so on each square foot we must have just one lumen of flux. Now supposing we remove from the surface of the sphere just one square foot of its area. Through this opening will come one lumen of light flux from the one-candlepower source which is one foot from all parts of the opening. Naturally, the flux will spread out thinner and thinner and thinner after coming through the opening, but no matter how far it goes or how thin it spreads it still is one lumen of flux.

THE INVERSE SQUARE LAW—In Fig. 272 we have a one-candlepower light source and have openings A, B and C at distances of one, two and three feet from the source. Opening A is square, measures one foot on each side, so has an area of one square foot and, as we now know, will permit passage of one lumen of light flux under the conditions stated above. By the time this one lumen of flux gets two feet from the source it will have spread out to fill opening B, which also is square but which measures two feet on a side and so has an area of four square feet. The one lumen of flux has gone only twice as far from the source, but now has to fill four times the area or to fall on four times the original surface. By the time the flux gets three feet from the source it fills opening C, which is three feet on a side and so has an area of nine square feet.

We have the same total light flux, really the same total light, at A, B and C of Fig. 272, but it is clear that a surface at B would be lighted only $\frac{1}{4}$ as brightly as one at A, for the light must spread over four times are area, and at C the surface would be lighted only $\frac{1}{9}$ as brightly as at A because the same light now must spread over nine times are original area.

The brightness of a surface, or more correctly, the illumination of a surface, varies as the squares of its distances from the source. for the distances are 1, 2 and 3, while the relative brightness is as

1, 4 and 9, which are the squares of 1, 2 and 3. But we must modify this statement because the illumination actually is as 1, $\frac{1}{4}$ and $\frac{1}{9}$, so we say that the illumination varies "inversely" as the square of the distance from the source. This is the law of inverse squares or the inverse square law, a law which we must not forget when working with light sources and illuminated surfaces.

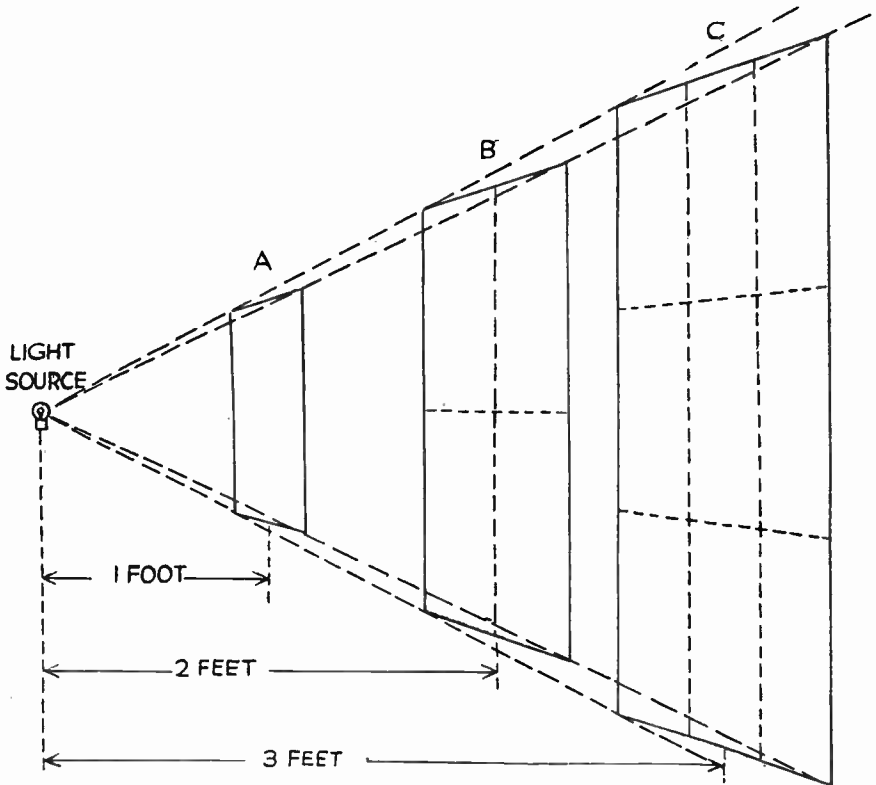

Fig. 272. The workings of the inverse square law applied to a flow of light.

FOOT-CANDLES—It was a little difficult to take about the relative illuminations of surfaces at the three distances in Fig. 272 because, while we had a unit of light flux or of luminous flux, we had no unit with which to make direct measurements of the degree of illumination. The unit of illumination commonly used when dealing with light is called the **foot-candle**.

The degree of illumination on a surface is one foot-candle when that surface receives a luminous flux of one lumen per square

foot. At A in Fig. 272 we have one lumen on one square foot of surface, so have one lumen per square foot and the illumination intensity is one foot-candle. At B we have only $\frac{1}{4}$ lumen per square foot, so the intensity of illumination is $\frac{1}{4}$ foot-candle, and at C, with $\frac{1}{9}$ lumen per square foot, the illumination is $\frac{1}{9}$ foot-candle.

The law of inverse squares applies directly to illumination intensity in foot-candles, for the number of foot-candles of illumination at two surfaces will be proportional to the inverse squares (one divided by the square) of the distances from the light source. For instance, with distances of 4 feet and 7 feet the squares are 16 and 49, so the illumination at 4 feet will be proportional to $\frac{1}{16}$ and that at 7 feet proportional to $\frac{1}{49}$. Since $\frac{1}{49}$ is about one-third of $\frac{1}{16}$, the intensity of illumination in foot-candles at 7 feet will be about one-third as much as at 4 feet. Here we have assumed that the two surfaces are lighted solely and only by the same source, and that there is no other light, such as reflected light, reaching either of them.

A 60-watt tungsten gas-filled incandescent lamp with frosted bulb produces a total luminous flux of about 760 lumens. Dividing by 12.57 shows that the flux on one square foot at one foot from the lamp is about 60 lumens were the flux to radiate uniformly in all directions. Since foot-candles are equal to lumens per square foot we would have an illumination of 60 foot-candles one foot from the lamp. Then, using the law of inverse squares, we would have at two feet an illumination $\frac{1}{4}$ as great, or 15 foot-candles, at three feet would have $\frac{1}{9}$, or about 6.7 foot-candles, and so on. We don't have to get very far from a light source to have the illumination drop off to very small values, this being one of the chief difficulties in the operation of phototubes from lamps as light sources.

Most light meters, such as those used in planning phototube installations, have dials or scales marked in foot-candles. When you use such a meter at the position where a phototube is to be placed, and it registers a certain number of foot-candles, it is really indicating the number of lumens per square foot. If you know the size of the phototube cathode or window you may change that size to square feet, divide it into the lumens per square foot (foot-candles) and you will have the number of lumens which will reach the phototube cathode. Phototube cathodes and windows vary in area from about $\frac{1}{5}$ to two square inches, so you can see that there won't be many lumens at the cathode even with a

bright light. The fact of the matter is that we seldom have lumens at all, but have only a fraction of a lumen on the cathode.

VACUUM PHOTOTUBE ACTION—The action of a phototube under operating conditions may be observed with a test apparatus such as shown by Fig. 273. Microamperes of electron flow in the phototube circuit are measured by the microammeter. The voltage divider provides adjustable voltages for the phototube and load resistor, these voltages being measured by the voltmeter. The position of the light source is adjustable, so that we may vary

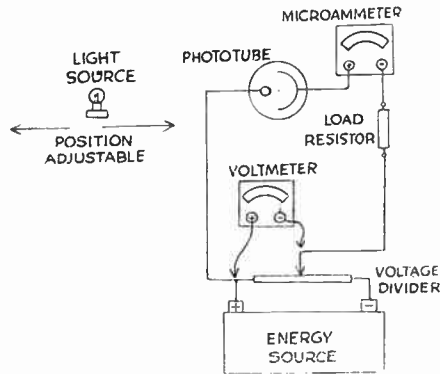

Fig. 273. A circuit for testing the relations between light flux, source voltage, electron flow, and load resistance with phototubes.

the foot-candles of illumination at the phototube and vary the lumens of light flux on its cathode or window area.

If the phototube being tested is a vacuum tube, and if the light is adjusted for 0.1 lumen on the cathode, we can gradually increase the voltage applied to the phototube and resistor while measuring the electron flow in microamperes. The results of the test may be plotted as a curve showing relations between voltage and electron flow. For any vacuum phototube the curve will have the general form of the lower one in Fig. 274. If the luminous flux is increased to 0.4 lumen and the voltage again varied, the resulting curve will be like the upper one on Fig. 274. Other flux values would give similarly shaped curves.

Note that Fig. 274 shows anode volts, not source volts. Anode volts, between anode and cathode of the phototube, will be equal

to the volts from the source (voltmeter volts in Fig. 273) minus the voltage drop in the load resistor.

One important characteristic of a vacuum phototube to be noted from these tests is that the electron flow becomes practically constant for any given light flux after the anode voltages exceeds some rather low value. With 0.1 lumen of flux the electron flow remains at 2 microamperes for all anode voltages above about 10, and with 0.4 lumen the electron flow remains at 8 microamperes for all anode voltages in excess of about 40.

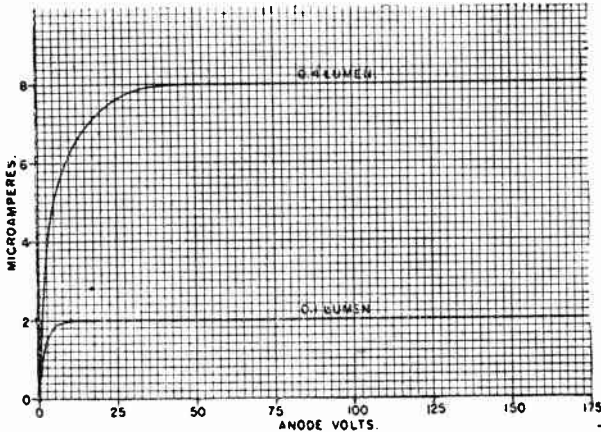

Fig. 274. How electron flow in a vacuum phototube varies with changes of anode voltage and with two values of light flux in lumens.

Another important property of vacuum phototubes which is illustrated by Fig. 274 is that electron flow is almost exactly proportional to light flux after the curves straighten out. For a flux of 0.1 lumen the electron flow is 2 microamperes, which is at the rate of 20 microamperes per lumen (because 2 divided by 0.1 equals 20). With 0.4 lumen the electron flow is 8 microamperes, again at the rate of 20 microamperes per lumen.

The number of microamperes of electron flow per lumen of flux on the cathode of a phototube is called the phototube luminous sensitivity or just the **sensitivity**. Published sensitivity ratings for the various types of phototubes ordinarily are determined with light from an incandescent lamp operated at such voltage as to give the light a desired color. The response of the phototube to other colors will vary, and the sensitivity will not be the same

as that listed. Listed sensitivities of vacuum phototubes usually are between 5 and 45 microamperes per lumen.

The fact that electron flow in the vacuum phototube is directly proportional to flux in lumens may be proven by operating such a tube with a supply voltage high enough to bring the electron flow onto the straight horizontal portions of the curves of Fig. 274, then varying the light flux while taking readings in microamperes. The resulting relations between light flux and microamperes will plot as a straight line like that of Fig. 275, where every increase of light causes an exactly proportional in-

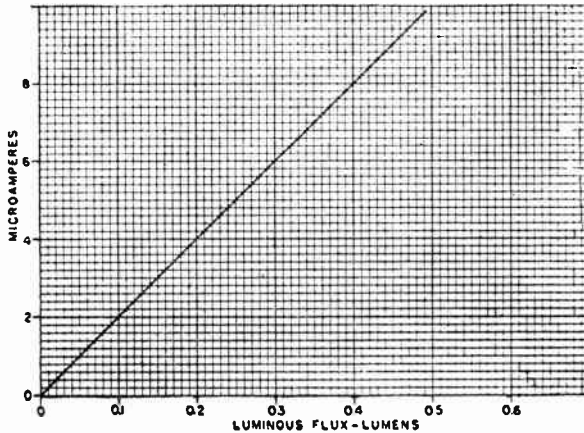

Fig. 275. The variations of electron flow in a vacuum phototube with changes of lumens of luminous flux.

crease of electron flow. If the lighted area of the cathode does not change, the electron flow will remain exactly proportional to foot-candles of illumination at the phototube.

GAS-FILLED PHOTOTUBE ACTION—If we place a gas-filled phototube in our testing apparatus and gradually increase the anode voltage while maintaining fixed values of luminous flux, the relations between voltage and electron flow will be of the general nature shown by the curves of Fig. 276.

From zero voltage up to a voltage at which the curve turns toward the horizontal the voltage and electron flow relations for the gas-filled tube are practically the same as for a vacuum phototube. But as soon as the voltage is raised a little more the electrons which collide with gas molecules inside the tube cause

ionization of the gas. The result is the same as with ionization in any other kind of gas-filled electron tube, a decided increase of electron flow which is due to release of extra electrons inside the tube. Then the curve commences to turn upward. The greater the anode voltage the greater the speed of electrons traveling from cathode to anode, the more forceful the collisions, the greater the electron flow reaching the anode, and the greater the upturn of the curve showing the relations between voltage and electron flow.

From Fig. 276 we find that gas phototube sensitivity increases rapidly with anode voltage. For example, taking the 0.4-lumen

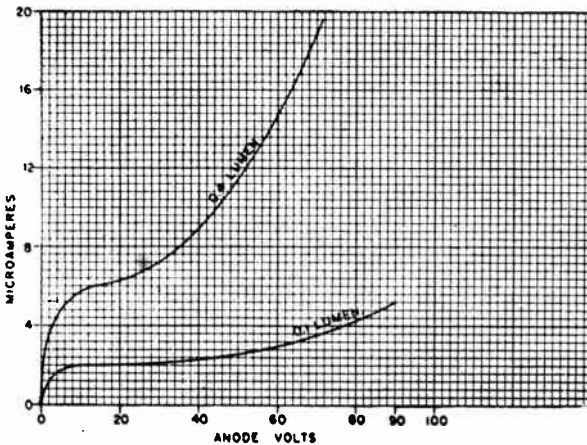

Fig. 276. How electron flow in a gas-filled phototube varies with changes of anode voltage and with two values of light flux in lumens.

curve of Fig. 276 and dividing the microamperes of electron flow at various voltages by 0.4 lumen, we find that sensitivities in microamperes per lumen are about 16 at 20 volts, about 22 at 40 volts, about 37 at 60 volts, and about 47 at 70 volts. Maximum sensitivities of gas phototubes may run from about 50 to somewhat more than 100 microamperes per lumen.

Had the tube for Fig. 276 been a vacuum type the curve for flux of 0.4 lumen would have flattened off at about 6 microamperes around 15 volts and would have continued at this same electron flow with higher voltages. But because there is ionization in the gas tube the electron flow increases to a value greater than the maximum flow just before ionization sets in. The number of times the electron flow is increased due to ionization over what it is

just before ionization is called the **gas amplification factor** of the phototube.

Maximum allowable gas amplification factors usually run between 7 and 10 times for various types of phototubes. If you use voltages or light fluxes that force the tube beyond the allowable gas amplification you are more than likely to cause a glow discharge inside the tube and permanently ruin it.

As you may see by the shape of the 0.4 lumen curve of Fig. 276 it wouldn't take much more than 70 or 80 anode volts to send the electron flow "straight up" to a value causing a luminous glow inside the tube, which means that the cathode is being so heavily bombarded by ions as to ruin the emitting surface. This is a **glow discharge**. From the fact that the 0.4 lumen curve turns upward so much more sharply than the 0.1 lumen curve it is easy to see that with much more light we will get a straight up electron flow and a glow discharge.

Once a glow discharge commences it will continue even though you shut off all the light. The only way to stop it is to immediately cut off the anode voltage if the phototube is to be saved for further use.

The chance of a glow discharge is avoided by observing four operating limits with gas phototubes. First, there is a maximum allowable source voltage or **supply voltage**, which usually is 90 volts. Second, there is a maximum allowable phototube electron flow for each type of tube, this maximum usually running anywhere from two to 20 microamperes when the cathode area being used is of some specified size. Third, the illumination or light flux must be limited to a value which will not cause excessive electron flow when using the maximum supply voltage. Fourth, when the supply voltage is above some specified value which still is less than the maximum of 90 volts, and when the electron flow will exceed some small value such as three or four microamperes, there must be a certain minimum load resistance in series with the phototube. This minimum allowable load resistance usually is between one-tenth megohm and one megohm. The voltage drop in this load resistance, with electron flow tending to go too high, will be enough to cut down on the anode voltage and prevent damage to the phototube.

Comparing the operating limits for a vacuum phototube with those just mentioned for the gas types, the vacuum tube ordinarily may be operated on supply voltages of at least 250, and as high as 500 provided there is a suitable load resistance in series. The

maximum allowable electron flow in a vacuum phototube usually is about half as much again as for an otherwise similar gas tube, and considering the lower sensitivity of the vacuum tube this means that the vacuum types may be operated at much higher illuminations or light flux values. Because there is no appreciable amount of gas in the vacuum phototube there is no real danger of causing ionization and a glow discharge with any voltages or illuminations likely to be applied.

The great advantage of the gas phototube in comparison with the vacuum type is that gas amplification produces much higher

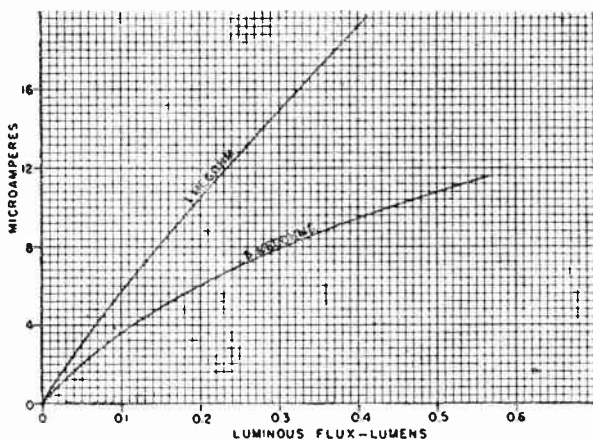

Fig. 277. Variations of electron flow in a gas-filled phototube with changes of luminous flux when two different values of load resistance are employed in the phototube circuit.

sensitivities in the gas tubes. This means that we may obtain a given change of electron flow in the gas tube with a smaller change of light flux than that needed by the vacuum type. It does not mean that we may have a greater electron flow with the gas tubes. In fact, the maximum allowable electron flow for gas tubes is less than for vacuum tubes.

Now we have one more matter to be checked with reference to the action of gas phototubes, this being the effect of a change of load resistance. Fig. 277 shows the changes of electron flow in a typical gas phototube as the light flux is changed while using a 1-megohm load resistance and then a 5-megohm resistance. Neither curve is straight, so with neither load resistance is there uniform sensitivity (microamperes divided by lumens), and

the greater load resistance causes the greater falling off in sensitivity as the light is increased. Were this gas phototube operated with no load resistance in series, the curve would bend upward and would indicate an increase of sensitivity with increase of light. With a vacuum phototube the sensitivity is not altered by changes of load resistance. The "curve" of Fig. 275 for a vacuum phototube is a straight line, and we would have this same line for all values of load resistance so long as the operating voltage keeps electron flow on the horizontal parts of the curves in Fig. 274.

Summing up the differences between actions of gas and vacuum phototubes we must note first that neither is better than the other, for each is suited to certain types of work, and which we choose depends on the work to be done. The vacuum type is preferred for high levels of illumination, the gas type for low illumination. The vacuum type is preferable where high load resistances, say 10 to 50 megohms may be used, and the gas type where the load resistance must be less than 10 megohms. The vacuum phototube has uniform sensitivity with changes of voltage, of light, and of load resistance. All these alter the sensitivity of the gas tube, but for relay operation and many other applications slight variations of sensitivity are of no importance. The advantage of the gas tube lies in the greater changes of electron flow that are obtained with small changes of light, while the advantage of the vacuum tube lies in its ability to withstand excessive voltages or excessive illumination without damage to the tube.

Chapter 18

PHOTOTUBE RELAYS

Uses of Phototube Relays — Phototube To Amplifier Connections — Relay Operation — A-c Operation of Relays — Forward and Reverse Circuits — Action With Negative and Positive Bias — Sensitivity Adjustments — Relays Using Gas Triodes — Relays With Cold-cathode Tubes — Time-delay With a Phototube — Phase-shift Control — Phototube Relay Troubles.

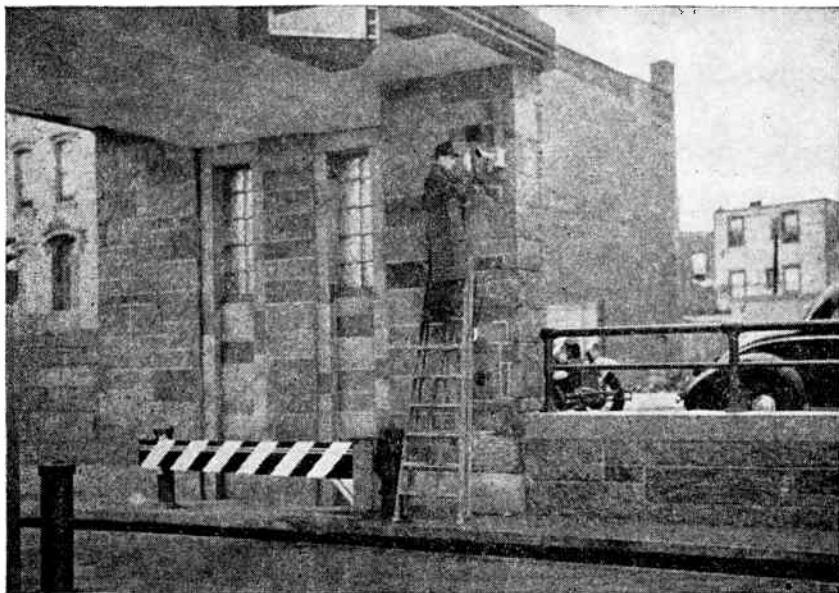

Fig. 278. A phototube-operated warning signal at a tunnel approach. A motor truck high enough to interrupt the light beam to the phototube is too high to pass through the tunnel, and the phototube causes a warning signal to be given.

With a maximum allowable electron flow of only 20 to 30 microamperes in the phototube and in the circuit directly connected to the phototube, there cannot possibly be a change of electron flow any greater than this value, even when the light changes from fully on to completely off. Such small changes of electron flow may be measured or observed only with the most delicate and sensitive apparatus, equipment that would be entirely unsuitable for industrial or commercial purposes. But, if we trans-

late the changes of electron flow into corresponding changes of voltage across a resistor in the phototube circuit, and if we then apply these changes of voltage to the grid and cathode of either a vacuum-type amplifier tube or a thyatron, we immediately have available relatively large changes of electron flow, of voltage, or of power in the plate circuit of the vacuum or thyatron amplifier.

If we wish to have measurements or comparisons of the degree of illumination and of every slight change of illumination, we will generally use a vacuum-type amplifier tube following the phototube because such tubes may be made to vary plate electron flow

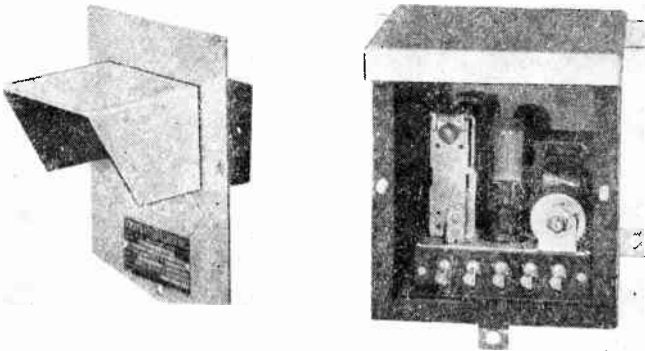

Fig. 279. A phototube, amplifier tube, and magnetic relay enclosed in a weatherproof housing for outdoor installation.

in exact accordance with grid voltage, and the grid voltage may be made to follow every slight change in the illumination applied to the phototube.

If we wish to control a power circuit, for the operation of any electrical or magnetic device or machine through a change of illumination, we ordinarily will use a relay in that power circuit. Because we wish to have the relay pull in and drop out at certain values of illumination, and because we usually need a rather large change of electron flow in the relay coil, the relay coil will frequently be connected in the plate circuit of a thyatron, with the grid circuit of the thyatron connected to the phototube. This does not mean that relays cannot be successfully operated from tubes of the vacuum type; however, many such applications would require a voltage amplifying type of vacuum tube between the power tube and the phototube. By using a shield grid thyatron

for direct operation from a phototube, we may operate fairly large relays directly from the thyatron, thus simplifying the control system. Phototube-thyatron-relay combinations are used for counting, for sorting and grading manufactured articles, for operating safety devices, for controlling the operation of conveyors, and for a great variety of other purposes.

Phototube control devices may be operated entirely from batteries as the source of electron flow and voltage, but because batteries are expensive and require periodic replacement they are used only for certain experimental and laboratory work. Phototube control and measurement apparatus may be operated from direct current obtained from rectifier tubes or from dry rectifiers, and smoothed with the help of filter circuits. Such rectified d-c power frequency is used for light measurement apparatus in which the amplifiers are vacuum-type tubes, and also in applications where the device must respond to very small changes of light, to very rapid changes of light, or to very low levels of illumination.

Most phototube relays of the moderate sensitivity and moderate speed are operated with power from a-c power and lighting lines without any rectifier tubes or dry rectifiers, such operation being made possible by the facts that the phototube is a rectifier and that either vacuum tube or thyatron amplifiers are rectifiers to the extent that all of them permit only one-way electron flow. In these "self-rectifying" controls we may use transformers to supply voltages higher or lower than line voltage, or, in some cases, we may arrange the circuit to operate directly from line voltage which can be reduced by the potential drop through resistances where necessary.

PHOTOTUBE TO AMPLIFIER CONNECTIONS—The basic arrangements for connecting a resistor, which is in series with a phototube, to the grid and cathode of either a vacuum-type or thyatron amplifier tube are shown by the diagrams in Fig. 280. We shall speak of a circuit in which light or increased light on the phototube causes plate electron flow or increased plate electron flow in the amplifier tube as a forward circuit. When light or increased light at the phototube causes amplifier plate electron flow to decrease or stop, we shall speak of such a circuit as a reverse circuit. With light on the phototube cathode, electron flow in the phototube circuit and resistor R is shown by arrows in all the diagrams. Resistor R, which is in the phototube circuit, always is connected between the grid and cathode of the amplifier tube.

In diagram A phototube electron flow makes the amplifier grid more positive with reference to its cathode, therefore it is a forward circuit, for the amplifier plate electron flow will increase with light. At B the phototube and the energy source have been turned around, so that phototube electron flow makes the amplifier grid more negative with reference to its cathode, which means a reverse circuit in which amplifier plate electron flow decreases with light. At C we have kept the phototube and energy source as at B but have reversed the connections to amplifier grid and

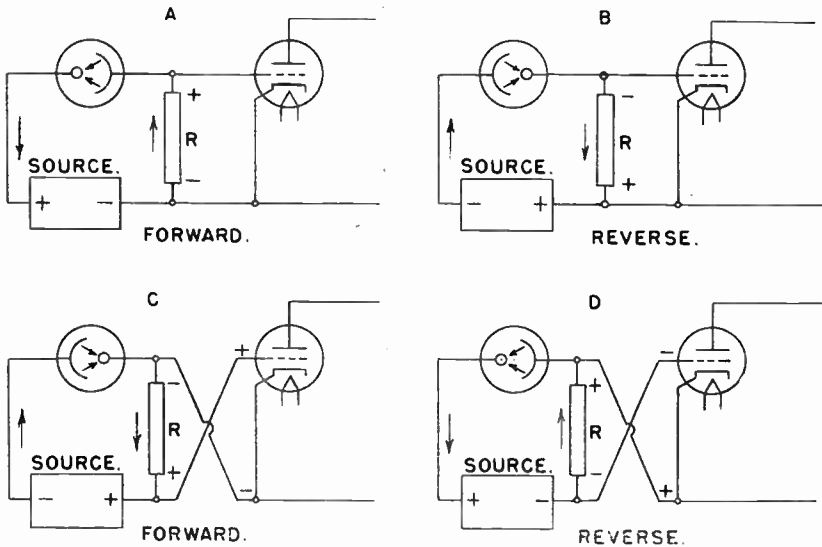

Fig. 280. Directions of electron flows in phototube circuits of the forward and reverse types when the phototube is illuminated.

cathode, thus producing a forward circuit. At D, with amplifier grid and cathode connections still reversed, we have restored the phototube and energy source to the positions of diagram A, and have a reverse circuit.

With forward circuits the cathode of the phototube is connected more or less directly to the grid of the amplifier. That is, starting from the phototube cathode and proceeding through a conductive path without going through coupling resistor R, you will come to the amplifier grid. With reverse circuits the phototube anode is connected more or less directly to the amplifier grid. The manner in which the phototube cathode or anode is connected to the amplifier grid provides one way of distinguishing between forward and reverse circuits.

RELAY OPERATION—With either a forward or a reverse circuit we may use either a normally open relay or a normally closed relay. A normally open relay is one whose load contacts remain open when there is no electron flow in its coil or when the coil electron flow is below the value required for pull-in, and whose load contacts close when the coil electron flow is above the value required for pull-in. A normally closed relay is one whose load contacts are closed when there is no electron flow in its coil or a flow too small

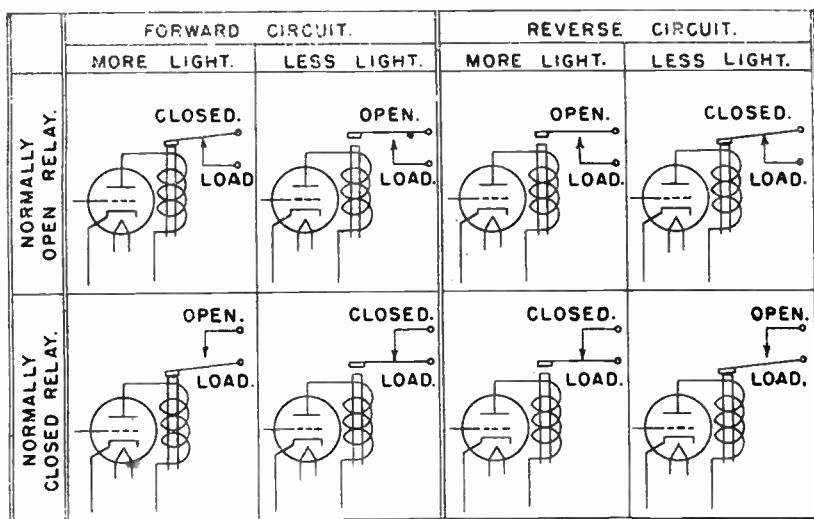

Fig. 281. How the load circuit is opened and closed with changes of light at the phototube when using normally open or normally closed relays with forward and reverse phototube circuits.

for pull-in, and whose contacts are opened when the coil electron flow causes pull-in.

Fig. 281 shows how relays close or open the contacts in the load circuit when we use forward or reverse operation with normally open and normally closed relays the coils of which are in the plate circuit of the amplifier tubes. From these diagrams it appears that we may either open or close the load circuit with either more or less light on the phototube.

Instead of using a relay with either a normally open or a normally closed contacts, we may use a double-throw relay such as represented in Fig. 282. Then, whether the load circuit is opened or closed when the relay pulls in will depend on which pair of the three relay contacts are used for the load circuit.

Whether we should choose a forward or reverse circuit will depend largely on whether the light is on or off, bright or dim, during most of the time; for during most of the operating time it is preferable that the relay coil be not energized or that it carry a minimum electron flow. If the light is bright, or is on most of the time, we might choose a reverse circuit with which the relay coil is de-energized with more light, while if the light off or dim for most of the time, we would probably use a forward circuit in which the relay coil is de-energized with less light. This is made plain by the diagrams in Fig. 281.

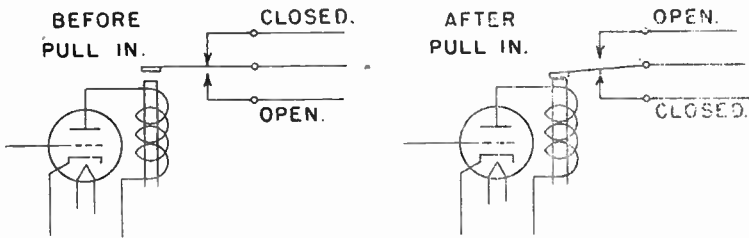

Fig. 282. The action of a double-throw magnetic relay.

A-C OPERATION OF THE PHOTOTUBE RELAY—When you read books and articles about phototube apparatus, it will seem as though there is an almost endless variety of circuit arrangements. This variety results from the use of forward or reverse circuits, of relays of one type and another, of either vacuum or gas-filled phototubes, and of either vacuum amplifiers or thyratrons. To become further acquainted with some of the fundamental principles of the most commonly employed circuits we now shall examine some simplified diagrams showing how we may obtain either a negative or a positive bias for the amplifier tube, or how we can change the grid voltage in either direction by using forward or reverse circuits. With all vacuum-type amplifier tubes and with negative-control thyratrons we will want an initial negative bias, while positive control thyratrons we will want an initial positive bias.

The arrangement of Fig. 283 provides negative grid bias for the amplifier with a forward phototube circuit. Consider the half-cycle in which the right-hand side of the a-c line is positive. The amplifier plate is positive because it is connected through the relay coil to this side of the line. The phototube anode is connected directly to this side of the line, so is positive. Electron flow is

from negative to positive through resistors R_1 (a voltage divider) and R_2 . The amplifier plate is more positive than its cathode by the potential drop through R_2 . The amplifier grid is more negative than its cathode by the potential drop from the cathode connection between R_1 and R_2 to the point on R_1 at which the slider is making contact, this bias being the negative grid voltage so long as there is no electron flow in resistor R_3 . The slider of the voltage divider R_1 is adjusted to a position that makes the amplifier grid sufficiently negative to prevent plate electron flow or limit it to a value which does not cause pull-in of the relay.

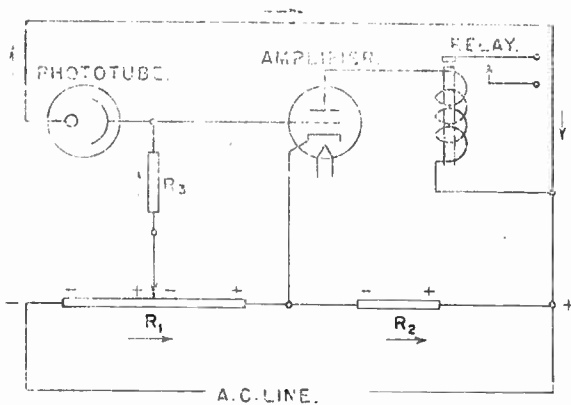

Fig. 283. A forward phototube circuit with which the amplifier tube has an initial negative bias, and with which amplifier grid voltage is made less negative (or possibly made positive) with increase of light at the phototube.

Now assume that the phototube is lighted. The phototube anode is positive with reference to its cathode because the anode is connected to the positive side of the line and the cathode is connected through R_3 to a point nearer the negative end of the line. Consequently there is electron flow in the phototube and from bottom to top of resistor R_3 . This direction of electron flow makes the upper end of R_3 and the amplifier grid more positive than the lower end and the amplifier cathode. If there is enough light on the phototube the resulting electron flow will produce a potential drop in R_3 great enough to overcome all or part of the negative grid bias, and the increase of electron flow through the amplifier and relay coil will cause the relay to pull in.

Note that electron flow for the amplifier tube and relay coil must pass from the negative side of the line through resistor R_1

to the amplifier cathode. This direction of electron flow through R_1 is such as to make the amplifier grid more negative or its cathode more positive than before, thus partially counteracting the grid-cathode voltage being produced in R_3 by phototube electron flow. The resistance of R_3 must be great enough (usually 1 to 10 megohms) so that its voltage drop cannot be completely counteracted by the change of voltage due to increased electron flow through the amplifier and R_1 .

During the a-c half-cycle in which the right-hand end of the line becomes negative and the left-hand end positive, the plate of the amplifier tube and the anode of the phototube are made nega-

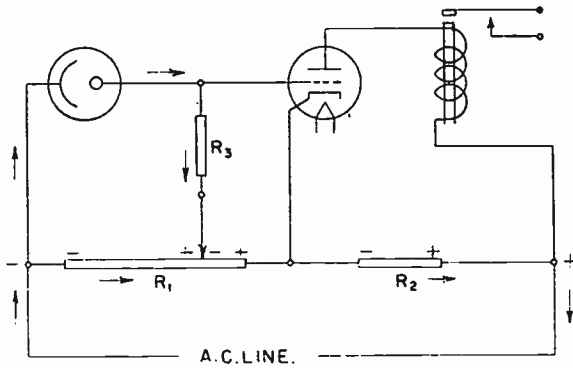

Fig. 284. A reverse phototube circuit with initial negative bias for the amplifier grid, and with the grid voltage made still more negative by increase of light at the phototube.

tive with reference to their cathodes, so there is no electron flow through either tube regardless of light on the phototube.

The circuit of Fig. 284 provides negative grid bias for the amplifier tube with a reverse phototube circuit. Note that the phototube has been turned around, its anode connected to the amplifier grid, and its cathode to the end of the a-c line which is negative during the half-cycle in which the amplifier plate is positive. Electron flow from the line through R_1 and R_2 provides a potential drop between the negative end of the line and the slider on R_1 which makes the phototube anode more positive than its cathode. The potential drop from the slider on R_1 to the amplifier cathode connection between R_1 and R_2 makes the amplifier grid negative with reference to its cathode. The potential drop across resistor R_2 is applied between the amplifier cathode

and its plate (through the relay coil) to make the plate positive with reference to the cathode.

When light reaches the phototube of Fig. 284, phototube electron flow goes through resistor R_3 from top to bottom, making the amplifier grid (connected to the top) more negative than the cathode (attached to the bottom). This negative grid voltage adds to the negative bias from part of resistor R_1 , making the grid so negative as to prevent plate electron flow or reduce it below pull-in value for the relay. With no light on the phototube there is no electron flow in R_3 and no voltage drop, so the grid then is nega-

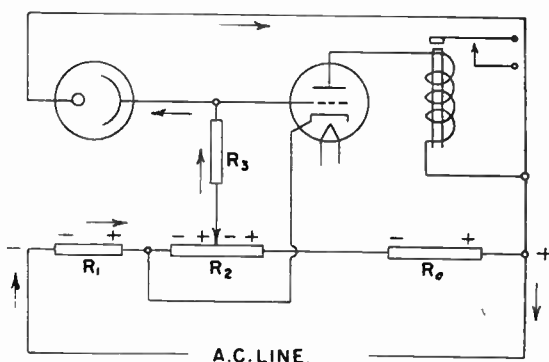

Fig. 285. A forward phototube circuit providing initial positive grid bias for the amplifier, and making the grid voltage still more positive when there is an increase of light at the phototube.

tive by only the bias voltage from part of R_1 . This lessened negative grid voltage allows amplifier plate electron flow sufficient for pull-in of the relay with no light on the phototube.

In Fig. 285 we have positive grid bias for the amplifier tube and a forward phototube circuit. The chief difference between this circuit and the one of Fig. 283 is in the connection of the amplifier cathode. With electron flow from the line through resistors R_1 , R_2 and R_4 the potential differences on the resistors are as shown by positive and negative signs. The amplifier grid connects through R_3 to a point on resistor R_2 which is positive with reference to the cathode connection at the left-hand end of R_2 . This positive bias would be less than enough to make the amplifier plate electron flow pull in the relay. With light on the phototube, phototube electron flow will be from bottom to top of R_3 , making the top and the amplifier grid still more positive, and

increasing the amplifier plate electron flow enough to pull in the relay.

In Fig. 286 the grid bias again is positive for the amplifier tube, but the phototube circuit is of the reverse type. The positive grid bias for the amplifier is obtained by shifting the cathode connection with reference to the grid connection, just as in Fig. 285, while the phototube circuit is made of the reverse type by turning the phototube around so that its anode connects to the amplifier grid, just as was done in Fig. 284. The positive bias for the amplifier is great enough to allow sufficient plate electron flow to

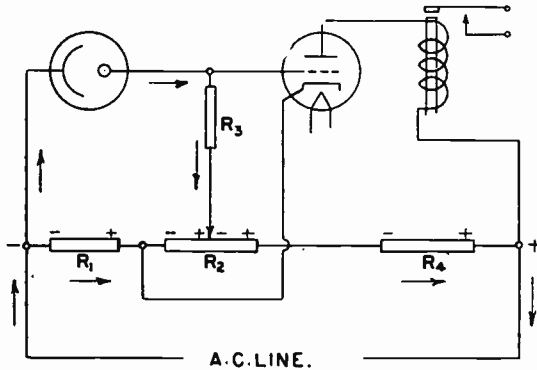

Fig. 286. A reverse phototube circuit providing initial positive grid bias for the amplifier, and making the grid less positive (or possibly making it negative) with increase of light at the phototube.

keep the relay pulled in so long as there is no great amount of electron flow and potential drop in resistor R_3 , which means little or no light on the phototube. With the phototube lighted, and phototube electron flow in R_3 from top to bottom, the top of this resistor and the amplifier grid are made more negative (or less positive) than before. The reduction or stopping of amplifier plate electron flow drops out the relay.

Any of the four circuits of Figs. 283 to 286 might be connected directly to an a-c supply line, as indicated, or, if the tubes are of types requiring higher voltages, these circuits may be connected across the secondary winding of a step-up transformer. In any case, we would usually need a filament transformer or a heater transformer for the amplifier tube. Any of these circuits might be used with a rectified d-c supply, employing resistors R_1 ,

R2 and R4 as the entire voltage divider system connected across the filter output, and using a filament or heater transformer for the amplifier tube.

Any of the circuits might be connected to a d-c power line of suitable voltage by using the heater of the amplifier tube as part of one of the line resistances. Such an arrangement is shown by Fig. 287, which otherwise is just like Fig. 283. The heater (or filament) resistance in ohms is determined by multiplying the rated volts by the rated amperes for the heater (or filament). This number of ohms would be subtracted from the resistance otherwise required in R2, because the heater or filament now becomes, in effect, a part of R2. Electron flow through resistors R1 and R2

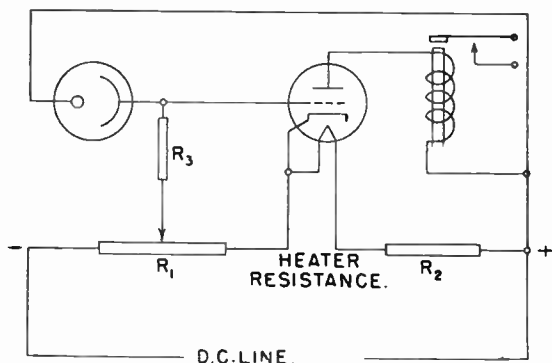

Fig. 287. For operation directly from a d-c supply line the amplifier heater or filament is included in the voltage-dropping resistance system.

now is taken as equal to the heater or filament amperes for calculating potential drops, since the heater or filament electron flow must pass through these resistors.

Potential drop in volts through a heater or filament frequently is used as a grid bias voltage. In Fig. 287 the heater resistance and potential drop do not affect the amplifier grid bias because they are not connected between the cathode and grid of this tube. Were the cathode connected to the heater on the side leading to resistor R2, the heater resistance and potential drop would be between the cathode and grid of the amplifier, and the potential drop would act as added negative grid bias. This scheme for obtaining grid bias may be used in any circuit, a-c as well as d-c, where the rather high rate of electron flow for the heater or filament may be passed through resistors forming part of the grid circuit or connected to the grid circuit.

The resistances of the several resistors in our circuits depend entirely on the types of phototube and amplifier tube used, on the electron flows required for relay pull in and drop out, and on the supply voltage. Tubes ordinarily are rated at certain maximum or peak voltages and electron flows, so we must not forget to multiply effective or r-m-s line voltages by 1.414 to find the corresponding peak voltages, or better still multiply by at least 1.5 to allow for ordinary variations. Working with rated peak or maximum tube voltages, we must multiply them by 0.707, or by 0.7, to find maximum allowable r-m-s or effective voltages. This is really important when working with gas-filled phototubes whose peak supply voltages must not exceed 90 volts, and for which the

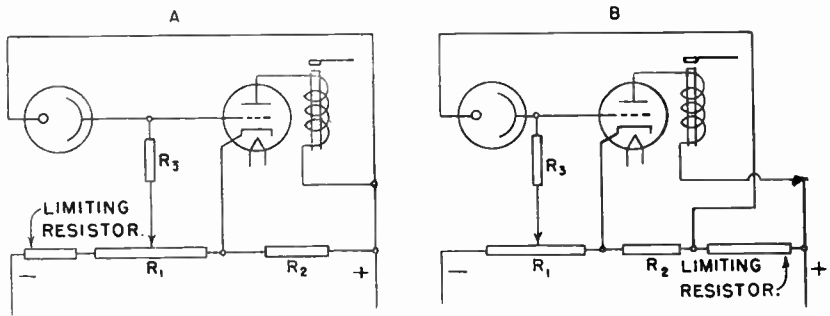

Fig. 288. When using a gas-filled phototube the maximum possible voltage applied between its cathode and anode must be limited to a safe value by using suitable voltage-dropping resistors.

corresponding maximum effective a-c voltage is 63 volts. Consequently, we must not connect a gas-filled phototube across even a 110-volt a-c line or in any circuit where the tube might possibly be subjected to a line voltage of this value.

In Fig. 283 the phototube would be across the line voltage were the slider moved all the way to the left on resistor R₁, so this circuit could not be used with a gas-filled phototube, although it would be satisfactory for a vacuum phototube. To adapt this circuit for a gas-filled phototube we may insert a voltage limiting resistor for the phototube, as in Fig. 288. In diagram A we have placed the limiting resistor between the negative side of the line and R₁. Now the voltage across the phototube cannot exceed that between the positive side of the line and the left-hand end of R₁, and will be less than the line voltage by the potential drop through the limiting resistor, whose resistance must be such as will use up the difference between the line voltage and 63 maximum a-c

volts for the phototube when there is minimum electron flow through this resistor. The objection to this arrangement is that amplifier electron flow will go through the limiting resistor, which will undesirably limit the amplifier electron flow as well as causing large changes of potential drop across this resistor.

To remove this objection we shall place the limiting resistor at the other end of the circuit, between the positive side of the line and resistor **R2**, as in diagram **B**. Now the electron flow and potential drop in this resistor are determined almost wholly by its resistance, the resistance of **R2** and **R1**, and the line voltage. Connecting the phototube between the limiting resistor and **R2** reduces the phototube voltage by the drop through the limiting resistor.

To use a gas-filled phototube in the circuit of Fig. 284 we should substitute for resistor **R1** an adjustable voltage divider and separate limiting resistor as at **A** in Fig. 288. In the circuits of Figs. 285 and 286 resistor **R1** acts as a limiting resistor for phototube voltage.

In the circuits of Figs. 283 to 286 the grid circuit of the amplifier tube includes the resistance of **R3** and part of the resistance of the adjustable voltage divider to which **R3** connects. When the amplifier is a vacuum tube of the type used in radio work, and when the plate electron flow is to be large enough to operate even a sensitive relay, the resistance in series with the grid circuit should be rather low, preferably not more than one or two megohms. Since the resistance of the adjustable voltage divider always will be very small in comparison with that of resistor **R3**, this means that the resistance of **R3** with a vacuum tube amplifier should be not much more than one or two megohms. Resistor **R3** is the one in which phototube electron flow has to develop voltage changes for control of the amplifier, and with a low resistance here we will need large changes of light and of phototube electron flow if we are to obtain large changes of amplifier grid voltage.

With the positive grid bias circuits of Figs. 285 and 286 there will be a relatively large electron flow from a vacuum-type amplifier grid down through resistor **R3** to the amplifier cathode. The potential drop thus produced across **R3** in Fig. 285 is opposite to the potential drop produced by phototube electron flow in this resistor, and in Fig. 286 it acts in the same direction as potential drop due to phototube electron flow. In either case the varying grid voltages caused by grid electron flow due to the positive bias lessens the effect of phototube electron flow and changes of light.

Consequently, these positive bias circuits are seldom satisfactory for use with vacuum types of amplifier tubes.

The positive bias circuits of Fig. 285 and 286 may be used with thyratrons which have positive control, meaning that their control grids are maintained positive with reference to their cathodes while being varied to cause or prevent breakdown. These circuits may be used also with shield grid thyratrons when the shield grid is made sufficiently negative to give the tube a positive control characteristic. The reverse phototube circuit of Fig. 286 may be used with a negative control thyatron in which the control grid is maintained negative by phototube electron flow through resistor R3 while the phototube is illuminated, and in which the grid is allowed to become slightly positive to insure breakdown when there is little or no phototube electron flow with little or no light on the phototube.

SENSITIVITY ADJUSTMENTS—All phototube relays have some adjustment by means of which the relay may be caused to pull in at various values of light on the phototube with a forward circuit, or to drop out with various values of light with a reverse circuit. This adjustment may be designed to change the plate and anode voltages, it may be made to change the value of resistance which is in series with the phototube and between grid and cathode of the amplifier, it may be connected so as to alter the grid bias of the amplifier, or it may bring about a combination of these things. While this adjustment usually is called a sensitivity adjustment, it does not alter the sensitivity of the phototube itself in all cases, but it does always alter the sensitivity of the whole apparatus to changes of light.

In Figs. 283 to 288 the adjustment is changed by moving the slider on the adjustable voltage divider R1 or R2. In each of these diagrams, moving the slider toward the right makes the amplifier grid bias less negative, or more positive. With vacuum type amplifiers this increases the plate electron flow and brings it closer to the value required for relay pull in. With thyratrons the grid voltage comes closer to the breakdown point. Movement of the slider to the left has the opposite effect. These adjustments affect the phototube anode-cathode voltage by about the same number of volts as they effect amplifier grid bias, but since the number of volts of change needed for varying the bias is small, there is but slight effect on phototube performance.

Settings of these adjustments are made by first applying line voltage or power for a long enough period to bring the tubes and

resistors to their normal or usual operating temperatures. Phototube illumination is adjusted to a value which will cause the relay to pull in with a forward circuit or drop out with a reverse circuit. Then the adjustment knob or screw is turned to the position where a slight movement either way makes the relay operate. If the relay is to pull in with the illumination being used the adjustment is left at a point where the relay has just pulled in; and if it is to drop out, the adjustment is placed where the relay has just dropped out. Then the illumination should be varied to check the action, after which it is probable that some slight alteration of the setting may be required.

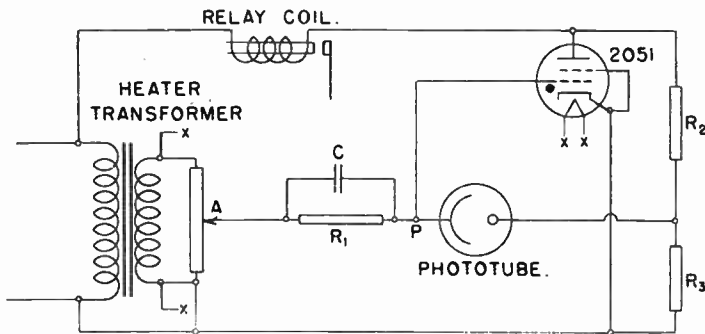

Fig. 289. A forward phototube circuit employing a type 2051 gas tetrode. The heater transformer provides 6.3 volts at 0.6 ampere. Voltage divider A is of 10,000 ohms resistance; resistor R1 is 2 megohms; R2 is 500,000 ohms; R3 is 1 megohm; and capacitor C is of 0.00025 microfarad. The relay coil has 500 ohms resistance.

PHOTOTUBE RELAYS USING GAS TETRODES—Fig. 289 shows a forward phototube relay circuit using a type 2051 gas tetrode, which is a gas-filled shield grid thyatron. The shield grid is connected directly to the cathode through a jumper on the tube socket. The secondary winding of the heater transformer is connected from points X-X to the similarly marked heater terminals of the 2051 tube socket. The plate and anode circuits of the amplifier and phototube are connected to the a-c supply line, with voltage drops supplied from resistors R2 and R3.

Considering the half-cycle during which the upper end of the a-c line is positive and the lower end negative, the plate of the 2051 tube will be positive because of its connection through the relay coil to the line, and the cathode is negative because of its connection directly to the line. Phototube voltage is supplied by

the potential drop across resistor **R3**, whose upper positive end is connected to the phototube anode and whose lower negative end is connected through adjustable voltage divider **A** and resistor **R1** to the phototube cathode.

The control grid of the gas tetrode is connected to point **P** and from there through resistor **R1** to the slider on voltage divider **A**. With no phototube electron flow there is no potential drop through **R-1**, so the control grid is at the same potential as the slider, while the cathode of the gas tetrode is at the potential of the lower end of the voltage divider, to which it is directly connected. Secondary voltage of the heater transformer, applied

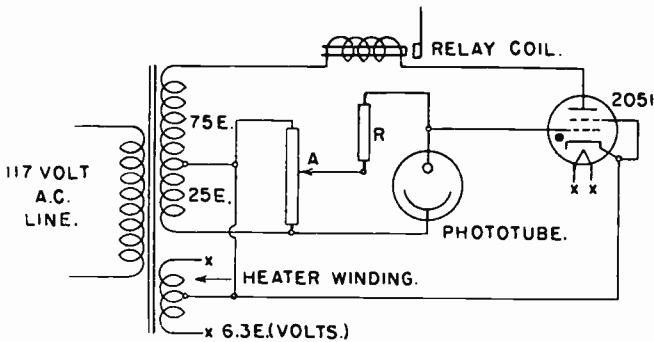

Fig. 290. A reverse phototube circuit employing a type 2051 gas tetrode. Voltage divider **A** is of 10,000 ohms resistance. Resistor **R** is 10 megohms. The relay coil has 500 ohms resistance.

across the voltage divider, is alternating at the same frequency as the primary voltage being applied between plate and cathode of the gas tetrode. Consequently, adjustment of the slider determines the degree of negative grid bias on the gas tetrode during the half-cycle in which its plate is positive, and thus provides the sensitivity adjustment for this circuit.

When the phototube is illuminated, or the illumination increased, the phototube electron flow through resistor **R1** makes the right-hand end (connected to point **P** and the gas tetrode grid) more positive, thus balancing part of the negative grid bias and causing the tube to break down and pull in the relay. The slider on voltage divider **A** should be adjusted with the phototube dark to a point just below that at which the gas tetrode breaks down. Capacitor **C** stabilizes the operation of this circuit in which all the voltages and electron flows are pulsating or alternating.

Fig. 290 shows a reverse phototube circuit employing a type 2051 gas tetrode for relay operation. The transformer has, in addition to its 6.3-volt heater winding, a tapped secondary winding providing 75 volts between plate and cathode of the 2051 tube, and 25 volts between anode and cathode of the phototube. Grid bias voltage for the gas tetrode is supplied by and adjusted by the adjustable voltage divider A much as in Fig. 289, since the grid of the tube is connected through resistor R to the slider, and its cathode is connected directly to the upper end of the divider.

With the phototube illuminated, its electron flow is downward through resistor R, making the upper end of this resistor negative and the lower end positive. The negative potential is applied to the control grid of the gas tetrode and the positive potential to its cathode through voltage divider A. With the phototube illuminated, and the grid of the gas tetrode made negative as just explained, the slider of voltage divider A is adjusted to a point just below that which allows the gas tetrode to break down. If illumination at the phototube is reduced or cut off, the reduction of phototube electron flow decreases the negative grid voltage being supplied from resistor R, and this decrease of negative grid voltage allows the gas tetrode to break down and pull in the relay. With the phototube again illuminated, the grid voltage of the gas tetrode again is made sufficiently negative to keep this tube from breaking down, and the relay drops out because the a-c voltage applied to the plate circuit falls to zero on every half-cycle.

USING A COLD-CATHODE CONTROL TUBE—Fig. 291 shows forward and reverse phototube relay circuits in which the relay control tube is the cold-cathode type OA4-G, a gas-filled triode with a starter anode marked S in the diagrams. The values of all the resistors, including the adjustable voltage divider R3, are the same for both the forward and reverse circuits, the only difference being in the connections of the phototube anode and cathode.

When the phototube of the forward circuit is illuminated, the increase of electron flow through the phototube and resistor R4 changes the potential at the slider of voltage divider R3 and at the starter anode S connected to the slider, thus causing the OA4-G tube to break down so that its plate-cathode electron flow pulls in the relay.

When there is no illumination or minimum illumination on the phototube of the reverse circuit the potential of the starter anode of the OA4-G tube is such that this tube remains conductive

and keeps the relay pulled in. When the phototube is illuminated, or more strongly illuminated, the additional phototube electron flow through resistors R_1 and R_2 changes the potential at the slider of R_3 and at the starter anode S to cause the OA4-G to cease conducting and to allow the relay to drop out. Thus the relay will pull in only when phototube illumination is decreased or cut off.

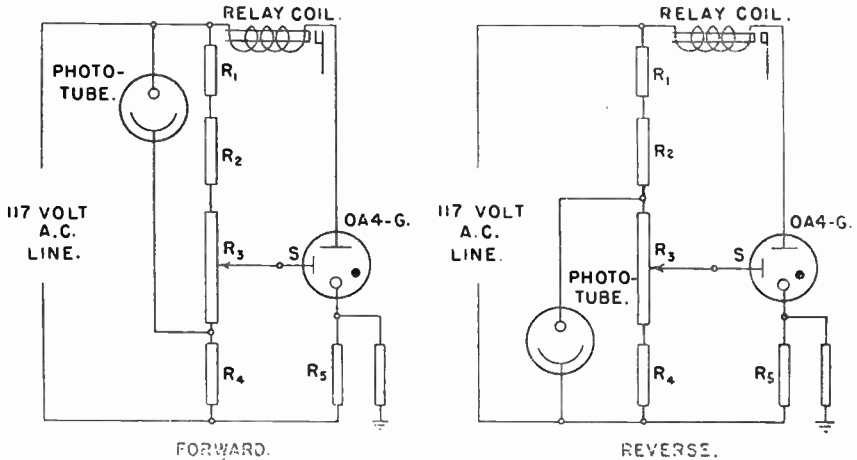

Fig. 291. Forward and reverse phototube circuits employing the OA4-G cold-cathode gas triode for relay operation. Resistor values are: $R_1 = 1$ megohm, $R_2 = 125,000$ ohms, R_3 voltage divider $= 250,000$ ohms, $R_4 = 2$ megohms, $R_5 = 250$ ohms. The relay coil has 500 ohms resistance.

TIME-DELAY WITH A PHOTOTUBE—Many circuits have been devised in which light on a phototube either begins or ends a time period whose length is determined by a capacitor and resistor as in other time-delay circuits. Diagram A of Fig. 292 shows a forward phototube circuit generally similar to that of Fig. 283 except for the addition of a capacitor C in parallel with resistor R_1 which is in the phototube circuit and between the grid and cathode of the amplifier tube.

With light on the phototube the capacitor will be charged in the direction shown, making the side connected to the amplifier grid become positive. The grid bias for the amplifier is previously made sufficiently negative to maintain the grid at a somewhat negative voltage or at zero voltage with reference to the cathode even with the capacitor charged. This slightly negative or zero grid voltage permits plate electron flow to pull in the relay. After

the light is reduced or cut off at the phototube the capacitor gradually discharges through resistor R_1 , allowing the amplifier grid to become more and more negative due to the negative bias voltage. At some certain value of negative grid voltage the amplifier plate electron flow will be reduced or stopped and the relay will drop out, but the drop-out will not occur until the end of a time delay period following reduction or cutting off of light at the phototube. The time period depends on the initial charge given the capacitor, on the values of capacitance in C and of resistance in R_1 , and on the grid voltage at which the amplifier ceases conducting or lowers its plate electron flow to the drop-out value.

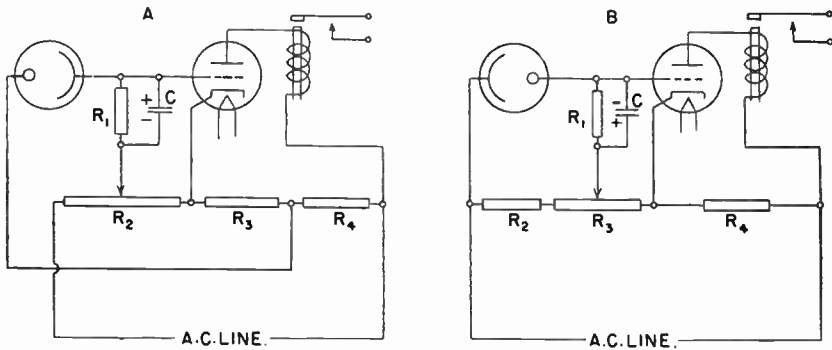

Fig. 292. The resistor in the phototube circuit and amplifier grid circuit may be used in combination with a capacitor to provide time-delay action.

Diagram B shows a reverse phototube circuit with a time-delay capacitor C in parallel with resistor R_1 . The amplifier bias is made of such value as will just keep the relay pulled in. Light on the phototube allows phototube electron flow to charge the capacitor negatively on the side connected to the amplifier grid, thus making the grid more negative than before, reducing or stopping amplifier plate electron flow, and dropping out the relay. With light cut off or reduced the capacitor will commence to discharge through R_1 , and at the end of a time period that allows the amplifier grid to become sufficiently less negative, the relay again will pull in because of the grid bias being set to cause pull-in with the capacitor discharged or practically discharged.

Although the resistor-capacitor combination of R_1 and C in Fig. 289 might appear like a time-delay arrangement, it does not act so because of the exceedingly short time constant. The time constant of a capacitor and resistor is, as you will recall, equal

to the number of microfarads multiplied by the number of megohms. In Fig. 289 we have 0.00025 microfarad and 2 megohms, so the time constant is only 0.0005 second.

PHASE-SHIFT CONTROL WITH A PHOTOTUBE—By using a phototube for all or part of the resistance in a phase-shift control for a thyatron tube we may cause the average electron flow in the thyatron plate circuit to vary with illumination on the phototube.

Fig. 293 shows how a phototube may be connected in parallel with the adjustable resistor of a resistor-capacitor phase-shift

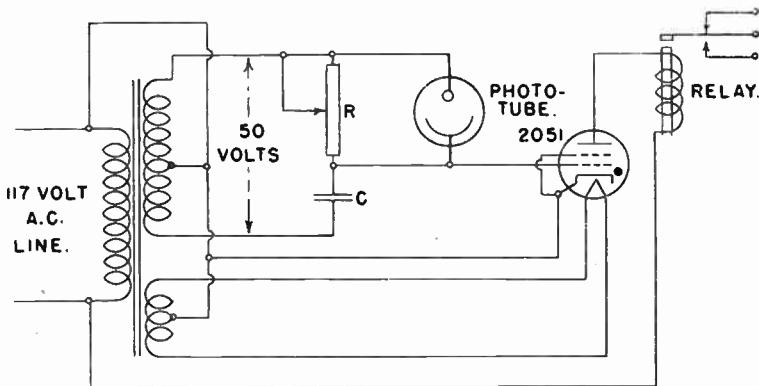

Fig. 293. A phase-shift thyatron control circuit in which average electron flow in the thyatron plate circuit is controlled by a phototube.

circuit connected to the control grid of a thyatron which here is a type 2051 gas tetrode. The general principles and the action of phase-shift control circuits were studied in an earlier chapter. There we learned that decreasing the resistance of the resistor in a resistor-capacitor phase-shifting combination will allow the thyatron to conduct during more of each half-cycle and this will increase the average plate electron flow through the thyatron.

In Fig. 293 the phototube will decrease its opposition to electron flow, or will decrease its own effective resistance, with increase of illumination. This decrease of phototube resistance, which is in parallel with phase-shift resistor R , will decrease the combined resistance of R and the phototube, and will allow an increase of average electron flow through the 2051 tube, thus pulling in the relay.

The slider on resistor R (which is a rheostat) forms the "sensitivity" adjustment whose setting determines the average electron flow in the 2051 tube, and thus determines the value of illumination at which the relay will pull in or drop out.

Fig. 294 shows a phase-shift control circuit consisting of a resistance-capacitance combination in which the resistance is that of a phototube and the capacitance is that of an adjustable capacitor whose setting forms the "sensitivity" adjustment for the control. With a resistance-capacitance phase-shift control less resistance means more average thyatron electron flow, so here again an increase of illumination and a reduction of resistance of the phototube increases the electron flow that pulls in the relay.

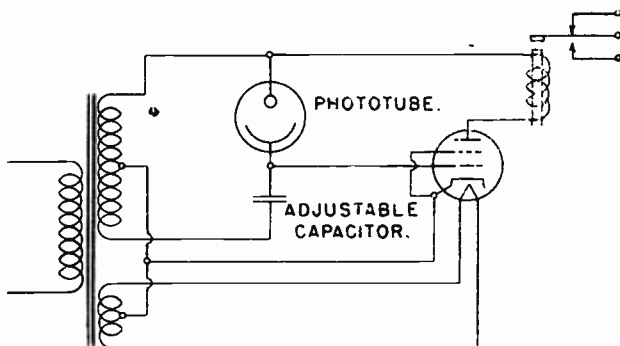

Fig. 294. A phase-shift control circuit with an adjustable capacitor for the sensitivity adjustment.

PHOTOTUBE-RELAY TROUBLES—When a phototube relay fails to operate, or operates incorrectly or erratically, we might be tempted to look first at the phototube and the amplifier or relay-operating tube. But unless subjected to abuse, a phototube may be expected to give about 5,000 hours and an amplifier about 3,000 hours of actual operation time before the cathode materials commence to fail.

Vacuum phototubes fail prematurely only if they have been subjected to high temperatures or to an excessively bright light which causes excessive emission, since they will withstand very high voltages. Gas-filled phototubes may have suffered from a glow discharge due to excessive operating voltage or to excessive illumination. Very intense light, such as direct sunlight, will damage a phototube cathode even though the tube is not in an operating circuit and has no applied voltage. By incorrect adjustment of focusing lenses at the light source or at the phototube the light

beam may be brought to such a small and intense spot on the cathode as to ruin the emitting material at that place on the cathode.

Instead of the tubes themselves being at fault it is far more likely that trouble results from defects in the wiring, the terminal connections, the capacitors, the resistors, or the electromagnetic relay. All these are considered in the chapter dealing with troubles in electronic apparatus in general.

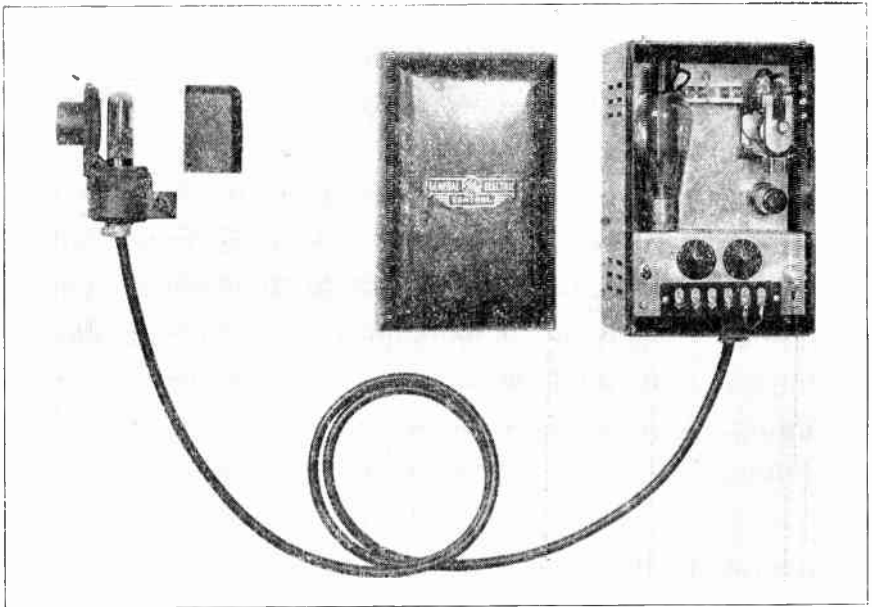

Fig. 295. A high-speed high-sensitivity phototube relay with the phototube in an extended holder and with an amplifier tube, a thyatron, and an electromagnetic relay in a separate housing.

In phototube circuits we have one kind of wiring problem that may be more serious here than in most other electronic circuits, this being the problem brought about by the exceedingly high resistance or impedance of the phototube itself, and of the parts of its circuit which also are in the amplifier grid circuit. Leakage of electron flow and voltage will be serious even though the leakage path has a resistance of millions of ohms, such as easily may occur with dust, oil, moisture, gas fumes, or insulation that is even slightly cracked. With a potential difference of only 50 volts a leakage path of ten million ohms resistance will permit flow of five microamperes, which probably is as much as the normal

electron flow in the phototube. This will reduce the effective sensitivity of the tube to a low value and will allow as much electron flow with the phototube dark as should exist with it illuminated.

Actually, the effective impedance of a phototube may be tens or hundreds of megohms, and unless the insulation and leakage resistance is at least 1,000 megohms there is danger of faulty operation in sensitive circuits. Frequent inspection and careful cleaning of sockets, glass bulbs, and all other insulating parts are absolutely necessary.

Phototube relays with extended phototube holders, such as illustrated in Fig. 295, must not be altered by substituting a longer connecting cable or a cable of poorer insulating qualities or of greater capacitance. The capacitance between wires of the cable is in parallel with the phototube, and if the phototube and amplifier grid circuit have high impedance excess capacitance will lead to trouble.

TROUBLES WITH LIGHT AND LIGHT SOURCES—With an incandescent lamp as the light source for a phototube we naturally would check to see that the lamp is not burned out or loose in its socket. These lamps should be replaced after about 3,000 hours of operation (or less time if operated at high voltage) to avoid danger of burnout at inconvenient times.

The supports of a light source must be rigid and tight, for any possible vibration may cause such a great shift of the light beam at its phototube end as to throw it completely off the phototube cathode. Focusing adjustments of lenses at the light source should be checked if the beam is not brought down to a diameter but little greater than the phototube holder at the other end. Light often is reflected from light colored surfaces or from mirrors to the phototube, so these surfaces must be positioned or aligned to throw the light toward the phototube, not in some other direction.

It is quite possible that the change of light may have become too small to operate the relay. This trouble sometimes results from dirty or unpainted reflecting surfaces, or from these surfaces receiving too much light from sources which should not affect phototube action.

Light source lenses, also covers of glass or transparent plastics, must be kept free from dirt and dust, and if badly scratched they should be replaced. Cleaning should be done with a soft cloth or brush, or with a low-pressure air stream, and these parts

should not be rubbed hard when washed. These precautions are especially necessary with easily damaged plastic materials.

The light should be checked not only at the source but also at the phototube. If lenses or covers of transparent material are used at the phototube it is advisable to check focusing and cleanliness. Make sure that the light spot has not moved partially or wholly off the cathode surface, also that lenses have not been focused to form a light spot that is too small, too bright, and too hot on the cathode.

In addition to the light which should actuate the phototube, some additional light almost always reaches the cathode. If this constant extra light is at all strong it will lessen the effect of changes of light on the phototube and may bring operation of the relay into an entirely wrong relation with the light changes which are supposed to control the operation.

Light at the phototube may have been greatly reduced by changing conditions, such as dust, smoke or steam in the space between light source and phototube, which may not have been present when the first adjustments were made. This will make it necessary to readjust the sensitivity or get rid of the light obstruction.

In general it is good practice to allow the operating light to fall on as large a cathode area as possible, then to operate with relatively low levels of illumination and with moderate voltages on the phototube. With a light beam larger than the cathode area, a shift of the beam won't have much effect. Complete cathode illumination makes for generally stable operation of the apparatus.

Chapter 19

THE CATHODE-RAY OSCILLOGRAPH

Cathode-ray Tubes — Action of the Tube — Operating Voltages and Controls — Sweep Circuit Oscillator — Oscillator, Synchronizer and Amplifier — Oscillograph Measurements — D-c Measurements.

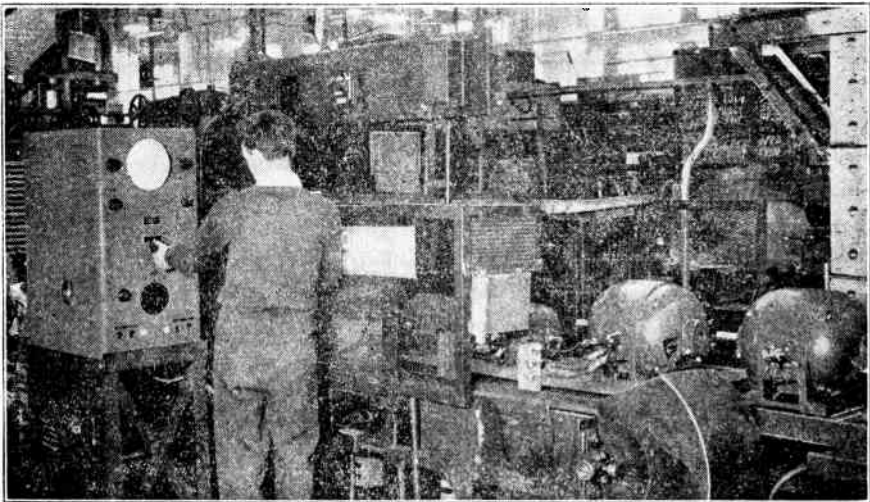

Fig. 296. Testing the insulation of windings with the help of a cathode-ray tube.

First think of all the electronic and electrical actions which we have shown by means of curves and lines on graphs. Then imagine apparatus which automatically and instantly will form such curves directly from voltages and electron flows no matter how fast they change, and will make these curves clearly visible. That kind of apparatus actually exists. It is the cathode-ray oscillograph, or oscilloscope.

The cathode-ray oscillograph makes visible the rise, fall and reversal of alternating voltages and electron flows of practically any frequency, no matter how they vary nor what the shape of their "waves", no matter whether they repeat over and over again in cycles or occur irregularly and infrequently. It will do the same for pulsating or d-c voltages and electron flows.

With the help of the cathode-ray oscillograph we may directly observe peak voltages, spark voltages, breakdown voltages, momentary changes of supply voltage, and voltage gains in amplifiers. We may observe things related to time, such as high-speed vibration, phase differences, frequencies in cycles per second, and the number of cycles in an operation. We may watch the action of electronic tubes of all types. We may measure sound waves, changes of pressure in engine cylinders and gun barrels, changes in magnetic and electrostatic fields, and do all such things practically unhindered by speeds or operating frequencies.

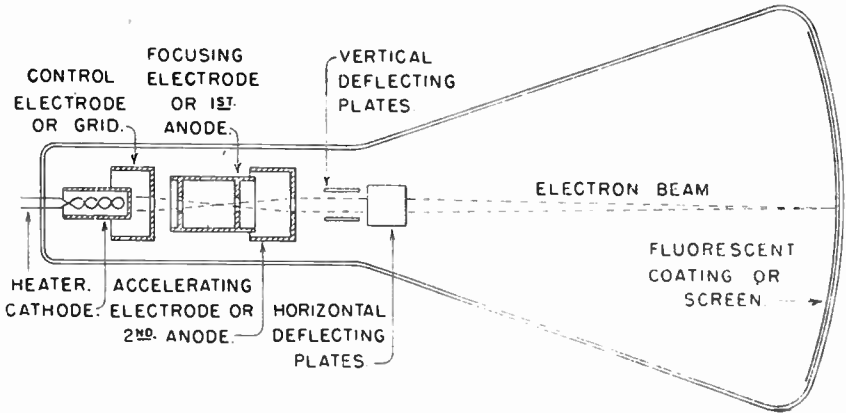

Fig. 297. The principal parts of a cathode-ray tube such as used in oscillographs.

CATHODE-RAY TUBES—The heart of the oscillograph is a cathode-ray tube. We looked at one such tube back in Fig. 19. The principal parts used in oscillograph tubes are shown by Fig. 297. Emitter materials on the end of an indirectly heated cathode supply electrons whose rate of flow away from the cathode is determined by a control electrode or grid maintained at zero or negative potential with reference to the cathode. Electrons are drawn through a hole in the grid by a focusing electrode or first anode which is maintained at from 50 to 600 volts positive with reference to the cathode, and then these electrons are given greater velocity and energy by an accelerating electrode or second anode maintained at between 250 and 2,000 volts positive with reference to the cathode.

The action of the grid and the two anodes on the electron beam is like that of two glass lenses on a light beam in that the electron beam is focused to a small point where it strikes a

fluorescent coating or screen on the inside of the large end of the tube. Where the electron beam strikes the screen there appears a small luminous spot clearly visible from the outside of the tube.

On its way from the second anode to the screen the electron beam passes between two pairs of spaced deflecting plates to which are applied potential differences. The negative electrons forming the beam are repelled by a plate which is negative and attracted by the opposite plate which is positive. Thus the potentials of the two plates in a pair bend the beam toward the positive plate and away from the negative plate.

The two pairs of plates are at right angles to each other, one pair placed horizontally and the other pair vertically. Voltages or

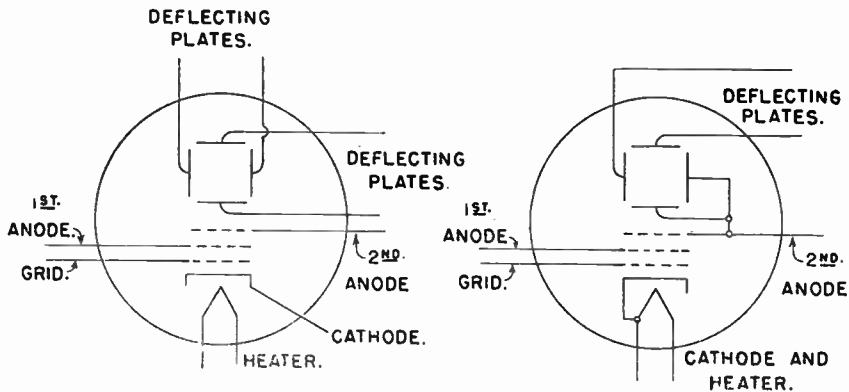

Fig. 298. Symbols showing connections to the electrodes in cathode-ray tubes.

potential differences on the horizontal plates move the electron beam up and down on the screen, while voltages on the vertical plates move the beam sideways on the screen.

As indicated by the symbols of Fig. 298, all the electrodes may be brought out to separate base pins, or, in some tubes, the deflecting plates and high-voltage anode may connect to caps on the glass envelope. In some tubes the four deflecting plates have individual terminals, while in others one plate of each pair is internally connected to the second anode. The cathode usually is internally connected to one side of the heater, but may have a separate base pin. The cathode, the grid, and the anodes considered as a unit are called the "electron gun" because they shoot the electron beam at the screen.

Most tubes used in oscillographs for industrial and commercial work have internal deflecting plates for moving the electron beam,

this being called **electrostatic deflection** because it is due to electrostatic charges. With other tubes the beam is deflected by magnetic fields from electromagnets mounted outside the neck of the envelope, this being called **magnetic deflection**.

The size of a cathode-ray tube is the nominal or approximate diameter of the circular screen on which the luminous spot may travel. Two, three and five-inch sizes are most common, although some tubes have one-inch and others have as large as nine-inch screens for oscillograph work.

ACTION OF THE CATHODE-RAY TUBE—In Fig. 299 we are applying an a-c voltage to the pair of deflecting plates which cause the electron beam to move up and down on the screen, and we are following the beam during one cycle. As the a-c voltage starts from zero there is no potential difference between the plates and the beam is at the center of the screen. As the upper plate becomes more and more positive, and the lower one negative, the beam is deflected upward and the spot travels upward on the screen to a point determined by the **peak potential difference** on the plates. Then, as the deflecting plate voltage returns to zero, the spot returns to the center of the screen, moves downward as the voltage reverses, back to zero again, and so continues up and down on the screen at a frequency corresponding to the frequency of the applied voltage.

The fluorescent material of the screen continues to glow for a fraction of a second after the electron beam passes, and as a consequence the moving spot produces a continuous vertical trace or pattern as shown at the extreme right-hand side of Fig. 299.

If we first apply a known d-c potential difference to the plates and measure the resulting vertical deflection in inches, we will be able to determine the vertical deflection in inches or fractions of an inch per volt of peak potential. We might also apply an a-c sine-wave voltage of which we know the effective or r-m-s value, and multiply that value by 1.414 to find the peak voltage and the deflection per peak volt. Then, by measuring the vertical deflection caused by an a-c voltage of unknown values we could easily determine its peak voltage. Many times in the past we have talked of measuring peak voltages, and here is such a measurement.

However, the vertical trace does not allow examining the form of the voltage wave, for, except in height, it bears little relation to the wave shown at the top of Fig. 299. To form the pattern of

a voltage wave we must move the spot horizontally at the same time it moves vertically. This is where the second pair of deflecting plates come in, for they are used to "sweep" the spot horizontally while it is moved vertically by the first pair.

For the horizontal sweep we seldom want a gradually and uniformly rising and falling voltage, instead we want what is called a saw-tooth voltage such as shown by Fig. 300. A saw-tooth voltage rises rather slowly, possibly taking $1/60$ second to go from

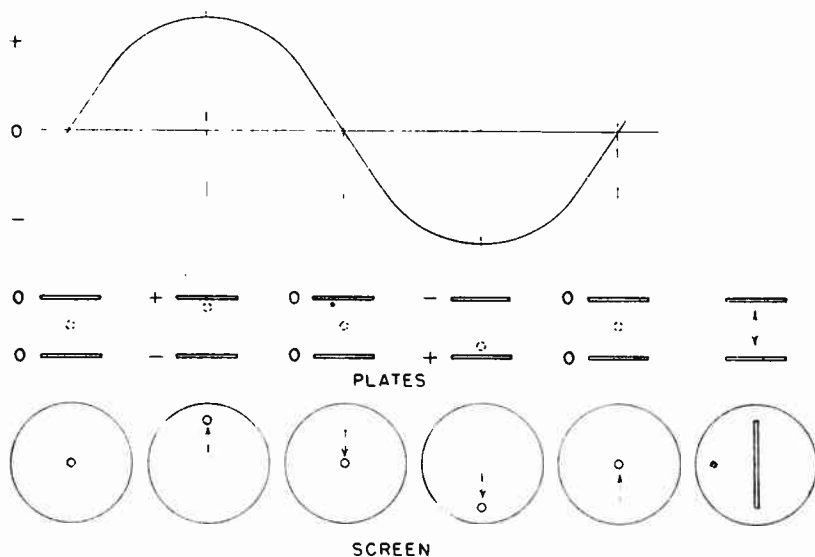

Fig. 299. An alternating voltage applied to a pair of deflecting plates causes the electron beam to move vertically and produce on the screen a luminous spot which appears as a continuous vertical line.

zero to its maximum value, then suddenly (maybe in $1/1000$ second) falls back to zero. The result is that the spot is moved slowly across the screen from left to right, then is snapped back to its starting position.

If we connect the voltage to be observed to the pair of deflecting plates that cause vertical movement of the beam, and connect the saw-tooth sweep voltage to the pair that cause horizontal movement, then adjust the frequency of the sweep voltage so that it is the same as that of the observed voltage, the combination of simultaneous vertical and horizontal travel of the spot will cause a luminous trace that looks like the wave that shows one cycle on any other kind of "graph".

The one-cycle trace or pattern is shown at A in Fig. 301. If we make the length of time for one cycle of sweep voltage twice as long as the time for one cycle of observed voltage we will show, as at B, two cycles of observed voltage on the screen for each horizontal sweep of the spot. For example, were the observed frequency 60 cycles we would use a sweep frequency of 30 cycles when watching two complete cycles of the observed frequency. By decreasing the sweep frequency we may bring more and more cycles of the observed frequency onto the screen. On the other

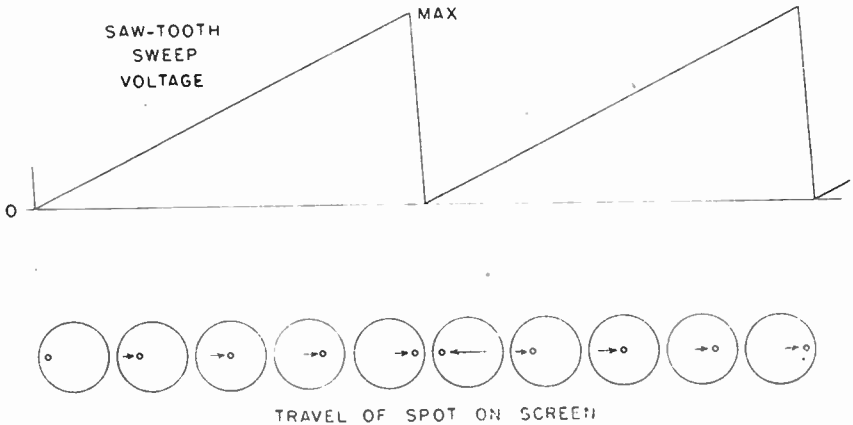

Fig. 300. A saw-tooth sweep voltage applied to a second pair of deflecting plates moves the luminous spot across the screen and then snaps it back to the starting position.

hand, by shortening the time of the sweep, or by increasing the sweep frequency, we may allow only part of a cycle of observed voltage to appear on the screen, as at C for instance, and by adjusting the phase relation between observed and sweep voltages we may examine any desired portion of the observed cycle. All these changes are easily made with convenient adjustments on a modern oscillograph.

The brightness of the spot depends on the energy delivered to the screen by the electron beam, and with a given rate of electron flow in the beam the energy depends on how long the spot remains on one area of the screen. The exceedingly rapid return trace with a saw-tooth sweep tends to diminish the spot energy and brightness so that it causes little interference with the pattern to be observed. In some oscillographs there are special means for extinguishing or blanking the beam during the return trace.

OPERATING VOLTAGES AND CONTROLS—Fig. 302 shows one of the simplest possible circuits for a cathode-ray oscillograph using a tube in which two of the deflecting plates are connected to the second anode, and in which the cathode is connected to the heater. D-c voltage and electron flow are supplied from a rectifier and filter to a series of resistors including R1 to drop the voltage between the second and first anodes, adjustable voltage divider R2 for the first anode or focusing anode, fixed resistor R3 to drop the voltage between the first anode and cathode, and adjustable voltage divider R4 for the control electrode or grid. Note that the grid always must remain negative or zero with reference to the cathode.

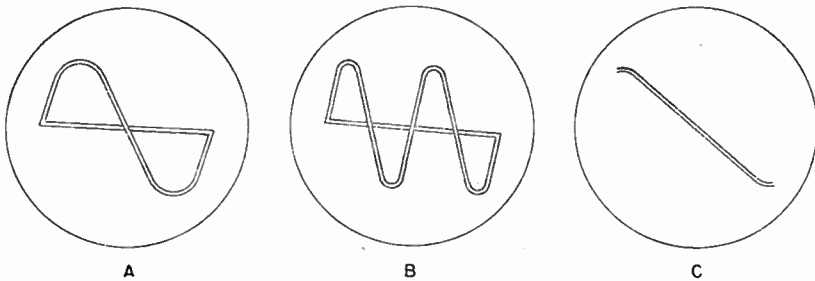

Fig. 301. One cycle, several cycles, or a portion of a cycle may be observed on the screen.

The sweep voltage and the observed voltage are applied between their respective deflecting plates and the lead for the second anode which connects to the remaining deflecting plates inside the tube. Resistors R5 and R6 prevent the accumulation of charges or potentials on the deflecting plates which might cause shifting or distortion of the trace or pattern on the screen by unbalancing the potentials on the two plates of a pair.

Making the grid less negative with reference to the cathode increases the electron flow in the beam, increases the intensity or brightness of the spot, and tends to enlarge the spot. Making the grid more negative has the opposite effects.

The spot is focused on the screen, or is made of suitably small size, by adjusting the voltage of the first anode or focusing electrode.

The voltage on the second anode is that furnished from the d-c supply. Increasing this voltage makes the spot more intense or brighter, and smaller in size, at the same time lessening the

travel of the spot on the screen (the deflection sensitivity) for given values of observed voltage and sweep voltage applied to the deflecting plates.

For measuring and comparing voltages and waveforms the oscillograph frequently is equipped with a ruled and graduated transparent scale, such as shown by Fig. 303, placed in front of the screen of the cathode-ray tube. Adjustable controls permit moving the trace or pattern up, down and sideways on the screen, so that it comes to a convenient position on the scale. These controls vary steady d-c voltages on the deflecting plates or apply

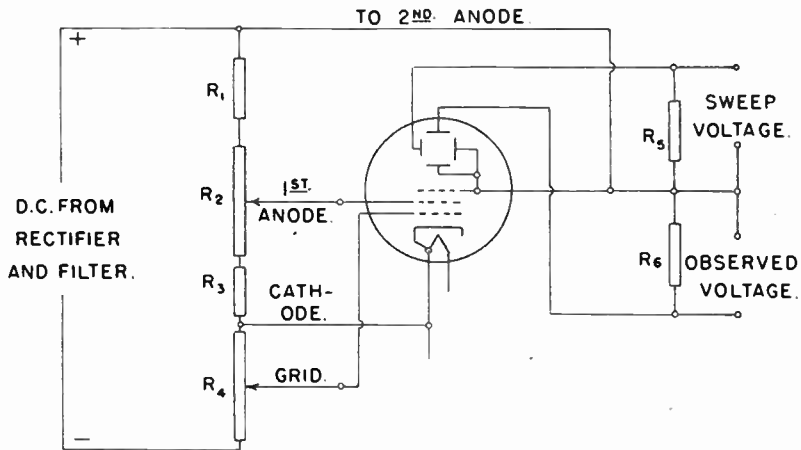

Fig. 302. How the several voltages are applied to the electrodes and deflecting plates of a cathode-ray tube.

variable a-c voltages which shift the pattern in the desired direction.

Even though the screen pattern be brought to the desired position it will more or less rapidly drift one way or the other across the screen unless the frequency of the sweep voltage is exactly synchronized to the same frequency or to some definite multiple or simple fraction of the frequency of the observed voltage. Such synchronizing may be done by coupling to the grid circuit of the sweep oscillator a voltage derived from the same source as the observed voltage and having a definite frequency relation. Sweep frequencies usually are adjustable from a minimum of around eight or ten cycles per second to a maximum of 30,000 or even 50,000, and with some types of apparatus the frequency may be lowered to a fraction of one cycle per second.

SWEEP-CIRCUIT OSCILLATOR—It is interesting to note that the saw-tooth voltage for the horizontal sweep is obtained with a thyatron tube in a circuit whose oscillating frequency is determined not by a combination of inductance and capacitance, but by the rate at which a capacitor is charged through a resistance. Fig. 304 shows the elementary principle of such an arrangement, often called a relaxation oscillator.

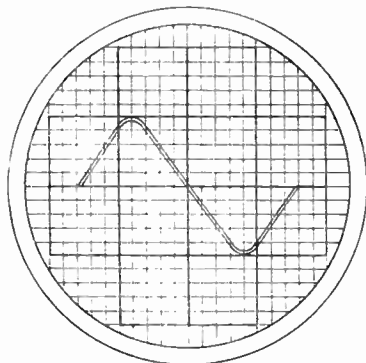

Fig. 303. A graduated scale in front of the screen places the trace or pattern on a graph for easy measurement and comparison.

Voltage and electron flow come from a rectifier and filter in a d-c supply. Resistor **R1** drops the voltage between plate and cathode, while adjustable voltage divider **R2** allows variable negative grid bias for the thyatron. The voltage between plate and cathode of the thyatron can be only the same as the voltage of capacitor **C** connected between plate and cathode. This capacitor is charged through the high resistance of **R3** until the potential difference across the capacitor plates rises to the breakdown potential of the thyatron for whatever grid voltage or bias is being applied. Then the thyatron breaks down and allows a practically instantaneous discharge of the capacitor through the thyatron, returning the capacitor potential difference nearly to zero.

The capacitor potential difference is applied to the deflecting plates which cause the horizontal sweep in the cathode-ray tube. As the capacitor voltage increases at a rate determined by electron flow through **R3** the electron beam moves at the same rate across

the screen, as shown in Fig. 300. When the capacitor discharges, the spot snaps back to its starting position. The frequency is determined by the circuit resistance and capacitance, which is made up chiefly by the high resistance of R_3 and the capacitance of C .

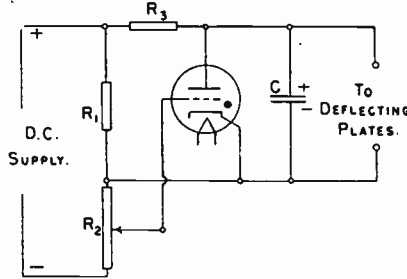

Fig. 304. A simplified circuit for a thyatron oscillator which produces a saw-tooth voltage for the sweep on the screen.

OSCILLATOR, SYNCHRONIZER, AND AMPLIFIER—The elementary circuit of Fig. 305 illustrates several principles rather generally used in supplying a sweep voltage to the horizontal deflecting plates of the cathode-ray tube. Resistor R_1 drops the d-c supply voltage from a value suitable for the vacuum-type amplifier (triode or pentode) to that for the thyatron oscillator. Resistor R_2 provides the additional voltage drop between plates and cathodes of the tubes. Resistor R_3 is the capacitor charging resistor, just as in Fig. 304, while R_4 is a limiting resistor for plate electron flow, and R_5 a limiting resistor for grid electron flow in the thyatron. Adjustable voltage divider R_6 provides grid bias connection for the thyatron, also adjustable grid-circuit coupling for a synchronizing voltage which may be from any external source to provide some desired frequency and phase relation, or which, by turning a switch, may be a 60-cycle frequency brought through a transformer from the line power supply.

Instead of the single charging capacitor we here have separate capacitors C_1 of different values which may be placed in the circuit by switch F to allow a choice of oscillator or sweep frequencies. The oscillating sweep voltages might be applied to the horizontal sweep deflecting plates through terminals A and B . However, with electron flow for capacitor charging regulated only by resistance,

it is possible to have only a small sweep voltage in relation to the d-c supply voltage if we are to preserve a uniform rise of capacitor voltage as indicated by the straight-line rise in Fig. 300.

To obtain a higher voltage for the horizontal sweep deflecting plates the output of the oscillator may be fed to the grid circuit of an amplifier tube. The portion of the oscillator voltage amplified, and the output of the amplifier to the deflecting plates, is regulated by adjustable voltage divider R7. Capacitor C3 blocks the high d-c plate voltage for the oscillator out of the amplifier grid circuit,

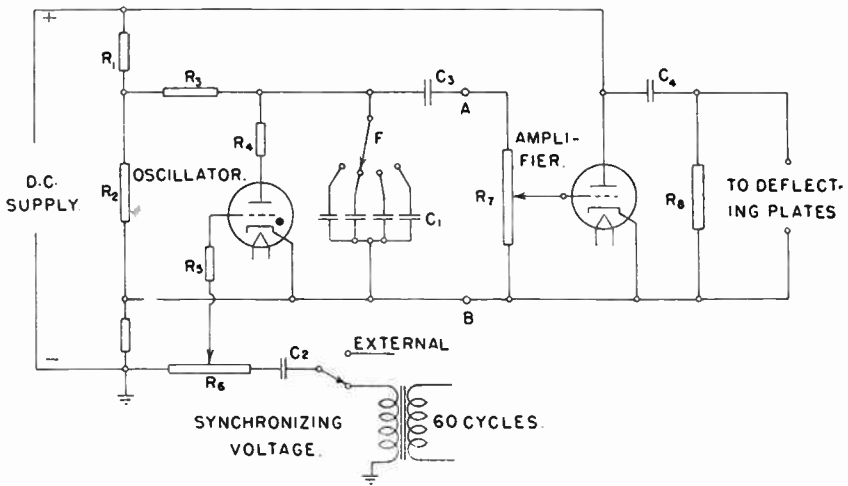

Fig. 305. An elementary circuit illustrating some of the principles employed with the saw-tooth oscillator and an amplifier for the horizontal deflecting voltage.

but allows the pulses of oscillating voltage to pass. Capacitor C4 blocks the high d-c plate voltage for the amplifier out of the deflecting plate circuit.

In Fig. 305 we have means for adjusting the sweep frequency, which may be supplemented by finer adjustments of capacitance or resistance; we have means for synchronizing the oscillator with the observed signal, and have means for adjusting the amplitude of the sweep voltage, which allows changing the width of the sweep across the screen. All these adjustments may be made with knobs or pointers on the control panel of the oscillograph, as may also the adjustments for intensity and focus of the spot and for vertical and horizontal positioning of the pattern on the screen. In addition, we ordinarily have an adjustment for the voltage gain

of another amplifier which increases the strength of a voltage to be observed and makes it great enough to produce a satisfactory height of the trace when applied to the vertical deflecting plates.

Built into the oscillograph case are the sweep circuit oscillator, the horizontal and vertical amplifiers, the rectified d-c supplies for the cathode-ray tube, the oscillator and the amplifiers, the a-c voltage supplies for supply-frequency synchronizing and for heaters of all the tubes, together with all necessary adjustable voltage dividers. External terminals will provide for connection of observed voltages through the vertical amplifier and sometimes directly to the deflecting plates, also for connections to external sweep voltages either through the horizontal amplifier or directly to the deflecting plates.

OSCILLOGRAPH MEASUREMENTS—When using an oscillograph around industrial apparatus and machinery the instrument itself should be kept as far as is convenient from parts which produce strong magnetic or electrostatic fields, this including large generators, motors, transformers, rectifiers, solenoids, plunger magnets, lifting magnets, and all similar devices. Cables and bus bars carrying large electron flows or high voltages are as bad as large electric machines. Any of these may cause deflections of the trace which will interfere with observations of voltages to be examined.

The oscillograph first should be placed in operation with a wire jumper between the vertical input terminals and with a horizontal trace formed on the screen. Then, while electrical devices which may cause interference are operating, the screen should be watched for any vertical motion in the trace with the oscillograph placed where it is proposed to use it. If the trace changes, a different location must be selected. Fluctuations of power line voltage which operates the instrument will show up in this test.

If long leads must be run from the source of observed voltage to the oscillograph, and if separate insulated wires are used, they should be twisted together to reduce pickup of interference. High-voltage low-capacitance cable is better. If small high-frequency voltages are to be observed they may be seriously altered in strength and phase by long cables or wires to the oscillograph. To avoid this an impedance transformer should be used, having very high impedance on the side connected to the voltage source

and relatively low impedance on the side connected to the cable which runs to the oscillograph.

Voltages higher than the rated maximum capacity of the oscillograph, or of the cathode-ray tube when direct connections are made, may be "attenuated" or reduced by means of a voltage divider as shown in Fig. 306. Moving the slider on R_2 away from the lower end gradually increases the voltage applied to the oscillograph, until the height of the trace on the screen is satisfactory. The resistance or impedance to the observed voltage may be increased by a resistor at R_1 . The greater the total impedance the less the observed voltage will be reduced, but high frequencies

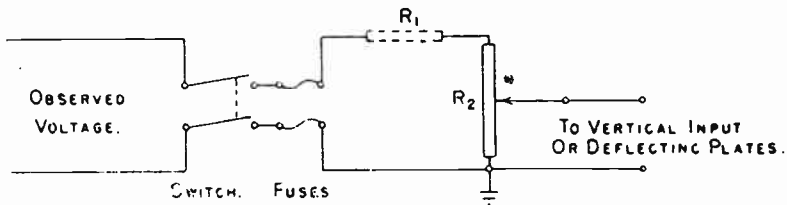

Fig. 306. A simple voltage divider for use as an attenuator of low-frequency or d-c voltages.

will be attenuated more than lower ones because of capacitances between parts of the voltage divider system. The less the impedance the less will be this "frequency discrimination".

Since electron flows in a conductor are similar in waveform to the voltages in the same conductor we may observe changes of electron flow by applying the accompanying voltage changes to the oscillograph. If the vertical input of the instrument is connected across a known resistance, and if the peak voltage is measured by the height of the pattern on the screen, the peak electron flow will be equal to the volts divided by the ohms of resistance.

A-c waveforms in circuits operating at high voltage or high rates of electron flow may be observed by using a current transformer as in Fig. 307. The normal purpose of such transformers is to allow connection of meters to the power circuit with the meter insulated from the circuit conductors by the insulation between primary and secondary of the transformer. When the circuit electron flow is that for which the transformer is rated, the standard secondary electron flow from the transformer secondary is five amperes. With the secondary terminals or "instrument" terminals connected across a resistor of five ohms or less,

and to the vertical input of the oscillograph, the voltage to the oscillograph will be proportional to electron flow in the tested circuit.

The lower diagram of Fig. 307 shows the primary of a current transformer connected in series with the lead to one side of a weld-

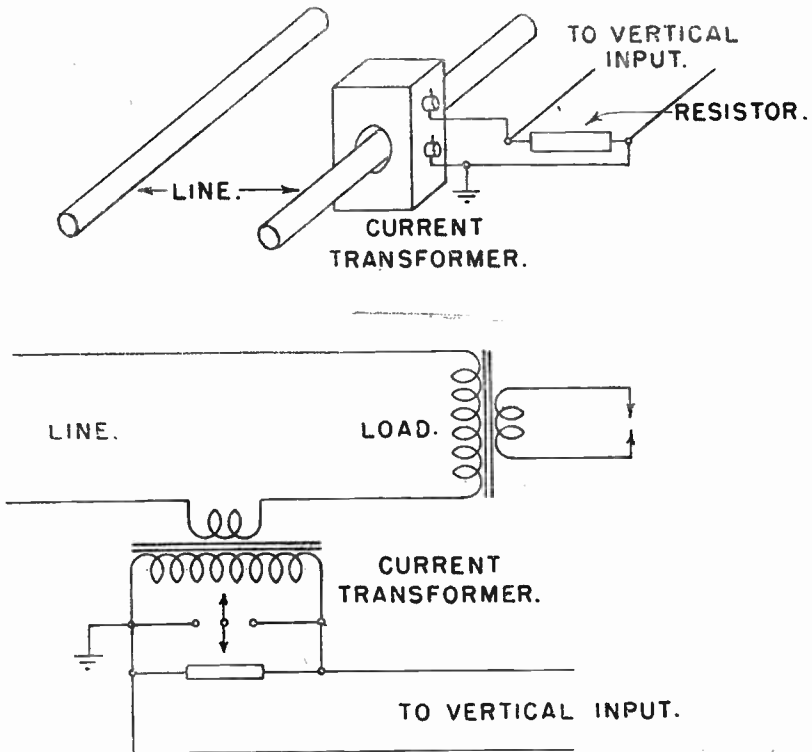

Fig. 307. Waveforms of electron flows may be observed with the help of a current transformer and resistor.

ing transformer primary. The secondary winding of the current transformer, with a resistor across it, is connected to the vertical input terminals of the oscillograph. Note that one side of this connection is grounded. Across the secondary terminals of the current transformer is a switch, indicated by a double-headed arrow, which is turned to short-circuit the line to the vertical input terminals when no readings are to be taken, and which is opened as shown when readings are to be taken on the oscillograph.

D-C MEASUREMENTS—Standard types of oscillographs are designed primarily for observation and measurement of a-c voltages and electron flows, not for d-c measurements. As shown in Fig. 305, and as you may see in most circuit diagrams for oscillographs, there are various capacitors used for coupling and for blocking high d-c voltages out of grid circuits, also capacitors in series with most of the input circuits for observed voltages and for externally produced sweep voltages. Applying a d-c voltage, either smooth or pulsating, to any of these input or amplifier circuits would merely charge the capacitors, and changes of voltage to be observed would not reach the deflecting plates of the cathode-ray tube.

For d-c voltages to affect the deflection, these voltages must be applied either directly to the deflecting plate terminals or else applied through an amplifier especially designed to handle d-c voltages. In some oscillographs there are accessible terminal connections leading directly to the deflecting plates, which makes d-c measurements quite easy. In other instruments it will be necessary to alter some of the internal connections to make the deflecting plates accessible for direct connection.

The deflection and the height or width of a pattern on the screen will, of course, be less with the observed and sweep voltages applied directly to the deflecting plates than when applied through amplifiers. Commonly used cathode-ray tubes operated at usual anode voltages require that the deflecting voltage applied directly to the plates causing vertical deflection be from 40 to 200 volts, and to the plates for horizontal deflection be from 50 to 250 volts, for each inch of deflection on the screen. The number of volts per inch of spot deflection varies with the type and size of tube. With any given tube more deflecting voltage is required per inch of spot deflection as voltages are increased on the first and second anodes.

OPERATING THE OSCILLOGRAPH—Between the cathode and first anode of the cathode-ray tube the voltage usually is from 100 to 500, and for the second anode it may be from 400 to 2,000. Such high voltages are dangerous, and every precaution must be used to prevent their reaching any part of the body. It is common practice to ground the positive side of the d-c voltage source, connected to the second anode and to the resistors going to the deflecting plates. This leaves the cathode, the heater and the grid at potentials many hundreds of volts above ground. Faults in resistors and capacitors may allow high voltages to reach parts

normally operating at low voltage. No parts of an oscillograph except the panel controls should be touched until after both sides of the line power supply have been disconnected and both terminals of high-voltage capacitors have been temporarily connected to ground to insure complete discharge.

A bright luminous spot must not be allowed to remain stationary on the screen, nor should it be allowed to remain bright if it moves so slowly as to be seen as a distinct spot rather than as a trace or line of light. A slowly moving spot should be dimmed by making the grid bias more negative with the intensity control, and a stationary spot should be made just visible, otherwise the screen will be damaged.

Chapter 20

MAINTENANCE AND TROUBLE SHOOTING FOR ELECTRONIC APPARATUS

Tube Maintenance and Testing — Mountings for Tubes and Parts — Tube Temperature and Ventilation — Forced Air Cooling — Water Cooling Methods and Devices — Test Instruments — Circuit Testing — Voltage Tests — Wiring Trouble — Faults With Resistors and Capacitors — Transformers — Rectifiers — Relay Maintenance — Fuses and Circuit Breakers — Troubles With Tubes — Special Tests.

One of the first rules of electronic maintenance is cleanliness, with special attention to all of the insulation for high voltage circuits. Dust and dirt frequently contain particles of conductive substances, and the higher the voltage the greater will be the leakage. Dust-tight or moisture-proof housings may be required where conditions are extremely severe.

After shutting off the power supply for socket-mounted tubes, cap leads may be disconnected and the tube taken out of the socket to allow cleaning of the socket surfaces and the tube base. Any tube is a rather delicate device, and must be handled with care when removed from and replaced in a socket.

If uninterrupted operation of apparatus is to be assured, spare tubes should be available. Tubes sometimes are replaced after several thousand hours of operating time, on the assumption that they are nearing the end of their expected life and might soon cause trouble if continued in use.

New tubes should be tested as soon as they are received, and before placing them in stock, for they may have been damaged during shipment. The surest test is operation for a short period in the apparatus where the tubes eventually will be installed as replacements. Many organizations make it a rule to test all their spare tubes at intervals such as three or six months.

Do not forget that mercury-vapor tubes, when first installed, should be given an extra long period of preheating in order to get all liquid mercury off the anodes and other elements. As has been mentioned many times, nearly all the industrial types of tubes require certain specified preheating periods before every operating

time. Large tubes, in which lack of sufficient preheating would allow serious damage to the emitters, usually are protected by some form of time-delay which prevents application of plate or anode voltage until after the correct preheating has taken place. Long time delays often are handled by clockwork timers.

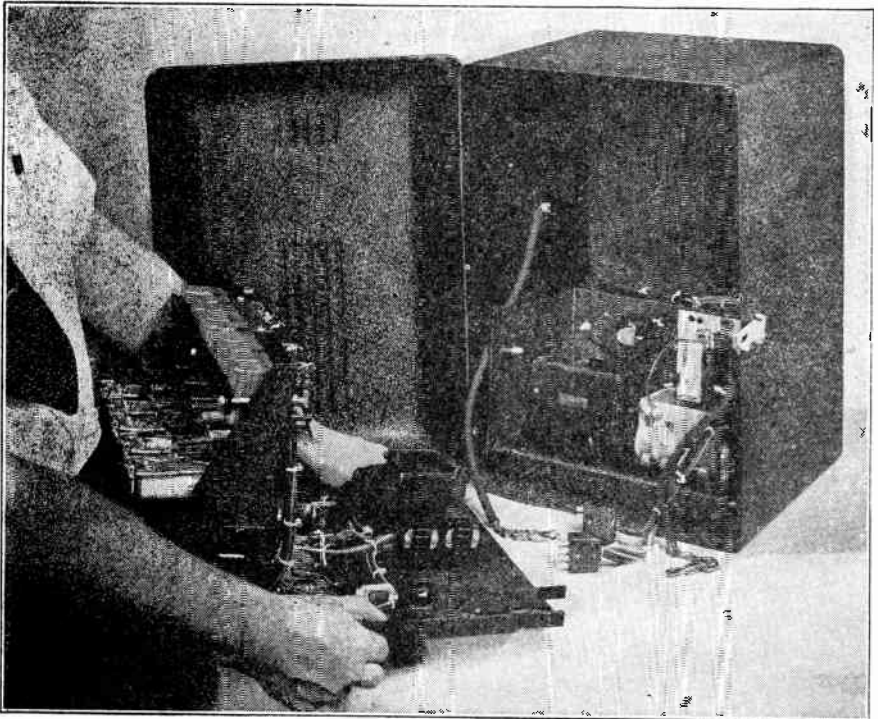

Fig. 308. The parts of well-designed electronic apparatus are easily accessible for maintenance and service. This picture shows the interior of a sequence timer.

Every time that filaments, heaters and cathodes are placed in operation, the rather sudden rise of temperature causes mechanical strains that tend to shorten the useful life of the tube. To avoid frequent heating and cooling where the power demands are intermittent, but occur at frequent intervals, tungsten filaments may be operated at about 80 percent of normal filament voltage during the "standby" periods, and coated filaments operated at full normal voltage during these periods.

When filaments are operated from a d-c supply there is more emission and a consequent heavier load at one end of the filament

than at the other end. To equalize the load, the filament leads often are reversed at certain regular intervals, say after each 500 hours of actual operating time.

TUBE MOUNTINGS—Any type of tube may be operated safely in a vertical position with the base, the filament or the cathode downward, and this is the preferred position for all tubes. Phototubes may be mounted and operated in any position that is convenient.

Many of the vacuum-type tubes may be mounted and operated horizontally or even at an angle. If the tubes are of filament types, or if they have heaters with relatively long single strands of conductor, the mounting position should be such that moderate sagging of these parts cannot bring them in contact with nearby grids or plates. Usually the position must be such that the plane of the filament or heater is vertical, as shown by Fig. 309.

Gas-filled tubes, which handle rather large amounts of power for their size, must be mounted vertically in order to allow free air circulation and cooling. It is preferable that the base or the cathode end be downward, since this is the hottest end and should receive effective cooling. This rule applies to thyratrons and phanotrons of gas-filled types.

Mercury-vapor tubes, which include many thyratrons and phanotrons, must not only be mounted vertically but must have the base or cathode downward so that condensed mercury may always collect in this end of the tubes.

Ignitrons, and all mercury-pool tubes, must be mounted vertically with the cathode end downward so that the mercury pool will remain in the correct position, and so that it is evenly distributed or is at uniform depth over the bottom of the tube.

Any sudden cooling of any spot on the glass envelope of a high-power tube will contract and probably crack or break the glass. Consequently, tubes must be well protected from drops or spray of any liquids, and there must be no possibility of any relatively cool metallic object touching the glass of the tube. With high-frequency power oscillators there is danger that the glass envelopes will be punctured unless there is good separation from all wiring and other conductors.

Grid-controlled tubes of all types, especially some thyratrons, often are operated with rather critical voltages, at which breakdown may occur with very slight variations from normal potentials. Not only the grid leads and grid circuits, but the tubes themselves, should be electrostatically shielded to prevent erratic operation if there are any nearby high-frequency or high-voltage circuits.

This rule applies also to the rectifier tubes furnishing d-c voltages for high-frequency oscillators.

As shown by Fig. 310, a tube shield is a metallic enclosure connected directly to ground through a wire conductor or securely attached to other metal which is grounded. Any kind of metal, such as aluminum, copper or brass, forms an electrostatic shield for protection against electric fields. If the protection is to be against magnetic fields the shield will usually be of iron or soft steel.

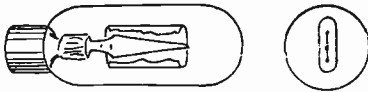

Fig. 309. Some tubes may be mounted with the plane of the filament vertical.

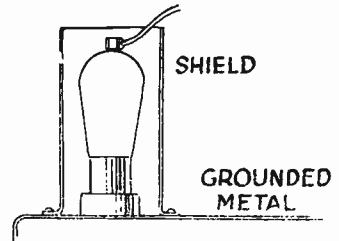

Fig. 310. Tube shields protect from electrostatic and electromagnetic fields.

Tubes should not be subjected to continued severe vibration or to sudden shocks, as such treatment may displace some of the internal elements or break the internal connections and supports where they are welded. Shock-absorbing mountings should be provided for all tubes that are subjected to excessive vibration.

The housings for tubes, relays and other electronic apparatus should be placed where the protected parts will be freely accessible for inspection, adjustment and service operations when the doors or covers of the housings or cases are opened. At the same time, the location should not be such that the housings will be in the way of operators. When making a new installation, always mount and wire the parts before inserting the tubes.

CONTROLLING THE TUBE TEMPERATURE—In all hot-cathode tubes and filament tubes there is excess heat from the emitter heating, and in all tubes there is heat developed by the power lost in electron flows inside the tube. Because emitters are damaged by excessively high temperatures, and because other elements may act as emitters if they get hot enough, most tubes must be cooled while in operation. The notable exception is the phototube, which develops practically no internal heat, and may suffer only from excessively high surrounding temperatures.

Tubes are cooled in any of three principal ways; by natural convection of air around the tube, by forced air circulation, and by forced water circulation through water jackets on the tube. Two or more of these methods may be used together.

Convection, illustrated in Fig. 311, means an upward flow of heated air due to the heated air being lighter than surrounding cooler air, which, because of its greater weight, pushes in underneath. Heat which warms the rising air is taken away from the hot object, here a tube, and thus the hot object is cooled. A chimney-like

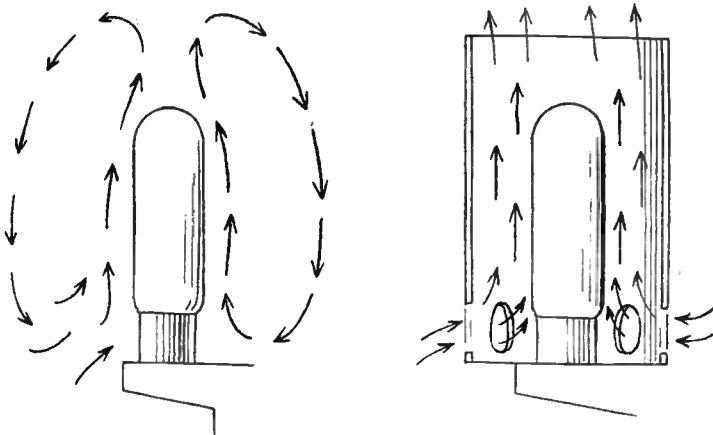

Fig. 311.—A tube is cooled by natural convection currents of air, which may be made more effective by enclosing the tube in a "chimney".

enclosure around the tube greatly increases the rapidity of air circulation by separating the upward and downward air currents, and it thus increases the rate of cooling.

The openings around the bottom of a cooling or ventilating enclosure must not become clogged with dirt and dust, nor obstructed in any other way. When the top of the enclosure has similar restricted openings, they too must be kept free of all obstruction. If air filters are used, as in dusty locations, they must be cleaned at frequent intervals.

If overheating occurs, and persists, and if it is wholly or partially overcome by operating with panels or doors opened, it is highly probable that the tube is being overloaded. Overloading occurs with operation at higher than any rated maximum voltage or electron flow. Overloading occurs also when intermittent operating periods have been made longer or closer together, or when

they exist for more of the total time than allowed for in the design of the equipment. In other words, the "duty cycle" may be too heavy for the tube.

The temperature of the air, water or any cooling medium surrounding a tube is called the ambient temperature. For each type of tube there are certain ambient temperatures which must not be exceeded. These are specified in the tube ratings. There are high temperature limits for all tubes, and for mercury-vapor types there are low limits as well. Ambient temperatures are to be measured near the cathode or filament end of the tube, or near the junction of the cathode base and the envelope of glass tubes. Water-cooled tubes and some air-cooled types may have "thermometer wells" in which the bulb of a thermometer is placed to measure ambient temperature.

When mercury-vapor tubes are in locations where ambient temperatures may become too low it is rather common practice to install resistance-type heaters or strip heaters which are turned on and off either by hand or by thermostat switches in accordance with temperature at the tube or tubes. Tube temperatures are raised also by partially closing shutters or louvers at the openings where air enters a ventilating enclosure. Sometimes there are thermostat controls for operating both the resistance heaters and the ventilating shutters.

FORCED AIR COOLING—Fig. 312 shows the details and measurements for the mounting and connections of a large tube which is cooled by a stream of air forced through an opening by a motor-driven blower. The air stream always should flow upward along the sides of the tube, as here shown, rather than being allowed to strike directly against the glass envelope anywhere along the sides.

For mercury-vapor tubes the temperature of incoming air is preferably only a little below the minimum recommended "condensed mercury" temperature for the tube. A relatively large flow of air at a moderate temperature is better than a smaller flow at much lower temperature. If the stream of cooling air is allowed to strike near the upper end of a mercury-vapor tube, mercury will be condensed in that upper end and may fall onto and between the elements to cause internal short circuits or flash backs.

With forced air cooling some provision must be made to automatically shut off the power supply for the tube and give a warning signal should the rate of air flow fall so low as to permit over-

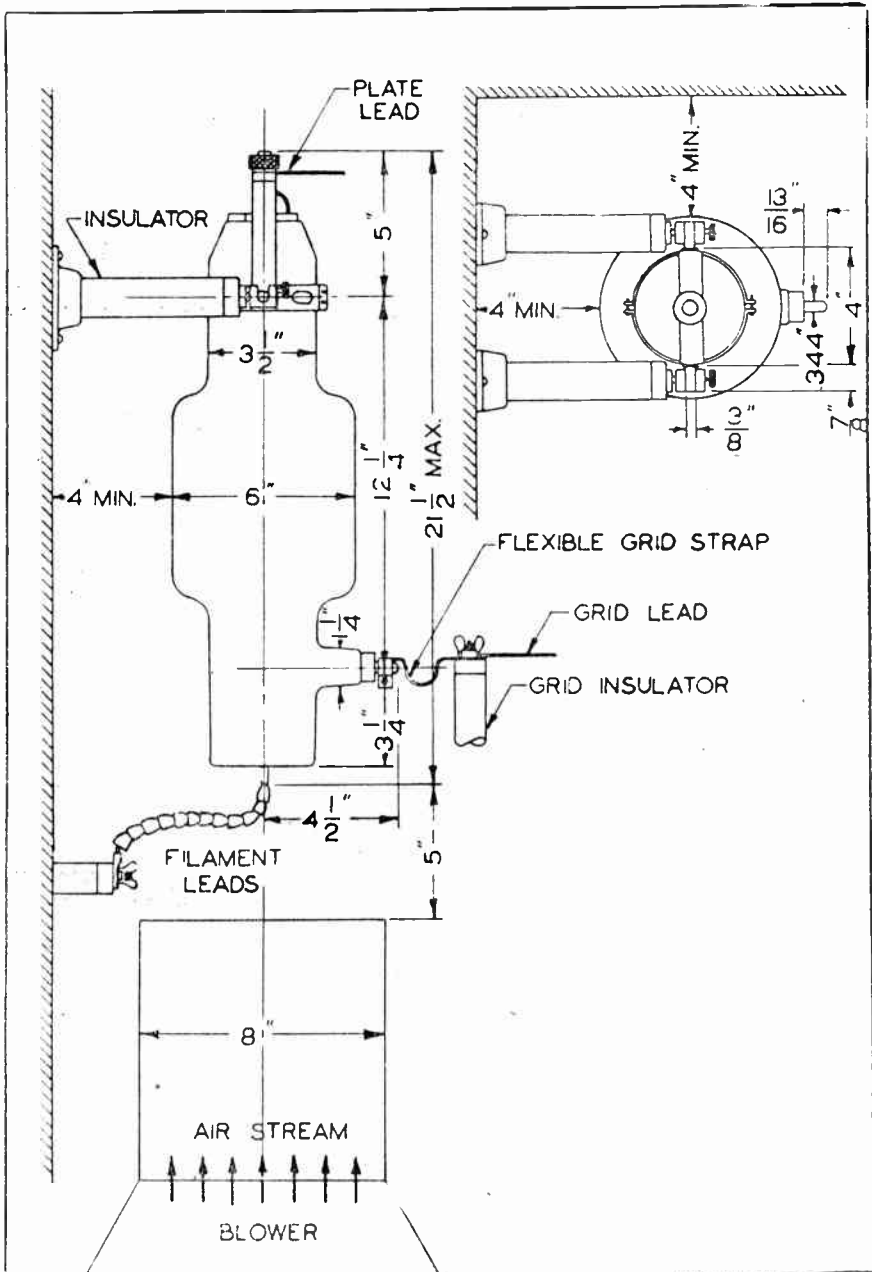

Fig. 312. The recommended mounting and cooling arrangements for an Amperex air-cooled, high-power triode. The preferred rate of air flow is from 200 to 400 cubic feet per minute.

heating. Two methods are illustrated in principle by Fig. 313. A thermostat may be mounted close to the tube, and arranged to close its contacts should the ambient temperature reach the maximum permissible. The thermostat actuates a relay which opens the power supply circuit. A small escape valve or bleeder valve may be placed on the air supply duct in such a way that the valve is held open so long as the rate of air flow and the air pressure are sufficient for cooling. Decreased flow and air pressure will allow the valve to close and operate a switch to shut off the plate and filament power for the tube before overheating occurs.

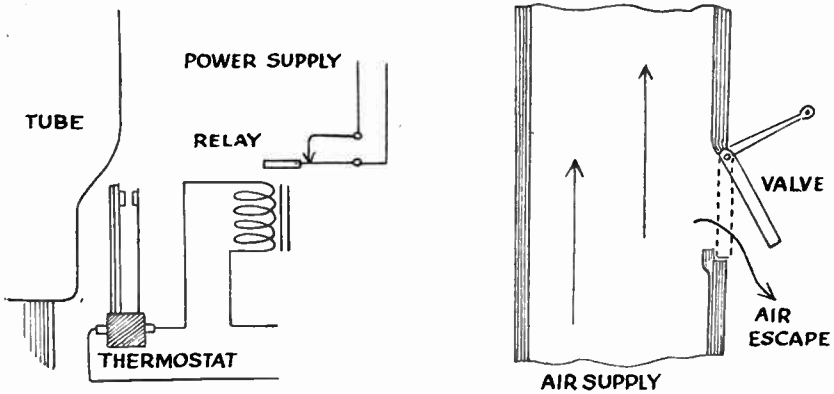

Fig. 313. Various methods are used for shutting off the power supply should tube temperature rise too high due to insufficient air circulation.

WATER COOLING—The relations of the principal parts used in typical water cooling systems are illustrated by Fig. 314. Water which is under pressure from a suitable source, usually a public main, flows from the inlet connection through valves to the water jackets of the tubes, upward through each jacket, then to the outlet.

If the power load on the tubes is reasonably constant, so that there is not much variation in the quantity of heat to be removed, the simple two-valve arrangement shown at the left-hand side of Fig. 314 may be used between the inlet connection and the tube jackets. Here the flow regulating valve is adjusted to allow somewhat more than the required rate of water flow in gallons per minute, and this setting is made permanent by clamping the valve, removing the handle, or otherwise making a change difficult. Then the shutoff valve is turned all the way on or all the way off when the equipment is either placed in operation or shut down.

For variable power loads and correspondingly different quantities of excess heat to be removed, we may use between the inlet and the jackets, as shown by the larger diagram, a valve whose opening is regulated by action of a thermostat in the outlet line. When the outlet water becomes too warm, the thermostat opens its valve farther, and as the water cools the valve is partially closed. In parallel with the thermostat valve is a bypass valve adjusted to permit a certain minimum rate of water flow.

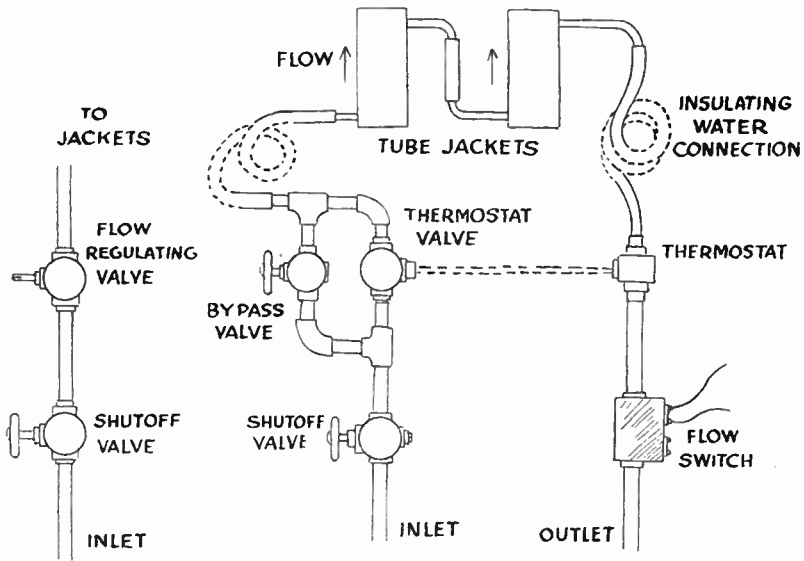

Fig. 314. The valves and connections used in typical water-cooling systems for power tubes.

The tube jackets are insulated from the metallic piping by coiled lengths of rubber hose or else by composition or ceramic insulators through which are water passages of considerable length. All of the piping and connections must be laid out and installed in such manner that there will be no air traps at any points. An air trap, or an air lock, may form wherever the piping rises and drops again to form an upward loop or bend in which air tends to remain except with very high rates of water flow.

Water which has been used for cooling may later be used for any other process work, since it will not have been made impure by passage through the cooling system. Water from the cooling system outlet pipe is preferably discharged into an open funnel or basin where continued flow is easily seen, and failure quickly

noted, and with which it will be impossible to have the flow impeded or stopped by obstructions such as might occur in any completely closed drain pipe.

Cooling is sometimes effected with re-circulating water by a system similar to that used for an automobile engine, with a radiator and pump connected in series with the tube jackets, and a radiator fan driven from the motor that operates the pump.

FLOW SWITCH—The maximum allowable temperature of water coming from the hottest tube jacket varies with the type and rating of the tube, usually being somewhere between 40 and 60 degrees centigrade or between 100 and 140 degrees Fahrenheit. The rate of flow may be regulated to maintain temperatures anywhere below the maximum, but, of course, not below the minimum for mercury-vapor tubes.

Various styles of flow switches or flow relays are installed in the water outlet connection, close to the tubes. These switches or relays shut off the power supply for the tubes in case the outlet water temperature becomes too high for any such reason as decreased rate of flow, high inlet temperature, or stoppage of the flow.

The elementary principle, but not the construction, of one kind of flow switch is illustrated by Fig. 315. In close contact with the water outlet pipe is a metallic block containing a heater wire connected to an a-c supply through normally closed contacts on a thermostat. The thermostat blade or disc is in contact with the heated block. So long as the temperature of water in the outlet pipe is low enough to keep the temperature of the heater block and thermostat below a certain level, in spite of the effect of the heater wire, the thermostat allows its contacts to remain closed. Excessive water temperature due to excessive load or partial or complete failure of the water supply causes the thermostat to open its contacts. The second set of normally closed contacts, when thus opened, causes some of the control circuits to cut off the power supply for the tubes.

Opening of the thermostat contacts which are in the heater circuit allows the heater wire and its block to cool, and allows the thermostat contacts to re-close. If water temperature has dropped to a satisfactory value the power supply will be re-connected to the tubes and the apparatus will go on operating, but if the water temperature still is high the thermostat contacts will not remain closed and operation will not be resumed. The time required for the thermostat to act after there is a change of temperature pre-

vents the equipment from being turned on and off with every slight change in flow rate or water temperature.

Other types of "thermal" flow switches contain small transformers whose large low-voltage secondary electron flow heats a portion of the water pipe and the thermostat. Still other designs do not operate directly from changes of temperature, but operate in accordance with water pressures which, of course, vary with the rate of flow.

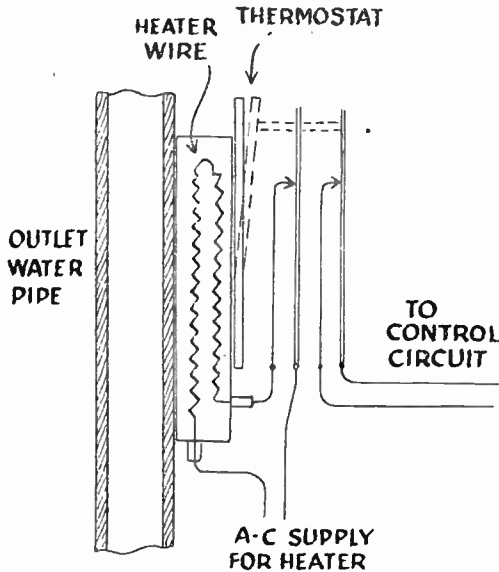

Fig. 315. The operating principle of one style of flow switch in which flow of cooling water tends to lower the temperature of a thermostat which is being heated by a resistance wire.

TUBE TROUBLES—If a tube has operated satisfactorily when first installed, and later fails to perform as it should, the probability is that the cathode surface is no longer able to furnish enough electron emission when the applied voltages are normal. Cathode failure may be due to long service, to overloading with excessive plate electron flow, or to damage from a heating supply voltage that is either too high or too low. Whatever the cause of the failure, nothing can be done about it in the tube that has failed, and the remedy is replacement with another tube.

Since spare tubes should be on hand for any industrial or commercial installation, the simplest and surest test for a defective tube is to replace the suspected one with another of the same type,

known to be good, and note whether operation improves. This method of test might be inconclusive should two or more tubes be defective and should replacement be made of only one tube at a time.

When the action of one tube depends directly on that of one particular other tube, as in the case of an ignitron and its firing thyatron, the two associated tubes should be replaced at the same time. If operation then becomes satisfactory, the replacements can be tried one at a time.

Where two tubes operate in parallel it often is possible to test each one by temporarily removing the anode connection from the other tube while the power is shut off, carefully insulating the disconnected lead, then operating the one tube. Comparing the operation with each of the tubes, or noting their relative electron flows will show up one that is defective.

A check sometimes may be made by interchanging two tubes of the same type and size, then noting whether faulty action is transferred to a different part of the apparatus. It is not an infrequent fault to have two tubes of different types, but of similar base construction, interchanged in their sockets.

MERCURY - VAPOR TUBES — When mercury-vapor tubes are in operation their envelopes are partially or almost wholly filled with a distinctive blue or blue-green glow which remains practically constant in intensity and color during normal operation at steady load. Even with the steel jacketed ignitrons this characteristic glow may be seen through the glass insulating support around the anode. In tubes used for grid rectification there will be a small glow in the region of the cathode.

Having become familiar with the appearance of the internal glow that accompanies normal operation, it is quite easy to detect changes that indicate trouble. A decided change of color may indicate that some foreign gas or vapor has entered the tube, either through a defective envelope or by being forced out of the internal



Fig. 316. A welding ignitron WL-652 rated for a maximum demand of 600 kilovolt-amperes.

elements. Irregular flashing or flaring may indicate that the tube itself breaks down only with abnormally high voltage or that a controlled associated tube breaks down or starts with difficulty.

IGNITRON TESTS—Overloading or overheating causes an ignitron to become hard starting sooner than it would in normal service. Starting time becomes longer and longer with decrease of voltage drop across the ignitor, and the decrease of voltage drop accompanies a decrease of resistance measured through the ignitor to the cathode.

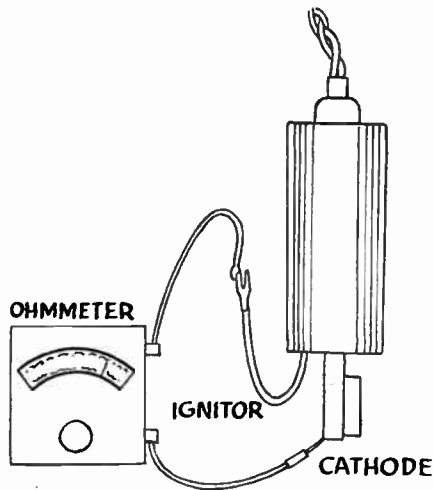

Fig. 317. Using an ohmmeter to check the ignitor resistance of an ignitron.

Ignitor-cathode resistance may be measured with an ohmmeter as illustrated in Fig. 317. The General Electric Company gives instructions as follows: With the power supply turned off the tube is allowed to cool to room temperature or to the temperature of the cooling water. With the tube in its normal vertical operating position the ignitor lead is disconnected, and the resistance is measured with the ohmmeter between the ignitor lead and the tube cathode connection. If the resistance is less than 5 ohms or more than 150 ohms the ignitron, and possibly its firing tube as well, should be replaced. With the ohmmeter connected, the ignition should be tapped. There should be no intermittent readings of either zero resistance or infinite resistance on the ohmmeter.

By using a high-voltage induction spark coil, an ignitron may be tested for the presence inside the envelope of foreign gases, such as might enter through an air leak or be released inside the tube. The General Electric Company gives the following procedure for testing for gas by use of a coil capable of jumping a spark from a half to three-quarters of an inch in open air. First, disconnect the anode terminal or lead of the ignitron and bend it so that the end comes to within one inch of the outside of the steel jacket of the tube. Touch the coil tip to the anode cable. There should be no sparks, and no pink or orange glow, inside the tube. Now press the coil tip against the anode lead to lessen the gap between the anode terminal and the jacket of the ignitron. A spark should jump across this gap before the space is reduced to as little as $3/16$ inch.

TESTING INSTRUMENTS—Various types of meters are used for the direct measurement and indication of a-c and d-c voltages, electron flows, resistances, and powers. The instrument generally used for measurement of d-c electron flows and voltages is the permanent-magnet moving-coil meter whose principle is illustrated in Fig. 318. A small lightweight coil of wire is mounted on bearings so that it may rotate through part of a turn in an air gap between the north and south poles of a permanent magnet. The coil frame carries the indicating pointer. Rotation is restrained by small hairsprings. The magnetic field produced by electron flow in the coil reacts with the field of the permanent magnet to rotate the coil and move the pointer proportionately to the rate of electron flow.

Because the field of the permanent magnet is constant and always acts in the same direction, the coil electron flow must always act in one direction if the pointer is to indicate the rate of flow. Alternating electron flow makes the coil and pointer try to move in opposite directions at the alternating frequency, resulting in nothing but vibration of the pointer. Consequently, the permanent-magnet moving-coil instrument is suitable only for d-c electron flows or voltages.

The moving coil itself is designed to carry only a few milliamperes or sometimes only micromperes of electron flow. When this style of meter is used for voltage measurements the coil electron flow is limited by a voltmeter multiplier resistor in series with the coil, as shown by Fig. 319. For measuring electron flows greater than the capacity of the moving coil we use a low-resistance ammeter shunt resistor in parallel with the moving coil, as in Fig. 319. Then most of the electron flow goes through the shunt and only

a small, but proportional, amount through the meter coil. For low voltages and small electron flows the multiplier or the shunt may be mounted inside the meter case, otherwise they are outside the case.

For measuring voltages, the meter with its multiplier is connected between the positive and negative points whose potential difference is to be measured, or is connected "across the line". For measurement of electron flows the meter with a self-contained shunt, or the external shunt for a separate meter, is connected

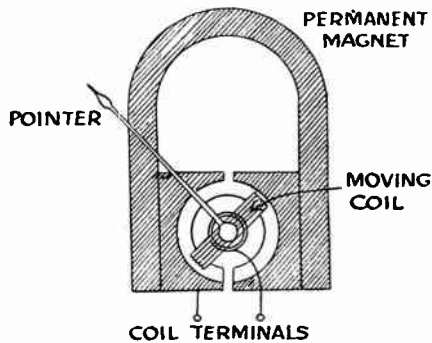

Fig. 318. The principal parts of the permanent - magnet moving - coil instrument as used for measurement of voltage or electron flow.

in series with the circuit or line whose flow is to be measured. This means that the line must be opened for insertion of the meter or the shunt.

There are two principal classes of meters for measurement of a-c voltages and electron flows, moving iron types and dynamometer types. In one class of moving iron meters, called repulsion types, one stationary and one movable iron vane are magnetized by the field of a coil carrying the measured a-c electron flow. The similar magnetic poles on the vanes causes repulsion of the movable one to which is attached the pointer. In the inclined coil moving-iron meter an iron vane suspended within a coil carrying the a-c electron flow moves to align itself with the field of the coil, and in doing so moves the pointer attached to the vane. In these meters the magnetization of the iron vanes reverses with reversal of the field of the coil, so the pointer is always moved in the same direction.

In dynamometer instruments, whose principle is shown in Fig. 320, there is no iron but there are two windings or coils, one stationary and one movable. Reaction between the fields of the two windings causes rotation of the movable one, to which is attached the indicating pointer. Since the a-c fields reverse simultaneously in the two windings the turning force always is on the one direction. Dynamometer instruments are used not only for a-c measurements but also for either smooth or pulsating d-c electron flows or voltages.

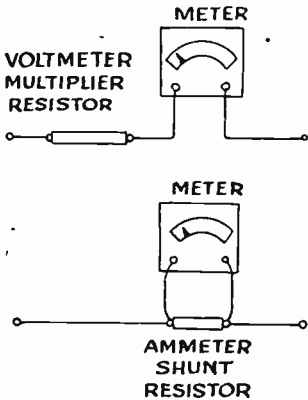

Fig. 319. For voltage measurements a high resistance is used in series, and for electron flow measurements a low resistance is used in parallel with the coil movement.

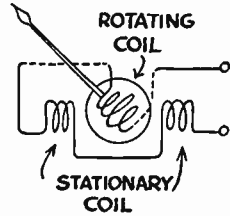

Fig. 320. The dynamometer instrument uses two coils, neither of which has an iron core.

The dynamometer instrument may be adapted for measurement of power in watts as shown by Fig. 321. Power in watts is proportional to the voltage and the rate of electron flow. The stationary windings, now called the current coils, are connected in series with one side of the line, between the supply and the load. Thus these windings are affected by the rate of electron flow. The movable coil, now called the voltage coil, is connected across the two sides of the line, so that this coil is affected by the voltage. This instrument is a wattmeter.

For measurements of high voltages the moving iron and dynamometer instruments have the disadvantage of rather low internal resistances. Connecting a low-resistance instrument across a high-voltage line in which the electron flow is small permits such a large

electron flow through the instrument as to materially change both electron flow and voltage in the line. This difficulty is avoided with rectifier meters as shown in Fig. 322. A bridge rectifier consisting of copper-oxide or other dry rectifier units is placed between the a-c voltage to be measured and a d-c permanent-magnet moving-coil meter, with series multiplier resistors R-R to limit the electron flow. The rectifier produces a d-c electron flow for the meter, this flow being proportional to the a-c voltage measured.

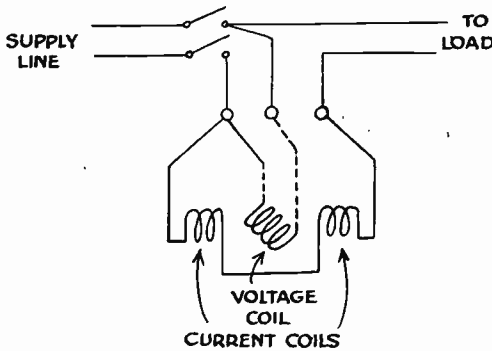

Fig. 321. How the dynamometer coils are connected for measuring power in watts used by a load.

High-frequency electron flows may be measured with a thermocouple meter as shown by Fig. 323. The thermocouple, mounted within an evacuated glass bulb, consists of a junction of two dissimilar metals, often copper and constantan. These two metals are connected directly to the coil terminals of a d-c permanent-magnet moving-coil meter. The junction is close to, but insulated from, a heater wire which is connected in series with one side of the line carrying the a-c electron flow to be measured. Heating of the junction causes a difference of potential between the two thermocouple metals, and this potential difference causes d-c electron flow in the meter coil. The heating is proportional to the square of the amperes of electron flow in the line and in the heater of the thermocouple. The heating is almost independent of frequency up to a million or more cycles.

Ohmmeters are instruments which indicate directly in ohms the resistance between two points to which the ohmmeter terminals are connected. The elementary principle of one style of ohmmeter is shown by Fig. 324. In series with a d-c meter is a dry cell battery and a fixed resistor. For purposes of explanation we assume that

the meter pointer will move all the way across its scale when the electron flow is 5 milliamperes (or 0.005 ampere) and that the resistance of the meter itself is 10 ohms. The battery furnishes 3 volts. To permit 5 milliamperes flow with 3 volts we require a total resistance of 600 ohms, because $R = E/I$. We already have 10 ohms in the meter, so the fixed resistor is to have the difference of 590 ohms.

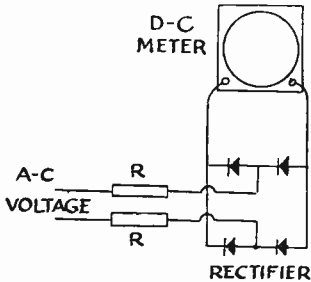

Fig. 322. The rectifier meter is a high-resistance type suitable for measurement of a-c voltages and electron flows.

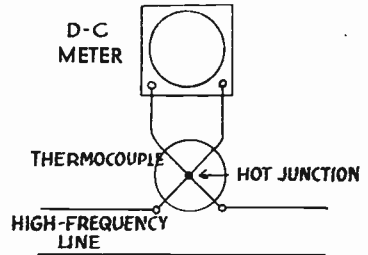

Fig. 323. The thermocouple meter is suitable for the measurement of high-frequency voltages and electron flows.

With no external resistance being measured, the terminals A-A are open-circuited or have resistance between them, so the meter pointer will indicate no electron flow. This means infinite external resistance. If the terminals are connected by a negligible resistance, such as a short piece of copper wire, the meter will indicate the full 5 milliamperes of flow, but this will be shown on the ohms scale as zero (external) resistance. With 600 ohms between the terminals there will be half the full-scale electron flow, or $2\frac{1}{2}$ milliamperes, and this point will be marked 600 ohms on the ohmmeter scale. The ohms scale will not be uniform, but will be very "open" toward the no resistance or zero resistance end and much condensed toward the infinite resistance end. Practical ohmmeters have adjustments to compensate for changes of battery voltage, and may have several scales for various ranges of resistances to be measured.

In most of our electronic work d-c instruments are useful only for measuring average values of pulsating d-c electron flows or voltages, such values as might be useful in determining the permissible continuous output of tubes. A-c meters measure and indicate r-m-s or effective values, so are useful in determining the heating

effect on circuit resistors, fuses, and thermally operated or heat operated circuit breakers.

To determine peak voltages, either forward or inverse, and for the examination of a-c waveforms or pulsating waveforms we must use the cathode-ray oscillograph. The oscillograph must be used also for checking voltages such as applied to the keying tube in synchronous timing circuits, for checking the voltages in phase-shifting circuits, and for checking of such troubles as hard starting of ignitrons which is due to high or low ignitor resistance and may be accompanied by incorrect instantaneous voltages or excessively long electron flow periods in the ignitor circuit.

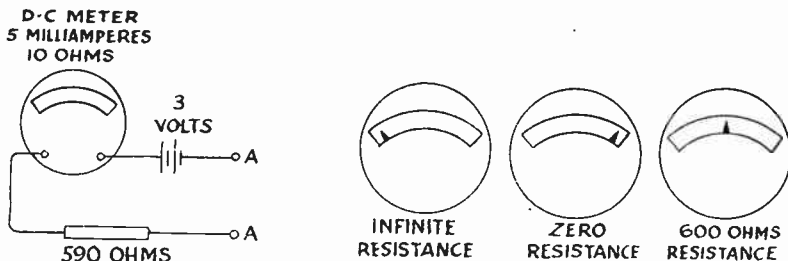

Fig. 324. The elementary principle of one style of ohmmeter.

WIRING AND CONNECTIONS—Wiring from power lines to electronic apparatus, and from the apparatus to machines and devices operated or controlled must be run in accordance with local rules and regulations and must conform to the minimum requirements for such installations as outlined in the National Electrical Code which is the standard of the National Board of Fire Underwriters for electric wiring and apparatus.

Within the apparatus itself, all unsupported leads such as those running to tube caps should be as short as possible. Leads intended to be flexible must be flexible enough to transmit no stresses or vibrations to the tubes, and these leads never should be stretched tightly.

Make certain that uninsulated parts of grid circuits and other sensitive control circuits do not come into direct contact with supports, and see that they are not so close to supports as to allow danger of accidental contact. Insulation in high-resistance circuits sometimes is coated with pure wax as additional protection against moisture which would allow leakage.

The iron and steel housings of electrically operated machines always are well grounded, or should be. When electronic apparatus

in steel cases is mounted on these machines the cases should make good metallic contact with the machine housing so that the cases are grounded.

One side or one wire of any public service a-c power line is usually grounded. When electronic apparatus is operated directly from such a line, without the use of a transformer, it is essential that the grounded side of the power supply be connected to the apparatus



Fig. 325. Accessible terminal connections on a relay. The electromagnetic relay is back of the tube. The heater transformer is at one side.

terminal that is specified for grounding. If the power supply is not grounded or should not be grounded, and if one terminal of the electronic apparatus should be grounded, it will be necessary to install an "insulating transformer" with one-to-one voltage ratio between the power line and the apparatus.

Plate power supply circuits for tubes operating with large electron flows or high voltages generally have fuses or circuit breakers which open the supply in case of any overload due to insulation breakdown, incorrect adjustments, or other causes. Tubes operating

at very high plate voltages may have a voltage-dropping resistor in series with the plate circuit of each tube. In case of a sudden surge of overvoltage the drop in the series resistor protects the tube during the short period required for the circuit breaker to open or for a fuse to blow. With large tubes there often is a time-delay relay which prevents application of plate voltage until the emitter has had time to heat.

TROUBLE SHOOTING—The better you are acquainted with the operation of tubes and their connected circuits the easier it will be to locate and remedy troubles in electronic apparatus. A few faults may be located simply by observation; these including burned out hot-cathode tubes which remain cold, and other burned out units which disclose their condition by a charred appearance or by the characteristic odor of burnt insulation. However, for most cases of trouble we require certain testing instruments.

Minimum requirements in the testing instrument line would be for (1) an a-c voltmeter capable of measuring maximum line voltages and transformer secondary voltages except those of the highest values such as used with some oscillators and rectifiers, (2) a high-resistance multi-range d-c voltmeter, probably of the rectifier type, capable of measuring smooth or pulsating d-c voltages, (3) a multi-range ohmmeter, which is useful not only for resistance measurements but for many circuit tests, and (4) an oscillograph for measuring all the things that cannot otherwise be measured.

Usual procedure is to locate the part or parts in trouble, by general tests of voltages and resistances, then to examine and check the condition of those parts in accordance with their known peculiarities of operation. The tubes themselves ordinarily are tested while in their regular positions and supplied with usual operating voltages. Practically all other parts which are to be individually tested must first be disconnected, at least at all except one lead or terminal, from all other parts of the apparatus. This is because voltages, electron flows and apparent resistances or impedances might otherwise be so affected by conductive paths through other parts as to make tests meaningless. Nearly all our electronic circuits have parts in parallel, and, when trouble exists, the voltages and electron flows in parallel paths are almost unpredictable. Even leaving a part connected to an energy source means that we probably would test the source rather than the part.

When making any kind of tests it is a good general rule to moderately vibrate or jar the tested parts so that intermittent

troubles will show up. Such troubles usually are due to loose mountings, fastenings, or too little clearance at some points.

Having located a damaged or defective unit it is not enough to just repair it or replace it with another part, for that often would mean that the same kind of trouble would soon recur. The thing to do is determine from the symptoms or kind of trouble the probable cause for that trouble, then correct the cause.

It is difficult, and sometimes almost impossible, to work speedily and effectively on a job of trouble-shooting without having a wiring diagram or at least a schematic circuit diagram of the apparatus, preferably with a list of normal voltages and resistances. This does not mean that you cannot shoot electronic trouble without a wiring diagram and a list of values, but such information always will save time.

CIRCUIT TROUBLES—Circuit troubles, or troubles occurring in wiring, other conductors, and insulation, may be considered to include,

1. **Short circuits**; which are accidental connections or contacts between conductors which normally should be insulated or separated from one another, and which are or may be at different potentials.

2. **Accidental grounds**; which are short circuits from a normally insulated or isolated conductor to ground, which usually is the metallic framework or support of the apparatus.

3. **Open circuits**; which are points at which a normally complete conductive path is not complete, thus preventing electron flow through all parts in series with the open point.

4. **Abnormally high resistances**; which act similarly to open circuits except that there still may be some electron flow.

Short circuits and accidental grounds are most frequently caused by or located at the following:

Disconnected leads at terminals, such as at tube sockets.

Loose wire strands at terminals.

Worn or scraped insulation.

Insulating tubing, push-back insulation, bead insulation, and other movable insulation out of place.

Excessive moisture, dirt, or oily accumulations on insulation.

Lack of sufficient clearance when there is movement due to vibration, to normal mechanical motions, to expansion and contraction with heating and cooling, etc.

Excessive looseness or play of unsupported flexible leads.
Insulation that has deteriorated due to oil or other liquids.
Insulation that has hardened and cracked due to overheating or age.
Shorts and grounds may occur also in or through resistors, capacitors, transformers, inductors, and dry rectifiers.

Open circuits and high resistance occur at or because of the following:

Dirty, corroded or pitted contact surfaces; as in switches and relays.
Looseness at screw or clip terminals.
Loose, corroded or otherwise defective soldered joints.
Tube cap connectors off, loose or corroded.
Ground connections loose, dirty or corroded.
Wires broken (possibly under insulation) because not flexible, stretched too tightly, or subjected to excessive vibration.
Fuses blown, loose in clips, or making poor contact through corroded clips.
Connections made wrong, or completely missing. These must be checked with a wiring diagram.

VOLTAGE TESTS—At least in the preliminary stages of trouble shooting we usually prefer making tests of voltages rather than of electron flows. There are two good reasons. First, voltage tests are made between any two points in a circuit without opening any connections, while tests of electron flow require opening a circuit to insert the meter. Second, there is great danger of burning out an electron flow meter with unexpectedly high rates of flow, especially when there is an unknown trouble, while high resistance voltmeters of suitable range are seldom damaged.

Some important principles of voltage testing are illustrated by Fig. 326 where, at A, B and C, we have in series one part in trouble and another with no trouble, and at D and E we have the two parts connected in parallel. What the voltmeter shows in a series circuit depends on whether it is connected across the part containing a fault or across another part which is in good condition. With parts in parallel, all are subjected to the same voltage provided there are no resistances or impedances between them.

Voltages at tube filaments or heaters should be measured at the socket or the lead terminals with the tube in place and the heater or filament turned on. It is possible to measure plate-to-cathode

voltages of vacuum tubes if these voltages are not too high, but the high voltages and sudden voltage changes of gas- or vapor-filled tubes are likely to damage any ordinary voltmeter.

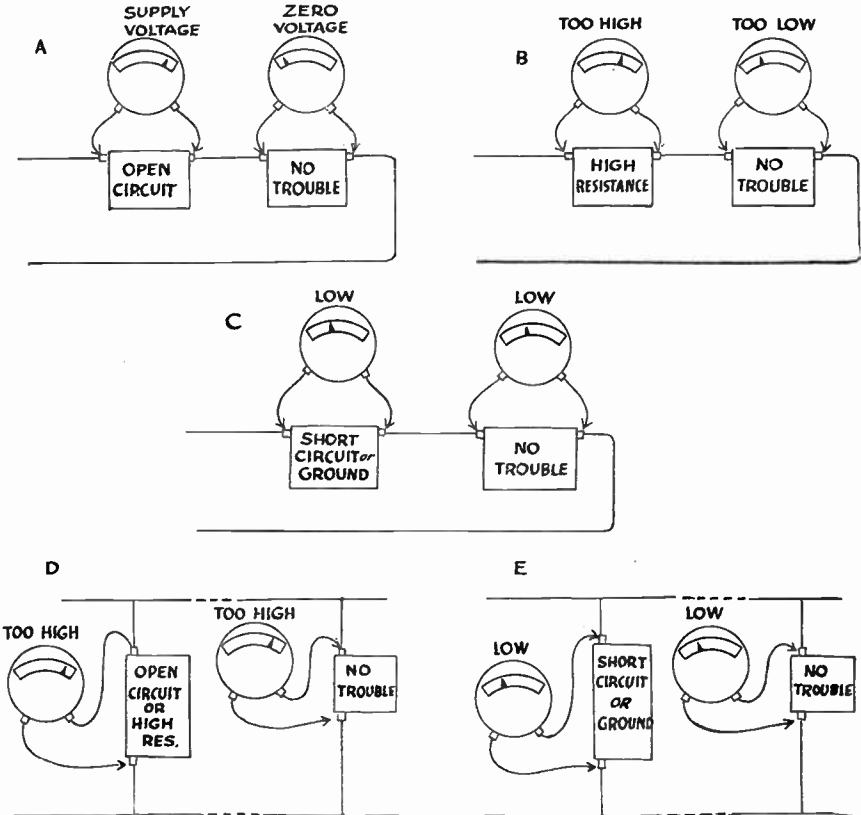

Fig. 326. At A, B and C are shown voltmeter indications when testing at parts in series. At D and E are shown indications with parts in parallel.

Incorrect voltages may be classed as (1) no voltage, (2) low voltage, (3) high voltage, (4) fluctuating voltage or surges, and (5) incorrect phasing.

No voltage will be due to open circuits or very high resistances, which already have been considered.

Low voltage frequently is due to the following:

Short circuits or accidental grounds which cause overloads and excessive voltage drops in some parts of the circuit.

High resistance in series with the part tested, allowing too little electron flow and a low voltage drop in the part tested. Overloads of any kind; such as may be due to incorrect adjustments, changes of resistors or other units, substitution of too large tubes, etc.

Using the wrong primary or secondary tap on a transformer, a tap not suited to the line voltage.

Any trouble or defect in the power transformer.

Supply line frequency (cycles) not the same as that for which apparatus designed.

Line voltage may be abnormally $\frac{1}{2}$ or $\frac{3}{4}$ at some times or at all times.

High voltage may be due to the following:

Using the wrong tap on a transformer, a tap not suited to the line voltage.

Underloading; using small tubes or any low-power elements in apparatus designed and adjusted for greater loads.

Line voltage may be abnormally high, especially when the line connects to power equipment that operates only during certain periods.

Line frequency not the same as that for which apparatus designed.

Fluctuating line voltage, with changes occurring irregularly and usually quite suddenly, almost always is due to the operation of other power equipment connected to the same line. Fig. 327 shows three loads connected through their branch circuits to feeders, which are low-resistance conductors extending from the building service entrance to the fuses or circuit breakers for the branch circuits. Whenever a load draws electron flow, that electron flow passes through all conductors between the load and the service entrance, and in those conductors causes a voltage drop proportional to the rate of electron flow and the resistance of the conductors.

Electron flow taken by load A will drop the voltage at all points beyond the connection of its branch circuit to the feeder, so will affect the voltage at loads B and C. Electron flows to B and C will have only minor effect on the voltage at A. Electron flow to load B will affect the voltage at load C, but C will have relatively little effect on the voltage at B.

Voltage fluctuations, and voltage surges, are avoided by connecting the apparatus to points farther back on the conductors, or to points closer to the building service entrance. Lighting circuits

always are designed to have less voltage fluctuation, or better voltage regulation, than power lines. So connection to a lighting circuit will provide steadier voltage than connection to a power line provided the apparatus may be so connected without violating local rules or Code rules. In some cases it may be necessary to use a voltage regulating transformer which maintains nearly constant output voltage with varying input voltage.

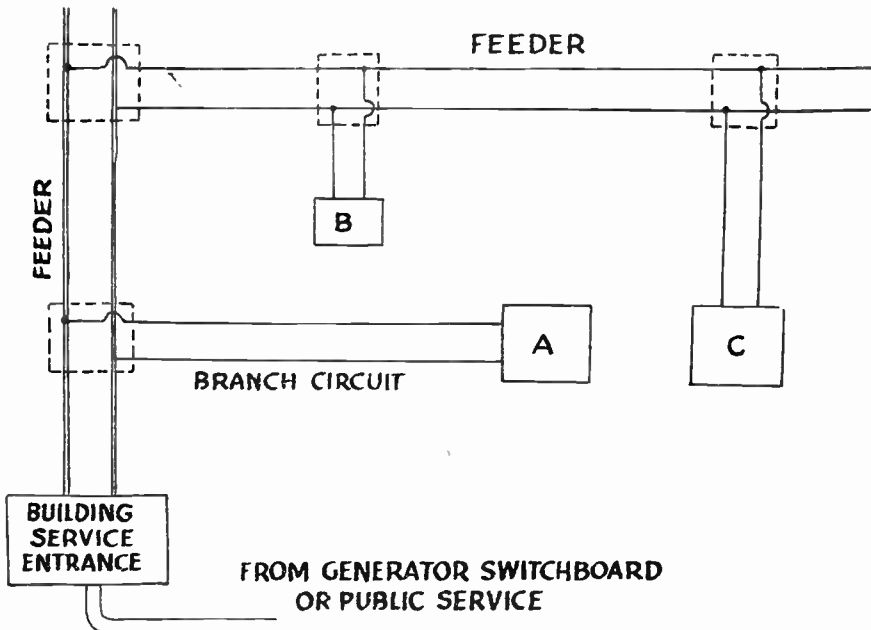

Fig. 327. Loads which may or may not affect the voltage at other loads, depending on the relative positions of the loads with reference to the service entrance.

Incorrect phasing of voltages means that the instantaneous polarities, positive and negative, of two a-c voltages are opposed when they should aid each other, or that they aid when they should oppose. If the relations of instantaneous voltages to parts of the apparatus should be as indicated at the left in Fig. 328, and if they are so related with the full-line connections, the relation will be reversed with the broken line connections from one source. If connections are reversed from both sources the relation will be just the same as though neither had been reversed.

One way of checking the phasing of two a-c voltages is shown at the right in Fig. 328. The test instrument is a high-resistance

a-c voltmeter having a range as high as the sum of the two a-c voltages. When both sources are connected to the meter there will be a high voltage reading if the voltages are in phase, or nearly so, and there will be a lower reading, or possibly a zero reading, if the two voltages are out of phase or in opposite phase. Whether the two voltages should be in phase or out of phase depends on the kind of apparatus and on how it should operate.

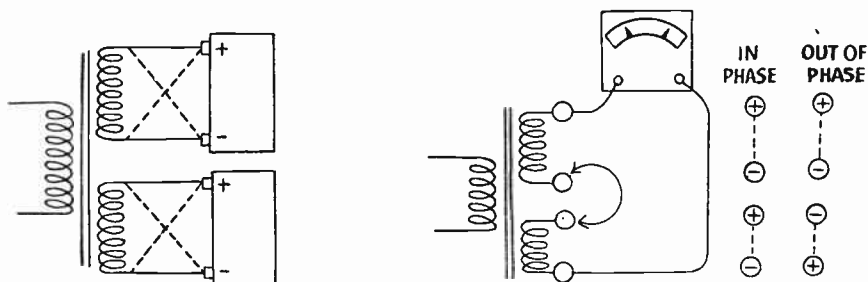

Fig. 328. If phasing is correct with full-line connections it will be incorrect with either brokenline connection, but not with both connections reversed. Phasing may be tested with an a-c voltmeter.

TROUBLE IN INDIVIDUAL UNITS—In addition to the tubes, the principal operating units in electronic apparatus include resistors, capacitors, transformers, switches, relays, circuit breakers, fuses, and dry rectifiers. If examination, voltage tests, and resistance tests indicate possible trouble in one of these units it should be disconnected and checked individually. •

Heat is probably the most important single limiting factor in the operation of all these parts of electronic apparatus. Temperature depends on the relation between the rate of heat production (the I^2R loss) and the rate at which heat is dissipated into surrounding air, water or other cooling medium. Heat is produced only while there is electron flow, but is dissipated all the time. Consequently, if a part carries electron flow only intermittently it may be allowed to generate heat rapidly during operating periods and still will not overheat because of the dissipation during idle periods. Tubes, resistors, capacitors, transformers, dry rectifiers, and other parts have entirely different ratings (electron flow and voltage) for intermittent operation than for continuous operation.

The operating time in relation to the total time is called the duty cycle. The duty cycle may be specified as so many seconds or minutes of operation during some longer specified time, such as

15 seconds out of 75 seconds. The duty cycle may be specified also as a percentage, such as 20 per cent, which gives the percentage of the total time or of specified time periods in which the part may operate at certain electron flows and voltages. Operation at a duty cycle higher than that for which the part is rated will quickly cause damaging overheating.

The following paragraphs list common troubles, and their causes, for the several types of parts found in electronic apparatus.

RESISTOR TROUBLES

Open circuit, resistor burned out.

High ambient temperature, due to lack of air circulation, or to being too close to other parts of the apparatus which prevents heat radiation.

Resistor which should be used only part time (as for starting) stays in circuit too long.

Wattage rating too low, or not suited to duty cycle.

Shorts or grounds, insulation defective.

Excessively high voltage or electron flow.

Long continued overheating, but not great enough to cause burnout.

Moisture, dirt, oil or corrosive spray and fumes.

Mechanical damage due to carelessness.

Adjustable voltage dividers and rheostats.

Same troubles as for resistors, above, also:

Poor contact between slider and winding.

Defective connection from stationary terminal to slider.

Dirty or corroded contacts at taps.

CAPACITOR TROUBLES

Open circuits, internal.

Usually impractical to repair; capacitor should be replaced.

Short circuits or grounds, internal.

(Test for shorts through dielectric, by connecting to terminals. Test for ground to case, by connecting to case and to each terminal in succession.)

Excessive working voltages.

Voltage surges, as from switching in relays or with tubes.

Exceeding the duty cycle for intermittent operation.

High ambient temperature from lack of air circulation or from being too close to resistors or other hot objects.
Moisture, oil, or corrosive fumes.

Electrolytic capacitors.

(These gradually deteriorate and should be replaced after some years.)

Polarity of terminals (+ and —) not observed in circuit connections.

Type designed for only d-c operation used in an a-c circuit.

Incorrect charging or failure to charge.

A rough check may be made by charging the capacitor from a battery or other d-c source, waiting for a few seconds after disconnecting the source, then connecting the capacitor terminals to a d-c voltmeter in the same polarity as for charging. The swing of the meter pointer indicates whether the capacitor has taken and retained a charge.

Too much charge, too high voltage, or failure to discharge.

Defective rectifier action, with either plate or grid rectification, or with a dry rectifier.

Discharge resistor open circuited, disconnected, etc.

Discharge tube fails to break down and permit discharge.

Too little charge, low voltage, or failure to charge.

Defective rectifier action, as above.

Defect in capacitor; open circuit, short circuit, etc.

SWITCH TROUBLES

Manually or mechanically operated types, not magnetic types.

Contacts dirty, corroded or pitted.

Contacts loose or bent, out of line, limited contact area.

Springs disconnected, bent or weak.

Improper air gap setting.

TRANSFORMER TROUBLES

Internal short circuits or grounds.

Shorted between turns of a winding. Causes low secondary output, high primary input, and severe overheating.
Not repairable.

Shorts between windings. See insulation failure below.
Grounds from terminals, leads or windings to frame or core.

Insulation failure.

Excessive primary voltage, or excessive electron flow in either primary or secondary.

High transient voltages, or high induced voltages in connected inductive parts.

Moisture, oil, corrosive fumes.

Mechanical damage, from carelessness.

Overheating.

Excessive voltage or electron flow.

High ambient temperature due to lack of air circulation, closeness to hot parts, etc.

Internal short circuits or grounds.

Operation on higher duty cycle than that for which rated.

FUSE AND CIRCUIT BREAKER TROUBLES

Test before replacement or resetting.

When a fuse blows or a breaker opens, connect a suitable voltmeter, or a test lamp of suitable voltage rating, across the fuse clips or around the breaker. The meter or lamp will indicate whether a short circuit or accidental ground still exists. After the fault has been located and corrected the meter reading will drop or the lamp will go out. Then the fuse may be replaced or the circuit breaker reset.

Load may have been increased or the duty cycle increased by changes in the apparatus. Check the fuse capacity or the circuit breaker rating and adjustment against the actual load as measured with an ammeter. Fuses and most breakers have a certain time delay, so may be of lower rating than momentary high pulses of electron flow. The load or the duty cycle should be reduced to a normal value to avoid overheating and damage to the apparatus.

Fuses blow too quickly.

Ampere capacity too small.

Overheating due to clips that are dirty, corroded, loose, or making poor contact due either to lack of initial tension or to overheating and softening.

RELAY TROUBLES**Load contacts.**

Dirty, corroded or pitted.

Out of line, leaves bent. May fail to open on drop-out, or fail to close on pull-in, or vice versa, depending on type.

Coil or winding.

Incorrect resistance for the required operation.

A-c coil used in a d-c circuit, or vice versa.

Short circuits, internal or at leads and terminals.

Open circuits, internal or at leads and terminals.

Intermittent troubles.

Usually due to dirt, mechanical binding, loose parts, loose mounting.

Pull-in too soon, or with too little electron flow.

Spring tension too weak.

Core-to-armature gap too small.

Pull-in too late, require excessive electron flow.

Spring tension too great.

Core-to-armature gap too large.

Dirt or obstructions in magnetic gap.

Mechanical binding of pivots or leaves.

Magnet face dirty or sticky, as from oily deposits.

Magnetic circuit breakers are a form of relay, and are subject to most of the above troubles.

DRY RECTIFIER TROUBLES

Check with the ohmmeter. A single element dry rectifier should show several times as much resistance in one direction as in the opposite direction, with the ohmmeter leads first connected one way to the rectifier terminals, then reversed. To check a full-wave bridge type of rectifier, disconnect both a-c leads and leave them off, then connect the ohmmeter first one way and then the other way to the d-c leads while these d-c leads are disconnected from everything except the ohmmeter.

Failure to rectify, passes excessive a-c electron flow.

Overheating, which may be due to excessive applied voltage, high ambient temperature, or operating with a duty cycle higher than that for which the rectifier is rated.

Used where there are corrosive fumes.

Mechanical damage due to carelessness or abuse.

Grounded to frame or supports.

Test from each terminal or lead to ground.

Short circuit between elements.

May result from excessive dirt around cooling flanges.

INSPECTION AND MAINTENANCE OF ELECTRONIC EQUIPMENT

The principal advantage of electronic control is the small number of moving and wearing parts. Because these parts—resistors, reactors, transformers, and capacitors, etc.—do not fail frequently, this type of control requires little maintenance. Nevertheless, continued operation cannot be expected unless periodic inspection, adjustment, and repair is carried out.

Many parts of electronic control are similar to those used in magnetic control: the enclosing cases, bases, and terminal, wiring and conduit devices, for example. Standard magnetic control devices such as fuses, switches, overload relays, and both instantaneous and time delay relays will be found on many electronic panels. These devices usually perform starting or protective functions and many operate quite infrequently. This infrequent operation sometimes leads to special maintenance problems due to the dust, corrosion, and contact difficulties.

Since many circuits on electronic panels have a very high impedance, the servicing of such equipment requires meters having high impedance. The radio service type of multimeter, having a resistance of 1000 ohms per volt or higher, is a useful tool, but some circuits can be tested only with electronic instruments such as the vacuum-tube voltmeter or the cathode-ray oscilloscope. The cathode-ray oscilloscope, particularly when modified to read d-c potentials, is an extremely useful device because it

combines, in effect, a very high impedance voltmeter with a time axis. Therefore, voltage changes that are much too rapid for the ordinary instrument to follow are made visible. Instantaneous thyatron grid and plate potentials can be observed easily with such an instrument, and incorrect operation can quickly be detected. Nevertheless, the majority of faults encountered in erratically operating electronic devices can be found by careful analysis of the operating indication, a thorough inspection of the apparatus, and the use of an ordinary multimeter.

Most of the items involved in the operation and maintenance of electronic control will be considered later. An understanding of the troubles, causes and remedies listed will greatly facilitate testing and trouble shooting on such equipment.

To be really efficient, the electronic maintenance man must understand the equipment placed in his care. He should know the operating sequence of each part of the control so that he may readily diagnose trouble. He should know which tube operates which relay and, in controls where tubes light up in sequence, he should know the proper order. Moreover, he should be acquainted with the wiring diagrams of the different controls, and, wherever possible, he should test each control as time permits and record voltage values obtained. With such data, a defective control may quickly be diagnosed. Without it, much time will be lost in unnecessary testing and analysis.

INSPECTION SCHEDULES

Many of the troubles commonly encountered in the use of electronic equipment of all types may be considerably reduced by the employment of an inspection schedule adapted to that particular type of control, and to the operating conditions under which it is expected to work. Due to the wide variation in both design and operating conditions, it follows that no hard and fast rule can be made that will apply to all cases; nevertheless, the schedule given here on photoelectric equipment will provide an example that may be used as a base from which a suitable schedule may be devised for any type of equipment.

The individual responsible for the continued operation of electrical and electronic equipment quickly detects the items that give frequent trouble; from such practical data he may then lay out an inspection schedule calculated to best meet the needs of the equipment under the operating conditions encountered.

INSPECTION SCHEDULE FOR PHOTOELECTRIC CONTROL

EVERY 3000 HOURS

Inspect vacuum tubes

In order to maintain continuity of service, all radio-type vacuum tubes should be checked and replaced if necessary.

EVERY 1000 to 3000 HOURS

Inspect light-source lamps

To prevent shutdowns by lamp burnouts, replace lamp each 1000 to 3000 hours, depending upon voltage applied. See instructions and recommendations supplied with equipment.

1 to 3 MONTHS, DEPENDING ON FREQUENCY OF OPERATION

Inspect contacts of magnetic relay

Look for excessive wear, burning, or pitting. Replace contacts if necessary. Check amount of wipe on normally closed contacts of sensitive relays. Test spring tension on relay contacts and check air gap.

1 to 6 MONTHS, DEPENDING ON LOCAL CONDITIONS

Inspect all glass or plastic surfaces through which light passes or from which it is reflected, such as lenses, phototubes, windows and mirrors.

Check for dust, oily film or any foreign matter which restricts the passage of light. Clean the surface. If oil film is present, use a suitable solvent. Since plastic surfaces are quite soft, care must be taken not to scratch the surface. Such surfaces should be cleaned with an air supply or dusted lightly with a cloth or brush. If necessary to use water or solvent, such as carbon tetrachloride, rub surface very carefully so as not to cause abrasion. Replace all glass or plastic parts which have become scratched or broken.

3 to 6 MONTHS

Inspect mechanical auxiliaries, relays, etc., used with photoelectric equipment. Check for contact wear, loose parts, loose connections, proper lubrication, alignment, etc.

1 to 6 MONTHS

Inspect control panel, phototube holders, and other auxiliary electronic equipment.

Check for dirt, metallic dust, and other foreign material. Because of the high impedance of most electronic circuits, such dirt and dust accumulations may cause trouble. The presence of moisture will make the condition much worse. Particular attention should be given to the phototube portion of the circuit, since the effective impedance of a phototube may be 50 to 500 megohms. Therefore, any leakages in associated cables, sockets, or panel surfaces must be at least 2000 megohms if erratic operation is to be avoided.

1 to 3 MONTHS

Inspect light sources, phototube holders, apertures, mirrors, and other parts included in the optical system.

Check these parts for proper alignment. Equipment subjected to vibration may develop loose supports, or it may be accidentally handled or struck by some object and knocked out of position.

3 to 6 months

Inspect connections to terminals and plug connections

Under severe operating conditions vibration may cause these connections to work loose. Tighten securely.

1 to 3 MONTHS, DEPENDING UPON LOCAL CONDITIONS

Inspect Air Filter

Air filters on ventilated cases should be cleaned out periodically or replaced. If filter is of a type which cannot be cleaned, replace with new filter.

TROUBLES WITH PHOTOCCELL UNITS

TROUBLE: Magnetic relay in photoelectric device does not operate when light beam is varied.

CAUSE: No light on phototube, or light reduced below the intensity required for operation. . . . Check light source. Lamp may be burned out.

- CAUSE:** Light, source, phototube holder, aperture, or surface from which light is reflected may be out of alignment. . . . Align correctly and check mounting supports for evidence of vibration.
- CAUSE:** Dirt on surfaces through which light passes or from which it is reflected. . . . Clean the surfaces and inspect at regular intervals.
- CAUSE:** Line voltage not within the limits specified. . . . Correct line voltage by use of suitable auxiliary equipment.
- CAUSE:** Defective tubes. . . . Check tubes by replacement.
- CAUSE:** Positioning key in center of tube base (radio-type tubes) may be broken and tube has been placed in socket incorrectly. . . . Place tube in socket properly. If a new tube is not available, check alignment of tube pins before replacing in socket.
- CAUSE:** Excessive light reaching the phototube from some source other than the light source. . . . Shield phototube from extraneous light or relocate phototube holder.
- CAUSE:** Defective circuit components, such as resistors, capacitors, etc. . . . If circuit voltages have been included with instructions, check these as a means of locating the trouble. Otherwise, make a visual inspection of the panel for defective parts, and check values of components with suitable testing equipment. Particular attention should be given to electrolytic capacitors, since this type of capacitor has a limited life, and failure may occur after several years of operation. When replacing, observe condenser polarity. **Be sure cause of failure is removed before unit is returned to operation.**
- CAUSE:** Excessive leakage in phototube cable or circuit associated with phototube caused by moisture accumulation, dirt, or poor insulation. . . . Check for leakage of phototube cable, phototube socket, and terminals where cable connects to panel. Total leakage-resistance should be at least 2000 megohms, if satisfactory operation is to be obtained.
- CAUSE:** Open magnetic relay coil. . . . Replace coil.

TROUBLE: Photoelectric relay operates erratically.

CAUSE: Variation in light on phototube resulting from light flicker due to worn contacts, loose connections, vibration, or other causes. . . . Replace lamp, if necessary. Light source, phototube unit, aperture, or surface from which light is reflected may be moving due to vibration or loose supports.

CAUSE: Variation in line voltage outside the limits specified for the device. . . . If possible use a better regulated power supply, such as is ordinarily obtained from lighting circuits. Otherwise, install a constant-voltage transformer or other voltage regulating equipment.

TROUBLE: Magnetic Relay on the Photoelectric Unit Opens and Closes Continuously at a Rapid Rate.

CAUSE: Grounded side of power supply on wrong terminal of photoelectric unit. . . . In some photoelectric relays not provided with an anode transformer, the grounded side of power supply must be connected to terminal as specified in the instructions. If power supply cannot be grounded, a 1-to-1 ratio isolating transformer should be installed and the proper terminal of the relay grounded.

CAUSE: Capacitor which is connected in parallel with the relay coil may be open, or filter capacitor in rectifier may be open. . . . Replace capacitor.

TROUBLE: Contacts on "sensitive"-type relays either stick or do not make good contact.

CAUSE: Insufficient wipe or improperly adjusted contacts. . . . Bend armature stop or contacts to obtain proper clearance between armature and contact spring. Clean contacts.

CAUSE: Contacts worn badly. . . . Replace contacts.

TROUBLE SHOOTING FOR ELECTRONIC CONTROL

TROUBLE: Reduced tube life or tube failure.

CAUSE: Vibration or mechanical abuse. . . . Shock-mount the tubes, the control panel, and use extra flexible leads. Prevent objects from striking tube holders and sockets, or tube elements may be jarred out of position or the weld on tube leads or connections may be broken.

- CAUSE:** **Natural deterioration.** . . . Usually failure is due to gradual loss of electron emission as the active cathode material is used up or flakes off. Be sure deterioration is at a rate consistent with expected life for each type of tube in its particular service. If the tube life seems too short, see following recommendations.
- CAUSE:** **Incorrect voltage on filament or heater.** . . . Check voltage at tube terminals frequently to determine magnitude of filament voltage variation. Do this with tube in socket both with and without anode load connected. If voltage is fluctuating more than plus or minus 5 per cent from filament rating, install voltage regulating transformer. If filament voltage is consistently high or low, adjust taps (if any) on transformer, install new heater transformer, or install an auto or booster transformer to correct filament voltage.
- CAUSE:** **If voltage is erratic—on and off.** . . . Check wiring from heater supply to tube sockets for loose connections, poorly soldered joints, corrosion, or conductor breaks.
- CAUSE:** **Ambient temperature too low or too high.** . . . Provide extra heat or forced air cooling to hold temperature within limits specified in tube instructions. Ambient temperature, which means temperature surrounding the tube, should be measured at the tube. Consult tube instruction sheet before applying heating or cooling methods. Correct ambient temperature is essential to the proper operation of mercury vapor type tubes.
- CAUSE:** **Excessive loading or too frequent operation.** . . . Operators of the equipment may have increased the anode voltage, replaced coils or made other changes to obtain greater output. Tubes should not be operated at outputs greater than those for which they have been designed. When equipment is used intermittently, tube life may be increased by leaving cathodes heated during unloaded periods. This prevents strains caused by too frequent heating and cooling.
- CAUSE:** **Mercury-vapor tubes don't fire.** . . . Measure air temperature next to tube; if necessary provide heat to bring temperature up to value specified in tube instructions. Manually or thermostatically controlled strip heaters are usually employed for this purpose.

- CAUSE:** Arc-backs after tubes have warmed up. . . . Ambient temperature too high. Provide forced-air cooling according to instruction sheet on tubes (Mercury-vapor tubes are rated on basis of "condensed mercury temperature").
- CAUSE:** Arc-backs when tube is first placed in service. Mercury vapor splashed on elements during shipment or handling of tube. Tube not kept in upright position. . . . Heat the tube cathode to distill this mercury before anode power is applied. Make sure cathode is heated for the length of time stipulated in instructions furnished with tube.
- CAUSE:** Failure of tubes to operate when starting equipment. Interlocks or protective control devices are not operating properly. . . . Check contacts to see that they close and that they are clean.
Cathode protective timer has not completed its timing cycle. . . . Wait until timing cycle is completed before attempting to operate equipment.
- CAUSE:** No voltage at control panel terminals. . . . Check external connections, fuses and panel connections to be sure they are correct.
Incorrect power. . . . Check the terminal power to make sure it corresponds with nameplate rating in voltage, phase, and frequency.
- CAUSE:** Missing Connections. . . . Recheck the circuit with wiring diagram.
- CAUSE:** Tubes will not heat up. . . . Check with wiring diagram to make sure tubes are in right place. The thyatron tube will be warm when cathode is heated. **Do not touch metal tubes while power is on the panel as the metal jackets are energized.**
- CAUSE:** Tubes may have been damaged internally through shipment. . . . Replace tube.
- CAUSE:** Overheated transformer or reactor. . . . Check cause of overload and remove. Warning is usually given by the odor of excessive heating, melting of the sealing compound, smoking or charring of the insulating paper. **Replace transformer.**

TROUBLE: Loose connection, or leads breaking.

CAUSE: Excessive vibration or poor soldering. . . . Install extra flexible connections. Resolder. Use shock absorbing mounting.

MONTHLY INSPECTION SCHEDULE FOR RESISTANCE WELDING CONTROL

Many of the operational difficulties associated with resistance welding equipment and its electronic control may be eliminated by a periodic check on the welding and control apparatus. Although the inspection routine here presented outlines the procedure for a particular type of installation, the schedule may easily be modified to fit the maintenance demands on any type of equipment designed for a similar purpose.

Make an over-all mechanical inspection with power-supply and control voltage disconnected but water supply turned on.

Check water-supply system for leaks or corrosion at fittings. See that there are no kinks in hose connections. Water-flow switch should not allow control to be operated on less than required water flow. If the flow switch is of the mechanical-type it should be tested at this time. Thermal-type flow switches, which require control voltage, should be tested later. Water should flow upward through power tubes.

Inspect tube sockets and anode and grid connectors

Remove anode and grid connectors and remove tubes from sockets. Remove dust (especially any metallic dust) from top of socket. Replace tubes, replace anode and grid caps, and inspect tightness of tube connections.

Inspect relays

Should be in de-energized position. Pivots must not bind and spring tension should be correct.

Inspect adjustable parts

Knobs and fittings should be tight. Slider brushes on rheostats should make good contact with resistor windings. Tapped rheostats should be clean.

Check wiring and connections

Inspect for loose connections at screw terminals and soldered joints. Look for loose sliders on adjustable resistors and see that the clearance between exposed wires (such as resistor and capacitor leads) and live parts is adequate. Inspect power-tube connections to be sure they are tight.

Check ignitor fuses

Be sure ignitor fuses of correct size are being used and that they make good contact with fuse clips.

ELECTRONIC CONTROL FOR RESISTANCE WELDING

Although there are several different types of electronic controls used for resistance welding, that is, for spot welding, projection welding, flash welding, butt welding, etc., all are similar in basic design and subject to similar troubles. Below is given some of the common difficulties associated with this type of electronic equipment.

TROUBLE: No welding current when weld-initiating switch is closed.

CAUSE: (If both firing tubes operate for normal timing) secondary circuit of welder open. . . . Make sure that electrodes fully close on work. Inspect joints in electrodes and electrode holders.

Welding transformer set on too low tap or heat control set too low for welding heat required. Compare all time and heating settings with values specified for work being done.

CAUSE: (If neither firing tube operates, but control tubes operate for normal timing) Power supply off. . . . Close line circuit breaker or replace fuses.

Ignitron power tubes have open ignitor circuits. Protective relay deenergized. . . . Make sure safety switch closes. Make sure cathode heating period for firing tubes has elapsed.

CAUSE: Water-flow switch tripped out. . . . Make sure cooling water for power tubes is adequate. Be sure cooling water is not too warm.

- CAUSE: Igniters disconnected, or firing tube anode or grid caps are off. . . .** Inspect ignitor leads and be sure ignitrons are mounted vertically with cathode end down.
- CAUSE: Ignitor fuses blown. . . .** Do not increase fuse size but if replacement fuses also blow, check the following:
- CAUSE: Incorrect protective resistor in ignitor circuit. . . .** When power supply is less than 250 volts, connect ignitor series resistor for 1 ohm (G. E. Tubes) When power supply voltage is more than 250 volts, use total resistance of 4 ohms.
- CAUSE: Phase controlled heat setting too low. . . .** When power supply voltage is less than 250 volts, do not decrease heat control (phase control) below 40 per cent on heat control dial.
- CAUSE: Insufficient load current. . . .** If firing tubes flare excessively when ignitor fuses are replaced, make sure that the power tube load current is sufficient for starting ignitrons (40 amperes reactive load or 25 amperes resistive load). Flash welders require auxiliary load resistor.
- CAUSE: Defective copper oxide rectifier. . . .** Replace copper oxide rectifiers in ignitor circuits.
- CAUSE: Copper oxide rectifier short circuited to ground. . . .** Replace copper oxide rectifiers in ignitor circuits.
- CAUSE: Defective ignitron tube. . . .** Install new power tube. When installing new power tubes also install new firing tubes. If this overcomes trouble, retest old power tubes by reinstalling one at a time.
- CAUSE: Firing-tube cathodes not heated. . . .** Make sure that filament voltage is correct. If necessary, substitute new firing tubes.
- CAUSE: Heat-control circuit open. Heat control potentiometer or rheostat open. . . .** Try full heat setting using short timing and low heat tap on welding transformer, and then try weld on scrap stock.
- CAUSE: Full heat limit resistor open. . . .** Be sure slider adjustment makes good contact on winding.
- CAUSE: Phase-control (heat control) circuit open. . . .** Cathode-ray oscilloscope should be used for checking component voltages in grid circuits of firing tubes.

CAUSE: Series capacitor for power-factor improvement not changed. . . . Energize welder at reduced heat (phase) setting to change series capacitor and then readjust heat dial for desired setting.

CAUSE: If neither firing tube operates, and control tubes do not operate. Water flow switch tripped out, or protective relay not energized.

CAUSE: A. C. control-voltage fuse blown. . . . Be sure correct tap on primary of control transformer is being used. If replacement fuses blow, disconnect load on secondary of control transformer. Then apply control voltage to check transformer for short circuit. If transformer is all right, reconnect load, one item at a time, until short is found in circuit.

CAUSE: No D. C. control voltage. . . . If rectifier tube does not glow, make sure cathode is heated and replace D. C. control voltage fuse. If new fuse blows, substitute new rectifier tube. If trouble still persists, check filter capacitors and resistance of d-c voltage-divider circuit by using high-resistance voltmeter.

CAUSE: Sequence or weld-initiating circuit open. . . . Make sure initiating relay operates.

CAUSE: Keying tube does not operate. . . . Inspect contacts in anode circuit. Substitute a tube known to be good. Be sure anode voltage is applied, and that grid voltages are correct. Complete inspection requires using cathode-ray oscilloscope.

TROUBLE: Welder energized when power switch is closed.

CAUSE: (If one or both firing tubes operate but control tubes do not operate with initiating circuit already closed. . . . Check the following if ignitron contactor is being used.

CAUSE: A. C. control voltage reversed or out of phase. . . . Be sure that phase relation between power and control voltages has not been altered by changes made farther back on lines.

CAUSE: Ignitrons fired by A. C. caused by insulation breakdown between grid circuits of firing tubes. . . . Remove power and control voltage, disconnect both ignitor leads, and test for insulation breakdown between grid circuits of

firing tubes, between each grid circuit and main control circuit, and between each grid circuit and ground. If defect is found, clear fault, and repeat test. Replace over-heated transformers, but retest circuits before applying control voltage.

CAUSE: (If neither firing tube operated) Power tubes too hot. Make sure cooling water is adequate and not too warm. Make sure operating duty cycle is not too high. Refer to rating curves. Demand current at full-heat (Phase-control) setting must be used for selecting size of power tube.

CAUSE: Defective power tube. . . . Find which tube is defective by disconnecting and insulating one anode connector at a time.

TROUBLE: Electrode flash when closing on work.

CAUSE: Weld-initiating switch being closed too soon. . . . Retard cam switch or increase squeeze period. If this does not correct trouble, prevent initiating switch from being closed during test for Welder Energized When Power Is Closed.

TROUBLE: Electrodes flash when separating from work.

CAUSE: Weld-initiating switch still closed, and weld time not elapsed. . . . Make sure hold period is not started before end of weld time.

CAUSE: (If firing tubes are still on) Electrodes being open before weld time elapses. Hold period is too short. . . . Make sure hold period is not initiated before end of weld time.

CAUSE: (Trailing firing tube operates) Power-factor starting adjustment incorrectly set, causing residual transient in welder secondary following weld. When secondary circuit is opened, the interruption of the transient triggers the trailing firing tube. . . . Readjust synchronous starting adjustment. Magnetic-type oscilloscope or cathode-ray oscilloscope should be used for this purpose.

CAUSE: Thyrite discharge resistor not connected across primary of welding transformer or loose connections in the re-

sistor circuit. . . . Discharge resistor may be in Control panel but may not be properly connected to primary of welding transformer.

CAUSE: (If firing tubes are not still on or do not flash when electrodes separate from work) Power tubes too hot. . . . Make sure cooling water is adequate and not too hot. Make sure operating duty cycle is not too high. Refer to rating curves used for selecting size of power tube.

TROUBLE: Line breaker trips or line fuses blow when welding is attempted.

CAUSE: (If both firing tubes operate) Line circuit breaker may be set too low or fuse may be too small. . . . Check power-tube ratings before setting line protection higher.

CAUSE: (If only one firing tube operates this causes saturation in the welding transformer) Heat control may be advanced ahead of power-factor angle. . . . Reduce heat setting. If both firing tubes operate, readjust full heat limit.

CAUSE: One ignitor disconnected, one firing tube anode cap off, or one of protective-relay contacts not closed. . . . Inspect ignitor leads and inspect "wipe" on protective-relay contacts.

CAUSE: Ignitor fuse blown. . . . If ignitor circuits are fused separately, interchange positions of power tubes. If the fuse blowing follows one power tube, put in a new power tube. Put in new firing tube when power tube is changed. If fuse blowing still persists, refer to remedy for Ignitor Fuses Blown.

CAUSE: One firing tube defective. . . . If cathodes of both firing tubes are heated, interchange positions of the firing tubes to check tube.

CAUSE: A. C. control voltage reversed or out of phase with power supply. . . . Be sure that phase relation between power and control voltage has not been altered by changes made farther back on lines.

CAUSE: Incorrect tap setting on feed-back transformer for trailing firing tube. . . . Refer to installation notes on wiring diagram.

CAUSE: Trouble in phase-shifting (heat control) circuit or auxiliary heat-regulating controls. . . . Inspect component parts. Inspect component voltages by using cathode-ray oscilloscope.

TROUBLE: Abnormal timing.

CAUSE: Bouncing weld-initiating switch. . . . Inspect switch for mechanical wear or loose mounting.

CAUSE: Excessive voltage variation. . . . Obtain control voltage from farther back on lines. Do not change phase or polarity.

CAUSE: Thyrite discharge resistor not connected across primary of welding transformer. . . . Discharge resistor may be in control panel but may not be properly connected to primary of welding transformer or there may be loose connections in the resistor circuit.

CAUSE: Defective timing tube. . . . Thyatron having greenish or very light blue glow (instead of deep blue glow) during operation indicated defective tube. Interchange timing and control tubes of same type.

CAUSE: Defective time adjustment. . . . Disconnect time adjustment, and test with analyzer.

CAUSE: Timing or control tubes too hot. . . . Be sure ventilating windows or screens are not closed.

* * *

Regardless of what purpose you had in mind in getting this book, our advice is to use it regularly. The more you learn about the wonders of electronics, the more you will want to learn about it. The field of electronics is just in its beginning. The great strides that have already been made haven't scratched the surface of the unlimited applications of electronic controls and equipment.

We sincerely hope this manual will be a constant guide and help you in your work and progress in the future.

INDEX

A

- Absolute pressure, 109
- A-c, meaning of, 165
- Alternating
 - electron flow, capacitor carries, 144
 - curves of, 53
 - maximum, 57
 - potentials, curves of, 52
 - maximum, 57
- Alternation, definition, 53
- Ampere, explanation, 5, 37
- Amplification factor, 223
 - gas, phototube, 328
- Amplifier
 - oscillograph type, 364
 - phototube, connections, 333
 - power, explanation, 220
 - triode used as, 213
 - tubes, 6, 9
 - vacuum tube, 207
 - voltage, explanation, 220
- Amplify, definition, 6
- Amplitude, 134
 - control, of thyatron, 132
- Anode, 60
 - connection of, 40
- Arc discharge, glow tube, 205
- Atoms, composition of 23
- Attraction, electric, 27

B

- Back to back thyatron connection, 155
- B-H curve, see *Saturation curve*
- Bias, grid, 214
 - phototube relay, 336
- Breakdown potential, thyatron, 130
- Breaker, circuit, troubles with, 400
- Bridge rectifier, 245

C

- Capacitance
 - conductor, 171
 - definition, 75
 - triode tube, 224
 - tube, internal, 171
- Capacitive coupling, 299
 - reactance, 146, 292
- Capacitor
 - action of, 72, 230
 - a-c flow in, 144
 - charge in, 71
 - charging, 231
 - grid rectification for, 238
 - time for, 232
 - construction of, 70, 73
 - discharging time, 232
 - electrolytic, 74
 - energy storage, welding, 286
 - grid, action of, 310
 - input filter, 79
 - phase difference affected by, 147
 - phase-shift affected by, 153
 - reactance of, 146
 - resistor paralleled with, 234
 - time constant for, 233
 - timing with, 229
 - series, welding circuit, 287
 - smoothing, 242
 - surge protection with, 172
 - troubles with, 398
- Capacity pickup, oscillator with, 312
- Cathode
 - connection of, 40
 - heater type, 59, 159
 - preheating of, 111
 - returns for, 148, 173, 223
- Cathode-ray
 - oscillograph, 355
 - controls for, 361
 - measurements with, 366, 369
 - voltages for, 361
 - tube, action of, 17, 358
 - construction of, 356
- Cell, photoelectric, see *Phototube*
- Center-tap, connection to, 149
 - filament winding, 65
- Characteristics
 - control, grid-glow tube, 200
 - thyatron, 117
 - thyatron, shield grid, 166
 - grid, triode, 212

Characteristics—(Cont.)

plate, triode, 215

Charge

capacitor, 70, 145

time for, 232

electric, 40

space, 51

Charging, capacitor, action of, 230

grid rectification for, 238

Choke coils, 78

-input filter, 79

Circuit breaker, troubles with, 400

Circuits

action in, 34, 36

electronic, 29

open, 393

parallel, rules for, 93

series, rules for, 93

short, 392

Circular mil-foot, 84

Coil, induced emf in, 180

magnetic line direction in, 181

Cold-cathode

rectifiers, 203

tube, 197

ignition as, 250

photorelay with, 347

Colpitts oscillator circuit, 301

Compound wound motor, 191

Condenser, see *Capacitor*

Conductance, mutual, definition, 223

Conductors

capacitance of, 171

definition, 37, 41

resistance of, 83

Constant, time, capacitor-

resistor, 233

Control characteristics

grid-glow tube, 200

positive and negative, 119

thyatron, 116

shield grid, 166

Controls, see names of parts

Cooling, tubes, 375-378

Copper-oxide rectifiers, 244

troubles with, 401

Core, iron, inductance affected

by, 181

Coulomb, definition, 37

Coupling

capacitive, 299

feedback through, 302

inductive, direct, 298

mutual inductance, 299

resistance, 298

Critical grid potential, thyatron, 130

Current (see also *Electron flow*)

eddy, 304

flow, vs. electron flow, 46

Curve, saturation, 182, 184, 275

sine, definition, 142

Cycles

degrees in, 142

definition, 53

duty, 397

per second, 53

D

D-c, meaning of, 165

Degrees, electrical, 142

Deionization, time for, 160

Delay, time, see *Time delay*

Dielectric, 70

heating of, 306

Difference, phase, 142

potential, see *Potential difference*

Dimming, lamp, saturable

reactor, 186

Direct electron flow, rectified, 50

inductive coupling, 298

Direction of magnetic lines, 181

Discharge, capacitor, on a-c, 145

time for, 232

Divider, voltage, 81, 99

Drop, potential, 90

in tubes, 204

Dry rectifiers, 244

troubles with, 401

Duty cycle, definition, 397

Dynamometer meters, 386

E

Eddy currents, 304

Effective values, 58

Electricity, definition, 23

Electrolytic capacitor, 74

Electromagnetic induction, 140

in coils, 180

- Electromotive force
 definition, 30
 induced, 140, 180
 sources of, 38
- Electron
 definition, 23
 emission, 49
 flow, current flow vs., 46
 direction of, 67
 explanation of, 28
 grid circuit, 211
 heating due to, 85
 law for, 95
 potential difference with, 88
 requirements for, 29
 resistance changed by, 85
 free, definition, 25
- Electronics, 1, 3
- Electrostatic, definition, 306
 heating, 290, 306
- Emf, see *Electromotive force*
- Emission, electron, 49
 secondary, 226
- Energy
 definition, 30
 storage systems, welding, 284
 capacitor method, 286
 magnetic method, 286
- F**
- Factor, amplification, 223
- Family of characteristics, 216
- Farad, definition, 75
- Feedback coupling, 302
- Field, magnetic, definition, 140
- Filament
 potential difference for, 159
 preheating of, 111
 returns for, 148, 173
- Filter
 capacitor-input, 79
 capacitors for, 70
 circuits, action in, 76
 high-resistance load for, 77
 inductor-input, 78, 79
 low resistance load for, 77
 rectifier power supply, 126
- Firing rectifier, ignitron, 251
 tube, ignitron, thyatron as, 253
- Flow, electron, see *Electron flow*
 rate, electrical, 5
 switch, water control, 380
- Flux, luminous, 320
 magnetic, 274
- Foot-candles, 322
- Forced air cooling, tubes, 376
- Forward phototube circuit, 333
- Free electron, 25
 grid, 212
- Frequency, 53
 high, 289
- Full-wave rectifiers, 67, 69
 ignitron types, 252, 254
 thyatron, 155
- Fuses, troubles with, 400
- G**
- Gain, voltage, 220
- Gas (see also *Vapor*)
 amplification, phototube, 328
 definition, 110
 ionization in, 106
 phototubes, 326
 tetrodes, 161
 phototube relay with, 345
 time-relay with, 241
- Generator voltage regulator, 195
- Glow discharge, phototube, 328
 tube, 197
 arc discharge in, 205
 rectifier, 203
 symbols for, 204
 uses of, 11
- Grid bias, 214
 phototube relay, 336
 capacitor, action of, 310
 characteristics, vacuum tube, 212
 control, positive and negative, 117
 thyatron, 116, 123
 vacuum tube, 210
 electron flow in, 158, 211
 free, meaning of, 212
 -glow tubes, 197
 connections, 198
 control characteristics, 200
 controls for, 202
 symbols, 198
 leak, action of, 310

Grid bias—(Cont.)

- rectification, charging by, 238
- resistor, 310
- screen, triode, 225
- shift control, thyatron, 132
- suppressor, in pentode, 227
- voltages, 130, 214, 221
- Gradient, potential, in tube, 204
- Ground, accidental, causes for, 392
- connection, explanation of, 170
- Grounding, wire circuit, 390

H

- Half-wave rectifier, 67
- tubes for, 69
- Hartley oscillator circuit, 309
- Heat control, welding, 281
- Heater-cathodes, 59
- Heating
 - electron flow causes, 85
 - electrostatic, 290, 306
 - induction, 289, 303
 - power required for, 86
 - resistance, 43
- Henry, definition, 78
- High frequencies, uses of, 289
- Horsepower, mechanical, 5
- Horizontal sweep oscillator, 359

I

- Ignitor, ignitron, action of, 248, 250
- circuit for, 251
- Ignitrons
 - a-c control by, 263
 - action of, 251
 - care of, 255
 - construction of, 247
 - control circuits for, 254, 255
 - full-wave rectifier with, 252, 254
 - ignitor in, 248
 - mounting of, 255
 - power control by, 261
 - testing of, 383
 - uses of, 11
 - welding control by, 262
- Illumination, see *Light*

- Impedance, 293
 - resonant circuit, 297
 - transformer, welding control, 282
 - triangle, 294
- Induced electromotive force, 140
- Inductance, definition, 78
 - mutual, coupling by, 299
- Induction, electromagnetic, 140, 180
 - heating by, 289, 303
- Inductive reactance, 152, 180, 291
 - saturation effect in, 183
- Inductors
 - action of, 78
 - definition, 78
 - filters using, 78
 - phase-shift with, 152
 - reactance of, 152
- In phase, definition, 142
- Instruments, testing, see *Meters*
- Insulators, 41, 42
- Inverse potentials, peak, 59
 - square law, illumination, 321
 - voltage, peak, 157
- Inverter, 13
- Ionization
 - action during, 106
 - cold-cathode tube, 197
 - thyatron operation due to, 115
 - time for, 160
- Ions, production of, 106
- Iron core, inductance affected by, 181

K

- Kenotron rectifier tubes, 13
- construction of, 47

L

- Lag, phase relations with, 143
- Lamp dimming, saturable reactor, 186
- Law of inverse squares, 321
 - Ohm's, 97
- Lead, phase relations with, 143
- Leading tube, 264
- Leak, grid, action of, 310
- Light
 - flux, 320

Light—(Cont.)

- measurement of, 319
- meters, 323
- sources, trouble with, 351
- Line, load, construction of, 217
- magnetic, direction of, 181
- voltage regulator, 185
- Load circuits, rectifier, 66
- line, construction of, 217
- resistance, vacuum tube, 221
- thyatron, 124
- Lumen, definition, 320
- Luminous flux, 320

M**Magnetic**

- energy storage systems, 286
- field, 140
- flux, 274
- lines, direction of, 181
- Maintenance, electronic apparatus, 371

Maximum

- average amperes in tubes, 111
- definition of, 156
- peak amperes in tube, 111
- inverse voltage, 157
- values, electrical, 58
- voltages, tube, 157

Meters

- dynamometer, 386
- light, 323
- moving coil, 384
- iron, 385
- ohm-, 387
- permanent-magnet moving-coil, 384
- thermocouple, 387
- Microfarad, 75
- Mil-foot, circular, 84
- Milliampere, 55
- Motors
- controls for, 189
- direct-current, action of, 190
- speed control of, 191
- Moving coil meter, 384
- iron meter, 385
- Mutual conductance, definition, 223
- inductance, coupling by, 299

N

- Negative bodies, 26
- charge, 40
- control characteristic, 117
- potential, 39
- Neutral bodies, 26
- Normally closed or open relay, 335

O

- Ohm, definition, 37
- Ohmmeter, 387
- Ohm's law, 89, 95-97
- Open circuits, causes for, 393
- Opposite phase, definition, 142
- Oscillators, 299
- capacity pickup for, 312
- Colpitts, 301
- feedback in, 302
- Hartley, 309
- oscillograph type, 364
- power types, 305
- relay controls by, 308, 311
- sweep circuits, 363
- tuned grid, 300
- grid tuned-plate, 301
- plate, 301
- Oscillograph, cathode-ray
- action of, 355
- a-c measurements with, 366
- amplifier for, 364
- controls for, 361
- d-c measurements with, 369
- oscillator for, 364
- synchronizer for, 364
- voltages for, 361
- Out of phase definition, 142

P

- Parallel
- capacitor and resistor in, 234
- circuits, rules for, 93
- resistances, equivalents of, 98
- resonance, 296
- series resistances, 99
- Peak inverse potentials, 59, 157
- Peaking transformers, 273
- construction of, 277
- use of, 279

- Pentodes, 224
 construction of, 226
 symbols for, 210
- Permanent-magnet moving-coil meter, 384
- Permeability, meaning of, 182
- Phanotron rectifiers, 14, 105
 (see also *Rectifier tubes*)
- Phase
 definition, 139
 difference, definition, 142
 capacitor effect on, 147
 resistance effect on, 147
 in, meaning of, 142
 opposite, meaning of, 142
 out of, meaning of, 142
 relations, transformer, 273
 shift, action of, 149
 adjustment of, 151, 153
 effect of, 149
 grid-glow tube, 203
 phototube control of, 350
 principles of, 143
 resistor-inductor for, 152
 saturable reactor for, 188
 thyatron, 139, 164
 triode for, 227
- Phasing, voltages, test for, 396
- Photoelectric tube, see *Phototube*
- Phototubes
 action of, 315, 317
 amplifier connections to, 333
 circuit, basic, 317
 construction of, 315
 forward circuits, 333
 gas amplification in, 328
 -filled, action of, 326
 glow discharge in, 328
 phase-shift control by, 350
 relays, 331
 a-c operated, 336
 cold-cathode tube in, 347
 d-c line supply for, 341
 gas tetrode type, 345
 sensitivity adjustment of, 344
 time-delay types, 348
 troubles with, 351
 reverse circuits, 333
 sensitivity of, 326
- Phototubes—(Cont.)
 uses of, 12
 vacuum, action of, 324
- Pickup, capacity, oscillator with, 312
- Plate characteristics, triode, 215
 -grid capacitance, triode, 224
 potential and electron flow, 56
 resistance, 223
- Pliotrons, 9, 207
 (see also *Vacuum tubes*)
- Positive bodies, 26
 charge, 40
 control characteristic, 117
 ions, production of, 106
 potential, 39
- Potentials (see also *Voltages*)
 difference, 34
 effect of, 39
 electron flow with, 88
 law for, 89
 drop of, 90
 in tubes, 108, 204
 electric, explanation of, 31
 gradient, tube, 204
 peak inverse, 59
- Power, 48
 amplifier, meaning of, 220
 electrical, 5, 44, 45
 heating, 86
 ignitron control of, 261
 oscillator, 305
 resistor dissipation of, 87
 supply, rectified, 125
- Preheating, cathode or filament, 111
- Pressure, absolute, 109
 effect in gas or vapor, 109
 electrical, 4 (See *Potentials*)
 vapor, in tube, 110
- Primary winding, transformer, 63
- Protons, definition, 24
- Pulsating electron flow, 54
- Pulsation welding, 258

R

- Ratings, thyatron, 155
 tube, 111
- Reactances
 capacitive, 146, 292
 explanation of, 291

- Reactances—(Cont.)
 inductive, 152, 291
 action of, 180
 saturation effect on, 183
 resonance values for, 295
- Reactor, definition, 182
 saturable, 179
 phase-shift control by, 188
- Rectification, grid, charging by, 238
- Rectified power supply, 125
- Rectifiers
 bridge, 245
 copper-oxide, 244
 troubles with, 401
 firing, ignitron, 251
 full-wave, 67
 ignitron, 252, 254
 half-wave, 67
 three-phase, 284
 tubes, action of, 50, 54
 cold-cathode, 203
 connections of, 66
 full-wave, 69
 half-wave, 69
 phanotron, 14, 105
 purpose of, 7
 uses of, 61
- Reference point, potential, 33, 34
- Regulator, generator voltage, 195
 voltage, saturable reactor for, 185
- Relays
 capacitor bypass for, 242
 magnetic, operation of, 335
 normally closed or open, 335
 oscillator operated, 311
 controls for, 308
 phototube, see *Phototube relays*
 time-delay, 240
 trigger type, 243
 troubles with, 400
 vacuum tube operated, 213
- Repulsion, electric, 27
- Resistance
 coupling, 298
 electron flow effect on, 85
 factors affecting, 83
 heating in, 43
 law for, 96
 load, thyatron, 124
 vacuum tube, 221
- Resistance—(Cont.)
 measurement of, 37
 parallel, 98
 phase difference affected by, 147
 plate, 223
 series-parallel, 99
 time-delay affected by, 231
- Resistors
 alloy types, 84
 capacitor paralleled with, 234
 timing with, 229
 definition, 41
 grid, action of, 310
 -inductor phase-shift, 152
 limiting, gas or vapor tube, 108
 phototube relay, 342
 thyatron, 172
 troubles with, 398
 watts dissipation of, 87
- Resonance, 295
 parallel, 296
 series, 295
- Resonant frequency, 295
- Return, cathode or filament,
 148, 173, 223
- Reverse phototube circuits, 333
- Reversing control, motor, 193
- Root-mean-square (r-m-s) values, 58
- S
- Saturable reactors, 179
 phase-shift control with, 188
- Saturation curve, 182, 184, 275
 reactance affected by, 183
- Saw-toothed sweep, oscillator, 359
- Seam welding control, 283
- Screen grid, triode, 225
 (see also *Shield grid*)
- Secondary emission, 226
 winding, transformer, 63
- Sensitivity, phototube, 326
 relay adjustment, 344
- Sequence timers, welding, 261
 timing, welding, 266
- Series capacitor welding circuit, 287
 circuits, rules for, 92
 -parallel resistances, 99
 resonance, 295
 transformer, welding control by,
 282

Series—(Cont.)

- wound d-c motor, 191
- Shield-grid, action of, 161
 - thyratrons, 161
- Shielding, tube, 374
 - thyatron leads, 170
- Shift, phase, see *Phase shift*
- Short circuits, causes of, 392
- Shunt wound d-c motor, 191
- Sine wave, definition, 142
 - production of, 141
- Skin effect, 304
- Smoothing capacitor, 242
- Sources, energy, 29, 30
- Space charge, 51
 - effect of, 57
 - ionization reduction of, 107
- Speed control, d-c motor, 191
- Spot welding, 258
- Suppressor grid, pentodé, 227
- Surge electron flow, thyatron, 158
 - voltages, capacitor protection, 172
- Sweep oscillator, 363
 - horizontal, oscillograph, 359
- Switches, water flow, 380
 - troubles with, 399
- Symbols
 - capacitor, 74
 - contacts, 75
 - copper-oxide rectifier, 245
 - electrical quantities, 86, 294
 - gas-filled tubes, 105
 - grid-glow tubes, 198
 - glow tubes, 204
 - inductor, 78
 - motor, 191
 - rectifier, 48, 60, 70
 - tetrode, 163
 - thyatron, 173
 - transformer, 63
 - vacuum tubes, 210
 - vapor-filled tubes, 105
- Synchronizer, oscillograph, 364
- Synchronous timer, welding, 277
 - timing, welding, 272

T

- Tanks, ignitron, 251
- Taps, center, transformer, 65

Temperature (see also *Heating*)
control, tube, 374

gas- or vapor-filled tubes, 110
thyatron, effect of, 120

Testing instruments, see *Meters*

Tests, voltage, methods for, 393
(see also names of parts)

Tetrodes, 224

gas types, 161
phototube relays with, 345
mercury-vapor types, 161
screen grid in, 225
secondary emission in, 226
symbols for, 210

Thermocouple meter, 387

Three-phase rectifier, 284

Thyratrons

action of, 113, 114

aging of, 169

alternating grid potential, 131

plate potential, 127

applications for, 10, 113, 122, 177

average electron flow in, 131, 137

back to back connections, 155

breakdown potentials, 130

circuits for, 177

connections to, 173

electron flow in, 124

firing tube, ignitron, 253

four-element, see *Thyratrons*,
shield grid

full-wave circuit for, 155

generator voltage regulation by,
195

grid action in, 115

control in, 116

electron flow in, 158

resistor for, 172

-shift control of, 132

load resistance for, 124

motor reversing control by, 194

speed control by, 193

multiple control of, 154

operation of, 122, 169

phase-shift control of, 139, 143

potentials during cycle, 128

protective resistors for, 172

ratings of, 155

shield-grid type, 161

- Thyratrons—(Cont.)**
 connections for, 163
 control characteristics of, 166
 shielding of leads to, 170
 stopping electron flow in, 117
 symbols for, 173
 temperature effect on, 120
 triode control of, 227
 uses of, 10, 113, 122, 177
- Time constant, capacitor-resistor, 233**
 controls, welding, 259
 delay, adjustment of, 237
 capacitor-resistor, 229
 circuit, use of, 236
 phototube relay with, 348
 relay, 240
 sequence timing, 266
 trigger relay, 243
- Timer, sequence, welding, 261, 266**
 synchronous, welding, 272, 277
- Timing, automatic, 229**
 seam welding, 283
- Transconductance, definition, 223**
- Trailing tube, 264**
- Transformers**
 action of, 62
 impedance type, welding control, 282
 peaking, 273
 construction of, 277
 use of, 279
 phase relations in, 273
 ratios of, 64
 series, welding control by, 282
 troubles with, 399
 voltages of, 63
 windings of, 63
- Triangle, impedance, 294**
- Trigger control, thyatron, 177**
 time-delay relay, 243
- Triodes**
 amplifier uses of, 213
 capacitance, internal, 224
 phase-shift control by, 227
 plate characteristics of, 215
 symbols for, 210
 thyatron control by, 227
- Trouble shooting**
 electronic apparatus, 371-416
 methods of, 391
- Troubles, see names of parts**
- Tubes**
 amplifier, 6, 9
 classification of, 18
 capacitance, internal, 171
 cathode-ray, see *Cathode-ray tubes*
 cold-cathode, see *Cold-cathode tubes*
 control types, 6, 10
 cooling of, 375-378
 glow, see *Glow-tubes*
 grid-glow, see *Grid-glow, tubes*
 industrial types of, 8
 leading, 264
 mercury-vapor, see *Gas and Vapor*
 mounting of, 373
 overheating of, 375
 pentode, see *Pentodes*
 photo, see *Phototubes*
 pliotron, 9, 207
 potential drop in, 108, 204
 rectifier, see *Rectifier tube*
 shielding for, 374
 temperature control for, 374
 tetrode, see *Tetrodes*
 thyatron, see *Thyratrons*
 trailing, 264
 troubles with, 381
 types of, 19
 vacuum, see *Vacuum tube*
 water cooling for, 378
- Tuned grid oscillator, 300**
 -tuned plate oscillator, 301
 plate oscillator, 301
- Turns ratio, transformer, 64**
- V**
- Vacuum tube**
 advantages and disadvantages, 208
 amplifiers, 207
 grid action in, 210
 electron flow, 211
 phototube, see *Phototubes*
 returns, filament and cathode, 223
 symbols for, 210
 voltage, grid, required, 221
 supply, required, 221
- Values, effective, maximum, r-m-s, 58**
- Vapor (see also *Gas*)**
 definition, 110

Vapor—(Cont.)

- ionization in, 106
- pressure, in tube, 110
- Vertical trace, cathode-ray tube, 358
- Volt, definition, 4, 38
- Voltage (see also *Potentials*)
 - amplifier, meaning of, 220
 - divider, action of, 81
 - analysis of, 99
 - drop, 90
 - in tubes, 108, 204
 - gain, 220
 - grid, vacuum tube, 214, 221
 - high, causes for, 395
 - line, fluctuating, 395
 - low, causes for, 394
 - phasing of, tests for, 396
 - regulator, generator, 195
 - line, saturable reactor, 185
 - tests, methods for, 393
 - transformer, 63
 - phase of, 273
 - troubles, causes for, 394

W

- Water cooling, tubes, 378
 - flow switch, 380
- Watt, 5
- Wattmeter, dynamometer type, 386
- Welding
 - energy storage systems for, 284
 - heat control for, 281
 - ignitron control for, 262
 - leading- trailing-tube circuit, 264
 - resistance, 258
 - seam, control of, 283
 - sequence timing for, 266, 268
 - series capacitor circuit, 287
 - series transformer control, 282
 - synchronous timing for, 272
 - time controls for, 259
 - types of, 258
- Winding, filament, center tapped, 65
 - transformer, 63, 64
- Wiring, installation of, 389
- Work, definition, 30

